

## 405/406 Baseboard Diffuser

- All-steel construction
- Blankets wall or window area
- Golden Sand or Bright White enamel finish

Model Number	Size	Free Area Sq. In.	Overall Length	Height	Base Projection	Opening Width
405	18"	38	18	5 <sup>1</sup> / <sub>4</sub>	2 <sup>13</sup> / <sub>16</sub>	12
406	15"	32	15	4 <sup>1</sup> / <sub>2</sub>	2 <sup>3</sup> / <sub>4</sub>	12
406	18"	38	18	4 <sup>1</sup> / <sub>2</sub>	2 <sup>13</sup> / <sub>16</sub>	12
407	18"	38	18	4 <sup>1</sup> / <sub>2</sub>	2 <sup>13</sup> / <sub>16</sub>	12

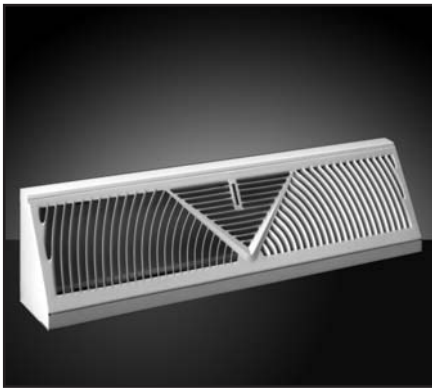
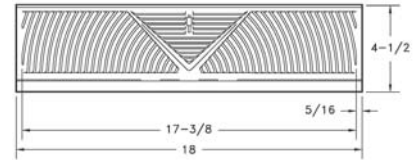

## 407 Matching Return Air Grille

- All-steel construction
- Complementary return air grille for Model 405 or Model 406 supply
- Golden Sand or Bright White enamel finish

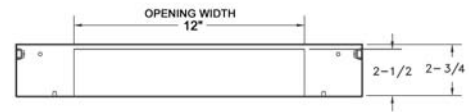

406 18" Shown



## 462 Baseboard Diffuser

- All-steel construction
- Two-foot length
- Airfoil valves reduce resistance
- Equal air distribution over the length of the diffuser
- Face can be easily removed
- Golden Sand or Bright White enamel finish

Model Number	Size	Free Area Sq. In.	Overall Length	Height	Base Projection	Bottom Opening
462	2'	27	24	4 <sup>1</sup> / <sub>2</sub>	2 <sup>23</sup> / <sub>32</sub>	2 <sup>5</sup> / <sub>16</sub> X 16
472	2'	42	24	4 <sup>1</sup> / <sub>2</sub>	2 <sup>23</sup> / <sub>32</sub>	2 <sup>5</sup> / <sub>16</sub> X 16

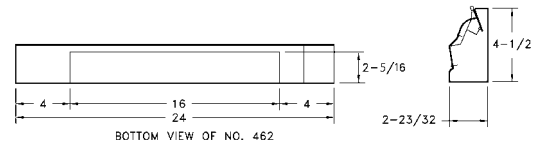

BOTTOM VIEW OF NO. 462



## 472 Matching Return Air Grille

- All-steel construction
- Two-foot length
- Complementary return air grille for Model 462 supply
- Golden Sand or Bright White enamel finish

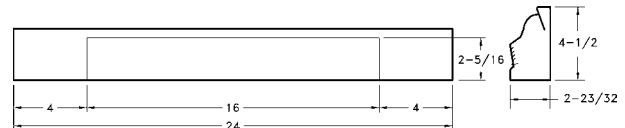

BOTTOM VIEW OF NO. 472

# Baseboard Registers & Grilles

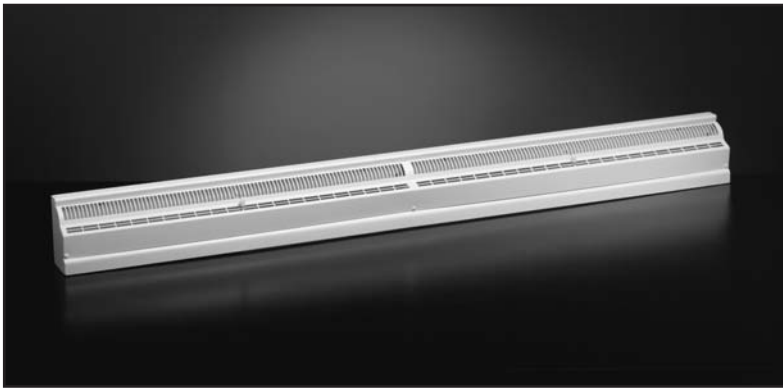

## 464 Baseboard Diffuser

- All-steel construction
- Four-foot length
- Airfoil valves reduce resistance
- Equal air distribution over the length of the diffuser
- Dual valves
- Face can be easily removed
- Golden Sand or Bright White enamel finish

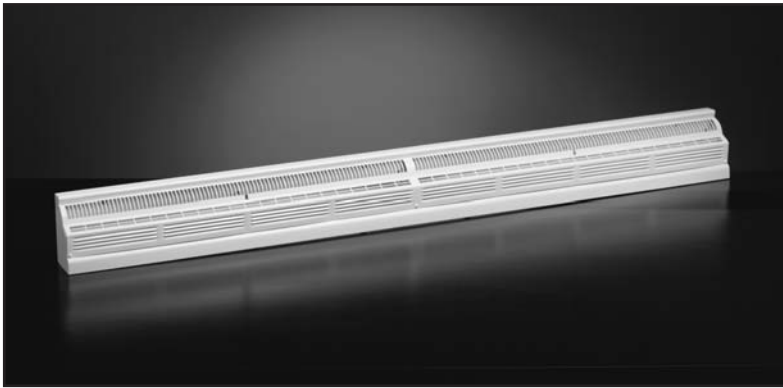

## 474 Matching Return Air Grille

- All-steel construction
- Four-foot length
- Complementary return air grille for Model 464 supply
- Golden Sand or Bright White enamel finish

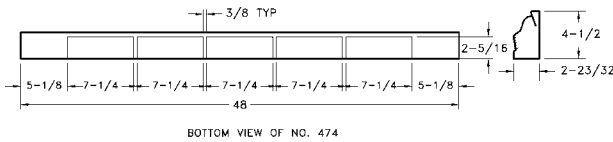
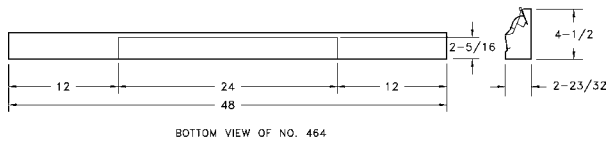

Model Number	Size	Free Area Sq. In.	Overall Length	Height	Base Projection	Bottom Opening
464	4'	54	48	4 1/2	2 <sup>23</sup> / <sub>32</sub>	2 <sup>5</sup> / <sub>16</sub> X 24
474	4'	84	48	4 1/2	2 <sup>23</sup> / <sub>32</sub>	2 <sup>5</sup> / <sub>16</sub> X 36 <sup>1</sup> / <sub>4</sub>



## 654 Baseboard Register with Damper

- One-piece steel construction
- 1/3" spaced fins set at 20 degrees
- 7/8" margin turnback
- Exceptional free area
- Positive volume-control damper
- Bright White enamel finish

654 Available Sizes (in.)				
HT	WIDTH			
	10	12	14	
6	X	X	X	

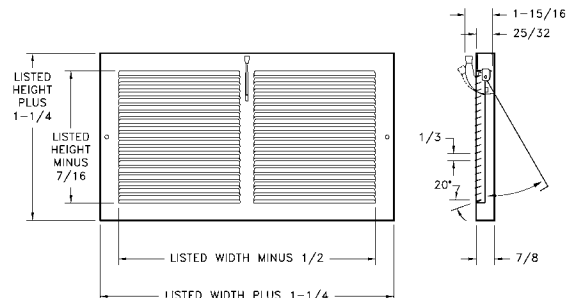



## 655 Baseboard Register with Damper

- All-steel construction
- 1/3" spaced fins set at 20 degrees
- Volume-control damper
- Bright White enamel finish

655 Available Sizes (in.)				
HT	WIDTH			
	8	10	12	14
6	X	X	X	X

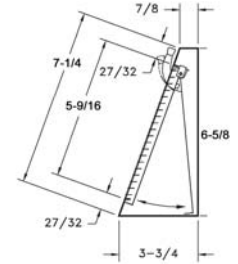
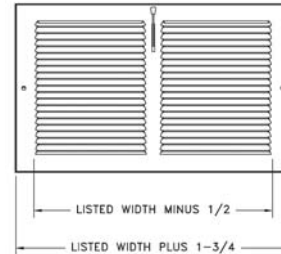

## 657 Baseboard Return Air Grille

- One-piece steel construction
- 1/3" spaced fins set at 20 degrees
- 7/8" margin turnback
- Exceptional free area
- Install with fins upward or downward for best duct concealment
- Complementary return air grille for Model 654 or 664 supply
- Golden Sand or Bright White enamel finish

657 Standard Sizes (in.)								
HT	WIDTH							
	4							
6	X	X	X	X	X	X	X	X
8	X	X	X	X	X	X	X	X
10			X		X	X	X	
12			X			X	X	

Contact factory for sizes not listed.

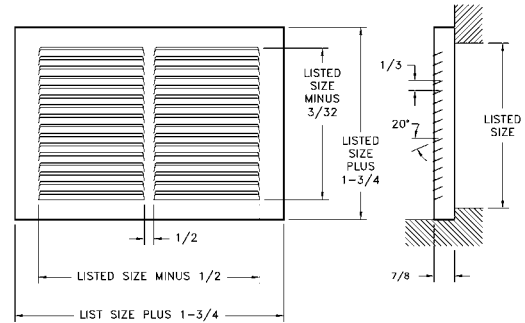

## 658 Baseboard Return Air Grille

- All-steel construction
- 1/3" spaced fins set at 20 degrees
- Complementary return air grille for Model 655 supply
- Bright White enamel finish

658 Available Sizes (in.)					
HT	WIDTH				
	10	12	14	24	30
6	X	X	X	X	X
8			X	X	X

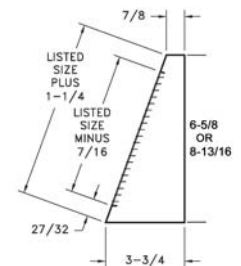
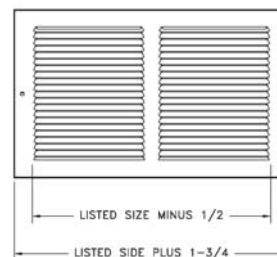

# Baseboard Registers & Grilles



## 664 Baseboard Register

- All-steel construction
- 1/3"-spaced fins set at 20 degrees
- 7/8" margin turnback
- 1-5/8" depth when fully opened
- Exceptional free area
- Ideal for shallow duct installations
- Multi-shutter valve
- Bright White enamel finish

664 Available Sizes (in.)				
HT	WIDTH			
	8	10	12	14
6	X	X	X	X
8			X	

Contact factory for sizes not listed

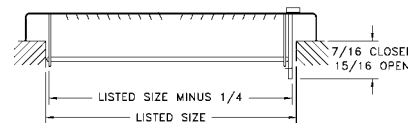
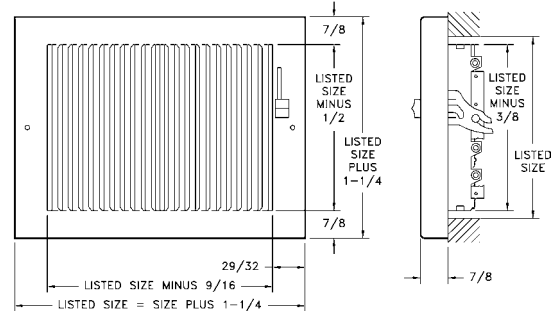

## 674 Return Air Grille

- One-piece steel construction
- 1/2"-spaced fins set at 40 degrees
- 7/8" margin turnback
- Complementary return air grille for 1/2"-spaced products
- Bright White enamel finish

674 Available Sizes (in.)			
HT	WIDTH		
	14	24	30
6	X	X	X
8	X	X	X

