

# Z-one™ Relay

## Multi-zone pump switching relays



01285/16 NA

Replaces 01285/14 NA

### ZSR series



#### Function

The ZSR series is a zone pump and boiler operating control for multiple zone hydronic heating systems. The ZSR series interfaces with low voltage thermostats, or any other low voltage controllers having a switching action. The ZSR series controls up to 6 zone pumps (depending on model selected) and a primary pump. It has LED indicators to provide functional status and easy system troubleshooting.

#### Features

- Compatible with 2, 3 and 4-wire thermostats or other low voltage controllers with switching action
- 120 VAC input
- Heavy duty, sealed relays
- 1 primary pump output and 3 to 6 (model dependent) zone pump outputs (120 VAC/5A each)
- Zone priority selectable with 1-hour time-out feature
- Convenient R,W,C and T,T,COM dual labeling at thermostat terminals
- System pump status (on/off) during priority selectable
- Dry contacts (XX,AUX, ZONE 1 E/S) capable of switching line voltage
- High capacity 12 VA or 20 VA transformer (model dependent)
- Automatic resettable fuse on 24 V circuit
- Selectable post purge
- Selectable pump exercising
- 3 pump ground terminals for simplified wiring
- Expandable to unlimited number of zones using simple 3-wire connection between controls
- Large screw terminals for ease of wiring.
- Front panel LED indicator light for functional status
- 100% factory tested with 3 year warranty
- ETL certified to CSA and UL standards

#### Product range

Code **ZSR103** Z-one™ Relay pump switching relays, 12 VA maximum transformer load .....three zone  
 Code **ZSR104** Z-one™ Relay pump switching relays, 12 VA maximum transformer load .....four zone  
 Code **ZSR106** Z-one™ Relay pump switching relays, 20 VA maximum transformer load ..... six zone

#### Technical specifications

##### Materials

Housing plastic: ABS  
 Front display lights: LED  
 Electrical knockouts (12) 1/2" size

##### Performance

Power supply: 120 VAC, 50/60 Hz  
 Transformer voltage: 24 VAC  
 Maximum transformer load: 12 VA (ZSR103/4), 20 VA (ZSR106)  
 Electrical switch rating: 20A max combined  
 Electrical switch rating pump output: 120 VAC, 5A each  
 Dry contact rating, XX, AUX, ZONE 1 E/S: 120 VAC, 2A each

Replaceable fuses: Type 2AG, 5A slow blow

##### Temperature limits for:

Shipping and storage max: 110°F (43°C)  
 Maximum Operating: 110°F (43°C)

Maximum humidity: 90% non-condensing

Approvals: ETL certified to CSA C22-2 No. 24, conforms to UL873

#### Dimensions

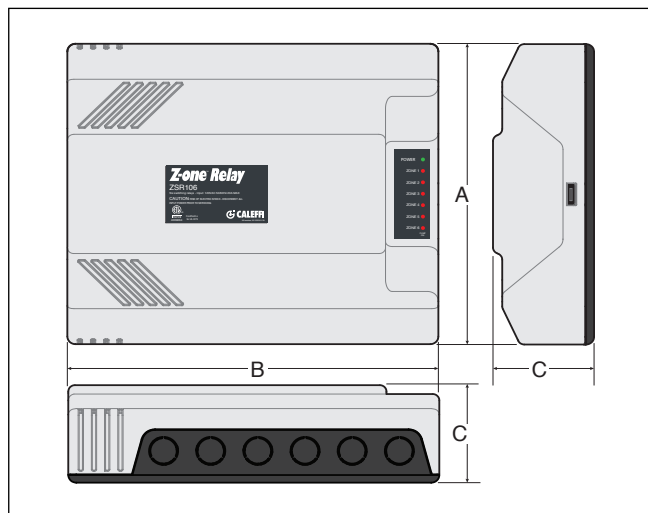

Code	Zones	A	B	C	Wgt. (lbs)
ZSR103	3	9 1/4"	11"	3"	2.0
ZSR104	4	9 1/4"	11"	3"	2.0
ZSR106	6	9 1/4"	11"	3"	2.0

**Maintenance and Repair:** The Caleffi Z-one™ multi-zone pump control comes with two spare fuses. If control fails or is damaged, replace control with functional one.

**Boiler connections:**

**XX** = Dry contact rated up to 120 VAC, 2 Amps, which is typically connected to TT on boiler control, closes when any zone calls including priority.

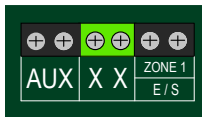

**ZONE 1 E/S** = Dry contact rated up to 120 VAC, 2 Amps, will close with any call to ZONE 1. Zone 1 can be enabled as a priority zone, typically used for heating domestic hot water. The ZONE 1 E/S can be used to close a DHW contact on boiler controls equipped with these features.

**AUX** = Dry contact, rated up to 120 VAC, 2 Amps, close when any zone calls and can be used as signal to a variable speed self regulated pump or other controls.

**Communication connections:**

Connect terminals to matching terminal of slave boards D to D, P to P, Ground to Ground. Use 18 gauge thermostat wire and it should be shielded if located in close proximity to high voltage wiring.



**Input Power:**

L = Line (hot leg) of 120 VAC supply  
 N = Neutral of 120 VAC  
 ⊥ = Ground

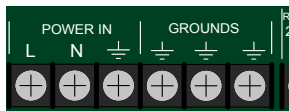

Note: when connecting 2 or more Z-one controls, all controls must be powered by the same 120 VAC circuit.

**Zone pump outputs:**

Zone pumps run when corresponding thermostat initiates a demand.

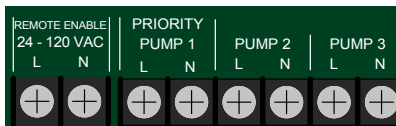

**GROUND** = Connect the ground from the pump to the ground terminal.

**PRIORITY PUMP** = Runs when zone #1 calls. Can be programmed to be the priority zone. L = Line (hot leg) of 120 VAC to power the pump, N = Neutral leg of 120 VAC to power the pump. Remote Enable allows for input of 24-120 VAC from a boiler to allow the zone pumps to operate. When power is removed from Remote Enable, zone pumps will not be allowed to operate. This is useful during warm weather shut down to stop zone pumps from running or if your boiler controls are used to handle priority (DHW) demand and need the zone pumps to be off during the priority demand. Even with power removed from Remote Enable, the ZSR board stays powered to supply power to the thermostats.

The ZSR series of control is programmed by positioning five dip switches for the following operations.

**Master / Slave:** allows for unlimited expansion to additional ZVR or ZSR relays. Only one Master.

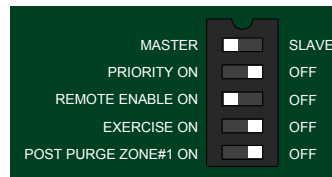

**Priority ON / OFF:** When priority switch is ON, upon demand to TSTAT 1, ZONE 1 will operate as priority and all other zones are temporarily switched off (with 1 hour time-out). When priority is OFF, any zones that were active when ZONE 1 was switched on will remain on.

**Remote Enable ON / OFF:** When remote enable mode is ON, the board will hold off all zones waiting for an external 24 - 120 VAC voltage from the boiler.

**Exercise ON / OFF:** When exercise mode is ON, each circulator is switched on for 30 seconds following 72 hours of inactivity.

**Post Purge Zone #1 ON / OFF:** When post purge is ON, Zone 1 pump continues operating for 2 minutes after the priority zone is switched OFF.

**Primary pump output:**

Primary pump runs when any zone pump runs. Its status during priority (on/off) can be programmed using the jumper pins.

L = Line (hot leg) of 120 VAC to power the pump

N = Neutral leg of 120 VAC to power the pump

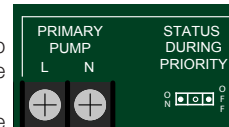

**Status During Priority ON / OFF:** If priority is enabled and the jumper is placed on the ON pins, the primary pump will continue to operate during ZONE 1 demand. When jumper is placed on OFF pins, the primary pump will be OFF during ZONE 1 demand.

**WARNING:** NEVER CONNECT R & C DIRECTLY, this will be a direct short on the 24 VAC supply.

**WARNING:** When connecting 2 or more Z-one controls, all controls must be powered by the same 120 VAC circuit.

**WARNING:** When replacing fuses, make sure power is disconnected to control box.

**Traditional boiler, indirect DHW with priority, zone pumps**

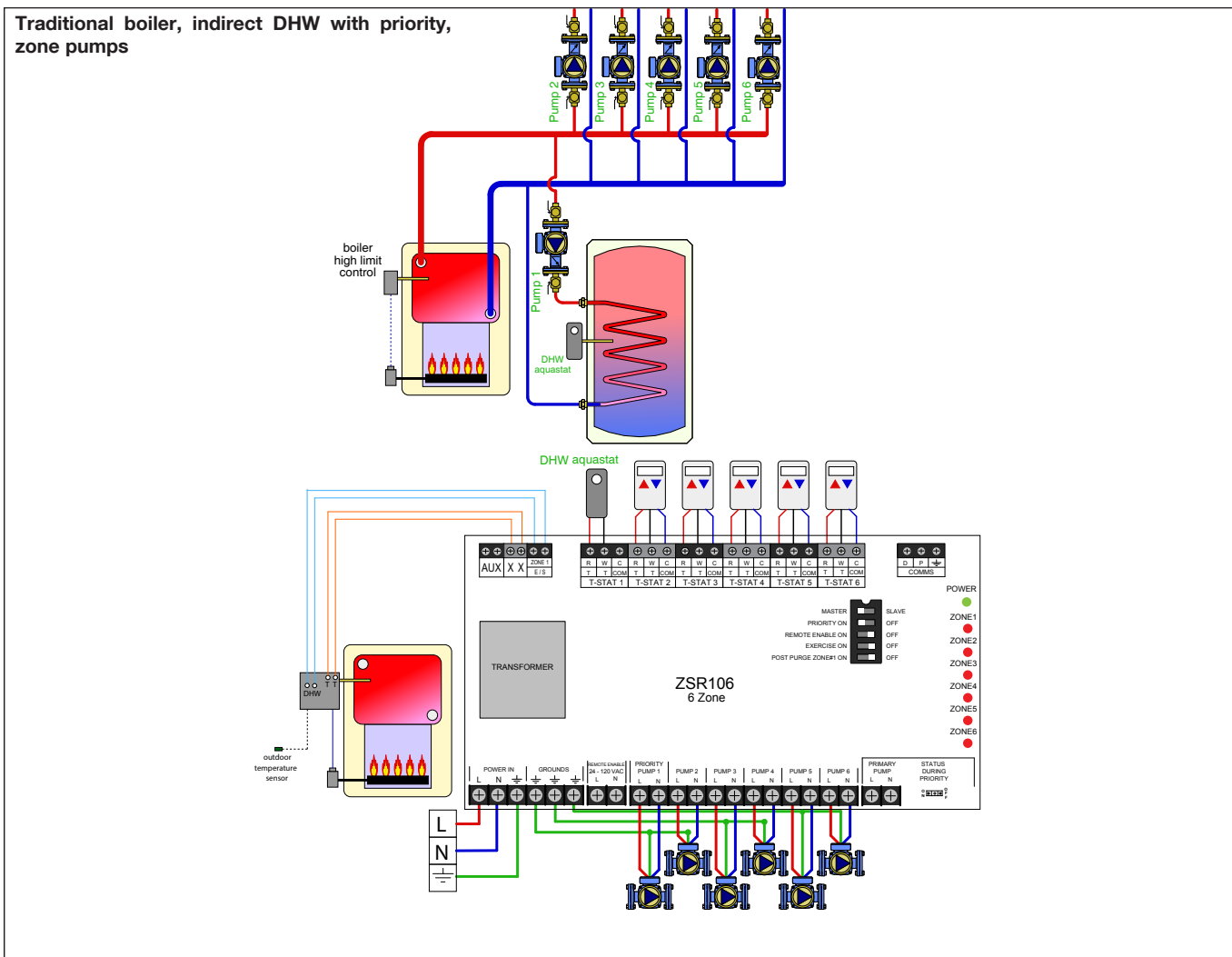

Hydronic diagram is for illustration purposes only, some components have been removed for simplicity.

## SPECIFICATION SUMMARY

### Z-one™ Relay, ZSR series

Multi-zone pump switching relay. Compatible with 2, 3 and 4-wire thermostats or low voltage controllers with switching action. Power supply 120 VAC, 50/60 Hz. Zone priority selectable with 1 hour time-out feature. System pump status (on/off) during priority selectable. Transformer voltage: 24 VAC. R,W,C and T,T,COM dual labeling at thermostat terminals. Dry contacts (XX,AUX,T,T,ZONE 1 E/S) capable of switching line voltage. Automatic resettable fuse on 24 V circuit. Expandable to unlimited number of zones using 3-wire connection between controls. Large screw terminals. Front panel LED indicator light for functional status. ETL certified to CSA C22-2 No. 24, conforms to UL873. Provided with heavy duty, sealed relays, 1 primary pump output and 3 to 6 (model dependent) zone pump outputs (120 VAC/5A each), high capacity 12 VA transformer on 3 and 4 zone models, and 20 VA transformer on 6 zone models, and 3 pump ground terminals. Temperature limits for shipping, storage and operating: 110 degrees F (43 degrees C). Maximum humidity: 90 percent non-condensing. Electrical switch rating: 20A maximum combined. Electrical switch rating pump output: 120 VAC, 5A each. Dry contact rating XX,AUX,T,T,ZONE 1 E/S: 120 VAC, 2A each.

We reserve the right to make changes and improvements to the products and related data in this publication, at any time and without prior notice.



Caleffi North America, Inc.  
 3883 W. Milwaukee Road  
 Milwaukee, WI 53208  
 Tel: 414-238-2360 · Fax: 414-238-2366  
 sales@caleffi.com · www.caleffi.com  
 © Copyright 2016 Caleffi North America, Inc.