

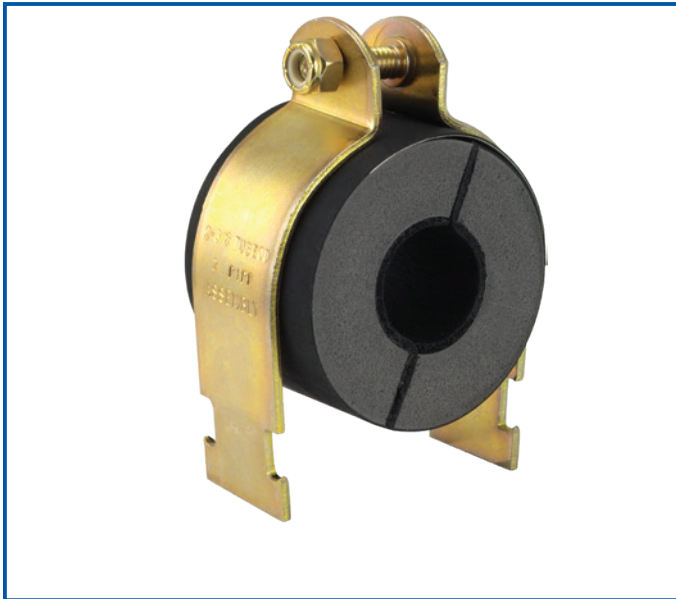

# Cush-A-Therm<sup>®</sup>

## Vapor Barrier Protection

### Airtight Crush-Resistant Insulation Clamp



- No Air Gaps, Hermetically Sealed Tubing
- Prevents Condensation Leaks
- Protects Thermal Barrier
- Absorbs Vibration
- 100% Solid Polyurethane
- Temperature range:  
-70°F to +250°F  
(-56.7°C to +121°C)

- Properly Supports Pipe and Tube
- Tested in Conformance with ASTM E84 (UL 723, NFPA 255) having results of 0 FSI (Flame Spread Index) and 50 SDI (Smoke Developed Index)
- Rubber Laminate Inside and Out
- Flammability Self-Extinguishing as Tested Under ASTM D 635

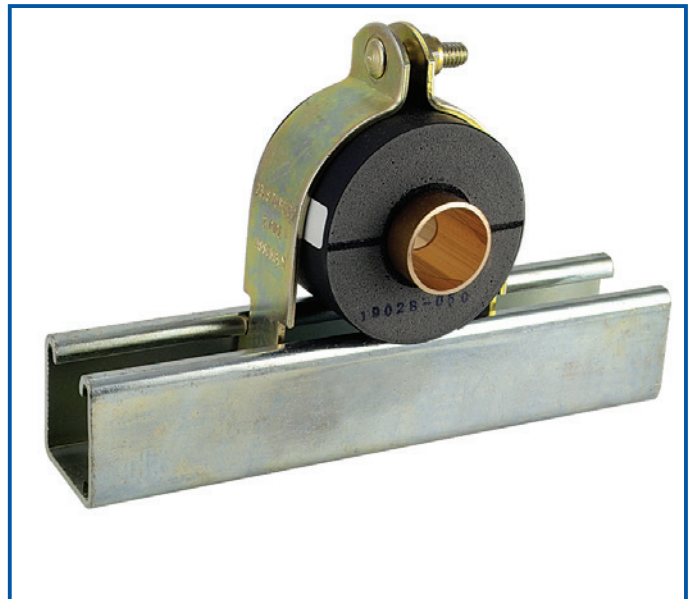

Call ZSi-Foster at (800) 323-7053 or order now at [zsi-foster.com](http://zsi-foster.com)

**ZSi-Foster**

Canton, MI | La Mirada, CA | Murfreesboro, TN | Ocala, FL | Springfield, MO | Totowa, NJ





# Cush-A-Therm®

## Airtight Crush-Resistant Insulation Clamp

**Cush-A-Therm Clamp** is a perfect crush-resistant airtight seal for chilled refrigeration or mechanical pipe lines that require continuous insulation.

The rigid foam construction has an insulating tape inner lining which supports tube and absorbs vibration of operating pipe lines.

The outer cover consists of a special rubber coating which seals the cushion after installation in order to prevent condensation.

Its strong closed-cell structure is ideal for liquid cooling lines to prevent condensation, save energy, and maintain the vapor barrier.

NOTE: Complete assembly supplied with Stainless Steel channel clamp and hardware

NOTE: Complete assembly supplied with gold electro-galvanized channel clamp and hardware

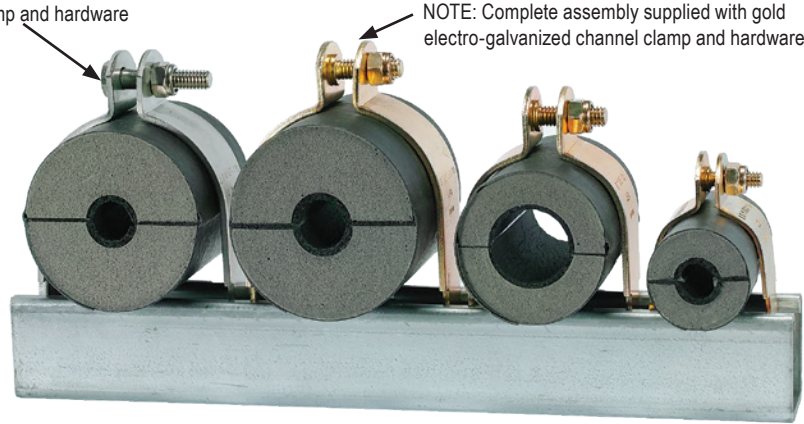

| Dimensions (Inches) |             |           |        |                | Nominal 1/2" (13mm) Wall Thickness |           |           |                         | Nominal 3/4" (19mm) Wall Thickness |           |           |                         |
|---------------------|-------------|-----------|--------|----------------|------------------------------------|-----------|-----------|-------------------------|------------------------------------|-----------|-----------|-------------------------|
| Hole Size           | Copper I.D. | Pipe O.D. | IPS    | Len.           | Part No.                           |           |           | Cushion O.D.            | Part No.                           |           |           | Cushion O.D.            |
|                     |             |           |        |                | Steel                              | SS 304    | SS 316    |                         | Steel                              | SS 304    | SS 316    |                         |
| 1/4" (6mm)          | -           | 1/4"      | -      | 2.953" (75mm)  | UX1412                             | UX1412SS  | UX1412S6  | 1 1/4" (1.250") (32mm)  | UX1434                             | UX1434SS  | UX1434S6  | 1 3/4" (1.750") (45mm)  |
| 3/8" (10mm)         | 1/4"        | 3/8"      | -      |                | UX3812                             | UX3812SS  | UX3812S6  | 1 3/8" (1.375") (35mm)  | UX3834                             | UX3834SS  | UX3834S6  | 1 7/8" (1.875") (48mm)  |
| 1/2" (13mm)         | 3/8"        | 1/2"      | 1/4"   |                | UX1212                             | UX1212SS  | UX1212S6  | 1 1/2" (1.500") (38mm)  | UX1234                             | UX1234SS  | UX1234S6  | 2" (2.000") (51mm)      |
| 5/8" (16mm)         | 1/2"        | 5/8"      | 3/8"   | 2.953" (75mm)  | UX5812                             | UX5812SS  | UX5812S6  | 1 5/8" (1.625") (41mm)  | UX5834                             | UX5834SS  | UX5834S6  | 2 1/8" (2.125") (54mm)  |
| 3/4" (19mm)         | 5/8"        | 3/4"      | -      |                | UX3412                             | UX3412SS  | UX3412S6  | 1 3/4" (1.750") (45mm)  | UX3434                             | UX3434SS  | UX3434S6  | 2 1/4" (2.250") (57mm)  |
| 7/8" (22mm)         | 3/4"        | 7/8"      | 1/2"   |                | UX7812                             | UX7812SS  | UX7812S6  | 1 7/8" (1.875") (48mm)  | UX7834                             | UX7834SS  | UX7834S6  | 2 3/8" (2.375") (60mm)  |
| 1-1/8" (29mm)       | 1"          | 1 1/8"    | 3/4"   | 2.953" (75mm)  | UX11812                            | UX11812SS | UX11812S6 | 2 1/8" (2.125") (54mm)  | UX11834                            | UX11834SS | UX11834S6 | 2 5/8" (2.625") (67mm)  |
| 1-3/8" (35mm)       | 1 1/4"      | 1 3/8"    | 1"     |                | UX13812                            | UX13812SS | UX13812S6 | 2 3/8" (2.375") (60mm)  | UX13834                            | UX13834SS | UX13834S6 | 2 7/8" (2.875") (73mm)  |
| 1-5/8" (41mm)       | 1 1/2"      | 1 5/8"    | 1 1/4" |                | UX15812                            | UX15812SS | UX15812S6 | 2 5/8" (2.625") (67mm)  | UX15834                            | UX15834SS | UX15834S6 | 3 1/8" (3.125") (79mm)  |
| 1-7/8" (48mm)       | -           | 1 7/8"    | -      | 2.953" (75mm)  | UX17812                            | UX17812SS | UX17812S6 | 2 7/8" (2.875") (73mm)  | UX17834                            | UX17834SS | UX17834S6 | 3 3/8" (3.375") (86mm)  |
| 2-1/8" (54mm)       | 2"          | 2 1/8"    | -      |                | UX21812                            | UX21812SS | UX21812S6 | 3 1/8" (3.125") (79mm)  | UX21834                            | UX21834SS | UX21834S6 | 3 5/8" (3.625") (92mm)  |
| 2-3/8" (60mm)       | 2 1/4"      | 2 3/8"    | 2"     |                | UX23812                            | UX23812SS | UX23812S6 | 3 3/8" (3.375") (86mm)  | UX23834                            | UX23834SS | UX23834S6 | 3 7/8" (3.875") (98mm)  |
| 2-5/8" (67mm)       | 2 1/2"      | 2 5/8"    | -      | 3.937" (100mm) | UX25812                            | UX25812SS | UX25812S6 | 3 5/8" (3.625") (92mm)  | UX25834                            | UX25834SS | UX25834S6 | 4 1/8" (4.125") (105mm) |
| 2-7/8" (73mm)       | -           | 2 7/8"    | 2 1/2" |                | UX27812                            | UX27812SS | UX27812S6 | 3 7/8" (3.875") (98mm)  | UX27834                            | UX27834SS | UX27834S6 | 4 3/8" (4.375") (111mm) |
| 3-1/8" (79mm)       | 3"          | 3 1/8"    | -      |                | UX31812                            | UX31812SS | UX31812S6 | 4 1/8" (4.125") (105mm) | UX31834                            | UX31834SS | UX31834S6 | 4 5/8" (4.625") (118mm) |
| 3-1/2" (89mm)       | -           | 3 1/2"    | 3"     | 3.937" (100mm) | UX31212                            | UX31212SS | UX31212S6 | 4 1/2" (4.500") (114mm) | UX31234                            | UX31234SS | UX31234S6 | 5" (5.000") (127mm)     |
| 3-5/8" (92mm)       | 3 1/2"      | 3 5/8"    | -      |                | UX35812                            | UX35812SS | UX35812S6 | 4 5/8" (4.625") (118mm) | UX35834                            | UX35834SS | UX35834S6 | 5 1/8" (5.125") (130mm) |
| 4-1/8" (105mm)      | 4"          | 4-1/8"    | 3 1/2" |                | UX41812                            | UX41812SS | UX41812S6 | 5 1/8" (5.125") (130mm) | UX41834                            | UX41834SS | UX41834S6 | 5 5/8" (5.625") (143mm) |

## Airtight Crush-Resistant Insulation Clamp

INSTALLATION IS AS EASY AS 1-2-3!

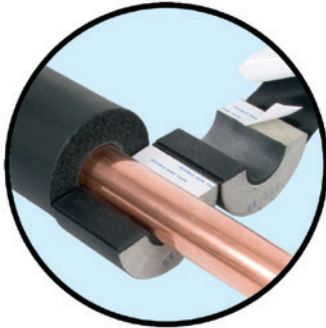

1. Insulation slides over pipes.  
Self adhesive surfaces provide seal.

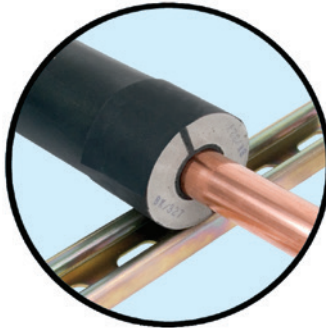

2 Put in place and glue to insulation.

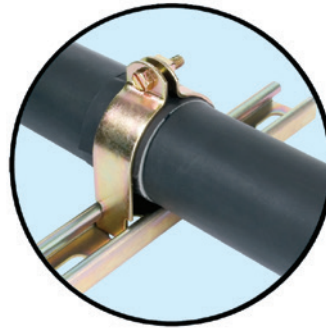

3. Wrap and seal with ProTape.

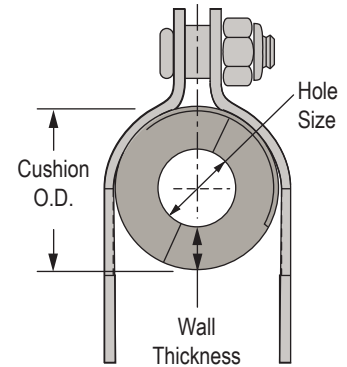

| Dimensions        | Nominal 1" (25mm)<br>Wall Thickness |           |           |                            | Nominal 1-1/2" (38mm)<br>Wall Thickness |           |           |                            | Nominal 2" (51mm)<br>Wall Thickness |           |           |                            |
|-------------------|-------------------------------------|-----------|-----------|----------------------------|---|-----------|-----------|----------------------------|-------------------------------------|-----------|-----------|----------------------------|
|                   | Part No.                            |           |           | Cushion<br>O.D.            | Part No.                                |           |           | Cushion<br>O.D.            | Part No.                            |           |           | Cushion<br>O.D.            |
|                   | Steel                               | SS 304    | SS 316    |                            | Steel                                   | SS 304    | SS 316    |                            | Steel                               | SS 304    | SS 316    |                            |
| 1/4"<br>(6mm)     | UX1410                              | UX1410SS  | UX1410S6  | 2 1/4" (2.250")<br>(57mm)  | UX1415                                  | UX1415SS  | UX1415S6  | 3 1/4" (3.250")<br>(83mm)  | -                                   | -         | -         | -                          |
| 3/8"<br>(10mm)    | UX3810                              | UX3810SS  | UX3810S6  | 2 3/8" (2.375")<br>(60mm)  | UX3815                                  | UX3815SS  | UX3815S6  | 3 3/8" (3.375")<br>(86mm)  | -                                   | -         | -         | -                          |
| 1/2"<br>(13mm)    | UX1210                              | UX1210SS  | UX1210S6  | 2 1/2" (2.500")<br>(64mm)  | UX1215                                  | UX1215SS  | UX1215S6  | 3 1/2" (3.500")<br>(89mm)  | -                                   | -         | -         | -                          |
| 5/8"<br>(16mm)    | UX5810                              | UX5810SS  | UX5810S6  | 2 5/8" (2.625")<br>(67mm)  | UX5815                                  | UX5815SS  | UX5815S6  | 3 5/8" (3.625")<br>(92mm)  | UX5820                              | UX5820SS  | UX5820S6  | 4 5/8" (4.625")<br>(118mm) |
| 3/4"<br>(19mm)    | UX3410                              | UX3410SS  | UX3410S6  | 2 3/4" (2.750")<br>(70mm)  | UX3415                                  | UX3415SS  | UX3415S6  | 3 3/4" (3.750")<br>(95mm)  | UX3420                              | UX3420SS  | UX3420S6  | 4 3/4" (4.750")<br>(121mm) |
| 7/8"<br>(22mm)    | UX7810                              | UX7810SS  | UX7810S6  | 2 7/8" (2.875")<br>(73mm)  | UX7815                                  | UX7815SS  | UX7815S6  | 3 7/8" (3.875")<br>(98mm)  | UX7820                              | UX7820SS  | UX7820S6  | 4 7/8" (4.875")<br>(124mm) |
| 1-1/8"<br>(29mm)  | UX11810                             | UX11810SS | UX11810S6 | 3 1/8" (3.125")<br>(79mm)  | UX11815                                 | UX11815SS | UX11815S6 | 4 1/8" (4.125")<br>(105mm) | UX11820                             | UX11820SS | UX11820S6 | 5 1/8" (5.125")<br>(130mm) |
| 1-3/8"<br>(35mm)  | UX13810                             | UX13810SS | UX13810S6 | 3 3/8" (3.375")<br>(86mm)  | UX13815                                 | UX13815SS | UX13815S6 | 4 3/8" (4.375")<br>(111mm) | UX13820                             | UX13820SS | UX13820S6 | 5 3/8" (5.375")<br>(137mm) |
| 1-5/8"<br>(41mm)  | UX15810                             | UX15810SS | UX15810S6 | 3 5/8" (3.625")<br>(92mm)  | UX15815                                 | UX15815SS | UX15815S6 | 4 5/8" (4.625")<br>(118mm) | UX15820                             | UX15820SS | UX15820S6 | 5 5/8" (5.625")<br>(143mm) |
| 1-7/8"<br>(48mm)  | UX17810                             | UX17810SS | UX17810S6 | 3 7/8" (3.875")<br>(98mm)  | UX17815                                 | UX17815SS | UX17815S6 | 4 7/8" (4.875")<br>(124mm) | UX17820                             | UX17820SS | UX17820S6 | 5 7/8" (5.875")<br>(149mm) |
| 2-1/8"<br>(54mm)  | UX21810                             | UX21810SS | UX21810S6 | 4 1/8" (4.125")<br>(105mm) | UX21815                                 | UX21815SS | UX21815S6 | 5 1/8" (5.125")<br>(130mm) | UX21820                             | UX21820SS | UX21820S6 | 6 1/8" (6.125")<br>(156mm) |
| 2-3/8"<br>(60mm)  | UX23810                             | UX23810SS | UX23810S6 | 4 3/8" (4.375")<br>(111mm) | UX23815                                 | UX23815SS | UX23815S6 | 5 3/8" (5.375")<br>(137mm) | UX23820                             | UX23820SS | UX23820S6 | 6 3/8" (6.375")<br>(162mm) |
| 2-5/8"<br>(67mm)  | UX25810                             | UX25810SS | UX25810S6 | 4 5/8" (4.625")<br>(118mm) | UX25815                                 | UX25815SS | UX25815S6 | 5 5/8" (5.625")<br>(143mm) | UX25820                             | UX25820SS | UX25820S6 | 6 5/8" (6.625")<br>(168mm) |
| 2-7/8"<br>(73mm)  | UX27810                             | UX27810SS | UX27810S6 | 4 7/8" (4.875")<br>(124mm) | UX27815                                 | UX27815SS | UX27815S6 | 5 7/8" (5.875")<br>(149mm) | UX27820                             | UX27820SS | UX27820S6 | 6 7/8" (6.875")<br>(175mm) |
| 3-1/8"<br>(79mm)  | UX31810                             | UX31810SS | UX31810S6 | 5 1/8" (5.125")<br>(130mm) | UX31815                                 | UX31815SS | UX31815S6 | 6 1/8" (6.125")<br>(156mm) | UX31820                             | UX31820SS | UX31820S6 | 7 1/8" (7.125")<br>(181mm) |
| 3-1/2"<br>(89mm)  | UX31210                             | UX31210SS | UX31210S6 | 5 1/2" (5.500")<br>(140mm) | UX31215                                 | UX31215SS | UX31215S6 | 6 1/2" (6.500")<br>(165mm) | UX31220                             | UX31220SS | UX31220S6 | 7 1/2" (7.500")<br>(191mm) |
| 3-5/8"<br>(92mm)  | UX35810                             | UX35810SS | UX35810S6 | 5 5/8" (5.625")<br>(143mm) | UX35815                                 | UX35815SS | UX35815S6 | 6 5/8" (6.625")<br>(168mm) | UX35820                             | UX35820SS | UX35820S6 | 7 5/8" (7.625")<br>(197mm) |
| 4-1/8"<br>(105mm) | UX41810                             | UX41810SS | UX41810S6 | 6 1/8" (6.125")<br>(156mm) | UX41815                                 | UX41815SS | UX41815S6 | 7 1/8" (7.125")<br>(181mm) | UX41820                             | UX41820SS | UX41820S6 | 8 1/8" (8.125")<br>(206mm) |



# Cush-A-Therm<sup>®</sup> Vapor Barrier Protection

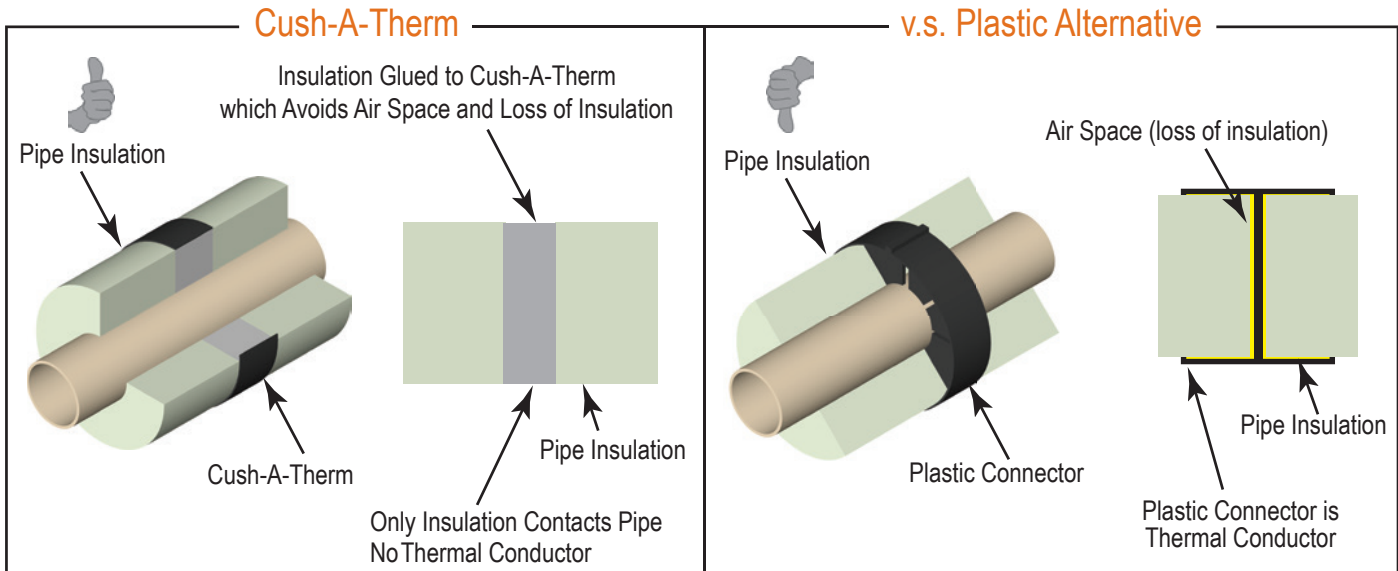

## ASHRAE Insulation Recommendations

Cush-A-Therm is designed to meet the ASHRAE recommendations for insulation for mechanical systems which indicate that insulated pipe hangers should provide the following:

1. Complete sealing of pipe against water vapor ingress
2. No energy transfer of cold to supporting clamp to prevent condensation of water and possible growth of mold. If the support encasing the insulation is in contact with the pipe or tube and supported by a metallic clamp, which is not protected by insulation, below ambient temperatures will be transferred to the clamp causing energy transfer and condensation.
3. No interruption of the insulation envelope
4. Limit or avoid compression at support location

ASHRAE Section 23.13-23.14 further states "when the goal is avoiding compression of low-compressive-strength insulation products, it is recommended to use high-strength insulation inserts made of a product that offers the desired compressive strength and other necessary performance properties. Other higher-strength materials that are not thermal insulation material and interrupt the insulation envelope, or do not allow complete sealing of an insulation system against water vapor ingress are not recommended for supporting insulated piping on pipe hangers. Note that wood blocks have poor thermal conductivity and are not recommended, especially for cold pipe systems."

Insulated cold piping should receive special attention when exposed to ambient or unconditioned air. The Cush-A-Therm is a product that seals out air, and insulates the pipe/tube from the supporting clamp, and is therefore in compliance with the 2013 ASHRAE insulation recommendations.



Call ZSi-Foster at (800) 323-7053 or order now at [zsi-foster.com](http://zsi-foster.com)

**ZSi-Foster**

Canton, MI | La Mirada, CA | Murfreesboro, TN | Ocala, FL | Springfield, MO | Totowa, NJ

© Copyright 2020 ZSi-Foster / Printed & Designed in the USA / 05-20 / Therm-3

