

mitco MFG.

Customer Satisfaction is our Top Priority
Same Day Shipping
Low Prices



137 Puncheon Creek Drive
Andrews, SC 29510

CLICK www.mitcomfg.com
EMAIL sales@mitcomfg.com

CALL 800 338-8908
FAX 800 727-4009

SUBJECT INDEX

050 Cold Flow Improver	9	Boxes, electrical outlet	14, 33
246 Super Duty Sludge Dispersants.....	8	Boxes, parts organizers.....	93
3-way Adapters.....	35	Brushes	73-76
A/C Temperature Controls	3	Burner Head Protectors.....	64
AC Unit Insulation.....	56	Buss Bars.....	66
Adapter, electrical	18	Buzz Pro Flood Alarm.....	4, 90
Adapter, gauge	29	Bypass Plugs.....	80
Adapters, 3-way.....	35	Cable Connectors.....	15
Adapters, for wells.....	51	Cable Staples.....	15
Adapters, nozzle	62	Cable Tie Mounting Pad.....	37
Aerosol Insulation Spray.....	56	Cable Tie Tension Tool.....	37
Air Cleaner Media.....	23	Cable Ties.....	37
Air Filters.....	23-27	Cad Cell Testers	86
Air Valves	29	Caps, hose.....	30, 49
Air Vents	51	Caps, oil fill.....	70
Airefresh Replacement Media.....	23	Central Oil Supply Systems	77
Alarm, tank fill	69-70	Charging Hoses	1-3
Alpine Condensing Units	1	Check Valves	30
Amp Mate Circuit Tester	85	Chemicals, oil treatment	8-9
Aquastat Immersion Wells	46	Circuit Breakers.....	13
Baffles, boiler.....	53-43	Circuit Testers	85
Bags, vacuum.....	57	Circulator Bearing Assemblies	43-46
Ball Valves.....	52	Circulator Body Gaskets.....	48
Bearing Assemblies.....	43-46	Circulator Couplings.....	47
Bearings, HVAC.....	6	Circulator Flange Tool.....	48, 94
Belts, oil burner	6	Circulator Hardware	29, 48
Bender, tube	96	Circulator Impellers	48
Biobor JF Biocide Treatment	9	Circulator Motor Mount Kits	47
Biocide Treatment.....	9	Circulator Motors	41, 42
Black Mamba Gloves	57	Circulator Replacement Parts.....	46-49
Blankets, combustion head	65	Circulator Seal Assemblies.....	48
Blank-Off Plates for compressors	5	Circulators.....	38, 40
Bleed Valves	30	Cleanout Plug.....	66
Blow Down Kits.....	49	Clearview Fluid.....	8
Blower Shafts.....	6	CO2 Fluid.....	8
Blue Mamba Gloves.....	57	Coin and Key Air Valves	29
Board, combustion chamber	64	Cold Alert Temperature Monitor.....	90
Boiler Drain Valves	52	Combination Electrical Switches.....	17
Boiler Gauges.....	49	Combustion Analysis Fluids	8
Boiler Saws	92	Combustion Blankets.....	65
Bolts.....	29	Combustion Burner Head Protectors	64
Bolts, hex head	36	Combustion Chamber Board	64

SUBJECT INDEX

Combustion Smoke Testers	87	Electrical Receptacles	17
Compressor Blank-Off Plates.....	5	Electrical Strap	18
Compressor Leads	35	Electrical Switches	17
Compressor Terminals.....	35	Electrical Tape.....	18
Condensate Float Switches.....	4, 31	Electrode Kits	69
Condensate Pumps	4	Electrostatic Air Filters.....	24
Condensing Units, outdoor.....	1	Emergency Switch Covers.....	16
Conduit Connectors	15	EMT Strap	15
Conduit Locknut	15	Extension Cords	11
Connectors, cable	15	Extension Lights	11
Connectors, oil gauge	29	Fan Pullers	92
Connectors, wire nut	13, 35	Felt Fuel Oil Filters	19-20, 22
Continuity Testers	89	Filter Pads	65
Cords, extension	11	Filters	19-27
Cords, test.....	12	Filters, nozzle	62
Cork Insulation.....	56	Filters, wound cotton.....	22
Cotton Fuel Oil Filters	22	Fin Straighteners.....	96
Couplings, circulator	47	Fittings, condensate drain pain	31
Couplings, oil burner	63	Fittings, nozzle	62
Covers, emergency switch.....	16	Flame Detectors.....	87
Covers, outlet boxes	16	Flame Mirrors	62
Crimpers	93	Flame Shield.....	55
Current Taps	18	Flame Simulators	86
Cutters, gauge glass.....	92	Flanges, blank universal.....	28
Cutters, tube.....	95	Flanges, for circulators	49
Danfoss Pump Strainers	79	Flanges, pump.....	80
De-Icers.....	8	Flat Insulation Rope	55
Detectors, flame	87	Flat Washers	36
DFC+ Diesel Fuel Conditioner	8	Floating Suction Line.....	72
Diesel Fuel Conditioners.....	8	Flood Alarms.....	4, 90
Dimmers, electrical.....	17	Flow Control Oil De-Aerator	61
Disconnects, A/C.....	13	Freeze-Free Control	3
Drain Pan Fittings	31	Fuel Analysis Kits.....	9
Drum Pump	57	Fuel Conditioners.....	8, 9
Dual Filtration Micro-Kleen System.....	23	Fuel Oil Anti-Gel Agent	9
Duct Straps	60	Fuel Oil Filter Upgrade Kits	20
Dura Flock Gloves	59	Fuse Holders	12
Dust Masks	57	Fuse Pullers.....	17
Econ-O-Gauge Tank Fill Gauge	70-71	Gas Cans.....	29
Electrical Adapters.....	18	Gas Line Testers	28
Electrical Dimmers.....	17	Gas Pressure Testers.....	86
Electrical Hardware	11-17	Gasket Kits	49

SUBJECT INDEX

Gasket Material for heating equipment.....	55	Hoses, vacuum cleaner	57
Gasket, Suntec pump.....	80	Humidifier Installation Kits	30
Gaskets, float assembly	50	Humidifier Pads	72
Gaskets, for circulator bodies.....	48	HVAC Bearings	6
Gaskets, for fuel oil filters.....	21-22	ICP Furnace Gaskets	66
Gaskets, for GI cans	29	Igniter Testers	84
Gaskets, for ICP Furnaces	66	Igniters	67-69
Gaskets, for LWCO and Water Feeders	50	Ignition Buss Bars.....	66
Gaskets, for Miller Furnace	65	Immersion Wells.....	46
Gaskets, for York Furnaces	66	Impeller Removers.....	48, 92
Gaskets, head	50	Impellers	48
Gaskets, Riello pump	80	Insulation	55
Gaskets, Webster pump	80	Insulation Tape	56
Gauge Glass	51, 92	Insulation, cork	56
Gauge Glass and Valve Sets.....	51	Insulation, spray	56
Gauge Glass Cutters	92	Insulation, Weather Seal	56
Gauge Glass Washers	51, 92	Isolator Ball Valves.....	52
Gauge, string.....	70-71	Jiffy Bleed Valves	30
Gauge, tank fill.....	70-71	Jumpers, electrical.....	11
Gauges, pump test.....	81, 91	Jumpers, magnetic.....	11
Gauges, Tridicators for boilers	49	Kaowool Strips	64
Gauges, Vac-Bolt test	91	Key, Radiator Vent.....	29
GI Can Gaskets.....	29	Keys, hex	93
Gloves	57-59	King Tank Fill Alarm	69-70
Grease Trap Air Filters	25	Kit, electrode	69
Guards, thermostat	32	Kit, for circulator motor mounting	47
Hand Tools.....	92-96	Kit, for mounting relays	37
Handi-Foam Aerosol Insulation Spray	56	Kit, fuel analysis	9
Hardware, for circulators	29	Kit, gaskets.....	49
Harnesses, wiring	13	Kit, humidifier installation	30
Head Gaskets	50	Kit, Kwik Coupler.....	63
Head Hex Bolts	36	Kit, Kwik-Fit pressure vacuum pump	81
Heat Protection Shields	55	Kit, Kwik-Wick Absorbent Spill Kit	60
Heater Gasket Material	55	Kit, mini-split installation.....	1
Hex Keys	93	Kit, oil pump.....	
Hex Nuts	36	Kit, pump test manifold	82
Hi-Temp 400 Paper.....	55	Kit, solderless terminal	34
Hi-Temp Flat Insulation Rope	55	Kit, transformer gasket	66
Hi-Temp Round Insulation Rope.....	55	Kit, upgrade for fuel oil filters.....	20
Hog Hair Air Filters.....	23	Kit, water feeder blow down valve.....	49
Hose Caps	30, 49	Kits, hose.....	86
Hose Kits	86	Knee Pads	58

SUBJECT INDEX

Knockout Plugs	15	Mounting Pad, for cable ties	37
Kwik Couple Oil Burner Couplings	63	Mounts, motor	47
Kwik Coupler Kits	63	Multimeters	89
Kwik-Check II Pressure and Cutoff Tester	82	N-Dex Gloves	57
Kwik-Fit Gauge Adapter	29	Nozzle Adapters	62
Kwik-Fit Pressure Vacuum Pump	81	Nozzle Filters	62
Kwik-Fit Wiring Harnesses	13	Nozzle Fittings	62
Kwik-Purge Blow Out Guns	94	Nozzle Lines	62
Kwik-Wick Absorbent Spill Kit	60	Nozzles, oil burner	62
Kwik-Zorb Waterwick Absorption Device	9-60	Nuts	29, 36
Leads, compressor	35	Odor Eliminator Spray	9
Leads, test	12	Odor Eliminators	9
Lennox Oil Burner Belts	6	Oil Burner Couplings	63
Level Indicators	70-71	Oil Burner Motors	39, 41
Light Bulbs	12	Oil Burner Nozzles	62
Lights, extension	11	Oil Burner Pumps, Riello	39
Line Noise Dampener	62	Oil De-Aerators, Flow Control	61
Line Testers	88	Oil Fill Caps	70
Line Voltage Testers	88-89	Oil Filter Wrench	19, 96
Line, suction	72	Oil Flow Monitors	83
Lines, copper	62	Oil Gauge Connectors	29
Lines, emergency oil	30	Oil Lines	30, 61
Liquid-Tite Connectors	15	Oil Pump Kit	5
Lock Washers	36	Oil Safety Valves	61
Low Voltage Testers	88	Oil Supply Systems	77
Lubricants	10	Oil Watcher Oil Flow Monitor	83
Manifold, pump test	82	Oil Wicking	29, 48
Manniglas Gaskets	55	O-rings	30
Manometer U-Gauge	28, 89	Outlet Box Covers	16
McDonnell & Miller Replacement Parts	49-50	Outlet Boxes	14, 33
Micro-Flow Fuel Oil Filter in a Can	19	Pads, absorbent	60
Micro-Flow Fuel Oil Filters	19-21	Pads, humidifier	72
Micro-Kleen Dual Filtrations System	23	Paper, Hi-Temp 400 insulation	55
Miller Furnace Filter Pads	65	Parts Organizing Boxes	93
Miller Furnace Gaskets	65	Paste, water detecting	60, 83
Mini-Split Installation Kits	1	Permanent Air Filters	27
Mirrors, flame	62	Petro-chemicals	8-9
Monitors, oil flow	83	Pillow Blocks	6
Monitors, temperature	90	Plugs, bypass	80
Motor Mounts	47	Plugs, cleanout	66
Motor, vacuum cleaner	57	Plugs, knockout	15
Motors, circulator	41, 42	Plugs, plastic	29

SUBJECT INDEX

Porcelains	67-69	Smoke Check Combustion Smoke Tester	87
Portable Pump Sets	78	Solderless Terminals	34
Pressure and Cutoff Tester	82	Soot-Saw Boiler Saws.....	92
Pressure Vacuum Pump	81	Soot-Snoot Vacuum Cleaner Hoses	57
Primary Controls.....	39	Sorbent Pads.....	60
Pullers, fan	92	Spiral Boiler Baffles.....	53-54
Pump Flanges	80	Staples	15
Pump Gaskets	80	Static-Aire Electrostatic Air Filters	24
Pump Sets, portable	78	STR-2+ Dispersant and De-Icer	8
Pump Strainers	79	Straighteners, fin	96
Pump Test Gauges	81, 91	Strainers, pump	79
Pump Test Manifold	82	Strap, electrical.....	18
Pumps, condensate	4	Straps, duct.....	60
Pumps, for drums	57	String Gauge	70-71
Pumps, transfer	77	Suction Line	72
Radiator Vent Key.....	29	Super-Flex Gloves	58
Reach-All Lubricating Oil.....	10	Switches, combination electrical	17
Receptacles, electrical	17	Switches, condensate float.....	31
Refillable Air Filters.....	26	Switches, electrical	17
Refrigeration Wrenches	96	Switches, float.....	31
Relay Mounting Kit	37	Tank Gauges.....	70-71
Remanufactured Products.....	38-46	Tankless Coil Tester	83
Replacement Gaskets for Oil Filters	21-22	Tap, current	18
Riello Controls	39	Tape, electrical.....	18
Riello Flame Simulator.....	86	Tape, insulation	56
Riello Oil Burner Pump	39	Tape, thread sealing	56
Riello Primary Controls.....	39	Telephone Temperature Monitors.....	90
Riello Pump Strainers	79	Tension Tool, for cable ties.....	37
Rope, flat	55	Terminals, compressor	35
Rope, round	55	Terminals, solderless	34
Round Insulations Rope.....	55	Test Cords	12
Saddle Valves	30	Test Gauges, Vac-Bolt	91
Safety Labels.....	60	Test Leads	12
Saw, boiler	92	Tester, screwdriver	88
Screwdriver Tester.....	88	Tester, tankless coil	83
Screws.....	36	Testers	28, 82-91
Seal Assemblies	48	Testers, cad cell	86
Shields, heat protection	55	Testers, circuit	85
Shut-Off Valves, for charging hoses	3	Testers, combustion smoke.....	87
Silent-Flo Line Noise Dampener	62	Testers, continuity	89
Simulators, flame.....	86	Testers, gas pressure	86
Sludge Dispersant	8	Testers, igniter	84

SUBJECT INDEX

Testers, line	88	Washable Air Filters.....	27
Testers, line voltage.....	88-89	Washers	15, 30, 36, 49, 51
Testers, low voltage.....	88	Water Absorption Devices.....	9
Testers, pressure and cutoff.....	82	Water Detecting Paste.....	60, 83
Testers, thermocouple	28, 88	Water Feeder Blow Down Valve Kit	49
Testers, transformer.....	84	Waterwick.....	9
Thermocouple Testers.....	28, 88	WD-40 Aerosol Lubricant.....	10
Thermometers.....	89	Weather Seal AC Unit Insulation	56
Thermostat Guards.....	32	Well Adapters	51
Thinwall Connectors	15	Wells, Immersion	46
Thread Sealing Tape	56	Wicking, oil	29, 48
TM-1 Transformer Tester	84	Wire Connectors.....	13, 35
TM-2 Igniter Tester	84	Wiring Harnesses	13
TM-20 Cad Cell Tester	86	Wise Crack Impeller Remover	48, 92
Tools, hand	92-96	Wound Cotton Fuel Oil Filters	22
Tools, Turn-A-Flange circulator flange	48, 94	Wrench, strap style for oil filters	19, 96
Transformer Tester.....	84	Wrench, Turn-A-Kit.....	92
Transfer Pumps.....	77	Wrenches, refrigeration	96
Transformer Gasket Kits	66	Yellow Jacket Hoses	1-3
Tridicators.....	49	York Furnace Gaskets	66
Tube Benders.....	96		
Tube Cutters	95		
Tubing, aluminum pilot	28		
Turn-A-Flange Circulator Flange Tool.....	48, 94		
Turn-A-Kit Bleed Wrench.....	92		
U-Gauge.....	28, 89		
Uni-Flange Ball Valves	52		
Universal Blank Flange.....	28		
Vac-Bolt Test Gauges.....	91		
Vacuum Bags	57		
Vacuum Cleaner Hoses	57		
Vacuum Cleaner Motor	57		
Vacuum Pump	81		
Vacuum Pump Oil	10		
Valves, ball.....	52		
Valves, bleed.....	30		
Valves, boiler drain	52		
Valves, check	30		
Valves, oil safety	61		
Valves, saddle	30		
V-Belts.....	7		
Vents, air.....	51		

AIR CONDITIONING & REFRIGERATION

Mini-Split Installation Kits

These new Mini-Split installation kits are designed to make your job easier and faster. The Kits contain everything you need to install the most popular brands of Ductless Mini-Split Systems.



Includes:

- Communication wire
- Drain hose
- Non-fused, 60 amp disconnect
- Non-metallic, 1/2" x 6 ft. A/C harness
- Ring terminals (8)
- 11" cable ties

Part#	Description	Quantity
E397-225M	25 ft. wire and hose	10 cable ties
E397-250M	50 ft. wire and hose	20 cable ties

Outdoor Condensing Units - Alpine Series

FEATURES:

- Wired with controls and doghouse cover
- 1/2, 3/4, 1 HP condensing unit
- Charged with nitrogen
- Crankcase heater mounted and wired
- Fan cycle control mounted and wired
- Drier installed
- Sight glass installed
- Galvanized cover

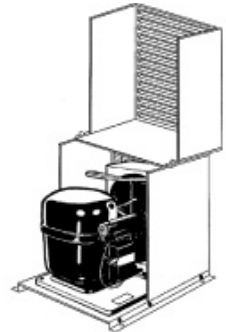

BTU Capacity @ 100° Ambient, based on Average Load

Part#	Compressor #	Size	+34° Box +25° Evap.	Quick Select Recommended Box Size
OTM050B1	AK9446ED1	1/2 HP	4,600	6 x 6 x 8
OTM075B2	AD9461EC2	3/4 HP	6,500	8 x 8 x 8
OTM100B2	AJ9486EC2	1 HP	8,600	10 x 10 x 8

Yellow Jacket® 1/4" Premium Charging Hoses

SINGLE HOSES - STANDARD FITTINGS - 1/4"

FEATURES:

- Brass fittings.
- 1/4" straight x 1/4" 45° angle fitting.
- 3 Packs are color coded for convenience.
- Hose cover pin-pricked to resist bubbling and bursting.
- 2500 psi minimum burst and 500 psi maximum working pressure for a 5-to-1 safety factor.
- Specially formulated rubber tube resists most refrigerants and assures long working life.
- Blow-off groove channels refrigerant out of the front of the nut to help prevent spray back.



Part#	Mfr#	Length	Color
N8-45	11036 HA36Y	36"	Yellow
N8-40	11048 HA48Y	48"	Yellow
N8-50	11060 HA60Y	60"	Yellow
N8-55	11072 HA72Y	72"	Yellow
N8-47	11236 HA36B	36"	Blue

AIR CONDITIONING & REFRIGERATION

Yellow Jacket® 1/4" Premium Charging Hoses

SINGLE HOSES - STANDARD FITTINGS - 1/4"

Part#	Mfr#	Length	Color
N8-46	11636 HA36R	36"	Red

3 PACK - 1/4" SAE STRAIGHT X 1/4" SAE 45° ANGLE

Part#	Mfr#	Length	Color
N8-49	11963	36"	Yellow, blue, white
N8-44	11984	48"	Red, yellow, blue
N8-54	11985	60"	Red, yellow, blue
11976M	11976	72"	Red, white, blue
11986M	11986	72"	Red, yellow, blue

AIR CONDITIONING & REFRIGERATION

Yellow Jacket® Plus II Charging Hoses

1/4" premium charging hoses with SealRight™ low loss anti-blow back fitting on one end.

FEATURES:

- 45° end for ease in tight areas.
- Nylon permeation barrier meets UL requirements for R12, R22, R500 and R134A.
- 2500 psi min. burst pressure, 500 psi max. working pressure for a 5 to 1 safety factor.
- Gaskets resist deterioration from existing CFC's, plus new HFO refrigerants and oils.
- Proven performance benefits of original Yellow Jacket® line, plus double barrier protection for CFC, HCFC and HFC (R404A, R134A, R507, etc.) control and system performance.
- Low loss anti-blowback SealRight™ fitting immediately traps refrigerant in the hose when disconnected, helping to meet non-venting regulations. Also prevents finger burns.

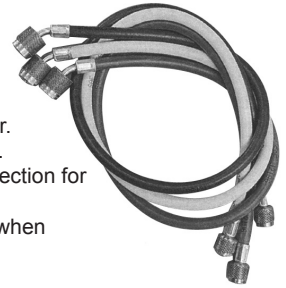

Part#	Length	Description	Mfr#
N8-54A	60"	3 pack, red, yellow, blue	22985
N8-55A	72"	3 pack, red, yellow, blue	22986

Kwik-Couplers® Service Hose Shut-Off Valves

For use with refrigeration and air conditioning service hoses when connecting to core valve type access fittings. Conventional threaded connection is converted to push-pull operation which is faster, easier and produces a positive seal

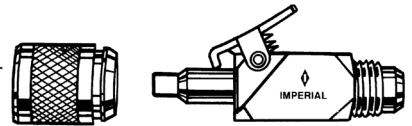

FEATURES:

- Automatic full depression of core valves without adjustment, regardless of core position.
- Coupler halves separately connect to access fitting and hose end.
- Automatic shutoff of hose ends permits discharging high side hose through manifold into low side
- Eliminates hazardous discharge of refrigerant and oil from system high side when disconnecting hose.
- Prevents freezing of hand when disconnecting – especially servicing heat pumps in cold weather
- Simplifies operation of charging critical amount of refrigerant into small system.

Part#	Description	Mfr#
N4-50	Straight coupler (45 Deg. flare) 1/4" female x 1/4" male	16-C

Freeze-Free A/C Coil Temperature Controls

Low cost control designed to protect the air conditioning coil from freezing. Opens at 38°F and closes when the temperature reaches 48°F.

FEATURES:

- Prevents frozen evaporator coils.
- Eliminates water damage to the heat exchanger, ceiling, ductwork or floors.
- Cuts down on nuisance service call backs.

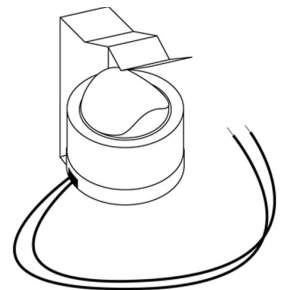
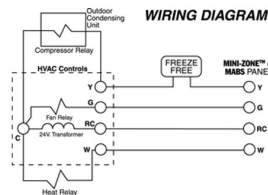

Part#
C138-16M ★

AIR CONDITIONING & REFRIGERATION

Condensate Float Switches

Used in condensate drain pan to shut down equipment and prevent overflow.

FEATURES:

- Low voltage
- Switches normally open or closed
- Positive hold down screw
- Easy installed

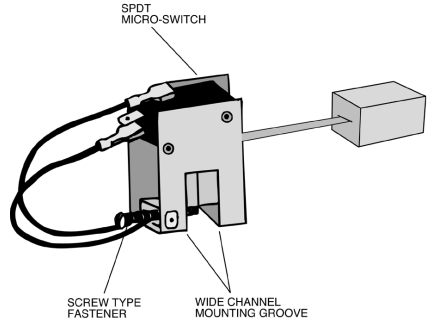

Part#	Description
K41M	★ Float switch with 12" wire
K41-5M	★ Float switch with 60" wire
K43M	Drain pan fitting

Automatic Condensate Pumps

For high efficiency applications such as condensate and waste water removal. Designed to fit most larger mechanical refrigeration and A/C units or in waste water disposal systems where increased volume is needed.

FEATURES:

- Leak proof, rustproof, high impact polystyrene tank
- 6 ft. power cord with 3-prong molded plug
- Stainless steel shaft
- Snap action switch
- ABS motor and tank cover, volute and impeller
- UL listed for water applications only
- Thermal overload protection
- 3/8" o.d. barbed discharge

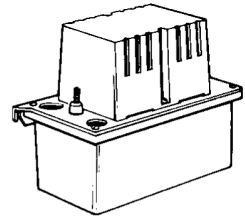

Part#	GPH @		Shut Off	Volts	Safety Switch Engages	Disengages	Model#	
	5 ft.	9 ft.						
K44-80	50*	30*	15ft.	115	Yes	2.40" water	1.25" water	VCM-15ULS
K44-82	50*	30*	15ft.	115	No	2.40" water	1.25" water	VCM-15UL

Flood Alarm Buzz Pro

The Flood Buzz Pro has two metal prongs on the bottom of the unit. Place the device, prongs down in the Water Heater Pan or the HVAC Condensing Pan. If the water level reaches 1/8", the circuit closes and sounds an alarm up to 110 dB.



Part#
K41-6M

AIR CONDITIONING & REFRIGERATION

Refrigeration Oil Pump Kit

Use to add or remove oil quickly and easily from A/C or refrigeration systems.

FEATURES:

- Piston-type, high pressure pump
- Special suction hose for easy oil removal
- Unique foot hold-down design for secure support
- Fits 1 or 5 gal. oil containers

INCLUDES:

- Pump
- Aluminum pick-up tube
- 1/4" plastic suction hose
- 2 red caps
- 2 red tube retainers
- High impact, plastic case



Part#

M6M ★

Blank-Off Plates for Copeland Compressors

Cover plates for the suction and/or liquid side of compressors.

Part#	Description
D74-1M	Copeland blank-off plate, small, all K bodies, high and low side
D74-2M	Copeland blank-off plate, large, 2 hole. E, L, M and 9 bodies, high and low side. 4 and 6 bodies, high side only.
D74-3M	Copeland blank-off plate, small, 4 hole. 8 bodies, high side only.
D74-4M	Copeland blank-off plate, large, 4 hole. 4, 6 and 8 bodies, suction side only.

BELTS AND BEARINGS

Pillow Block and Bearings

For heating, ventilation and air conditioning blowers.

FEATURES:

- Sintered bronze with oil cup
- Self-aligning
- Self-oiling
- Static-free, quiet operation
- Rubber spacers provided

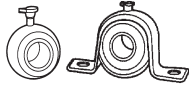

Part#	Description	Shaft Diam.	Pkg Qty
A222M	Pillow block	5/8"	2
A222-1M	Pillow block	3/4"	2
A222-2M	Pillow block	1"	2
A223-15M	Bearing	3/4"	2
A223-16M	Bearing	1"	2

Lennox Oil Burner Belt

1/4" top with 3/16" thickness. Series 2L160M, 16" outside length.

NOTE: See following page for 4L Series V-Belts.



Part#	Belt#	Outside Length
2L160	2L160	16"

Blower Shafts

For heating, ventilation and air conditioning blowers and pulleys.

FEATURES:

- Ground, polished steel
- Precision diameter
- Uniform concentricity
- Static-free, quiet operation
- Special lengths and machining on request

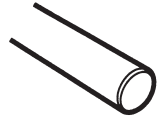

Part#	Diameter	Length
A224M	5/8"	20"
A224-1M	3/4"	20"
A224-1BM	3/4"	16"
A224-2M	1"	25"
A224-3M	1"	36"
A224-4M	5/8"	48"
A224-5M	3/4"	48"
A224-6M	1"	48"

BELTS AND BEARINGS

4L Series V-Belts



Part #	Outside Length
4L170	17"
4L180	18"
4L190	19"
4L200	20"
4L210	21"
4L220	22"
4L230	23"
4L240	24"
4L250	25"
4L260	26"
4L270	27"
4L280	28"
4L290	29"
4L300	30"
4L310	31"
4L320	32"
4L330	33"
4L340	34"
4L350	35"
4L360	36"
4L370	37"
4L380	38"
4L390	39"
4L400	40"
4L410	41"
4L420	42"
4L430	43"
4L440	44"

Part #	Outside Length
4L450	45"
4L460	46"
4L470	47"
4L480	48"
4L490	49"
4L500	50"
4L510	51"
4L520	52"
4L530	53"
4L540	54"
4L550	55"
4L560	56"
4L570	57"
4L580	58"
4L590	59"
4L600	60"
4L610	61"
4L620	62"
4L630	63"
4L640	64"
4L650	65"
4L660	66"
4L670	67"
4L680	68"
4L690	69"
4L700	70"
4L710	71"

CHEMICALS

CO2 Absorbing Fluids for Combustion Analysis



Absorbing fluids are selective in their chemical absorption of carbon dioxide. Their accuracy is well within the range required for industrial and professional applications. The reading are unaffected by the presence of most background gases in the sample.

Part #	Description
N28-17M	Includes: 2 bottles Clearview fluid, top gasket, screws, filtering material, 2 safety gloves
N28-16M	Includes: 1 bottle Clearview fluid, valve plunger gasket, top gasket, screws, diaphragm, filtering material, 2 safety gloves
N29-67M	Exact replacement for Bacharach Fyrite fluid Includes: 1 bottle fluid

STR-2+ Sludge Dispersant and De-Icer

Reduces service and maintenance calls.

FEATURES:

- Disperses and eliminates sludge clog filters, lines and tanks. Disperses and emulsifies water.
- Contains aircraft quality, non-alcohol de-icers to melt existing ice and prevent ice formation in lines and filters.
- Stabilizes fuel.
- Controls waxing and gelling.
- Bio compatible up to B20.
- Lowers pour point an additional 25°F.



Part #	Size	Treats Fuel up to
F2-17M	8 oz., One-Shot bottle	275 gal.
F2-18M	55 gal. drum	222,000 gal
F2-19M	1 gal., Tip-n-Pour spout	4,000 gal
F2-23M	1 gal. jug	4,000 gal
F2-27M	330 gal. tote	1.3 million gal

246 Super Duty Sludge Dispersant

Formulated to condition fuel tanks not on a regular maintenance conditioning program or that have been contaminated with sludge and/or water. Continued use after tank is clean helps ensure sludge free fuel storage.



Part #	Size	Fuel Type	Treatment
F2-246M	8 oz.	No. 2 oil	250 gal
		No. 4 oil	125 gal
		No. 6 oil	65 gal

DFC+ Premium Diesel Fuel Conditioner

Fuel conditioner used to improve diesel fuel quality and engine performance.

FEATURES:

- Restores power.
- Extends engine life.
- Improves fuel lubricity.
- Decreases fuel consumption.
- Provides corrosion protection
- Reduces carbon and soot formation.
- Contains Cetane improver and demulsifier.
- Meets NCWM requirements for Premium Diesel Specifications.
- Passes comprehensive OEM No Harm test at recommended treat rates.



Part #	Size
F4M	8 oz.

CHEMICALS

Biobor JF Biocide Treatment

FEATURES:

- 16 oz. 'Easy Squeeze' applicator container. Safely blends Biobor® JF into the fueling system as the tank is being filled in exact measured quantities. No-spill, no additional measurement device required.
- Dual-action property - kills present fungal growth, prevents future growth. - Shock Application: 1 oz. Biobor® JF per 40 gal. fuel. - Maintenance Application: 1 oz. Biobor® JF per 75 gal. fuel.



Part #	Description
F2-26M	16 oz. Easy Squeeze

Fuel Oil Analysis Kits

Test fuel oil for water, sediment and bacteria. Identification of these substances can determine proper treatment necessary to help eliminate sludge related problems.



FEATURES:

- Oil sampling input form.
- Return shipping box and labels.
- Oil test at our lab.

Part #
F2-16M

Kwik-Zorb Waterwick

Absorbs and removes the water that collects at the bottom of oil and kerosene tanks.



FEATURES:

- Can be used on openings 1-1/2" in diameter or larger.
- Removes approximately 8oz of water.

Part#
F2-30M

Cold Flow Improver

Cold weather anti-gel cold flow improver.



FEATURES:

- Maximizes cold weather diesel and distillate machinery and vehicle operability limits (CFPP) by up to 30°F.
- Permits smooth flowing fuel under the most extreme cold weather conditions.
- Lowers fuel pour point by over 50°F and reduces fuel's tendency to plug filters and lines.
- Melts existing ice in fuel and prevents ice formation in filters and fuel lines.
- Eliminates the use of expensive kerosene.

Part #	Size
050M	32 oz.

Odor Eliminator Spray

FEATURES:

- Excellent for the elimination of heavy oil odors.
- Propellant-free, environmentally friendly formulation.
- Conveniently sized to easily carry into service site.



Part #	Size
F1-75M	8 oz.

CHEMICALS

Reach-All Lubricating Oils

Field-proven for more than thirty years. Specially formulated for use on circulator bearing assemblies, centrifugal pumps, electric motors, blowers and bearings.



FEATURES:

- Provides excellent lubrication and resists build up of contaminants
- Non-detergent, high grade

Part #	Size
--------	------

F2-32M	1 qt. plastic bottle
F2-40M	4 oz. refillable plastic bottle with pullout spout for hard-to-reach places

Fast- Vac Vacuum Pump Oil

Premium high vacuum pump oil.



Part #	J/B Part#	Size
M4-83A	DVO-1	1 pint
DVO-12-12	DVO-12	32 oz.

WD-40 All Purpose Lubricant

FEATURES:

- Loosens rusted parts. Frees sticky mechanisms and penetrate to free up frozen or rusted metal parts and fasteners. Keeps controls and linkages working freely.
- Displaces moisture. WD-40 is a non-conductor and can be used to dry electrical and electronic equipment.
- Stops squeaks. Is silicone free and will not leave a messy or gummy residue.
- Protects metal against moisture and corrosive elements.
- Cleans: Removes grease, grime, tar, adhesives, gum, crayon, water deposits.
- Non-conductive.



Part #	Size
--------	------

F2-57	3 oz. aerosol
F2-58	11 oz. aerosol

ELECTRICAL

Jumper Magnetic

FEATURES:

- Hands free way to jump low voltage circuit.
- Ideal for recessed terminals.
- Excellent for troubleshooting low voltage thermostats, control boards, sensors, switches and panels.
- Can be used up to 30 volts/5 amps.



Part#

E397-314M

Extension Light

Extension light with 25 ft. extension cord.

FEATURES:

- OSHA approved.
- With side outlet and switch.
- Steel bulb guard.



Part#

E313

Heavy Duty Extension Cord

By **POWER CORDS & CABLES CORP.**

FEATURES:

- Three conductor cables with molded-in receptacles
- OSHA approved for indoor and outdoor use
- UL approved
- Polarized connectors
- Orange color for visibility



Part#	Length	125V Rating
E310	25'	13 amp
E310-1M	50'	13 amp

Electrical Jumpers

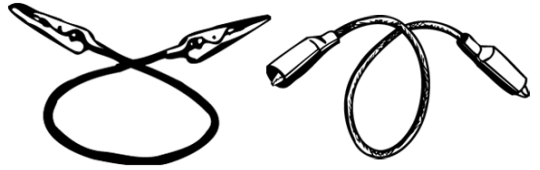

Part#	Description	Pkg Qty.
E58M	12" Long, non-insulated	25
E58-2M	12" long, insulated clips	12
E58-5M	36" long, insulated clips	2
E58-6M	Alligator clips	25

ELECTRICAL

Test Cord Sets

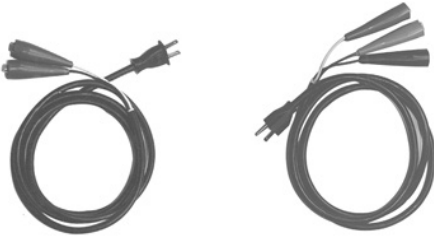

Part#	Description
E59M	6' long, 12 amp max, 18/2 sleeved cord, male plug
E59-2M	6' long, 15 amp max, 14/3 sleeved cord, male plug
E59-5M	6' long, 15 amp max, 14/3 sleeved cord, female plug

Test Cords



Used to power any 110V device in remote areas, without having to hard-wire the device.

FEATURES:

- Red and black heavy duty, insulated boots.
- Large clips
- Rugged construction.
- 16 gauge wire.
- 125 amp.

FEMALE TEST CORD

Part#	Wires	Volt	Length
E397-301M	3	3 - 30	24"

MALE TEST CORD

E397-302M	2	2 - 20	72"
-----------	---	--------	-----

Test Leads

18" multicolored test leads. 5 pairs- 2 of each color- red, yellow, black, green, and white

FEATURES:

- 18 gauge wire
- 24 VAC

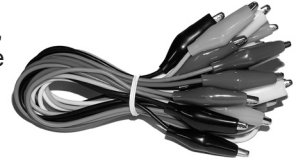

Part#	Volts	Amps	Wire	Length
E397-307M	300	5	18 gauge	18"

Fuse Holders

Fuse holder for glass fuses. Handy twist cap to remove and replace fuses.



Item#	Description
E397-303M	5 pak

Shatter-resistant Light Bulbs

Specially coated to be shatter-resistant, weather proof and improve light diffusion.

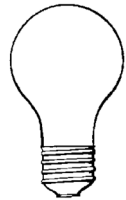

Part#	Watts	Pkg Qty.
E317-7AM	75	2
E317-8A	100	2

ELECTRICAL

Kwik-Fit Electrical Wiring Harnesses

FEATURES:

- Liquid tight
- All components UL listed
- Includes connectors: one each, straight and 90°.
- Special lengths available on request

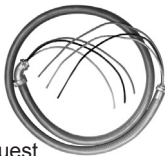

METAL CONNECTIONS ATTACHED

Part#	Size	Wire Size
E306-40M	1/2" x 4'	10
E306-45M	1/2" x 6'	10
E306-60M	3/4" x 4'	8
E306-65M	3/4" x 6'	8

LOOSE PLASTIC FITTINGS

E306-70M	1/2" x 4'	10
E306-72M	1/2" x 6'	10
E306-74M	3/4" x 4'	8
E306-76M	3/4" x 6'	8

Air Conditioner Disconnects

FEATURES:

- #10 wire rated at 30 amps
- UL listed weather proof
- Padlock door



FUSIBLE DISCONNECTS

Part#	Description
E306-110M	60 amp fusible disconnect with 6 ft. #8 THHN harness
E306-115M	60 amp fusible disconnect

NON-FUSIBLE DISCONNECTS

E306-100M	60 amp disconnect with 6 ft. #10 THHN harness
E306-105M	60 amp plastic disconnect

Wire Connectors Mit-Paks

FEATURES:

- Accepts solid or stranded wire
- Connectors are color coded and flame retardant
- Spring inside connector makes twisting wire easier.



Part#	Color	AWG Range	Min.	Max.	Pkg Qty.
T397-321M	Gray	22-16	1 #20, 1 #22	2 #16	40
T397-322M	Blue	22-14	3 #22	3 #16	40
T397-323M	Orange	22-14	3 #22, 1 #18	2 #14, 3 #16	20
T397-324M	Yellow	18-12	1#4, 1#18	2#14, 3#16	20
T397-325M	Red	18-10	1 #12, 2 #18	3 #10	15

Wire Connectors

Part#	Color	AWG Range	Pkg Qty.
E358-5M	Red	12-6	50
E358-7M	Yellow	16-10	100
E358-9M	Orange	22-14	100
E358-10M	Blue	22-14	100
E358-11M	Gray	22-16	100

Circuit Breakers



E397-400M thru 430



E397-435M



E397-440M

Part#	Rating	Type
E397-400M	15 amp	Square D
E397-405M	20 amp	Square D
E397-410M	30 amp	Square D
E397-415M	30 amp	Square D, double pole
E397-420M	15 amp	Interchangeable
E397-425M	20 amp	Interchangeable
E397-430M	30 amp	Interchangeable
E397-435M	30 amp	Interchangeable, twin pole
E397-440M	30 amp	Interchangeable, double pole

ELECTRICAL

Electrical Outlet Boxes

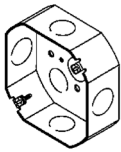

E326M

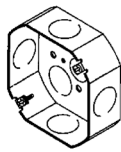

E326-1M

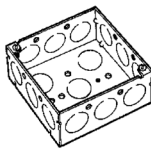

E325M

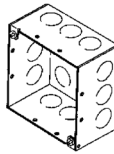

E325-15M

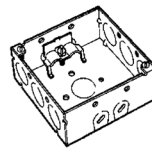

E325-12M

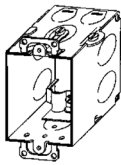

E329-8M

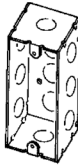

E328M

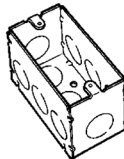

E328-5M

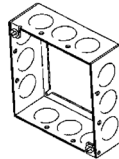

E325-25M

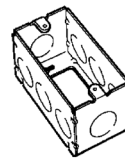

E328-10M

FEATURES:

- UL listed
- Conforms to applicable UBC codes

Part#	Type	Depth	Side Knockout	End Knockout	Bottom Knockout
E326	Octagonal welded, 4"	1-7/8"	One 1/2"	One 1/2"	Five 1/2"
E326-1	Octagonal welded, 4"	1-7/8"	One 3/4"	One 3/4"	Three 1/2" in a line, two 3/4" opposite ends
E325	Square welded, 4"	1-1/2"	Three 1/2"	Three 1/2"	Five 1/2"
E325-12	Square welded, 4"	1-1/2"	Two loom	Three 3/4"	One 1/2"
E325-15	Square welded, 4"	2-1/8"	Three 1/2"	Three 1/2"	Five 1/2"
E329-8	Gangable switch box, 3" x 2"	2-1/2"	Two 1/2" nail holes	One 3/4"	Two 1/2"
E328	Utility box welded, 4" x 2-1/8"	1-7/8"	Three 1/2"	One 1/2"	Three 1/2", 4 nail holes
E328-5M	Utility box welded, 4" x 2-1/8"	2-1/8"	Three 1/2"	One 1/2"	Three 1/2", 4 nail holes
E325-25	Extension ring, 4" square, welded	1-1/2"	Three 1/2"	Three 1/2"	Open
E328-10	Extension ring, utility box, 4" x 2-1/8" welded	1-7/8"	Three 1/2"	One 1/2"	Open

ELECTRICAL

Electrical Cable Connectors

NM, BX, GREENFIELD

Part#	Size	Desc.	Pkg Qty.
E397-50M	3/8" x 1/2"	Straight NM connector	4
E397-52M	3/8" x 1/2"	Straight BX connector	4
E397-54M	1/2" x 1/2"	Greenfield set screw connector	3
E397-56M	3/4" x 3/4"	Greenfield set screw connector	2
E397-58M	3/8" x 90°	Angled BX flex connector	4
E397-60M	1/2" x 90°	Angled BX flex connector	2
E397-62M	3/4" x 90°	Angled BX flex connector	2
E397-64M	3/8"	Duplex BX flex connector	2

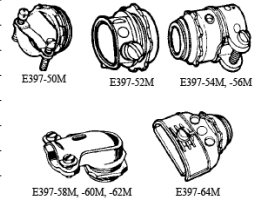

THINWALL - ELECTRICAL METALLIC TUBING

E397-70M	1/2"	EMT straight connector	3
E397-72M	3/4"	EMT straight set screw connector	2
E397-74M	1/2"	EMT straight compression connector	2
E397-76M	3/4"	EMT straight compression connector	2
E397-78M	1/2"	EMT angle compression connector	2
E397-79M	1/2"	EMT offset connector	2
E397-79BM	1/2"	EMT offset connector	10
E397-80M	3/4"	EMT angle compression connector	2
E397-84M	1/2"	EMT set screw coupling	5
E397-86M	1/2"	EMT compression coupling	5
E397-88M	3/4"	EMT compression coupling	3

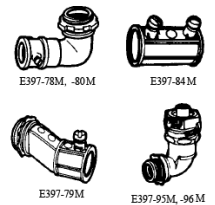

LIQUID TIGHT

E397-90M	1/2"	Straight liquid tight connector	2
E397-92M	3/4"	Straight liquid tight connector	1
E397-93M	3/8" x 1/2"	Liquid tight connector	2
E397-95M	1/2" x 90°	Angled liquid tight connector	2
E397-96M	3/4" x 90°	Angled liquid tight connector	1
E397-98M	1/2" x 90°	Angled liquid tight connector	2
E397-100M	3/4" x 90°	Angled liquid tight connector	1

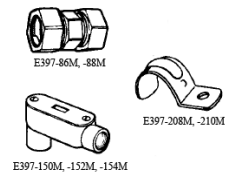

RIGID CONDUIT BODIES

E397-150M	1/2"	LB type covered, set screw conduit	1
E397-152M	1/2"	LR type covered, set screw conduit	1
E397-154M	1/2"	LL type covered, set screw conduit	1

HARDWARE

E397-200M	7/8"	Cable staples	50
E397-202M	1/2"	Plastic staples	25
E397-204M	- - -	Plastic thermostat wire staples	25
E397-206M	1/2"	Knockout plug	4
E397-208M	1/2"	EMT strap, single hole	5
E397-210M	3/4"	EMT strap, single hole	4
E397-216M	0	Fiber BX bushing	35
E397-218M	1	Fiber BX bushing	35
E397-220M	1/2"	Conduit locknut	5
E397-222M	3/4" - 1/2"	Reducing washer	4
E397-223M	1" - 1/2"	Reducing washer	4
E397-224M	1" - 3/4"	Reducing washer	4

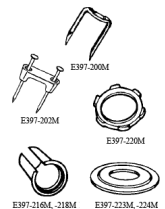

ELECTRICAL

Electrical Outlet Box Covers



E397 M

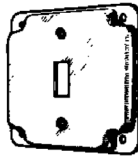

E397-2 M



E397-3 M



E397-6 M



E397-9M



E397-12 M



E397-14 M



E397-16 M

4" SQUARE COVERS

Part#	Description	Pkg Qty.
E397M	Blank cover	3
E397-2M	Toggle switch cover	1
E397-3M	Single duplex receptacle cover	1
E397-4M	Double duplex receptacle cover	1
E397-6M	Switch and receptacle cover	1

4" ROUND COVERS

E397-9M	Round blank cover for octagonal box 4-1/4" x 2-1/4" covers	1
E397-12M	Blank cover for utility box	3
E397-14M	Switch cover for utility box	3
E397-16M	Receptacle cover for utility box	3

Emergency Switch Covers and Fused Box Covers

EMERGENCY COVERS

Part#	Size	Description	Pkg Qty.
E397-20M	2-1/4" W	Switch cover: GAS BURNER EMERGENCY	3
E397-22M	2-3/4" W	Switch cover: GAS BURNER EMERGENCY	3
E397-24M	2-1/4" W	Switch cover: OIL BURNER EMERGENCY	3
E397-26M	2-3/4" W	Switch cover: OIL BURNER EMERGENCY	3
E397-28M	4" square	Switch cover: OIL BURNER EMERGENCY	1
E397-30M	3-1/4" round	Switch cover: OIL BURNER EMERGENCY	1
E397-32M	4" round	Switch cover: OIL BURNER EMERGENCY	1
E397-34M	- - -	Fused utility box cover with switch	1

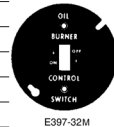

E397-32M

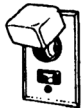

E397-34M

ELECTRICAL

Electrical Switches and Dimmers

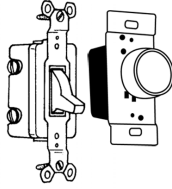

Part#	Description
E397-310M	15 amp, single pole, quiet switch
E397-320M	20 amp, double pole, quiet switch
E397-327M	Rotary dimmer switch

Electrical Receptacles

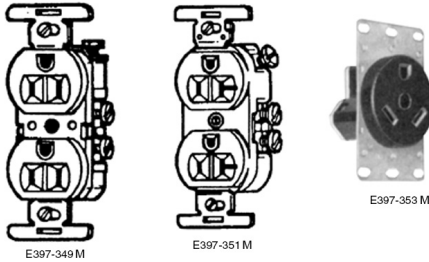

Part#	Rating	Type
E397-349M	15 amp, 125 v	Duplex
E397-351M	20 amp, 125 v	Duplex
E397-353M	30 amp	Air conditioning

Combination Switch Kit

Combination Switch Kit



Part#	Rating	Description
E397-360M	15 amp, 125 v	Receptacle and Cover

Combination Switch Only

Part#	Description
E397-361M	Combination Switch Only

Tapes and Strapping

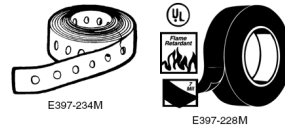

TAPES

Part#	Description	Roll Size
E397-228M	Premium grade electrical tape. Black, weather-resistant vinyl. 18° - 105°F. UL listed. Flame-retardant. 7 mil.	3/4" x 66"
E397-230M	All-weather electrical tape.	3/4" x 60"

STRAPPING

E397-234M	Galvanized metal. Perforated.	3/4" x 10 ft.
-----------	-------------------------------	---------------

Electrical Taps and Adapters

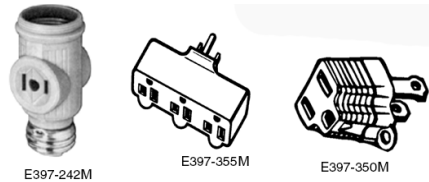

TAPS

Part#	Description	Pkg Qty.
E397-242M	Current tap	1
E397-355M	Tri-tap	1

ADAPTERS

E397-350M	3 prong adapter	2
-----------	-----------------	---

Fuse Pullers

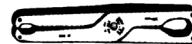

Part#
E397-240M

FILTERS

Spin-on Oil Filters

For use in all residential and light commercial applications. Reduces truck inventory.

FILTER ELEMENT FEATURES:

- Heavy duty outer shell construction with durable Epoxy coating.
- 10 micron pleated composite element is three times thicker than standard filters for deeper filtration.
- Rated 60 PSI maximum working pressure.
- Rate 40 GPH flow rate.



Listed in US and Canada.

TOP FEATURES:

- E-Z on self centering steel spud.
- #380 aluminum alloy top offer 50% greater tensile strength vs. competitive cast iron tops.
- Precision die-cast construction is considered superior to traditional sand casting that results in pinhole leaks
- **RATED FOR B20**



Part#	Description	Competitive Cross Reference
264-90M	Standard Spin-On complete with top. All Residential and Light Commercial	- Gar-Ber 11VF-OB, 11BV-M - Crown 41439 - Sid Harvey 264-90 - Wix 24100 - Westwood F100 - Nozzle Guard NG 300-G
264-91M	Standard Spin-On - replacement element only, less top	- Gar-Ber R&M - Crown 41436 - Sid Harvey 264-91 - Wix 24104 - Westwood F100-10 - Nozzle Guard 80000905
264-90BM	Standard Spin-On complete with top and mounting bracket	- Gar-Ber 11VF-OB, 11BV-M - Crown 41439 - Sid Harvey 264-90B - Wix 24100 - Westwood F100-3
264-90GM	Standard Spin-On complete with top and gauge	- Gar-Ber 11VF-OB, 11BV-M - Crown 41439 - Sid Harvey 264-90G - Wix 24100 - Westwood F100-5
264-90GBM	Standard Spin-On complete with top, mounting bracket and gauge	- Gar-Ber 11VF-OB, 11BV-M - Crown 41439 - Sid Harvey 264-90GB - Wix 24100 - Westwood F100-7
290-SOM	Spin on top(only)	

FILTERS

Oil Filter Strap Wrench

FEATURES:

- Adjust to fit any circumference or shape up to 6" diameter.
- Grip, loosen or tighten almost anything. Won't scratch or damage surfaces.
- Cushioned grip for maximum comfort.



Part#

T535-2M



Complete Fuel Oil Filter with choice of Micro-Flow or Felt Elements

The Latest in Fuel Oil Filtration Design and Technology.

NOTE: The 265M and 264M oil filters come with the patented Micro-Flow oil filter element made of continuous, micro-spun fiber. The non-shed design help eliminate plugged nozzles and strainers.



FEATURES:

- Hot dipped, galvanized can for rust protection, inside and out.
- Using precision die cast aluminum eliminates the leaks associated with sand cast, cast iron.
- #380 Aluminum alloy top for 50% greater tensile strength.
- High capacity containment reservoir extends filter life.
- Highest UL pressure rating.
- Highest UL GPH rating.
- Zinc-plated internal components resist rust formation and make center bolt removal easy.
- 360° screwdriver slot for fast and easy removal.



Listed in US and Canada.

Part#	Includes	Flow Rate	Competitive Cross Reference
264M	With Micro-Flow filter element	15 GPH flow rate	- General 1A-25A - Sid Harvey 264 - Unifilter 77 - Westwood S254
264FM	With Felt filter element	15 GPH flow rate	- General 1A-25A - Sid Harvey 264F - Unifilter 77 - Westwood S254
265M	With Micro-Flow filter element	30 GPH flow rate	- General 2A-700A - Sid Harvey 265 - Unifilter 99
265FM	With Felt filter element	30 GPH flow rate	- General 2A-700A - Sid Harvey 265F - Unifilter 99
264 BRACKETM	Wall mount filter bracket	N/A	- Fits most Fulflo, General Filters, Mitco, Sid Harvey and Westwood can style filters

NOTE: BIO compatible filters available on request.

FILTERS

Fuel Oil Filter Upgrade Kits

For hard-to-change filter replacements. Perfect for obstructed or hard-to-reach filter cans. Leaves the piping alone and filter top intact while replacing the can and element. 3/8" NPT.

INCLUDES: Filter can, cover gasket, center bolt, fiber washers, filter element (Micro-Flow or Felt).

Part#	Includes	Competitive Cross Reference
264LTM	With Micro-Flow filter element	General 1A-25A, Sid Harvey 264LT, Unifilter 77, Westwood S254
264FLM	With Felt filter element	General 1A-25A, Sid Harvey 264FL, Unifilter 77, Westwood S254
265LTM	With Micro-Flow filter element	General 2A-700A, Sid Harvey 265LT, Unifilter 99
265FLM	With Felt filter element	General 2A-700A, Sid Harvey 265FL, Unifilter 99

NOTE: BIO compatible filters available on request.



FILTERS

Micro-Flow Oil Filter Replacement Elements

State-of-art oil filter cartridges designed for a full range of nozzle gallonages.

NOTE: Testing by an independent laboratory confirms that the Micro-Flow replacement oil filter is extremely efficient in filtering foreign particles.

FEATURES:

- Computer design gives largest surface area and most flutes for increased filtering.
- Greatest volume - more filter material than comparable filter elements.
- Change filters less frequently due to increased holding capacity.
- Non-shed design is fiber welded. Does not contain bonding agents that may Cause nozzle to clog.
- Y-fiber composition for increased depth filtration.
-  UL® recognized in US and Canada.

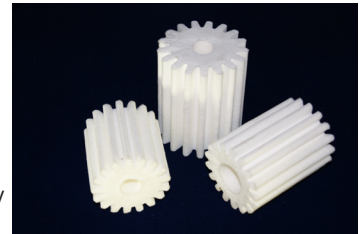

Part#	Pkg Qty.	Description	Competitive Cross Reference
250-30M	30	4" Fulflo elements	Fulflo FB4, Sid Harvey 250-30
250-48M	48	4" Fulflo elements individually bagged with gaskets	Fulflo FB4, Sid Harvey 250-48
251-20AM	10	6" Fulflo elements individually bagged with gaskets	Fulflo FB6, Sid Harvey 251-20A
252-40AM	6	8" Fulflo elements individually bagged with gaskets	Fulflo FB8, Sid Harvey 252-40A
252-50AM	4	10" Fulflo elements individually bagged with gaskets	Fulflo FB10, Sid Harvey 252-50A
264-48M	48	Elements individually bagged with gaskets and disposal bags	General 1A-25A, Sid Harvey 264-48, Unifilter 77, Westwood S254
265-12AM	12	Elements individually packed with gaskets and disposal bags	General 2A-700A, Sid Harvey 265-12A
274M	6	Elements individually packed with gaskets and disposal bags	Firomatic RC20, Sid Harvey 274
275M	6	Elements individually packed with gaskets and disposal bags	Firomatic RC30, Sid Harvey 275
287-2M	6	Elements individually packed with gaskets and disposal bags	Purolator PF2002, Sid Harvey 287-2

Note: BIO compatible filters available on request.

Replacement Gaskets for Fuel Oil Filters

253-1M	30	Neoprene cover gasket	- Fulflo FB4, FB6, FB8, FB10 - Sid Harvey 253-1
253-5M	1	Fiber gasket	- Fulflo FB4, FB6, FB8, FB10 - Sid Harvey 253-5
256-2M	30	Cover gasket	- General Filters 1A25A - Mitco 264M - Sid Harvey 264
256-3M	1	Fiber port/bolt gasket	- General Filters 1A25A - Mitco 264M - Sid Harvey 264
256-4M	20	Cover gasket	- Mitco 264M - Sid Harvey 264
257-2M	20	Cover gasket	- General Filters 2A-700 - Mitco 265M - Sid Harvey 265
274-1M	20	Cover gasket	- Firomatic RC20, RC30 - Sid Harvey 274-1
275-3M	20	Bolt gasket	- Firomatic RC-20, RC-30 - Sid Harvey 275-3
287-1M	20	Cover gasket	- Purolator PF2002 - Sid Harvey 287-1

FILTERS

Felt Fuel Oil Filter Elements

Standard felt elements prevent clogged burner nozzles and reduce service problems.

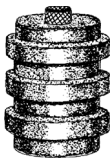

FEATURES:

- High grade wool material.
- Individually packed in bags for added protection.
- Gaskets and disposal bags included.
- UL® recognized in US and Canada.



Part#	Competitive Cross Reference	Pkg Qty.
264-1AM	- AutoFlo F300 - General Filters 1A-25A - Westwood S25	48
265-1AM	- Edco S254 - General Filters 2A-700A	12
250-4M	- Fulflo FB4	48

NOTE: BIO compatible filters available on request.

Wound Cotton Fuel Oil Filter Elements

Functional replacements for Fulflo FB4 in heating systems using #1 or #2 fuel oil.



Part#	Description	Pkg Qty.
250-2M	4" wound cotton filters only less cover, bolt and gaskets	30
250-2BM	4" wound cotton filters individually packed with cover, bolt and vent gaskets	48
251-2M	6" wound cotton filters individually packed with cover, bolt and vent gaskets	12
252-4M	8" wound cotton filters individually packed with cover, bolt and vent gaskets	6
252-5M	10" wound cotton filters individually packed with cover, bolt and vent gaskets	4

Gasket Kits for Fuel Oil Filters

Each kit contains 10 cover gaskets, 10 bolt gaskets for popular filter elements.

Part#	For Use With
264GM	- General Filters 1A25A - Mitco 264M - Sid Harvey 264 - Unifilter 77 - Westwood S254, F10, F12, F15, F20, F25
265GM	- Fulflo FB - General Filters 2A700A - Mitco 265M - Sid Harvey 265 - Unifilter 99 - Westwood F30, F32, F35, F65, F70
250GM	- Fulflo FB4, FB6, FB8, FB10 - Sid Harvey 250
274GM	- Firomatic RC20 - Sid Harvey 274
264 BRACKETM	- Wall mounted filter bracket for most popular canned filters listed above

FILTERS

Micro-Kleen Dual Oil Filtration System

FEATURES:

- Unique dual filter design provides superior filtration with extended element life to keep nozzles clean.
- Oil is first filtered through our revolutionary Micro-Flow fiber with a 50 micron filter rating. It then passes through the 10 micron secondary Spin-on filter, leaving it virtually contaminant free.
- Installing the Micro-Kleen Dual Oil Filtration System is easy for both new and after market equipment.
- Proper maintenance of the Micro-Kleen Dual Oil Filtration System is assured by using the optional vacuum gauge.
- The service tech can easily monitor any increase in vacuum indicating that the filter elements need changing.
- Comes with hanger bracket #264BRACKETM.

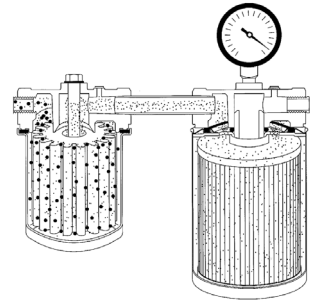

Part#	Primary Filter @45 Microns	Secondary Filter @10 Micron	Vacuum Gauge Included	Size	Bracket
264-290M	264M Micro-Flow, 15 GPH	264-90M Spin-On, 40 GPH	No	3/8"	Yes
264-290FM	264M Micro-Flow, 15 GPH	264-90M Spin-On, 40 GPH	Yes	3/8"	Yes
265-292-2M	265M Micro-Flow, 30 GPH	264-90M Spin-On, 40 GPH	No	3/8"	Yes
265-292-2FM	265M Micro-Flow, 30 GPH	264-90M Spin-On, 40 GPH	Yes	3/8"	Yes

Airefresh Replacement Media for Air Cleaners

Replacement filters that offer I.A.Q. benefits and can be used in all popular brands of media air cleaners.

FEATURES:

- Return duct mount.
- For use on oil. Gas and electric heat furnaces and CAC systems up to 5 tons.
- MERV 8 rating (micron Efficiency Rating Value) as established by ASHRAE 52.1-92 and 52.2-1999.
- Rated at 30 – 35 initial Dust Spot Efficiency at 90 – 93% average arrestance.

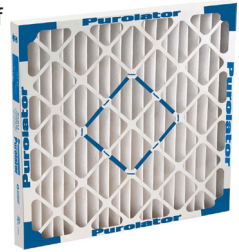

Part#	Dimensions	Capacity	Cooling	Static Pressure Drop
L13-72	16" x 25" x 4"	1400 CFM	Up to 3.5 ton cooling	0.19 in W.C.
L13-73	20" x 20" x 4"	1400 CFM	Up to 3.5 ton cooling	0.19 in W.C.
L13-74	20" x 25" x 4"	1725 CFM	Up to 5 ton cooling	0.19 in W.C.
L13-75	24" x 24" x 4"	2500 CFM	Up to 5 ton cooling	0.19 in W.C.

Hog Hair Air Filter

Natural Fiber Air Filter for all HVAC application.

FEATURES:

- Easy installation - cut to size
- Easy to maintain - washable / Refillable
- Higher capacity filter – last 3 times longer
- Mold and mildew resistant



Part#	Dimensions (L x W x D)
L13-50M	20" x 30" x 1"

FILTERS

Static-Aire Electrostatic Filters

Effective and economical alternative to electronic air cleaners. Fits into existing framework of warm air furnaces and air conditioning units.

FEATURES:

- Generates its own static charge.
- Plastic channel construction with drain holes.
- Easy installation
- No wiring required.
- No duct work or sheet metal work involved.
- 1" Thickness only.



Part#	Dimensions (L x W x D)
L14-10M	10" x 20" x 1"
L14-15M	15" x 20" x 1"
L14-20M	16" x 20" x 1"
L14-22M	16" x 20" x 1"
L14-25M	20" x 20" x 1"
L14-27M	20" x 25" x 1"
L14-28M	20" x 30" x 1"
L14-30M	24" x 24" x 1"
L14-32M	24" x 30" x 1"
L14-34M	14" x 30" x 1"

Custom Order Sizes

Calculate size by determining the area in sq. in.

(W x L = Area Square Inches)

Once you've calculated the size in sq. in., select from the part numbers below.

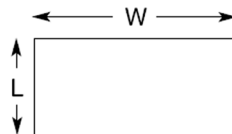

Part #	Area Square	Thickness
L14-1-99-1M	0-99	1"
L14-100-199-1M	100-199	1"
L14-200-299-1M	200-299	1"
L14-300-399-1M	300-399	1"
L14-400-499-1M	400-499	1"
L14-500-599-1M	500-599	1"
L14-600-699-1M	600-699	1"
L14-700-799-1M	700-799	1"
L14-800-899-1M	800-899	1"
L14-900-999-1M	900-999	1"

FILTERS

Grease Trap Filters

Mitco makes replacement filters for heating and A/C blowers and exhaust fans and hoods. Custom sizes made to order quickly.

FEATURES:

- All aluminum construction
- Criss-crossed sheets for maximum entrapment
- Washable.
- Any size in 1/2", 1", or 2" thickness

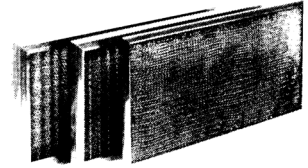

To Find Area Square Inches W x L = Area of Square Inches

Part #	Area Square (in.)	Thickness	Part #	Area Square (in.)	Thickness
L13-50-99-1GM	50-99	1/2" & 1"	L13-50-99-2GM	50-99	2"
L13-100-149-1GM	100-149	1/2" & 1"	L13-100-149-2GM	100-149	2"
L13-150-199-1GM	150-199	1/2" & 1"	L13-150-199-2GM	150-199	2"
L13-200-249-1GM	200-249	1/2" & 1"	L13-200-249-2GM	200-249	2"
L13-250-299-1GM	250-299	1/2" & 1"	L13-250-299-2GM	250-299	2"
L13-300-349-1GM	300-349	1/2" & 1"	L13-300-349-2GM	300-349	2"
L13-350-399-1GM	350-399	1/2" & 1"	L13-350-399-2GM	350-399	2"
L13-400-449-1GM	400-449	1/2" & 1"	L13-400-449-2GM	400-449	2"
L13-450-499-1GM	450-499	1/2" & 1"	L13-450-499-2GM	450-499	2"
L13-500-549-1GM	500-549	1/2" & 1"	L13-500-549-2GM	500-549	2"
L13-550-599-1GM	550-599	1/2" & 1"	L13-550-599-2GM	550-599	2"
L13-600-649-1GM	600-649	1/2" & 1"	L13-600-649-2GM	600-649	2"
L13-650-699-1GM	650-699	1/2" & 1"	L13-650-699-2GM	650-699	2"
L13-700-749-1GM	700-749	1/2" & 1"	L13-700-749-2GM	700-749	2"
L13-750-799-1GM	750-799	1/2" & 1"	L13-750-799-2GM	750-799	2"
L13-800-849-1GM	800-849	1/2" & 1"	L13-800-849-2GM	800-849	2"
L13-850-899-1GM	850-899	1/2" & 1"	L13-850-899-2GM	850-899	2"
L13-900-949-1GM	900-949	1/2" & 1"	L13-900-949-2GM	900-949	2"
L13-950-999-1GM	950-999	1/2" & 1"	L13-950-999-2GM	950-999	2"
L13-1000-1049-1GM	1000-1049	1/2" & 1"	L13-1000-1049-2GM	1000-1049	2"
L13-1050-1099-1GM	1050-1099	1/2" & 1"	L13-1050-1099-2GM	1050-1099	2"

FILTERS

Refillable Air Filters

Mitco makes replacement filters for heating and A/C blowers and exhaust fans and hoods. Custom sizes made to order quickly.

FEATURES:

- Glass fiber encased in an aluminum frame with an expanded metal back
- Media may be replaced with glass fiber or synthetic material
- Any size in 1/2", 1", or 2" thickness.

To Find Area Square Inches $W \times L = \text{Area of Square Inches}$

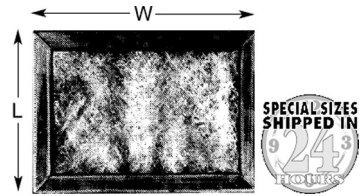

Part #	Area Square (in.)	Thickness
L13-1-49-1RM	0-49	1/2" & 1"
L13-50-99-1RM	50-99	1/2" & 1"
L13-100-149-1RM	100-149	1/2" & 1"
L13-150-199-1RM	150-199	1/2" & 1"
L13-200-249-1RM	200-249	1/2" & 1"
L13-250-299-1RM	250-299	1/2" & 1"
L13-300-349-1RM	300-349	1/2" & 1"
L13-350-399-1RM	350-399	1/2" & 1"
L13-400-449-1RM	400-449	1/2" & 1"
L13-450-499-1RM	450-499	1/2" & 1"
L13-500-549-1RM	500-549	1/2" & 1"
L13-550-599-1RM	550-599	1/2" & 1"
L13-600-649-1RM	600-649	1/2" & 1"
L13-650-699-1RM	650-699	1/2" & 1"
L13-700-749-1RM	700-749	1/2" & 1"
L13-750-799-1RM	750-799	1/2" & 1"
L13-800-849-1RM	800-849	1/2" & 1"
L13-850-899-1RM	850-899	1/2" & 1"
L13-900-949-1RM	900-949	1/2" & 1"
L13-950-999-1RM	950-999	1/2" & 1"
L13-1000-1049-1RM	1000-1049	1/2" & 1"
L13-1050-1099-1RM	1050-1099	1/2" & 1"

Part #	Area Square (in.)	Thickness
L13-1-49-2RM	0-49	2"
L13-50-99-2RM	50-99	2"
L13-100-149-2RM	100-149	2"
L13-150-199-2RM	150-199	2"
L13-200-249-2RM	200-249	2"
L13-250-299-2RM	250-299	2"
L13-300-349-2RM	300-349	2"
L13-350-399-2RM	350-399	2"
L13-400-449-2RM	400-449	2"
L13-450-499-2RM	450-499	2"
L13-500-549-2RM	500-549	2"
L13-550-599-2RM	550-599	2"
L13-600-649-2RM	600-649	2"
L13-650-699-2RM	650-699	2"
L13-700-749-2RM	700-749	2"
L13-750-799-2RM	750-799	2"
L13-800-849-2RM	800-849	2"
L13-850-899-2RM	850-899	2"
L13-900-949-2RM	900-949	2"
L13-950-999-2RM	950-999	2"
L13-1000-1049-2RM	1000-1049	2"
L13-1050-1099-2RM	1050-1099	2"

FILTERS

Permanent, Washable Air Filters

Mitco makes replacement filters for heating and A/C blowers and exhaust fans and hoods. Custom sizes made to order quickly.

FEATURES:

- High efficiency foam media reinforced with aluminum wire screen
- Encased in a heavy duty aluminum frame
- Any size in 1/2", 1", or 2" thickness

To Find Area Square Inches $W \times L = \text{Area of Square Inches}$

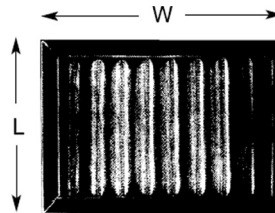

Part #	Area Square (in.)	Thickness
L13-1-49-1PM	0-49	1/2" & 1"
L13-50-99-1PM	50-99	1/2" & 1"
L13-100-149-1PM	100-149	1/2" & 1"
L13-150-199-1PM	150-199	1/2" & 1"
L13-200-249-1PM	200-249	1/2" & 1"
L13-250-299-1PM	250-299	1/2" & 1"
L13-300-349-1PM	300-349	1/2" & 1"
L13-350-399-1PM	350-399	1/2" & 1"
L13-400-449-1PM	400-449	1/2" & 1"
L13-450-499-1PM	450-499	1/2" & 1"
L13-500-549-1PM	500-549	1/2" & 1"
L13-550-599-1PM	550-599	1/2" & 1"
L13-600-649-1PM	600-649	1/2" & 1"
L13-650-699-1PM	650-699	1/2" & 1"
L13-700-749-1PM	700-749	1/2" & 1"
L13-750-799-1PM	750-799	1/2" & 1"
L13-800-849-1PM	800-849	1/2" & 1"
L13-850-899-1PM	850-899	1/2" & 1"
L13-900-949-1PM	900-949	1/2" & 1"
L13-950-999-1PM	950-999	1/2" & 1"
L13-1000-1049-1PM	1000-1049	1/2" & 1"
L13-1050-1099-1PM	1050-1099	1/2" & 1"

Part #	Area Square (in.)	Thickness
L13-1-49-2PM	0-49	2"
L13-50-99-2PM	50-99	2"
L13-100-149-2PM	100-149	2"
L13-150-199-2PM	150-199	2"
L13-200-249-2PM	200-249	2"
L13-250-299-2PM	250-299	2"
L13-300-349-2PM	300-349	2"
L13-350-399-2PM	350-399	2"
L13-400-449-2PM	400-449	2"
L13-450-499-2PM	450-499	2"
L13-500-549-2PM	500-549	2"
L13-550-599-2PM	550-599	2"
L13-600-649-2PM	600-649	2"
L13-650-699-2PM	650-699	2"
L13-700-749-2PM	700-749	2"
L13-750-799-2PM	750-799	2"
L13-800-849-2PM	800-849	2"
L13-850-899-2PM	850-899	2"
L13-900-949-2PM	900-949	2"
L13-950-999-2PM	950-999	2"
L13-1000-1049-2PM	1000-1049	2"
L13-1050-1099-2PM	1050-1099	2"

GAS HEATING SERVICES

Gas Line Testers

Test any gas line, stove or any appliance that requires air test for gas leakage.

FEATURES:

- 3/4" NPT
- Easy to read gauge- 0-15 psi in 1/2 lb. increments

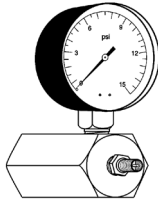

Part #		Description
N55-12M	★	0 - 15 PSI pressure
N55-18M	★	0 - 100 PSI pressure

Thermocouple Testers

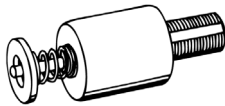

Isolates gas safety problems by power unit substitution.

Part #
N55-10M

Aluminum Pilot Tubing

FEATURES:

- Brass Compression Sleeve
- Brass Compression Nut
- Brass Compression Union



Part#	Size
G80M	1/4" OD x 5ft.

Manometer U-Gauge

Used to set pressure regulator when adjusting main burner manifold. Adjustable scale for zero setting. Complete with 3' rubber hose and adapter fittings.



INCLUDES:

- 3 ft. rubber hose
- Adapter fittings.

Part #	Description
N28-51M	★ Manometer complete. LP gas, 16" WC. Scale markings 8 - 0 - 8
N28-52M	Manometer replacement tubing, 3ft. L
N28-55M	Manometer replacement adapter fittings 5/16-32, 1/8" NPT, 1/4" NPT threads

Universal Blank Flange

Used to seal manifold while oven thermostat is removed for repair while allowing use of top burners.

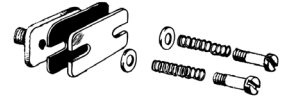

Part #
G1095M

HARDWARE

Oil Gauge Connectors



FEATURES:

- Quick hook up to hard-to-get at gauge ports.
- Plastic tubing with 400 psi burst pressure.

Part #	Size	Length
P127-8M	1/8" fpt x 1/4" fpt	20"
P127-10M	1/8" mpt x 1/4" fpt	12"

Kwik-Fit Gauge Adapter

One fitting accommodates suction ports and new or old style bleeder valves.



Part

P127-11M

Plastic Plugs

Prevents fluids flow and leaks from the base of HVAC units.

Part #	Thread Size	Installation	Pkg Qty.
W55-21M	3/4 - 1/4 NPT	Use 5/16" hex or straight screw driver for recessed slot	6

Coin and Key Air Valve



Part #	Size	Pkg Qty.
B159-1M	1/8"NPT	6

Radiator Vent Key

For bleeding air from radiators and baseboards.



Part #	Description	Pkg Qty.
B160M	Radiator vent key	10

EnviroFlo Plus Metal Gas Can



FEATURES:

- Advanced design spout, combined with child-resistant features and emission reducing technology.
- Environmentally safe fuel storage solution.
- The easy to use spout features convenient variable flow, automatic venting, and automatic locking when lever is released.
- Airtight seal when not in use to reduce spills.

Part#	Description
31710-6	5 Gallon Jerry can design with spout
81101	Enviro-Flo Spout

Gaskets for G.I. Cans

Made of high grade nitrile material for use with No. 2 fuel oil.

Part #	Pkg Qty.
580-16M	2

Oil Wicking

Recommended for use in bearing assemblies.

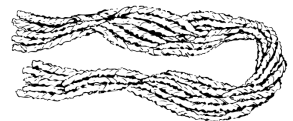

Part #	Pkg Qty.
B62-2M	6

Circulator Hardware

Nuts and bolts for use on circulators. Packaged in sets of four.



Part #	Description
B63-30M	Fits Taco, Harvey, most B&G, Modern
B63-32M	Circ Flange, Bolt B&G 100
B63-34M	Impeller Hsg, Bolt (4), B&G 100

HARDWARE

O Ring for Scully Delivery Nozzles

Part#	Description	Pkg Qty.
550-22M	Replacement O-ring for 04318 nozzle connector	4

Sid Harvey

Universal Humidifier Installation Kit

Kit Includes:

- 1/4" x 10 ft copper tubing
- Self-piercing saddle valve
- 1/4" brass compression union



Part#

L25-27M

Brass Poppet Check Valve

For use on oil lines for tight shutoff and to prevent reverse flow

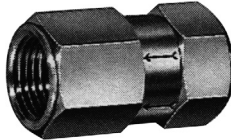

FEATURES:

- Compact design, 1-piece body.
- Operates in any position.
- UL listed.

Part #	Includes	Replaces	Max. Pressure
499M	3/8"	3/8" x 3/8" fnpt	1200 psig
499-1M	7/16"	1/2" x 1/2" fnpt	1200 psig

Self-Tapping Saddle Valve

Self-tapping, universal fit, combination clamp/valve assembly. Perfect for ice makers and humidifiers.

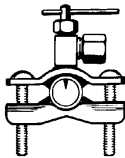

Part

L25-26M

Emergency Oil Lines

For temporary hook-up of suction lines.



FEATURES:

- Plastic tubing rated at 30° vacuum and 300 lb. pressure.
- Can be used over and over.

Part#	Length	Diameter	Fitting
P127-9M	100'	3/8" od	1/4" FPT
P127-9AM	50'	1/2" od	3/8" FPT

Jiffy Bleed Valves

Permits bleeding at the same speed as unit capacity.

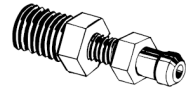

Part #	Size	Type
P131-6M	1/8"	Bleed Wrench
P131-7M	1/4"	Bleed Wrench

Jiffy Bleed Valves w/ Set Screw



Part #	Size	Type
P131M	1/8"	Allen Key
P131-1M	1/4"	Allen Key

Hose Caps and Washers

Use to cap boiler drains.

Part #	Description	Pkg Qty.
W55-19M	Brass hose caps	10
W55-20M	Neoprene washers	10



HARDWARE

Condensate Float Switches

Used in condensate drain pan to shut down equipment and prevent overflow.

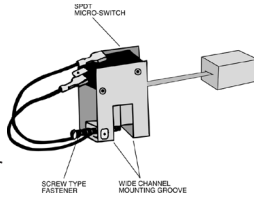

FEATURES:

- Low voltage
- Switches normally open or closed
- Positive hold down screw
- Easy installed

Part#	Description
K41M	Float switch with 12" wire
K41-5M	★ Float switch with 60" wire
K43M	★ Drain pan fitting

HARDWARE

Thermostat Guards

Available in a wide array of designs sizes and types to fit virtually any thermostat on the market.

FEATURES:

- Metal style guard for use in schools industrial plants or any setting where maximum protection against tampering is required.
- Opaque plastic guard recommended for additional visual security. Must be removed in order to read thermostat.
- Transparent plastic guard for use when visual security is not required and risk of tampering is lessened.

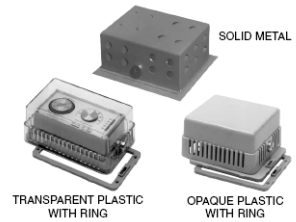

Part #	Cover	Shape	CoverType and Dimensions	Base
C131-38	Metal	Square	Ring 5-1/4 x 4-5/8 x 3-1/4	Ring
C131-40	Metal	Rectangular	Solid 6-3/8 x 3-1/2 x 3	Solid
C131-32	Metal	Rectangular	Solid 6-1/4 x 4-3/4 x 3	Solid
C131-26	Metal	Rectangular	Ring 6-3/8 x 3-1/2 x 3-1/4	Ring
C131-34	Opaque plastic	Square	Solid 3-7/8 x 3-1/2 x 2-1/2	Solid
C131-10	Opaque plastic	Rectangular	Ring 6 x 3-13/16 x 3-1/8	Ring
C131-30	Opaque plastic	Rectangular	Ring 6 x 3-13/16 x 3-1/8	Ring
C131-28	Opaque plastic	Rectangular	Ring 6-3/4 x 4-1/4 x 3-9/16	Ring
C131	Transparent plastic	Square	Solid 3-7/8 x 3-1/2 x 2-1/2	Solid
C131-4M	Transparent plastic	Square	Solid 5-1/4 x 4-5/8 x 3	Solid, ring
C131-8	Transparent plastic	Rectangular	Solid 6-3/8 x 3-1/2 x 3	Solid, ring
C131-12	Transparent plastic	Rectangular	Solid 7-1/4 x 5-3/8 x 3-1/2 2	Solid, ring

HARDWARE

Electrical Outlet Boxes

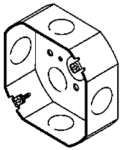

E326M

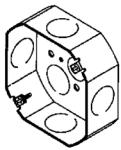

E326-1M

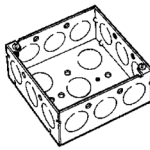

E325M

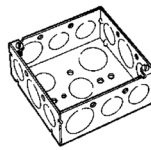

E325-3M

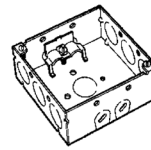

E325-12M

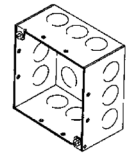

E325-15M

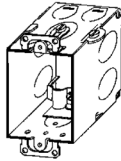

E329-8M

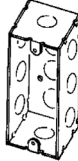

E328M

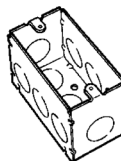

E328-5M

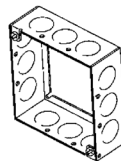

E325-25M

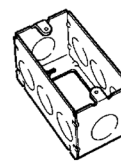

E328-10M

FEATURES:

- UL listed
- Conforms to applicable UBC codes

Octagonal/Welded 4"

Part #	Depth	Side Knockout	End Knockout	Bottom Knockout
E326	1-7/8"	One 1/2"	One 1/2"	Five 1/2"
E326-1	1-7/8"	One 3/4"	One 3/4"	Three 1/2" in a line, two 3/4" opposite ends

Square Welded 4"

E325	1-1/2"	Three 1/2"	Three 1/2"	Five 1/2"
E325-12	1-1/2"	Two loom	Three 3/4"	One 1/2"
E325-15	2-1/8"	Three 1/2"	Three 1/2"	Five 1/2"

Gangable Switch Box 3" x 2"

E329-8	2-1/2"	Two 1/2" nail holes	One 3/4"	Two 1/2"
--------	--------	---------------------	----------	----------

Utility Box 4" x 2-1/8" Welded

E328	1-7/8"	Three 1/2"	One 1/2"	Three 1/2", 4 nail holes
------	--------	------------	----------	--------------------------

Extension Rings - Square 4" Welded

E325-25	1-1/2"	Three 1/2"	Three 1/2"	Open
---------	--------	------------	------------	------

Extension Rings - Utility Box 4" x 2-1/8" Welded

E328-10	1-7/8"	Three 1/2"	One 1/2"	Open
---------	--------	------------	----------	------

HARDWARE

Solderless Terminal Mit-Paks

Choose from a wide variety of quality connectors

FEATURES:

- Color coded and fully insulated (where rated) for maximum safety for permanent and vibration resistant applications
- Packaged in convenient heavy plastic packs
- Also available in bulk

Part #	Wire Gauge	Insulated	Tab/Stud Size	Description	Pkg Qty.
T397M	A	22-16	Yes	#5, 6 Ring tongue	18
T397-2M	A	16-14	Yes	#5, 6 Ring tongue	18
T397-4M	A	22-16	Yes	#8 Ring tongue	18
T397-6M	A	16-14	Yes	#8 Ring tongue	18
T397-8M	A	22-16	Yes	#10 Ring tongue	18
T397-10M	A	16-14	Yes	#10 Ring tongue	18
T397-12M	A	12-10	Yes	#10 Ring tongue	14
T397-14M	A	22-16	Yes	1/4 Ring tongue	14
T397-16M	A	16-14	Yes	1/4 Ring tongue	12
T397-18M	A	12-10	Yes	1/4 Ring tongue	12
T397-47M	B	12-10	Yes	1/4 Female disconnect	18
T397-49M	B	18-14	Yes	1/4 Angle female disconnect	18
T397-52M	B	22-16	Yes	1/4 Female disconnect	18
T397-56M	B	16-14	Yes	1/4 Female disconnect	18
T397-58M	B	22-16	Yes	3/16 Female disconnect	18
T397-50M	C	22-16	Yes	1/4 Male disconnect	18
T397-54M	C	16-14	Yes	1/4 Male disconnect	18
T397-59M	D	---	No	1/4 Double male, single female	10
T397-61M	E	22-16	Yes	--- Splice connectors	10
T397-63M	E	16-14	Yes	--- Splice connectors	10
T397-65M	E	12-10	Yes	--- Splice connectors	8
T397-87M	G	22-16	Yes	#5, 6 Fork terminal	18
T397-88M	G	22-16	Yes	#8 Fork terminal	18
T397-89M	G	16-14	Yes	#10 Fork terminal	18

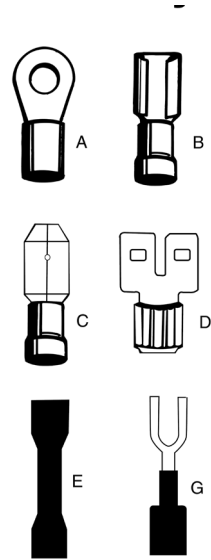

Solderless Terminal Kits

Durable, clear plastic, labeled container with 18 compartments of the most popular terminals and connectors (approx. 175 pieces).

FEATURES:

- T397-517M also contains a crimper designed for a broad range of insulated and non-insulated terminals and connectors
- Also cuts bolts and strips wire; made of tempered steel for long life and equipped with cushioned insulated handles.

Part #	Description
T397-515M	Terminal kit
T397-517M	Terminal kit with crimper



HARDWARE

Compressor Terminal Mit-Paks

Heavy 10 gauge terminals provide quick easy and firm connections. Corrosion and arc resistant. Tab width 1/4".

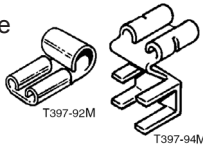

Part #	Description	Pkg Qty.
T397-92M	Flag female	18
T397-94M	Male	18

Wire Connector Mit-Paks

FEATURES:

- Accepts solid or stranded wire
- Connectors are color coded and flame retardant
- Spring inside connector makes twisting wire easier.



Part #	Color	AWG		Pkg Qty.
		Range	Min. Max.	
T397-321M	Gray	22-16	1 #20, 2 #16 1 #22	40
T397-322M	Blue	22-14	3 #22 3 #16	40
T397-323M	Orange	22-14	3 #22, 3 #16 1 #18	30
T397-324M	Yellow	18-12	1 #4, 2 #14, 1 #18 3 #16	20
T397-325M	Red	18-10	1 #12, 3 #10 2 #18	15

Compressor Lead Mit-Paks

Designed to make compressor installations quick and easy. Contains 10 gauge wire leads 12" long 1/4" female tab connector at one end and connector at other

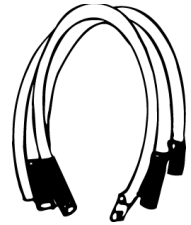

Part #	Pkg Qty.
T397-112M	3

3-Way Adapter Mit-Pak

Allows three connections with two male tab connectors and one female connector 1/4" tab width.

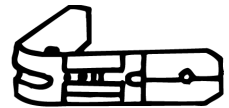

Part #	Pkg Qty.
T397-120M	12

HARDWARE

Machine Screw Mit-Paks

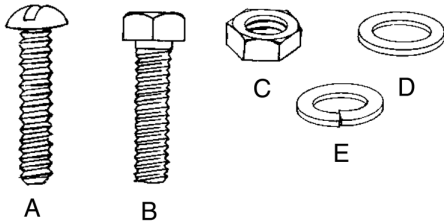

Nuts, bolts, screws and washers in convenient and economical packaging.

FEATURES:

- Heavy-duty, zinc-plated steel.

Part #	Size	Pkg Qty.
T397-235M	A 10-24 x 1"	30
T397-236M	A 10-24 x 2"	20
T397-241M	B 1/4-20 x 1"	20
T397-242M	B 1/4-20 x 2"	18

Hex Head Bolts Mit-Paks

T397-247M	B 5/16"-18 x 1"	18
T397-248M	B 3/8"-16 x 1-1/2"	8
T397-249M	B 3/8"-16 x 3/4" (for tankless coils)	12

Hex Nuts Mit-Paks

T397-251M	C 10 x 24	40
T397-252M	C 1/4" x 20	30
T397-253M	C 5/16" x 18	20
T397-254M	C 3/8" x 16	20

Flat Washers Mit-Paks

T397-256M	D #10	75
T397-257M	D 1/4"	50
T397-258M	D 5/16"	35
T397-259M	D 3/8"	30

Lock Washers Mit-Paks

T397-261M	E #10	50
T397-262M	E 1/4"	50
T397-263M	E 5/16"	35

Anchors/ Screws Combo Mit-Paks

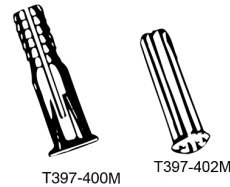

Durable nylon or vinyl construction for general use on hollow walls.

FEATURES:

- Combo-packs contain 15 each 3/16" wall anchors with #7 screws and 1/4" wall anchors with #10 screws.

Part #	Type	Pkg Qty.
T397-400M	Nylon	15 each
T397-402M	Vinyl	15 each

Drill Screw Mit-Paks

Hex head, self-tapping. For use on sheet metal, duct work, furnaces and other general repairs.



FEATURES:

- Hardened points with washer head for firm hold
- Hex head with screwdriver slot for tightening or use with 1/4" nut driver
- Chrome-zinc finish

Part #	Size	Pkg Qty.
T397-200M	6 x 3/8"	40
T397-202M	6 x 1/2"	40
T397-204M	8 x 1/2"	40
T397-205M	8 x 3/4"	35
T397-206M	8 x 1"	35
T397-207M	8 x 1-1/2"	20
T397-208M	8 x 2"	20
T397-210M	10 x 1/2"	30
T397-211M	10 x 3/4"	30
T397-212M	10 x 1"	18
T397-214M	10 x 2"	18

HARDWARE

Cable Tie Mit-Paks

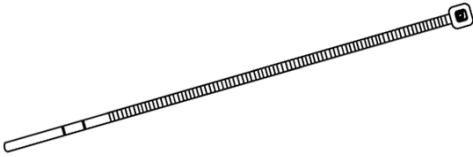

Strong nylon construction heavy duty weather resistant and self locking.

Natural

Part #	Length	Pkg Qty.
T397-300M	4"	20
T397-301M	6"	15
T397-302M	11"	10
T397-303M	4"	100
T397-304M	6"	100
T397-305M	11"	100
T397-306M	14"	10
T397-307M	14"	100
T397-303BM	4"	1,000
T397-304BM	6"	1,000
T397-305BM	11"	1,000
T397-307BM	14"	500

Black

T397-316M	6"	100
T397-318M	11"	100

Cable Tie Mounting Pad

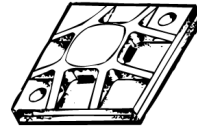

Used for screwing low voltage wiring to walls and ductwork

FEATURES:

- 4 way opening accepts cable ties to 3.6mm wide
- Self sticking adhesive
- #8 screw opening for more secure fastening

Part #	Base Size	Pkg Qty.
T397-352M	3/4" x 3/4"	12

Relay Mounting Kit

Use to mount a cad cell or panel relay to any lolly column or motor.

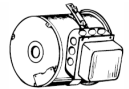

Part#

A205-8M

Cable Tie Tension Tool

FEATURES:

- Lightweight, yet durable.
- Ratchet handle to desired tension and cut excess strap.
- Works with all ties including thin designs.
- Comfortable, curved handles reduce pressure pinch point area.



Part#

T397-350M

HYDRONICS

Remanufactured Taco 007 Cartridge Circulator

Cartridge style, maintenance free, wet rotor, single stage circulator pump. Designed for quiet operation in hydronic heating, radiant heating, hydro-air fan coils, indirect water heating, chilled fresh water and domestic water situations.



FEATURES:

- Field serviceable cartridge contains all moving parts.
- With no mechanical seal, the self-lubricating, maintenance-free design provides quiet, efficient operation and reliability.
- Direct drive, low power consumption.
- Universal flange-to-flange dimension.

Fluid Temperature

Part#	Taco Model#	Flow HP Range	Head Range	Fluid Temperature		Connection	Electrical	Motor	Min. Inlet Pressure Req.
				Min.	Max.				
Q53-16	007-F5	1/25 0 – 20 gpm	0 – 11 ft.	40°F	240°F	3/4", 1", 1-1/4", 1-1/2" flanged	115 volt, 60 Hz, 1 phase, 70 apms, 3250 RPM	Permanent split capacitor, impedance protected	14 PSI

RIELLO REPLACEMENT PARTS

Riello Burner Motor

FEATURES:

- Remanufactured to OEM specifications
- 115 Volts
- 3250 RPM
- PSC (Permanent Split Capacitor)
- Ball Bearings



Part #	Riello Part#	Used On	RPM	Volts	Phase
Q180-1	3005843	F3, F5, F10, M3, M5, M10	3250	120	1

Riello Primary Control

FEATURES:

- Remanufactured to OEM specifications
- Full intergrated solid state control primary control, ignitor and CAD Cell in one unit
- Pre-purge control



Part #	Riello Part#	Use on	Volts	Burner Circuit
Q78-10	530 SE	All R40 and Mectron sereis models	120	120

Riello Pump

FEATURES:

- Remanufactured to OEM specifications
- 3250 RPM
- Factory set to 150 PSI
- Rated up to 2 GPH
- Solinoid control pump



Part #	Description	Used on	RPM
Q4-150	Built-in cylinder port, single with CW-R	F3, F5, F10, F15, M3, M5, M10, M15	3250

HYDRONICS

Remanufactured Bell & Gossett Circulators

FEATURES:

- Motor: sleeve bearing, oil lubricated with replaceable motor mounts. Two-piece bracket for easy servicing.
- Noise dampening coupler with flexible spring design for quiet operation.
- Long bronze sleeve bearing maintains exact shaft alignment. Provides constant circulation of oil over bearing surfaces.
- Precision ground pump shaft is oversized to provide large bearing surfaces. Hardened integral thrust collar minimizes end-thrust to ensure long seal and bearing life.
- Mechanical seal is designed to withstand a wide range of water temperatures, pressures, additives and dissolved solids common in hydronic systems.
- Mitco enhances the performance of Series 100 Pumps through use of Sintered Bronze Bearings.
- Centrifugal prevents accumulation of air at seal faces to assure long life. Close impeller/body tolerances minimize water slippage and maximize efficiency.



Part#	Fits Series 100 Models	B&G	Max Working Pressure	Max Operating Temperature	Body Composition	Flange Size NPT	Motor Characteristics @ 60 Hz
Q51	100 NFI	106189	125 PSI	225°F	Cast Iron	3/4", 1", 1-1/4", 1-1/2"	1/12 HP, 1 phase, 115 volt
Q51-1	100 BNF	106197	125 PSI	225°F	Bronze	3/4", 1", 1-1/4", 1-1/2"	1/12 HP, 1 phase, 115 volt

MOTORS

Remanufactured Bell & Gossett Circulators Motors



Part#	B&G#	Pump#	HP	RPM	Voltage	Phase	Notes
Q28-15	111034	Series 100	1/12 HP	1725 RPM	115 volt	1	With cradle
Q28-20	111031	1", 1-1/4", 1-1/2" prior HV prior to 8/75	1/6 HP	1725 RPM	115 volt	1	With run capacitor
Q28-21	111061	2 NFI, 2BNFI 5" dia, HV BNFI	1/6 HP	1725 RPM	115 volt	1	With cradle
Q28-23	111040	2-1/2, LD3	1/4 HP	1725 RPM	115 volt	1	With cradle
Q28-24	M10293	HV	1/6 Hp	1725 RPM	115 volt	1	With run capacitor
Q28-25	111042	HD 3	1/3 HP	1725 RPM	115 volt	1	With run/start capacitor
Q28-26	169035	60 1 AA, 60 1-1/4"	1/4 HP	1725 RPM	115 volt	1	With cradle less capacitor
Q28-28	111046	PD-35, 60 1-1/2 AA, 60 1-1/2 A	1/2 HP	1725 RPM	208-230/460 volt 208-220/440 volt	3	
Q28-29	169038	60 1/4 AA	1/3 HP	1725 RPM	115/230 volt	1	
Q28-30	111047	PD 37, 60 2 AA, 60 1-1/2 A, 60 2A	3/4 HP	1725 RPM	115/230 volt	1	
Q28-32	111049	PD 37, 60 2 AA, 60 1/2 A, 60 2 A	3/4 HP	1725 RPM	208-230/ 460 volt 208220/440 volt, CCW	3	
Q28-34	111050	PD 38, PD 39, 60 1-1/2 A, 60 2 A	1 HP	1725 RPM	115/230 volt, CCW	1	
Q28-123	111040	Power pack 1/91 to current	1/4 HP	1725 RPM	115 volt	1	With cradle less capacitor
Q28-126	169035	Series 60 power pack 1/91 to current	1/4 HP	1725 RPM	115 volt	1	With cradle less capacitor

Remanufactured Standard PSC Burner Motor

FEATURES:

- Semi-enclosed
- Quiet sealed ball bearings
- Auto rest thermal overload



Part#	Functional Re- placement For:	Description	Voltage	RPM	Phase
Q39-311M	Beckett 21805U Carlin 98022S GE 5KH39CN21Y/ B17M1 Emerson 3083 Carrier HC37UY115 Marathon 0100 Steveco 84783 SH Heat Chief A39- 311R	Semi-enclosed, ball bearing and CW rotation	1/7 HP	115 Volt	3450 RPM

HYDRONICS

Remanufactured Econo



Part#	For use with	HP	Voltage	RPM	Phase	Notes
Q28-52	Econo Circulator	1/8 HP	115 volt	1725 RPM	1	With cradle

Remanufactured TACO



Circulator Motor

Part#	Taco#	Pump#	HP	Voltage	RPM	Phase	Notes
Q28-60	110-223RP	Older 110 horizontal circulators	1/8 HP	115 volt	1725 RPM	1	With cradle
Q28-64	110-223RP	HC, 110, 117 horizontal circulators	1/12 HP	115 volt	1725 RPM	1	
Q28-66	121-151RP	Series 121 in-line cartridge circulators	1/4 HP	115 volt	1725 RPM	1	
Q28-68	---	Older motors vertical circulators call with specifications	1/6 HP	115 volt	1725 RPM	1	
Q28-69	131-143RP	Series 131 in-line cartridge circulators	1/3 HP	115 volt	1725 RPM	1	

HYDRONICS

Remanufactured Bell & Gossett Bearing Assemblies

Part#	B&G#	Pump#	Manufactured Data	Notes
Q70	ORIGINAL 189100 Replaced by 189162	1" IB 1" BI 1-1/4" IB 1-1/4" BI 1-1/2" IB 1-1/2" BI 1-1/2" AI 2-1/2" IB HLD3	Prior to 1950 Prior to 1950 Prior to 1950 Prior to 1950 1/76 1/76 1/76 Prior to 1950 Prior to 1950	Cast iron Less Impeller With High Temp Seal
Q70-1	ORIGINAL 189101 Replaced by 189162	2" IB HV BI HLD 3 AB	Prior to 6/76 Prior to 8/75 Prior to 1950	Cast iron Less Impeller
Q70-2	ORIGINAL 189103 Replaced by 189163	1-1/2" AB 2" AB HV AB	Prior to 8/75 Prior to 3/76 Prior to 9/75	Bronze Less Impeller
Q70-3	ORIGINAL 189100 Replaced by 189162	1" IB 1" BI 1-1/4" IB 1-1/4" BI 1-1/2" IB 1-1/2" BI 1-1/2" AI 2-1/2" IB HLD3	Prior to 1950 Prior to 1950 Prior to 1950 Prior to 1950 1/76 1/76 1/76 Prior to 1950 Prior to 1950	Cast iron Less Impeller Q70 With Hi-Temp seal
Q71	ORIGINAL 189104 Replaced by 189162	2-1/2" AB	Prior to 1950	Bronze Less Impeller
Q73	ORIGINAL 189105	PR IB PB BI 2-1/2" IB 2-1/2" BI LD 3 IB LD 3 BI HD 3 IB HD 3BI	Current Current Current Current Current Current Current Current Current	Cast iron Less Impeller
Q73-1	ORIGINAL 189106 Replaced by 189106	PR AB 2-1/2" AB LD 3 AB HD 3 AB	Current Current Current Current	Bronze Less Impeller
Q73-2	ORIGINAL 189105	PR IB PB BI 2-1/2" IB 2-1/2" BI LD 3 IB LD 3 BI HD 3 IB HD 3BI	Current Current Current Current Current Current Current Current Current	Cast iron Less Impeller With Hi-Temp seal
Q73-3	ORIGINAL 189106, 189120 Replaced by 189106	PR AB 2-1/2" AB LD 3 AB HD 3 AB	Current Current Current Current	Bronze Less Impeller With Hi-Temp

HYDRONICS

Remanufactured Bearing Assemblies *CONTINUED*

Part#	B&G#	Pump#	Manufactured Data	Notes
Q74-1	ORIGINAL 189134, 118844	Series 100 IB Series 100 NFI	Current Current	Cast iron With Impeller
Q74-2	118844	Series 100 IB Series 100 NFI Series 100 BI	Current Current Current	Cast iron High Temp Seal
Q75	189034	Series 100 AB Series 100 BNFI	Current Current	Cast iron Less Impeller
Q75-1	189034	Series 100 AB Series 100 BNFI	Current Current	Cast iron Less Impeller With Hi-Temp seal
Q75-2	ORIGINAL 189106, 189120 Replaced by 189165	1-1/2" IB 1-1/2" BI 2" NFI HV NFI	2/76 - 9/76 2/76 - 9/76 Current Current	Cast iron Less Impeller
Q75-3	ORIGINAL 189122 Replaced by 189165	2" BNFI HV BNFI	Current Current	Bronze Fitted With plastic Impeller
Q75-4	ORIGINAL 189120 Replaced by 189165	2" BNFI HV BNFI	Current Current	Q75-2 with Impeller
Q75-5	ORIGINAL 189106 Replaced by 189165	1-1/2" IB 1-1/2" BI 2" NFI HV NFI	2/76 - 9/76 2/76 - 9/76 Current Current	Cast iron Less Impeller
Q76	186863	PD 35 BF PD 37 BF 60 1 AA BF 60 1-1/4AA BF 60 1-1/2AA BF 60 2 AA BF 1522 1 AAB BF 1522 1-1/4AAB BF 1522 1-1/2AAB BF	Current Current Current Current Current Current Current Current Current	Cast iron Less Impeller
Q76-1	186863	PD 35 BF PD 37 BF 60 1 AA BF 60 1-1/4AA BF 60 1-1/2AA BF 60 2 AA BF 1522 1 AAB BF 1522 1-1/4AAB BF 1522 1-1/2AAB BF	Current Current Current Current Current Current Current Current Current	Bronze Less Impeller
Q76-2	186863	PD 35 BF PD 37 BF 60 1 AA BF 60 1-1/4AA BF 60 1-1/2AA BF 60 2 AA BF 1522 1 AAB BF 1522 1-1/4AAB BF 1522 1-1/2AAB BF	Current Current Current Current Current Current Current Current Current	Cast iron Less Impeller With Hi-Temp seal
Q76-5	----	----	----	Cast iron With Impeller 6" diameter impeller ring

HYDRONICS

Remanufactured Bearing Assemblies CONTINUED

Part#	B&G#	Pump#	Manufactured Data	Notes
Q76-10	----	----	----	Cast iron With Impeller 7" diameter impeller ring
Q76-25	185260	PD 38 BF PD 39 BG PD 40 BF 60-1-1/2A BF 60 2A BF	Current Current Current Current Current	Cast iron Less Impeller

Remanufactured Bearing Assemblies Universal Replacement Models BELL & GOSSETT

Part#	B&G#	Pump#	Manufactured Data	Notes
Q76-30	----	----	----	With support bracket Grease cap lube
Q76-31	----	----	----	Without support bracket Grease cap lube
Q76-32	----	----	----	With support bracket Oil cap lube
Q76-33	----	----	----	Without support bracket Oil cap lube

NOTE: If a unit is not shown. It can be priced upon inspection.

HYDRONICS

Remanufactured Bearing Assemblies TACO

Part#	Taco#	Impeller Diameter	Size
Q83	110-361 RP	2-1/2"	3/4" to 1-1/2"
Q83-1	HC, 100 bronze	2-1/2"	3/4" to 1-1/2"

Cast Iron Brackets with Cartridge Less Impeller for 1600 Series Pumps TACO

Reman#	Casting#
Q89-1	1600-175RP
Q89-2	1604-023RP
Q89-3	1604-025RP

Replacement Brackets for Remanufactured Bearing Assemblies TACO

Reman#	Casting#
Q89	1600-155RP

Remanufactured Bearing Cartridge Assemblies TACO

Used with all mod kits and pump series 121 thru 138 and all 1600 series ending with -9.

Reman#	Casting#
Q67-60	1600-160RP

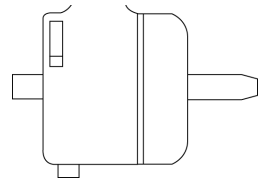

Immersion Wells

FEATURES:

- 3/8" bulb diameter
- 3" insulation

Part#	Pipe Conn.	Insertion Dia.	Insulation Lth.	Depth	Competitive Cross Ref.	Use on
C347-2M	1/2"	3/8"	3"	1-1/2"	Honeywell 121371A, 12389A, W/R F-89-0211	Honeywell L4006, L6006, L8124, L81848, R8182D, R8182E, R8182F
C347-3M	3/4"	3/8"	3"	1-1/2"	Honeywell 121371B, 123870A, W/R F-89-02213	Same as above
C347-6M	3/4"	3/8"	3"	4-1/2"	Honeywell 122555A	Long insertion for water heaters
C347-7M	3/4"	3/8" or 5/8"	3"	4-1/2"	Honeywell 122555E	3/8" to 5/8" insertion dia.
C347-8M	3/4"	3/8"	3"	3"	Honeywell 122555E	Long insertion for water heaters



NOTE: Remanufactured products are available only on exchange for similar defective units

HYDRONICS ACCESSORIES

Spring Circulator Couplings

For B&G circulators.

FEATURES:

- All cast iron with heavy duty springs and hardened carbon steel links.
- 1/2" x 1/2" shaft diameter.



Part#	Mfr#
156M	118705
156-1M	118723
156-2M	118473

Spiral Circulator Couplings

For B&G and Armstrong circulators.

FEATURES:

- Easier to install.
- Quieter running.
- Longer life – no wear surfaces.
- Better alignment.
- Less pump and motor wear – less rigidity puts less load on bearings, seals.



Part#	Replaces
156AM	118705 Series 100 circulator, fits 1/12 HP, 1/6 HP circulators
156-2AM	118473 (PDZ-12291), PD35, PD37, fits 1/2 HP, 3/4 HP circulators

Circulator Couplings

FOR TACO

For Taco and Thrush horizontal circulators.

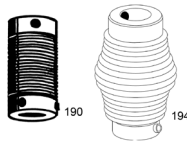

Part#	Diameter	Length
190M	1/2" x 3/8"	2"
194M	1/2" x 7/16"	1-3/4"

Circulator Couplings and Motor Mount Kits

Convenient bagged combinations of replacement couplings and motor mounts for B&G motors. Broken couplings are usually the result of sagging motor mounts and both the coupling and mount should be replaced at the same time.



Part#	Use on
155-10M	1/12 HP B&G circulator
155-15M	1/6 HP B&G circulator

Motor Mounts

For B&G circulators.

FEATURES:

- Oil-resistant, neoprene material.
- With copper grounding wire.



Part#	Use on	Pkg Qty.
B61M	118227, 1/6 HP, 1/4 HP circulators	2
B61-1M	118223, 1/12 HP circulaotrs	2

HYDRONICS ACCESSORIES

Impellers

For B&G Model 100 circulators.

FEATURES:

- Glass-filled, nylon impeller.



Part#	Mfr#	Material	Diameter
B60AM	189132		
B60-10	118626	Bronze	5-1/4"
B60-11	189128	Noryl	3-3/8"
B60-2	118434	Bronze	1.25
B60-3		Bronze	3.29
B60-4			2.5
B60-5	118438		3
B60-6	118436	Bronze	3-3/8"
B60-8	118439	Brass	4-1/4"
B60-9	118627	Brass	4-3/4"

Wise Crack Impeller Remover

Quickly removes stubborn B&G impellers without damaging the impeller or shaft.

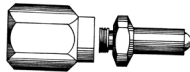

Part#

B60-30M ★

Turn-A-Flange Tool

Makes flange installation on threaded pipe quick and easy.

FEATURES:

- Turn-A-Flange fits most circulator flanges.
- Place tool on flange.
- Use socket or adjustable wrench to turn and install flange.

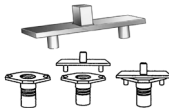

Part#

B60-40M ★

Seal Assemblies

For B&G circulators.



Part#	Mfr#	Use on
B66M	118680	(PZ-3118), PD-37, 1522, 1535, all residential circulators
B66-4M	118681	All bronze residential circulators
B66-8M	118682	1531, 1510, universal A, B, Series 80, 1510, 1531
B66-12M	186499	(PD-39), Series 60A

Oil Wicking

Recommended for use in bearing assemblies.



Part#	Description	Pkg Qty.
B62-2M	Oil wicking	6

Circulator Hardware

Nuts and bolts for use on circulators.



Part#	Description	Pkg Qty.
B63-30M	Flange nuts and bolts for Taco, Harvey, Modern and most B&G circulators	4
B63-32M	Fits B&G 100 Series	4
B63-34M	Fits B&G 100 Series Circulator Flange	4

Circulator Body Gaskets

For use on B&G circulators.

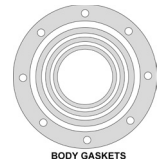

Part#	Fits	Inside Dia.	Pkg Qty.
B65-15M	189100, 189104	3-1/2"	10
B65-17M	189105, 118447	4-1/4"	5
B65-18M	118844, 189034	2-13/16"	10
B65-19M	185863, 186864	5-3/8"	5

HYDRONICS ACCESSORIES

Circulator Flange Gaskets

Part#	Use on	Type	Pkg Qty.	Color
B64M	Universal	Flange	20	Red
B65-1M	B&G 100 series	Flange	2	Red
B65-7M	Taco 007 series	Flange	2	Black
B65-8M	Grundfos UP Series	Flange	6	Black
T36BRM	Universal	Flange	20	Black

Boiler Gauges (Tridicators)

Replacement gauges for today's most popular boilers.

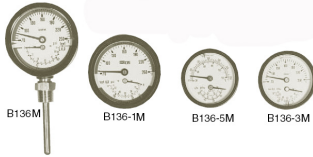

Part#	Case Diameter	Mount	Shank
B136M	3-1/4" dia., 1/2" NPT	Bottom connection	3" L
B136-1M	3-1/4" dia., 1/2" NPT	Center back connection	3" L
B136-3M	2-1/2" dia., 1/4" NPT	Center back connection	1-3/4" L
B136-5M	2-1/2" dia., 1/4" NPT	Center back connection	3" L

Hose Caps and Washers

Use to cap boiler drains.



Part#	Description	Pkg Qty.
W55-19M	Brass hose cap and washer	10
W55-20M	Neoprene washers	10

Circulator Gasket Kit

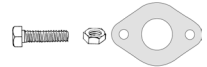

Part#	Description	Color
B64-2BRM	Circulator Gasket Kite includes: o 2 Universal flange gaskets o 4 Hex head bolts 7/16 - 14 x 1-3/4" o 4 hex nuts 7/16 - 14	Black
B64-2M	Circulator Gasket Kite includes: o 2 Universal flange gaskets o 4 Hex head bolts 7/16 - 14 x 1-3/4" o 4 hex nuts 7/16 - 14	Red

McDonnell & Miller Water Feeder and Low Water Cut-off Replacement Parts



Part#	Description	Competitive Cross Reference	Use With
B122-10M	Blow down valve kit, 3/4" NPT, with gasket, bolt, flange, and nipple	310477	Series 67 and 767 float type LWCOs
B123-7M	Blow down valve dirt pocket cap, 3/4" NPT	313200	Series 67 and 767 float type LWCOs and Series 47 and 47-2 combination mechanical water feeder/LWCOs

HYDRONICS ACCESSORIES

McDonnell & Miller Water Feeder and Low Water Cut-off Gaskets

Part#	Gasket Type	Competitive Cross Reference	McD&M Models used on
B122-5M	Float assembly gasket	Part# 318800 Model# 67-12	Series 61 float type LWCO Series 64 / 764 float type LWCO Series 67 / 767 float LWCO Series 69 float type LWCO Series 70 float type LWCO
B123M	Body gasket	Part# 312700 Model# 37-16	Series 47 / 47-2 combination mechanical water feeder / LWCO
B123-3M	Blow down valve gasket	Part# 313200 Model# 37-39	Series 47 / 47-2 combination mechanical water feeder / LWCO Series 53 / 53-2 combination mechanical water feeder / LWCO Series 67 / 767 float type LWCO Series 70 float type LWCO
B126-5M	Head gasket	Part# 304100 Model# F-26	Series 221 make-up water feeder Series 551-S make-up water feeder Series 25-A make-up water feeder Series 3155 make-up water feeder Series 51 / 51-2 combination mechanical water feeder / LWCO Series 53 / 53-2 combination mechanical water feeder / LWCO
B127-4M	Head gasket	Part# 325400 Model# 150-14	Series 93 and 193 LWCO / pump controller Series 150 and 157 float type LWCO Series 150S and 157S LWCO / pump controller

HYDRONICS ACCESSORIES

Universal Well Adapter

Permits replacement of obsolete hot water controls without draining the boiler system. Adapts modern controls to old style well with inside diameters of 1/2", 3/4" or 11/16".



Part#

C308M

Air Vent

Quick-acting air vent with self-sealing mounting valve.



Part#

Mounting

Max.

Pressure

B157-7M

1/8" or 1/4" NPT

Up to 175 PSI max.

Gauge Glass and Valve Set

Allows for visual inspection of liquid levels in various vessels. Required by ASME Boiler and Pressure Code on all steam boilers. Useful in other applications such as monitoring the amount of oil in a tank.

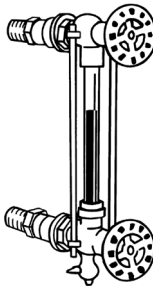

Part#

Pipe Size

OD

Length

B133M

1/2"

5/8"

12"

Gauge Glass Washers

Fits 5/8" gauge glasses.



Part#

Material

Pkg Qty.

B132M

Lathe cut EPDM gasket

100

B132-1M

Lathe cut EPDM gasket

12

B132-2M

High pressure molded rubber gasket

12

B133-2M

Brass washer

1

Gauge Glasses

Our glass is widely used in low pressure steam boiler applications. Optional Accessories: Mitco Glass Cutter #B134-4M



REGULAR GAUGE GLASS

Part#	OD	Length	Pkg Qty.
B131M	5/8"	8"	6
B131-1M	5/8"	10"	6
B131-2M	5/8"	12"	6
B131-3M	5/8"	14"	6

HIGH PRESSURE GAUGE GLASS

B131-11M	5/8"	10"	6
B131-12M	5/8"	12"	6
B131-13M	5/8"	14"	6
B131-36M	5/8"	36"	1

HYDRONICS ACCESSORIES

Isolator Uni-Flange Ball Valves

FEATURES:

- The brass body and flange provide strength and versatility for any application where a pipe and flange meet.
- The valve features a solid, hard chrome plated, brass ball with reinforced Teflon® seats and a blowout-proof Teflon® sealed stem with an adjustable packing gland.
- Solid brass flange, when sealed with a rubber gasket, eliminates the problem of galvanic corrosion common when an iron flange is connected to copper tubing as in conventional installations.
- Vinyl-coated, stamped steel handle.



- PRESSURE RATING:** 600 WOG non-shock
150 WSP
- END COMPLIANCE:**
• Threaded ANSI B2.1.20.1
• Solder ANSI B16.18

Part#	Nominal Size
40403	3/4" threaded
40404	1" threaded
40405	1-1/4" threaded
50403	3/4" sweat
50404	1" sweat
50405	1-1/4" sweat
50413	3/4" sweat
50414	1" sweat

Boiler Drain Valves

FEATURES:

- Heavy brass construction
- Max. temp. rating: 180 °F
- Pressure rating: 200 WOG (non-shock)
- Free flow with a min. pressure drop



Part#	Mfr	Mounting Connections
470	1/2"	Male
470-1	3/4"	Male

Ball Valves

2-piece, full port.

FEATURES:

- Minimal pressure drop due to large, full port sizing.
- Pressure rated at 600 psi and 50 psi saturated steam.
- Fast 1/4 turn to open or close.
- Excellent for throttling applications.
- AGA and CGA approved.

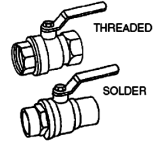

THREADED

Part#	Size
488-9	3/8"
488-10	1/2"
488-11	3/4"
488-12	1"
488-13	1-1/4"
488-14	1-1/2"

SOLDER

488-15	3/8"
488-16	1/2"
488-17	3/4"
488-18	1"
488-19	1-1/4"

SPIRAL BAFFLES

Spiral Boiler Baffles

FEATURES:

- Special spiral design diverts flue gases, reducing heat loss up the stack and greatly improving overall boiler efficiency.
- Special residential and commercial sizes made to order, from 1-1/4" to 4" wide and from 17" to 96" in length.

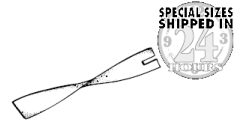

Part#	Length	Width
634-1.25X17M	17"	1-1/4"
634-1.375X17M	17"	1-3/8"
634-1.50X17M	17"	1-1/2"
634-1.625X17M	17"	1-5/8"
634-1.75X17M	17"	1-3/4"
634-2.00X17M	17"	2"
634-2.25X17M	17"	2-1/4"
634-2.50X17M	17"	2-1/2"
634-2.75X17M	17"	2-3/4"
634-3.00X17M	17"	3"
634-4.00X17M	17"	4"
634-1.25X18M	18"	1-1/4"
634-1.375X18M	18"	1-3/8"
634-1.50X18M	18"	1-1/2"
634-1.625X18M	18"	1-5/8"
634-1.75X18M	18"	1-3/4"
634-2.00X18M	18"	2"
634-2.25X18M	18"	2-1/4"
634-2.50X18M	18"	2-1/2"
634-2.75X18M	18"	2-3/4"
634-3.00X18M	18"	3"
634-4.00X18M	18"	4"
634-1.25X24M	24"	1-1/4"
634-1.375X24M	24"	1-3/8"
634-1.50X24M	24"	1-1/2"
634-1.625X24M	24"	1-5/8"
634-1.75X24M	24"	1-3/4"
634-2.00X24M	24"	2"
634-2.25X24M	24"	2-1/4"
634-2.50X24M	24"	2-1/2"
634-2.75X24M	24"	2-3/4"
634-3.00X24M	24"	3"
634-4.00X24M	24"	4"
634-1.25X30M	30"	1-1/4"
634-1.375X30M	30"	1-3/8"
634-1.50X30M	30"	1-1/2"
634-1.625X30M	30"	1-5/8"
634-1.75X30M	30"	1-3/4"
634-2.00X30M	30"	2"
634-2.25X30M	30"	2-1/4"
634-2.50X30M	30"	2-1/2"
634-2.75X30M	30"	2-3/4"
634-3.00X30M	30"	3"
634-4.00X30M	30"	4"
634-1.25X36M	36"	1-1/4"
634-1.375X36M	36"	1-3/8"
634-1.50X36M	36"	1-1/2"
634-1.625X36M	36"	1-5/8"

Part#	Length	Width
634-1.75X36M	36"	1-3/4"
634-2.00X36M	36"	2"
634-2.25X36M	36"	2-1/4"
634-2.50X36M	36"	2-1/2"
634-2.75X36M	36"	2-3/4"
634-3.00X36M	36"	3"
634-4.00X36M	36"	4"
634-1.25X42M	42"	1-1/4"
634-1.375X42M	42"	1-3/8"
634-1.50X42M	42"	1-1/2"
634-1.625X42M	42"	1-5/8"
634-1.75X42M	42"	1-3/4"
634-2.00X42M	42"	2"
634-2.25X42M	42"	2-1/4"
634-2.50X42M	42"	2-1/2"
634-2.75X42M	42"	2-3/4"
634-3.00X42M	42"	3"
634-4.00X42M	42"	4"
634-1.25X48M	48"	1-1/4"
634-1.375X48M	48"	1-3/8"
634-1.50X48M	48"	1-1/2"
634-1.625X48M	48"	1-5/8"
634-1.75X48M	48"	1-3/4"
634-2.00X48M	48"	2"
634-2.25X48M	48"	2-1/4"
634-2.50X48M	48"	2-1/2"
634-2.75X48M	48"	2-3/4"
634-3.00X48M	48"	3"
634-4.00X48M	48"	4"
634-1.25X54M	54"	1-1/4"
634-1.375X54M	54"	1-3/8"
634-1.50X54M	54"	1-1/2"
634-1.625X54M	54"	1-5/8"
634-1.75X54M	54"	1-3/4"
634-2.00X54M	54"	2"
634-2.25X54M	54"	2-1/4"
634-2.50X54M	54"	2-1/2"
634-2.75X54M	54"	2-3/4"
634-3.00X54M	54"	3"
634-4.00X54M	54"	4"
634-1.25X60M	60"	1-1/4"
634-1.375X60M	60"	1-3/8"
634-1.50X60M	60"	1-1/2"
634-1.625X60M	60"	1-5/8"
634-1.75X60M	60"	1-3/4"
634-2.00X60M	60"	2"
634-2.25X60M	60"	2-1/4"
634-2.50X60M	60"	2-1/2"

SPIRAL BAFFLES

Spiral Boiler Baffles

Part#	Length	Width
634-2.75X60M	60"	2-3/4"

Part#	Length	Width
634-3.00X60M	60"	3"

Spiral Boiler Baffles

FEATURES:

- Special spiral design diverts flue gases, reducing heat loss up the stack and greatly improving overall boiler efficiency.
- Special residential and commercial sizes made to order, from 1-1/4" to 4" wide and from 17" to 96" in length.

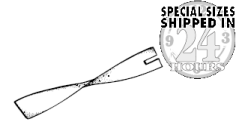

Part#	Length	Width
634-4.00X60M	60"	4"
634-1.25X66M	66"	1-1/4"
634-1.375X66M	66"	1-3/8"
634-1.50X66M	66"	1-1/2"
634-1.625X66M	66"	1-5/8"
634-1.75X66M	66"	1-3/4"
634-2.00X66M	66"	2"
634-2.25X66M	66"	2-1/4"
634-2.50X66M	66"	2-1/2"
634-2.75X66M	66"	2-3/4"
634-3.00X66M	66"	3"
634-4.00X66M	66"	4"
634-1.25X72M	72"	1-1/4"
634-1.375X72M	72"	1-3/8"
634-1.50X72M	72"	1-1/2"
634-1.625X72M	72"	1-5/8"
634-1.75X72M	72"	1-3/4"
634-2.00X72M	72"	2"
634-2.25X72M	72"	2-1/4"
634-2.50X72M	72"	2-1/2"
634-2.75X72M	72"	2-3/4"
634-3.00X72M	72"	3"
634-4.00X72M	72"	4"
634-1.25X78M	78"	1-1/4"
634-1.375X78M	78"	1-3/8"
634-1.50X78M	78"	1-1/2"
634-1.625X78M	78"	1-5/8"
634-1.75X78M	78"	1-3/4"
634-2.00X78M	78"	2"
634-2.25X78M	78"	2-1/4"
634-2.50X78M	78"	2-1/2"
634-2.75X78M	78"	2-3/4"
634-3.00X78M	78"	3"
634-4.00X78M	78"	4"

Part#	Length	Width
634-1.25X84M	84"	1-1/4"
634-1.375X84M	84"	1-3/8"
634-1.50X84M	84"	1-1/2"
634-1.625X84M	84"	1-5/8"
634-1.75X84M	84"	1-3/4"
634-2.00X84M	84"	2"
634-2.25X84M	84"	2-1/4"
634-2.50X84M	84"	2-1/2"
634-2.75X84M	84"	2-3/4"
634-3.00X84M	84"	3"
634-4.00X84M	84"	4"
634-1.25X90M	90"	1-1/4"
634-1.375X90M	90"	1-3/8"
634-1.50X90M	90"	1-1/2"
634-1.625X90M	90"	1-5/8"
634-1.75X90M	90"	1-3/4"
634-2.00X90M	90"	2"
634-2.25X90M	90"	2-1/4"
634-2.50X90M	90"	2-1/2"
634-2.75X90M	90"	2-3/4"
634-3.00X90M	90"	3"
634-4.00X90M	90"	4"
634-1.25X96M	96"	1-1/4"
634-1.375X96M	96"	1-3/8"
634-1.50X96M	96"	1-1/2"
634-1.625X96M	96"	1-5/8"
634-1.75X96M	96"	1-3/4"
634-2.00X96M	96"	2"
634-2.25X96M	96"	2-1/4"
634-2.50X96M	96"	2-1/2"
634-2.75X96M	96"	2-3/4"
634-3.00X96M	96"	3"
634-4.00X96M	96"	4"

INSULATION & ADHESIVES

Hi-Temp Round Rope

For use as boiler and furnace door packing, heat breaks, window seals and access doors.



FEATURES:

- Safe, non-asbestos.
- Heat resistant to 1000°F.

Part #	Size (Diam. x Length)
650-9M	1/8" x 25 ft.
650-12	3/8" x 25 ft.
650-13	1/2" x 25 ft.
650-14M	1/4" x 25 ft.
650-15M	3/8" x 5 ft.
650-16M	3/8" x 25 ft.
650-20M	1/2" x 5 ft.
650-21M	1/2" x 25 ft.
650-24M	3/4" x 25 ft.

Hi-Temp Flat Rope

Use as door seal in Ovens as pipe wrapping for steam tracer lines tadpole tape gasket covers and other gasket and insulation applications.



FEATURES:

- Will not smolder.
- Heat resistant to 2000°F.
- Retains up to 25% tensile strength up to 1000°F.
- High strength-to-weight ratio while maintaining high degree of flexibility.
- Safe, non-asbestos. Knitted fiberglass designed and engineered to meet stringent industrial and marine applications where non-hazardous material are required.

Part #	Size (W x L)
650-100M	1" x 25 ft.
650-105M	2" x 25 ft.

Heater Gasket Material

For replacing gaskets on tank less heaters and circulator flanges. Special sizes available.



Part #	Sheet Size	Pkg Qty.	Color
B44M	12" x 24" x 1/8"	1	Red
B44-1BRM	18" x 36" x 1/8"	1	Black
B44-1M	18" x 36" x 1/8"	1	Red
B44BRM	12" x 24" x 1/8"	1	Black

Manniglas 1900 Gasket Material

Heat resistance to 1200°F. For thermal barrier applications such as furnaces and boiler jackets.

Part #	Description	Pkg Qty.
650-52M	24" x 24" x 1/8"	3

Hi-Temp 400 Paper

Use in wood burning stoves and electric heaters for welding and brazing protection as a heat shield. Can also be used as burner flange gasket material.



FEATURES:

- Stable to 1300°F.
- Low thermal conductivity guarantees safety.
- Very flexible - for easy wrapping, shaping and cutting.

Part #	Sheet Size	Pkg Qty.
650-50M	24" x 24" x 1/8"	6

Flame Shield Heat Protection Sheets

For soldering and brazing in confined areas.

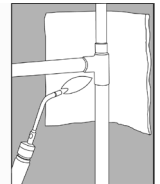

FEATURES:

- 9" x 12" sheet.
- Non-Asbestos.
- Designed for several uses.
- 2400°F max. temperature rating.
- Resistant to thermal shock and chemicals.

Part #
T802M

INSULATION & ADHESIVES

Cork Insulation Tape

FEATURES:

- Used on pipe or tube.
- For air conditioning or refrigerated units.
- For both hot or cold temperature applications from -20 to 158°F.



Part #	Size
J6-3	30 ft. roll, 1/8" thick, 2" wide

Thread Sealing Tape

Wind around threads of any metal, plastic, or rubber pipe to provide leak-free joints. Won't freeze or harden with age.

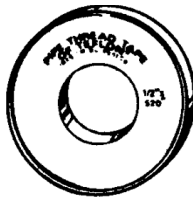

Part #	Size
F3-76M	1/2 x 260"
F3-76AM	3/4 x 260"

Air Conditioner Weather Seal

Flexible foam stripping used to seal gaps created by window installed air conditioning units.

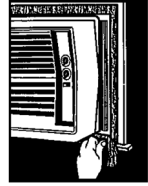

FEATURES:

- Easy maintenance, periodically remove and wash in soapy water.
 - Economical, instead of cleaning simply replace with another piece of this low cost weather seal.
 - Easy installation - If required, simply cut to size and press into place around the unit to prevent drafts and reduce vibration. No tools required.
- Recyclable, made in the U.S.A.

Part #	Size
L15-34	1-1/4" x 1-1/4" x 42"
L15-35	1-1/4" x 1-1/4" x 72"

Handi-Foam Aerosol Insulation

Polyurethane foam for insulating and sealing ducts, air conditioning units and heating equipment.



FEATURES

- Fills quickly and economically.
- Stops air infiltration, insulates, seals, bonds and retrofits.
- Seals joints, vents, sound deadening, inhibits leaks, fills holes, in roofs and walls.

Part #	Size
TFI-012	12 oz.

INSULATION & ADHESIVES

Hi-Temp Round Rope

For use as boiler and furnace door packing, heat breaks, window seals and access doors.



FEATURES:

- Safe, non-asbestos.
- Heat resistant to 1000°F.

Part #	Size (Diam. x Length)
650-9M	1/8" x 25 ft.
650-12	3/8" x 25 ft.
650-13	1/2" x 25 ft.
650-14M	1/4" x 25 ft.
650-15M	3/8" x 5 ft.
650-16M	3/8" x 25 ft.
650-20M	1/2" x 5 ft.
650-21M	1/2" x 25 ft.
650-24M	3/4" x 25 ft.

Hi-Temp Flat Rope

Use as door seal in Ovens as pipe wrapping for steam tracer lines tadpole tape gasket covers and other gasket and insulation applications.



FEATURES:

- Will not smolder.
- Heat resistant to 2000°F.
- Retains up to 25% tensile strength up to 1000°F.
- High strength-to-weight ratio while maintaining high degree of flexibility.
- Safe, non-asbestos. Knitted fiberglass designed and engineered to meet stringent industrial and marine applications where non-hazardous material are required.

Part #	Size (W x L)
650-100M	1" x 25 ft.
650-105M	2" x 25 ft.

Heater Gasket Material

For replacing gaskets on tank less heaters and circulator flanges. Special sizes available.



Part #	Sheet Size	Pkg Qty.	Color
B44M	12" x 24" x 1/8"	1	Red
B44-1BRM	18" x 36" x 1/8"	1	Black
B44-1M	18" x 36" x 1/8"	1	Red
B44BRM	12" x 24" x 1/8"	1	Black

Manniglas 1900 Gasket Material

Heat resistance to 1200°F. For thermal barrier applications such as furnaces and boiler jackets.

Part #	Description	Pkg Qty.
650-52M	24" x 24" x 1/8"	3

Hi-Temp 400 Paper

Use in wood burning stoves and electric heaters for welding and brazing protection as a heat shield. Can also be used as burner flange gasket material.



FEATURES:

- Stable to 1300°F.
- Low thermal conductivity guarantees safety.
- Very flexible - for easy wrapping, shaping and cutting.

Part #	Sheet Size	Pkg Qty.
650-50M	24" x 24" x 1/8"	6

Flame Shield Heat Protection Sheets

For soldering and brazing in confined areas.

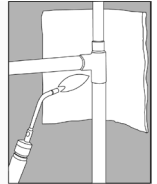

FEATURES:

- 9" x 12" sheet.
- Non-Asbestos.
- Designed for several uses.
- 2400°F max. temperature rating.
- Resistant to thermal shock and chemicals.

Part #
T802M

INSULATION & ADHESIVES

Cork Insulation Tape

FEATURES:

- Used on pipe or tube.
- For air conditioning or refrigerated units.
- For both hot or cold temperature applications from -20 to 158°F.



Part #	Size
J6-3	30 ft. roll, 1/8" thick, 2" wide

Thread Sealing Tape

Wind around threads of any metal, plastic, or rubber pipe to provide leak-free joints. Won't freeze or harden with age.

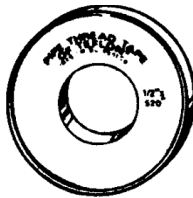

Part #	Size
F3-76M	1/2 x 260"
F3-76AM	3/4 x 260"

Air Conditioner Weather Seal

Flexible foam stripping used to seal gaps created by window installed air conditioning units.

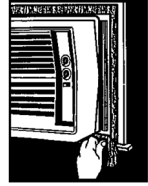

FEATURES:

- Easy maintenance, periodically remove and wash in soapy water.
 - Economical, instead of cleaning simply replace with another piece of this low cost weather seal.
 - Easy installation - If required, simply cut to size and press into place around the unit to prevent drafts and reduce vibration. No tools required.
- Recyclable, made in the U.S.A.

Part #	Size
L15-34	1-1/4" x 1-1/4" x 42"
L15-35	1-1/4" x 1-1/4" x 72"

Handi-Foam Aerosol Insulation

Polyurethane foam for insulating and sealing ducts, air conditioning units and heating equipment.



FEATURES

- Fills quickly and economically.
- Stops air infiltration, insulates, seals, bonds and retrofits.
- Seals joints, vents, sound deadening, inhibits leaks, fills holes, in roofs and walls.

Part #	Size
TFI-012	12 oz.

MAINTENANCE & SAFETY

Soot-Snoot Vacuum Cleaner Hoses Vacuum Bags

FEATURES:

- Reaches places impossible to access with regular vacuum hoses.
- Particularly useful for today's smaller, more compact boilers.
- Easy slip-on attachment to any standard vacuum.
- Flexible without being overly "floppy".



Part #	Hose Style	Description
S53-40M	Flexible	4' x 7/8"
S53-41M	Rigid	5' x 7/8"

Drum Pump

For use with:

- F2-17BM – STR2+ Fuel Oil Treatment, 55 gal. drum.
- ARCTIC1005 – Antifreeze, 5 gal. pail.
- 998E02205 – Polyolester Oil, 5 gal. pail.



FEATURES:

- Adjustable dispenses 2, 4, 6, or 8 ounces per stroke.
- Molded components of polypropylene and polyethylene-chemical and acid resistant materials.
- Fits 5 gal. pail with Reike Senior spout supplied.
- Fits 55 gal. drum with 3/4" or 2" standard F.I.P. fittings supplied.

Part #
F1-39EM

Replacement Motor for Industrial Vacuum Cleaners

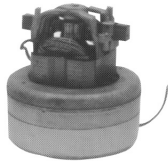

Part #	HP	Used On
A166M	7/8	Sid Harvey models S12, S14, S16. Mastercraft models 641M, 642M, 655M

FEATURES:

- Filter paper bags imprinted with installation instructions.



S52-14, -15

Part #	Style	Competitive Cross Reference
S52-14M	4464	Mastercraft 605, 641, 110, 6500 and other small sized (3-1/2 gal.) vacuum cleaners
S52-15M	4465	Mastercraft 652, 653, 990, 1010, 1015, 1300, 7000, D6508, D6520, D6530, W6508, W6509, 6510, 6513 and other medium sized (5 gal.) vacuum cleaners

Vacuum Cleaner Attachments and Accessories

Part#	Description	Dimension
S53-10	Standard hose	10 ft. x 1-1/2" dia.
S53-50	Flexible metal hose	6 ft. L x 1-1/2" od, fits 1-1/2" id hoses
S53-55	Flexible metal hose	6 ft. L x 1-1/2" id hoses

Dust Mask

Provides comfortable relief against the irritating effects of non-toxic, nuisance dusts such as pollen, common house dust and cut grass.



FEATURES:

- Lightweight - elastic headband provides just enough tension to hold mask to head.
- Comfortable - won't interfere with breathing or speech.
- Contour design - low profile provides maximum field of vision, even with eyeglasses.
- Custom fit - adjustable, flexible metal nosepiece.

Part #	Description
S7	Dust mask, 50 per box

MAINTENANCE & SAFETY

N-Dex™ Powder-Free Disposable Gloves

100% soft nitrile, petro-chemical resistant.

FEATURES:

- 4 mil thin for new levels of tactile sensitivity and comfort.
- Exclusive, patented, low modulus formulation reduces hand fatigue and provides much greater puncture resistance.
- Cooler and drier feeling than natural rubber or other disposables.

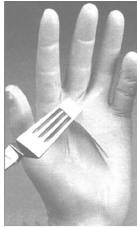

Part #	Size	Qty/Pack
7005PFMM	Medium	100 per box
7005PFLM	Large	100 per box
7005PFXLM	Extra Large	100 per box
7005PFXLXL	2 Extra Large	100 per box

Black Mamba Gloves

FEATURES:

- Fully textured 6 mil from tip to wrist.
- 3 times the chemical resistance of latex or vinyl.
- Patented nitrex polymer for superior strength and tear resistance.



Part#	Size	Qty/Pack
BLK-110-MM	Medium	100 per box
BLK-120-LM	Large	100 per box
BLK-130-XLM	Extra Large	100 per box
BLK-140-XXLM	2 Extra Large	100 per box

Blue Mamba Gloves

FEATURES:

- Fully textured 6 mil from tip to wrist.
- 3 times the chemical resistance of latex or vinyl.
- Patented nitrex polymer for superior strength and tear resistance.



Part#	Size	Qty/Pack
BLU-110-MM	Medium	100 per box
BLU-120-LM	Large	100 per box

Part#	Size	Qty/Pack
BLU-130-XLM	Extra Large	100 per box

Knee Pads

Contoured, single strap, foam rubber, water repellent.



FEATURES:

- Affixes with a 3/4" adjustable strap.
- Made of a thick, soft, cellular rubber for maximum comfort.

Part

S80-40

Super-Flex™ Foam Insulated Gloves

Vinyl coated, chemical-resistant.

APPLICATION; Winter transportation; yard and field work; cold storage; unheated warehouses; laboratories; construction.



FEATURES:

- Curved fingers and winged thumb for extra working ease.
- Tough and fully coated to resist abrasion, oils, chemicals. Stay soft when cold.
- Foam insulation locks out cold and keeps hands warm.
- Triple-layer construction of insulation that provides extra protection at low temperatures with specially formulated PVC coating that remains flexible even in sub-zero temperatures.
- Wrinkle finish provides excellent wet or dry grip.
- Safety cuff.

Part

S80-30M

MAINTENANCE & SAFETY

Dura Flock Gloves

Keeps your hands dry, comfortable, and protected with Dura FLock™ gloves.



FEATURES:

- 8 mil nitrile 25% thicker than standard disposable gloves for increased durability and superior protection.
- Extremely comfortable to wear for extended periods reducing hand fatigue.
- Exclusive ultra-thin moisture-absorbing flock-lining keeps hand dry.
- Fully-textured for a firm, reliable grip.
- 100% nitrile, latex-free.

Item#	Size	Qty/Pack
DFK-608-LM	Large	50 gloves per box
DFK-608-XLM	Extra Large	50 gloves per box
DFK-608-XXLM	2 Extra Large	50 gloves per box

MAINTENANCE & SAFETY

Kwik-Wick Absorbent Spill Kit

Effectively controls leaks and spills. For use with oil, grease, coolants and other industrial fluids.

FEATURES:

- Powerful wicking action.
- Socks are filled with safe, non-toxic material.
- Absorbs up to 6-3/4 gal. of oil or the equivalent of 320 lb. clay (8 bags).



Part #	Kit Includes	Pkg Qty.
F1-86M	11 absorbent pads, 18" x 18", 3 absorbent socks and 3 disposal bags	1 kit
F1-87M	Absorbent sock, 4" x 46"	40
F1-89M	Absorbent pad, 18" x 18"	100

Petroleum Sorbent Pads

Hydrophobic – absorbs oil only, repels water. Can also be used to absorb splashes and spills.



Part #	Description	Pkg Qty.
F1-85M	Absorbent pad, 15" x 18"	200
F1-88M	Absorbent pad, 17" x 19"	200

Water Detecting Paste

Detects water in tank.



Part #	Size
F2-25	2 oz. jar
F7-5	7 oz. tube

Safety Labels

IF OIL BURNER FAILS TO OPERATE

1. Be sure the oil burner switch is on.
2. Thermostat should be set above the room temperature.
3. Be certain there is oil in the tank.
4. Check fuse or circuit breaker.
5. Press red reset button on relay - **ONCE ONLY**.
If burner still fails to operate, call for service.

PRESS RESET BUTTON
ONCE ONLY. IF BURNER
DOES NOT START, CALL
FOR SERVICE.

Used by oil service technicians to alert homeowners to proper procedures to follow in case of burner failure

FEATURES:

- Fluorescent orange labels have high visibility and are easily seen by homeowners
- Peel-and-stick label stock is easily affixed to equipment.

Part #	Label Message	Pkg Qty.
T397-600M	If burner Fails To Operate	10

Kwik-Zorb Waterwick

Absorbs and removes the water that collects at the bottom of oil and kerosene tanks.



FEATURES:

- Can be used on openings 1-1/2" in diameter or larger.
- Removes approximately 8oz of water.

Part#

F2-30M

Nylon Flex-Duct Straps

Use in attaching flex-duct to register and grilles.



FEATURES:

- Manufactured from nylon 6/6
- Rated at 120 or 175 lb. minimum loop tensile strength

Part #	Description	Pkg Qty.
T397-424M	24" long for 6" duct, 120 lb.	50
T397-436M	34" long for 10" duct, 175 lb.	50
T397-448M	48" long for 14" duct, 175 lb.	50

OIL HEAT SERVICE

Flow Control 3/K-2

Oil De-Aerator

Separating air from Oil-Outperforms all other oil De-Aerators.

FEATURES:

- Simplifies Installation - no return line to the tank.
- Reduces installation cost - 1-stage pump does the work of a 2-stage pump.
- Reduces service calls - eliminates nuisance air leaks and call backs.
- Extends oil filter life - only the oil that goes through the nozzle is filtered.
- 5 year warranty.
- Helps resolve cold oil combustion problems
- Superior flow characteristics over competitive de-aerators.
- 3 Floats – 2 chambers double seals the units
- Mounts close to the burner.
- **BIO RATING OF B100.**

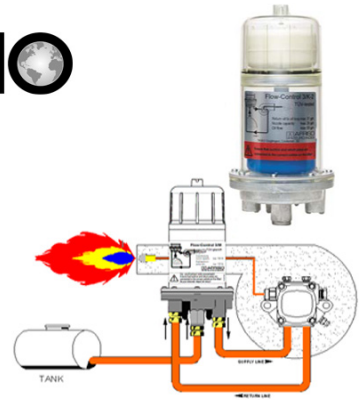

Part #	Nozzle Capacity	Return Oil	Oil Flow	Operating Temp.	Ambient Temp.	Feed Line Operating Pressure	Pump/Tank Connection
P131-35M	26 GPH	37 GPH	58 GPH	140°F max.	140°F max.	10 PSI	1/4" NPT

Flexible Oil Lines

Mitco's flex lines are composed of a perbunan liner inside a braid of Galvanized soft steel. It simplifies the installation of oil components.

FEATURES:

- Max temperature 212°F
- Operating pressure 145 psi
- **BIO RATING OF B20**



Part#	Length	Connectors
P131-18M	24"	1/4" NPT Male x 1/4" NPT Male
P131-18FM	24"	3/8" Female Flare x Female Flare
P131-19M	36"	1/4" NPT Male x NPT Male
P131-19FM	36"	3/8" Female Flare x Female Flare
P131-28M	36"	3/8" x 1/4" NPT Male

Oil Safety Valves

FEATURES:

- Operated by fuel pump pressure.
- Prevents fuel flow in the event of a line break or when the unit is shut idle.
- Prevents fuel from puddling in chamber, causing smokey start ups, puff back and possible fires.



Guard against spills and siphoning

Part#	Mfr	Mounting Connections	Mfr#
P131-31M	Suntec	Any location, max 3" above lowest point in system, 3/8" NPT	PRV38

OIL HEAT SERVICE

Oil Burner Nozzles

Mitco Mfg. stocks and offers for sale an extensive selection of Delavan nozzles.



FEATURES:

- Individually packaged in sturdy plastic vials.
- Vials are color coded and stamped for easy identification.

Nozzle Extractors



Part #	Description
94-1	Barrel snaps off for removal from flame retention head.

Copper Nozzle Lines

Replacement oil lines for oil burners.

FEATURES:

- Flared copper with nuts.



Part #	Size
P127-5M	3/16" x 16"
P127-5AM	3/16" x 5"
P127-5BM	3/16" x 12"
P127-6M	1/4" x 16"
P127-6BM	1/4" x 12"
P127-7M	3/16" x 8"

Beckett Nozzle Lines

Copper line with hydraulic double flare fitting.



Part#	Size
5636M	6.5"
5394M	8"
5628M	9.5"
51127U	11"

In-Line Nozzle Filters



Part#
87-1

Nozzle Fittings for Beckett AF Series Burners



Part #	Description
P127-12M	Fitting only
P127-13M	Fitting for 3488-AFG Model Series
P127-14M	Fitting with 16" tubing

Delevan Flame Mirrors



Part#	Size	With handle
90	Rectangular mirror 1-15/16"	Yes
90-1	Rectangular mirror Only	No
90-2	Mini-mirror w/handle	Yes
90-3	Mini-mirror only	No

Beckett Silent-Flo™ Line Noise Dampener

Inserts in the return line of a two pipe system at the pump connection or in the suction line of a single pipe system. Immediately reduces noise.

Part#
480-10

Nozzle Adapters

FEATURES:

- Precision machined.
- Solid brass.



Part #	Size	Pkg Qty.
80M	2-1/16" x 1/8" FPT	1
80-1M	2-1/16" x 1/4" FPT	1
81M	1-3/8" x 1/8" FPT	6
81-1M	1-3/8" x 1/4" FPT	3
82M	7/8" x 1/8" FPT	1
82-1M	7/8" x 1/4" FPT	1

OIL HEAT SERVICE

Kwik Couple Oil Burner Couplings



Universal replacement 3-piece coupling with high density plastic end pieces.

FEATURES:

- Requires no set screws, ends slide on shaft.
- Flexible center piece is self aligning and may be easily cut with a knife.

KWIK COUPLER KITS

Part #	Description
146M	5" Coupling Kit
146-1M	6" Economy Pak
146-2M	12" Coupling Kit
148-6M	6" Coupling Kit

REPLACEMENT PARTS

146-30M	30" center piece
148-8M	1/2" end piece, black
148-9M	7/16" end piece, blue
148-10M	5/16" end piece, red
148-50M	5" center piece
148-60M	6" center piece
148-70M	12" center piece

EXACT REPLACEMENT COUPLINGS

155-5M	Beckett AF
155-6M	Beckett SR
175M	Carlin 100CRD
198M	Wayne MSR

OIL HEAT SERVICE

Combustion Chamber Products

Part #	Lynn Model #	Application/Features	Size	Pkg Qty.
633-95	1019	COMBUSTION CHAMBER BOARD • For floors, walls, front plate or target installation	20" x 20" x 1"	2
633-60	1030	BURNER HEAD PROTECTOR • Use to protect against high flame temperatures. • Useful as a sizing aid. • Fits 4" o.d. burner heads, Beckett and others.	up to 4" o.d.	1
633-90	9500	KAOWOOL STRIPS • Use as gasket material and end cone protection.	150" x 2" x 1"	1

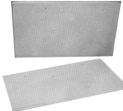

COMBUSTION CHAMBER BOARD

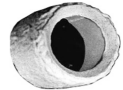

BURNER HEAD PROTECTOR

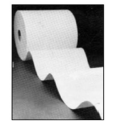

KAOWOOL STRIP

Kaowool Dry Combustion Blankets

A soft ceramic blanket that can be formed to the shape of an existing chamber. For applications where protection is required against high temperatures such as lining steel and hard brick chambers.

FEATURES:

- Can withstand temperatures up to 2300°F.
- Kaowool construction for safety - contains no asbestos.



Part #	Dimensions	Lynn Model#
633-68	56" x 14" x 3/4"	9450
633-67	48" x 16" x 1/2"	9451
633-69	60" x 24" x 1/4"	9452

Hole Plugs

Part #	Lynn Model #	Application/Features	Size	Pkg Qty.
633-98	6010	For plugging test holes in flue pipe	5/16"	100

OIL HEAT SERVICE

Golden Glo Wet Combustion Blankets

A soft, moist fiber blanket that can be formed to the shape of an existing chamber and used as a liner.

FEATURES:

- High temperature ceramic fiber construction. Non-freezing.
- Kaowool construction for safety - contains no asbestos.
- Formed and packaged wet - hardens when burner is fired.



Part #	Pkg Qty.	Dimensions	Lynn Model#
628-20	1	'A' KIT 14" x 48" x 1/2"	1032
628-21	1	'B' KIT 14" x 48" x 1/2" 16" x 16" x 1/2"	1033
628-22	1	'C' KIT 16" x 48" x 1/2" 16" x 16" x 1/2"	1034
628-16	1	INDIVIDUAL BLANKET 36" x 24" x 1/2"	1035
628-17	1	INDIVIDUAL BLANKET 36" x 18" x 1/2"	1036

Filter Pads for Miller Furnaces

Washable foam media pads sized for popular models of Miller furnaces. Easily cut to size for other applications.

Part #	Dimensions	Pkg Qty.
L17-140M	15-34" x 17-3/4" x 1/4"	25
L17-142M	15-34" x 26-3/4" x 1/4"	25

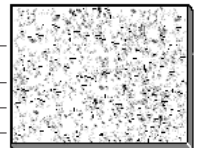

Gaskets for Miller Furnaces

REPLACEMENT GASKETS FOR MILLER MOBILE HOME FURNACES

Part #	Miller Model#	Description	Pkg Qty.
650-55M	301195000	Flue gasket 7-1/16" o.d. x 5-1/8" i.d.	20
650-60M	3001000	Burner gasket 6-1/2" o.d. x 4-3/8" i.d.	20
650-65M	301181000	Pouch gasket 10" x 13-1/2"	20
650-70M	301205000	Burner plate gasket 10-1/2" x 16"	20
650-75M		Gasket kit with one each of gasket listed above	4

OIL HEAT SERVICE

Clean out Gaskets for York and ICP Furnaces

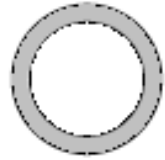

INTERNATIONAL COMFORT PRODUCTS

Part #	Description	Pkg Qty.
650-82M	(Acroaire, Heil, Tempstar brands) furnace gasket 1149103	6
650-82BM	(Acroaire, Heil, Tempstar brands) furnace gasket 1149103	25

YORK

650-80M	028-1070900	6
650-80BM	028-10709000	25

THERMOPRIDE

650-83M	Clean-out gasket	6
650-83BM	Clean-out gasket, bulk pack	25

Ignition Buss Bars



Part #	Description
T386M	12" length - Round
T386-4M	12" length - Flat

Ignition Leads

Package of 2.



Part #	Description
T386-20M	12" - Ring-Cage
T386-21M	12" - Cage-Cage
T386-26M	18" - Ring-Cage
T386-27M	18" - Cage-Cage
T386-32M	24" - Ring-Cage
T386-33M	24" - Cage-Cage

Transformer Gasket Kit

When properly installed, this gasket kit will maintain a "seal tight fit" recommended for AFG style burners. This kit can be used with most name brand replacement transformers. Includes: 1 perimeter body gasket, 1 bridge gasket.

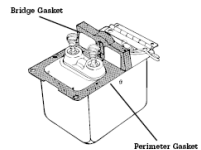

Part

T92-2M

Universal Cleanout Plug



Part #	Description	Pkg Qty.
T397-95M	Universal furnace clean out plug and gasket	1
T397-96M	Thermopride cleanout cover bracket less plug	1

OIL HEAT SERVICE

Oil Burner Porcelains and Igniters

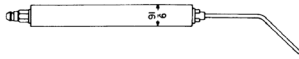

DIAGRAM - A
LARGE BORE

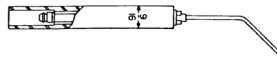

DIAGRAM - B
LARGE BORE

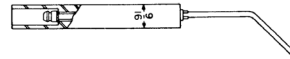

DIAGRAM - C
SMALL BORE

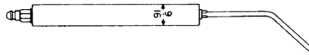

DIAGRAM - D
SMALL BORE

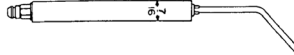

DIAGRAM - E
SMALL BORE

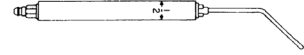

DIAGRAM - F
SMALL BORE

Part #	Porcelain Only	Type	Porcelain Diameter	Porcelain Length	Bore Diameter	Tip Length	Dia.
300-1M		Male	9/16"	4"	3/16"	2-5/8"	A
301-1M		Male	9/16"	4-1/2"	3/16"	2-5/8"	A
302-1M		Male	9/16"	4-3/4"	3/16"	- - -	A
303-1M		Male	9/16"	5"	3/16"	2-5/8"	A
305-1M		Male	9/16"	6"	3/16"	2-5/8"	A
307-1M		Male	9/16"	7"	3/16"	2-5/8"	A
308-1M		Female	9/16"	4"	3/16"	2-5/8"	B
309-1M		Female	9/16"	4-1/2"	3/16"	2-5/8"	B
310-1M		Female	9/16"	5"	3/16"	2-5/8"	B
311-1M		Female	9/16"	6"	3/16"	- - -	B
312-1M		Female	9/16"	7"	3/16"	2-5/8"	B
312-6M		Female	9/16"	4"	1/8"	2-5/8"	C
312-8M		Female	9/16"	4-1/2"	1/8"	2-5/8"	C
312-10M		Female	9/16"	5"	1/8"	2-5/8"	C
312-12M		Female	9/16"	5-1/2"	1/8"	- - -	C
312-14M		Female	9/16"	6"	1/8"	2-5/8"	C
312-16M		Female	9/16"	7"	1/8"	2-5/8"	C
312-18M		Female	9/16"	8"	1/8"	- - -	C
312-26M		Male	9/16"	4"	1/8"	2-5/8"	D
312-28M		Male	9/16"	4-1/2"	1/8"	2-5/8"	D
312-30M		Male	9/16"	5"	1/8"	2-5/8"	D
312-32M		Male	9/16"	5-1/2"	1/8"	2-5/8"	D
312-34M		Male	9/16"	6"	1/8"	2-5/8"	D
312-36M		Male	9/16"	7"	1/8"	2-5/8"	D
312-38M		Male	9/16"	8"	1/8"	2-5/8"	D
312-50M		Male	7/16"	4"	1/8"	- - -	E
313-1M		Male	7/16"	4-1/4"	1/8"	2-3/4"	E
314-1M		Male	7/16"	4-1/2"	1/8"	- - -	E
315-1M		Male	7/16"	4-3/4"	1/8"	- - -	E
316-1M		Male	7/16"	6"	1/8"	2-3/4"	E
317-1M		Male	1/2"	4"	1/8"	2-5/8"	F
318-1M		Male	1/2"	5"	1/8"	2-5/8"	F
319-1M		Male	1/2"	6"	1/8"	2-5/8"	F

OIL HEAT SERVICE

OEM Replacement Oil Burner Porcelains and Igniters

Part #	OEM	Porcelain Diam.		
320M	Ace	9/16"		
323-1M	Aero water heater and Carlin burner	7/16"		
323-2M	Aero water heater and Carlin burner	9/16"		
325-3M	ABC	9/16"		
325-4M	ABC	9/16"		
326M	ABC	9/16"		
326-1M	ABC	7/16"		
328M	Arcoflame	9/16"		
328-3M	Arcoflame C	9/16"		
329M	Arcoflame MF	9/16"		
329-1M	Arcoflame B-1	9/16"		
329-2M	Armstrong	9/16"		
330M	Beckett	9/16"		
330-1M	Beckett	9/16"		
330-2M	Beckett AFG	9/16"		
330-3M	Beckett	9/16"		
330-4M	Beckett SR	9/16"		
330-6M	Beckett	9/16"		
330-7M	Beckett	9/16"		
330-8M	Beckett	7/16"		
331M	Beckett	9/16"		
331-3M	Bettendorf	9/16"		
331-1M	Bettendorf	7/16"		
332M	Caloroil	9/16"		
332-1M	Caloroil	9/16"		
332-3M	Carlin	9/16"		
332-4M	Carlin	9/16"		
332-5M	Carlin	9/16"		
332-6M	Carlin	7/16"		
332-7M	Carlin	9/16"		
332-10M	Carlin left hand, right hand	9/16"		
82768S	Carlin Electrode	5" Long		
82776S	Carlin Electrode	7" Long		
82784S	Carlin Electrode	9" Long		
82792S	Carlin Electrode	11" Long		
332-1M	Delco	9/16"		
360-8M	Iron Fireman	9/16"		
360-9M	Iron Fireman	9/16"		
361-5M	Lennox	9/16"		
364-6M	Miller Mobile Home left hand, right hand	7/16"		

CONTINUED

OIL HEAT SERVICE

OEM Replacement Oil Burner Porcelains and Igniters

Part #	OEM	Porcelain Diam.
365-8M	National Radiator	9/16"
366M	Nu-Way	7/16"
366-1M	Nu-Way	9/16"
366-7M	Nu-Way	7/16"
367M	Nu-Way	7/16"
369M	Nu-Way	1/2"
380M	Quiet Heet	7/16"
385M	Shell Head	9/16"
385-1M	Shell Head	9/16"
385-2M	Shell Head	9/16"
404M	Wayne	9/16"
404-1M	Wayne	1/2"
404-2M	Wayne Blue Angel	7/16"
404-3M	Wayne	1/2"
404-4M	Wayne	1/2"
404-5SM	Wayne left hand, right hand	1/2"
404-9M	Wayne left hand, right hand	1/2"
409-2M	York left hand, right hand	9/16"
411M	Sun Ray	9/16"
411-1M	Sun Ray	9/16"
411-2M	Sun Ray	9/16"
411-3M	Sun Ray	9/16"
411-4M	Sun Ray	9/16"
414M	Weil-McLain double	7/16"

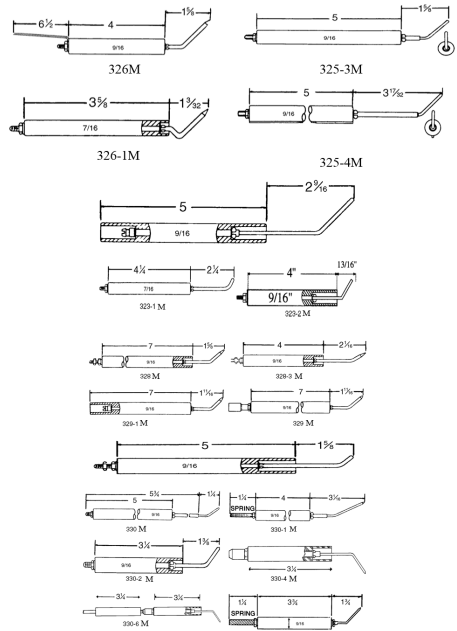

Beckett Universal Electrode Kits

Part #	OEM
5780M	Beckett Electrode Kit



King Tank Fill Alarm

FEATURES:

- Easy to read and accurate.
- Cast in durable grey iron with corrosion resistant finish.
- 'R' type whistle.

Part #	Stem Depth	Color
532	5-1/4"	Tan
532-1	5-1/4"	Red
532-2	9-3/4"	Green
532-4	5-1/4"	Blue



OIL HEAT SERVICE

King Tank Fill Alarm and Tank Gauge Combinations

2" x 2" Male/Female. For basement or above ground tanks.

FEATURES:

- Air tight construction won't leak when air-tested to meet local codes.
- Installation is quick and easy, even in empty or partially filled tanks or tight spots.
- Durable grey iron with corrosion resistant powder coating.
- 'R' type whistle.



Part #	Tank Size	Tank Position	Color	Size (Bottom) Male x Female
535-1	42"-44"	Vertical	Orange	1-1/2" x 1-1/4"
535-3	42"-44"	Vertical	Red	2" x 1-1/4"
535-5	42"-44"	Vertical	Blue	2" x 2"
535	26"-27"	Horizontal	Orange	1-1/2" x 1-1/4"
535-2	26"-27"	Horizontal	Red	2" x 1-1/4"
535-6	26"-27"	Horizontal	Blue	2" x 2"

Oil Fill Caps

Flush type. Recessed cover on on-locking cap is ideal for flush installation in floors and driveways.

FEATURES:

- Seals tightly, yet is easy to open.
- Solid brass construction.
- Thick leather gasket maintains water tight seal.
- Rust resistant.



Part #	Size
430-1	2" - Female

Econ-O-Gauge® Level Indicators

FEATURES:

- Leak-proof construction with non-rusting zinc casting
- Dual bushing fits both 1-1/2 & 2" tanks holes

Part #	Tank Depth
575-11	26"-27"
575-10	42"-44"

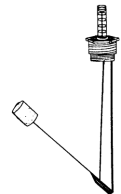

OIL HEAT SERVICE

TANK GAUGE CHART

275 GALLON 44" x 27" x 60" VERTICAL		275 GALLON 44" x 27" x 60" HORIZONTAL		285 GALLON 38" x 60"		550 GALLON 48" x 72"		1,000 GALLON 48" x 128"	
Inches	Gallons	Inches	Gallons	Inches	Gallons	Inches	Gallons	Inches	Gallons
2	5	2	14	1	3	1	3	1	5
4	14	4	32	2	6	2	8	2	14
6	25	6	51	3	11	3	15	3	26
8	37	8	73	4	17	4	22	4	40
10	50	10	96	5	23	5	31	5	55
12	65	12	118	6	30	6	41	6	72
14	79	14	146	7	37	7	51	7	91
16	93	16	169	8	45	8	62	8	110
18	107	18	191	9	53	9	73	9	130
20	122	20	213	10	62	10	85	10	151
22	136	22	235	11	71	11	97	11	173
24	150	24	253	12	80	12	110	12	196
26	164	26	275	13	89	13	123	13	219
28	178			14	99	14	137	14	243
30	193			15	108	15	151	15	267
32	207			16	118	16	165	16	292
34	221			17	128	17	179	17	317
36	234			18	137	18	193	18	343
38	246			19	147	19	208	19	369
40	258			20	157	20	222	20	395
42	268			21	167	21	237	21	421
44	275			22	177	22	252	22	447
				23	186	23	267	23	474
				24	196	24	282	24	501
				25	206	25	297	25	528
				26	215	26	312	26	555
				27	224	27	327	27	581
				28	233	28	342	28	607
				29	241	29	356	29	633
				30	249	30	371	30	659
				31	257	31	385	31	685
				32	265	32	399	32	710
				33	272	33	413	33	735
				34	278	34	427	34	759
				35	284	35	441	35	783
				36	289	36	454	36	806
				37	292	37	467	37	829
				38	295	38	479	38	851
						39	491	39	872
						40	502	40	892
						41	513	41	911
						42	523	42	930
						43	533	43	947
						44	542	44	962
						45	549	45	976
						46	556	46	988
						47	561	47	997
						48	564	48	1002

Fluid Level String Gauges

Universal, mechanical level gauge for measuring levels in fuel oil tanks.

FEATURES:

- Interchangeable scale faces for 24" and 42" fluid heights (275 gal. tanks) for use with a wide variety of fuel oil storage tanks.
- 2" NPT threads.
- Easy-to-read dial face.
- Highly reliable.
- Made of ABS plastic with epicyclic gear set and nylon cord for added durability.



Part

577M

OIL HEAT SERVICE

Universal Floating Suction Line

The KLEEN-FLO floating suction line utilizes only the upper oil level, reducing nozzle and filter performance problems caused by contaminants in the tank. The bottom of storage tanks are notorious for contamination. The KLEEN-FLO is particularly effective during oil tank fill-ups, when the oil supply is most vulnerable to contamination as new fuel is added, stirring up bottom sediment.



FEATURES:

- Fits any tank, vertical or horizontal
- Significantly reduces filter and nozzle clogging
- Standard 2" threaded connection
- Ideal for single or two pipe systems
- Stainless clamps and fittings for durability
- Made to last – fabricated from high quality, non-corrosive materials. The float and tubing are oil-resistant and B20 rated
- Tubing rated to 1000 PSI

Part#

578M

Humidifier Pads

Replacement evaporator pads for many popular humidifier models.

Part #	Replaces
L26M	Montgomery 20 Skuttle 90, H100, 100
L26-80M	Vista 710 Research Products 10RR Adams MFG. AWP-1, 10RR, 110, 220 Chippewa 220
L26-82M	Adam MFG. AWP-2, 12RR, 112, 136, 440, 445 Chippewa 224, 225 Research Products 12RR Vista 712
L27-4M	Autoflo 0-40, 250, 40EP Leigh 224, 225, 1100 Little Giant LGH, PB-S1, SP P-1 Vista 717
L27-10M	Autoflo 97EP (model 97)
L27-14M	Autoflo 200P, 200PR, 800BP, 800 BPR
L29-22M	Trion 1220
L29-27M	Herrmidifier 2024 (model 2000)
L31-20M	Montgomery Ward 12 Skuttle 45
L32M	Lau/Conaire 411069-06 Vapor-Air 8, 14
L32-2M	Lau/Conaire 410510-06 Vapor-Air 2, 5, 18, 4300
L32-8M	Lobb WA-2

OIL HEAT SERVICE

Clean-Fit Brushes and Extension Rods

For use in oil heat refrigeration and plumbing service and for general cleaning.



HARD SPIRAL FLUE BRUSHES

Part #	Features	Size
S5-47	• Stiff, flat wire tube brush	2" od
S5-47B	• 1/4" npt connection.	3" od

100 % HORSEHAIR RADIATOR BRUSH

S5-108	• 24" long overall • Hardwood handle	9" L, 1 row
--------	---	-------------

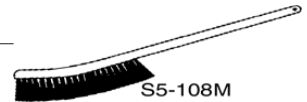

SPIRAL HORSEHAIR RADIATOR BRUSHES

S5-70	• Single spiral	2" dia. x 27" L
S5-74	• 6" fill	2" dia. x 42" L
S5-72		3" dia. x 27" L
S5-76		3" dia. x 42" L

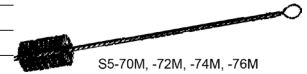

SPIRAL FIBER FILL RADIATOR BRUSHES

S5-62	• Single spiral	2" dia. x 27" L
S5-64	• 6" fill	2" dia. x 42" L
S5-66		3" dia. x 27" L
S5-68		3" dia. x 42" L

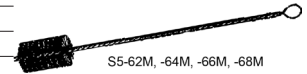

SPIRAL WIRE RADIATOR BRUSHES

S5-79	• 3" brush length	1/2" dia x 42" L.
S5-79A	• 4" loop handles for hanging	3/4" dia. x 42" L
S5-79B	• Labels on handles	1" dia. x 42" L
S5-78	• with individual IPC	1-1/2" dia. x 42" L
S5-80	identification.	2" dia. x 42" L
S5-81	• Carbon steel handles.	2-1/2" dia. x 42" L
S5-82		3" dia. x 42" L

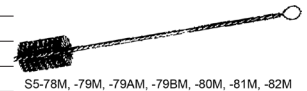

FAN BRUSHES

S5-102		3/8" dia. x 9" L
S5-104		1/2" dia. x 9" L
S5-100		3/4" dia. x 9" L
S5-100A		3/4" dia. x 30" L

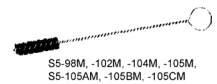

OIL HEAT SERVICE

Clean-Fit Brushes and Extension Rods CONTINUED

For use in oil heat refrigeration and plumbing service and for general cleaning.

GAUGE GLASS BRUSHES

Part #	Features	Size
S5-98		1/2" dia. x 24" L
S5-105B		1/2" dia. x 36" L
S5-105A		1/2" dia. x 18" L
S5-105C		3/4" dia. x 9" L
S5-100B		1-1/2" dia. x 36" L
S5-100C		2-1/4" dia. x 36" L

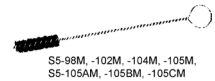

S5-98M, -102M, -104M, -105M,
S5-105AM, -105BM, -105CM

ACID OR DOPE APPLICATOR BRUSHES

T723-35	<ul style="list-style-type: none"> • 100% horsehair • Tin plated handle 	3/8" bristle x 5-7/8" handle
---------	---	---------------------------------

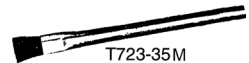

T723-35M

FINE WIRE WIPER BRUSHES

S5-90	• 3" brush length	1/2" dia. x 16" L
S5-92	• Loop handles for hanging	5/8" dia. x 16" L
S5-94	• Stainless steel handle	3/4" dia. x 18" L
S5-96	(unless noted) • Labels on handles with individual IPC identification *Carbon steel handle	1" dia. x 18" L



S5-90M, -92M, -94M, -96M

HAND WIRE SCRATCH BRUSHES

S5-110	• Hardwood handles and backs	14" x 1" B, 3 x 19 R, 1-3/16" T
S5-110A	B = block size R = row configuration T = trim size	14" x 1-1/8" B, 4 x 18 R, 1-3/16" T

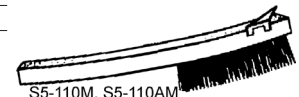

S5-110M, S5-110AM

DUSTER HAND WIRE SCRATCH BRUSHES

S5-112	• Hardwood handles and backs	2-3/4" x 1-1/8" block, 4" x 8" rows, 2-3/8" trim size
--------	------------------------------	---



S5-112M

SHOE HANDLE HAND WIRE SCRATCH BRUSHES

S5-115	• Hardwood handles and backs B = block size R = row configuration T = trim size	10" x 1-1/8" B, 4 x 16 R, 1-3/16" T
--------	--	--



S5-115M

REFRIGERATION/RADIATOR BRUSHES

S5-88	• Horsehair	1-7/8" x 1-1/8" x 42" L
S5-88A		1/2" - 1" taper, 21" L

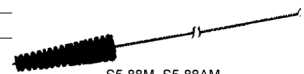

S5-88M, S5-88AM

OIL HEAT SERVICE

Clean-Fit Brushes and Extension Rods CONTINUED

For use in oil heat refrigeration and plumbing service and for general cleaning.

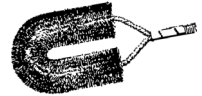

S5M, S5-2M

U BRUSHES - DOUBLE STEM, HORSESHOE SHAPE

Part #	Features	Size
S5	• Oil-tempered wire	1-1/2" dia. x 4" fill x 5" L
S5-2	• 1/4" npt connection	2" dia. x 4-1/2" fill x 5" L

FIBERGLASS EXTENSION RODS FOR FLUE, BOILER AND CHIMNEY CLEANING BRUSHES

S5-46	• Standard rods have 1/4" npt	1/4" npt x 3 ft. L
S5-48	self-connect and .34" dia.	1/4" npt x 4 ft. L
S5-52	extension rod	1/4" npt x 6 ft. L
S5-51	• Heavy duty rods have 3/8"	3/8" npt x 4 ft. L
S5-51B	extension rod	3/8" npt x 6 ft. L

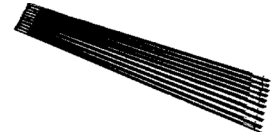

S5-46M, -48M, -51M, -51AM, -51BM, 52M

WEIL-McLAIN BOILER BRUSHES

S5-86	• Twisted-in handle	1-1/2" x 1-1/8", 30" L heavy duty
S5-86A	• Horsehair	1-1/2" x 1-1/8", 30" L lite duty

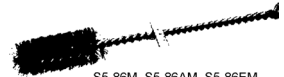

S5-86M, S5-86AM, S5-86EM

COLUMBIA BOILER BRUSHES

S5-84	• Flat brush	1/2" x 1", 48" L
S5-84A		1/2" x 1", 27" L

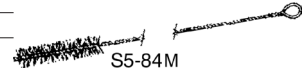

S5-84M

SLANT/FIN BOILER BRUSHES

S5-87	• Tapered	0" to 2-1/4" taper, 20" L
-------	-----------	---------------------------

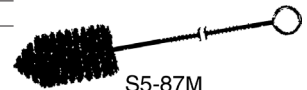

S5-87M

CONDENSER TUBE AND HEAT EXCHANGER BRUSHES

S5-19	• 4-1/2" brush length	1/2" dia. x 7-1/2" L
S5-20	• High carbon steel wire	5/8" dia. x 7-1/2" L
S5-22	• 1/8 npt outside • 5/16"-18 in.. thread • Shank length 2" • Individually boxed with UPC and sizes clearly indicated	3/4" dia. x 7-1/2" L



S5-19M, S5-20M, S5-22M

SINGLE SPIRAL WIRE FLUE AND BOILER TUBE BRUSHES

S5-28	• Black, oil-tempered wire	1-1/4"	1-1/2"
S5-30	• Overall length 8"	2"	2-1/4"
S5-31	• Brush length 4-1/2"	2-1/2"	2-3/4"
S5-32	• 1/4" npt connection	3"	3-1/4"
S5-34		4"	4-1/2"



S5-28M, -30M, -31M, -32M, -34M

OIL HEAT SERVICE

Clean-Fit Brushes and Extension Rods CONTINUED

For use in oil heat refrigeration and plumbing service and for general cleaning.

DOUBLE SPIRAL WIRE AND BOILER TUBE BRUSHES

Part #	Features	Brush Dia.	Flue Dia.
S5-36	• Overall length 8"	1"	1-1/4"
S5-38	• Brush length 4-1/2"	1-1/2"	1-3/4"
S5-40	• 1/4" npt connection	2"	2-1/4"
S5-42		3"	3-1/4"
S5-44		4"	4-1/4"



S5-36M, -38M, -40M, -42M, -44M

FLAT FINE WIRE BAFFLE BRUSHES

Part #	Features	Size
S5-12	• 5/16-18 int'l. thread	3/8" x 1"
S5-14	• 1/8" npt connection	1/2" x 2"



S5-12M, S5-14M

OVAL FINE FLUE BRUSHES

S5-6	• Brush length 4-1/2"	2" x 4"
S5-8	• 1/4" npt connection	2-1/2" x 4-1/2"



S5-6M, S5-8M, S5-10M

COUNTER DUSTERS BRUSHES

S5-126	<ul style="list-style-type: none"> • For general light brushing or cleaning • Beaver tail lacquered handle • Tampico fiber 	3" W x 13" L x 2-1/2" trim
--------	---	----------------------------

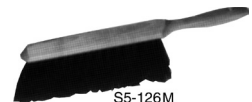

S5-126M

LONG HANDLED UTILITY SCRUB BRUSHES

S5-122	<ul style="list-style-type: none"> • 20" overall length • Plastic base • Nylon fill • Fill material is staple set 	2-1/4" trim
--------	---	-------------



S5-126M

PROFESSIONAL PLUMBING/REFRIGERATION FITTING BRUSHES

T723-40	• Double stem, single spiral construction	1/8" id x 1/4" od
T723-41		1/4" id x 3/8" od
T723-42	• Heavy gauge, galvanized stem wire secured in a large contoured handle	3/8" id x 1/2" od
T723-43		1/2" id x 5/8" od
T723-44		5/8" id x 3/4" od
T723-45	• Spring-tempered stainless steel fill bristles to prevent rust	3/4" id x 7/8" od
T723-46		1" id x 1-1/8" od
T723-47		1-1/4" id x 1-3/8" od



T723-40M, -41M, -42M, -43M, -44M, -45M, -46M, -47M

CHIMNEY BRUSHES

S5-59	• 3/8" npt conn.	6" round
S5-59B		8" round



S5-59M, S5-59BM

OIL HEAT SERVICE

Flow Control 3/K-2

Oil De-Aerator

Separating air from Oil-Outperforms all other oil De-Aerators.

FEATURES:

- Simplifies Installation - no return line to the tank.
- Reduces installation cost - 1-stage pump does the work of a 2-stage pump.
- Reduces service calls - eliminates nuisance air leaks and call backs.
- Extends oil filter life - only the oil that goes through the nozzle is filtered.
- 5 year warranty.
- Helps resolve cold oil combustion problems
- Superior flow characteristics over competitive de-aerators.
- 3 Floats – 2 chambers double seals the units
- Mounts close to the burner.
- **BIO RATING OF B100.**

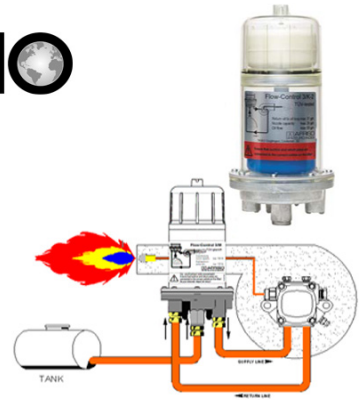

Part #	Nozzle Capacity	Return Oil	Oil Flow	Operating Temp.	Ambient Temp.	Feed Line Operating Pressure	Pump/Tank Connection
P131-35M	26 GPH	37 GPH	58 GPH	140°F max.	140°F max.	10 PSI	1/4" NPT

Flexible Oil Lines

Mitco's flex lines are composed of a perbunan liner inside a braid of Galvanized soft steel. It simplifies the installation of oil components.

FEATURES:

- Max temperature 212°F
- Operating pressure 145 psi
- **BIO RATING OF B20**



Part#	Length	Connectors
P131-18M	24"	1/4" NPT Male x 1/4" NPT Male
P131-18FM	24"	3/8" Female Flare x Female Flare
P131-19M	36"	1/4" NPT Male x NPT Male
P131-19FM	36"	3/8" Female Flare x Female Flare
P131-28M	36"	3/8" x 1/4" NPT Male

Oil Safety Valves

FEATURES:

- Operated by fuel pump pressure.
- Prevents fuel flow in the event of a line break or when the unit is shut idle.
- Prevents fuel from puddling in chamber, causing smokey start ups, puff back and possible fires.



Guard against spills and siphoning

Part#	Mfr	Mounting Connections	Mfr#
P131-31M	Suntec	Any location, max 3" above lowest point in system, 3/8" NPT	PRV38

OIL HEAT SERVICE

Oil Burner Nozzles

Mitco Mfg. stocks and offers for sale an extensive selection of Delavan nozzles.



FEATURES:

- Individually packaged in sturdy plastic vials.
- Vials are color coded and stamped for easy identification.

Nozzle Extractors



Part #	Description
94-1	Barrel snaps off for removal from flame retention head.

Copper Nozzle Lines

Replacement oil lines for oil burners.

FEATURES:

- Flared copper with nuts.



Part #	Size
P127-5M	3/16" x 16"
P127-5AM	3/16" x 5"
P127-5BM	3/16" x 12"
P127-6M	1/4" x 16"
P127-6BM	1/4" x 12"
P127-7M	3/16" x 8"

Beckett Nozzle Lines

Copper line with hydraulic double flare fitting.



Part#	Size
5636M	6.5"
5394M	8"
5628M	9.5"
51127U	11"

In-Line Nozzle Filters



Part#
87-1

Nozzle Fittings for Beckett AF Series Burners



Part #	Description
P127-12M	Fitting only
P127-13M	Fitting for 3488-AFG Model Series
P127-14M	Fitting with 16" tubing

Delevan Flame Mirrors



Part#	Size	With handle
90	Rectangular mirror 1-15/16"	Yes
90-1	Rectangular mirror Only	No
90-2	Mini-mirror w/handle	Yes
90-3	Mini-mirror only	No

Beckett Silent-Flo™ Line Noise Dampener

Inserts in the return line of a two pipe system at the pump connection or in the suction line of a single pipe system. Immediately reduces noise.

Part#
480-10

Nozzle Adapters

FEATURES:

- Precision machined.
- Solid brass.



Part #	Size	Pkg Qty.
80M	2-1/16" x 1/8" FPT	1
80-1M	2-1/16" x 1/4" FPT	1
81M	1-3/8" x 1/8" FPT	6
81-1M	1-3/8" x 1/4" FPT	3
82M	7/8" x 1/8" FPT	1
82-1M	7/8" x 1/4" FPT	1

OIL HEAT SERVICE

Kwik Couple Oil Burner Couplings



Universal replacement 3-piece coupling with high density plastic end pieces.

FEATURES:

- Requires no set screws, ends slide on shaft.
- Flexible center piece is self aligning and may be easily cut with a knife.

KWIK COUPLER KITS

Part #	Description
146M	5" Coupling Kit
146-1M	6" Economy Pak
146-2M	12" Coupling Kit
148-6M	6" Coupling Kit

REPLACEMENT PARTS

146-30M	30" center piece
148-8M	1/2" end piece, black
148-9M	7/16" end piece, blue
148-10M	5/16" end piece, red
148-50M	5" center piece
148-60M	6" center piece
148-70M	12" center piece

EXACT REPLACEMENT COUPLINGS

155-5M	Beckett AF
155-6M	Beckett SR
175M	Carlin 100CRD
198M	Wayne MSR

OIL HEAT SERVICE

Combustion Chamber Products

Part #	Lynn Model #	Application/Features	Size	Pkg Qty.
633-95	1019	COMBUSTION CHAMBER BOARD • For floors, walls, front plate or target installation	20" x 20" x 1"	2
633-60	1030	BURNER HEAD PROTECTOR • Use to protect against high flame temperatures. • Useful as a sizing aid. • Fits 4" o.d. burner heads, Beckett and others.	up to 4" o.d.	1
633-90	9500	KAOWOOL STRIPS • Use as gasket material and end cone protection.	150" x 2" x 1"	1

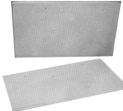

COMBUSTION CHAMBER BOARD

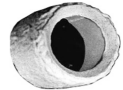

BURNER HEAD PROTECTOR

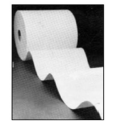

KAOWOOL STRIP

Kaowool Dry Combustion Blankets

A soft ceramic blanket that can be formed to the shape of an existing chamber. For applications where protection is required against high temperatures such as lining steel and hard brick chambers.

FEATURES:

- Can withstand temperatures up to 2300°F.
- Kaowool construction for safety - contains no asbestos.



Part #	Dimensions	Lynn Model#
633-68	56" x 14" x 3/4"	9450
633-67	48" x 16" x 1/2"	9451
633-69	60" x 24" x 1/4"	9452

Hole Plugs

Part #	Lynn Model #	Application/Features	Size	Pkg Qty.
633-98	6010	For plugging test holes in flue pipe	5/16"	100

OIL HEAT SERVICE

Golden Glo Wet Combustion Blankets

A soft, moist fiber blanket that can be formed to the shape of an existing chamber and used as a liner.

FEATURES:

- High temperature ceramic fiber construction. Non-freezing.
- Kaowool construction for safety - contains no asbestos.
- Formed and packaged wet - hardens when burner is fired.



Part #	Pkg Qty.	Dimensions	Lynn Model#
628-20	1	'A' KIT 14" x 48" x 1/2"	1032
628-21	1	'B' KIT 14" x 48" x 1/2" 16" x 16" x 1/2"	1033
628-22	1	'C' KIT 16" x 48" x 1/2" 16" x 16" x 1/2"	1034
628-16	1	INDIVIDUAL BLANKET 36" x 24" x 1/2"	1035
628-17	1	INDIVIDUAL BLANKET 36" x 18" x 1/2"	1036

Filter Pads for Miller Furnaces

Washable foam media pads sized for popular models of Miller furnaces. Easily cut to size for other applications.

Part #	Dimensions	Pkg Qty.
L17-140M	15-34" x 17-3/4" x 1/4"	25
L17-142M	15-34" x 26-3/4" x 1/4"	25

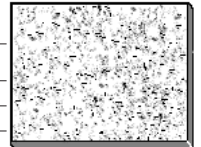

Gaskets for Miller Furnaces

REPLACEMENT GASKETS FOR MILLER MOBILE HOME FURNACES

Part #	Miller Model#	Description	Pkg Qty.
650-55M	301195000	Flue gasket 7-1/16" o.d. x 5-1/8" i.d.	20
650-60M	3001000	Burner gasket 6-1/2" o.d. x 4-3/8" i.d.	20
650-65M	301181000	Pouch gasket 10" x 13-1/2"	20
650-70M	301205000	Burner plate gasket 10-1/2" x 16"	20
650-75M		Gasket kit with one each of gasket listed above	4

OIL HEAT SERVICE

Clean out Gaskets for York and ICP Furnaces

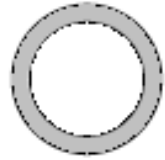

INTERNATIONAL COMFORT PRODUCTS

Part #	Description	Pkg Qty.
650-82M	(Acroaire, Heil, Tempstar brands) furnace gasket 1149103	6
650-82BM	(Acroaire, Heil, Tempstar brands) furnace gasket 1149103	25

YORK

650-80M	028-1070900	6
650-80BM	028-10709000	25

THERMOPRIDE

650-83M	Clean-out gasket	6
650-83BM	Clean-out gasket, bulk pack	25

Ignition Buss Bars



Part #	Description
T386M	12" length - Round
T386-4M	12" length - Flat

Ignition Leads

Package of 2.



Part #	Description
T386-20M	12" - Ring-Cage
T386-21M	12" - Cage-Cage
T386-26M	18" - Ring-Cage
T386-27M	18" - Cage-Cage
T386-32M	24" - Ring-Cage
T386-33M	24" - Cage-Cage

Transformer Gasket Kit

When properly installed, this gasket kit will maintain a "seal tight fit" recommended for AFG style burners. This kit can be used with most name brand replacement transformers. Includes: 1 perimeter body gasket, 1 bridge gasket.

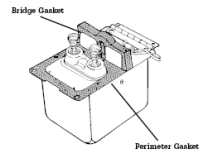

Part

T92-2M

Universal Cleanout Plug



Part #	Description	Pkg Qty.
T397-95M	Universal furnace clean out plug and gasket	1
T397-96M	Thermopride cleanout cover bracket less plug	1

OIL HEAT SERVICE

Oil Burner Porcelains and Igniters

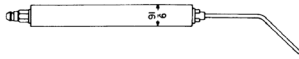

DIAGRAM - A
LARGE BORE

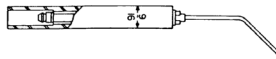

DIAGRAM - B
LARGE BORE

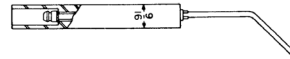

DIAGRAM - C
SMALL BORE

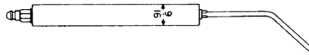

DIAGRAM - D
SMALL BORE

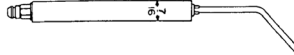

DIAGRAM - E
SMALL BORE

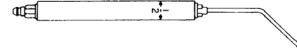

DIAGRAM - F
SMALL BORE

Part #	Porcelain Only	Type	Porcelain Diameter	Porcelain Length	Bore Diameter	Tip Length	Dia.
300-1M		Male	9/16"	4"	3/16"	2-5/8"	A
301-1M		Male	9/16"	4-1/2"	3/16"	2-5/8"	A
302-1M		Male	9/16"	4-3/4"	3/16"	- - -	A
303-1M		Male	9/16"	5"	3/16"	2-5/8"	A
305-1M		Male	9/16"	6"	3/16"	2-5/8"	A
307-1M		Male	9/16"	7"	3/16"	2-5/8"	A
308-1M		Female	9/16"	4"	3/16"	2-5/8"	B
309-1M		Female	9/16"	4-1/2"	3/16"	2-5/8"	B
310-1M		Female	9/16"	5"	3/16"	2-5/8"	B
311-1M		Female	9/16"	6"	3/16"	- - -	B
312-1M		Female	9/16"	7"	3/16"	2-5/8"	B
312-6M		Female	9/16"	4"	1/8"	2-5/8"	C
312-8M		Female	9/16"	4-1/2"	1/8"	2-5/8"	C
312-10M		Female	9/16"	5"	1/8"	2-5/8"	C
312-12M		Female	9/16"	5-1/2"	1/8"	- - -	C
312-14M		Female	9/16"	6"	1/8"	2-5/8"	C
312-16M		Female	9/16"	7"	1/8"	2-5/8"	C
312-18M		Female	9/16"	8"	1/8"	- - -	C
312-26M		Male	9/16"	4"	1/8"	2-5/8"	D
312-28M		Male	9/16"	4-1/2"	1/8"	2-5/8"	D
312-30M		Male	9/16"	5"	1/8"	2-5/8"	D
312-32M		Male	9/16"	5-1/2"	1/8"	2-5/8"	D
312-34M		Male	9/16"	6"	1/8"	2-5/8"	D
312-36M		Male	9/16"	7"	1/8"	2-5/8"	D
312-38M		Male	9/16"	8"	1/8"	2-5/8"	D
312-50M		Male	7/16"	4"	1/8"	- - -	E
313-1M		Male	7/16"	4-1/4"	1/8"	2-3/4"	E
314-1M		Male	7/16"	4-1/2"	1/8"	- - -	E
315-1M		Male	7/16"	4-3/4"	1/8"	- - -	E
316-1M		Male	7/16"	6"	1/8"	2-3/4"	E
317-1M		Male	1/2"	4"	1/8"	2-5/8"	F
318-1M		Male	1/2"	5"	1/8"	2-5/8"	F
319-1M		Male	1/2"	6"	1/8"	2-5/8"	F

OIL HEAT SERVICE

OEM Replacement Oil Burner Porcelains and Igniters

Part #	OEM	Porcelain Diam.		
320M	Ace	9/16"		
323-1M	Aero water heater and Carlin burner	7/16"		
323-2M	Aero water heater and Carlin burner	9/16"		
325-3M	ABC	9/16"		
325-4M	ABC	9/16"		
326M	ABC	9/16"		
326-1M	ABC	7/16"		
328M	Arcoflame	9/16"		
328-3M	Arcoflame C	9/16"		
329M	Arcoflame MF	9/16"		
329-1M	Arcoflame B-1	9/16"		
329-2M	Armstrong	9/16"		
330M	Beckett	9/16"		
330-1M	Beckett	9/16"		
330-2M	Beckett AFG	9/16"		
330-3M	Beckett	9/16"		
330-4M	Beckett SR	9/16"		
330-6M	Beckett	9/16"		
330-7M	Beckett	9/16"		
330-8M	Beckett	7/16"		
331M	Beckett	9/16"		
331-3M	Bettendorf	9/16"		
331-1M	Bettendorf	7/16"		
332M	Caloroil	9/16"		
332-1M	Caloroil	9/16"		
332-3M	Carlin	9/16"		
332-4M	Carlin	9/16"		
332-5M	Carlin	9/16"		
332-6M	Carlin	7/16"		
332-7M	Carlin	9/16"		
332-10M	Carlin left hand, right hand	9/16"		
82768S	Carlin Electrode	5" Long		
82776S	Carlin Electrode	7" Long		
82784S	Carlin Electrode	9" Long		
82792S	Carlin Electrode	11" Long		
332-1M	Delco	9/16"		
360-8M	Iron Fireman	9/16"		
360-9M	Iron Fireman	9/16"		
361-5M	Lennox	9/16"		
364-6M	Miller Mobile Home left hand, right hand	7/16"		

CONTINUED

OIL HEAT SERVICE

OEM Replacement Oil Burner Porcelains and Igniters

Part #	OEM	Porcelain Diam.
365-8M	National Radiator	9/16"
366M	Nu-Way	7/16"
366-1M	Nu-Way	9/16"
366-7M	Nu-Way	7/16"
367M	Nu-Way	7/16"
369M	Nu-Way	1/2"
380M	Quiet Heet	7/16"
385M	Shell Head	9/16"
385-1M	Shell Head	9/16"
385-2M	Shell Head	9/16"
404M	Wayne	9/16"
404-1M	Wayne	1/2"
404-2M	Wayne Blue Angel	7/16"
404-3M	Wayne	1/2"
404-4M	Wayne	1/2"
404-5SM	Wayne left hand, right hand	1/2"
404-9M	Wayne left hand, right hand	1/2"
409-2M	York left hand, right hand	9/16"
411M	Sun Ray	9/16"
411-1M	Sun Ray	9/16"
411-2M	Sun Ray	9/16"
411-3M	Sun Ray	9/16"
411-4M	Sun Ray	9/16"
414M	Weil-McLain double	7/16"

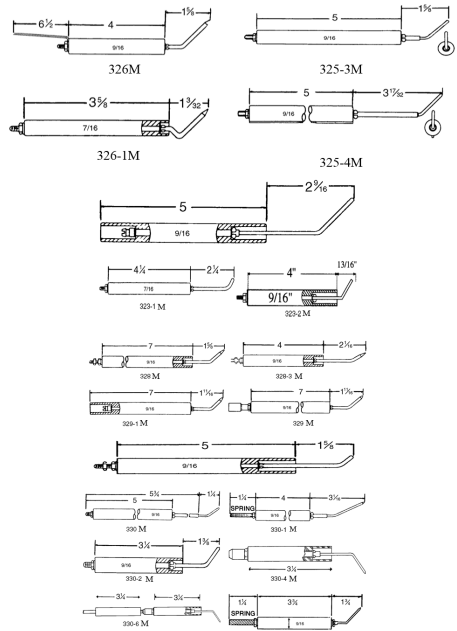

Beckett Universal Electrode Kits

Part #	OEM
5780M	Beckett Electrode Kit



King Tank Fill Alarm

FEATURES:

- Easy to read and accurate.
- Cast in durable grey iron with corrosion resistant finish.
- 'R' type whistle.

Part #	Stem Depth	Color
532	5-1/4"	Tan
532-1	5-1/4"	Red
532-2	9-3/4"	Green
532-4	5-1/4"	Blue



OIL HEAT SERVICE

King Tank Fill Alarm and Tank Gauge Combinations

2" x 2" Male/Female. For basement or above ground tanks.

FEATURES:

- Air tight construction won't leak when air-tested to meet local codes.
- Installation is quick and easy, even in empty or partially filled tanks or tight spots.
- Durable grey iron with corrosion resistant powder coating.
- 'R' type whistle.



Part #	Tank Size	Tank Position	Color	Size (Bottom) Male x Female
535-1	42"-44"	Vertical	Orange	1-1/2" x 1-1/4"
535-3	42"-44"	Vertical	Red	2" x 1-1/4"
535-5	42"-44"	Vertical	Blue	2" x 2"
535	26"-27"	Horizontal	Orange	1-1/2" x 1-1/4"
535-2	26"-27"	Horizontal	Red	2" x 1-1/4"
535-6	26"-27"	Horizontal	Blue	2" x 2"

Oil Fill Caps

Flush type. Recessed cover on on-locking cap is ideal for flush installation in floors and driveways.

FEATURES:

- Seals tightly, yet is easy to open.
- Solid brass construction.
- Thick leather gasket maintains water tight seal.
- Rust resistant.



Part #	Size
430-1	2" - Female

Econ-O-Gauge® Level Indicators

FEATURES:

- Leak-proof construction with non-rusting zinc casting
- Dual bushing fits both 1-1/2 & 2" tanks holes

Part #	Tank Depth
575-11	26"-27"
575-10	42"-44"

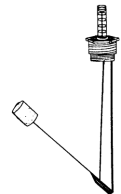

OIL HEAT SERVICE

TANK GAUGE CHART

275 GALLON 44" x 27" x 60" VERTICAL		275 GALLON 44" x 27" x 60" HORIZONTAL		285 GALLON 38" x 60"		550 GALLON 48" x 72"		1,000 GALLON 48" x 128"	
Inches	Gallons	Inches	Gallons	Inches	Gallons	Inches	Gallons	Inches	Gallons
2	5	2	14	1	3	1	3	1	5
4	14	4	32	2	6	2	8	2	14
6	25	6	51	3	11	3	15	3	26
8	37	8	73	4	17	4	22	4	40
10	50	10	96	5	23	5	31	5	55
12	65	12	118	6	30	6	41	6	72
14	79	14	146	7	37	7	51	7	91
16	93	16	169	8	45	8	62	8	110
18	107	18	191	9	53	9	73	9	130
20	122	20	213	10	62	10	85	10	151
22	136	22	235	11	71	11	97	11	173
24	150	24	253	12	80	12	110	12	196
26	164	26	275	13	89	13	123	13	219
28	178			14	99	14	137	14	243
30	193			15	108	15	151	15	267
32	207			16	118	16	165	16	292
34	221			17	128	17	179	17	317
36	234			18	137	18	193	18	343
38	246			19	147	19	208	19	369
40	258			20	157	20	222	20	395
42	268			21	167	21	237	21	421
44	275			22	177	22	252	22	447
				23	186	23	267	23	474
				24	196	24	282	24	501
				25	206	25	297	25	528
				26	215	26	312	26	555
				27	224	27	327	27	581
				28	233	28	342	28	607
				29	241	29	356	29	633
				30	249	30	371	30	659
				31	257	31	385	31	685
				32	265	32	399	32	710
				33	272	33	413	33	735
				34	278	34	427	34	759
				35	284	35	441	35	783
				36	289	36	454	36	806
				37	292	37	467	37	829
				38	295	38	479	38	851
						39	491	39	872
						40	502	40	892
						41	513	41	911
						42	523	42	930
						43	533	43	947
						44	542	44	962
						45	549	45	976
						46	556	46	988
						47	561	47	997
						48	564	48	1002

Fluid Level String Gauges

Universal, mechanical level gauge for measuring levels in fuel oil tanks.

FEATURES:

- Interchangeable scale faces for 24" and 42" fluid heights (275 gal. tanks) for use with a wide variety of fuel oil storage tanks.
- 2" NPT threads.
- Easy-to-read dial face.
- Highly reliable.
- Made of ABS plastic with epicyclic gear set and nylon cord for added durability.



Part

577M

OIL HEAT SERVICE

Universal Floating Suction Line

The KLEEN-FLO floating suction line utilizes only the upper oil level, reducing nozzle and filter performance problems caused by contaminants in the tank. The bottom of storage tanks are notorious for contamination. The KLEEN-FLO is particularly effective during oil tank fill-ups, when the oil supply is most vulnerable to contamination as new fuel is added, stirring up bottom sediment.



BIO

FEATURES:

- Fits any tank, vertical or horizontal
- Significantly reduces filter and nozzle clogging
- Standard 2" threaded connection
- Ideal for single or two pipe systems
- Stainless clamps and fittings for durability
- Made to last – fabricated from high quality, non-corrosive materials. The float and tubing are oil-resistant and B20 rated
- Tubing rated to 1000 PSI

Part#

578M

Humidifier Pads

Replacement evaporator pads for many popular humidifier models.

Part #	Replaces
L26M	Montgomery 20 Skuttle 90, H100, 100
L26-80M	Vista 710 Research Products 10RR Adams MFG. AWP-1, 10RR, 110, 220 Chippewa 220
L26-82M	Adam MFG. AWP-2, 12RR, 112, 136, 440, 445 Chippewa 224, 225 Research Products 12RR Vista 712
L27-4M	Autoflo 0-40, 250, 40EP Leigh 224, 225, 1100 Little Giant LGH, PB-S1, SP P-1 Vista 717
L27-10M	Autoflo 97EP (model 97)
L27-14M	Autoflo 200P, 200PR, 800BP, 800 BPR
L29-22M	Trion 1220
L29-27M	Herrmidifier 2024 (model 2000)
L31-20M	Montgomery Ward 12 Skuttle 45
L32M	Lau/Conaire 411069-06 Vapor-Air 8, 14
L32-2M	Lau/Conaire 410510-06 Vapor-Air 2, 5, 18, 4300
L32-8M	Lobb WA-2

OIL HEAT SERVICE

Clean-Fit Brushes and Extension Rods

For use in oil heat refrigeration and plumbing service and for general cleaning.



HARD SPIRAL FLUE BRUSHES

Part #	Features	Size
S5-47	• Stiff, flat wire tube brush	2" od
S5-47B	• 1/4" npt connection.	3" od

100 % HORSEHAIR RADIATOR BRUSH

S5-108	• 24" long overall • Hardwood handle	9" L, 1 row
--------	---	-------------

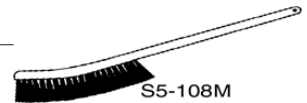

SPIRAL HORSEHAIR RADIATOR BRUSHES

S5-70	• Single spiral	2" dia. x 27" L
S5-74	• 6" fill	2" dia. x 42" L
S5-72		3" dia. x 27" L
S5-76		3" dia. x 42" L

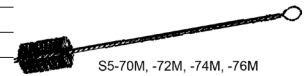

SPIRAL FIBER FILL RADIATOR BRUSHES

S5-62	• Single spiral	2" dia. x 27" L
S5-64	• 6" fill	2" dia. x 42" L
S5-66		3" dia. x 27" L
S5-68		3" dia. x 42" L

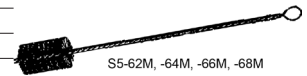

SPIRAL WIRE RADIATOR BRUSHES

S5-79	• 3" brush length	1/2" dia x 42" L.
S5-79A	• 4" loop handles for hanging	3/4" dia. x 42" L
S5-79B	• Labels on handles	1" dia. x 42" L
S5-78	• with individual IPC	1-1/2" dia. x 42" L
S5-80	identification.	2" dia. x 42" L
S5-81	• Carbon steel handles.	2-1/2" dia. x 42" L
S5-82		3" dia. x 42" L

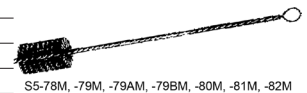

FAN BRUSHES

S5-102		3/8" dia. x 9" L
S5-104		1/2" dia. x 9" L
S5-100		3/4" dia. x 9" L
S5-100A		3/4" dia. x 30" L

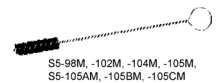

OIL HEAT SERVICE

Clean-Fit Brushes and Extension Rods CONTINUED

For use in oil heat refrigeration and plumbing service and for general cleaning.

GAUGE GLASS BRUSHES

Part #	Features	Size
S5-98		1/2" dia. x 24" L
S5-105B		1/2" dia. x 36" L
S5-105A		1/2" dia. x 18" L
S5-105C		3/4" dia. x 9" L
S5-100B		1-1/2" dia. x 36" L
S5-100C		2-1/4" dia. x 36" L

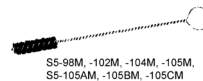

S5-98M, -102M, -104M, -105M,
S5-105AM, -105BM, -105CM

ACID OR DOPE APPLICATOR BRUSHES

T723-35	<ul style="list-style-type: none"> • 100% horsehair • Tin plated handle 	3/8" bristle x 5-7/8" handle
---------	---	---------------------------------

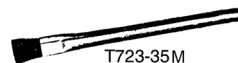

T723-35M

FINE WIRE WIPER BRUSHES

S5-90	• 3" brush length	1/2" dia. x 16" L
S5-92	• Loop handles for hanging	5/8" dia. x 16" L
S5-94	• Stainless steel handle	3/4" dia. x 18" L
S5-96	(unless noted) • Labels on handles with individual IPC identification *Carbon steel handle	1" dia. x 18" L



S5-90M, -92M, -94M, -96M

HAND WIRE SCRATCH BRUSHES

S5-110	• Hardwood handles and backs	14" x 1" B, 3 x 19 R, 1-3/16" T
S5-110A	B = block size R = row configuration T = trim size	14" x 1-1/8" B, 4 x 18 R, 1-3/16" T



S5-110M, S5-110AM

DUSTER HAND WIRE SCRATCH BRUSHES

S5-112	• Hardwood handles and backs	2-3/4" x 1-1/8" block, 4" x 8" rows, 2-3/8" trim size
--------	---------------------------------	---



S5-112M

SHOE HANDLE HAND WIRE SCRATCH BRUSHES

S5-115	• Hardwood handles and backs B = block size R = row configuration T = trim size	10" x 1-1/8" B, 4 x 16 R, 1-3/16" T
--------	--	--



S5-115M

REFRIGERATION/RADIATOR BRUSHES

S5-88	• Horsehair	1-7/8" x 1-1/8" x 42" L
S5-88A		1/2" - 1" taper, 21" L

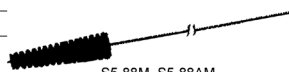

S5-88M, S5-88AM

OIL HEAT SERVICE

Clean-Fit Brushes and Extension Rods CONTINUED

For use in oil heat refrigeration and plumbing service and for general cleaning.

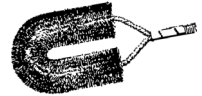

S5M, S5-2M

U BRUSHES - DOUBLE STEM, HORSESHOE SHAPE

Part #	Features	Size
S5	• Oil-tempered wire	1-1/2" dia. x 4" fill x 5" L
S5-2	• 1/4" npt connection	2" dia. x 4-1/2" fill x 5" L

FIBERGLASS EXTENSION RODS FOR FLUE, BOILER AND CHIMNEY CLEANING BRUSHES

S5-46	• Standard rods have 1/4" npt	1/4" npt x 3 ft. L
S5-48	self-connect and .34" dia.	1/4" npt x 4 ft. L
S5-52	extension rod	1/4" npt x 6 ft. L
S5-51	• Heavy duty rods have 3/8"	3/8" npt x 4 ft. L
S5-51B	extension rod	3/8" npt x 6 ft. L

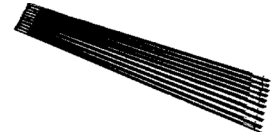

S5-46M, -48M, -51M, -51AM, -51BM, 52M

WEIL-McLAIN BOILER BRUSHES

S5-86	• Twisted-in handle	1-1/2" x 1-1/8", 30" L heavy duty
S5-86A	• Horsehair	1-1/2" x 1-1/8", 30" L lite duty

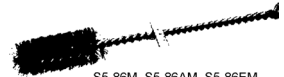

S5-86M, S5-86AM, S5-86EM

COLUMBIA BOILER BRUSHES

S5-84	• Flat brush	1/2" x 1", 48" L
S5-84A		1/2" x 1", 27" L

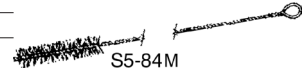

S5-84M

SLANT/FIN BOILER BRUSHES

S5-87	• Tapered	0" to 2-1/4" taper, 20" L
-------	-----------	---------------------------

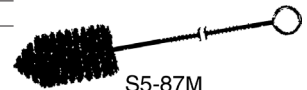

S5-87M

CONDENSER TUBE AND HEAT EXCHANGER BRUSHES

S5-19	• 4-1/2" brush length	1/2" dia. x 7-1/2" L
S5-20	• High carbon steel wire	5/8" dia. x 7-1/2" L
S5-22	• 1/8 npt outside • 5/16"-18 in.. thread • Shank length 2" • Individually boxed with UPC and sizes clearly indicated	3/4" dia. x 7-1/2" L



S5-19M, S5-20M, S5-22M

SINGLE SPIRAL WIRE FLUE AND BOILER TUBE BRUSHES

S5-28	• Black, oil-tempered wire	1-1/4"	1-1/2"
S5-30	• Overall length 8"	2"	2-1/4"
S5-31	• Brush length 4-1/2"	2-1/2"	2-3/4"
S5-32	• 1/4" npt connection	3"	3-1/4"
S5-34		4"	4-1/2"



S5-28M, -30M, -31M, -32M, -34M

OIL HEAT SERVICE

Clean-Fit Brushes and Extension Rods CONTINUED

For use in oil heat refrigeration and plumbing service and for general cleaning.

DOUBLE SPIRAL WIRE AND BOILER TUBE BRUSHES

Part #	Features	Brush Dia.	Flue Dia.
S5-36	• Overall length 8"	1"	1-1/4"
S5-38	• Brush length 4-1/2"	1-1/2"	1-3/4"
S5-40	• 1/4" npt connection	2"	2-1/4"
S5-42		3"	3-1/4"
S5-44		4"	4-1/4"



S5-36M, -38M, -40M, -42M, -44M

FLAT FINE WIRE BAFFLE BRUSHES

Part #	Features	Size
S5-12	• 5/16-18 int'l. thread	3/8" x 1"
S5-14	• 1/8" npt connection	1/2" x 2"



S5-12M, S5-14M

OVAL FINE FLUE BRUSHES

S5-6	• Brush length 4-1/2"	2" x 4"
S5-8	• 1/4" npt connection	2-1/2" x 4-1/2"



S5-6M, S5-8M, S5-10M

COUNTER DUSTERS BRUSHES

S5-126	<ul style="list-style-type: none"> • For general light brushing or cleaning • Beaver tail lacquered handle • Tampico fiber 	3" W x 13" L x 2-1/2" trim
--------	---	----------------------------

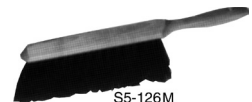

S5-126M

LONG HANDLED UTILITY SCRUB BRUSHES

S5-122	<ul style="list-style-type: none"> • 20" overall length • Plastic base • Nylon fill • Fill material is staple set 	2-1/4" trim
--------	---	-------------



S5-126M

PROFESSIONAL PLUMBING/REFRIGERATION FITTING BRUSHES

T723-40	• Double stem, single spiral construction	1/8" id x 1/4" od
T723-41		1/4" id x 3/8" od
T723-42	• Heavy gauge, galvanized stem wire secured in a large contoured handle	3/8" id x 1/2" od
T723-43		1/2" id x 5/8" od
T723-44		5/8" id x 3/4" od
T723-45	• Spring-tempered stainless steel fill bristles to prevent rust	3/4" id x 7/8" od
T723-46		1" id x 1-1/8" od
T723-47		1-1/4" id x 1-3/8" od



T723-40M, -41M, -42M, -43M, -44M, -45M, -46M, -47M

CHIMNEY BRUSHES

S5-59	• 3/8" npt conn.	6" round
S5-59B		8" round



S5-59M, S5-59BM

PUMPS

Central Oil Supply Systems

A simple and practical oil supply system for single or multiple burners located in suspended heating equipment.

FEATURES:

- **Simple** - Pumping is direct, with no bypass, stand pipes, or regulating valves. Makes troubleshooting easy.
- **Inexpensive** - Comes complete with all fittings needed for a fast and neat installation.

Part #	Description
P239-1M	Supply Pumper complete, 24 gph, 1/4 HP, 1725 rpm
P239-2M	Pump only, 24 gph
P239-9M	Pump and motor set for 24 gph model
P239-10M	Vent
P239-11M	Oil supply switch
P239-14M	Tank and fittings
P239-15M	Check valve assembly
P239-16M	Hanger strap
P239-17M	Mounting plate

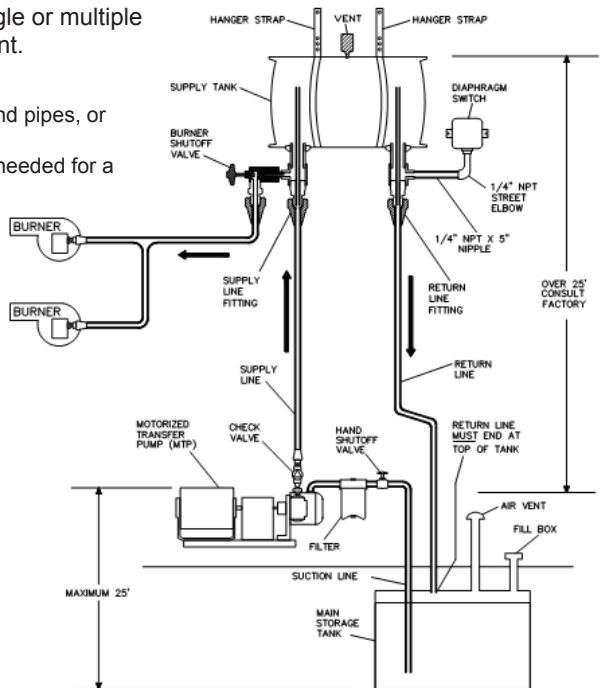

Transfer Pumps

Suitable for light or heavy oil. Other capacities, with or without regulating valve, available on request.

FEATURES:

- 300 psi maximum discharge pressure.
- 115 volt.
- 1/2-14 taps, inlet and outlet.

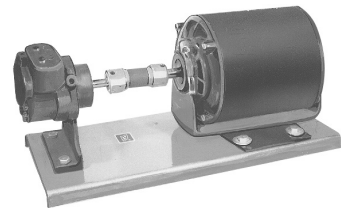

TRANSFER PUMPS COMPLETE WITH MOTOR

Part #	Capacity	Pump	HP	Pipe	Part#	Pump Only
P238M	60 gph	Tuthill 00L	1/4	1/2 - 14 tap inlet and outlet	P99-5M	00L
P238-1M	180 gph	Tuthill 0L	1/4	1/2 - 14 tap inlet and outlet	P99-6M	0L
P238-2M	192 gph	Tuthill 1L	1/3	1/2 - 14 tap inlet and outlet	P99-7M	1L E
P238-3M	372 gph	Tuthill 2L	1/2	1/2 - 14 tap inlet and outlet	P99-8M	2L E

PUMPS

Portable Pump Sets

For use with oil, water and mild chemicals. Ideal for pumping out boilers, tanks, flooded basements or pools.

NOTE: Do not use to pump gasoline or other combustible, explosive or volatile substances.

FEATURES for P9M:

- **Motor:** 1/3 HP, 1725 RPM. Continuous duty capacitor type.
- **Pump:** All bronze pump and bronze gear set.

FEATURES for P9-10M:

- **Motor:** 3/4 HP, 115 volt, 1725 RPM. Provides higher starting torque for faster lift. Continuous duty capacitor type.
- **Pump:** Bronze pump with oil resistant Nitrile rubber impeller. Outboard ball bearing permanently lubricated for longer service life.
- **Connections:** Top mounted, vertical suction ports hold more prime, eliminating constant dry starts which cause excessive impeller wear. 3/4" FPT with garden hose fitting.
- **General Performance:** 750 GPH at 5 to 10 lb. pressure. As pressure increases, GPH drops off. This unit is not recommended for service requiring more than 20 pounds pressure. Temperature range 10° to 140° F. Will prime from 10 feet when dry or from 20 feet with liquid in the pump.



P9-10M

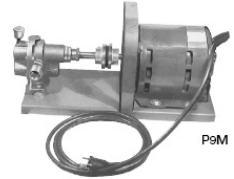

P9M

STANDARD MODEL

Part #	Capacity @ 20' Lift	Pump Construction	Motor Specifications
P9M	480 gph	All bronze pump and gears	1/3 HP, 1725 RPM, continuous duty

FLEXIBLE IMPELLER MODEL

P9-10M	750 gph	All bronze pump with nitrile impeller	3/4 HP, 1725 RPM, continuous duty
--------	---------	---------------------------------------	-----------------------------------

REPLACEMENT PARTS

Part #	Description	Pkg Qty.
P9-10PM	Replacement pump for P9-10M w/nitrile impeller	1
P9-11M	Replacement nitrile impeller for P9-10PM	1
P9-11GM	Gasket for P9-10PM	1
P9-18M	2-1/4" Orange Impeller Kit	1
P9-1M	Replacement bronze pump for P9M	1
P9-2M	Hose adapter	6
P9-3M	Coupling	2

PUMPS

Strainers for Suntec Pumps

Exact replacement for Suntec models

FEATURES:

- Non-rusting stainless steel mesh
- Durable Nylon ends
- Ribbed design for greater strength and capacity
- Packaged with cover gasket.



Part #	Use with Suntec	Packaging	Pkg Qty.
P193M	H, J	Individual	5 each
P193-3M	*A70	3-pak	3
P193-3AM	A70	Individual box	50
P193-3BAGM	A70	Individual	100
P193 BAGM	H, J, K	Individual bag	100
P193-6M	B-series, 1-3/8" length B-Pump	3-pak	3
P193-6BM	B-series, 1-3/8" length B-Pump	Individual bag	20
P193-9M	1-5/8" length pumps	3-pak	3
P193-9BM	1-5/8" length pumps	Individual bag	20

Strainers for Reillo Pumps

Part #	Use with Reillo	Replacement for	Packaging	Pkg Qty.
P193-126GM	F3 - F20 Mectron Series	Reillo # 3005719, SSC-12G	Individual box with O-ring (#R64M) and (R64AM)	1



Strainers for Danfoss Pumps

Part #	Use with Danfoss	Replacement for	Packaging	Pkg Qty.
P193-127M	BFPH Fuel Pumps	Danfoss # 071N1012, SSC-127	Individual box with O-ring	1

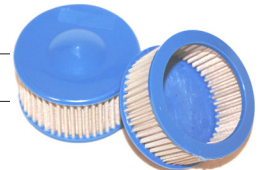

*P193-3 "A" Series Strainers will fit Beckett CleanCut Pump

PUMPS

Pump-Mounting Flanges

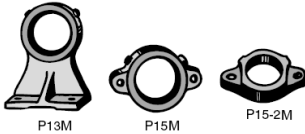

For use on pumps with mounting barrels of 2-1/8" nom. diameter.

FEATURES:

- Opposing set screws for firm and secure lock-up.

Part #	Description
P13M	Foot mounted, base to center 3-1/2"
P15M	2 holes, stepped down, threaded for 1/2-13 bolt
P15-2M	2 holes, stepped down, not threaded

Pump by Pass Plugs

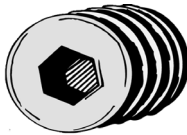

SUNTEC/WEBSTER

Part #	Size	Pkg Qty.
P24M	1/8" NPT	10
P24-1M	1/16" NPT	10

RIELLO

Part #	Size	Pkg Qty.
P24-2M	Metric	5

Gaskets for Riello Pumps

Part#	Use with Riello	Pkg Qty.
R64AM	Flat Cover Gasket	10
620-10M	"O" Ring Gasket	10

Gaskets for Webster Pumps

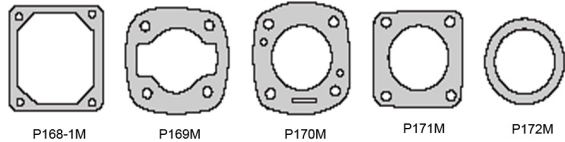

Part #	Use with Webster	Pkg Qty.
P168-1M	Cover gasket for M Series	10
P169M	Valve cover gasket for T and Q Series	10
P170M	Strainer cover gasket for T and Q Series	10
P171M	Valve and strainer gasket for T and Q Series - old style	10
P172M	Under-bellows and strainer gasket for T and Q series	10

Gaskets for Suntec Pumps

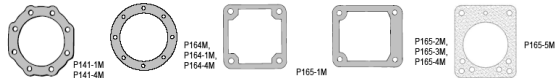

Part #	Use with Suntec	Pkg Qty.
P141M	Cover gasket for S1, S2	10
P141-4M	Cover gasket for S1, S2	50
P164M	Cover gasket for H, J, K	10
P164-1M	Cover gasket for H, J, K	100
P164-4M	Cover gasket for H, J, K	50
P165-1M	Cover gasket for 60 Series	10
P165-5M	Cover gasket for 70 Series - new style*	10
P165-5BM	Cover gasket for 70 Series - new style*	50

*For maximum resistance to oil.

PUMPS

Pump Test Gauges

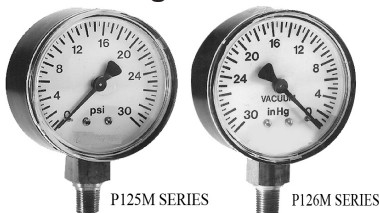

Part #	Description	Face	Mount
P125-1M	0 - 30 PSI pressure.	2"	1/8" Bottom
P125-2M	0 - 300 PSI pressure.	2"	1/8" Bottom
P126M	0 - 30" hg vacuum.	2"	1/8" Bottom
P125-2LM	0 - 300 PSI, liquid filled.	2"	1/8" Bottom
P126LM	0 - 30" hg vacuum, liquid filled.	2"	1/8" Bottom

Compact Pump Test Gauges

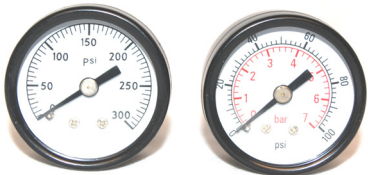

FEATURES:

- Ideal for permanent mounting on pumps or pressure lines.

Part #	Description	Face	Mount
P127M	30 - 150 PSI compound.	2"	1/8" Bottom
P127-2M	0 - 100 PSI pressure.	1-1/2"	1/8" Back
P127-3M	0 - 300 PSI pressure.	1-1/2"	1/8" Back

Kwik-Fit Pressure Vacuum Pump and Kits



FEATURES:

- For use with water, air or liquids.
- Clears lines.
- Frees stuck valves.
- Can also be used to add chemicals to boilers.

Part #	Description
P132M	Pump only
P132-4M	"O" ring for P132
P132-5M	1-1/2" tube for Firomatic Pump
P132-7M	Adapter/hose kit with toolbox. May be used with other pumps.
P132-8M	Complete Kit
P132-10M	Tool box only

TESTING & MEASUREMENT

Pump Testing Manifold Kit

Combines all the features of the P115-2M Kwik-Check II and the P115M Oil Watcher in one tool! Includes special fittings and instructions for use on Reillo pumps.



APPLICATIONS:

- Test pump pressure and cutoff of fuel oil pumps quickly and easily. No need to remove pump from oil burner. For use with all pumps of operating pressures up to 300 PSI.
- Use with vacuum gauge to analyze problems in oil lines caused by impurities, leaks or high restrictions.

FEATURES:

- Quick hook-up fittings for easy testing.
- Accurately checks pressure, cutoff and vacuum under actual operating conditions.
- Liquid filled gauges for accurate readings.
- High pressure hoses for setting up today's higher pressure pumps.
- High impact case with handle.
- Complete with easy-to-follow instructions.
- Brass and high quality aluminum construction for long life.
- Color coded hoses for pressure hook-up.
- Clear tubing adapts to any suction line.
- Adapter fittings included for all pumps including Riello.

Part#	Description
P115-10M ★	Pump Testing Manifold pressure hose and fittings

REPLACEMENT PARTS FOR PUMP TESTING MANIFOLD

P115-1M	Vacuum Adapter Fittings 1/2 x 3/8 (2 pack)
P115-3M	Flare adapter fittings 3/16" x 1/4"
P115-4M	Replacement viton seats
P115-11M	Pressure Hoses with Fittings
P115-12M	Vacuum Hoses with Fittings
P115-14M	Riello Adapters and O-rings
P125-2LM	0-300 PSI Liquid Filled Gauge
P126LM	0-30" Vacuum Liquid Filled Gauge

Kwik-Check II Pressure and Cutoff Tester

Tests pump pressure and cutoff of fuel oil pumps quickly and accurately without removing the pump from the oil burner. For use on all pumps up to 300 PSI.

FEATURES:

- Quick hook-up fittings make testing easy, clean and simple.
- Easy to follow, step-by-step directions.
- Checks operating pressure and cutoff under actual operating conditions.
- Color coded hoses.
- All brass body and high impact case for durability.



Part#	Description	Pkg Qty.
P115-2M ★	Kwik-Check II pressure and cut-off tester kit includes tester, fittings, rubber gaskets in case with instructions	1
P115-3M	Flare adapter fittings, 3/16" x 1/4"	2
P115-4M	Replacement viton seats	12
P115-5M	Hoses with fittings	2

TESTING & MEASUREMENT

Tankless Coil Tester

Accurately checks boiler pressure, indicates local water pressure ratings, indicates leaks in tankless heater coils.

FEATURES:

- Swivel hose connections for fast hookup
- Flexible plastic lines permit easy positioning of pressure gauges.
- High impact plastic case to protect coil tester gauge and components.
- Brass hose cap for access valve prevents leaks after testing.
- Instructions on inner lid of case.



Part#

B134-50M



Oil Watcher Oil Flow Monitor

Use with vacuum gauge to analyze problems in oil lines caused by impurities, leaks and high restrictions.

FEATURES:

- Clear tubing adapts to any suction line
- Fittings and complete instructions provided



Part#

Description

Pkg Qty.

P115M	★ Oil Watcher kit includes vacuum gauge, adapter fittings, hose and clamps, instructions and case	1
P115-1M	Oil Watcher adapter fittings	2
P115-1AM	Oil Watcher replacement hose and stainless steel camps	2

Water Detecting Paste

Detects water in tank.

Part#

Size

F2-25 2 Oz. jar



TESTING & MEASUREMENT

TM-2 Solid State Electronic Igniter Tester

Accurately, safely and quickly tests solid state electronic igniters, without having to disassemble the ignition system.

FEATURES:

- Easy to use: simply place the TM-2 on the igniter cover and activate the burner. In less than a second, a flashing red light will indicate if the igniter is good.
- No disassembly of ignition system required.
- No exposure to high voltage connections.
- Solid state accuracy - no misleading meter readings or interpretation.
- Works on all solid state oil igniters and Riello gas igniters.



Part#

T400M



TM-1 Iron Core Transformer Tester

Tests standard 10,000 volt transformers. Durable, safe, easy-to-use. Can be used without having to remove the transformer from the oil burner.

The TM-1 will identify deterioration in a transformer, even though the eye may appear to have an adequate spark.

FEATURES:

- Easy-to-read meter.
- Safe – all tests made on primary side.
- High impact case.
- Fused for meter protection.



Part#

T389M



TESTING & MEASUREMENT

Amp Mate Low Voltage Circuit Tester

Accurately measures low voltage control circuits for precise heat anticipator adjustments on thermostats.

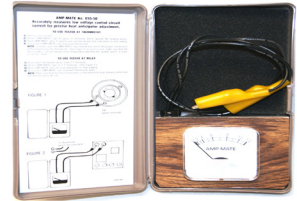

FEATURES:

- Quick hook-up makes testing easy and simple.
- High impact case for protection.
- Easy-to-follow, step-by-step instructions.
- Can be used to test other low voltage parts.

To Use Tester at the Thermostat

1. Remove thermostat
2. Attach AMP-MATE clips to wires or terminals which operate the heating device.
3. Read AMP-MATE after one minute and set thermostat heat anticipator to that setting.
4. Disconnect AMP-MATE and reconnect the thermostat.

NOTE:

In many cases the AMP-MATE clips may be touched to the proper connections without removing the thermostat (see diagram). In such a case, make sure that the thermostat is set well below room temperature and that the system switch, if used, is set for "heat".

To Use Tester at the Relay

1. Disconnect thermostat wires from T-T terminals.
2. Attach AMP-MATE clips to T-T terminals (see diagram).
3. Read AMP-MATE and set heat anticipator to the rating.
4. Disconnect AMP-MATE and reconnect the thermostat wires.

NOTE:

Make sure that the thermostat wires connected to the relay actually come from the thermostat to be set.

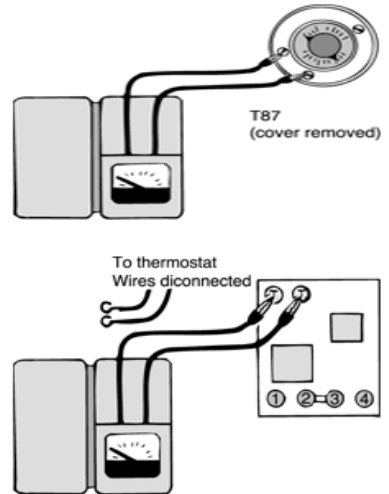

Part#

E55-50M



TESTING & MEASUREMENT

TM-20 Cad Cell Relay and Eye Tester

The TM-20 enabled the user to check both the cad cell relay and eye in minutes, without removing them from the burner.

FEATURES:

- Checks all brands of relays and eyes.
- Accurate and reliable.
- High impact case.
- Easy to follow, step-by-step directions included.

NOTE: All tests are made with the relay and cad cell eye mounted on the burner. To save time, relay and cad cell eye test may be run at the same time.

Before each use check the tester battery by holding the yellow and red tester leads together while reading the testing meter. The meter needle must fall within the "BAT,OK" area of the dial.

If not, replace the battery.



Part#

E55-2M



Riello Flame Simulator

Mounts on the Riello control, in place of cad cell eye. When the burner starts the ignition cycle, it throws the toggle switch. The burner will lock in the run position and simplifies priming the pump.

Part#

E55-4M



Gas Pressure Tester

Tests both natural and LP gases. 0 - 15" WC.

FEATURES:

- Durable – service truck tough
- Highlighted dial for fast reading
- Includes brass hose adapter.



Part#

N28-75M



Description

Tests both natural and LP gas. 0 - 15" WC

Replacement Hose Kit

Includes:

- Nitrile hose.
- Stainless steel spring
- Brass sampling tube

Part#

N27-16 Hose Assembly

TESTING & MEASUREMENT

Cadmium Sulfide Flame Detectors

Photoconductive flame sensing device that are direct replacements for several competitive models. For sequencing oil burner systems using protectorelay oil primary controls such as Honeywell R4166, R418, R8182, R8184, R8185 and R8404.

Part#	Replaces	Description
R80-100M	Honeywell 130367	Cad cell eye, 12.0 MA min.
R82M	C554A1794	Preassembled flame detector kit E-style mounting bracket 1 oil line bracket cad cell eye 60" leads
R82-2M	C554A1463	Universal flame detector kit includes 4 different style mounting brackets 1 oil line bracket cad cell eye 60" leads
R82-4M	70064	Preassembled flame detector kit includes E-style mounting bracket Beckett cad cell eye 30" leads

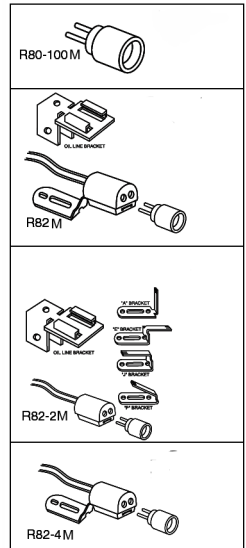

Smoke Check Combustion Smoke Testers

For testing smoke contents of flue gases.

FEATURES:

- High-impact barrel for durability.
- Sampling tube is curved to hook securely into the smoke pipe hole.
- Impact resistant and acid resistant polycarbonate barrel.
- Solid brass shaft.
- All hardware is stainless steel
- Lifetime lubrication.
- Fits standard Bacharach case.
- Uses all brands of smoke paper.

OPERATION:

- Flue gas is drawn through tester, staining the paper.
- The stained paper is compared to the smoke scale, allowing the service technician to set the burner at maximum efficiency.
- All necessary components provided: Smoke Check Tester, smoke paper, smoke scale and instructions.



Part#	Description
N27-16M ★	Smoke Check Combustion Smoke Tester - complete kit. Includes Smoke Check tester, smoke paper, smoke scale, instructions, carry case.
N29-26M	SmokeTest Paper only, 12 packs of 50 precut strips. Includes smoke scale. Suitable for use with Bacharach and Dwyer smoke testers.

TESTING & MEASUREMENT

Line Tester

Test any gas line, stove or any appliance that requires air test for gas leakage.

FEATURES:

- Easy to read gauge – 1/2lb. increments.
- 3/4" NPT.

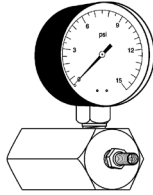

Part#		Description
N55-18M	★	0 - 100 PSI pressure
N55-12M	★	0 - 15 PSI pressure

Thermocouple Testers

Isolates gas safety problems by power unit substitution.

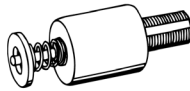

Part#	
N55-10M	

Audible/Visual Line Voltage Tester

Includes two LR44 button cell batteries.

FEATURES:

- LED visual indicator.
- Audible and visual hot side alert.
- Microwave leakage test.
- Continuity test.
- AC contact and non-con-contact.
- Polarity test.
- DC voltage test.
- Checks fuses.
- Pocket clip.



Part#	AC / DC Volts	Non-Contact AC Volts	Continuity
E397-313M	50 to 250V	200V, 750V	0 to 100M ohm

Low Voltage Screwdriver Tester

Includes two LR44 button cell batteries and pocket clip.

FEATURES:

- LED light and buzzer indication.
- AC contact and non-contact.
- Continuity check.
- Microwave leakage test.
- Polarity check.
- Checks fuses.



Part#	AC / DC Volts	Non-Contact AC Volts	Continuity
E397-309M	6 to 30V AC	1.5 to 30V DC	0 to 80 ohms

Screwdriver Tester with Red Glow LED

When tip is in direct contact with the live (HOT) part of the AC voltage, the red LED lights up.

FEATURES:

- Self-test.
- Continuity test.
- Checks fuses.
- Polarity check.
- Microwave leakage test.



Part#	AC Volts	Drop Resistant
E397-311M	70 to 250V AC	To 10 ft.

TESTING & MEASUREMENT

Line Voltage Testers

Fully insulated, this handy pocket screwdriver is also a combination high voltage circuit tester. Checks voltages from 90 to 250 volts.

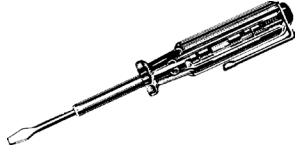

Part#	Description
E53M	90 to 250V

Low Voltage Tester

Part#	AC / DC Volts
E397-308M	5 to 50V AC/DC

Continuity Tester for Non-Energized Circuits

For low voltage circuits.

FEATURES:

- Extra-long, insulated leads with convenient alligator clip
- Uses 2 standard AA batteries (not included).

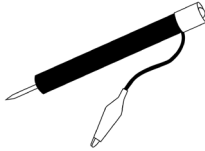

Part#
E397-244M

Pocketknife Style Thermometer

FEATURES:

- Easy to hang from vent or thermostat.
- Easier to carry. Rod easily folds away. No cover or sleeve to lose. Grooves hold rod at any angle.
- Easy to hang in flex duct.
- Range: -58°F to 392°F
- Resolution: 0.1°F



Part#	Range
SPK1	0° to +200 °F

Manometer U-Gauge

Used to set pressure regulator when adjusting main burner manifold. Adjustable scale for zero setting.



INCLUDES:

- 3 ft. rubber hose.
- Adapter fittings.

Part#	Description
N28-51M ★	Manometer complete. LP gas. 16" WC. Scale markings 8 - 0 - 8.
N28-52M	Manometer replacement tubing, 3 ft. L
N28-55M	Manometer replacement adapter fittings 5/16-32, 1/8" NPT, 1/4"NPT threads

Pocket Dial Thermometers

FEATURES:

- Easy-to-read, 1" dial with shatterproof, lens.
- Accurate to over 1% of full range.
- Rugged 5" stainless steel stem.
- Comes with plastic carrying sleeve and pocket clip.



Part#	Range
N29-100M ★	- 40° to +180 °F
N29-102M ★	0° to +200 °F

Digital Multimeter

The new EasyView Display™ makes reading the extra-large 4000-count display simple in dark work environment or bright sunlight, plus the range and function indicators provide you with more on-screen information making this a solid value.



FEATURES:

- Measures 1000 V DC, 750 V AC, amps, resistance and continuity.
- Diode check function.
- 3-3/4 digit, 4000-count display
- MAX capture mode.
- Data hold
- Low battery indication
- On-screen range and function indicators.
- Ruggedized to withstand a 10' drop.

Part#
DM383

TESTING & MEASUREMENT

Cold-Alert Telephone Temperature Monitor

Ideal for snowbirds or vacation homes. Cold-Alert guards homes against freezing conditions that could result in burst pipes or damaged equipment during the resident's absence. Cold-Alert quickly mounts on an existing phone jack. The homeowner phones home. A busy signal means that there has been a significant drop in internal temperature in the home.

FEATURES:

- Mounts on any modular telephone jack.
- Comes with telephone jack for easy installation.
- Can be permanently installed – secondary jack permits the use of your phone with Cold-Alert in place.
- Quick, easy installation. No tools required.



Part#	Description
C138-4M ★	Cold-Alert Telephone Temperature Monitor

Flood Alarm Buzz Pro

The Flood Buzz Pro has two metal prongs on the bottom of the unit. Place the device, prongs down in the Water Heater Pan or the HVAC Condensing Pan. If the water level reaches 1/8", the circuit closes and sounds an alarm up to 110 dB.

Part#
K41-6M



TESTING & MEASUREMENT

Vac-Bolt Test Gauges



For use with popular filter can models. Accurately reads vacuum without disconnecting pump fittings or oil lines.

Part#	Use with
P127-25M	General Filters 1A-25A; Harvey 264, 264F; Mitco 264M, 264FM; Westwood S254; Unifilter 77
P127-27M	General Filters 2A-700A; Harvey 265, 265F; Mitco 265M, 265FM
P127-29M	Firomatic C20, C30, C40, C50, C60, CF20, CF30
P127-31M	Fulflo FB-4, FB-6, FB-8, FB-10

Vac-Bolt Test Gauge Sets

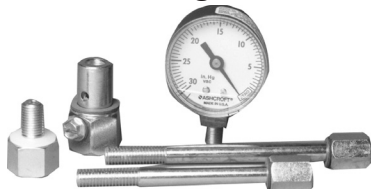

1 gauge and 4 adapters to fit most popular filter can models.

Part#	Description
P127-34M	1 gauge, 4 adapters to fit most popular filter can models

Pump Test Gauges



2" face test gauge.

FEATURES:

- Large face for easy reading at distance or in dim light.
- Dials specifically designed for oil burner service
- High impact acrylic construction.
- 1/8" NPT bottom mount.

Part#	Description
P125-1M	0 - 30 PSI pressure.
P125-2M	0 - 300 PSI pressure.
P125-2LM	0 - 300 PSI, liquid filled.
P126M	0 - 30" hg vacuum.
P126LM	0 - 30" hg vacuum, liquid filled.

Compact Pump Test Gauges



1 – 1/2" face test gauge.

FEATURES:

- Ideal for permanent mounting on pumps or pressure lines.
- 1/8" NPT back mount.

Part#	Description	Face	Mount
P127M	30 - 150 PSI pressure.	2"	1/8" Bottom
P127-2M	0 - 100 PSI pressure.	1-1/2"	1/8" Back
P127-3M	0 - 300 PSI pressure.	1-1/2"	1/8" Back

TESTING & MEASUREMENT

Pump Testing Manifold Kit

Combines all the features of the P115-2M Kwik-Check II and the P115M Oil Watcher in one tool! Includes special fittings and instructions for use on Reillo pumps.



APPLICATIONS:

- Test pump pressure and cutoff of fuel oil pumps quickly and easily. No need to remove pump from oil burner. For use with all pumps of operating pressures up to 300 PSI.
- Use with vacuum gauge to analyze problems in oil lines caused by impurities, leaks or high restrictions.

FEATURES:

- Quick hook-up fittings for easy testing.
- Accurately checks pressure, cutoff and vacuum under actual operating conditions.
- Liquid filled gauges for accurate readings.
- High pressure hoses for setting up today's higher pressure pumps.
- High impact case with handle.
- Complete with easy-to-follow instructions.
- Brass and high quality aluminum construction for long life.
- Color coded hoses for pressure hook-up.
- Clear tubing adapts to any suction line.
- Adapter fittings included for all pumps including Riello.

Part#	Description
P115-10M ★	Pump Testing Manifold pressure hose and fittings

REPLACEMENT PARTS FOR PUMP TESTING MANIFOLD

P115-1M	Vacuum Adapter Fittings 1/2 x 3/8 (2 pack)
P115-3M	Flare adapter fittings 3/16" x 1/4"
P115-4M	Replacement viton seats
P115-11M	Pressure Hoses with Fittings
P115-12M	Vacuum Hoses with Fittings
P115-14M	Riello Adapters and O-rings
P125-2LM	0-300 PSI Liquid Filled Gauge
P126LM	0-30" Vacuum Liquid Filled Gauge

Kwik-Check II Pressure and Cutoff Tester

Tests pump pressure and cutoff of fuel oil pumps quickly and accurately without removing the pump from the oil burner. For use on all pumps up to 300 PSI.

FEATURES:

- Quick hook-up fittings make testing easy, clean and simple.
- Easy to follow, step-by-step directions.
- Checks operating pressure and cutoff under actual operating conditions.
- Color coded hoses.
- All brass body and high impact case for durability.



Part#	Description	Pkg Qty.
P115-2M ★	Kwik-Check II pressure and cut-off tester kit includes tester, fittings, rubber gaskets in case with instructions	1
P115-3M	Flare adapter fittings, 3/16" x 1/4"	2
P115-4M	Replacement viton seats	12
P115-5M	Hoses with fittings	2

TESTING & MEASUREMENT

Tankless Coil Tester

Accurately checks boiler pressure, indicates local water pressure ratings, indicates leaks in tankless heater coils.

FEATURES:

- Swivel hose connections for fast hookup
- Flexible plastic lines permit easy positioning of pressure gauges.
- High impact plastic case to protect coil tester gauge and components.
- Brass hose cap for access valve prevents leaks after testing.
- Instructions on inner lid of case.



Part#

B134-50M



Oil Watcher Oil Flow Monitor

Use with vacuum gauge to analyze problems in oil lines caused by impurities, leaks and high restrictions.

FEATURES:

- Clear tubing adapts to any suction line
- Fittings and complete instructions provided



Part#

Description

Pkg Qty.

P115M	★	Oil Watcher kit includes vacuum gauge, adapter fittings, hose and clamps, instructions and case	1
P115-1M		Oil Watcher adapter fittings	2
P115-1AM		Oil Watcher replacement hose and stainless steel camps	2

Water Detecting Paste

Detects water in tank.

Part#

Size

F2-25 2 Oz. jar



TESTING & MEASUREMENT

TM-2 Solid State Electronic Igniter Tester

Accurately, safely and quickly tests solid state electronic igniters, without having to disassemble the ignition system.

FEATURES:

- Easy to use: simply place the TM-2 on the igniter cover and activate the burner. In less than a second, a flashing red light will indicate if the igniter is good.
- No disassembly of ignition system required.
- No exposure to high voltage connections.
- Solid state accuracy - no misleading meter readings or interpretation.
- Works on all solid state oil igniters and Riello gas igniters.



Part#

T400M



TM-1 Iron Core Transformer Tester

Tests standard 10,000 volt transformers. Durable, safe, easy-to-use. Can be used without having to remove the transformer from the oil burner.

The TM-1 will identify deterioration in a transformer, even though the eye may appear to have an adequate spark.

FEATURES:

- Easy-to-read meter.
- Safe – all tests made on primary side.
- High impact case.
- Fused for meter protection.



Part#

T389M



TESTING & MEASUREMENT

Amp Mate Low Voltage Circuit Tester

Accurately measures low voltage control circuits for precise heat anticipator adjustments on thermostats.

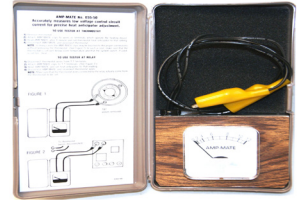

FEATURES:

- Quick hook-up makes testing easy and simple.
- High impact case for protection.
- Easy-to-follow, step-by-step instructions.
- Can be used to test other low voltage parts.

To Use Tester at the Thermostat

1. Remove thermostat
2. Attach AMP-MATE clips to wires or terminals which operate the heating device.
3. Read AMP-MATE after one minute and set thermostat heat anticipator to that setting.
4. Disconnect AMP-MATE and reconnect the thermostat.

NOTE:

In many cases the AMP-MATE clips may be touched to the proper connections without removing the thermostat (see diagram). In such a case, make sure that the thermostat is set well below room temperature and that the system switch, if used, is set for "heat".

To Use Tester at the Relay

1. Disconnect thermostat wires from T-T terminals.
2. Attach AMP-MATE clips to T-T terminals (see diagram).
3. Read AMP-MATE and set heat anticipator to the rating.
4. Disconnect AMP-MATE and reconnect the thermostat wires.

NOTE:

Make sure that the thermostat wires connected to the relay actually come from the thermostat to be set.

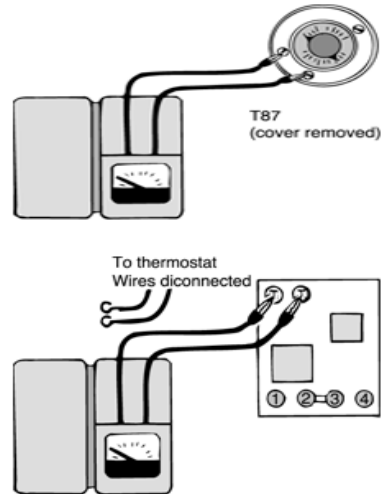

Part#

E55-50M



TESTING & MEASUREMENT

TM-20 Cad Cell Relay and Eye Tester

The TM-20 enabled the user to check both the cad cell relay and eye in minutes, without removing them from the burner.

FEATURES:

- Checks all brands of relays and eyes.
- Accurate and reliable.
- High impact case.
- Easy to follow, step-by-step directions included.

NOTE: All tests are made with the relay and cad cell eye mounted on the burner. To save time, relay and cad cell eye test may be run at the same time.

Before each use check the tester battery by holding the yellow and red tester leads together while reading the testing meter. The meter needle must fall within the "BAT,OK" area of the dial.

If not, replace the battery.



Part#

E55-2M



Riello Flame Simulator

Mounts on the Riello control, in place of cad cell eye. When the burner starts the ignition cycle, it throws the toggle switch. The burner will lock in the run position and simplifies priming the pump.

Part#

E55-4M



Gas Pressure Tester

Tests both natural and LP gases. 0 - 15" WC.

FEATURES:

- Durable – service truck tough
- Highlighted dial for fast reading
- Includes brass hose adapter.



Part#

N28-75M



Description

Tests both natural and LP gas. 0 - 15" WC

Replacement Hose Kit

Includes:

- Nitrile hose.
- Stainless steel spring
- Brass sampling tube

Part#

N27-16 Hose Assembly

TESTING & MEASUREMENT

Cadmium Sulfide Flame Detectors

Photoconductive flame sensing device that are direct replacements for several competitive models. For sequencing oil burner systems using protectorelay oil primary controls such as Honeywell R4166, R418, R8182, R8184, R8185 and R8404.

Part#	Replaces	Description
R80-100M	Honeywell 130367	Cad cell eye, 12.0 MA min.
R82M	C554A1794	Preassembled flame detector kit E-style mounting bracket 1 oil line bracket cad cell eye 60" leads
R82-2M	C554A1463	Universal flame detector kit includes 4 different style mounting brackets 1 oil line bracket cad cell eye 60" leads
R82-4M	70064	Preassembled flame detector kit includes E-style mounting bracket Beckett cad cell eye 30" leads

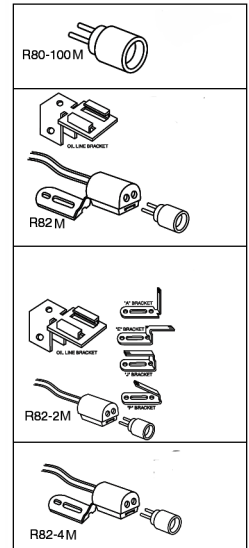

Smoke Check Combustion Smoke Testers

For testing smoke contents of flue gases.

FEATURES:

- High-impact barrel for durability.
- Sampling tube is curved to hook securely into the smoke pipe hole.
- Impact resistant and acid resistant polycarbonate barrel.
- Solid brass shaft.
- All hardware is stainless steel
- Lifetime lubrication.
- Fits standard Bacharach case.
- Uses all brands of smoke paper.

OPERATION:

- Flue gas is drawn through tester, staining the paper.
- The stained paper is compared to the smoke scale, allowing the service technician to set the burner at maximum efficiency.
- All necessary components provided: Smoke Check Tester, smoke paper, smoke scale and instructions.



Part#	Description
N27-16M ★	Smoke Check Combustion Smoke Tester - complete kit. Includes Smoke Check tester, smoke paper, smoke scale, instructions, carry case.
N29-26M	SmokeTest Paper only, 12 packs of 50 precut strips. Includes smoke scale. Suitable for use with Bacharach and Dwyer smoke testers.

TESTING & MEASUREMENT

Line Tester

Test any gas line, stove or any appliance that requires air test for gas leakage.

FEATURES:

- Easy to read gauge – 1/2lb. increments.
- 3/4" NPT.

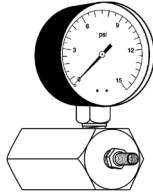

Part#		Description
N55-18M	★	0 - 100 PSI pressure
N55-12M	★	0 - 15 PSI pressure

Thermocouple Testers

Isolates gas safety problems by power unit substitution.

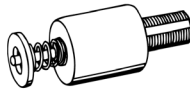

Part#	
N55-10M	

Audible/Visual Line Voltage Tester

Includes two LR44 button cell batteries.

FEATURES:

- LED visual indicator.
- Audible and visual hot side alert.
- Microwave leakage test.
- Continuity test.
- AC contact and non-con-contact.
- Polarity test.
- DC voltage test.
- Checks fuses.
- Pocket clip.



Part#	AC / DC Volts	Non-Contact AC Volts	Continuity
E397-313M	50 to 250V	200V, 750V	0 to 100M ohm

Low Voltage Screwdriver Tester

Includes two LR44 button cell batteries and pocket clip.

FEATURES:

- LED light and buzzer indication.
- AC contact and non-contact.
- Continuity check.
- Microwave leakage test.
- Polarity check.
- Checks fuses.



Part#	AC / DC Volts	Non-Contact AC Volts	Continuity
E397-309M	6 to 30V AC	1.5 to 30V DC	0 to 80 ohms

Screwdriver Tester with Red Glow LED

When tip is in direct contact with the live (HOT) part of the AC voltage, the red LED lights up.

FEATURES:

- Self-test.
- Continuity test.
- Checks fuses.
- Polarity check.
- Microwave leakage test.



Part#	AC Volts	Drop Resistant
E397-311M	70 to 250V AC	To 10 ft.

TESTING & MEASUREMENT

Line Voltage Testers

Fully insulated, this handy pocket screwdriver is also a combination high voltage circuit tester. Checks voltages from 90 to 250 volts.

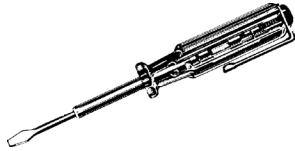

Part#	Description
E53M	90 to 250V

Low Voltage Tester

Part#	AC / DC Volts
E397-308M	5 to 50V AC/DC

Continuity Tester for Non-Energized Circuits

For low voltage circuits.

FEATURES:

- Extra-long, insulated leads with convenient alligator clip
- Uses 2 standard AA batteries (not included).

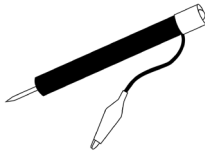

Part#
E397-244M

Pocketknife Style Thermometer

FEATURES:

- Easy to hang from vent or thermostat.
- Easier to carry. Rod easily folds away. No cover or sleeve to lose. Grooves hold rod at any angle.
- Easy to hang in flex duct.
- Range: -58°F to 392°F
- Resolution: 0.1°F



Part#	Range
SPK1	0° to +200 °F

Manometer U-Gauge

Used to set pressure regulator when adjusting main burner manifold. Adjustable scale for zero setting.



INCLUDES:

- 3 ft. rubber hose.
- Adapter fittings.

Part#	Description
N28-51M ★	Manometer complete. LP gas. 16" WC. Scale markings 8 - 0 - 8.
N28-52M	Manometer replacement tubing, 3 ft. L
N28-55M	Manometer replacement adapter fittings 5/16-32, 1/8" NPT, 1/4"NPT threads

Pocket Dial Thermometers

FEATURES:

- Easy-to-read, 1" dial with shatterproof, lens.
- Accurate to over 1% of full range.
- Rugged 5" stainless steel stem.
- Comes with plastic carrying sleeve and pocket clip.



Part#	Range
N29-100M ★	- 40° to +180 °F
N29-102M ★	0° to +200 °F

Digital Multimeter

The new EasyView Display™ makes reading the extra-large 4000-count display simple in dark work environment or bright sunlight, plus the range and function indicators provide you with more on-screen information making this a solid value.



FEATURES:

- Measures 1000 V DC, 750 V AC, amps, resistance and continuity.
- Diode check function.
- 3-3/4 digit, 4000-count display
- MAX capture mode.
- Data hold
- Low battery indication
- On-screen range and function indicators.
- Ruggedized to withstand a 10' drop.

Part#
DM383

TESTING & MEASUREMENT

Cold-Alert Telephone Temperature Monitor

Ideal for snowbirds or vacation homes. Cold-Alert guards homes against freezing conditions that could result in burst pipes or damaged equipment during the resident's absence. Cold-Alert quickly mounts on an existing phone jack. The homeowner phones home. A busy signal means that there has been a significant drop in internal temperature in the home.

FEATURES:

- Mounts on any modular telephone jack.
- Comes with telephone jack for easy installation.
- Can be permanently installed – secondary jack permits the use of your phone with Cold-Alert in place.
- Quick, easy installation. No tools required.



Part#	Description
C138-4M ★	Cold-Alert Telephone Temperature Monitor

Flood Alarm Buzz Pro

The Flood Buzz Pro has two metal prongs on the bottom of the unit. Place the device, prongs down in the Water Heater Pan or the HVAC Condensing Pan. If the water level reaches 1/8", the circuit closes and sounds an alarm up to 110 dB.

Part#
K41-6M



TESTING & MEASUREMENT

Vac-Bolt Test Gauges



For use with popular filter can models. Accurately reads vacuum without disconnecting pump fittings or oil lines.

Part#	Use with
P127-25M	General Filters 1A-25A; Harvey 264, 264F; Mitco 264M, 264FM; Westwood S254; Unifilter 77
P127-27M	General Filters 2A-700A; Harvey 265, 265F; Mitco 265M, 265FM
P127-29M	Firomatic C20, C30, C40, C50, C60, CF20, CF30
P127-31M	Fulflo FB-4, FB-6, FB-8, FB-10

Vac-Bolt Test Gauge Sets

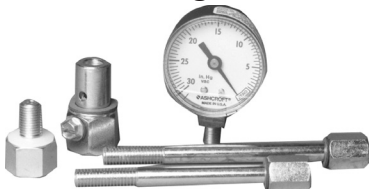

1 gauge and 4 adapters to fit most popular filter can models.

Part#	Description
P127-34M	1 gauge, 4 adapters to fit most popular filter can models

Pump Test Gauges



2" face test gauge.

FEATURES:

- Large face for easy reading at distance or in dim light.
- Dials specifically designed for oil burner service
- High impact acrylic construction.
- 1/8" NPT bottom mount.

Part#	Description
P125-1M	0 - 30 PSI pressure.
P125-2M	0 - 300 PSI pressure.
P125-2LM	0 - 300 PSI, liquid filled.
P126M	0 - 30" hg vacuum.
P126LM	0 - 30" hg vacuum, liquid filled.

Compact Pump Test Gauges



1 – 1/2" face test gauge.

FEATURES:

- Ideal for permanent mounting on pumps or pressure lines.
- 1/8" NPT back mount.

Part#	Description	Face	Mount
P127M	30 - 150 PSI pressure.	2"	1/8" Bottom
P127-2M	0 - 100 PSI pressure.	1-1/2"	1/8" Back
P127-3M	0 - 300 PSI pressure.	1-1/2"	1/8" Back

TOOLS

Turn-a-Kit Bleed Wrenches

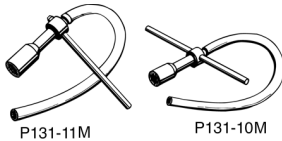

Use to bleed fuel oil units with a quick turn of the wrench.

FEATURES:

- Clear vinyl tubing routes bleed oil directly into catch can without spilling.

Part#	Description
P131-10M ★	T-handle
P131-11M ★	Offset bleed handle
T397-122M	Replacement bleed hoses - 6 pack

Fan Pullers

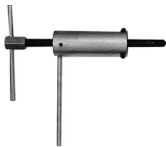

Locks to hub of fan for quick removal without damaging hub or fan. Fits most fans or blower assemblies.

Part#

238M ★

Gauge Glass Washers

High Pressure Gauge Glass Washers

Part#	Glass O.D. & Length	Pkg Qty.
B132-2M	5/8" I.D. Rubber	12 Pack

Gauge Glass Cutters

FEATURES:

- Built-in rule, scaled to 1/16".
- Adjustable lock assures cuts to exact length.
- Steel cutting wheel is easily replaced for sharp, clean operation.



Part#	Description
B134	Glass gauge cutter
B134-1	Replacement cutting wheel

Gauge Glass Cutters

Fast and convenient hand tool for cutting gauge glass.

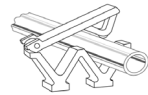

FEATURES:

- Cuts glass easily and cleanly, leaving clean, straight edges.
- Cuts all types of glass including Corning Pyrex Redline and high pressure glass.

Part#
B134-4M

Soot-Saws

The perfect tool for removing soot and scale build-up on boilers with narrow passages.

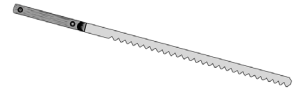

FEATURES:

- Made of cold-rolled, electro-zinc coated 17 gauge steel for extra durability.
- Hook hole drilled for easy storage.
- Soft vinyl handle for comfortable use.

Part#	Description	Size
S5-50M ★	Heavy-duty Soot Saw 63% heavier with larger teeth	1" W x 32" L
S5-49M ★	Standard style Soot Saw	1" W x 32" L

TOOLS

Hex Key Sets

FEATURES:

- Made of top grade, steel alloy to resist wear.
- 8 of the most commonly used sizes.
- Convenient chrome-plated case with spring tension to hold keys securely.



Part#	Hex Sizes
T651-50M	★ .050", 1/16", 5/64", 3/32", 1/8", 5/32", 3/16", 1/4", 7/64, 9/64, 7/32, 5/16, 3/8
T651M	★ 5/64"
T651-1M	★ 3/32"
T651-2M	★ 1/8"
T651-3M	★ 5/32"
T651-4M	★ 3/16"
T651-5M	★ 7/32"
T651-6M	★ 1/4"

Dual Purpose Crimping Tools

Crimps both insulated and non-insulated solderless terminals.



FEATURES:

- Cut and rethreads bolts.
- Pliers nose for pulling and looping wire.
- Sizing information engraved on tool.
- Man-sized, cushioned, vinyl grips.
- Lifetime pivot joint.

Part#	Materials Used On	Bolt Sizes	Length
T395-5M	Cuts and strips, 10-20 gauge copper and aluminum wire., Cuts electrical/ electronic bolts.	4-40, 6-32, 8-32, 10-24, 10-32	8"

Metal Parts Organizers

FEATURES:

- 21 plastic compartments.
- Removable, high-impact plastic tray.
- Metal hinges and snap fastener.
- Easy carry handle.



Part#

T397-510M

TOOLS

Kwik-Purge Oil Line Products

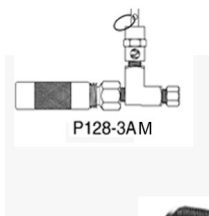

P128-3AM



P128-34M
WITH
GAUGE
0-1000 PSI

P128-4M



P128-3M



P128M



P128-1M

Part#	Description	Pkg Qty
P128-3AM ★	Kwik-Purge II Deluxe Blow Out Gun With safety valve. Valve opens at 150 PSI protecting against excessive line pressure build-up.	1
P128M ★	Kwik-Purge II CO2 Blow Out Gun Clears plugged oil lines. Brass construction with built-in check valve. Uses standard CO2 charges.	1
P128-1M	CO2 Charges High pressure CO2 charges for blow out gun use. Individually immersion tested. Box of 10 charges	10
P128-2M ★	O Ring For P128M. 800 PSI	6
P128-3M ★	Kwik-Purge II Kit Deluxe blow out gun with gauge. Identifies direction of oil plug. Prevents CO2 charge waste.	1
P128-34M ★	Blow Out Gun and Fitting Kit Blow-out gun w/gauge and P128-4M fitting kit	1
P128-4M ★	Kwik Coupling Kit Adapts to any standard CO2 blow out tool. Threaded 1/4" NPT. Upgraded design reduces time requires on 3/8" and 1/2" copper suction line hook-ups. Contains coupling, 3/8" and 1/2" compression fittings and 3/8" and 1/2" flare fittings.	1

Turn-a-Flange Installation Tools

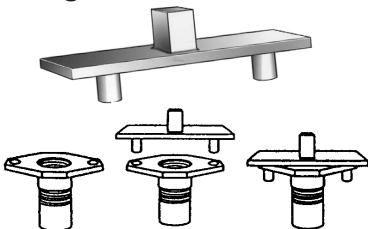

Makes flange installation on threaded pipe quick and easy. Fits most makes of circulator flanges.

Part#

B60-40M ★

Wise Crack Impeller Removers

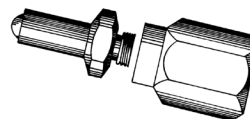

Specially designed to quickly remove stubborn B&G impellers without damage to either impeller or shaft.

Part#

B60-30M ★

TOOLS

Tube Cutters

Small Capacity Compact Tube Cutter

Designed for use in restricted spaces, on small diameter, hard and soft copper, aluminum, brass, thinwall steel, stainless steel, monel and titanium.

FEATURES:

- Strong, lightweight slide.
- Large knurled feed screw knob for easy control of cutting pressure and clean cuts.



Part#	Tube Dia. Range	Swing Radius	Length
T625-10M ★	1/8" to 5/8" O.D. Tubing	1-1/4"	1-3/4"

Large Capacity Compact Tube Cutter

Designed for use in restricted spaces, but has larger capacity than T625-10M. Cuts hard and soft copper, aluminum, brass, thinwall steel, stainless steel, monel and titanium.

FEATURES:

- Strong, lightweight slide.
- Large knurled feed screw knob for easy control of cutting pressure and clean cuts.
- Includes two cutter wheels.



Part#	Tube Dia. Range	Swing Radius	Length
T625-11M ★	3/8" to 1-1/8" O.D. Tubing (2-14" with 1-1/8" tube)	1-5/16"	2-11/16"

Adjustable Tube Cutter

For soft and hard copper, aluminum, brass, thin wall stainless steel, stainless steel, monel and titanium.

FEATURES:

- Ratchet feed mechanism speeds up cutting.
- Extra wide rollers with flare cut-off groove stabilize tubing.
- Enclosed screw-type feed mechanism, lightweight aluminum alloy body.
- Includes 2 general purpose cutting wheels.

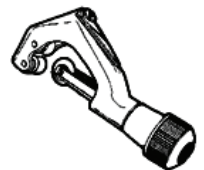

Part#	Capacity	Swing Radius	Length
T625-23M ★	Large: 3/8" - 2-5/8" O.D. Tubing	7-3/4"	7-3/4"

TOOLS

Triple Header Tube Benders

For bending hard or soft copper, aluminum, brass, thin wall, steel and other tubing.

FEATURES:

- Makes smooth, tight radius 180° bends.
- Calibrated Markings-for making accurate left-hand, right-hand and offset bends.
- Adjustable hook.
- Optimum bending radius-for each tubing size.
- Bends 1/4", 3/16", 3/8" and tubing.
- Cushion grips-for extreme comfort.



Part#	Radius to Center of Tube Measurement	Mfr#
T710M ★	15/16"	368-FH

All Metal Fin Straighteners

Use to straighten and clean condenser and evaporator fins.

FEATURES:

- One tool for all units.
- Heavy-duty spring wire bristles automatically adjust to any fin spacing.
- Exclusive tension adjustment band allows maximum rigidity and ease of operation.

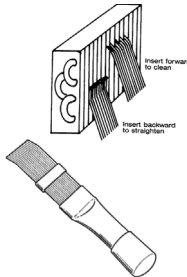

Part#	Mfr#
T645-22M ★	T200

Fin Straighteners

For condenser and evaporator fins.

FEATURES:

- 8, 9, 10, 12, 14, 15 fins per inch.



Part#	Mfr#
T645M ★	14401

Refrigeration Wrenches

Premium quality forged steel.

FEATURES:

- Reversible ratchet with square openings.
- 1/4" and 3/6" and 5/16" other end.
- Closed end style.



Part#	Mfr#
T534-38M	★ 60613

Refrigeration & A/C Wrenches



Part#	Description
60616	"Knuckle Saver" design for convenience in tight areas. 1/4" and 3/16" square openings on one end. 3/8" and 5/16" square openings on the other.

Oil Filter Strap Wrench

FEATURES:

- Adjust to fit any circumference or shape up to 6" diameter.
- Grip, loosen or tighten almost anything. Won't scratch or damage surfaces.
- Cushioned grip for maximum comfort.



Part#	Mfr#
T535-2M	★ 54000