

We've got it.

HVAC Product Catalog

Issue 22



Simplify your Work.™

1

PADS

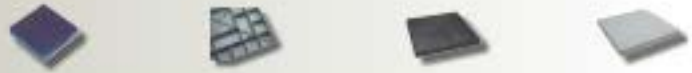

25

MOUNTING SYSTEMS



37

AIR MOVEMENT

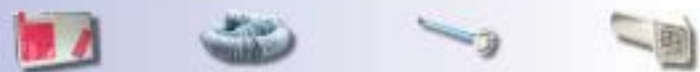

43

HEATING PRODUCTS



55

CONDENSATE MANAGEMENT



83

GENERAL INDUSTRIAL



95

DEVCO

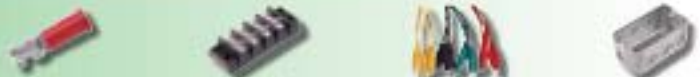

127

ELECTRICAL

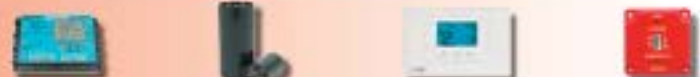

167

TOOLS



185

PLUMBING

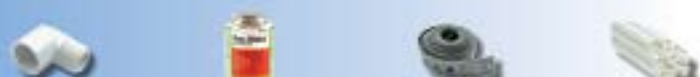

195

DUCTLESS SYSTEMS



205

MAINTENANCE CHEMICALS



231

INLINE COMPONENTS



249

DISTRIBUTOR SUPPORT



PADS

Anti-Vibration Pads.....	24
Cladlite® Lightweight Equipment Pads.....	20
E Lite® Plastic Equipment Pads.....	19
EcoPad™.....	23
Heat Pump Pads.....	23
Hef-T-Pad®.....	22
The Black Pad®.....	22
The Hurricane Pad™.....	21
Ultralite® Lightweight Concrete Equipment Pads....	18-19

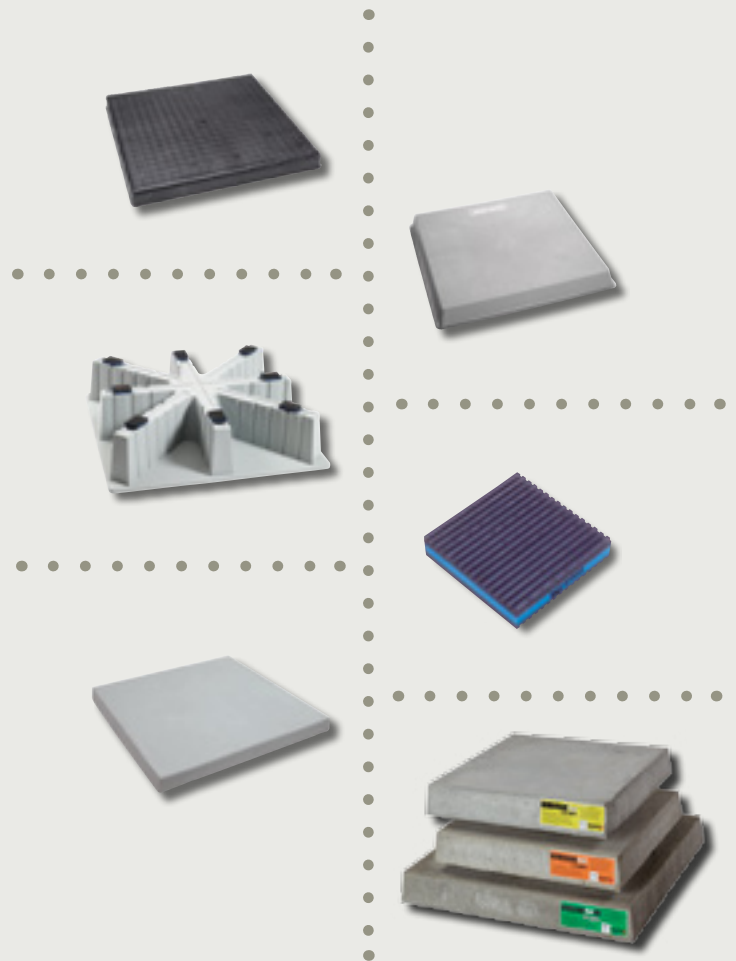

E Lite® Plastic Equipment Pads

E Lite® is a plastic pad designed as a mounting base for equipment. The rugged design provides uniform and generous ribbing for optimum, self-leveling ground support without inserts. E Lite® is injection molded from polypropylene, resulting in a pad that is lightweight, but not too light. A subtle texture prevents unit slide and presents a classic appearance, which is enhanced by rounded edges and a concrete gray color. Each pad is molded with its size in raised letters.



TECHNICAL DATA

MATERIAL

Polypropylene

FREEZE/THAW

Flawless performance under the 25-cycle regimen specified by ASTM C67

CHEMICAL RESISTANCE

Does not crack, flake, or warp when tested per ASTM D2299 with the following:

- R-22 and R-134a
- Synthetic canine urine
- Compressor oil
- Salt solution, 20% by volume



Each pad is molded with its size in raised letters.

FEATURES AND BENEFITS

- Lightweight, yet rugged
- Drillable for securing unit
- Uniform ribbing transfers load evenly
- Unaffected by UV or weather
- Subtle texture resists unit slide

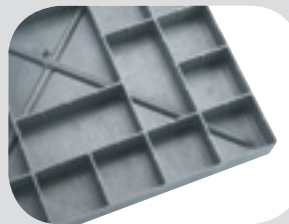

The bottom of an E Lite® pad shows extensive ribbing, plus additional surface support.



E Lite® plastic equipment pads are manufactured at DiversiTech's Conyers, Georgia plant.

Hef-T-Pad® Equipment Pads

Hef-T-Pad® is an injection molded equipment pad created from high impact polypropylene with UV inhibitors making it easy to handle, yet durable and strong. It does not require any additional equipment for moving and handling. Hef-T-Pad® is resistant to impact, ultraviolet degradation and weathering and will not crack, flake, or warp. It is virtually impervious to climatic variations. Hef-T-Pad® is drillable to permit installation of refrigerant and electrical lines under and through the pad and to allow equipment to be easily secured to the pad.



FEATURES AND BENEFITS OF THE HEF-T-PAD®

Stabilization foot increases the surface area for bearing stabilization on soil; reduces sinking in soft soil under heavy load. Support ribs provide structural support.



STABILIZATION FOOT

Stabilization flange provides a wide perimeter that reduces sinking in soft soil under heavy load. Both the flange and ribbing provide reinforcement for the corners.



STABILIZATION FLANGE

The thick walled polymer is suitable for drilling and screw fastening of equipment, line sets, and electrical connections.

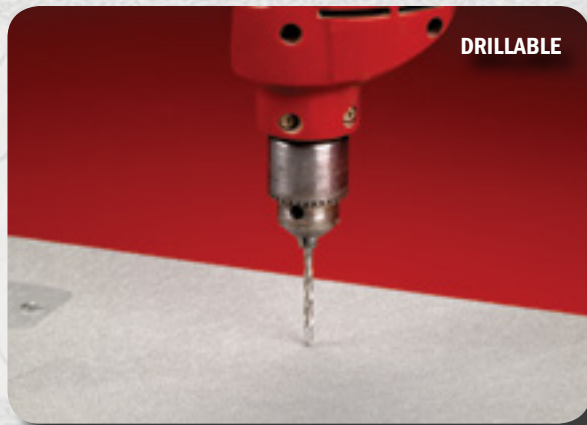

DRILLABLE

Attractive neutral gray color with pad size and branding clearly embossed on pad surface.

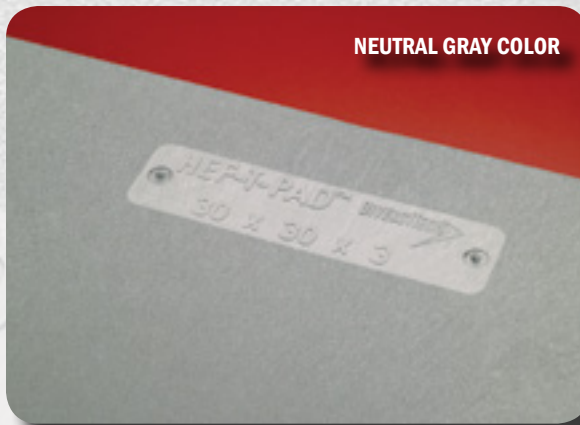

NEUTRAL GRAY COLOR

Textured surface provides good aesthetics and a non-skid surface.

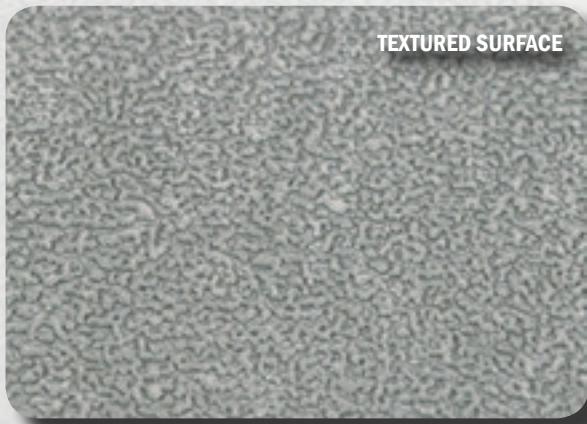

TEXTURED SURFACE

Pad size is molded into the side of the pad as well as the top surface.



PAD SIZE

The Black Pad[®] replaces Concrete Equipment Bases

Eco-friendly

An innovative equipment base, The Black Pad[®] uses ground, recycled rubber in a co-injection process. The pad is extremely durable, resistant to ultraviolet light, and heavier than a completely plastic pad. The Black Pad[®] is ideal for pool and spa pumps, filters and heaters. The Black Pad[®] is extremely weather resistant and easy to drill and secure pool and spa equipment.



- No cracking and less breakage than concrete
- Extremely durable, yet lightweight
- UV resistant; unaffected by weather
- Generous ribbing for optimum, self-leveling ground support
- Outer edges have rounded corners with double-thick walls
- Uniform ribbing transfers load evenly
- Textured surface prevents equipment slippage
- Drillable for securing equipment
- Made of recycled material
- ICC Certified to Standard Swimming Pool Code sections 305.2 Mounting and section 405 Equipment Foundations and Enclosures.

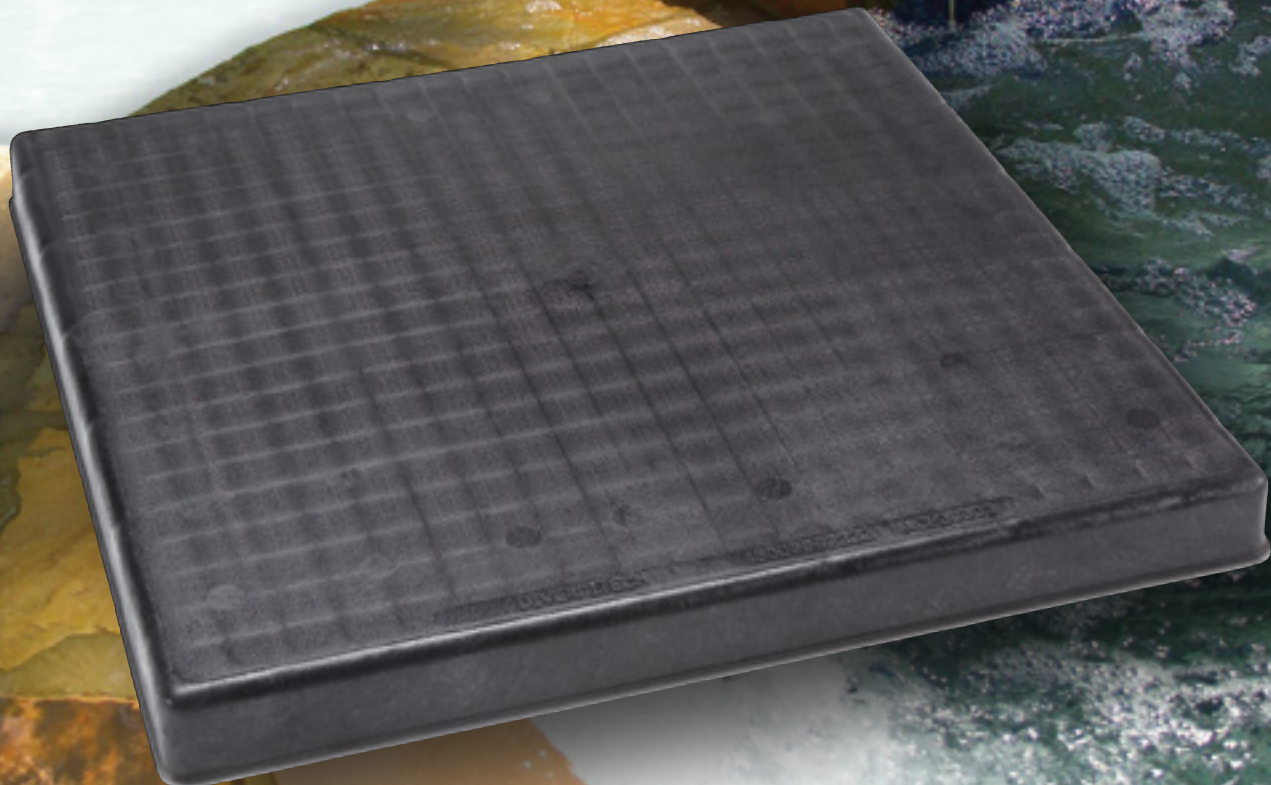
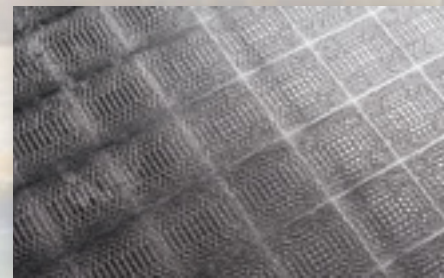

UltraLite® Equipment Pads



- *Lightweight concrete pad*
- *Installs in seconds - easier and faster than pouring your own pad*
- *Engineered for long term outside weather resistance*
- *Will not degrade or discolor*
- *Freeze/thaw resistant - will not crack*

UltraLite® Pads are made by DiversiTech, North America's largest manufacturer of equipment pads.

FEATURES AND BENEFITS

LIGHTWEIGHT At an average weight of 2-1/2 pounds per square foot (12 kg. per square metre), the UltraLite lightweight concrete pad is one of the lightest equipment mounting products available today. Lightweight products are important for ease of handling on job site.

DURABLE The exterior of the UltraLite lightweight concrete pad is specifically engineered for long-term exterior weather resistance.

DUCTILE The skin and core of the UltraLite lightweight concrete pad is specifically engineered for flexibility and ductility demanded of job site handling. Additionally, the ductility of the outer skin facilitates conformance to slight ground contours without fracture.

TIME/LABOR SAVINGS Time is money, and hence any time savings on site translates into money saved. The UltraLite lightweight concrete pad literally installs in seconds while providing a solid foundation for the condensing unit.

CONCRETE SURFACE The concrete external skin of the UltraLite lightweight concrete pad is not subject to ultraviolet degradation or weathering discoloration.

VIBRATION ABSORBING The engineered polystyrene core in the UltraLite lightweight concrete pad absorbs and dampens vibration associated with normal operation of a condensing unit.

FREEZE/THAW RESISTANT The UltraLite lightweight concrete pad is vapor permeable. Water vapor evaporates through the pad, hence the concrete outer skin is not subject to expansion cracks.

FLAME RESISTANT The concrete outer skin of the UltraLite lightweight concrete pad is resistant to heating caused by the compressor. Additionally, the surface is resistant to heat from incidental torch flame during site installation.

OUTSIDE STORAGE The UltraLite lightweight concrete pad is intended for life in the outdoors. As such, the pad is suitable for exterior storage prior to site installation.

TECHNICAL DATA

LOADING

To achieve the maximum permissible pad load capacity, the earth under the pad must be capable of supporting the transmitted compression load of the UltraLite pad. All values tabulated assume the earth has a bearing capacity of at least 1000 pounds per square foot (48 kPa).

The allowable loads assume a uniformly distributed loading on the pad surface (that is, a relatively flat-bottomed condenser unit in contact with the pad). For condenser units with footpads or other point loads, the maximum concentrated load for any size UltraLite pad is 125 pounds per 2" (56 kg per 50 mm) diameter (or equivalent surface area) footpad.

CHEMICAL RESISTANCE

In normal usage conditions an equipment pad can be exposed to a variety of chemicals. The UltraLite pad has been fully tested in accordance with ASTM D2299 for resistance against:

- R-22 and R-134a
- Compressor oil
- Salt solution, 20 percent by volume
- Synthetic canine urine

The UltraLite pad performs extraordinarily well under these testing criteria. UltraLite does not craze, soften, delaminate, or spall under exposure in this test.

FREEZE/THAW TESTING

The UltraLite pad has been independently tested to the rigorous freeze-thaw regimen specified by ASTM C67. This standard dictates a twenty-five cycle freeze-thaw sequence. The freeze portion of the sequence takes place with the top surface of the UltraLite pad under 1/2" (12 mm) of water. Once twenty-five cycles are complete, the pad is examined using visual magnification. No cracks or crazing is permitted. UltraLite has performed flawlessly.



CladLite® Equipment Pads

CladLite® Equipment Pads provide the strength and durability customers demand in an easy to install pad. CladLite® Pads are up to 80% lighter than solid concrete but still provide rock solid support for equipment. Once it's set, so are you. CladLite® Pads stay in place and can withstand anything mother nature can throw at them. These pads provide superior resistance to sun, moisture, and freeze-thaw conditions. And the vibration dampening EPS foam core is unaffected by water, soil, fungus or bacteria. CladLite® Pads are available in 2" and 3" thickness and more than 70 different sizes so you can get the exact pad you need for the job. Get the concrete pads that homeowners prefer – CladLite®.



Tough. Durable. Strong.

CladLite® Equipment Pads provide the strength and durability customers demand in an easy to install pad. CladLite® Pads are up to 80% lighter than solid concrete but still provide rock solid support for equipment. Once it's set, so are you. CladLite® Pads stay in place and can withstand anything mother nature can throw at them. These pads provide superior resistance to sun, moisture, and freeze-thaw conditions. And the vibration dampening EPS foam core is unaffected by water, soil, fungus or bacteria. Cladlite® Pads are available in 2" and 3" thickness and more than 70 different sizes so you can get the exact pad you need for the job. Get the concrete pads that homeowners prefer – Cladlite®.

CLADLITE® SPECIFICATIONS

Allowable Load: 125 lbs. per 2" diameter foot

Freeze/Thaw: Flawless performance under the 25-cycle regimen specified by ASTM C67

Chemical Resistance: Does not craze, soften, delaminate, or spall when tested per ASTM D2299 with the following:

- R-22 and R-134a
- Compressor oil
- Synthetic canine urine
- Salt solution, 20% by volume

Foam Core: ASTM Type 1 EPS

Flame Resistance:

Cladding resists compressor heat and incidental torch contact.

Not to be used under heating devices.



Heat Pump Pad™



Ideal for snowy climates, the new DiversiTech Heat Pump Pad™ is the perfect solution for protecting equipment and ensuring proper operation year round. The Heat Pump Pad™ provides

a full 8" clearance from ground level in a compact square footprint. Included with every Heat Pump Pad™ are 8 anti-vibration pads, specifically molded into slots in the pad to reduce vibration and provide quiet operation of your equipment. The base of the pad is also angled to direct melting snow or condensate away from the unit and pad. Heat Pump Pads are made from recycled polypropylene so they are eco-friendly and are built tough to provide many years of service. These pads also nest together for easier transportation and warehousing.

Each Heat Pump Pad™ includes eight Anti-Vibration pads fitted into special slots in the risers to reduce equipment vibration and noise.

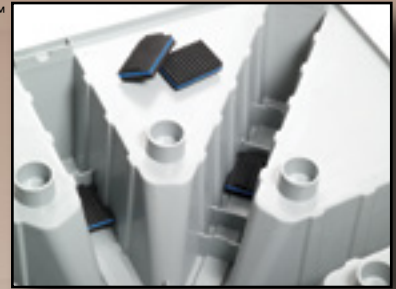

Stackable!

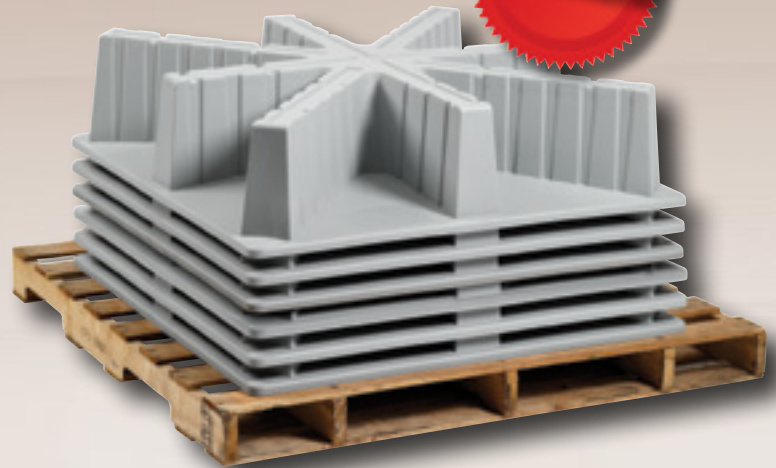



The Hurricane Pad™

THE HURRICANE PAD™ CONCRETE EQUIPMENT PAD

Hurricane strength equipment pads designed to Florida's tough standards.

DiversiTech's family of Hurricane Pads provide complete protection when the weather turns the worst. Three different models and dozens of sizes of The Hurricane Pad™ ensure you have the right pad for any area or need. Each DiversiTech Hurricane Pad™ includes these features:

- Steel reinforced
- 7,000 psi minimum concrete, mandatory to meet strict anchor pullout requirements
- Easier to install
- Will not float (unlike air filled pads)
- Uses standard Tapcon™ brand screws and no inserts are necessary
- Superior screw pullout strength



FLORIDA BUILDING CODE NOTICE

This product meets the following Florida Building Code requirements:

1. Florida Building Commission (DCA02-DEC-183) declares this pad to be an acceptable alternative material to solid concrete pads.
2. This pad meets Mechanical Volume, Section 304.10 – clearance from grade.
3. Pad weight and wind load requirements have been calculated by Master Consulting Engineers. For up to date calculations and documentation, visit our website: www.diversitech.com.

THE HURRICANE PAD™

The Hurricane Pad is designed for installations up to 150 MPH. The Hurricane Pad provides a solid base for mounting and protecting equipment threatened by adverse conditions.



THE HURRICANE PAD™ T CLASS

The Hurricane Pad T-Class is designed for even higher wind loads - up to 175 MPH. Ideal for south Florida counties and other heavily threatened areas, the T Class Hurricane Pads are heavier and provide additional concrete for superior anchor pullout strength.



THE HURRICANE PAD™ MD

The ultimate in protection, The Hurricane Pad MD is specifically designed for the strict regulations of Miami-Dade county. These solid concrete pads meet the Florida Building Code Notice and can withstand winds up to 175 MPH. This pad is made from a minimum 7000PSI solid concrete.



Equipment must be properly attached to The Hurricane Pad™ in order to prevent sliding and tipping in high winds.

Anti-Vibration Pads

EVA™ PAD: The BEST Performer

EVA™ (Extreme Vibration Attenuation) is the latest generation in vibration dampening technology. In the most severe vibration extremes, testing shows the EVA™ pad outperforms cork and rubber by greater than 3:1 and outperforms our competitor's "waffle" pad by greater than 8:1! The enhanced performance comes from the special composite foam center which is structurally more sound than cork. EVA™ is not affected by oils or chemicals that can break down cork and is much more effective at vibration dampening than solid rubber. Designed to withstand 50 psi. Choose EVA™ to get the best of both worlds!

ANTI-VIBRATION PAD PERFORMANCE

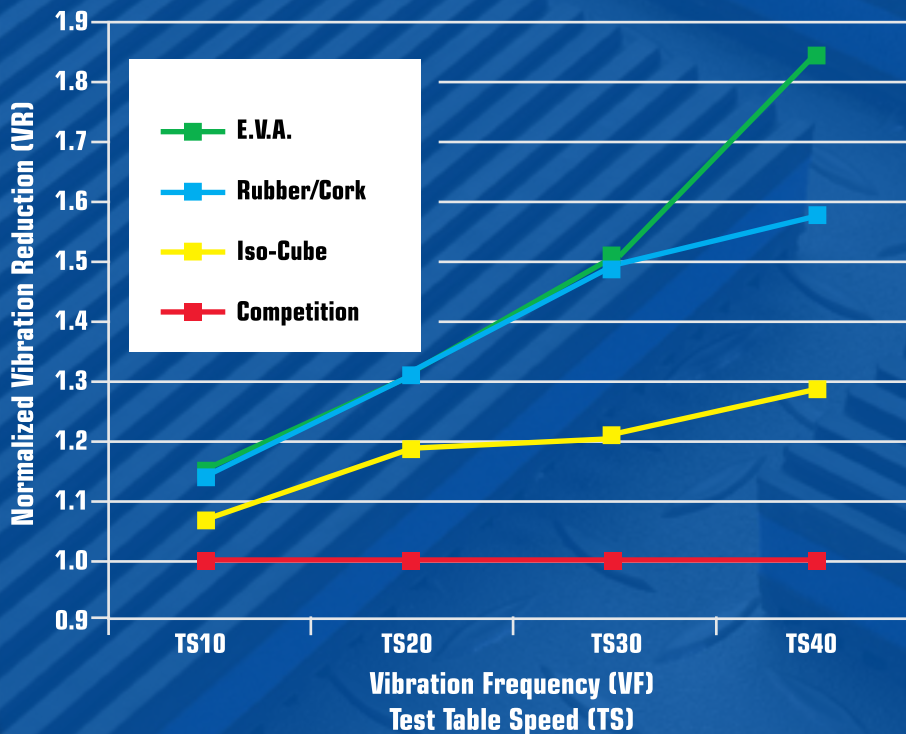

RUBBER/CORK PAD: The Industry Standard

These pads are made with the highest quality elastomeric oil resistant padding. Designed to withstand 50 psi. The rubber pads are corrugated on both sides and laminated to the cork center.

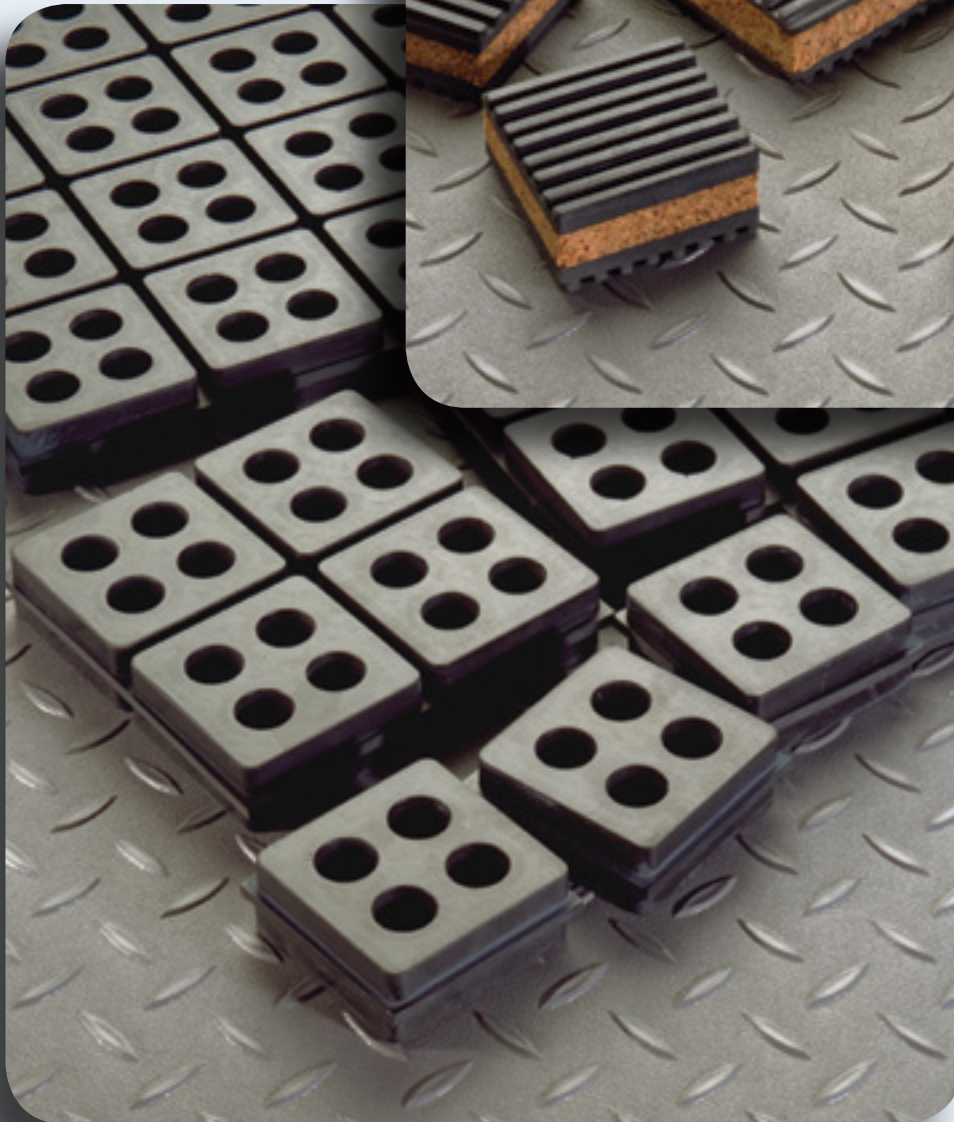
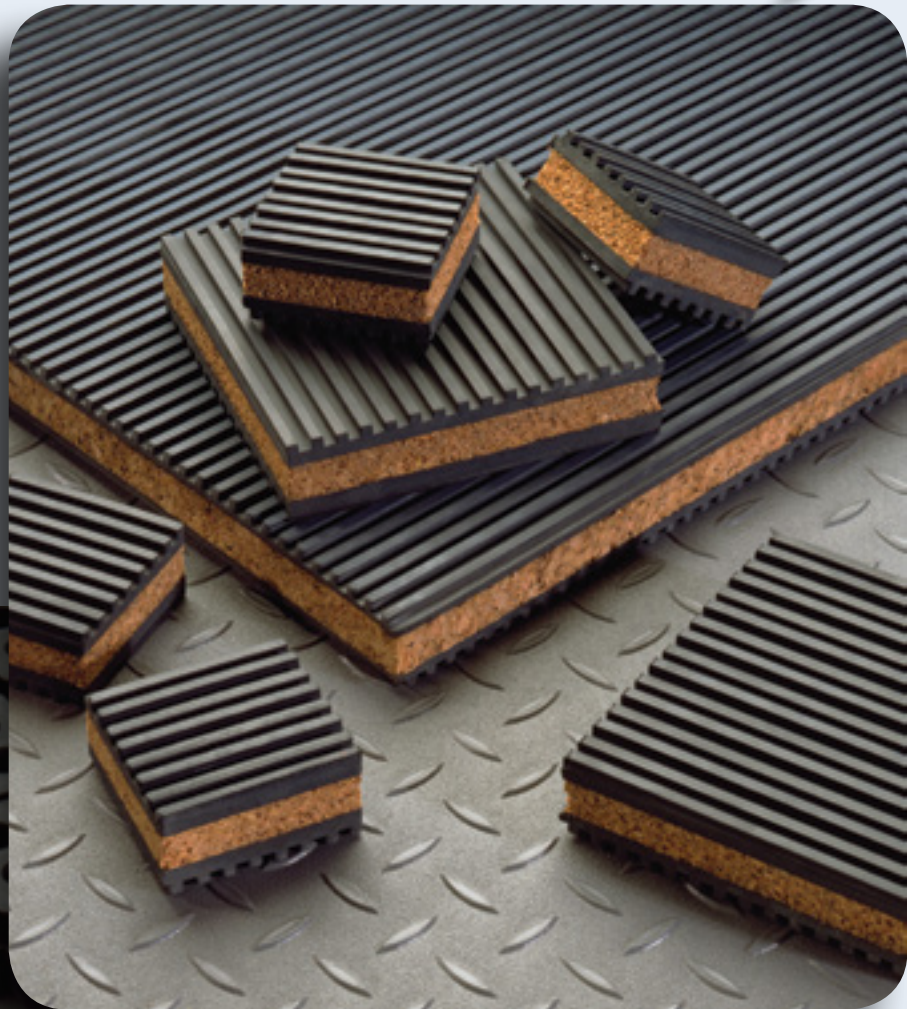

ISO-CUBE: Solid Rubber Tough

Natural rubber pads designed to reduce vibration and noise emanating from refrigeration or AC equipment. Circular design offers a suction cup effect eliminating the need to bolt the pads down. A standard 18" pad divides into eighty-one 2" segments which may be cut or torn into smaller pads. The 50 durometer pads will withstand a load of 180 psi with great resiliency.

ULTRALITE® LIGHTWEIGHT CONCRETE EQUIPMENT PADS

A true concrete equipment pad at the weight of plastic (about 2.5 lbs. per square foot). UltraLite® is strengthened by miles of fiber in each square foot of fiber-cement coating. This fiber allows the pad to flex instead of cracking or breaking. The textured surface prevents the condensing unit or portable generator from sliding, and allows water drainage, while the engineered expanded polystyrene (EPS) core prevents warping and provides a solid bottom to resist settling. Unaffected by soil conditions, ultraviolet (UV) light, temperature extremes, and other weather conditions.



UC2424-2

2" UltraLite® Pads

The 2" thick UltraLite® pad is the industry standard. Used across a wide variety of applications. Codes have moved toward requiring 3" pads, check local codes for your requirements.

CATALOG NO.	SIZE	PAD WT.	PALLET QTY.	PALLET WT.	UOM	ORDER MULTIPLE
UC1636-2	16 X 36	11	40	250	EA	40
UC2424-2	24 X 24	15	20	323	EA	20
UC2430-2	24 X 30	17	20	361	EA	20
UC2436-2	24 X 36	22	20	455	EA	20
UC2448-2	24 X 48	18	20	385	EA	20
UC2626-2	26 X 26	17	20	365	EA	20
UC2628-2	26 X 28	19	20	397	EA	20
UC3030-2	30 X 30	21	20	441	EA	20
UC3036-2	30 X 36	27	20	571	EA	20
UC3040-2	30 X 40	30	20	617	EA	20
UC3143-2	31 X 43	26	20	551	EA	20
UC3232-2	32 X 32	24	20	501	EA	20
UC3434-2	34 X 34	23	20	493	EA	20
UC3445-2	34 X 45	45	20	915	EA	20
UC3636-2	36 X 36	27	20	555	EA	20
UC3640-2	36 X 40	29	20	608	EA	20
UC3648-2	36 X 48	35	20	725	EA	20
UC3842-2	38 X 42	30	20	625	EA	20
UC4040-2	40 X 40	32	20	644	EA	20

U.S. Patents 7,334,385; 7,232,589; 6,931,822; 6,927,183; 5,728,458; 5,664,394; 5,268,226; 5,209,968, and patents pending. ICBO PFC-5112.

3" UltraLite® Pads

Where codes have moved toward requiring 3" pads, UltraLite® is the solution. Check local codes for your requirements.



UC2424-3

CATALOG NO.	SIZE	PAD WT.	PALLET QTY.	PALLET WT.	UOM	ORDER MULTIPLE
UC1636-3	16 X 36	18	30	297	EA	30
UC1838-3	18 X 38	18	30	297	EA	30
UC2424-3	24 X 24	18	15	294	EA	15
UC2430-3	24 X 30	21	15	339	EA	15
UC2436-3	24 X 36	26	15	412	EA	15
UC2442-3	24 X 42	28	15	441	EA	15
UC2448-3	24 X 48	28	15	443	EA	15
UC2626-3	26 X 26	17	15	279	EA	15
UC3030-3	30 X 30	23	15	370	EA	15
UC3036-3	30 X 36	30	15	471	EA	15
UC3040-3	30 X 40	33	15	517	EA	15
UC3232-3	32 X 32	26	15	411	EA	15
UC3237-3	32 X 37	27	15	436	EA	15
U3353-3	33 X 53	68	15	1,045	EA	15
UC3434-3	34 X 34	27	15	427	EA	15
UC3445-3	34 X 45	39	15	612	EA	15
UC3636-3	36 X 36	34	15	528	EA	15
UC3642-3	36 X 42	32	15	510	EA	15
UC3648-3	36 X 48	37	15	579	EA	15
U3650-3	36 X 50	38	15	595	EA	15
U3654-3	36 X 54	71	15	1,096	EA	15
U3660-3	36 X 60	49	15	767	EA	15
U3678-3	36 X 78	99	15	1,510	EA	15
UC3842-3	38 X 42	35	15	550	EA	15
U3865-3	38 X 65	85	15	1,300	EA	15
U3870-3	38 X 70	113	15	1,720	EA	15
UC4040-3	40 X 40	34	15	510	EA	15
UC4042-3	40 X 42	36	15	565	EA	15
U4054-3	40 X 54	81	15	1,240	EA	15
UC4347-3	43 X 47	60	15	925	EA	15
U4550-3	45 X 50	81	15	1,240	EA	15
U4558-3	45 X 58	93	15	1,420	EA	15
U4848-3	48 X 48	85	15	1,300	EA	15
U4854-3	48 X 54	91	15	1,390	EA	15
U4866-3	48 X 66	108	15	1,645	EA	15
U5053-3	50 X 53	92	15	1,405	EA	15
U5056-3	50 X 56	97	15	1,480	EA	15
U5075-3	50 X 75	130	15	1,975	EA	15
U5079-3	50 X 79	145	15	2,200	EA	15
U5252-3	52 X 52	94	15	1,435	EA	15
U5260-3	52 X 60	109	15	1,660	EA	15
U5557-3	55 X 57	109	15	1,660	EA	15
U6067-3	60 X 67	134	15	2,035	EA	15

ULTRALITE® LIGHTWEIGHT CONCRETE EQUIPMENT PADS cont'd

3" UltraLite® Wedge Pads

The UltraLite® Wedge Pad is designed for Lennox condensing units.



UC3132-3L

CATALOG NO.	SIZE	PAD WT.	PALLET QTY.	PALLET WT.	UOM	ORDER MULTIPLE
UC3132-3L	31 X 32	23.33	15	350	EA	15
UC3539-3L	35 X 39	33.46	15	502	EA	15
UC4044-3L	40 X 44	37.53	15	563	EA	15

UltraLite® Earthquake Code Compliant Pads

Required nearly exclusively in Southern California, the UltraLite® pad is available for compliance with strict attachment provisions detailed in earthquake prone local building codes. UltraLite® earthquake code compliant pads are only available for sale in regions where local codes mandate installation of pads with these particular characteristics. Currently these locales include most of Southern California, portions of Washington, and portions of Oregon.



UC2424-3CA

CATALOG NO.	SIZE	PAD WT.	PALLET QTY.	PALLET WT.	UOM	ORDER MULTIPLE
UC1838-3CA	18 X 38	18	15	273	EA	15
UC2424-3CA	24 X 24	14	15	241	EA	15
UC2436-3CA	24 X 36	22	15	349	EA	15
UC2448-3CA	24 X 48*	28	15	443	EA	15
UC2636-3CA	26 X 36	29	15	428	EA	15
UC3030-3CA	30 X 30	22	15	351	EA	15
UC3036-3CA	30 X 36	25	15	400	EA	15
UC3040-3CA	30 X 40	34	15	510	EA	15
UC3232-3CA	32 X 32	24	15	381	EA	15
UC3445-3CA	34 X 45	33	15	516	EA	15
UC3636-3CA	36 X 36	28	15	441	EA	15
UC3642-3CA	36 X 42	32	15	510	EA	15
UC3648-3CA	36 X 48	37	15	579	EA	15
UC4040-3CA	40 X 40	34	15	510	EA	15

E LITE® PLASTIC EQUIPMENT PADS

E Lite's rugged design provides uniform and generous ribbing for optimum, self-leveling ground support without inserts. The result is a pad that is lightweight, but not too light. A subtle texture prevents unit slide and presents a classic appearance, which is enhanced by rounded edges and a concrete gray color. Each pad is molded with a size label and a symbol representing content of recycled material.

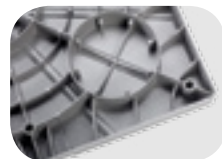

2" E Lite® Pads

The 2" thick E Lite® pad is the choice for plastic pads. Codes have moved toward requiring 3" pads, check local codes for your requirements.

CATALOG NO.	SIZE	PAD WT.	PALLET QTY.	PALLET WT.	UOM	ORDER MULTIPLE
EL2424-2	24 X 24	7	44	333	EA	44
EL2430-2	24 X 30	9	22	219	EA	22
EL2436-2	24 X 36	11	22	256	EA	22
EL2626-2	26 X 26	8	22	205	EA	22
EL3030-2	30 X 30	11	22	265	EA	22
EL3036-2	30 X 36	13	22	313	EA	22
EL3040-2	30 X 40	15	22	346	EA	22
EL3232-2	32 X 32	13	22	300	EA	22
EL3244-2	32 X 44	17	22	401	EA	22
EL3434-2	34 X 34	14	22	350	EA	22
EL3636-2	36 X 36	16	22	373	EA	22
EL3640-2	36 X 40	18	22	410	EA	22
EL3648-2	36 X 48	29	22	663	EA	22
EL3842-2	38 X 42	19	22	470	EA	22

3" E Lite® Pads

Codes have moved toward requiring 3" pads, check local codes for your requirements.



EL5658-3

CATALOG NO.	SIZE	PAD WT.	PALLET QTY.	PALLET WT.	UOM	ORDER MULTIPLE
EL1838-3	18 X 38	16	32	300	EA	32
EL2424-3	24 X 24	13	16	225	EA	16
EL2436-3	24 X 36	19	16	321	EA	16
EL3030-3	30 X 30	20	16	345	EA	16
EL3232-3	32 X 32	21	16	353	EA	16
EL3244-3	32 X 44	30	16	499	EA	16
EL3636-3	36 X 36	28	16	471	EA	16
EL3640-3	36 X 40	31	16	521	EA	16
EL3648-3	36 X 48	36	16	601	EA	16
EL3842-3	38 X 42	33	16	575	EA	16
EL3870-3	38 X 70	36	16	604	EA	16
EL4040-3	40 X 40	31	16	546	EA	16
EL4558-3	45 X 58	33	16	545	EA	16
EL4848-3	48 X 48	29	16	481	EA	16
EL5252-3	52 X 52	48	16	793	EA	16
EL5658-3	56 X 58	43	16	715	EA	16

CLADLITE® LIGHTWEIGHT CONCRETE EQUIPMENT PADS

Concrete surface and superior performance at 20% the weight of conventional concrete pads. The cladding provides superior resistance to sun, moisture and freeze-thaw conditions; the engineered expanded polystyrene (EPS) core is virtually impervious to water, soil conditions, fungus and bacteria. Large CladLite® pads are further strengthened by continuous steel reinforcement throughout the cladding. CladLite® is code approved for installation throughout the U.S.

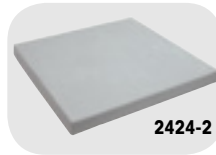

2" CladLite® Pads

The 2" thick CladLite® pad is the choice for equipment pads. Codes have moved toward requiring 3" pads, check local codes for your requirements.

CATALOG NO.	SIZE	PAD WT.	PALLET QTY.	PALLET WT.	UOM	ORDER MULTIPLE
1636-2	16 X 36	33	25	850	EA	25
2424-2	24 X 24	36	25	913	EA	25
2436-2	24 X 36	50	25	1,275	EA	25
2442-2	24 X 42	57	25	1,450	EA	25
2454-2	24 X 54	84	25	2,125	EA	25
26-2	26 Round	31	25	800	EA	25
2626-2	26 X 26	38	25	975	EA	25
2660-2	26 X 60	95	25	2,400	EA	25
30-2	30 Round	36	25	925	EA	25
3030-2	30 X 30	48	25	1,225	EA	25
3036-2	30 X 36	60	25	1,525	EA	25
3143-2	31 X 43	83	25	2,100	EA	25
32-2	32 Round	44	25	1,125	EA	25
3232-2	32 X 32	54	25	1,375	EA	25
3434-2	34 X 34	63	25	1,600	EA	25
3636-2	36 X 36	76	25	1,925	EA	25
3640-2	36 X 40	81	25	2,050	EA	25
3648-2	36 X 48	115	25	2,900	EA	25
3654-2	36 X 54	93	25	2,350	EA	25

3" CladLite® Pads

Used where codes have moved toward requiring 3" pads, check local codes for your requirements.

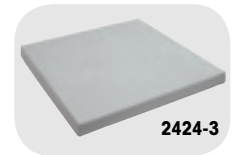

CATALOG NO.	SIZE	PAD WT.	PALLET QTY.	PALLET WT.	UOM	ORDER MULTIPLE
1636-3	16 X 36	46	20	945	EA	20
2424-3	24 X 24	49	20	995	EA	20
2436-3	24 X 36	63	20	1,285	EA	20
2448-3	24 X 48	71	20	1,445	EA	20
2460-3	24 X 60	105	20	2,125	EA	20
2626-3	26 X 26	53	20	1,085	EA	20
3030-3	30 X 30	62	20	1,265	EA	20
3036-3	30 X 36	71	20	1,445	EA	20
3060-3	30 X 60	130	15	1,975	EA	15
3143-3	31 X 43	74	20	1,505	EA	20
32-3	32 Round	67	20	1,365	EA	20
3232-3	32 X 32	68	20	1,385	EA	20
3237-3	32 X 37	87	20	1,765	EA	20
3345-3	33 X 45	117	20	2,365	EA	20
3636-3	36 X 36	100	20	2,025	EA	20
3640-3	36 X 40	120	20	2,425	EA	20
3648-3	36 X 48	132	20	2,665	EA	20
3650-3	36 X 50	137	15	2,080	EA	15
3660-3	36 X 60	163	15	2,470	EA	15
3678-3	36 X 78	196	10	1,985	EA	10
3842-3	38 X 42	132	20	2,700	EA	20
3870-3	38 X 70	179	10	1,815	EA	10
4042-3	40 X 42	170	10	1,700	EA	10
4054-3	40 X 54	167	15	2,530	EA	15
4062-3	40 X 62	179	10	1,815	EA	10
4147-3	41 X 47	140	15	2,125	EA	15
4183-3	41 X 83	231	10	2,335	EA	10
4550-3	45 X 50	158	15	2,395	EA	15
4558-3	45 X 58	177	15	2,680	EA	15
4766-3	47 X 66	219	10	2,215	EA	10
4848-3	48 X 48	150	15	2,275	EA	15
5053-3	50 X 53	194	15	2,935	EA	15
5056-3	50 X 56	212	10	2,145	EA	10
5058-3	50 X 58	212	10	2,145	EA	10
5070-3	50 X 70	257	10	2,595	EA	10
5252-3	52 X 52	197	10	1,995	EA	10
5557-3	55 X 57	237	10	2,395	EA	10
6067-3	60 X 67	284	10	2,865	EA	10

THE HURRICANE PAD™ CONCRETE EQUIPMENT PADS

The Hurricane Pad™

Designed specifically for the hurricane prone regions of Florida and the Gulf Coast, The Hurricane Pad™ meets stringent local code requirements for wind resistance. Heavier than a normal concrete pad, this 4" pad provides sufficient weight to meet code. The Hurricane Pad meets the Florida Building Code Notice and can withstand winds up to 150 MPH. For certain taller equipment, The Hurricane T Class Pad™ is needed. Due to their extra weight, standard freight terms only apply for shipments to Florida. All other shipments are shipped FOB Conyers, GA.

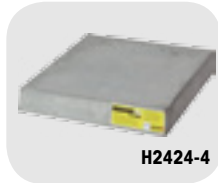

H2424-4

The Hurricane T-Class Pad™

The Hurricane T Class Pad™ is even heavier than The Hurricane Pad™ and is designed to meet the higher wind loads of taller equipment. The taller the piece of equipment mounted to the pad, the greater the wind load on the pad. These heavier 4" pads provide sufficient weight to meet code for these taller condensing units. The Hurricane T-Class Pad meets the Florida Building Code Notice and can withstand winds up to 175 MPH. Due to their extra weight, standard freight terms for The Hurricane T Class Pad™ only apply for shipments to Florida. All other shipments are shipped FOB Conyers, GA.



HT2424-4

CATALOG NO.	SIZE	PALLET QTY.	UOM	ORDER MULTIPLE
H1840-4	18 X 40	16	EA	16
H2424-4	24 X 24	16	EA	16
H2436-4	24 X 36	16	EA	16
H3030-4	30 X 30	16	EA	16
H3232-4	32 X 32	16	EA	16
H3345-4	33 X 45	16	EA	16
H3636-4	36 X 36	16	EA	16
H3642-4	36 X 42	16	EA	16
H3648-4	36 X 48	16	EA	16
H3652-4	36 X 52	8	EA	8
H3654-4	36 X 54	8	EA	8
H3672-4	36 X 72	8	EA	8
H3842-4	38 X 42	8	EA	8
H3852-4	38 X 52	8	EA	8
H3865-4	38 X 65	8	EA	8
H3872-4	38 X 72	8	EA	8
H4040-4	40 X 40	8	EA	8
H4242-4	42 X 42	8	EA	8
H4558-4	45 X 58	8	EA	8
H5557-4	55 X 57	8	EA	8

CATALOG NO.	SIZE	PALLET QTY.	UOM	ORDER MULTIPLE
HT1840-4	18 X 24	10	EA	10
HT2424-4	24 X 24	5	EA	5
HT2436-4	24 X 36	5	EA	5
HT3030-4	30 X 30	5	EA	5
HT3232-4	32 X 32	5	EA	5
HT3345-4	33 X 45	5	EA	5
HT3636-4	36 X 36	5	EA	5
HT3648-4	36 X 48	5	EA	5
HT3656-4	36 X 56	5	EA	5
HT3842-4	38 X 42	5	EA	5
HT3852-4	38 X 52	5	EA	5
HT4040-4	40 X 40	5	EA	5
HT4242-4	42 X 42	5	EA	5
HT4558-4	45 X 58	5	EA	5

Potential Hurricane Winds Map



The Hurricane Pad™ MD

The new Hurricane Pad™ MD is the newest in concrete pad technology from DiversiTech. The Hurricane Pad MD is a solid concrete pad designed for the strict requirements of Miami Dade county. The Hurricane Pad MD meets the Florida Building Code Notice and can withstand winds up to 175 MPH. This pad is made from a minimum 7000PSI solid concrete. For Florida shipments only.

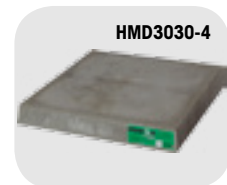

HMD3030-4

CATALOG NO.	SIZE	PALLET QTY.	UOM	ORDER MULTIPLE
HMD1844-4	18 X 40 X 4	5	EA	5
HMD2436-4	24 X 36 X 4	5	EA	5
HMD3030-4	30 X 30 X 4	5	EA	5
HMD3636-4	36 X 36 X 4	5	EA	5
HMD3648-4	36 X 48 X 4	5	EA	5
HMD3842-4	38 X 42 X 4	5	EA	5
HMD4040-4	40 X 40 X 4	5	EA	5

The Hurricane Pad Attachment Bracket

Bracket secures condenser to The Hurricane Pad. Use #8 self drilling or self tapping screws to secure condenser to brackets. Be sure to place brackets according to local building code requirements. Made of 12 gauge ASTM A653 Grade 40 steel with G90 coating.



HC-1

CATALOG NO.	DESCRIPTION	UOM	ORDER MULTIPLE
HC-1	The Hurricane Pad Attachment Bracket, pack of 4 PK	PK	1
HC-1-100	The Hurricane Pad Attachment Bracket, pack of 100 PK	PK	1

THE BLACK PAD® BLACK PLASTIC EQUIPMENT PADS

The Black Pad® is an innovative equipment pad. The pad is extremely durable, resistant to ultraviolet light, and heavier than a completely plastic pad. The Black Pad® is suitable for use with pool pumps, filters, and heaters and complies with the 1997 Standard Swimming Pool Code sections 305.2 Mounting and section 405 Equipment Foundations and Enclosures.



ACP24242

The Black Pad® — 3"

Used where codes have moved toward requiring 3" pads. Check local codes for your requirements.

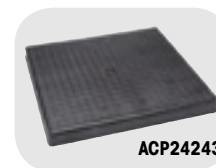

ACP24243

The Black Pad® — 2"

The 2" thick Black Pad® is the choice for plastic pads. Codes have moved toward requiring 3" pads, check local codes for your requirements.

CATALOG NO.	SIZE	PAD WT.	PALLET QTY.	PALLET WT.	UOM	ORDER MULTIPLE
ACP24242	24 X 24	10	24	240	EA	24
ACP24362	24 X 36	15	24	360	EA	24
ACP30302	30 X 30	13	24	312	EA	24
ACP32322	32 X 32	16	24	384	EA	24
ACP36362	36 X 36	19	24	456	EA	24
ACP38422	38 X 42	25	24	600	EA	24

CATALOG NO.	SIZE	PAD WT.	PALLET QTY.	PALLET WT.	UOM	ORDER MULTIPLE
ACP24243	24 X 24	12	16	192	EA	16
ACP30303	30 X 30	20	16	320	EA	16
ACP32323	32 X 32	25	16	400	EA	16
ACP36363	36 X 36	23	16	368	EA	16
ACP36483	36 X 48	37	16	592	EA	16

HEF-T-PAD™ PLASTIC EQUIPMENT PADS

Hef-T-Pad® is an injection molded equipment pad created from high impact polypropylene with UV inhibitors making it easy to handle, yet durable and strong. It does not require any additional equipment for moving and handling. It is resistant to impact, ultra violet degradation and weathering and will not crack, flake, or warp. The Hef-T-Pad® is virtually impervious to climatic variations. It is drillable to permit installation of refrigerant and electrical lines under and through the pad and to allow equipment to be easily secured to the pad.

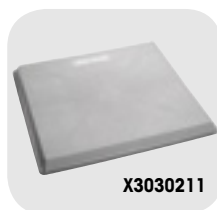

X3030211

Hef-T-Pad® — 3"

Used where codes have moved toward requiring 3" pads. Check local codes for your requirements.

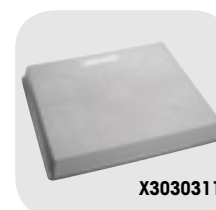

X3030311

Hef-T-Pad® — 2"

The 2" thick Hef-T-Pad® is the choice for plastic pads. Codes have moved toward requiring 3" pads, check local codes for your requirements.

CATALOG NO.	SIZE	PAD WT.	PALLET QTY.	PALLET WT.	UOM	ORDER MULTIPLE
X2424211	24 X 24 X 2	6	24	208	EA	24
X2430211	24 X 30 X 2	8	24	251	EA	24
X2436211	24 X 36 X 2	10	24	290	EA	24
X3030211	30 X 30 X 2	10	24	290	EA	24
X3232211	32 X 32 X 2	11	24	312	EA	24
X3244211	32 X 44 X 2	14	24	382	EA	24
X3636211	36 X 36 X 2	13	24	367	EA	24
X3836211	38 X 36 X 2	14	24	376	EA	24
X3842211	38 X 42 X 2	17	24	464	EA	24

CATALOG NO.	SIZE	PAD WT.	PALLET QTY.	PALLET WT.	UOM	ORDER MULTIPLE
X2424311	24 X 24 X 3	9	16	200	EA	16
X2436311	24 X 36 X 3	12	16	242	EA	16
X3030311	30 X 30 X 3	13	16	264	EA	16
X3232311	32 X 32 X 3	16	16	300	EA	16
X3636311	36 X 36 X 3	17	16	319	EA	16
X3848311	38 X 48 X 3	24	16	400	EA	16

ECOPAD™ BLACK PLASTIC EQUIPMENT PADS

An injection molded equipment pad created from 100% recycled materials to minimize environmental impact. It does not require any additional equipment for moving and handling. EcoPad™ is resistant to impact, ultra-violet degradation and weathering (virtually impervious to climatic variations), and will not crack, flake, or warp. Drillable to permit installation of refrigerant and electrical lines under and through the pad and to allow equipment to easily secure to the pad.



EcoPad™ — 3"

Used where codes have moved toward requiring 3" pads, check local codes for your requirements.



EcoPad™ — 2"

The 2" thick EcoPad™ is the choice for plastic pads. Codes have moved toward requiring 3" pads, check local codes for your requirements.

CATALOG NO.	SIZE	PAD WT.	PALLET QTY.	PALLET WT.	UOM	ORDER MULTIPLE
EP2424-2	24 X 24 X 2	6	24	208	EA	24
EP2436-2	24 X 36 X 2	10	24	240	EA	24
EP3030-2	30 X 30 X 2	10	24	290	EA	24
EP3232-2	32 X 32 X 2	11	24	312	EA	24
EP3244-2	32 X 44 X 2	14	24	382	EA	24
EP3636-2	36 X 36 X 2	13	24	367	EA	24
EP3842-2	38 X 42 X 2	17	24	450	EA	24

CATALOG NO.	SIZE	PAD WT.	PALLET QTY.	PALLET WT.	UOM	ORDER MULTIPLE
EP1838-3	18 X 38 X 3	10	32	166	EA	32
EP2424-3	24 X 24 X 3	9	16	200	EA	16
EP3030-3	30 X 30 X 3	13	16	264	EA	16
EP3232-3	32 X 32 X 3	16	16	300	EA	16
EP3244-3	32 X 44 X 3	14	16	273	EA	16
EP3636-3	36 X 36 X 3	17	16	319	EA	16
EP3648-3	36 X 48 X 3	23	16	368	EA	16
EP3842-3	38 X 42 X 3	20	16	323	EA	16
EP4040-3	40 X 40 X 3	28	16	496	EA	16

HEAT PUMP PAD™

Heat Pump Pad™

Provides an effective base for heat pump equipment installed in snowy climates. Rather than a combination of a typical 2" (or 3") equipment pad and 6" heat pump risers, the Heat Pump Pad™ provides a full 8" of elevation in a simple square footprint. The star pattern of the integral risers allows for installation of equipment with different size footprints up to 36" x 36". Also included are eight anti vibration pads uniquely designed to fit into the guide slots on the top of the integral risers. The base is sloped outward to allow for easy drainage of condensate or defrost cycle condensate when the outdoor coil is operating in heat pump mode. Nestable for efficient shipping, transportation, and warehousing. Injection molded from concrete gray, recycled polypropylene material, the Heat Pump Pad™ is environmentally friendly and designed to last longer than the equipment it supports. US Patent Number 7,891,635, and other patent(s) pending.



CATALOG NO.	DESCRIPTION	UOM	ORDER MULTIPLE
HP3232-8	32" x 32" x 8"	EA	16
HP3636-8	36" x 36" x 8"	EA	16

ANTI-VIBRATION PADS

E.V.A. Anti-Vibration Pad

The latest generation in vibration dampening technology. The most effective vibration dampening pad available on the market. The EVA Pad was tested against other pads at four different vibration settings. In the most severe vibration extremes, the EVA Pad outperforms cork and rubber by a margin of greater than 3:1! This is due to the special composite foam center which is much more structurally sound than cork. It is not affected by oils or chemicals that can break down cork and is much more effective at vibration dampening than solid rubber. All this at a very competitive price. Designed to withstand 50 psi.

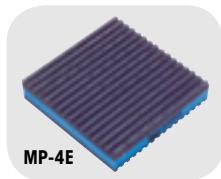

CATALOG NO.	DESCRIPTION	UOM	ORDER MULTIPLE
MP-2E	2" x 2" x 7/8" E.V.A. Pad	EA	48
MP-3E	3" x 3" x 7/8" E.V.A. Pad	EA	36
MP-4E	4" x 4" x 7/8" E.V.A. Pad	EA	24
MP-6E	6" x 6" x 7/8" E.V.A. Pad	EA	24
MP-12E	12" x 12" x 7/8" E.V.A. Pad	EA	12
MP-18E	18" x 18" x 7/8" E.V.A. Pad	EA	6

Rubber Anti-Vibration Pad

Highest quality elastomeric oil resistant padding. Designed to withstand 50 lbs. psi. The rubber pads are corrugated on both sides. Ideal for air conditioners, compressors, cooling towers, presses, machines, etc.

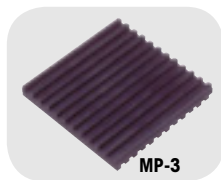

CATALOG NO.	DESCRIPTION	UOM	ORDER MULTIPLE
MP-2	2" x 2" x 3/8" Rubber	EA	48
MP-3	3" x 3" x 3/8" Rubber	EA	36
MP-4	4" x 4" x 3/8" Rubber	EA	24
MP-6	6" x 6" x 3/8" Rubber	EA	24
MP-8	8" x 8" x 3/8" Rubber	EA	12
MP-12	12" x 12" x 3/8" Rubber	EA	12
MP-18	18" x 18" x 3/8" Rubber	EA	6

Rubber/Cork Anti-Vibration Pad

Highest quality elastomeric oil resistant padding. Designed to withstand 50 psi. The rubber pads are corrugated on both sides. The cork is laminated between two corrugated pads. Ideal for air conditioners, compressors, cooling towers, presses, machines, etc.

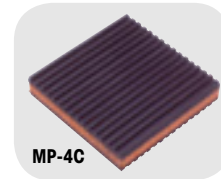

CATALOG NO.	DESCRIPTION	UOM	ORDER MULTIPLE
MP-2C	2" x 2" x 7/8" Rubber/Cork	EA	48
MP-3C	3" x 3" x 7/8" Rubber/Cork	EA	36
MP-4C	4" x 4" x 7/8" Rubber/Cork	EA	24
MP-6C	6" x 6" x 7/8" Rubber/Cork	EA	24
MP-8C	8" x 8" x 7/8" Rubber/Cork	EA	12
MP-12C	12" x 12" x 7/8" Rubber/Cork	EA	12
MP-18C	18" x 18" x 7/8" Rubber/Cork	EA	6

Iso-Cube Economy Anti-Vibration Pad

Natural rubber pads, designed to reduce vibration and noise emanating from refrigeration and air conditioning equipment. The circular design in each pad offers a suction cup effect, which eliminates the need to bolt the pads down. A standard 18" (46cm) pad is divided into eighty-one 2" (5cm) segments, each of which may be cut or torn to provide smaller pads. These 50 durometer pads will withstand a load of 180 psi with greater resiliency.



CATALOG NO.	DESCRIPTION	UOM	ORDER MULTIPLE
ISO-2	2" x 2" x 3/4" Iso-Cube	EA	24
ISO-4	4" x 4" x 3/4" Iso-Cube	EA	12
ISO-18	18" x 18" x 3/4" Iso-Cube	EA	6

MOUNTING SYSTEMS

Equipment Stands	33-34
Hanging Brackets.....	35
Heat Pump Risers	30
Mini-Split Stands	32
Mounting Blocks.....	30-31
Mounting Brackets.....	31-32

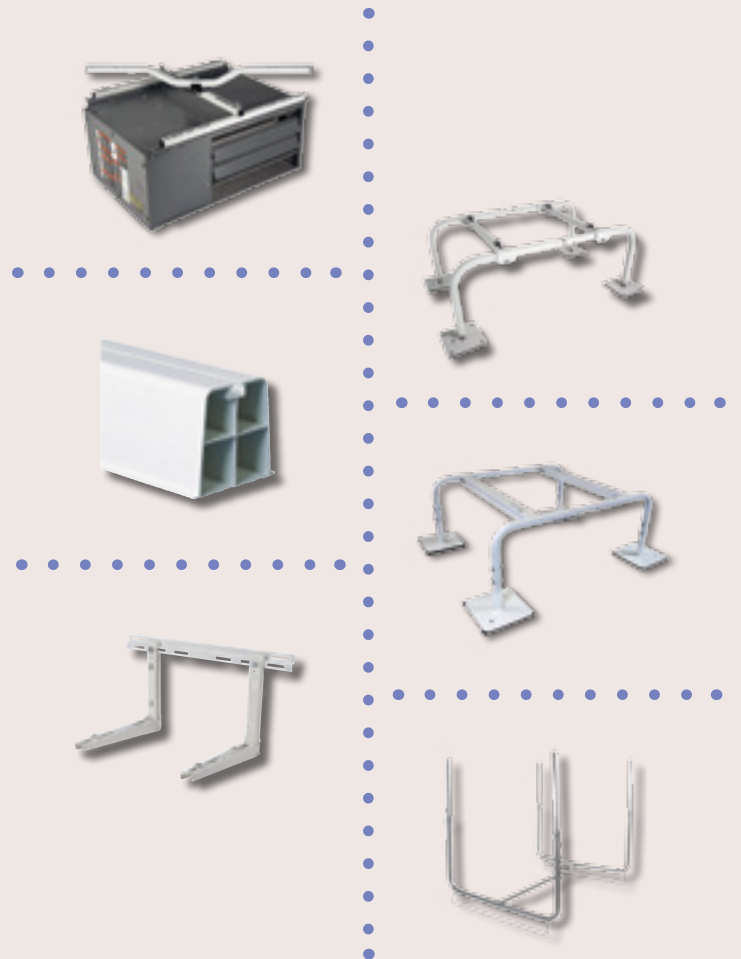



MINI-SPLIT OUTDOOR UNIT STANDS

QSMS1201

MINI-SPLIT WALL BRACKETS

QSWB2000



UNIT HEATER SWIVEL BRACKETS

QSWI4000



**VRF/VRV
EQUIPMENT STANDS**
QSSS1019



**UNIT HEATER
SWIVEL
BRACKETS**
QSWI3000

Hef-T-Foot™

Recycled rubber condensing unit and accessory mounting blocks.



ROOFTOP INSTALLATIONS



*Hef-T-Foot™ —
Rooftop/Ground Mount
Installation*



*Hef-T-Foot™ —
Rooftop/Ground Mount
Accessory/Pipe Support
Installation*

UTILITY ROOM INSTALLATIONS



Hef-T-Foot™ — Utility Room Installation, Gravity Drain

Condensate management is needed for heat pumps.



Hef-T-Foot™ — Utility Room Installation, Condensate Pump

Hef-T-Bracket™ — Wall Mounted Mini-Split Brackets



HEF-T-BRACKET™ TYPE 2
 These brackets feature a cross bar that is attached to a wall and two L-shaped brackets that are hooked and bolted into place on the cross bar.



When operating in heat pump mode, the unit will produce condensate which is easily captured and managed using this snap on drain pan.

HEAT PUMP RISERS

One Piece Heat Pump Risers

Sturdy and stable, DiversiTech's Heat Pump Riser provides the desired elevation for condensers, heat pumps, and air handlers. The one piece, heavy duty plastic unit is manufactured in three heights. Butyl mastic on the top and bottom guarantees no slipping and reduced vibration and noise.



CATALOG NO.	DESCRIPTION	UOM	ORDER MULTIPLE
HPR-3	Riser - 3"	EA	48
HPR-6	Riser - 6"	EA	36
HPR-12	Riser - 12"	EA	16

Adjustable Equipment Risers

Adjustable equipment risers easily adjust up or down as needed to secure equipment at the correct height. The large center barrel twists up from starting height of 5" to a max of 8". A separate top cap allows for raising or lowering the riser even with equipment already on it. Convenient height markings provided for reference.



CATALOG NO.	DESCRIPTION	UOM	ORDER MULTIPLE
AER-8	Adjustable Equipment Riser - 8"	EA	4
AER-8BL	Adjustable Equipment Riser - 8" Black	EA	4

Two Piece Heat Pump Risers

Sturdy and stable, DiversiTech's Heat Pump Riser provides the desired elevation for condensers, heat pumps, and air handlers. The one piece, heavy duty plastic unit is manufactured in two heights and an extension. Butyl mastic on the top and bottom guarantees no slipping and reduced vibration and noise.



CATALOG NO.	DESCRIPTION	UOM	ORDER MULTIPLE
HPR-3-2P	Two Piece Riser - 3"	EA	32
HPR-6-2P	Two Piece Riser - 6"	EA	16
HPR-3-2PG	Two Piece Black Riser - 3"	EA	32
HPR-6-2PG	Two Piece Black Riser - 6"	EA	16
HPR-EXT	4" Extension	EA	28

MOUNTING BLOCKS

Air Handler Block

Lightweight styrofoam block (concrete gray) provides A/C air handler support in attic installations.

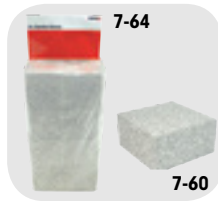

CATALOG NO.	DESCRIPTION	UOM	ORDER MULTIPLE
7-60	Air Handler Block 8" x 8" x 4"	EA	144
7-64	Air Handler Block 8" x 8" x 4", pack of 4	PK	4

Base Pad

Used as a mounting base when condensing units must be bolted down. Maximum load capacity is 220 lbs. per pad. Sliding rail design for easy and fast installation. Includes mounting bolts. Available in 14" and 17" lengths. Ivory color.



CATALOG NO.	DESCRIPTION	UOM	ORDER MULTIPLE
230-BP17W	17" Base Pad, pack of 2	PK	10

Furnace Mounting Blocks

Each furnace mounting block can support 40% more weight than competitive products - over 500 pounds! Easy peel and stick installation.



CATALOG NO.	DESCRIPTION	UOM	ORDER MULTIPLE
FB-1	Furnace Mounting Block	EA	72

Hef-T-Block™

Used as mounting bases when condensing units must be bolted down. Available in three lengths. Furnished complete with end caps and mounting bolts. Maximum load capacity is 440 pounds per mounting block. Installation temperature range from 4F (20C) to 140F (60C). Hef T Blocks fit all mini split condensing units with a unique sliding rail feature.



CATALOG NO.	DESCRIPTION	UOM	ORDER MULTIPLE
230-MB14W	14" Hef-T-Block™ (White), pack of 2	PK	6
230-MB17W	17" Hef-T-Block™ (White), pack of 2	PK	6
230-MB36W	36" Hef-T-Block™ (White), pack of 2	PK	2
230-MBCW	Hef-T-Block™ Replacement End Cap (White), pack of 4	PK	25

A/C Riser Block

The A/C Riser Block gives you a fast and easy way to elevate an air handler or furnace 2.5 in. off the floor or drain pan. The unique stacking feature provides variable height adjustment from a single block height of 2.5 in. in increments of .75 in.



CATALOG NO.	DESCRIPTION	UOM	ORDER MULTIPLE
ACR-1	A/C Riser Block	EA	100

MOUNTING BLOCKS cont'd

Hef-T-Foot™

The Hef-T-Foot™ is used to support small pipework, runs of cable tray, or an alternative to supporting condensing units, air source heat pumps or a variety of outdoor equipment.

The Hef-T-Foot™ with strut comes in four lengths — 9.8", 15.7", 23.6", 39.4". They are manufactured from heavy duty recycled rubber and come complete with .8" x 1.6" galvanized steel strut adhered to the rubber with industrial adhesive. The rubber is strong and durable with drain slots moulded into the underside to allow standing water to flow under the foot.

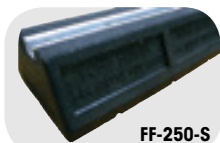

FF-250-S



FF-250-UNI

CATALOG NO.	DESCRIPTION	UOM	ORDER MULTIPLE
FF-250-S	Hef-T-Foot™ – 9.8" with 1.6" x .8" strut	EA	1
FF-400-S	Hef-T-Foot™ – 15.7" with 1.6" x .8" strut	EA	1
FF-600-S	Hef-T-Foot™ – 23.6" with 1.6" x .8" strut	EA	1
FF-1000-S	Hef-T-Foot™ – 39.4" with 1.6" x .8" strut	EA	1
FF-250-UNI	Hef-T-Foot™ – 9.8" Universal	EA	1

Hef-T-Foot™ Installation Variants

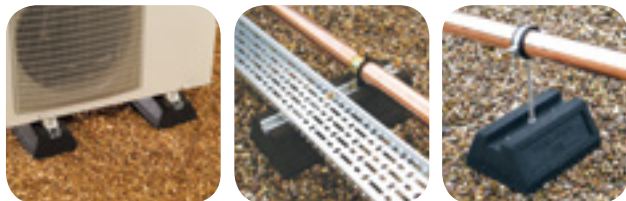

MOUNTING BRACKETS

Boiler Bracket

Our boiler bracket works well with all wall hung boilers and tankless hot water heaters available.



QSBB2000
QSBB1000

QUICK-SLING
by DiversiTech

CATALOG NO.	DESCRIPTION	UOM	ORDER MULTIPLE
QSBB1000	Boiler Bracket Wall Hung	EA	1
QSBB2000	Boiler Bracket Leg Kit	EA	1

Hef-T-Bracket™ (Type 2)

Used for supporting condensing units, Hef-T-Brackets (Type 2) feature a cross bar that is attached to a wall, and two L shaped brackets that are hooked and bolted into place on the cross bar. The condensing unit is mounted onto the L shaped brackets, and fastened using the bolts and anti vibration washers provided.

*Not approved for South Florida.



230-B2L

CATALOG NO.	DESCRIPTION	ARM LENGTH	LOAD RATING PER ARM	UOM	ORDER MULTIPLE
230-B2M	Hef-T-Bracket™ (Type 2) – Medium	18"	165#	EA	1
230-B2L	Hef-T-Bracket™ (Type 2) – Large	21"	220#	EA	1

Heavy Duty Bracket (Type 1)

Heavy duty L-shaped brackets for supporting condensing units. Each 20" arm supports up to 350 lbs.



230-B1HD

CATALOG NO.	DESCRIPTION	ARM LENGTH	LOAD RATING PER ARM	UOM	ORDER MULTIPLE
230-B1HD	Heavy Duty Bracket	20"	350#	EA	1

Hef-T-Bracket™ (Type 3)

Used for supporting condensing units, Hef-T-Brackets (Type 3), just like Hef-T-Brackets (Type 2), feature a cross bar that is attached to a wall, and two L shaped brackets that are hooked and bolted into place on the cross bar. The condensing unit is mounted onto the L shaped brackets, and fastened using the bolts and anti vibration washers provided. The Hef-T-Bracket™ (Type 3) features an innovative locking mechanism called Easy Fit™. Easy Fit™ enables the arms to be joined to the uprights in a matter of seconds. A spring lock automatically secures the joint, preventing the arms from being dislodged accidentally. All brackets are furnished complete with an integral bubble level to make correct installation of the crossbar easier.



230-B3L



CATALOG NO.	DESCRIPTION	ARM LENGTH	LOAD RATING PER ARM	UOM	ORDER MULTIPLE
230-B3M	Hef-T-Bracket™ (Type 3) – Medium	19"	100#	EA	1
230-B3L	Hef-T-Bracket™ (Type 3) – Large	21"	150#	EA	1

Hef-T-Bracket™ (Type 2) Extra Duty

Used for supporting condensing units, Type 2 Extra Duty brackets feature a sturdy cross bar that is attached to a wall and two L shaped brackets that slide onto the crossbar and then bolt into place. The condensing unit is mounted onto the L shaped brackets and fastened using the bolts and anti-vibration washers provided. Includes bubble level and adjustable back support. *Not approved for South Florida.



230-B2XL

CATALOG NO.	DESCRIPTION	ARM LENGTH	LOAD RATING PER ARM	UOM	ORDER MULTIPLE
230-B2XL	Hef-T-Bracket™ (Type 2) – Large	21"	240#	EA	1

Wall Brackets

Our Quick-Sling® Wall Bracket provides a quick, safe, and stable way to mount your unit. They allow for easy access during installation, service, and maintenance. Our roof bracket accessory is designed to protect your equipment from snow and freezing rain while maintaining proper air flow around the unit.



QSWB1000



CATALOG NO.	DESCRIPTION	UOM	ORDER MULTIPLE
QSWB1000	Mini Split Wall Bracket	EA	1
QSWB2000	Wall Bracket w/Rails Light Dty	EA	1
QSWB3000	Wall Bracket w/Z Bend	EA	1
QSWB4000	Wall Bracket w/Rails Heavy Dty	EA	1
QSRB1000	Roof Bracket System	EA	1

MINI-SPLIT STANDS

Mini-Split Stands

Our Quick-Sling® Mini-Split Stands provide a safe, stable platform to mount your unit on. It keeps unit elevated above lawn mowers, weed whackers, pets, snow, and flooding. The elevated height allows for ease of installation, maintenance and service.



QSMS1200



CATALOG NO.	DESCRIPTION	UOM	ORDER MULTIPLE
QSMS1200	Mini-Split Stand Thin - 12"	EA	1
QSMS1201	Mini-Split Stand Wide - 12"	EA	1
QSMS1800	Mini-Split Stand Thin - 18"	EA	1
QSMS1801	Mini-Split Stand Wide - 18"	EA	1
QSMS2400	Mini-Split Stand Thin - 24"	EA	1
QSMS2401	Mini-Split Stand Wide - 24"	EA	1

Mini-Split Double Stack Stand

Our Quick-Sling® Mini-Split Double Stack Stand provide a safe, stable platform to mount your unit on. It keeps unit elevated above lawn mowers, weed whackers, pets, snow, and flooding. The elevated height allows for ease of installation, maintenance and service.



QSMS1203



CATALOG NO.	DESCRIPTION	UOM	ORDER MULTIPLE
QSMS1203	Mini-Split Double Stack Stand	EA	1

Air Conditioner Brackets

These heavy duty 1/8" thick steel AC brackets are perfect for hanging A/C condensers and heat pumps outside the home. Mount at any height to allow for easy maintenance under units. No need to wait for finished grade or landscaping prior to installation of AC unit. Pre punched holes for easy installation. Powder coated gray finish. Load rating 600 lbs. per pair.



ACB-30

CATALOG NO.	DESCRIPTION	UOM	ORDER MULTIPLE
ACB-30	AC Mounting Bracket – 30", pack of 2	PK	1
ACB-36	AC Mounting Bracket – 36", pack of 2	PK	1
ACB-42	AC Mounting Bracket – 42", pack of 2	PK	1
ACB-48	AC Mounting Bracket – 48", pack of 2	PK	1

Mini-Split Dual Fan Stands

Our Quick-Sling® Mini-Split Dual Fan Stands provide a safe, stable platform to mount your unit on. It keeps unit elevated above lawn mowers, weed whackers, pets, snow, and flooding. The elevated height allows for ease of installation, maintenance and service.



QSMS1202



CATALOG NO.	DESCRIPTION	UOM	ORDER MULTIPLE
QSMS1202	Mini-Split Dual Fan Stand - 12"	EA	1
QSMS1802	Mini-Split Dual Fan Stand - 18"	EA	1
QSMS2402	Mini-Split Dual Fan Stand - 24"	EA	1

EQUIPMENT STANDS

Air Handler Base – Heavy Duty Adjustable

Made of 14 gauge galvanized steel for excellent corrosion resistance and longevity. 22" high x 22" deep. Width is adjustable from 16" – 26". Supports up to 200 lbs.



6-HAB-BG

CATALOG NO.	DESCRIPTION	UOM	ORDER MULTIPLE
6-HAB-BG	Steel Air Handler Base	EA	1

Quick-Stand

Our Quick-Stand is made of 14-gauge square tubing. This not only cuts down on vibration but allows the stand to hold up to 500 lbs. Each leg individually extends in 1" increments using thumb screws & wing nuts for speed and versatility. Installs as low as 22" on flat or uneven surfaces.



QSTD1000



CATALOG NO.	DESCRIPTION	UOM	ORDER MULTIPLE
QSTD1000	Quick-Stand Heavy Duty	EA	1
QSTD2000	Quick-Stand Light Duty	EA	1

Quick Heat Pump Stand

Our 18" Quick-Sling® Heat Pump Stand provides a safe stable platform to mount your unit on. Keep it elevated above lawn mowers, weed whackers, pets, snow, and flooding. Elevated height allows for ease of installation, service, and maintenance.



QSTD3000



CATALOG NO.	DESCRIPTION	UOM	ORDER MULTIPLE
QSTD3000	Quick Heat Pump Stand (4 Arm)	EA	1

Vertical Air Handler Stand

Our Quick-Sling® Vertical Air Handler Stand fits all LG, Unico and Mitsubishi Air Handlers. It is adjustable left to right in 1" increments up to 6". 18" and 24" stands include 2 stability arms. 500 lbs Max Capacity.



QSTD4000



CATALOG NO.	DESCRIPTION	UOM	ORDER MULTIPLE
QSTD4000	12" Vert Air Hdler Std 19" Arm	EA	1
QSTD4001	12" Vert Air Hdler Std 23" Arm	EA	1
QSTD4002	12" Vert Air Hdler Std 27" Arm	EA	1
QSTD5000	18" Vert Air Hdler Std 19" Arm	EA	1
QSTD5001	18" Vert Air Hdler Std 23" Arm	EA	1
QSTD5002	18" Vert Air Hdler Std 27" Arm	EA	1
QSTD6000	24" Vert Air Hdler Std 19" Arm	EA	1
QSTD6001	24" Vert Air Hdler Std 23" Arm	EA	1
QSTD6002	24" Vert Air Hdler Std 27" Arm	EA	1

EQUIPMENT STANDS *cont'd*

VRF/VRV/HRV Super Stands

Super Stands come with single and double-sided U Bars to accommodate any multi-unit combination.



QSSS1003-12



U Bar Details:

- 1.5" x 1.5" - U Bars made from 11 gauge steel square tubing.
- Adjustable width in 1" increments.
- Adjustable height in 1/4" and 1/2" increments.
- Rubber roof friendly.
- 12" x 12" feet made from 7 gauge steel with 3/8" holes for mounting.

CATALOG NO.	DESCRIPTION	UOM	ORDER MULTIPLE
QSSS1003-12	Super Stand 12" Type A	EA	1
QSSS1003-18	Super Stand 18" Type A	EA	1
QSSS1003-24	Super Stand 24" Type A	EA	1
QSSS1004-12	Super Stand 12" Type B	EA	1
QSSS1004-18	Super Stand 18" Type B	EA	1
QSSS1004-24	Super Stand 24" Type B	EA	1
QSSS1005-12	Super Stand 12" Type C	EA	1
QSSS1005-18	Super Stand 18" Type C	EA	1
QSSS1005-24	Super Stand 24" Type C	EA	1
QSSS1006-12	Super Stand 12" Type A+A	EA	1
QSSS1006-18	Super Stand 18" Type A+A	EA	1
QSSS1006-24	Super Stand 24" Type A+A	EA	1
QSSS1007-12	Super Stand 12" Type A+C	EA	1
QSSS1007-18	Super Stand 18" Type A+C	EA	1
QSSS1007-24	Super Stand 24" Type A+C	EA	1
QSSS1008-12	Super Stand 12" Type B+B	EA	1
QSSS1008-18	Super Stand 18" Type B+B	EA	1
QSSS1008-24	Super Stand 24" Type B+B	EA	1
QSSS1009-12	Super Stand 12" Type B+C	EA	1
QSSS1009-18	Super Stand 18" Type B+C	EA	1
QSSS1009-24	Super Stand 24" Type B+C	EA	1
QSSS1010-12	Super Stand 12" Type C+C	EA	1
QSSS1010-18	Super Stand 18" Type C+C	EA	1
QSSS1010-24	Super Stand 24" Type C+C	EA	1
QSSS1011-12	Super Stand 12" Type C+A+A	EA	1
QSSS1011-18	Super Stand 18" Type C+A+A	EA	1
QSSS1011-24	Super Stand 24" Type C+A+A	EA	1
QSSS1012-12	Super Stand 12" Type A+B+C	EA	1
QSSS1012-18	Super Stand 18" Type A+B+C	EA	1
QSSS1012-24	Super Stand 24" Type A+B+C	EA	1
QSSS1013-12	Super Stand 12" Type A+C+C	EA	1
QSSS1013-18	Super Stand 18" Type A+C+C	EA	1
QSSS1013-24	Super Stand 24" Type A+C+C	EA	1
QSSS1014-12	Super Stand 12" Type B+C+C	EA	1
QSSS1014-18	Super Stand 18" Type B+C+C	EA	1
QSSS1014-24	Super Stand 24" Type B+C+C	EA	1
QSSS1015-12	Super Stand 12" Type C+C+C	EA	1
QSSS1015-18	Super Stand 18" Type C+C+C	EA	1
QSSS1015-24	Super Stand 24" Type C+C+C	EA	1
QSSS1016-12	Super Stand 12" Type A+A+A	EA	1
QSSS1016-18	Super Stand 18" Type A+A+A	EA	1
QSSS1016-24	Super Stand 24" Type A+A+A	EA	1
QSSS1017-12	Super Stand 12" Type A+B+B	EA	1
QSSS1017-18	Super Stand 18" Type A+B+B	EA	1
QSSS1017-24	Super Stand 24" Type A+B+B	EA	1
QSSS1018-12	Super Stand 12" Type B+B+B	EA	1
QSSS1018-18	Super Stand 18" Type B+B+B	EA	1
QSSS1018-24	Super Stand 24" Type B+B+B	EA	1
QSSS1019-12	Super Stand 12" Type D	EA	1
QSSS1019-18	Super Stand 18" Type D	EA	1
QSSS1019-24	Super Stand 24" Type D	EA	1

CATALOG NO.	DESCRIPTION	UOM	ORDER MULTIPLE
QSSS1020-12	Super Stand 12" Type D+D	EA	1
QSSS1020-18	Super Stand 18" Type D+D	EA	1
QSSS1020-24	Super Stand 24" Type D+D	EA	1
QSSS1021-12	Super Stand 12" Type D+D+D	EA	1
QSSS1021-18	Super Stand 18" Type D+D+D	EA	1
QSSS1021-24	Super Stand 24" Type D+D+D	EA	1
QSSS1022-12	Super Stand 12" Type A+B	EA	1
QSSS1022-18	Super Stand 18" Type A+B	EA	1
QSSS1022-24	Super Stand 24" Type A+B	EA	1
QSSS1023-12	Super Stand 12" Type A+A+B	EA	1
QSSS1023-18	Super Stand 18" Type A+A+B	EA	1
QSSS1023-24	Super Stand 24" Type A+A+B	EA	1
QSSS1024-12	Super Stand 12" Type A+D	EA	1
QSSS1024-18	Super Stand 18" Type A+D	EA	1
QSSS1024-24	Super Stand 24" Type A+D	EA	1
QSSS1025-12	Super Stand 12" Type A+D+D	EA	1
QSSS1025-18	Super Stand 18" Type A+D+D	EA	1
QSSS1025-24	Super Stand 24" Type A+D+D	EA	1
QSSS36	Super Stand Cross Rail - 36 in.	EA	1
QSSS48	Super Stand Cross Rail - 48 in.	EA	1
QSSS55	Super Stand Cross Rail - 55 in.	EA	1
QSSS70	Super Stand Cross Rail - 70 in.	EA	1
QSSS100-12	Super Stand U Bar - Single	EA	1
QSSS100-12	Super Stand U Bar - Double	EA	1

*NOTE: Please contact Diversitech for additional configurations.

Cross Rail Types: Type A: 36" Cross Rail; Type B: 48" Cross Rail; Type C: 70" Cross Rail; Type D: 55" Cross Rail

HANGING BRACKETS

Quick-Sling

Our Quick-Sling is made of 14-gauge square tubing. This not only cuts down on vibration but allows the stand to hold up to 400 lbs. Extension arms individually adjust in one inch increments using thumb screws & wing nuts for speed & versatility. Installs as high as 24" or as low as 48" on flat or pitched roofs.



CATALOG NO.	DESCRIPTION	UOM	ORDER MULTIPLE
QSLG1000	Sling Bracket Light Duty 1 Arm	EA	1
QSLG2000	Sling Bracket Heavy Duty 2 Arm	EA	1

Quick Swivel "U" Mount

Our Quick Swivel is made of 14-gauge steel able to hold 200 lbs. The swivel allows for 360° rotation for setting the perfect direction of air flow.



CATALOG NO.	DESCRIPTION	UOM	ORDER MULTIPLE
QSWI1000	Swivel "U" Mount w/H-Bracket	EA	1
QSWI2000	Swivel "U" Mount w/L-Bracket	EA	1

Quick Swivel Flush Mount w/"H" Bracket

Our Quick Swivel is made of 14-gauge steel able to hold 200 lbs. The swivel allows for 360° rotation for setting the perfect direction of air flow.



CATALOG NO.	DESCRIPTION	UOM	ORDER MULTIPLE
QSWI3000	Swivel Flush H Bracket	EA	1
QSWI3001	Swivel Flush H Bracket 36" Spd	EA	1
QSWI3002	Swivel Flush H Bracket 17" Spd	EA	1

Quick Swivel Flush Mount w/"I" Bracket

Our Quick Swivel is made of 14-gauge steel able to hold 200 lbs. The swivel allows for 360° rotation for setting the perfect direction of air flow.



CATALOG NO.	DESCRIPTION	UOM	ORDER MULTIPLE
QSWI4000	Swivel Flush w/ I Bracket	EA	1
QSWI5000	Swivel Flush Heavy Duty	EA	1
QSWI6000	Swivel Flush w/2 I Brackets	EA	1

Quick-Sling Accessories

- The QSAC1000 (set of 4) & 1100 (set of 2) steel beam adapters are made out of aluminum & able to hold up to 250 lbs each.
- Each QSAC1000 is slotted to receive 3/8 threaded rod or C-clamps for easy mounting.
- The QSAC2000 (set of 4) & 2100 (set of 2) wood beam adapters are made of steel & are 12" long & 2" wide.
- Each of our adapters are able to hold up to 200 lbs.
- They have a 1.5" bend that simply clips over the wood joist. All the necessary hardware is provided.
- QSAC1000 and QSAC2000 adapts: QSLG1000 & QSLG2000
- QSAC1100 and QSAC2100 adapts: QSWI1000 & QSWI2000



CATALOG NO.	DESCRIPTION	UOM	ORDER MULTIPLE
QSAC1000	Adapters, Steel Pk of 4	EA	1
QSAC1100	Adapters, Steel Pk of 2	EA	1
QSAC2000	Adapters, Wood Pk of 4	EA	1
QSAC2100	Adapters, Wood Pk of 2	EA	1

Patch It Up!

Item # FP-36

Repair almost any surface with Flexi-Patch™

- Extremely durable fiberglass reinforced patch
- Flexible and waterproof
- Weather and UV resistant
- Temperature safe from -30°C to 365°C
- Will not shrink or expand during or after application
- Bonds to all surfaces except polypropylene
- Cure quickly – as fast as 5 minutes.

Flexi-Patch™ is an easy to use flexible repair patch ideal for repairing almost any surface. It cures quickly using only UV light from sunlight or a UV flashlight for a long lasting, permanent repair. Flexi-Patch is a fiberglass-reinforced polyester ideal for use on PVC, plastics, metal, wood, concrete and more. It's the easy way to permanently patch almost any surface. It dries hard for permanent repair. Can be drilled, tapped and painted once dry.



BEFORE

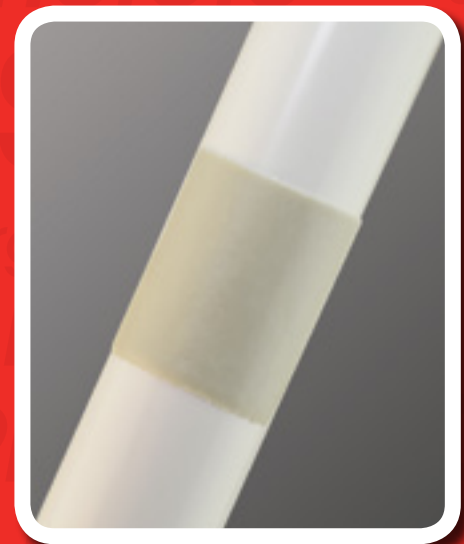

AFTER



**Display
box of 20**

DIVERSITECH®

AIR MOVEMENT

Dryer Duct, Vent Hose, Hose Clamps	40-41
Duct Strap, Ties, Clamps	41-42
Pure-Beam™ Ultraviolet Light	40
Tapes	42
Ventilation Products	39



PURE-BEAM™ Ultraviolet Light

The Pure-Beam™ ultraviolet light is designed for HVAC air disinfection and surface irradiation. Exposure to Pure-Beam™ significantly reduces air contamination caused by fungus, mold, and viruses and can cleanse surfaces overcome by mold and slime.

- The Pure-Beam™ ultraviolet light is an excellent way to maintain indoor air quality.
- This UV Light includes a ballast, transformer, and bracket for even more convenience.
- Overall dimensions are small which makes installation easy.
- The included transformer allows operation using 120, 208, and 240/220 VAC power.
- UV lights are unobtrusive and transparent in operation, requiring little maintenance.

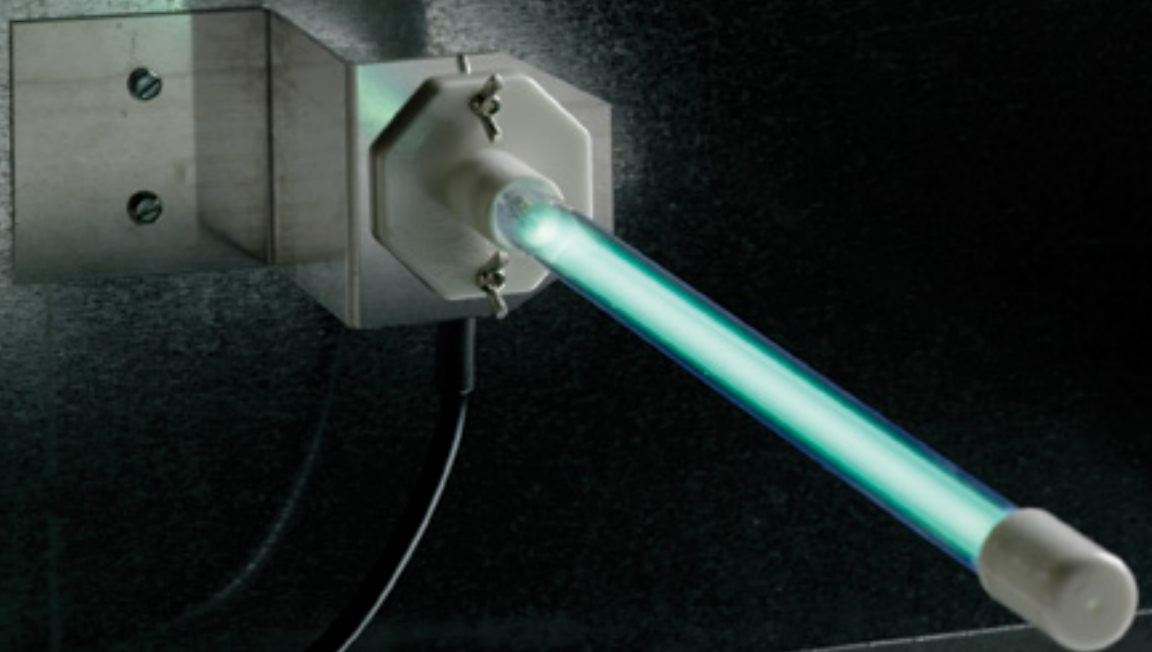

Duct Fans

Features electrical junction box for UL and code compliant electrical connection. An efficient way to increase air circulation, keep room temperatures consistent, and lower heating and cooling costs. Metal construction, powerful no-maintenance motors and a one-use thermal fuse mean these fans will be up to the task for years. Straightforward installation into any 120V system with detailed instructions, templates, and diagrams. Available in many sizes. A great way to give slow vents a boost. Conforms to UL STD 507, Certified to CSA STD C22.2 #113

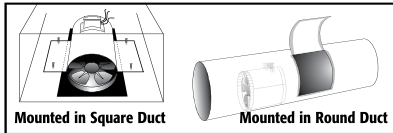

CATALOG NO.	DESCRIPTION	UOM	ORDER MULTIPLE
625-AF6	Duct Fan 6" dia., 240 CFM, 37W	EA	4
625-AF8	Duct Fan 8" dia., 420 CFM, 37W	EA	4
625-AF10	Duct Fan 10" dia., 650 CFM, 35W	EA	4
625-AF12	Duct Fan 12" dia., 975 CFM, 65W	EA	2
625-AF14	Duct Fan 14" dia., 1350 CFM, 65W	EA	1

Roof Flashing

Easy to install. The no-caulk flashing slips over vent stack and automatically adjusts to pipe size and roof angle. 24 gauge galvanized steel.



CATALOG NO.	DESCRIPTION	UOM	ORDER MULTIPLE
5-11830	Roof Flashing – 1/2" – 3/4" – 1"	EA	12
5-11840	Roof Flashing – 1-1/4" – 1-1/2"	EA	12
5-11853	Roof Flashing – 2"	EA	12
5-11866	Roof Flashing – 3"	EA	12
5-11879	Roof Flashing – 4"	EA	12

Roof Louver

Unique interior louver design, eliminating the need for a screen. The square hood has been designed for maximum air movement. Large nailing flange for easy installation. U.L. Listed.



CATALOG NO.	DESCRIPTION	UOM	ORDER MULTIPLE
6-R50A	Roof Louver – Aluminum	EA	10

Flue Caps

PVC Flue Caps are an affordable way to protect today's high efficiency furnaces from dirt, moisture and other debris.

- Protection for high efficiency furnaces
- Universal flue cap fits 1.5", 2" and 3" PVC pipe
- Reduces draft inducer motor rust
- Helps to eliminate pressure switch service calls
- Resistant to UV radiation and oxidative degradation
- CSA approved for use in 90% AFUE heating applications



CATALOG NO.	DESCRIPTION	UOM	ORDER MULTIPLE
EC-1	E cap Flue Cap	EA	12

Smokeys

Smoke emitter cartridges provide effective, low cost leak testing of heat exchangers, air ducts, tanks and boilers. Visual air balancing of HVAC systems. Cartridges produce clean, non toxic, oil free smoke through chemical reaction. Use also for fire drills as well as the placement and testing of smoke alarms/ detectors.



CATALOG NO.	DESCRIPTION	UOM	ORDER MULTIPLE
14145	45 second burn time, 150 cu. ft., pack of 10	PK	1
14175	75 second burn time, 600 cu. ft., pack of 10	PK	1
14250	2-1/2 minute burn time, 1,100 cu. ft., pack of 5	PK	1
14340	4 minute burn time, 2,500 cu. ft., pack of 5	PK	1

Versa Cap® Flue and Hot Stack Caps

Non clogging positive draft design, recommended for flue or hot stack installation. Clamp fitting adjustable for all standard sizes. Aluminum model. U.L. Listed.



CATALOG NO.	PIPE O.D.	DOUBLE WALL	SINGLE WALL	J-M TRANS. SITE	HEIGHT/OVERALL DIAMETER	ORDER UOM	ORDER MULTIPLE
6-3050	2-7/8"-5"	3 and 4	3 and 4	3 and 4	4-1/2" x 6-5/8"	EA	12
6-5070	4-7/8"-7"	5 and 6	5 and 6	5 and 6	4-3/4" x 9-1/2"	EA	12
6-7090	6-7/8"-9"	7 and 8	7 and 8	7 and 8	5-7/8" x 11-5/8"	EA	12
6-9011	8-7/8"-11"	9 and 10	9 and 10	9 and 10	6-1/2" x 12-3/4"	EA	6
6-1200	11-7/8"-14-1/2"	12	12 and 14	12	8-11/16" x 17-9/16"	EA	2

Egg Crate Louvers – Air Return Diffusers

White polystyrene 1/2 in. open cell grid louvers are beneficial for air return.

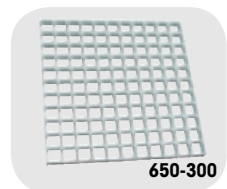

CATALOG NO.	DESCRIPTION	UOM	ORDER MULTIPLE
650-300	Egg Crate Louvers – 2' x 2' x 1/2"	EA	20
650-200	Egg Crate Louvers – 2' x 4' x 3/8"	EA	15
650-100	Egg Crate Louvers – 2' x 4' x 1/2"	EA	10

PURE BEAM™ ULTRAVIOLET LIGHT

Pure-Beam™ Ultraviolet Light

Pure Beam™ ultraviolet light is designed for HVAC air disinfection and surface irradiation. The 17 watt UV C lamp is a powerful tool for improved indoor air quality. Installs in the HVAC system or ductwork on either the return or supply air side of the furnace or air handler. DiversiTech's Pure Beam™ ultraviolet light provides a healthier environment in your home, thanks to the germicidal qualities of the UV light spectrum present in the Pure Beam™ light. Ultraviolet light deactivates the DNA of dust mites, bacteria, viruses and other pathogens and destroys their ability to multiply and cause disease. Placement of a Pure Beam™ light in an airstream or near a drain pan can help to decrease the air contamination of any home. Exposure to Pure Beam™ significantly reduces air contamination caused by fungus, mold, and viruses and can cleanse surfaces overcome by mold and slime. Overall size is 14 in. L x 2 in. W x 2 in. H for easy placement. Includes the UV lamp, a UL listed ceramic base, and mounting bracket.



UV-1

CATALOG NO.	DESCRIPTION	UOM	ORDER MULTIPLE
UV-1	Ultraviolet Light with 24 VAC elec. ballast	EA	1
UV-BULB	Replacement Bulb – 24V	EA	1

DRYER DUCT, VENT HOSE, HOSE CLAMPS

Aluminum Dryer Vent Hoods, Kits, and Fittings

Aluminum vent hood with flange plate.

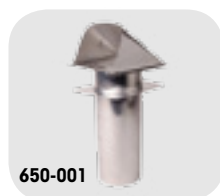

650-001

CATALOG NO.	DESCRIPTION	UOM	ORDER MULTIPLE
650-001	4" Aluminum Hood	EA	24
650-002	3" Aluminum Hood	EA	24
650-003	4" Hood / 8' Tubing	EA	24
650-038	4" Aluminum Wide Mouth	EA	10

Plastic Wide Mouth Dryer Vent Hood

Hood, aluminum pipe and collar.



650-012

CATALOG NO.	DESCRIPTION	UOM	ORDER MULTIPLE
650-031	3" White Hood – Assembled	EA	12
650-012	4" White Hood – Assembled	EA	12
650-013	4" White Hood – Unassembled	EA	18
650-023	4" Brown Hood – Assembled	EA	12

Louvered Dryer Vent Hood

Louvered vent hoods are available with aluminum pipe and collar or hood only. Ideal for dryer and bathroom fan exhausts.



650-014

CATALOG NO.	DESCRIPTION	UOM	ORDER MULTIPLE
650-014	4" Hood Only – White	EA	12
650-015	4" Hood Only w/Bird Guard – White	EA	12
650-016	4" Hood, Pipe and Collar – White (Assembled)	EA	12
650-017	4" Hood, Pipe and Collar – White (Unassembled)	EA	18
650-036	3" Hood, Pipe and Collar – White (Assembled)	EA	12

Dryer Vent Hose

High quality flexible white vinyl tubing. Available in 3in. or 4in. diameters. One 50ft roll per box.



650-005

CATALOG NO.	DESCRIPTION	UOM	ORDER MULTIPLE
650-005	Dryer Vent Hose – 3" x 50'	EA	1
650-006	Dryer Vent Hose – 4" x 50'	EA	1

Semi-Rigid Aluminum Duct

8ft. length compressed to 28in.



650-011

CATALOG NO.	DESCRIPTION	UOM	ORDER MULTIPLE
650-011	4" x 8' Flexible Aluminum Duct	EA	9
650-021	3" x 8' Flexible Aluminum Duct	EA	14
650-074	6" x 8' Flexible Aluminum Duct	EA	3

Metallic Duct – 5 Ply

Pure aluminum 5 ply multi layered flexible metallic duct. U.L. 181 Listed. Will contain a fire up to 265°F.



FUL0425

CATALOG NO.	DESCRIPTION	UOM	ORDER MULTIPLE
FUL0425	4" x 25' 5 Ply Metallic Duct	EA	4
FUL0625	6" x 25' 5 Ply Metallic Duct	EA	4

DRYER DUCT, VENT HOSE, HOSE CLAMPS cont'd

Dryer Hose Clamps

Available for 3 in. or 4in. dryer vent hose. Steel screw design or convenient spring action design.



CATALOG NO.	DESCRIPTION	UOM	ORDER MULTIPLE
650-008	Steel Screw Clamp for 4" Hose	EA	50
650-010	Spring Clamp for 4" Hose	EA	500

Periscope Connection Kit

For tight space duct venting. Contains one male snap lock fitting and one draw band with clamp. Adjustable 17in. to 28in..



CATALOG NO.	DESCRIPTION	UOM	ORDER MULTIPLE
650-020	4" Periscope Kit	EA	9

Metallic Duct – 2 Ply

2 ply metallic duct — aluminum outside, polyester inside. Ideal for bath fan ducting and all purpose venting.



CATALOG NO.	DESCRIPTION	UOM	ORDER MULTIPLE
FM0450	4" x 50' 2 Ply Metallic Duct	EA	1

DUCT STRAP, TIES, CLAMPS

Heavy Duty Cable Ties

6.6 nylon, the heavy duty duct straps feature smooth insertion, and a locking mechanism that gives ductwork a firm hold. Accommodates 7 to 15 inch duct. Tensioning tool for 32 in. plus allows operator to adjust strap to any desired tension.



CATALOG NO.	DESCRIPTION	UOM	ORDER MULTIPLE
7-P24	24" Long – Fits up to 6" Duct – 175 lb. Tensile	EA	50
7-P36	36" Long – Fits up to 10" Duct – 175 lb. Tensile	EA	50
7-P36B	36" Long – Black – Fits up to 10" Duct – 175 lb. Tensile	EA	50
7-P48	48" Long – Fits up to 14" Duct – 175 lb. Tensile	EA	50
7-P48B	48" Long – Black – Fits up to 14" Duct – 175 lb. Tensile	EA	25
7-L300	Tensioning Tool for 120-175 lb. Ties	EA	1

Strapping Hanger Iron

Galvanized 3/4 in. vent strapping, hanger iron, plumber's tape, pipe hanger tape and many other uses. 1/4 in. centers for bolts or nails.



CATALOG NO.	DESCRIPTION	UOM	ORDER MULTIPLE
710-A1710	Hanger Iron (Galv.) – 10' Rolls – 28 Gauge	EA	50
710-A1650	Hanger Iron (Galv.) – 50' Rolls – 28 Gauge	EA	10
710-A16100	Hanger Iron (Galv.) – 100' Rolls – 28 Gauge	EA	6

Hanging Wire

The 18 gauge galvanized can be used to hang HVAC duct work.



CATALOG NO.	DESCRIPTION	UOM	ORDER MULTIPLE
710-182G	2# Roll – 330' – 18 Gauge Galvanized	EA	8
710-185G	5# Roll – 830' – 18 Gauge Galvanized	EA	8

Duct Strap – Metallic – Roll

Galvanized duct strap in a convenient cardboard dispenser is not only easy to drill or nail, but also solid strapping. Plenum rated.



CATALOG NO.	DESCRIPTION	UOM	ORDER MULTIPLE
710-001	Metallic Duct Strap – 26 Gauge – 1" x 100'	EA	1
710-002	Metallic Duct Strap – 30 Gauge – 1" x 100'	EA	1
710-003	Metallic Duct Strap – 30 Gauge – 1-1/2" x 100'	EA	1
710-004	Metallic Duct Strap – 26 Gauge – 1-1/2" x 100'	EA	1
710-005	Metallic Duct Strap – 22 Gauge – 1" x 100'	EA	1

DUCT STRAP, TIES, CLAMPS cont'd

Duct Strap – Woven Polypropylene

Webbed duct strap possessing high tensile and abrasion resistance. This can be used for flex duct as it is easy to cut and staple to joists. The product is chemical resistant and tested to meet UL Standard 2043.



CATALOG NO.	DESCRIPTION	UOM	ORDER MULTIPLE
710-100	Duct Strap – 1-3/4" x 100 Yards – Black	EA	24
710-101	Duct Strap – 1-3/4" x 100 Yards – Silver	EA	24
710-102	Duct Strap – 3" x 100 Yards – Black	EA	8
710-103	Duct Strap – 3" x 100 Yards – Silver	EA	8

Plastic Hanger Strap

Flexible, non-conductive. 3/4 in. wide x .050 in. thick. Load tested to 120 lbs.



CATALOG NO.	DESCRIPTION	UOM	ORDER MULTIPLE
710-P100	3/4" x 100' Roll	EA	20

TAPES

Stick-E-Tape

Self adhesive aluminum tape with temperature range of 40 degree F to 200 degree F. Easily painted. Excellent vapor barrier; effective UV and water shield over urethane foam. Preferred duct and pipe wrap.



CATALOG NO.	DESCRIPTION	UOM	ORDER MULTIPLE
50302	Stick-E-Tape – AFT-701-2 – 2" x 50' Roll	EA	24

Aluminum Foil Tape

Prevents heating and cooling losses. Blocks odors and moisture. Easy to handle. Use for HVAC and refrigeration systems. 35 degree F to plus 260 degree F working temperatures. 3-5 year shelf life. Made in USA.

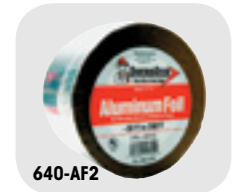

CATALOG NO.	DESCRIPTION	UOM	ORDER MULTIPLE
640-AF2	2" Aluminum Foil Tape – 50 yds.	EA	24
640-AF25	2-1/2" Aluminum Foil Tape – 50 yds.	EA	20
640-AF3	3" Aluminum Foil Tape – 50 yds.	EA	16

Flex Duct Tape

Specially designed to meet new UL181B FX code for flex duct. Higher adhesion and tack than traditional cloth duct tapes. Conformable, hand tearable foil; 3 mil thickness. 2 in. x 120 yds. Code identification printed on the tape. Acrylic adhesive for superior performance in extreme environments. (35°F to 260°F)



CATALOG NO.	DESCRIPTION	UOM	ORDER MULTIPLE
640-FD2S	Flex Duct Tape – Silver – 2"	EA	24
640-FD2B	Flex Duct Tape – Black – 2"	EA	24
640-FD3S	Flex Duct Tape – Silver – 3"	EA	16

Foil Scrim Kraft Tape

Non tearable, diamond patterned backing with an aggressive rubber based adhesive system for consistently dependable performance. Made in the USA.



CATALOG NO.	DESCRIPTION	UOM	ORDER MULTIPLE
640-FSK2	Foil Scrim Kraft Tape – 2" – 50 Yards	EA	24
640-FSK3	Foil Scrim Kraft Tape – 3" – 50 Yards	EA	16

UL Listed Foil Tape

Unique acrylic adhesive for airtight bonds on joints and seams of fiberglass duct systems. Flexible, easy to use. Meets or exceeds performance standard AFLS 100 73 and UL 181 A P.



CATALOG NO.	DESCRIPTION	UOM	ORDER MULTIPLE
640-UL25	UL 181 Listed Foil Tape – 2-1/2" – 60 Yards	EA	16
640-UL3	UL 181 Listed Foil Tape – 3" – 60 Yards	EA	16

Cloth Duct Tapes

High tack, excellent strength. Superior performance in sealing air handling systems. Heavy cloth content for easier tearing and additional strength. Made in the USA.



CATALOG NO.	DESCRIPTION	UOM	ORDER MULTIPLE
PC-622-S	2" x 60 Yards – Premium Grade Duct Tape – Silver	EA	24
PC-622-B	2" x 60 Yards – Premium Grade Duct Tape – Black	EA	24
PC-609-S	2" x 60 Yards – Industrial Grade Duct Tape – Silver	EA	24
PC-609-B	2" x 60 Yards – Industrial Grade Duct Tape – Black	EA	24
PC-600-S	2" x 60 Yards – Contractor Grade Duct Tape – Silver	EA	24
PC-600-B	2" x 60 Yards – Contractor Grade Duct Tape – Black	EA	24
PC-857	2" x 60 Yards – Metallized UL181B-FX Flex Duct Tape	EA	24

HEATING PRODUCTS

Black Steel Welded Nipples..... 51
 Carbon Monoxide & Smoke Alarms..... 49
 DiversiTech Gas Connectors..... 50
 Dormont Gas Valves and Connectors..... 50-51
 Malleable Black Iron Pipe Fittings..... 52-53
 TrueStart® Hot Surface Igniters48
 TrueStart® Ignition Accessories.....48-49
 Vent Termination Kits..... 49

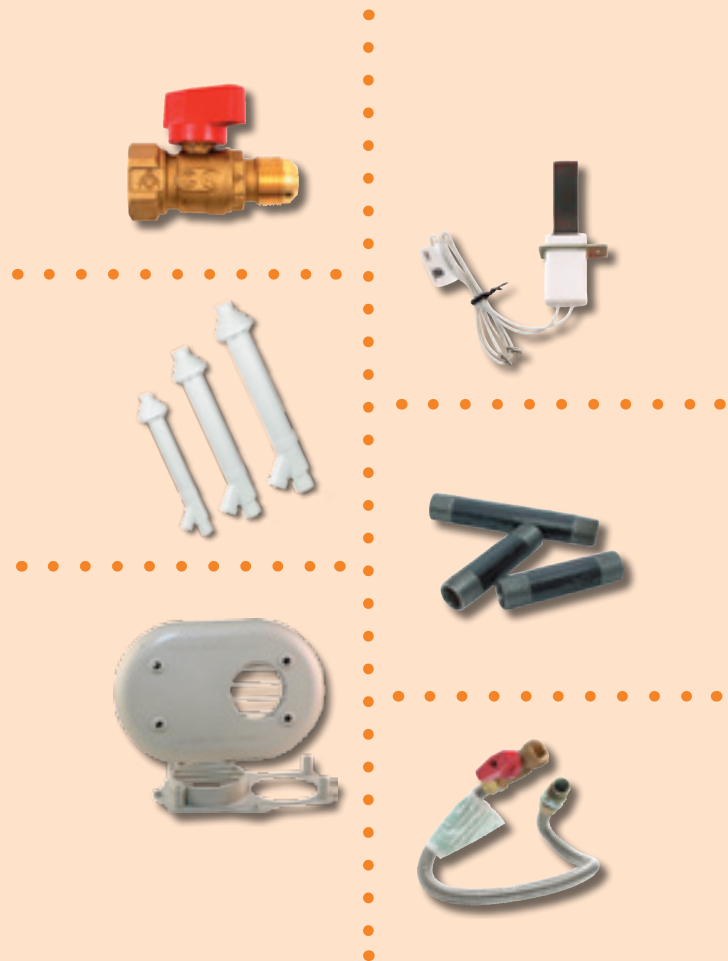

TrueStart® Hot Surface Igniters



*TrueStart® hot surface igniters have been
100% tested and approved.*

*TrueStart® hot surface igniters are completely reliable
right out of the package and are certified by CSA
for use in electrical equipment.*





TrueStart® universal hot surface igniters by DiversiTech are high quality replacements that fit hundreds of OEM components. TrueStart® universal igniters are durable and are designed to provide years of reliable service.

BUILT TO LAST

TrueStart® universal igniters are available in silicon nitride and silicon carbide models. Silicon nitride is a very durable ceramic that is high fracture and temperature resistant and has a long life expectancy. Silicon nitride is a longer lasting material that is also more shock resistant. Silicon carbide is a naturally high temperature resistant metal that has been the standard used in heating equipment for years.

JUST ONE REPLACES HUNDREDS

TrueStart® universal hot surface igniters feature a universal bracket kit that can be used to fit most all OEM furnaces. And TrueStart® hot surface igniters feature a unique universal electrical plug kit. This plug kit includes the most common crimp terminals and connector housings to fit the majority of OEM furnaces.

- ✓ *Durable ceramic material*
- ✓ *High thermal shock and chemical resistance*
- ✓ *Fracture resistant*
- ✓ *Long life*

LONG WARRANTY

Every TrueStart® universal igniter includes a generous warranty period to ensure your satisfaction. The warranty on silicon nitride models is 3 full years and the warranty for silicon carbide igniters is 18 months.

100% TESTED

TrueStart® universal hot surface igniters have been 100% tested and approved. TrueStart® hot surface igniters are completely reliable right out of the package and are certified by CSA for use in electrical equipment.



Each TrueStart® universal igniter also includes:



A universal bracket kit for a fast, easy installation.



A universal electrical plug connection kit to simplify installation.



Color coded packaging.



Made in U.S.A.



Vent Termination Kits

Concentric vents and termination kits allow both intake for combustion air and the exhaust vent to pass through a standard roof or sidewall. This makes it easier to have a two-pipe installation for high efficiency furnaces. These vents simplify installation and only require one hole through the wall or roof where the pipes terminate. Without using these vents, the installation would require cutting two holes through the home, one for each pipe. These vents save time and money by reducing the amount of work required.

Horizontal vent kits for use in venting high efficiency fossil fuel appliances. The low profile kit hides the vent from view.



All Fittings included

DiversiTech's CVENT series concentric vent kit includes all fittings a contractor will need to install the vent. No additional fittings for outside connections are needed. Only piping from the vent kit to the furnace will need to be provided separately. Models are available for 2", 3" or 4" intake/vent systems.



Low profile

The low profile of the HVENT series product creates a neat look for the vent connection. The simple and clean looking vent hides both the intake and exhaust pipework. Models are available for 2" or 3" vent systems.



Flexible installation

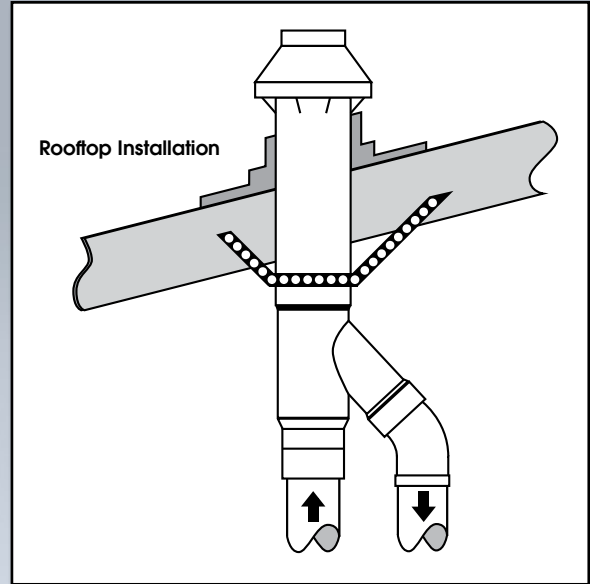
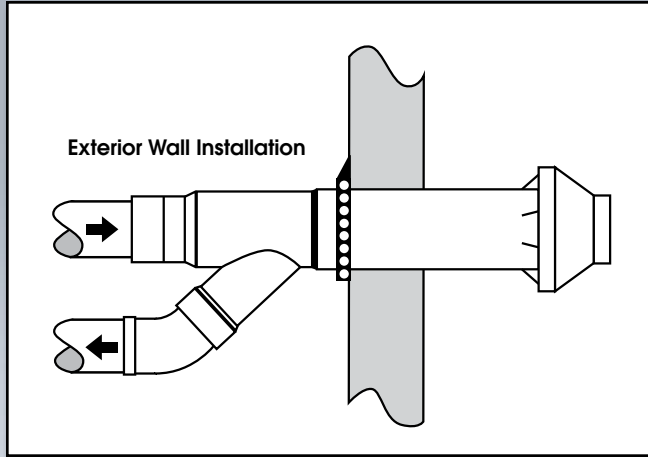

The same CVENT series vent kit can be used in either a horizontal (through the wall) or vertical (through the roof) installation.

TRUESTART® HOT SURFACE IGNITERS

Wolverine® Universal Hot Surface Igniter

Wolverine® hot surface igniters feature protective, dynamic, and informative packaging. Wolverine® hot surface igniters are 100% tested and completely reliable. They are compatible with all OEM furnaces. Universal hot surface igniters allow a contractor to reduce truck stock and replace hundreds of OEM igniters with just one SKU.



CATALOG NO.	DESCRIPTION	UOM	ORDER MULTIPLE
IGN-2	Wolverine Hot Surface Igniter by TrueStart, Universal, Silicon Nitride	EA	6
IGN-2-6P	Wolverine Hot Surface Igniter by TrueStart, Universal, Silicon Nitride – Contractor Pack, pack of 6	PK	1

TrueStart™ Hot Surface Igniters

TrueStart® hot surface igniters feature protective, dynamic, and informative packaging. TrueStart® hot surface igniters are 100% tested and completely reliable. They are compatible with all OEM furnaces. TrueStart® hot surface igniters are available as direct replacement for OEM (silicon carbide) or as a universal igniter (silicone carbide or silicon nitride). Universal hot surface igniters allow a contractor to reduce truck stock and replace hundreds of OEM igniters with just one SKU



CATALOG NO.	DESCRIPTION	UOM	ORDER MULTIPLE
IGN-1R	TrueStart™ Hot Surface Igniter, Universal, Round, Silicon Nitride	EA	6

Direct Replacement Igniters

TrueStart® hot surface igniters feature protective, dynamic, and informative packaging. TrueStart™ hot surface igniters are 100% tested and completely reliable. They are compatible with all OEM furnaces. TrueStart® hot surface igniters are available as direct replacement for OEM silicon carbide igniters.



CATALOG NO.	DESCRIPTION	UOM	ORDER MULTIPLE
IGN-401	TrueStart™ Hot Surface Igniter, Direct Replacement, Silicon Carbide	EA	6
IGN-402	TrueStart™ Hot Surface Igniter, Direct Replacement, Silicon Carbide	EA	6
IGN-403	TrueStart™ Hot Surface Igniter, Direct Replacement, Silicon Carbide	EA	6
IGN-409	TrueStart™ Hot Surface Igniter, Direct Replacement, Silicon Carbide	EA	6

Universal Silicon Carbide Igniters

TrueStart® hot surface igniters feature protective, dynamic, and informative packaging. TrueStart™ hot surface igniters are 100% tested and completely reliable. They are compatible with all OEM furnaces. TrueStart® hot surface igniters are available as a universal silicon carbide igniter.

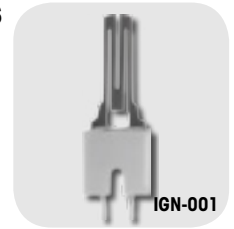

CATALOG NO.	DESCRIPTION	UOM	ORDER MULTIPLE
IGN-001	TrueStart™ Hot Surface Igniter, Universal, Silicon Carbide	EA	6

TRUESTART® IGNITION ACCESSORIES

TrueStart® Pilot Burners

TrueStart® pilot burners are a direct replacement for Carrier/BDP pilot burners. Available in 2 wire and 3 wire versions. The 3 wire is also field convertible to a 2 wire. TrueStart® pilot burners are not manufactured by Carrier Corporation.



CATALOG NO.	DESCRIPTION	UOM	ORDER MULTIPLE
FC-73	2 Wire Pilot Burner – Replacement for the Carrier® 732 2 wire pilot burner commonly known as Carrier®/BDP part number LH33JZ053	EA	1
FC-74	3 Wire Pilot Burner – Replacement for the Carrier® 740A 3 wire pilot burner commonly known as Carrier®/BDP part number LH680005	EA	1

TRUESTART® IGNITION ACCESSORIES cont'd

TrueStart® Flame Sensors

TrueStart® flame sensors are a direct replacement for Carrier/BDP flame sensors, cross reference part numbers are detailed in the item descriptions. TrueStart® flame sensors are not manufactured by Carrier Corporation.



CATALOG NO.	DESCRIPTION	UOM	ORDER MULTIPLE
900-3	TrueStart™ FLAME SENSOR replaces Carrier® LH33WZ516	EA	1
900-4	TrueStart™ FLAME SENSOR replaces Carrier® LH33WZ517	EA	1
900-5	TrueStart™ FLAME SENSOR replaces Carrier® LH33WZ518	EA	1
900-6	TrueStart™ FLAME SENSOR replaces Carrier® LH33WZ520	EA	1

TrueStart® Spark Electrode

Replacement pilots and accessories for selected Carrier/BDP units. Full 2 year warranty. Made in America.

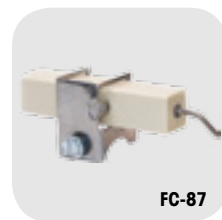

CATALOG NO.	DESCRIPTION	UOM	ORDER MULTIPLE
FC-87	Spark Electrode – Replacement for the Carrier®/BDP 871 Spark Electrode commonly known as Carrier®/BDP part number LH680512	EA	1

VENT TERMINATION KITS

Concentric Vents

Concentric vents make it easier to have a two pipe installation for high efficiency furnaces. These vents simplify installation and only require one hole through the wall or roof where the pipes terminate. Without using these vents, the installation would require cutting two holes through the home, one for each pipe. These vents save time and money by reducing the amount of work required. Available in 2", 3" or 4" intake vent sizes.

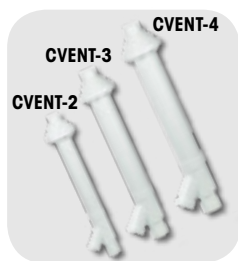

CATALOG NO.	DESCRIPTION	UOM	ORDER MULTIPLE
CVENT-2	2" Concentric Vent	EA	1
CVENT-3	3" Concentric Vent	EA	1
CVENT-4	4" Concentric Vent	EA	1
CVENTCAP2	Replacement cap for CVENT-2	EA	1
CVENTCAP3	Replacement cap for CVENT-3	EA	1
CVENTCAP4	Replacement cap for CVENT-4	EA	1
CVS-2	Vent screen for CVENT-2	EA	1
CVS-3	Vent screen for CVENT-3	EA	1

Horizontal Vent Termination Kits

Horizontal vent kits for use in venting high efficiency fossil fuel appliances. The low profile kit hides the vent from view.



CATALOG NO.	DESCRIPTION	UOM	ORDER MULTIPLE
HVENT-2	Horizontal Termination Kit - 2 inch	EA	6
HVENT-3	Horizontal Termination Kit - 3 inch	EA	6

CARBON MONOXIDE & SMOKE ALARMS

Carbon Monoxide Alarms

- 10 year sealed batteries provide continuous protection
- Microprocessor intelligence combined with electrochemical sensor virtually eliminates nuisance alarms
- Red LED indicates the status of power and CO
- Table top (free standing) or wall mounted. Mounting hardware included.
- Exceeds industry standards, ETL listed to UL Standard UL 2034 and California State Fire Marshal approved.
- 10 year limited warranty on both battery and alarm



CATALOG NO.	DESCRIPTION	UOM	ORDER MULTIPLE
CM-1000	Carbon Monoxide Smart Alarm	EA	1

Combination Carbon Monoxide and Smoke Alarms

- 3-in-1 alarm provides triple the protection with a single installation to protect against fires, carbon monoxide and natural gas
- 120-volt AC/DC hardwired alarm with backup battery is suitable for houses, apartments and mobile homes
- Mount the bracket to any standard wiring junction box and use the large mounting base to cover imperfections in drywall
- Features a quick activation pull-tab and a front-loading battery drawer for replacement without removing the alarm from the bracket
- Comes with a 7 year limited warranty



CATALOG NO.	DESCRIPTION	UOM	ORDER MULTIPLE
MICN109	Smoke, Carbon Monoxide and Natural Gas Alarm	EA	6

DIVERSITECH GAS CONNECTORS

DiversiTech Gas Connectors 1/2" OD

Combining flexibility, durability, and functionality, DiversiTech stainless steel gas connectors are CSA design certified and 100% leak tested for quality and security. DiversiTech gas connectors are durable and reliable to give you everything you need. Available in a variety of sizes and lengths.



D20-3132-18

CATALOG NO.	DESCRIPTION	UOM	ORDER MULTIPLE
D20-3132-18	Gas Connector – 18" long, 1/2" OD x 3/8" ID, M x F	EA	12
D20-3132-24	Gas Connector – 24" long, 1/2" OD x 3/8" ID, M x F	EA	12
D20-3132-36	Gas Connector – 36" long, 1/2" OD x 3/8" ID, M x F	EA	12
D20-3132-48	Gas Connector – 48" long, 1/2" OD x 3/8" ID, M x F	EA	12

Epoxy Coated Gas Connectors

Yellow coated gas connectors include an epoxy coating for added durability and extra protection from corrosion, chemical stains from common household products and plumbing repairs.



DC30-3132-18

CATALOG NO.	DESCRIPTION	UOM	ORDER MULTIPLE
DC30-3132-18	Gas Connector coated – 18" long, 5/8" OD x 1/2" ID, M x F	EA	12
DC30-3132-24	Gas Connector coated – 24" long, 5/8" OD x 1/2" ID, M x F	EA	12
DC30-3132-36	Gas Connector coated – 36" long, 5/8" OD x 1/2" ID, M x F	EA	12
DC30-3132-48	Gas Connector coated – 48" long, 5/8" OD x 1/2" ID, M x F	EA	12

DiversiTech Gas Connectors 5/8" OD

Combining flexibility, durability, and functionality, DiversiTech stainless steel gas connectors are CSA design certified and 100% leak tested for quality and security. DiversiTech gas connectors are durable and reliable to give you everything you need. Available in a variety of sizes and lengths.



D30-3132-18

CATALOG NO.	DESCRIPTION	UOM	ORDER MULTIPLE
D30-3131-24	Gas Connector – 24" long, 5/8" OD x 1/2" ID, M x M	EA	12
D30-3131-36	Gas Connector – 36" long, 5/8" OD x 1/2" ID, M x M	EA	12
D30-3131-48	Gas Connector – 48" long, 5/8" OD x 1/2" ID, M x M	EA	12
D30-3132-18	Gas Connector – 18" long, 5/8" OD x 1/2" ID, M x F	EA	12
D30-3132-24	Gas Connector – 24" long, 5/8" OD x 1/2" ID, M x F	EA	12
D30-3132-36	Gas Connector – 36" long, 5/8" OD x 1/2" ID, M x F	EA	12
D30-3132-48	Gas Connector – 48" long, 5/8" OD x 1/2" ID, M x F	EA	12

DORMONT GAS CONNECTORS AND VALVES

Dormont 20 Series

1/2" O.D. x 3/8" I.D. 1/2" MIP x 1/2" FIP Connectors



20-3132-18

CATALOG NO.	DESCRIPTION	UOM	ORDER MULTIPLE
20-3132-18	Gas Connector – 18" Long	EA	12
20-3132-24	Gas Connector – 24" Long	EA	12
20-3132-36	Gas Connector – 36" Long	EA	12
20-3132-48	Gas Connector – 48" Long	EA	12

Dormont 30 Series

Corrugated, stainless steel connectors with special Supr Safe® design to increase flexibility. Maximum service and safety, approved for indoor or outdoor use. Perfect for range and furnace connection. AGA and CGA approved. 3131 Series: 5/8" O.D. x 1/2" I.D. 1/2" MIP x 1/2" MIP Connectors. 3132 Series: 5/8" O.D. x 1/2" I.D. 1/2" MIP x 1/2" FIP Connectors.



30-3132-18

CATALOG NO.	DESCRIPTION	UOM	ORDER MULTIPLE
30-3131-24	Gas Connector – 24" Long	EA	12
30-3131-36	Gas Connector – 36" Long	EA	12
30-3131-48	Gas Connector – 48" Long	EA	12
30-3132-12	Gas Connector – 12" Long	EA	12
30-3132-18	Gas Connector – 18" Long	EA	12
30-3132-24	Gas Connector – 24" Long	EA	12
30-3132-30	Gas Connector – 30" Long	EA	12
30-3132-36	Gas Connector – 36" Long	EA	12
30-3132-48	Gas Connector – 48" Long	EA	12
30-3132-60	Gas Connector – 60" Long	EA	12
30-3132-72	Gas Connector – 72" Long	EA	12

DORMONT GAS CONNECTORS AND VALVES cont'd

Dormont 20 Series with Valve

Corrugated stainless steel connectors with special Supr Safe design to increase flexibility. Maximum service and safety and is approved for both indoor and outdoor use. This is perfect for range and furnace connections. This Series is AA and CGA approved. This connector comes in 20 3135 18 1/2" O.D. x 3/8" I.D. x 1/2" FIP Ball Valve.



20-3135-18

CATALOG NO.	DESCRIPTION	UOM	ORDER MULTIPLE
20-3135-18	Gas Connector – 18" Long	EA	12
20-3135-24	Gas Connector – 24" Long	EA	12
20-3135-36	Gas Connector – 36" Long	EA	12
20-3135-48	Gas Connector – 48" Long	EA	12

Gas Ball Valve

Gas Ball Valves meet the stringent ISO 9000 quality standard. AGA and CGA certified.



91-3042

CATALOG NO.	DESCRIPTION	UOM	ORDER MULTIPLE
91-3042	5/8" O.D. Flare x 3/4" FIP for "30 Series" Gas Conn.	EA	10
91-2032	1/2" O.D. Flare x 1/2" FIP for "20 Series" Gas Conn.	EA	10
92-3232	1/2" FIP x 1/2" FIP	EA	10
92-4242	3/4" FIP x 3/4" FIP	EA	10

BLACK STEEL WELDED NIPPLES

Black Steel Welded Nipples

Welded Steel that withstands 700 PSI test pressure is perfect for everyday use. The specs for this product are ASTM A 120 (Nom B 10) and the thickness is Sch. 40.



BPN-5

CATALOG NO.	DESCRIPTION	UOM	ORDER MULTIPLE
BPN-1	1/2" x CL Black Welded Nipple	EA	25
BPN-2	1/2" x 1-1/2" Black Welded Nipple	EA	25
BPN-3	1/2" x 2" Black Welded Nipple	EA	25
BPN-4	1/2" x 2-1/2" Black Welded Nipple	EA	25
BPN-5	1/2" x 3" Black Welded Nipple	EA	25
BPN-6	1/2" x 3-1/2" Black Welded Nipple	EA	25
BPN-7	1/2" x 4" Black Welded Nipple	EA	20
BPN-8	1/2" x 4-1/2" Black Welded Nipple	EA	15
BPN-9	1/2" x 5" Black Welded Nipple	EA	15
BPN-10	1/2" x 5-1/2" Black Welded Nipple	EA	25
BPN-11	1/2" x 6" Black Welded Nipple	EA	15
BPN-12	1/2" x 7" Black Welded Nipple	EA	25
BPN-13	1/2" x 8" Black Welded Nipple	EA	15
BPN-14	1/2" x 9" Black Welded Nipple	EA	25
BPN-15	1/2" x 10" Black Welded Nipple	EA	15
BPN-16	1/2" x 11" Black Welded Nipple	EA	25
BPN-17	1/2" x 12" Black Welded Nipple	EA	15
BPN-18	3/4" x CL Black Welded Nipple	EA	25
BPN-19	3/4" x 1-1/2" Black Welded Nipple	EA	25
BPN-20	3/4" x 2" Black Welded Nipple	EA	25
BPN-21	3/4" x 2-1/2" Black Welded Nipple	EA	25
BPN-22	3/4" x 3" Black Welded Nipple	EA	15
BPN-23	3/4" x 3-1/2" Black Welded Nipple	EA	15
BPN-24	3/4" x 4" Black Welded Nipple	EA	15
BPN-25	3/4" x 4-1/2" Black Welded Nipple	EA	20

Black Steel Welded Nipples (cont'd)

CATALOG NO.	DESCRIPTION	UOM	ORDER MULTIPLE
BPN-26	3/4" x 5" Black Welded Nipple	EA	20
BPN-28	3/4" x 6" Black Welded Nipple	EA	15
BPN-29	3/4" x 7" Black Welded Nipple	EA	25
BPN-30	3/4" x 8" Black Welded Nipple	EA	10
BPN-31	3/4" x 9" Black Welded Nipple	EA	25
BPN-32	3/4" x 10" Black Welded Nipple	EA	10
BPN-33	3/4" x 11" Black Welded Nipple	EA	25
BPN-34	3/4" x 12" Black Welded Nipple	EA	15
BPN-35	1" x CL Black Welded Nipple	EA	25
BPN-37	1" x 2" Black Welded Nipple	EA	25
BPN-38	1" x 2-1/2" Black Welded Nipple	EA	25
BPN-39	1" x 3" Black Welded Nipple	EA	5
BPN-40	1" x 3-1/2" Black Welded Nipple	EA	5
BPN-41	1" x 4" Black Welded Nipple	EA	10
BPN-43	1" x 5" Black Welded Nipple	EA	5
BPN-44	1" x 5-1/2" Black Welded Nipple	EA	10
BPN-45	1" x 6" Black Welded Nipple	EA	5
BPN-46	1" x 7" Black Welded Nipple	EA	10
BPN-47	1" x 8" Black Welded Nipple	EA	5
BPN-48	1" x 9" Black Welded Nipple	EA	10
BPN-50	1" x 11" Black Welded Nipple	EA	10
BPN-51	1" x 12" Black Welded Nipple	EA	5
BPN-52	1/2" x 18" Black Welded Nipple	EA	5
BPN-53	1/2" x 24" Black Welded Nipple	EA	3
BPN-54	1/2" x 36" Black Welded Nipple	EA	5
BPN-A12	1/2" Assortment Pack, 6 each of CL thru 6", pack of 66 PK	PK	2
BPN-A34	3/4" Assortment Pack, 6 each of CL thru 6", pack of 66 PK	PK	2

MALLEABLE BLACK IRON PIPE FITTINGS

90 Degree Ell

- Material: ASTM A 197 Cupola Malleable Iron, 150 lb.
- Dimensions:
ANSI B 16.3 - Malleable Iron Threaded Fittings
ANSI B 16.14 - Ferrous Pipe Plugs, Bushings etc.
ANSI B 16.39 - Malleable Iron Threaded Pipe Unions
- Threads: ANSI B 2.1 or BS 21
- Tensile Strength: 28.4 kg/mm.min



CATALOG NO.	DESCRIPTION	UOM	ORDER MULTIPLE
BPF-01	1/2" 90 Degree Elbow	EA	50
BPF-02	3/4" 90 Degree Elbow	EA	35
BPF-03	1" 90 Degree Elbow	EA	20

Coupling

The Coupling fitting is made of ASTM A 197 Cupola Malleable Iron, 150 LB. The dimensions for this fitting are ANSI B 16.3. The threads are ANSI V 2.1 or BS 21 and the tensile strength is 28.4 kg/mm.min for this fitting.



CATALOG NO.	DESCRIPTION	UOM	ORDER MULTIPLE
BPF-07	1/2" Coupling	EA	60
BPF-08	3/4" Coupling	EA	50
BPF-09	1" Coupling	EA	25

90 Degree Street Ell

The 90 Degree Street Ell fitting is made of ASTM A 197 Cupola Malleable Iron, 150 LB. The dimensions for this fitting are ANSI B 16.3. The threads are ANSI V 2.1 or BS 21 and the tensile strength is 28.4 kg/mm.min for this fitting.



CATALOG NO.	DESCRIPTION	UOM	ORDER MULTIPLE
BPF-13	1/2" 90 Degree Street Elbow	EA	60
BPF-14	3/4" 90 Degree Street Elbow	EA	35

Reducing Tee

The Reducing Tee fitting is made of ASTM A 197 Cupola Malleable Iron, 150 LB. The dimensions for this fitting are ANSI B 16.3. The threads are ANSI V 2.1 or BS 21 and the tensile strength is 28.4 kg/mm.min for this fitting.



CATALOG NO.	DESCRIPTION	UOM	ORDER MULTIPLE
BPF-20	3/4" x 1/2" x 1/2" Reducing Tee	EA	25
BPF-21	3/4" x 1/2" x 3/4" Reducing Tee	EA	20
BPF-34	1" x 1" x 1/2" Reducing Tee	EA	15

45 Degree Ell

The 45 Degree Ell fitting is made of ASTM A 197 Cupola Malleable Iron, 150 LB. The dimensions for this fitting are ANSI B 16.3. The threads are ANSI V 2.1 or BS 21 and the tensile strength is 28.4 kg/mm.min for this fitting.



CATALOG NO.	DESCRIPTION	UOM	ORDER MULTIPLE
BPF-04	1/2" 45 Degree Elbow	EA	50
BPF-05	3/4" 45 Degree Elbow	EA	40
BPF-06	1" 45 Degree Elbow	EA	15

Reducing Coupling

The Reducing Coupling fitting is made of ASTM A 197 Cupola Malleable Iron, 150 LB. The dimensions for this fitting are ANSI B 16.3. The threads are ANSI V 2.1 or BS 21 and the tensile strength is 28.4 kg/mm.min for this fitting.



CATALOG NO.	DESCRIPTION	UOM	ORDER MULTIPLE
BPF-10	3/4" x 1/2" Reducing Coupling	EA	60
BPF-11	1" x 1/2" Reducing Coupling	EA	30
BPF-12	1" x 3/4" Reducing Coupling	EA	25

Tee

The Tee fitting is made of ASTM A 197 Cupola Malleable Iron, 150 LB. The dimensions for this fitting are ANSI B 16.3. The threads are ANSI V 2.1 or BS 21 and the tensile strength is 28.4 kg/mm.min for this fitting.



CATALOG NO.	DESCRIPTION	UOM	ORDER MULTIPLE
BPF-16	1/2" Tee	EA	40
BPF-17	3/4" Tee	EA	35
BPF-18	1" Tee	EA	20

Bushing

The Bushing fitting is made of ASTM A 197 Cupola Malleable Iron, 150 LB. The dimensions for this fitting are ANSI B 16.14. The threads are ANSI V 2.1 or BS 21 and the tensile strength is 28.4 kg/mm.min for this fitting.



CATALOG NO.	DESCRIPTION	UOM	ORDER MULTIPLE
BPF-22	3/4" x 1/2" Hex Bushing	EA	75
BPF-23	1" x 1/2" Hex Bushing	EA	50

Cap

The Cap fitting is made of ASTM A 197 Cupola Malleable Iron, 150 LB. The dimensions for this fitting are ANSI B 16.3. The threads are ANSI V 2.1 or BS 21 and the tensile strength is 28.4 kg/mm.min for this fitting.



CATALOG NO.	DESCRIPTION	UOM	ORDER MULTIPLE
BPF-25	1/2" Cap	EA	75
BPF-26	3/4" Cap	EA	40
BPF-27	1" Cap	EA	35

Plug

The Plug fitting is made of ASTM A 197 Cupola Malleable Iron, 150 LB. The dimensions for this fitting are ANSI B 16.14. The threads are ANSI V 2.1 or BS 21 and the tensile strength is 28.4 kg/mm.min for this fitting.



CATALOG NO.	DESCRIPTION	UOM	ORDER MULTIPLE
BPF-28	1/2" Plug	EA	50
BPF-29	3/4" Plug	EA	30

Union

The Union fitting is made of ASTM A 197 Cupola Malleable Iron, 150 LB. The dimensions for this fitting are ANSI B 16.39. The threads are ANSI V 2.1 or BS 21 and the tensile strength is 28.4 kg/mm.min for this fitting.



CATALOG NO.	DESCRIPTION	UOM	ORDER MULTIPLE
BPF-31	1/2" Union	EA	50
BPF-32	3/4" Union	EA	35
BPF-33	1" Union	EA	20

In a class by itself.



The **ClearVue™** condensate pump isn't like all the other pumps. It features Floatless Sensor™ technology for super reliable operation without a mechanical float — No Float, No Problems. And ClearVue even has a brain. Built-in Variable Speed and Lift adjusts pump speed and lift as needed so ClearVue can adapt to any conditions. ClearVue even cleans itself to ensure worry-free operation. Learn more about how ClearVue stands out from the crowd at www.diversitech.com

CONDENSATE MANAGEMENT

ClearVue™ Tube & Traps.....78
 Condensate Drain Line Cleaning78-79
 Condensate Drain Line Switches 77
 Condensate Drain Pans, Fittings, Adapters.....79-81
 Condensate Pumps.....76-77
 Drain Line, Tubing81
 Tapes82



ClearVue™ Pump

About ClearVue™

The new ClearVue™ condensate pump from DiversiTech is unlike any other pump available. ClearVue™ features Variable Speed and Lift which makes ClearVue™ the smartest condensate pump on the market. Variable Speed and Lift provides ClearVue™ the ability to “think” and adapt to changing conditions. It’s not just off or on like a regular pump. ClearVue™ senses the amount of condensate water in the tank and its rate of inflow and adjusts its speed and lift to match the conditions and keep the tank clear. ClearVue™ starts pumping slowly and only accelerates if needed. And since it pumps slowly, ClearVue™ is super quiet and easy to live with.

With its Floatless Sensor™ technology, ClearVue™ doesn’t have the usual problems associated with float switch pumps. No more stuck floats or misaligned contacts to cause problems and potential damage. ClearVue™ uses Floatless Sensor™ technology to detect the condensate level in the tank and make the right decision about what to do next. ClearVue™ pump also features a see-through tank to give the contractor and homeowner a clear view of water, blockage, and buildup in the tank. This clear tank allows for quick troubleshooting due to normal buildup caused by daily condensate generation. ClearVue™ gives you the most improved, user-inspired features on the market.

What makes ClearVue™ Better?

- The ClearVue™ pump features Variable Speed and Lift which allows ClearVue™ to change pump speed and lift based on condensate flow. Other pumps are simply off or on but ClearVue™ starts pumping slowly, then gradually accelerates its lift if needed.
- Floatless Sensor™ technology means more reliable operation and no problems from stuck or fouled mechanical floats. ClearVue’s Floatless Sensor™ detects the condensate level without a float for reliable, accurate operation. **No float, no problems.**
- World’s only self-cleaning condensate pump. ClearVue™ features a unique self-cleaning mode to maintain itself and help help keep drain lines clear. Also, if ClearVue™ senses a blockage, it will begin self-cleaning and pulse the condensate water to try to remove the blockage.
- ClearVue™ also offers a clear tank that allows the user to see what’s happening inside. This means faster and more accurate troubleshooting.



**FLOATLESS
SENSOR™**

ClearVue
PUMP™

0-22'
Variable Speed
and Lift
Self-Cleaning



Stainless Steel
Mounting Tabs

Reversible
Deck

Clear Tank

**FLOATLESS
SENSOR**™

Silicone
Rubber Feet

NO FLOAT, NO PROBLEMS



Floatless Sensor™ Technology

ClearVue's sensors tell it how high the water is in the tank and how fast the inflow is. It then adjusts pump speed and lift to keep the tank clear and the system running properly. *No float, no problems.*

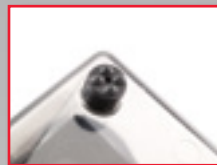

Molded Silicone Rubber Feet

Specially designed rubber feet dampen vibration and noise, making ClearVue™ quiet and easy to live with. And like the feet on all DiversiTech pumps, they are installed at the factory and stay in place.



Push Button Drain

Need to drain the tank quickly? Simply push the DRAIN button and ClearVue™ removes all the water in the tank—fast.



Stainless Steel Hang Tabs

Two stainless steel hanging tabs offer many installation options. The tabs are sturdy and durable and will last longer than standard plastic mounts.



Clear Tank

ClearVue™ also offers a clear tank so you can easily see what's happening inside the tank. The clear tank makes it easy to see the water level and diagnose other issues if needed.



LED Indicator Lights

4 LED indicator lights – Ready, Pumping, Cleaning, and Alarm. LED lights tell you what mode the pump is in at any given time.



Check Valve

Removable duckbill check valve resists corrosion and wear and is self-cleaning.

ClearVue™ Mini Pump

ClearVue™ Mini is the newest innovation in Ductless System pumps from DiversiTech. It's small, quiet and offers a host of unique features that help it outperform other mini-split pumps. And just like the original ClearVue™ and ClearVueKube™ pumps, ClearVue™ Mini features Variable Speed and Lift and Floatless Sensor™ technology that help the pump think and respond to changing conditions.



Look at everything ClearVue™ Mini offers:

NO FLOAT, NO PROBLEMS



Variable Speed and Lift

ClearVue™ Mini determines how fast condensate is entering the tank and adjusts its speed and lift to match the conditions and keep the tank clear.



Aluminum Pump Housing

ClearVue™ Mini features an aluminum housing that is built to last. This tough housing protects the pump from physical damage and helps contribute to the super quiet operation of the pump.

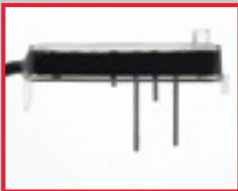

Floatless Sensor™ Technology

No float, no problem! That's what ClearVue™ Mini's Floatless Sensor™ will provide you and your customers. ClearVue™ Mini's Floatless Sensor™ eliminates many of the typical problems associated with conventional condensate pumps. By eliminating the float, ClearVue™ Mini won't fail like conventional float-switch pumps.



Rubber Mounting Pad

The molded rubber mounting pad can be used to mount ClearVue™ Mini to a vertical or horizontal surface; or to copper refrigerant lines with cable ties. The rubber pad decreases sound and vibration, contributing to a very quiet pump.

ClearVue™ Mini uses Floatless Sensor™ technology in different levels in the tank to provide the most accurate water level information to the pump's brain. And better information means a better pump. ClearVue's Floatless Sensor™ technology tells it how high the water is in the tank and how fast the inflow is. ClearVue™ Mini then uses this information to adjust its pump speed and lift to keep the tank clear and the system running properly.

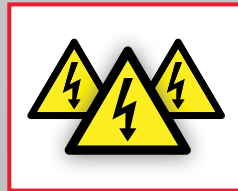

Multiple Voltages

ClearVue™ Mini can be powered with any voltage from 120 to 240V, 50 or 60 Hz. With one product suitable for multiple voltages, there is no need to stock separate SKUs for different voltages.



Super Quiet

With Variable Speed and Lift ClearVue™ Mini is nearly inaudible. You literally can hardly hear the pump run. This quiet operation allows maximum installation flexibility, as you can place the pump right in the room where people are.



LED Lights

ClearVue™ Mini features three LED indicator lights: Ready, Pumping, and Alarm. The LED lights tell you what mode the pump is in at any given time.

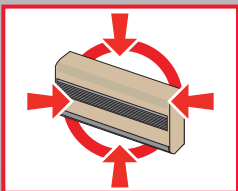

Flexible Installation

ClearVue™ Mini is compact — only 3-1/2" x 2" x 3". It fits almost anywhere including inside a line set cover, inside the wall cassette unit (on some cassette models), and easily installs in the ceiling or behind a wall. ClearVue™ Mini features suction lift of up to 6.5'.



Separate Tank

ClearVue™ Mini features a separate tank that can be located away from pump if needed, providing a more flexible installation. This small tank fits inside most indoor cassettes.



Built-in Overflow Switch

ClearVue™ Mini also include a built-in overflow switch that shuts down the compressor in case of clogged line. This prevents damage to equipment or the environment.



2 Year Warranty

ClearVue Mini includes an extended 2 year warranty.

QUICK, EASY INSTALLATION
HIGHEST LIFT: 22FT.
SAFETY SWITCH
AVAILABLE WITH TUBING
LOW PROFILE MODELS AVAILABLE

SAVE INSTALLATION TIME WITH

CP-22 CONDENSATE PUMPS



DiversiTech Condensate Pumps



Metal Hang Tabs

Shatterproof metal hang tabs have hole-and-slot design for easy mounting. Tabs are located on convenient 8" centers.



Indicator Lights

Red, yellow, and green indicator lights show the pump status. Green for power applied, yellow for pump running, and red for high level alarm.



Overflow Safety Switch

1/4" quick connect terminals provide easy connection to the built-in overflow switch. Two terminals are provided allowing the installer flexibility to connect air handler shut-down. Switch features SPDT isolated contacts ready for connection to building automation systems.



Four Inlet Holes

Four inlets versus two or three on other pumps provide the greatest installation versatility. Inlet holes have a reinforced wall for durability.



Rubber Feet

Rubber feet dampen vibration which reduces noise.



Check Valve

Removable check valve for easy cleaning.

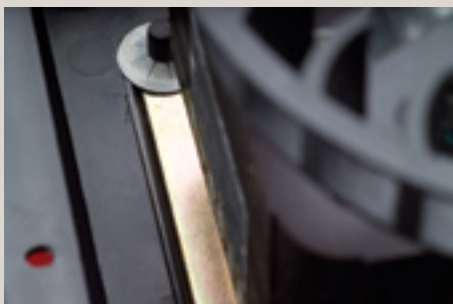

Vibration Isolation

An elastomeric motor mounting gasket dampens vibration.

High Rise Pan™

The High Rise Pan™ is an innovative new plastic drain pan design which allows placement of an air handler 2-3/4" above the outside lip of the pan without the need for separate, cumbersome mounting blocks. The pan has a molded-in network of risers to give a 5" lift. The risers are positioned to accept a wide variety of air handler sizes. Each riser has a specially shaped area at each end to accommodate a 2" x 2" anti-vibration pad which allows for quiet operation at all times.

Other features include heavy duty reinforcement throughout to give plenty of support as well as rolled edges for durability. One-piece plastic construction ensures no rust, leaks, or seams to split.

Each High Rise Pan™ comes complete with a Condensate Cop™ float switch, six E.V.A. anti-vibration pads, and one 3/4" PVC male adapter. Installation is straightforward and hassle-free.

Water pushes to the side of the pan preventing stagnant water from building up in inaccessible areas. This helps prevent slime and algae accumulations, eliminating call backs due to foul smells.

Now available in a Single Pack box, too!

Nestable! High Rise Pans™ take up less space.

Diversitech High Rise Pans™ are nestable, thus creating a tremendous decrease in volume needed to store and transport the pans.

FEATURE

BENEFIT

Nestable

Because DiversiTech High Rise Pans™ are nestable, there is a tremendous decrease in volume needed to store and transport the pans.



Eliminates a single line vendor

Eliminating a vendor cuts distributor costs and saves warehouse and transportation costs.

Water pushes to the side of the pan

This prevents stagnant water in inaccessible areas which helps prevent slime and algae buildup, eliminating call backs because of smell.

Includes EVA™ pads

EVA™ pads increase the overall height of the unit which increases available drain line pitch. EVA™ pads also create better sound and vibration dampening for a quieter installation, meaning less call backs due to noise.

Standard anti-vibration pad

Uses a standard, easily available anti-vibration pad, eliminating the need to stock extra SKUs of anti-vibration pads. Competitor products use specialized grommets which are not commonly available.



Installation kit includes six EVA™ pads and Condensate Cop™ float switch

The universal CC-1 can be placed anywhere on the pan. It can also be used on other secondary drain pans (metal or plastic). You will never forget a part because you have a complete kit!

80% thicker than the standard drain pan

Stronger and more durable for job site installations; resists work place installation damage, minimizing the need to replace drain pans damaged at job site.



ABS construction/flexible material

Time-tested material has been used for 15 years in the market. Flexibility allows for easier fit in tight work places and a faster installation. You'll have peace of mind for long term performance.

Heat/cold resistance

Meets structural and temperature requirements for attic installations.

5" riser

5" riser gives additional height needed to assure proper drain line pitch. Stack EVA™ pads for additional height.

Heavy-duty reinforced construction

Gives support for a wider range of air handler applications, minimizing the need to replace drain pans damaged at the job site.



Metal Drain Pan

DiversiTech introduces the ultimate in drain pan design - the seamless, nestable, metal drain pan with rolled edges.



FEATURES

BENEFITS

Seamless

The seamless design of DiversiTech metal drain pans virtually eliminates leaks from seams and folded corners found in conventional metal drain pans.

Nestable

Because DiversiTech drain pans are nestable, there is a tremendous decrease in volume needed to store and transport metal drain pans. A stack of seventy DiversiTech metal drain pans is only 12" high. Therefore, seventy DiversiTech pans fit in the same space as six conventional 2" deep non-nesting drain pans!

Single Piece Design

The DiversiTech metal drain pan is stamped from a single sheet of 26 gauge galvanized steel which prevents leaks.

Rolled Edge

The rolled edge virtually eliminates hand injuries during handling.

Two Outlets

Easy, flexible installation with an outlet on both the long and short side of the pan — no need to cut an outlet if you have the wrong pan on the job.

Fittings Included

Get everything you need for the installation of the pan in a single package. Fittings are included with DiversiTech metal drain pans.

A stack of
70 DiversiTech
metal drain pans
is only
12" high!

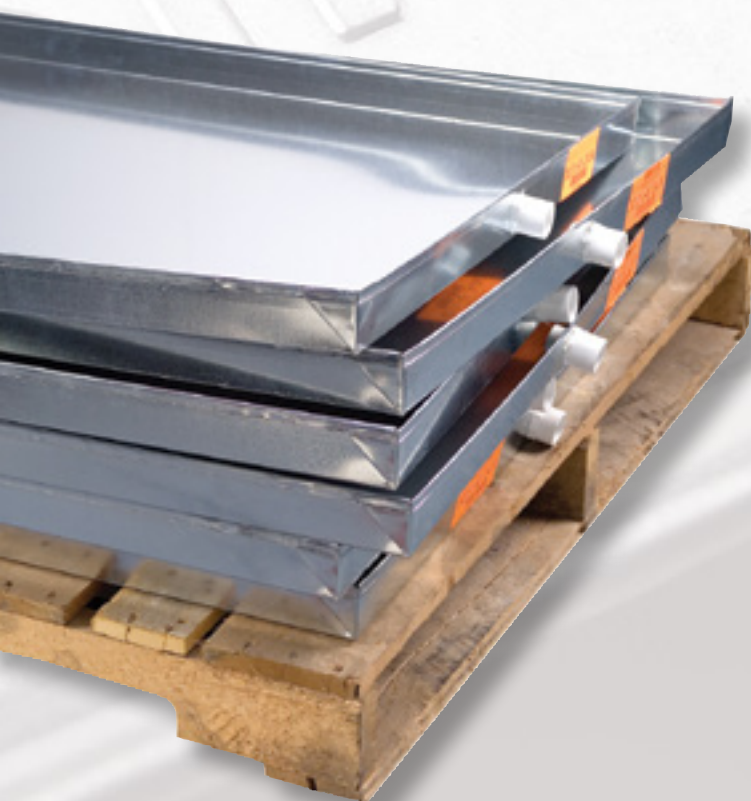

70 DiversiTech drain pans fit in the same space as 6 conventional 2" deep non-nesting drain pans!



Faster Install

Hinged Fast Lock Clamp

Hinged clamp bar self adjusts to angle of pan wall for a level switch. One-step installation with single screw fastener. Single screw fastens switch to pan – no drilling and no fussing with multiple thumb screws.



Works Everywhere

Universal Pan Mount

Easy twist to adjust to pan walls of 0, 8, 15 or 22 degrees. Fast, simple, easy, and level installation on metal or plastic pans for reliable moisture detection. Angled installation on other switches reduces their ability to detect condensate overflow.

CS1200 AC Shutoff Switch

The CS1200 Multi-Position AC Shutoff Switch from DiversiTech is a reliable, easy to use float switch that clips on to any pan size. Designed with contractor feedback in mind, the CS1200 features an adjustable housing that twists to match any pan angle for easy installation. The CS1200 detects water in the pan quickly and shuts off the equipment to prevent damage. The CS1200 also includes these great features:

- Hinged fast lock clamp
- LED Indicator light
- Universal pan mount
- Large water openings for fast detection
- Push to test button
- Simple 2 wire installation
- 5 AMP switching, 24 Volt



LED Indicator Light

Easy to see visual trip indicator alarm displays red if switch is tripped. CS1200 is the only pan switch with a light for fast troubleshooting.



Push to Test

Know instantly with the push of a button that your switch is installed and functioning properly. The bright LED indicator visually confirms proper operation.



Reliable Mechanical Contact Float Switch

Trouble free design reduces overflow failures and call backs. All electronics are mounted above the waterline, eliminating the chance of malfunction. The one piece molded float protects switch from water and debris. This is the same design used for safety interlocks because it gives you years of reliable, maintenance free service.



10x Open Area

10 times more open area for water to enter the detection chamber with our large open area design. No detection failure from small holes that can get clogged. Prevents switch failure from clogged water holes. No call backs due to clogged switches.



Simple 2 Wire Installation

With a simple 2 wire connection, the CS1200 is simple, easy, and fast to install. No checking polarity, just connect the switch in the red or yellow wire. Simple well designed electrical connections using 6 feet of the standard 18AWG wire and high current (5 amp) switching. The CS1200 gives you everything you need in one simple switch.



Clear Design

CS1200 is the only pan switch with a clear design for fast troubleshooting. Clear design lets you see the float and switch. Know instantly that the switch is working and components are functioning.

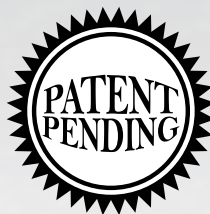

RECOGNIZED COMPONENT



Intertek

Wet Switch Flood Detector

WHAT IS THE WET SWITCH?

The Wet Switch is a solid state device designed to detect the presence of condensate water overflow. The Wet Switch is placed into the secondary drain pan — a normally dry pan. If the primary drain pan fails, condensate water will overflow into the secondary drain pan. Upon sensing moisture, the Wet Switch will turn the system off (typically the cause of the condensing water) to help prevent damage to carpets, walls, woodwork, ceilings, and other property.

- Hydrophilic Pad
- Integral Feet
- Stainless Steel Sensor Array
- Solid State Electronics
- Epoxy Encapsulated Electronics
- Double Throw Relay
- Standard 24VAC control
- Multiple Unit Connectivity

The Wet Switch is designed to interrupt the operation of cooling systems. However, it is a water activated switch and can be used in a variety of other applications.

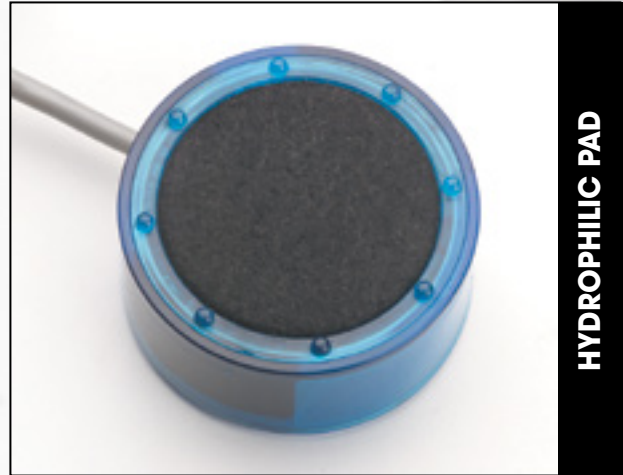

HYDROPHILIC PAD



INTEGRAL FEET



STAINLESS STEEL SENSORS

HYDROPHILIC PAD

A high tech polymer fiber quickly draws water into the sensor array using proven capillary technology.

INTEGRAL FEET

Integral feet raise the hydrophilic pad and sensor array off the drain pan slightly to prevent nuisance tripping and pan corrosion (metal pans only) from interfering with the sensor array.

STAINLESS STEEL SENSOR ARRAY

A high tech array of multiple stainless steel sensors detects even a minimal amount of water drawn into the hydrophilic pad.

COMPACT PACKAGE

This technology is packed into a 3-5/8" diameter by 1-1/4" high cylinder. Furnished complete with 5-conductor 22AWG stranded cable, 6' long.

DOUBLE THROW RELAY

Allows for wiring to interrupt system and to sound an alarm (by others) when moisture is detected.

SOLID STATE ELECTRONICS

Proven electronics prevent mechanical failure in an aggressive operating environment.

MULTIPLE UNIT CONNECTIVITY

Multiple unit connectivity allows for multiple Wet Switches to be connected in series to adequately cover large drain pan areas.

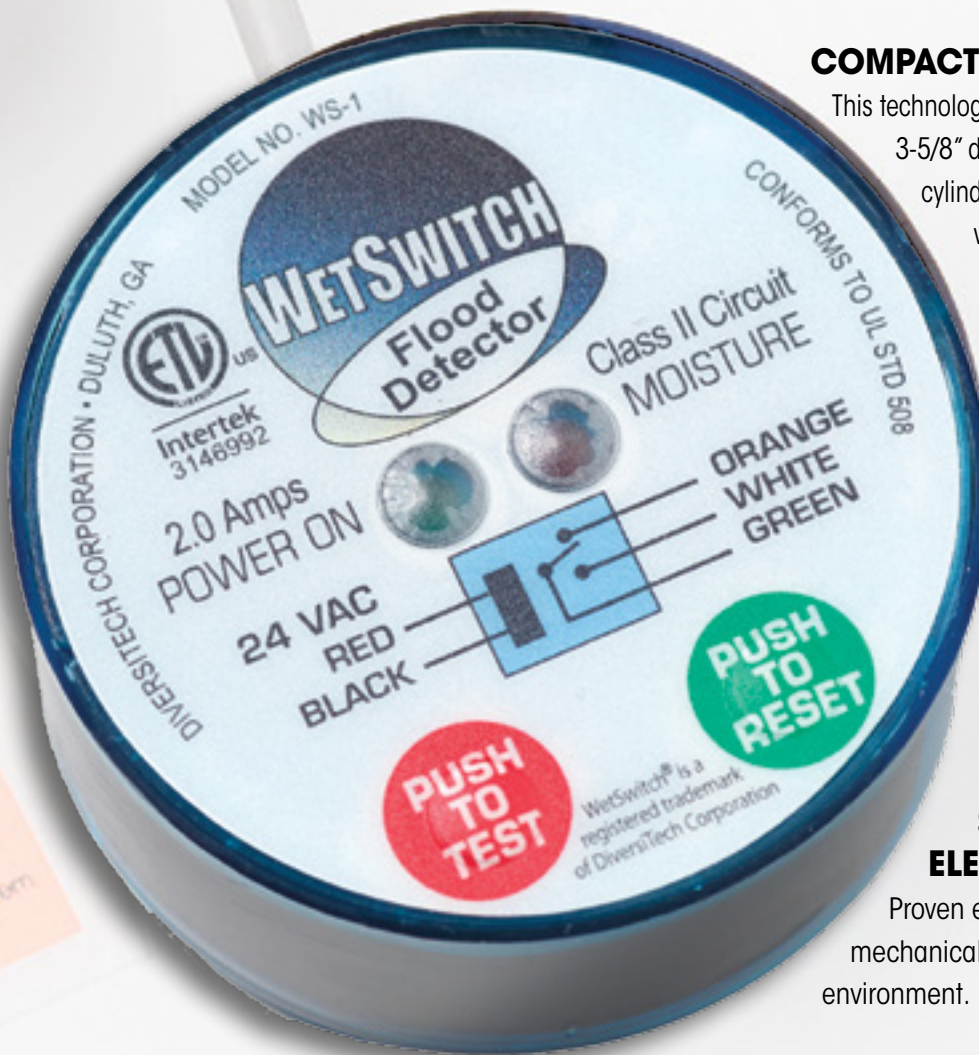

Drain Gun - Charles Gallo Brand



The Drain Gun - Charles Gallo Brand is a lightweight (3oz.) portable tool designed to blow out condensate drain lines instantly. Simply insert a Swoosh CO₂ cartridge into the Charles Gallo Drain Gun and with a press of the trigger — SWOOSH — 800 psi of oil free air clears the line.

INSTRUCTIONS:

- Unscrew cup and insert cartridge with the narrow end up.
- Without depressing the trigger, screw the cup slowly into the head until the cartridge contacts the puncture pin.
- Quickly and firmly screw the unit together to puncture and seal the cartridge in the same motion.

Note: Not completely screwing the unit together may result in escaping gas.

- Release the red safety catch.
- Depress the trigger to discharge the Swoosh CO₂ cartridge. For condensate drains, a quick and full discharge is best.

The Drain Gun - Charles Gallo Brand is for use with condensate drain and oil burner lines only.



SMALL AND LIGHTWEIGHT

The Drain Gun packs cleaning power into a small, lightweight package. This prevents the need for carrying heavy air or nitrogen tanks.

AIR POWER

The Drain Gun uses CO₂, eliminating the mess caused by water back flushing drain lines.

ENVIRONMENTALLY FRIENDLY

The Drain Gun uses carbon dioxide (CO₂), a common component of air, and is totally safe for use in the environment. The Drain Gun is an excellent alternative to the environmentally unfriendly practice of using refrigerant to clean the drain line.

FLEXIBLE HOSE ASSEMBLY

The flexible hose assembly enables you to maneuver through cabinets, coils, and hard to reach drains.

ADAPTER KIT

An adapter kit is available to allow for use on oil burner lines and tighter areas with a 90° fitting.



Fittings increase the versatility of the innovative Drain Gun and are available from your distributor.

90° FITTING FOR TIGHT AREAS



FITTING FOR OIL BURNER LINES



FITTING FOR LARGER DRAINS



Condensate Drain Line Cleaners

DiversiTech offers a family of products designed to help make condensate drain line cleaning faster and easier. From the super lightweight handheld Charles Gallo Drain Gun to the full power of the DrainDawg, DiversiTech has the right solution for every need. These products also have multiple other uses including operating air power tools, purging and testing copper tubing and more.



HANDHELD POWER

- Clears condensate drain lines with a SWOOSH!
- Lightweight and portable - goes anywhere
- Environmentally friendly
- Uses CO₂ refill cartridges



PORTABLE POWER

- Uses Nitrogen or CO₂
- Lightweight and portable
- Includes boxed fitting kit
- Easy to refill at your truck
- Multiple uses
- Includes inflatable DrainDawg fitting to clear lines fast



ULTIMATE POWER

- Uses Nitrogen or CO₂
- Includes 10' flexible hose and blowgun assembly
- Includes boxed fitting kit
- Multiple uses
- Includes inflatable DrainDawg fitting to clear lines fast



A/C Easy Tee®

The A/C Easy Tee® from DiversiTech is the easy way to unclog and clean drain lines in just seconds. It installs quickly and provides permanent, fast access for routine drain line maintenance. And with the Service Tool Kit adapters you can use water or compressed gas to quickly clean out the lines to maintain proper flow. Ideal for both commercial and residential systems.



Make your service calls faster and simpler with the A/C Easy Tee®.



Flexible to Use

The A/C Easy Tee® can be installed in many different ways. There is no designated inlet or outlet. Both connections can be either. The Service Tool Kit allows the technician to close off backflow creating full discharge of water or nitrogen to clean out the drain line. It can also be used with a wet/dry vac to suction dirt, debris, and gunk out of a primary drain pan.



Code Required

A Service Port – also called a Cleanout – is required by code (IMC - SECTION 307.2.5, IRC-SECTION M1411.3.3). Don't get your jobs red tagged by code inspectors. Install an A/C Easy Tee®.



Simple Design

The A/C Easy Tee® Service Port is a compact, simple design with no moving parts. Small, fiddly parts can and will fail. The A/C Easy Tee® has a simple cap that screws off for easy access to the condensate drain line.



No Drainage Block

Featuring a simple, easy design without flappers or ball valves like other products. Flappers and ball valves can fail or be left closed in the drain line.



www.aceasytee.com

CONDENSATE PUMPS

ClearVue™ Pump

No Float, No Problems! ClearVue's Variable Speed and Lift and Floatless Sensor™ make this the most advanced condensate pump ever. This new pump can provide up to 22' of lift if needed. ClearVue™ runs at the minimum speed needed, saving wear on the pump. The pump selects the lowest effective speed, making it quieter than a regular pump. Its unique self cleaning feature senses problems and automatically enters a self cleaning mode using condensate water to fix the issue. The ClearVue™ pump features a clear bottom tank to easily check the water level. Other features include: stainless steel mounting tabs, silicone rubber feet, reversible deck, four inlet holes, and LED indicator lights. ETL Listed File Number 3190890



IQP-120

CATALOG NO.	DESCRIPTION	UOM	ORDER MULTIPLE
IQP-120	ClearVue™ Pump – 120V – 0-22' Lift	EA	6
IQP-120T	ClearVue™ Pump w/Tube – 120V – 0-22' Lift	EA	6

FP-22 Furnace Pump



The FP-22 Furnace Pump is a full featured condensate pump designed for condensing furnaces and other hot water applications. It handles hot condensate water up to 190 degrees F. Other features include 22' lift, built-in P traps, steam resistant electronics, and a super tough tank. Available in 120 and 230V models.



FP-22

CATALOG NO.	DESCRIPTION	UOM	ORDER MULTIPLE
FP-22	Furnace Pump 120V 22' Lift 190°F Condensate	EA	1
FP-22-230	Furnace Pump 230V 22' Lift 190°F Condensate	EA	1

BP-46 Boiler Pump



The BP-46 Boiler Pump is a heavy duty, full featured condensate pump for hot water applications up to 212 degrees F. It features a 46' lift, oil resistant tank and impeller, two inlet holes and 1/4 turn check valve. Additional features include high impact construction, large tank and is available in 120 and 230V models.



BP-46

CATALOG NO.	DESCRIPTION	UOM	ORDER MULTIPLE
BP-46	High Temperature Boiler Pump 115V, 46' Lift 212°F Condensate	EA	1
BP-46-230	High Temperature Boiler Pump 230V, 46' Lift 212°F Condensate	EA	1

ClearVue™ Mini Ductless System Pump

Featuring super quiet operation, specifically designed for ductless system installations, and including Variable Speed and Lift and Floatless Sensor™, ClearVue™ Mini is chock full of innovative features, and priced competitively.



CVMINI

CATALOG NO.	DESCRIPTION	UOM	ORDER MULTIPLE
CVMINI	ClearVue Mini - Ductless System Pump	EA	6

CP-22 Pumps

Suitable for use with condensate from HVAC equipment which produce condensate. 22' of lift compared to the typical 20'. Features include vibration dampening feet and motor mounts, metal hang tabs, four inlet holes, a clear indicator display, a float switch and check valve. Integrating the CP-22 into your system is easy. 1/4" quick connect terminals provide easy connection to the built in overflow switch. 2 terminals are provided allowing flexibility to connect air handler shut down. UL Listed File Numbers E253155 and E258186.



CP-22

CATALOG NO.	DESCRIPTION	UOM	ORDER MULTIPLE
CP-22	Condensate Pump – 120V	EA	6
CP-22T	Condensate Pump – 120V w/20' 3/8" Tube	EA	6
CP-22-230	Condensate Pump – 230V	EA	6
CP-22-230T	Condensate Pump – 230V w/20' 3/8" Tube	EA	6

CP-22 Low Profile Pumps

The new CP-22LP comes packed with all the same great features found in the CP-22, but now in a low profile package. This pump is only 4-3/8" tall so it's a good fit for those instances where space is at a premium. The shorter reservoir holds 1/3 gallon. Suitable for use with condensate up to 160 degree F. UL Listed File Numbers E253155 and E258186.



CP-22LP

CATALOG NO.	DESCRIPTION	UOM	ORDER MULTIPLE
CP-22LP	Condensate Pump – 120V – Low Profile	EA	6
CP-22LP-230	Condensate Pump – 230V – Low Profile	EA	6

General Purpose Pumps

The DiversiTech CP-16 condensate pump is an economical alternative that's based off of the proven CP-22 design. More compact than the CP-22, it's designed to lift to a maximum of 16 feet. The CP-16 shares many of the great features of the CP-22, including hang tabs, four inlet holes, float switch, overflow switch, and a check valve. UL Listed File Numbers E253155 and E258186.



CP-16

CATALOG NO.	DESCRIPTION	UOM	ORDER MULTIPLE
CP-16	Condensate Pump 16' Lift 120V	EA	6
CP-16-230	Condensate Pump 16' Lift 230V	EA	6

Pump Parts & Accessories

Check valve installs easily and prevents water from travelling backwards into the pump and overflowing.



CP-CV

CATALOG NO.	DESCRIPTION	UOM	ORDER MULTIPLE
CP-CV	Replacement Check Valve for CP-22	EA	1

CONDENSATE PUMPS cont'd

CP-MINI-L



DiversiTech's CP-MINI-L Mini Split Condensate Pump is a quiet, super compact, and feature rich pump that fits almost anywhere. Handles multiple voltages. Pump fits easily in most line set covers.



CP-MINI-L

CATALOG NO.	DESCRIPTION	UOM	ORDER MULTIPLE
CP-MINI-L	Low Profile Mini-Split Pump 115V-240V 50/60 Hz EA	EA	6

Mini-Split Pumps

DiversiTech's Mini-Split Condensate Pump is a quiet, super compact, and feature rich pump that fits almost anywhere. Compatible with all brands of mini-split units. Provides 24' of lift with 6' suction lift. Pump fits easily in most line set covers and includes all needed accessories. Available in 115V and 230V versions.



CP-M115

CATALOG NO.	DESCRIPTION	UOM	ORDER MULTIPLE
CP-M115	Mini-Split Condensate Pump, 115V	EA	10
CP-M230	Mini-Split Condensate Pump, 230V	EA	10

CONDENSATE DRAIN LINE SWITCHES

PAN MOUNTED SWITCHES

Wet Switch Flood Detector

A solid state control designed to help prevent flooding, damage to carpets, walls, furniture, ceilings, etc. Now has a built in test and reset button for easier installation. Turns system off when detecting moisture due to condensate or drain leaks. One or two drops will cause Wet Switch to turn off a unit, alerting a serviceman to a moisture problem. A lit LED indicates the Wet Switch is activated and has turned the unit off. Reset simply by drying the absorbent pad with a paper towel and pressing the reset switch. Connects to 24 VAC. More than one unit may be connected to a system. 2 amp contact rating. Simple 5 wire installation. Sales displays available. ETL Listed File Number 3146992. UL508 Approved.



WS-1

CATALOG NO.	DESCRIPTION	UOM	ORDER MULTIPLE
WS-1	Wet Switch Flood Detector	EA	1

Condensate Cop™

Condensate Cop™ is a unique clamp on float switch intended for HVAC drain pan installation. The Condensate Cop™ features a large over clamping area that fits easily over the edge of all types of drain pans; including formed plastic and galvanized sheet metal. A separate float/probe assembly swivels to accommodate drain pans having sloped sides. The swivel action allows the installer to position the float switch for best operation and then clamp it into place. The probe features an inlet grill which prevents the float from being blocked or damaged by insulation or other debris. Sealed inside the probe is a magnetically actuated normally closed switch. The switch opens when rising water presents a potential flooding condition. Two wire connection for easy hook up to a thermostat "Y" (compressor) circuit. Provided complete with 5' (1.5 meter) leads, wire nuts, and clamping screws. Small size, 24V/1.5 amp NC reed switch. ETL Listed File Number 3166285. UL508 Approved.

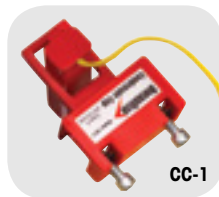

CC-1

CATALOG NO.	DESCRIPTION	UOM	ORDER MULTIPLE
CC-1	Condensate Cop™ Drain Pan Switch	EA	12

CS1200 AC Shutoff Switch

The CS1200 is a fast installing, reliable, condensate overflow detection pan switch. Featuring a unique universal pan mount design to assure accurate detection in metal or plastic secondary drain pans. UL508 Approved.



CS1200

CATALOG NO.	DESCRIPTION	UOM	ORDER MULTIPLE
CS1200	CS1200 AC Shutoff Switch	EA	12

CS-3 Condensate Pan Switch

The CS-3 is a clip-on pan switch that use a magnetic reed switch for condensate overflow protection.



CS-3

CATALOG NO.	DESCRIPTION	UOM	ORDER MULTIPLE
CS-3	Condensate Switch – Clip	EA	12

Pipe Mounted Switches

DiversiTech Flood Prevention Switches are simple to install, easy to service and extremely reliable. As water level in the auxiliary or main drain pipe rises due to a clogged air conditioning condensate drain, the switch shuts off the system - thus preventing water from overflowing and causing damage to doors, walls and ceilings. At the heart of the switch is a durable yet precise magnetic reed switch. Constructed of materials that will not rust or stick, the switch operates smoothly every time. UL508 Approved.



CS-1

CS-2

CATALOG NO.	DESCRIPTION	UOM	ORDER MULTIPLE
CS-1	Condensate Switch – Tee	EA	12
CS-2	Condensate Switch – Elbow	EA	12

Universal Alarm

A universal low voltage alarm that can indicate possible system trouble. Use with the Wet Switch, SOS, Condensate Cop, CP 22 (all types) and all float switches on 24VAC control circuits. If an alarm condition exists, the homeowner can turn the alarm off with a "silence" button until service is obtained, however a red trouble LED will remain lit. Also features: easy 2 wire connection, label to print contractor information, and low current draw. Actuates at greater than 18V to prevent any false alarms due to low voltage. Includes 2 wire nuts, a sheet metal screw, and double sided tape for convenient installation options. Also includes instructions for wiring normally open switch systems (for the CP 22 or other condensate pumps).



UA-1

CATALOG NO.	DESCRIPTION	UOM	ORDER MULTIPLE
UA-1	Universal Alarm for 24VAC	EA	12

CLEARVUE™ TUBE & TRAPS

ClearVue™ Tube

Clear, schedule 40 PVC ideal for installing as condensate drain lines in other areas where seeing the inside of the tubing is helpful. ClearVue™ Tube makes it easy to quickly spot build up or obstructions in drain lines for faster troubleshooting. Available in 5ft lengths.



CATALOG NO.	DESCRIPTION	UOM	ORDER MULTIPLE
CV-TUBE	ClearVue™ Tube – 5' section	EA	50

Drain Trap Kits

Drain trap kits feature clear PVC traps with multiple cleanouts for easy maintenance. Available in several fitting styles with or without float switch to match any installation need.



CATALOG NO.	DESCRIPTION	UOM	ORDER MULTIPLE
DTK113	Drain Trap Kit, 3/4 in Blow Molded	EA	1
DTK113B	Drain Trap Kit, 3/4 in, w/Brush	EA	1
DTK205	Drain Trap Kit, 3/4 in, Deep w/switch	EA	1
DTK207	Drain Trap Kit, 3/4 in, Standard w/switch and cross	EA	1
DTK210	Drain Trap Kit, 3/4 in, Standard w/switch	EA	1

ClearVue™ Traps

DiversiTech introduces new ClearVue™ P and R traps. These traps are made from smooth, clear PVC with no flat spots to restrict flow. With these new ClearVue™ traps its easy to see directly into them to detect blockages and prevent problems before they become severe. Ideal for installation in condensate drain lines.

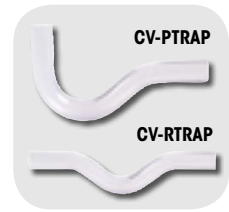

CATALOG NO.	DESCRIPTION	UOM	ORDER MULTIPLE
CV-PTRAP	ClearVue™ 3/4" P trap	EA	25
CV-RTRAP	ClearVue™ 3/4" R trap	EA	25

Drain Trap Kit Cross Reference

DIVERSITECH CATALOG NO.	RECTORSEAL PART NO.
DTK113	EZT-113
DTK113B	EZT-113B
DTK205	EZT-205
DTK207	EZT-207
DTK210	EZT-210

CONDENSATE DRAIN LINE CLEANING

Drain Gun™ - SWOOSH CO₂ Cartridges

Clears condensate drains with a SWOOSH! A lightweight (3 oz.) portable tool designed to blow out drain lines instantly. New larger SWOOSH CO₂ cartridges now deliver 800 PSI of oil free air to clear the line. Each unit comes equipped with a tapered fitting to work on 3/8in. – 3/4in. drain openings. Flexible hose assembly maneuvers through cabinets, coils and hard to reach drains. Cartridges are environmentally safe and recyclable. No need for air or nitrogen tanks. Reduces labor costs and time on service calls.



CATALOG NO.	DESCRIPTION	UOM	ORDER MULTIPLE
GG-1	Drain Gun™ for A/C Condensate Lines	EA	6
GGC-12	SWOOSH CO ₂ Cartridges, pack of 12	PK	1
GGC-6	SWOOSH CO ₂ Cartridges, pack of 6	PK	1
GG-1A	Drain Gun™ Adapter Kit	EA	1
GG-1H	Drain Gun™ Hose Assembly	EA	1
GG-1TF	Drain Gun™ replacement tip	EA	1
GG-1BOR	Drain Gun™ bottom o-ring, pack of 5	PK	1
GG-1NHL	Drain Gun™ body, no hose	EA	1

DrainDawg™

The DrainDawg™ is a complete condensate drain cleaning kit, including the CT-475M deluxe nitrogen / CO₂ 0-475 psi regulator, the TG-10 & BS-25 ten foot hose and blowgun assembly, and the CW-15 fifteen inch whip hose. Also included is the AP-DD DrainDawg™ Accessory Fitting Kit which contains the DF-75 DrainDawg™ inflatable tip, the CK-141 3/4"-1" cone fitting, the FA-02 CO₂ to nitrogen adapter, the QN-S3 needle tip, and the TC-25 tire chuck. Made in USA.



CATALOG NO.	DESCRIPTION	UOM	ORDER MULTIPLE
CB-2	DrainDawg™ Kit	EA	3

DrainKat™

The DrainKat™ is an over the shoulder refillable, nitrogen or CO₂ mini drain cleaning kit. Featuring a small cylinder that holds 9 cubic feet of nitrogen or 2-1/2 pounds of CO₂. The cylinder includes an integral mounted regulator for quick and easy adjustment of discharge pressure. Get exactly the amount of pressure you need with a quick adjustment on the regulator. Furnished complete with an 87" hose and drain gun kit, the CW-15 whip hose, and the AP-DK DrainKat™ Accessory Fitting Kit which contains the DF-75 DrainDawg™ inflatable tip, the CB-03 3/4"-1" cone fitting, the FA-01 male to male CO₂ to nitrogen adapter, the FA-03 CO₂ trans-fill adapter, and the the QN-S3 needle tip. Made in the USA.



CATALOG NO.	DESCRIPTION	UOM	ORDER MULTIPLE
MBK-6	DrainKat™ Kit	EA	2

CONDENSATE DRAIN LINE CLEANING cont'd

A/C Easy Tee®

A/C Easy Tee® is a simple, inexpensive way to comply with the International Mechanical Code M32-12. It provides a Condensate Drain Service Port that is flexible and easy to use with nitrogen, water, or shop vac. A/C Easy Tee® has no valve or moving parts that could fail.

CATALOG NO.	DESCRIPTION	UOM	ORDER MULTIPLE
ET75	A/C Easy Tee®	EA	20
ET75-KIT	A/C Easy Tee® Kit - 2 Tees and ST75	EA	6
ST75	Service Tool Kit	EA	6



Drain Dawg™ and Drain Kat™ Fittings

The Drain Dawg™ and Drain Kat™ products are compatible with a series of fittings to connect to condensate drain lines and hoses. The fittings are available individually, or as kits for the Drain Dawg™ and Drain Kat™.

CATALOG NO.	DESCRIPTION	UOM	ORDER MULTIPLE
AP-DD	Drain Dawg™ Accessory Pack	EA	1
AP-DK	Drain Kat™ Accessory Pack	EA	1
BS-25	Blow gun with safety tip for Drain Dawg™ or Drain Kat™	EA	1
CB-03	3/4 in. cone tip with female thread for Drain Dawg™ or Drain Kat™ blow gun	EA	1
CK-141	3/4 in. cone with male thread for use with whip hose for Drain Dawg™ or Drain Kat™	EA	1
CW-15	15 in. whip hose for Drain Dawg™ or Drain Kat™	EA	1
DF-75	Drain Dawg™ inflatable tip for drain line blowout	EA	1
FA-01	Nitrogen to CO2 adapter, male by male for Drain Kat™	EA	1
FA-02	Nitrogen to CO2 adapter, female by female for Drain Dawg™	EA	1
FA-03	CO2 transfill adapter for Drain Kat™	EA	1
QN-S3	Needle tip with female thread for Drain Dawg™ or Drain Kat™ blow gun	EA	1
TC-25	Tire chuck for Drain Dawg™	EA	1
TG-10	120 in. blow gun hose for Drain Dawg™	EA	1
TG-87A	87 in. blow gun hose for Drain Kat™	EA	1



CONDENSATE DRAIN PANS, FITTINGS, ADAPTERS

A/C Secondary Condensate Drain Pans

Rolled edges for durability, ribbed bottoms for rigidity, and reinforced corners for strength. 3/4in. PVC fittings are included with each pan. No seams, no rust, and no leakage. ABS materials will not put out toxic smoke. Available in over 20 convenient sizes. Five pans per clip.

CATALOG NO.	BOTTOM DIMENSION		OVERALL DIMENSION		DEPTH		UOM	ORDER MULTIPLE
	IN.	CM.	IN.	CM.	IN.	CM.		
6-1838L	18" x 38"	46 x 97	20" x 40"	51 x 102	2"	5	EA	5
6-1838S	18" x 38"	46 x 97	20" x 40"	51 x 102	2"	5	EA	5
6-1846S	18" x 46"	46 x 117	20" x 48"	51 x 122	2"	5	EA	5
6-2424L	24" x 24"	61 x 61	26" x 26"	66 x 66	2"	5	EA	5
6-2626L	26" x 26"	66 x 66	28" x 28"	71 x 71	2"	5	EA	5
6-2739L	27" x 39"	69 x 99	29" x 41"	74 x 104	2"	5	EA	5
6-2748L	27" x 48"	69 x 122	29" x 50"	74 x 127	2"	5	EA	5
6-2748S	27" x 48"	69 x 122	29" x 50"	74 x 127	2"	5	EA	5
6-2748L-100	27" x 48"	69 x 122	29" x 50"	74 x 127	2"	5	EA	100
6-2763L	27" x 63"	69 x 160	29" x 65"	74 x 165	2"	5	EA	5
6-2763S	27" x 63"	69 x 160	29" x 65"	74 x 165	2"	5	EA	5
6-3030L	30" x 30"	76 x 76	32" x 32"	81 x 81	2"	5	EA	5
6-3050L	30" x 50"	76 x 127	32" x 52"	81 x 132	2"	5	EA	5
6-3050S	30" x 50"	76 x 127	32" x 52"	81 x 132	2"	5	EA	5
6-3060L	30" x 60"	76 x 152	32" x 62"	81 x 157	2"	5	EA	5
6-3060S	30" x 60"	76 x 152	32" x 62"	81 x 157	2"	5	EA	5
6-3060L-100	30" x 60"	76 x 152	32" x 62"	81 x 157	2"	5	EA	100
6-3263L	32" x 63"	81 x 160	34" x 65"	86 x 165	2"	5	EA	5
6-3263S	32" x 63"	81 x 160	34" x 65"	86 x 165	2"	5	EA	5
6-3636L	36" x 36"	91 x 91	38" x 38"	97 x 97	2"	5	EA	5
6-3660L	36" x 60"	91 x 152	38" x 62"	97 x 157	2"	5	EA	5
6-3660S	36" x 60"	91 x 152	38" x 62"	97 x 157	2"	5	EA	5

L = Drain Line Outlets in Long Side S = Drain Line Outlets in Short Side



CONDENSATE DRAIN PANS, FITTINGS, ADAPTERS cont'd

High Rise Pans™

The High Rise Pan™ is an innovative new plastic drain pan design which allows placement of an air handler 2 3/4in. above the outside lip of the pan without the need for separate, cumbersome mounting blocks. The pan has a molded in network of risers to give a 5in. lift. The risers are positioned to accept a wide variety of air handler sizes. Each riser has a specially shaped area at each end to accommodate a 2in. x 2in. anti vibration pad which allows for quiet operation at all times. Other features include heavy duty reinforcement throughout to give plenty of support as well as rolled edges for durability. One piece plastic construction ensures no rust, leaks, or seams to split. Each High Rise Pan™ comes complete with a Condensate Cop™ float switch, 6 EVA™ anti vibration pads, and 1 3/4in. PVC male adapter. Installation is straightforward and hassle free.

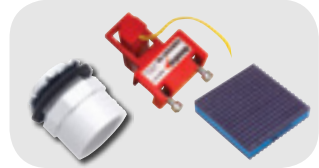

CATALOG NO.	DESCRIPTION	UOM	ORDER MULTIPLE
6-HK2748	High Rise Pan™ 27" x 48" with Installation Kit including: One CC-1 Condensate Cop, Six MP-2E 2" x 2" EVA™ Pads, One 6-1 3/4" PVC male adapter	EA	5
6-HK2748-1	Single Pack Kit – High Rise Pan™ 27" x 48" with Installation Kit including: One CC-1 Condensate Cop, Six MP-2E 2" x 2" EVA™ Pads, One 6-1 3/4" PVC male adapter	EA	1
6-HK2766	High Rise Pan™ 27" x 66" with Installation Kit including: One CC-1 Condensate Cop, Six MP-2E 2" x 2" EVA™ Pads, One 6-1 3/4" PVC male adapter	EA	5
6-HK2766-1	Single Pack Kit – High Rise Pan™ 27" x 66" with Installation Kit including: One CC-1 Condensate Cop, Six MP-2E 2" x 2" EVA™ Pads, One 6-1 3/4" PVC male adapter	EA	1
6-HK3050	High Rise Pan™ 30" x 50" with Installation Kit including: One CC-1 Condensate Cop, Six MP-2E 2" x 2" EVA™ Pads, One 6-1 3/4" PVC male adapter	EA	5
6-HK3050-1	Single Pack Kit – High Rise Pan™ 30" x 50" with Installation Kit including: One CC-1 Condensate Cop, Six MP-2E 2" x 2" EVA™ Pads, One 6-1 3/4" PVC male adapter	EA	1
6-HK3060	High Rise Pan™ 30" x 60" with Installation Kit including: One CC-1 Condensate Cop, Six MP-2E 2" x 2" EVA™ Pads, One 6-1 3/4" PVC male adapter	EA	5
6-HK3060-1	Single Pack Kit – High Rise Pan™ 30" x 60" with Installation Kit including: One CC-1 Condensate Cop, Six MP-2E 2" x 2" EVA™ Pads, One 6-1 3/4" PVC male adapter	EA	1

Heavy Duty High Rise Pans

A thicker, tougher version of our regular High Rise Pans. Each pan includes a kit with one CS1200 float switch, six EVA™ anti-vibration pads and one 3/4" PVC male adapter.



CATALOG NO.	DESCRIPTION	UOM	ORDER MULTIPLE
6-HK3050HD	Heavy Duty High Rise Pan 30" x 50"	EA	5
6-HK3060HD	Heavy Duty High Rise Pan 30" x 60"	EA	5
6-HK3070HD	Heavy Duty High Rise Pan 30" x 70"	EA	5

Furnace Pans

DiversiTech furnace pans are designed specifically for furnace installations. Their one piece construction provides strength and durability for any furnace installation.



CATALOG NO.	DESCRIPTION	UOM	ORDER MULTIPLE
6-HK3364FUR	Furnace Pan – 33" x 64" with installation kit	EA	
6-HK3378FUR	Furnace Pan – 33" x 78" with installation kit	EA	

Metal Drain Pan

The ultimate in drain pan design — tailored for easy distribution and installation. Full of features to make life easier on both the distributor and the contractor. Seamless, one piece metal construction with rolled edges on all sides for maximum safety and integrity. Nestable as well — a stack of 70 pans is only a foot high! Once on site, you'll never have to return to the distributor for missing parts. The fittings are packaged with the pan for simple and efficient installation. Choose between two possible drain outlet positions and install with confidence.



CATALOG NO.	DESCRIPTION	UOM	ORDER MULTIPLE
6-M2748	26 Gauge Metal Drain Pan – 27" x 48"	EA	5
6-M2763	26 Gauge Metal Drain Pan – 27" x 63"	EA	5
6-M3030	26 Gauge Metal Drain Pan – 30" x 30"	EA	5
6-M3050	26 Gauge Metal Drain Pan – 30" x 50"	EA	5
6-M3060	26 Gauge Metal Drain Pan – 30" x 60"	EA	5
6-M3263	26 Gauge Metal Drain Pan – 32" x 63"	EA	5

A/C Condensate Drain Pan Fittings

The Drain Pan Fittings are designed to be used with our Condensate Drain Pans.



CATALOG NO.	DESCRIPTION	UOM	ORDER MULTIPLE
6-1	3/4" Slip	EA	50
6-2	1" Slip	EA	50
6-3	3/4" Slip with Plastic Nut	EA	50
6-5	3/4" Female Pipe Thread	EA	50

Water Heater Pans

Aluminum water heater pans can be installed under gas or electric water heaters to protect from water damage. Includes a 1" PVC drain fittings to allow for connection to indirect drain. Each pan is manufactured from .032 in. prime aluminum with a pre-cut side opening to accommodate a drain fitting. Pan depth is a minimum 2.5 in.



CATALOG NO.	DESCRIPTION	UOM	ORDER MULTIPLE
6-M22	Aluminum Water Heater Pan - 22 in.	EA	6
6-M24	Aluminum Water Heater Pan - 24 in.	EA	6
6-M26	Aluminum Water Heater Pan - 26 in.	EA	6
6-M30	Aluminum Water Heater Pan - 30 in.	EA	6

CONDENSATE DRAIN PANS, FITTINGS, ADAPTERS cont'd

Mini-Split Drain Adapters

Mini Split fan units — either ceiling cassettes or wall cassettes — typically have a unique (metric) drain line fitting. DiversiTech's adapters convert this metric fitting to standard drain line tubing sizes.



CATALOG NO.	DESCRIPTION	UOM	ORDER MULTIPLE
230-DLFY	Mini-Split Drain Line Wye	EA	1
230-DLF16	16mm Mini-Split Drain Line Adapter	EA	1
230-DLF18	18mm Mini-Split Drain Line Adapter	EA	1
230-DLF20	20mm Mini-Split Drain Line Adapter	EA	1
230-DLF25	25mm Mini-Split Drain Line Adapter	EA	1
230-DLF32	32mm Mini-Split Drain Line Adapter	EA	1

Condensate Drain Pans

When a mini split system operates in heat pump mode, the outdoor coil becomes the evaporator coil. Typically, condensation generates from the evaporator coil. In certain installations, the condenser coil may be mounted overhead on brackets affixed to a wall. In these overhead applications, dripping condensation may be a nuisance. Condensate drain pans bolt onto the condenser mounting brackets, and the drain line can be plumbed to a nearby drain location. Furnished complete with all mounting hardware and drain pan outlet, condensate drain pans are available in either plastic or powder coated steel.



CATALOG NO.	DESCRIPTION	UOM	ORDER MULTIPLE
230-DPPL	Poly Condensate Drain Pan (Large)	EA	1
230-DPPM	Poly Condensate Drain Pan (Medium)	EA	1

DRAIN LINE, TUBING

Mini-Split Condensate Drain Line

A unique drain line for mini-split units. This large diameter drain line is typical for mini-split installations. Furnished in 160 feet lengths with cut marks every 3.28 feet. Accommodates 5/8" and 3/4" connections.



CATALOG NO.	DESCRIPTION	UOM	ORDER MULTIPLE
230-DL16	5/8" ID Mini-Split Drain Line	EA	160'
230-DL16-20	5/8" ID Mini-Split Drain Line – 20' section	EA	1

Clear Vinyl Tubing

Clear vinyl hose applications include: air conditioning and refrigeration condensate drains, condensate pump discharge lines and humidifier overflows.



CATALOG NO.	DESCRIPTION	UOM	ORDER MULTIPLE
7-316	3/16" ID Clear Vinyl Tubing – 100' section	EA	100'
7-CVMINITUBE	3/16" ID CVMINI Tubing – 100' section	EA	100'
7-14	1/4" ID Clear Vinyl Tubing – 100' section	EA	100'
7-38	3/8" ID Clear Vinyl Tubing – 100' section	EA	100'
7-12	1/2" ID Clear Vinyl Tubing – 100' section	EA	100'
7-58	5/8" ID Clear Vinyl Tubing – 100' section	EA	100'
7-34	3/4" ID Clear Vinyl Tubing – 100' section	EA	100'
7-78	7/8" ID Clear Vinyl Tubing – 100' section	EA	50'
7-10	1" ID Clear Vinyl Tubing – 100' section	EA	50'

Gorilla Tube® Clear Vinyl Tubing

Applications include: air conditioning and refrigeration condensate drains, condensate pump discharge lines, and humidifier overflows. Several sizes from 1/4" to 1" diameter. Non-toxic clear vinyl chloride.

Select Gorilla Tube® over standard clear vinyl tube because:

- Extra rigid design resists crimping and kinking due to durometer value of 80 (Shore A) and thicker wall
- Maximum service temperature 140°F (60°C)
- Better performance in cold weather climates.



CATALOG NO.	DESCRIPTION	UOM	ORDER MULTIPLE
7-14P	1/4", .250" I.D., .360" O.D., .055 wall thickness	EA	100'
7-38P	3/8", .375" I.D., .495" O.D., .060 wall thickness	EA	100'
7-12P	1/2", .500" I.D., .631" O.D., .066 wall thickness	EA	100'
7-58P	5/8", .625" I.D., .771" O.D., .073 wall thickness	EA	100'
7-34P	3/4", .750" I.D., .913" O.D., .082 wall thickness	EA	100'
7-78P	7/8", .875" I.D., 1.050" O.D., .088 wall thickness	EA	50'
7-10P	1", 1.000" I.D., 1.215" O.D., .108 wall thickness	EA	50'

Braided Clear Vinyl Tubing

Braided clear vinyl offers better strength and sealing than regular clear vinyl tubing and is very kink-resistant.



CATALOG NO.	DESCRIPTION	UOM	ORDER MULTIPLE
7-14B	1/4" ID Braided Clear Vinyl Tubing – 100' section	EA	100'
7-38B	3/8" ID Braided Clear Vinyl Tubing – 100' section	EA	100'
7-12B	1/2" ID Braided Clear Vinyl Tubing – 100' section	EA	100'
7-58B	5/8" ID Braided Clear Vinyl Tubing – 100' section	EA	100'
7-34B	3/4" ID Braided Clear Vinyl Tubing – 100' section	EA	100'

TAPES

Cork Insulation Tape

Adheres firmly to all metals. Use on hot or cold pipes to stop condensation and drips.



CATALOG NO.	DESCRIPTION	UOM	ORDER MULTIPLE
6-330	Cork Insulation Tape – 1/8" x 2" x 30' Roll – Black	EA	12

Foam Insulation Tape

Superior self-adhesive foam tape can be used on hot or cold pipes. Fits well around valves and fittings. Easily cut and molded.



CATALOG NO.	DESCRIPTION	UOM	ORDER MULTIPLE
6-9718	Foam Insulation Tape – 1/8" x 2" x 30' Roll – Black	EA	12

PTFE Tape

Made of pure white PTFE. Non toxic. For use with chemicals, solvents, oxygen, and on food lines. Withstands up to 2000 psi of pressure.



CATALOG NO.	DESCRIPTION	UOM	ORDER MULTIPLE
6-733	Teflon Tape – 1/2" x 520"	EA	100
6-734	Teflon Tape – 1/2" x 260"	EA	100
6-735	Teflon Tape – 3/4" x 520"	EA	100
6-736	Teflon Tape – 3/4" x 260"	EA	100

GENERAL INDUSTRIAL

Abrasive Cloths.....	84
Aerosols.....	84
Batteries By Rayovac®.....	85
Carton Sealing Tape and Dispenser.....	85
Contact Cleaners.....	85-86
Degreasers.....	86
Drop Cloths.....	86
Hand Cleaners.....	86
Industrial Towels.....	87
Lubricants.....	87-88
Markers.....	89
Paints and Primers.....	89
Safety Supplies, Devices.....	90
Sealant, Epoxy, Glue.....	91
Sealing Compounds, Adhesive.....	91-93
Sheet Metal Screws.....	93-94
Wasp, Hornet and Yellow Jacket Killers.....	94



ABRASIVE CLOTHS

All Purpose Cleaning Pads

For cleaning copper tubes and fittings. Made of nylon and will not rust. Can be used wet or dry. Leaves no residue and is long lasting.



ACP-10

CATALOG NO.	DESCRIPTION	UOM	ORDER MULTIPLE
ACP-10	All Purpose Cleaning Pads – pack of 10	PK	1

Abrasive Cloth

Aluminum oxide, high quality 120 grit, abrasive cloth to thoroughly clean copper and steel tubing. Works wet or dry. Exceeds industry standards for abrasive cloth.



SC-10

CATALOG NO.	DESCRIPTION	UOM	ORDER MULTIPLE
SC-10	Abrasive Cloth – 1-1/2" x 10 yds.	EA	1
SC-25	Abrasive Cloth – 1-1/2" x 25 yds.	EA	1

Grip-Cut™

Open mesh sand screen cloth. Aluminum oxide grain resin bonded to synthetic nylon cloth. 100% waterproof, but can also be used dry for sanding by hand or with portable tools. Most effective where clogging is a problem, such as soft materials. 180 grit.



SCM-5

CATALOG NO.	DESCRIPTION	UOM	ORDER MULTIPLE
SCM-5	Grip-Cut™ – 1-1/2" x 5 yds.	EA	1
SCM-10	Grip-Cut™ – 1-1/2" x 10 yds.	EA	1
SCM-25	Grip-Cut™ – 1-1/2" x 25 yds.	EA	1

AEROSOLS

Sure-Stick Heavy Duty Adhesive Spray

Wide web spray adhesive ideal for both temporary or permanent bonding. Waterproof, transparent and non-staining. Use for the toughest adhesive applications with leather, cardboard, most plastics, polyethylene sheeting and insulation in HVAC applications. Cleans with mineral spirits. Not for use on vinyl.



315-20

CATALOG NO.	DESCRIPTION	UOM	ORDER MULTIPLE
315-20	Sure-Stick Adhesive Spray – 12 oz. Aerosol	EA	12

CBC II Contact Cleaner

A plastic safe, non flammable electronic contact and circuit board cleaner. Dries fast, leaves no residue. No harsh fumes or odors.



362-16

CATALOG NO.	DESCRIPTION	UOM	ORDER MULTIPLE
362-16	CBC II Contact Cleaner – 10 oz. Aerosol	EA	12

Sweat-Free Pipe Insulation Spray

An aerosol spray on insulation specifically developed for cold water pipes, refrigeration and air conditioning lines. Stops sweating and dripping problems. Dries to a clean, white, flexible and water resistant coating. Adheres to galvanized, black iron, steel, brass, copper and PVC piping.



770-15

CATALOG NO.	DESCRIPTION	UOM	ORDER MULTIPLE
770-15	Sweat-Free Pipe Insulation – 15 oz. Aerosol	EA	12

Glass Cleaner

A foaming premium glass cleaner that powers through the toughest grease and grime on any glass or hard surface. Leaves a streak-free shine.



325-12

CATALOG NO.	DESCRIPTION	UOM	ORDER MULTIPLE
325-12	Glass Cleaner – 19 oz. Aerosol	EA	12

BATTERIES BY RAYOVAC®

Rayovac is the Industrial Product Leader! Rayovac is the leader in the industrial battery market and has been for years, with an estimated 50% share of the traditional industrial distribution channel. Rayovac introduced the top-selling industrial flashlight to the market, and set the quality standard by which all other industrial flashlights are measured today. Whether your customer is searching for a toolbox-tough flashlight or high-performance batteries, Rayovac offers a broad range of products to meet your needs.

Rayovac Industrial Maximum Alkaline Batteries – Shrink Packed

- Same battery performance as the Contractor Packs at a lower cost
- Formulated specifically to exceed the everyday demands of industrial applications
- Outstanding dependability for “must work” applications



CATALOG NO.	DESCRIPTION	UOM	ORDER MULTIPLE
7-ALAA	Alkaline AA Battery – Shrink Packed, pack of 8	EA	8
7-ALAAA	Alkaline AAA Battery – Shrink Packed, pack of 8	EA	8
7-ALC	Alkaline C Battery – Shrink Packed, pack of 6	EA	6
7-ALD	Alkaline D Battery – Shrink Packed, pack of 6	EA	6
7-AL9V	Alkaline 9V Battery – Shrink Packed, pack of 6	EA	6

Rayovac Lantern Batteries

- Dependable performance — for “must work” applications
- Available in General Purpose, Heavy Duty, and Alkaline Maximum



CATALOG NO.	DESCRIPTION	UOM	ORDER MULTIPLE
7-806	6 Volt Alkaline Maximum – Spring Terminals, pack of 6	EA	6
7-918	6 Volt General Purpose – Screw Terminals, pack of 6	EA	6
7-944	6 Volt Lantern Battery, pack of 6	EA	6

Rayovac Industrial Maximum Alkaline Batteries — Contractor Packs

- Contractor preferred, clear, re-sealable package
- Greater battery per pack quantities command higher battery sales
- Displays much more readily than other competitive batteries
- In an HVAC test market, the Contractor Packs outsold the standard packs by a greater than 2 to 1 ratio!

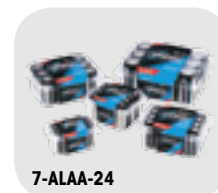

CATALOG NO.	DESCRIPTION	UOM	ORDER MULTIPLE
7-ALAA-24	Alkaline AA Battery – Contractor Pack, pack of 24	EA	24
7-ALAAA-18	Alkaline AAA Battery – Contractor Pack, pack of 18	EA	18
7-ALC-12	Alkaline C Battery – Contractor Pack, pack of 12	EA	12
7-ALD-12	Alkaline D Battery – Contractor Pack, pack of 12	EA	12
7-AL9V-8	Alkaline 9V Battery – Contractor Pack, pack of 8	EA	8

CARTON SEALING TAPE AND DISPENSER

Carton Sealing Tape

This Clear 2.4 mil Sealing Tape is 2in. nominal width and is 110 yds. in length



CATALOG NO.	DESCRIPTION	UOM	ORDER MULTIPLE
540-2110C	Carton Sealing Tape – 2” x 110 Yards – Clear	EA	36

Carton Tape Dispenser

A Heavy Duty Tape Dispenser that holds 2in. Tape.



CATALOG NO.	DESCRIPTION	UOM	ORDER MULTIPLE
540-DISP	2” Carton Tape Dispenser	EA	1

CONTACT CLEANERS

HF™ Contact Cleaner

A petroleum distillate based precision cleaner with a flash point of 205°F. It can be an alternative to CFCs when applications require higher flashpoints.



CATALOG NO.	DESCRIPTION	UOM	ORDER MULTIPLE
CRC-4-140	HF™ Contact Cleaner – 11 oz.	EA	12

QD® Contact Cleaner

This contact cleaner is suitable for cleaning sensitive electronics and electrical equipment and does not leave any residue. It evaporates quickly and is safe to use on all plastics. This product is more useful where lower flashpoint cleaners are acceptable. The QD® Contact Cleaner is NSF K2 Registered.



CATALOG NO.	DESCRIPTION	UOM	ORDER MULTIPLE
CRC-4CF	QD® Contact Cleaner – 11 oz.	EA	12

CONTACT CLEANERS cont'd

Electronic Degreaser

This Advanced Technology Formula is non-chlorinated, non-conductive, non-corrosive and non-staining. It rapidly dissolves grease, oil and sludge for better efficiency of mechanical equipment. The Electronic Degreaser has no flash or fire point.



CATALOG NO.	DESCRIPTION	UOM	ORDER MULTIPLE
CRC-4NU	Electronic Degreaser – 15 oz.	EA	12

DEGREASERS

Heavy Duty Degreaser

This degreaser rapidly and effectively removes grease, oil, tar, and other residue to increase operating efficiency of equipment. It has no flash or fire point, making it an excellent alternative to 1,1,1-based cleaners. Please use caution on plastics.



CATALOG NO.	DESCRIPTION	UOM	ORDER MULTIPLE
CRC-7X	Heavy Duty Degreaser – 19 oz.	EA	12

Heavy Duty Degreaser II

The Heavy Duty Degreaser II is a non-chlorinated, zero VOC formula for cleaning where chlorinated solvents are prohibited. It has a high flashpoint of 180°F. This degreaser effectively removes soils with no residue build-up. Please exercise caution on plastics.



CATALOG NO.	DESCRIPTION	UOM	ORDER MULTIPLE
CRC-7-140	Heavy Duty Degreaser II – 15 oz.	EA	12

Chlor-Free® Degreaser

Non-chlorinated degreasing solvent which is used to remove oil, grease and other contaminants. It is especially useful for applications requiring a quick turnaround and where a low flashpoint solvent can be used.



CATALOG NO.	DESCRIPTION	UOM	ORDER MULTIPLE
CRC-7Z	Chlor-Free® Degreaser – 14 oz.	EA	12

Citrus Degreaser

The Citrus Degreaser has a new Low VOC Formula. The product removes grease, oil and lubricants with no water wash-off. It evaporates quickly and leaves no residue. The product gives off a pleasant citrus scent and is NSF C1 Registered.



CATALOG NO.	DESCRIPTION	UOM	ORDER MULTIPLE
CRC-7PS	Citrus Degreaser – 15 oz.	EA	12

DROP CLOTHS

Canvas Drop Cloths

Premium grade canvas drop cloths are made of first quality and full piece 100% cotton duck canvas fabric. The industrial grade canvas fabric is durable since it is tightly woven using virgin cotton yarn. The drop cloths are washable and reusable. Double stitched seams with heavy-duty rot resistant thread.



CATALOG NO.	DESCRIPTION	UOM	ORDER MULTIPLE
DC-4128	Canvas Drop Cloth - 4' x 12'	EA	1
DC-9128	Canvas Drop Cloth - 9' x 12'	EA	1

HAND CLEANERS

Fast Orange® Hand Cleaner

Three out of five people prefer Fast Orange® over other hand cleaners. The first biodegradable, waterless hand cleaner with aloe, lanolin, and jojoba. Smooth lotion and extra-fine pumice available. USDA Approved.



CATALOG NO.	DESCRIPTION	UOM	ORDER MULTIPLE
HCO-7	Fast Orange® – 7-1/2 fl. oz. Smooth Squeeze Bottle	EA	12
HCO-15	Fast Orange® – 15 oz. Smooth Squeeze Bottle	EA	12
HCO-128	Fast Orange® – 1 Gallon Smooth with Dispenser	EA	4
HCP-7	Fast Orange® – 7-1/2 fl. oz. Pumice Squeeze Bottle	EA	12
HCP-15	Fast Orange® – 15 oz. Pumice Squeeze Bottle	EA	12

Kimberly-Clark Waterless Hand Wipes

These wipes go wherever hands go to get dirty. Full sized 12" x 12" wipes for full sized cleaning. Natural cleaning agent is tough on grease, grime, ink, and paint. Dual textured – smooth for wiping on one side and tough for scrubbing on the other. More wipes with our 75 count bucket.



CATALOG NO.	DESCRIPTION	UOM	ORDER MULTIPLE
5-42272	Kimberly-Clark Waterless Hand Wipes – Bucket	EA	1

INDUSTRIAL TOWELS

WypAll Plus

Absorbs grease, oil, water and solvents from floors, hands, parts, tools and machinery. Tough enough for extra heavy jobs. Comes in a convenient pop-up box of 100 towels.



5-05790

CATALOG NO.	DESCRIPTION	UOM	ORDER MULTIPLE
5-05790	WypAll Plus Towels—White, pack of 100	PK	1

Kimtex® Towels

Long lasting Kimtex® stands up to oils, chemicals and solvents better than ordinary shop towels. Cloth-like feel and performance. Towel size is 9-3/4" x 16-3/4". 100 towels/box. 5 boxes/case.

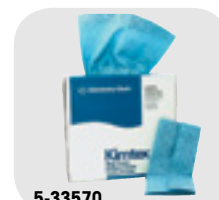

5-33570

CATALOG NO.	DESCRIPTION	UOM	ORDER MULTIPLE
5-33570	Kimtex Shop Towels, pack of 100	PK	1

Teri® Towels

The Teri® reinforced towels feature multi-ply tissue reinforced with nylon webbing for added strength on the job. Made from 100% recycled paper. Towel size is 9-3/4" x 16-3/4". Towel color is white. Comes in a convenient pop up box. 126 towels/box. 10 boxes/case.



5-34790

CATALOG NO.	DESCRIPTION	UOM	ORDER MULTIPLE
5-34790	Teri Reinforced Towels, pack of 126	PK	1

WypAll ShopPro X80 Towels

Like a rental shop towel, only more consistent. Engineered to feel like cloth and work even better. Absorbs more oil and water faster pound for pound than laundered shop towels. The ShopPro X80 is simply the heaviest duty towel in the Kimberly Clark line. 160 towels/box.



5-41041

CATALOG NO.	DESCRIPTION	UOM	ORDER MULTIPLE
5-41041	WypAll ShopPro X80 Towels, pack of 160	PK	1

Workhorse® Manufactured Rags

The economical alternative to scrap rags. Workhorse® Manufactured Rags is the first product to be made from Kimberly-Clark's advanced new material – Hydroknit®. Durable, rag tough construction stands up to any task. Can be re-used time and time again. Available in white or blue.



5-41455

CATALOG NO.	DESCRIPTION	UOM	ORDER MULTIPLE
5-41455	9-3/4" x 16-3/4" White, pack of 100	PK	1
5-41411	9-3/4" x 16-3/4" Blue, pack of 100	PK	1

Terry Towels

100% cotton. Minimum of 14" x 17". Pre-washed for absorbency, fully-hemmed, all-white, and reusable.



DTT-10

CATALOG NO.	DESCRIPTION	UOM	ORDER MULTIPLE
DTT-10	Terry Towels, pack of 10	PK	1
DTT-24	Terry Towels, pack of 24	PK	8

Shop Towels

Heavy duty reusable towels. For wipe ups of grease, oil, water, etc. 100% cotton material is pre-shrunk and hemmed. Each towel measures 13" x 16".



ST-10

CATALOG NO.	DESCRIPTION	UOM	ORDER MULTIPLE
ST-4	Shop Towels, pack of 4	PK	1
ST-10	Shop Towels, pack of 10	PK	1
ST-24	Shop Towels, pack of 24	PK	1

LUBRICANTS

Knock'er Loose® Penetrating Solvent

An industrial strength, low viscosity penetrant designed to rapidly loosen and free seized, bound or frozen fasteners. This product also quickly permeates rust, scale, gum, grease and corrosion. Independent tests reveal that it outperforms its competition.



CRC-1KB

CATALOG NO.	DESCRIPTION	UOM	ORDER MULTIPLE
CRC-1KB	Knock'er Loose® Penetrating Solvent – 13 oz.	EA	12

Screwloose® Industrial Penetrating Oil

A no compromise penetrant that attacks corrosion to free corroded fasteners and mechanical components. A super fast, powerful, concentrated penetrating solvent that loosens rust scale and corrosion and instantly penetrates minute and tightly fitted crevices.



CRC-8

CATALOG NO.	DESCRIPTION	UOM	ORDER MULTIPLE
CRC-8	Screwloose® Industrial Penetrating Oil – 11 oz.	EA	12

LUBRICANTS cont'd

White Lithium Grease

White Lithium Grease has superior lubrication and durability in any weather or temperature. It is useful as a break in lubricant for bearings or as a general purpose lubricant and corrosion inhibitor for tools, machinery and equipment.



CRC-9

CATALOG NO.	DESCRIPTION	UOM	ORDER MULTIPLE
CRC-9	White Lithium Grease – 10 oz.	EA	12

Ultra Lite 3-36® Ultra Thin Non Staining Lubricant

Ultra thin, non staining lubricant that resists oil, dirt and dust build up. This lubricant also seals out moisture and protects against corrosion. It is excellent for drying out electrical components.



CRC-1

CATALOG NO.	DESCRIPTION	UOM	ORDER MULTIPLE
CRC-1	Ultra Lite 3-36® Ultra Thin Non Staining Lubricant – 11 oz.	EA	12

3-36® Multi-Purpose Lubricant & Corrosion Inhibitor

A multi-purpose petroleum based compound that forms a clear, thin film that lubricates and protects against wear and corrosion. The product also displaces moisture and cleans.



CRC-2

CATALOG NO.	DESCRIPTION	UOM	ORDER MULTIPLE
CRC-2	3-36® Multi-Purpose Lubricant & Corrosion Inhibitor – 11 oz.	EA	12

SP-400™ Corrosion Inhibitor

Long-term corrosion inhibitor that protects equipment subject to heat, humidity, chemicals or severely corrosive atmospheres. This product is best to use on machined surfaces and assemblies subjected to long periods of storage.



CRC-3

CATALOG NO.	DESCRIPTION	UOM	ORDER MULTIPLE
CRC-3	SP-400™ Corrosion Inhibitor – 10 oz.	EA	12

Zinc-It® Instant Cold Galvanize™ Zinc Rich Galvanize Coating

High-performance zinc coating that electrochemically bonds with ferrous metals to form a galvanic cell. The product also fights rust and corrosion and can be used as a touch-up for damaged galvanized coatings. Zinc-It® Instant Cold Galvanize™ Zinc Rich Galvanize Coating dries quickly.



CRC-5

CATALOG NO.	DESCRIPTION	UOM	ORDER MULTIPLE
CRC-5	Zinc-It® Instant Cold Galvanize™ Zinc Rich Galvanize Coating – 13 oz.	EA	12
CRC-5BC	Bright Zinc-It® Instant Cold Galvanize™ Coating – 13 oz.	EA	12

Sta-Plex™ Extreme Pressure Premium Red Grease

A superior multi-purpose certified lithium complex based grease which contains extreme pressure, anti-wear, and anti-oxidation additives. The product is very useful in high temperature and performance applications. The drop point is 500°F.



CRC-13

CATALOG NO.	DESCRIPTION	UOM	ORDER MULTIPLE
CRC-13	Sta-Plex™ Extreme Pressure Premium Red Grease – 14 oz.	EA	10

WD-40®

Loosens rusted parts. Stops squeaks. Removes tar, grease and adhesives. Displaces moisture. Protects metal. New Smart Straw can.



741-001

CATALOG NO.	DESCRIPTION	UOM	ORDER MULTIPLE
741-001	WD-40 – 8 oz.	EA	12
741-002	WD-40 – 11 oz.	EA	12
741-003	WD-40, 14.4oz with E-Z Reach	EA	12

Heavy Duty Silicone Mold Release

This product provides maximum releases and is useful in difficult to remove parts. The Heavy Duty Silicone Mold Release is colorless, odorless, non-staining and non-corrosive.



CRC-6

CATALOG NO.	DESCRIPTION	UOM	ORDER MULTIPLE
CRC-6	Heavy Duty Silicone Mold Release – 12 oz.	EA	12

Cutting Oil

Cutting Oil is a superior thread cutting lubricant for use on all types of metals, including brass, copper and aluminum. For use on ferrous and non-ferrous metals. Clings to vertical surfaces for improved performance.



CRC-CF2

CATALOG NO.	DESCRIPTION	UOM	ORDER MULTIPLE
CRC-CF2	Cutting Oil - 16 oz. aerosol	EA	1

Pull-A-Spout Oiler

All purpose oiler with a 14in. telescoping spout. Zooms out for long shots, and in for short shots, even zooms around corners. Squeeze bottle action. Perfect lubricant for general industrial use. Contains four ounces of finest quality carbon free, rust and oxidation inhibited lubricating oil. Plastic container won't short out around electrical connections. No leakage.



CO-1

CATALOG NO.	DESCRIPTION	UOM	ORDER MULTIPLE
CO-1	Pull-A-Spout Oiler – 4 oz. – (Display)	EA	12
CR-1	Lubricant, Rust Breaker – 4 oz.	EA	12

MARKERS

Valve Action Marker

Large ink supply for increased mileage. Fast drying, smear and water resistant. Utilizes a patented valve-activated ink feed mechanism to supply ink as required, down to the last drop.



CATALOG NO.	DESCRIPTION	UOM	ORDER MULTIPLE
540-799	Valve Action Marker-Regular Tip – Red	EA	12
540-800	Valve Action Marker-Regular Tip – Black	EA	12

Felt Tip Markers

Sharpie® King-Sized Permanent Marker for metal, glass, paper and plastic. Durable metal body.



CATALOG NO.	DESCRIPTION	UOM	ORDER MULTIPLE
540-811B	Sharpie® King-Sized Marker	EA	12

Valve Action Paint Marker

Bright, crisp, opaque colors. The oil-based paint is quick drying and permanent on most surfaces. These markers also feature the patented valve-operated feed mechanism and a medium point.



CATALOG NO.	DESCRIPTION	UOM	ORDER MULTIPLE
540-805	Valve Action Paint Marker – Black	EA	12
540-806	Valve Action Paint Marker – Red	EA	12
540-807	Valve Action Paint Marker – White	EA	12
540-808	Valve Action Paint Marker – Yellow	EA	12

PAINTS AND PRIMERS

General Purpose Spray Paint

New, more complete line of professional quality fast drying spray paints. Color code compressors or refrigerant recovery cylinders to match standard refrigerant identifying colors. Touch up equipment housings. Product meets most recent VOC legislation and is currently compliant.



CATALOG NO.	DESCRIPTION	UOM	ORDER MULTIPLE
799-001	Spray Paint – Gloss Black – 12 oz.	EA	6
799-002	Spray Paint – Flat Black – 12 oz.	EA	6
799-003	Spray Paint – Gloss White – 12 oz.	EA	6
799-004	Spray Paint – Flat White – 12 oz.	EA	6
799-005	Spray Paint – Dark Machinery Gray – 12 oz.	EA	6
799-006	Spray Paint – Gray Primer – 12 oz.	EA	6
799-009	Spray Paint – Astro Blue – 12 oz.	EA	6
799-010	Spray Paint – Orange – 12 oz.	EA	6
799-011	Spray Paint – Aluminum (Silver) – 12 oz.	EA	6
799-012	Spray Paint – Zinc Rich Primer – 14 oz.	EA	6
799-013	Spray Paint – Bright Red – 12 oz.	EA	6

Industrial Enamel

Finally an aerosol paint that sprays in any direction without clogging. We guarantee it! Dries tack free in 10 to 20 minutes; fully dry in just one hour. Excellent corrosion and solvent resistance. Resists heat up to 250°F. Now in 20 oz. cans. Product meets most recent VOC legislation and is currently compliant.



CATALOG NO.	DESCRIPTION	UOM	ORDER MULTIPLE
799-021	Industrial Enamel – Flat Black – 12 oz.	EA	6
799-022	Industrial Enamel – Gloss White – 12 oz.	EA	6
799-024	Industrial Enamel – Machinery Light Gray – 12 oz.	EA	6
799-025	Industrial Enamel – Aluminum – 12 oz.	EA	6

High Heat Spray Paint

An ultra high temperature coating formulated to resist temperatures up to 1300°F. Great for use on boilers, furnaces, steam pipes, chimney collars, compressors and engine manifolds. Product meets most recent VOC legislation and is currently compliant.



CATALOG NO.	DESCRIPTION	UOM	ORDER MULTIPLE
799-040	High Heat Spray Paint – Aluminum – 12 oz.	EA	6
799-041	High Heat Spray Paint – Black – 12 oz.	EA	6

SAFETY SUPPLIES, DEVICES

Latex Gloves

Disposable natural latex rubber which provide a natural feel and grip. Powdered.



23010

CATALOG NO.	DESCRIPTION	UOM	ORDER MULTIPLE
23010	Latex Gloves, pack of 50 pairs	PK	1

Nitrile Gloves

Foam control gloves for industrial use that provide a high level of wet and dry grip. Standard in applications where tactile sensitivity is required.



540-1005L

CATALOG NO.	DESCRIPTION	UOM	ORDER MULTIPLE
540-1005L	Nitrile Gloves - Large, 1 pair per pack	EA	1

Heavy Duty Work Gloves

Your choice of durable work gloves. Washable, breathable, and durable for everyday use.



540-HU1L

CATALOG NO.	DESCRIPTION	UOM	ORDER MULTIPLE
540-HU1L	Heavy Utility Gloves - Large, 1 pair per pack	EA	1
540-BH1L	Box Handler Gloves - Large, 1 pair per pack	EA	1
540-LG1M	Leather Gloves - Medium, 1 pair per pack	EA	1

Dust Masks

Extremely lightweight, disposable, nuisance dust mask for non-toxic particles. Metal noseclips to fit individual facial contours.



5-500

CATALOG NO.	DESCRIPTION	UOM	ORDER MULTIPLE
5-500	Dust Masks, pack of 50	PK	1

Leather Work Gloves

Versatile leather work gloves ideal for many industrial jobs. These leather work gloves offer: wing thumb pattern, continuous pull patch, seamless full leather index finger, leather knuckle strap, leather finger tips with elastic gather on back. Generously sized for a good working fit.

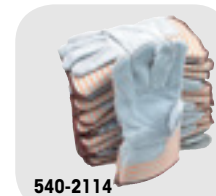

540-2114

CATALOG NO.	DESCRIPTION	UOM	ORDER MULTIPLE
540-2114	Leather Glove w/Safety Cuff, 1 pair per pack	EA	12
540-2200	Renegade® Performance Glove w/Kevlar Thread, 1 pair per pack	EA	1

First Aid Kits

10 and 25-unit first aid kits packaged in economy plastic boxes to assist when industrial accidents occur.



FAK-25

CATALOG NO.	DESCRIPTION	UOM	ORDER MULTIPLE
FAK-10	10-Unit First Aid Kit	EA	1
FAK-25	25-Unit First Aid Kit	EA	1

Shoe Covers

Slip these shoe covers on in seconds to protect carpet, tile, or wood from dirt and scuff marks. Customers will appreciate your professional appearance.



SC-1

CATALOG NO.	DESCRIPTION	UOM	ORDER MULTIPLE
SC-1	Navy Blue Shoe Covers, pack of 50 pairs	PK	1
SC-1WP	Waterproof Shoe Covers, pack of 50 pairs	PK	1
SC-1SHU	Dark Blue Shoe Covers, pack of 50 pairs	PK	1

SEALANT, EPOXY, GLUE

Thread Sealant with PTFE

General purpose sealant with the lubricity of PTFE for metal pipes. Won't shred like PTFE Tape. Allows easy disassembly. Resists common shop fluids. 60° to 400°F temp. resistance. Pressure resistance of 5000 PSI.



CATALOG NO.	DESCRIPTION	UOM	ORDER MULTIPLE
7-80632	Thread Sealant – 1/4 Pint Brush Can	EA	12
7-80633	Thread Sealant – 1 Pint Brush Can., 12 per pack	EA	12

Super Glue

This adhesive can be used on dirty, greasy surfaces and the medium viscosity penetrates into preassembled and close fitting parts. It can be used on aluminum, metal, rubber, and most plastics for most tough jobs.



CATALOG NO.	DESCRIPTION	UOM	ORDER MULTIPLE
DEP052	Super Glue – 2 Gram Tube	EA	12

J-B Weld

The world's finest cold-weld compound for use when welding or soldering is out of the question due to cost, down time for repairs, or technical or environmental considerations. A remarkably easy, convenient, and inexpensive alternative to welding, soldering, and brazing. Literally pennies per use.



CATALOG NO.	DESCRIPTION	UOM	ORDER MULTIPLE
JB8265	J-B Weld 2 Part Epoxy	EA	6

Wagner Adhesive Sealant

For refrigerant sealing. Eliminates fastener loosening, leakage, and corrosion. Cures between thread flanks to seal against leakage and prevents thread corrosion. Offers sealing with maximum solvent resistance to the action of refrigerant (11, 12 and 22), ammonia and sulfur dioxide. Withstands corrosive liquids used in metal finishings and process industries. Ideal sealant for refrigeration, A/C, and process equipment using corrosive chemicals.



CATALOG NO.	DESCRIPTION	UOM	ORDER MULTIPLE
CAS-2712	Wagner Adhesive Sealant – 0.34 fl. oz.	EA	12

Fast Cure Epoxy

An easy-to-use, two part putty you simply mix and mold like clay. No complicated weighing or measuring required. Easy 1:1 cut-what-you-need mix ratio. Form it into any shape. It hardens in one hour and makes a final, steel-hard cure in 12 hours and can be sanded, drilled, machined, sawed and painted. Use on metal, wood, brick, stone, concrete, fiberglass, porcelain, tile and most plastics. Cures under water. 1.0 lb.

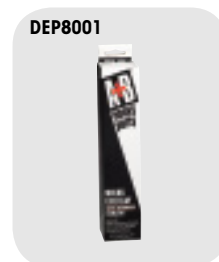

CATALOG NO.	DESCRIPTION	UOM	ORDER MULTIPLE
DEP8001	Gray Epoxy Putty – 1 lb. Kit	EA	24
DEP8002	White Epoxy Putty – 1 lb. Kit	EA	24

SEALING COMPOUNDS, ADHESIVE

Flexi-Patch™

Flexi-Patch™ is an easy to use flexible repair patch ideal for repairing almost any surface. It cures quickly using only UV light from sunlight or a UV flashlight for a long lasting, permanent repair. Flexi-Patch is a fiberglass-reinforced polyester ideal for use on PVC, plastics, metal, wood, concrete and more. It's the easy way to permanently patch almost any surface. It dries hard for permanent repair. Can be drilled, tapped and painted once dry.



CATALOG NO.	DESCRIPTION	UOM	ORDER MULTIPLE
FP-36	Flexi-Patch fiberglass patch	EA	20

Foam Sealant – One Component

One component closed-cell expanding polyurethane foam sealant for lineal caulking applications. Air-moisture cure. Tack free in 20 minutes; fully cured in 12 hours. Paintable. Use for insulating and sealing around windows, doors, pipes, ducts and vents. Non-toxic when cured. Paint to protect from UV exposure. "R" value 4.7 (1" thickness). Foam contains fire retarding chemical and is U.L. Listed but not rated as a firestop product. Environmental concerns have led us to replace CFC's and HCFC's with hydrocarbon material in our one component foam products. See instructions on each product to ensure safe use and quality results.



CATALOG NO.	DESCRIPTION	UOM	ORDER MULTIPLE
01714	Foam Sealant – 12 oz. Can – Yields 275' (3/8" bead)	EA	12
01724	Foam Sealant – 20 oz. Can – Yields 460' (3/8" bead)	EA	12

SEALING COMPOUNDS, ADHESIVE cont'd

Foam Sealant – Two Component

Two component closed-cell expanding polyurethane foam sealant for cavity filling, surface coating and insulation applications. Rapid chemical cure (Component A and Component B). Tack free in 2 minutes, fully cured in 20 minutes. Use for insulation repairs in refrigerated enclosures. Spray coat and insulate tanks, pipes, tubs and panels. Non-toxic when cured. Paint to protect from UV exposure. "R" value 5 (1" thickness). Kits include dispensing nozzles, hose and flow control mechanism. Foam contains fire retarding chemicals and is U.L. Listed but is not rated as a firestop product.



CATALOG NO.	DESCRIPTION	UOM	ORDER MULTIPLE
10012	Foam – 2 Kit – 15 bd. ft. Kit – Yields 1 cu. ft.	EA	12

Firestop Products for Class A Buildings

U.L. Classified. Code Approved. Seal penetrations of plumbing, refrigeration and AC lines, ducts, vents and electrical cable through fire-rated floors, walls and ceilings. Easy-to-use, non-shrinking, non-toxic and permanently flexible. Blocks fire, gas, smoke, air and water migration. Use ceramic fiber filler together with putty or caulk for thick penetrations. Technical bulletins available.



CATALOG NO.	DESCRIPTION	UOM	ORDER MULTIPLE
16491	Firestop Caulk – Red – 10.3 fl. oz. cartridge	EA	12

Caulk Gun

Caulk guns can be used to hold the sealant to seal duct work.



CATALOG NO.	DESCRIPTION	UOM	ORDER MULTIPLE
7-100	Caulk Gun – Super Ratchet Type	EA	12
7-200	Caulk Gun – Standard Duty	EA	1

High Temp Red Silicone Sealant

A one part non-slumping paste that cures to a tough, rubbery solid at room temperature. Formulated to perform at temperatures ranging from -85°F to 500°F for continuous operation, and to 600°F for intermittent exposure. Tack free cure time – 15 minutes. Full cure time – 24 hours.



CATALOG NO.	DESCRIPTION	UOM	ORDER MULTIPLE
7-4300	High Temp Red Silicone Sealant – 10.1 oz. Cartridge	EA	12

Geocel Caulking Sealant

Exceptional bonding and sealing caulk for interior and exterior applications involving seams, joints, ductwork, flashing and any similar use. Excellent adhesion to virtually any surface (metals, fiberglass, wood, concrete, brick and most plastics) even if moisture is present. Resealable, paintable, flexible. Will not crack, chip or peel. Specially formulated for the HVACR industry. Not available in California.



CATALOG NO.	DESCRIPTION	UOM	ORDER MULTIPLE
18001	Clear Geocel Sealant – 10.3 oz. Cartridge	EA	24
18002	White Geocel Sealant – 10.3 oz. Cartridge	EA	24
18003	Aluminum/Gray Geocel Sealant – 10.3 oz. Cartridge	EA	24

DiversiGum Sealing Compound

Non-hardening. For plugging openings through foundations or around refrigeration tube entry.



CATALOG NO.	DESCRIPTION	UOM	ORDER MULTIPLE
6-202-1	DiversiGum Sealing Compound – 1 lb. Slug	EA	24
6-202-2	DiversiGum Sealing Compound – 2 lb. Slug	EA	20
AG-25	DiversiGum Sealing Compound – 3/8" x 25' Caulking Cord	EA	12

Silicone Sealant

Food grade 100% RTV Silicone Sealant. Can be used in applications for continuous use to 450°F. UV and water resistant. Long-term flexibility. Non-paintable. Available in 10.3 fl. oz. tube for use in standard caulk gun or in 3 fl. oz. squeeze tube.

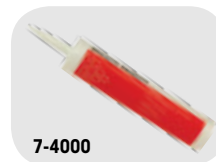

CATALOG NO.	DESCRIPTION	UOM	ORDER MULTIPLE
7-4000	Clear Silicone Sealant – 10.3 fl. oz. Tube	EA	12
7-4001	Clear Silicone Sealant – 3 fl. oz. Squeeze Tube	EA	48
7-4100	White Silicone Sealant – 10.3 fl. oz. Tube	EA	12
7-4101	White Silicone Sealant – 3 fl. oz. Squeeze Tube	EA	48
7-4200	Aluminum Silicone Sealant – 10.3 fl. oz. Tube	EA	12
7-80045	Pipe Joint Compound – 6 fl. oz. Tube	EA	12

SEALING COMPOUNDS, ADHESIVE cont'd

25 Year Acrylic Latex Painter's Caulk

For both interior and exterior use. DiversiTech's 25 Year Acrylic Latex Painter's Caulk forms a tough, paintable resilient bond to all building material surfaces. Excellent resistance to water, weathering and moisture vapor.



CATALOG NO.	DESCRIPTION	UOM	ORDER MULTIPLE
7-4500	White Acrylic Latex Caulk – 10.1 oz. Cartridge	EA	12
7-4400	Clear Acrylic Latex Caulk – 10.1 oz. Cartridge	EA	12

Pro-Air Industrial Grade Spray Adhesive

A clear, pressure sensitive aerosol adhesive with exceptional tack and shear strength characteristics. An excellent choice for most permanent adhesive applications: duct liner and wrap, sheet aluminum, fiberglass insulation board, and much more. The aerosol package offers a specially designed web spray pattern for even, controlled distribution. Flammability meets aerosol flame extension test requirements. Coverage is approximately 90-100 square feet per pound.



CATALOG NO.	DESCRIPTION	UOM	ORDER MULTIPLE
GP1-40BL	Pro-Air Spray Adhesive – 38 lb. Disposable Cylinder	EA	1
GN-23H	Spray Gun	EA	1

Pro-Air Duct Sealant – UL 181 AM-BM Listed

Water-based fiber-reinforced duct sealant/mastic formulated for indoor/outdoor use. Meets U.L. Class 1 rating and local codes while featuring long term flexibility and strength. Use on metal heating, ventilating, and A/C duct systems; as well as fiberglass duct board systems and flex duct systems. Recommended for use to 10" of water column pressure without the need for fiberglass mesh reinforcement.



CATALOG NO.	DESCRIPTION	UOM	ORDER MULTIPLE
800-008	Pro-Air Duct Sealant – 1/10 Gallon Tube – 10.5 oz.	EA	12
800-009	Pro-Air Duct Sealant – 1 Gallon Pail	EA	4

Black Jack® Roof Cement

Black Jack® All-Weather Roof Cement is an asphalt based patching compound designed to repair cracks, splits, seams and holes in roofing materials. It also works great in new construction and in setting flashings, drip edges and roofing material edges.

- Use in wet or dry conditions
- Seals flashings, and other roof projections
- Fiber reinforced
- Thick trowel grade



CATALOG NO.	DESCRIPTION	UOM	ORDER MULTIPLE
RM-1G	Black Jack All Weather Roof Cement – 1 gallon	EA	6
RM-10	Black Jack All Weather Roof Cement – 10 oz. tube	EA	12

SHEET METAL SCREWS

Sheet Metal Screw Assortment Kit

The 7 most popular sizes in one multi-compartmented, resealable, plastic container. Perfect for the toolbox. Contains:

- 7 x 1/2 Taper Point – 175 pieces
- 8 x 1/2 Drill Point – 100 pieces
- 8 x 1 Taper Point – 50 pieces
- 8 x 2 Taper Point – 40 pieces
- 8 x 1/2 Taper Point – 175 pieces
- 8 x 3/4 Taper Point – 60 pieces
- 8 x 1-1/2 Taper Point – 50 pieces
- 1/4" Nut Setter – 1 each



CATALOG NO.	DESCRIPTION	UOM	ORDER MULTIPLE
5-SCR-AK	Sheet Metal Screw Assortment Pack	EA	1

Masonry Bit

This bit is suitable for brick, tile, slate, cement, and cinder block. This bit is a nice addition to the toolbox.



CATALOG NO.	DESCRIPTION	UOM	ORDER MULTIPLE
540-DB6	Masonry Bit – 3/16" x 6"	EA	1

Masonry Screw

This product comes in a pack of 250 and is suitable for brick, tile, slate, cement, and cinder block. The screws are a nice addition to the toolbox.

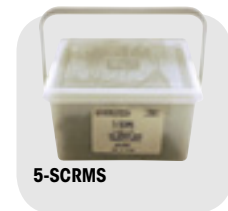

CATALOG NO.	DESCRIPTION	UOM	ORDER MULTIPLE
5-SCRMS	Masonry Screw – 1/4" x 1-1/4", pack of 250	PK	1

Anchor Kit

Plastic anchor kit for sheet rock applications. Kit includes 100 anchors, screws and 1 masonry bit.



CATALOG NO.	DESCRIPTION	UOM	ORDER MULTIPLE
540-AK100	Anchor size 1/4 x 1, Screw Size 10 x 1-1/4 HWH Head Size 5/16 hex	EA	1

SHEET METAL SCREWS cont'd

**Sheet Metal Screws
– Taper Point**

Hex washer slotted head. Burr-free. Full 1/4" head will not strip out of hex driver opening. Heat treated tapered point will not break or "walk". Packaged in resealable plastic cartons.

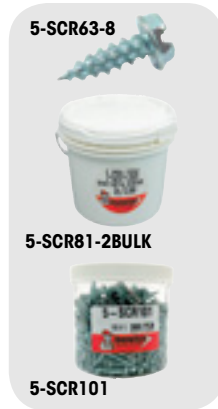

**Sheet Metal Screws
– Drill Point**

Self-drilling, self-tapping. Hex washer head. Produces the optimum hole size, resulting in a tighter fit. Made from special heat treated steel for extra strength. Packaged in resealable plastic cartons.



CATALOG NO.	DESCRIPTION	UOM	ORDER MULTIPLE
5-SCR63-8	6 x 3/8 Taper Point, pack of 1,000	PK	1
5-SCR63-8BULK	6 x 3/8 Taper Point – Bulk, pack of 20,000	PK	1
5-SCR71-2	7 x 1/2 Taper Point, pack of 1,000	PK	1
5-SCR71-2BULK	7 x 1/2 Taper Point – Bulk, pack of 15,000	PK	1
5-SCR81-2	8 x 1/2 Taper Point, pack of 1,000	PK	1
5-SCR81-25M	8 x 1/2 Taper Point, pack of 5,000	PK	1
5-SCR81-2BULK	8 x 1/2 Taper Point – Bulk, pack of 12,000	PK	1
5-SCR83-4	8 x 3/4 Taper Point, pack of 1,000	PK	1
5-SCR83-4BULK	8 x 3/4 Taper Point – Bulk, pack of 10,000	PK	1
5-SCR81	8 x 1 Taper Point, pack of 500	PK	1
5-SCR81BULK	8 x 1 Taper Point – Bulk, pack of 7,500	PK	1
5-SCR81-12-100	8 x 1-1/2 Taper Point, pack of 100	PK	1
5-SCR81-12W	8 x 1-1/2 Taper Point w/White Head, pack of 250	PK	1
5-SCR81-12WTBUL	8 x 1-1/2 Taper Point w/White Head – Bulk, pack of 5,000	PK	1
5-SCR81-12BULK	8 x 1-1/2 Taper Point – Bulk, pack of 5,000	PK	1
5-SCR82-100	8 x 2 Taper Point, pack of 100	PK	1
5-SCR82	8 x 2 Taper Point, pack of 350	PK	1
5-SCR82W	8 x 2 Taper Point w/White Head, pack of 250	PK	1
5-SCR82BULK	8 x 2 Taper Point – Bulk, pack of 3,000	PK	1
5-SCR101-2BULK	10 x 1/2 Taper Point – Bulk, pack of 14,000	PK	1
5-SCR103-4	10 x 3/4 Taper Point, pack of 1,000	PK	1
5-SCR103-4BULK	10 x 3/4 Taper Point – Bulk, pack of 10,000	PK	1
5-SCR101	10 x 1 Taper Point, pack of 500	PK	1
5-SCR101BULK	10 x 1 Taper Point – Bulk, pack of 7,000	PK	1

CATALOG NO.	DESCRIPTION	HEAD SIZE	UOM	ORDER MULTIPLE
5-SCR61-2DP	6 x 1/2 Drill Point, pack of 1,000	1/4"	PK	1
5-SCR61-2DPBULK	6 x 1/2 Drill Point – Bulk, pack of 15,000	1/4"	PK	1
5-SCR81-2DP	8 x 1/2 Drill Point, pack of 1,000	1/4"	PK	1
5-SCR81-2DPBULK	8 x 1/2 Drill Point – Bulk, pack of 10,000	1/4"	PK	1
5-SCR83-4DP	8 x 3/4 Drill Point, pack of 500	1/4"	PK	1
5-SCR83-4DPBULK	8 x 3/4 Drill Point – Bulk, pack of 10,000	1/4"	PK	1
5-SCR81DP	8 x 1 Drill Point, pack of 500	1/4"	PK	1
5-SCR81DPBULK	8 x 1 Drill Point – Bulk, pack of 7,500	1/4"	PK	1
5-SCR101-2DP	10 x 1/2 Drill Point, pack of 500	5/16"	PK	1
5-SCR101-2DPBULK	10 x 1/2 Drill Point – Bulk, pack of 10,000	5/16"	PK	1
5-SCR103-4DP	10 x 3/4 Drill Point, pack of 500	5/16"	PK	1
5-SCR103-4DPBULK	10 x 3/4 Drill Point – Bulk, pack of 5,000	5/16"	PK	1
5-SCR101DP	10 x 1 Drill Point, pack of 500	5/16"	PK	1
5-SCR101DPBULK	10 x 1 Drill Point – Bulk, pack of 5,000	5/16"	PK	1
5-SCR101-12DP	10 x 1-1/2 Drill Point, pack of 250	5/16"	PK	1
5-SCR101-12DPBULK	10 x 1-1/2 Drill Point – Bulk, pack of 3,500	5/16"	PK	1
5-SCR102DP	10 x 2 Drill Point, pack of 350	5/16"	PK	1
5-SCR102DPBULK	10 x 2 Drill Point – Bulk, pack of 2,500	5/16"	PK	1

WASP, HORNET, AND YELLOW JACKET KILLERS

Sting Less Wasp & Hornet Killer

Kills wasps, hornets and yellow jackets. Very fast-acting when insects are hit directly. Allow approximately 24 hours for those that were not directly hit. This container delivers a 20-foot jet blast to knock down the insects and allow for the user to remain at a safe distance.



CATALOG NO.	DESCRIPTION	UOM	ORDER MULTIPLE
436-20	Sting Less Wasp & Hornet Spray – 14 oz. Aerosol	EA	12

Wasp & Hornet Killer by ENFORCER

Enforcer's Wasp & Hornet Killer shoots a 20-foot jet blast for instant knockdown of wasps, hornets, and yellow jackets. Enforcer's Wasp & Yellow Jacket Foam is a 20-foot blast of blanketing foam that plugs yellow jacket holes and clings to wasp and hornet nests, preventing their escape.



CATALOG NO.	DESCRIPTION	UOM	ORDER MULTIPLE
8-WH16	Enforcer Wasp & Hornet Killer – 16 oz. Aerosol	EA	12
8-FWH16	Enforcer Wasp & Yellow Jacket Foam – 16 oz. Aerosol	EA	12



Anchors.....	108-109
Boxes, Rings, and Covers.....	110-111
Bulbs	111
Cable Connectors	112
Cable Ties and Accessories	113
Conduit Fittings	114
General Tools.....	115
High Temperature Solderless Terminals	106
Nuts and Bolts.....	115-116
Plastic Anchor Kits	109
Power Cords and Work Lights	117
Screws	117
Slip-On Solderless Terminals	102-103
Special Purpose Solderless Terminals	103-104
Specialty Fasteners.....	118
Specialty Fittings	119
Standard Solderless Terminals.....	104-105
Storage Containers	119
Tapes	119
Terminal Kits	107
Testers, Leads, Clips, Fuses	120
Wire.....	120-121
Wiring Devices	121-126

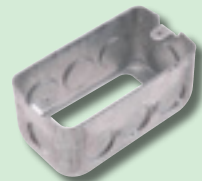

How to sell DEVCO products

DEVCO merchandising displays are an easy and attractive way to showcase a variety of DEVCO products in your store. Offered in three different versions, each display rack includes everything you need to create extra sales for your business.

Easy to Display

DEVCO provides turnkey merchandising solutions for wholesale distribution. Attractive, easy to set-up merchandising displays provide a great way to highlight DEVCO products and make it easy for customers to find what they need. The point of sale display merchandises the products, enabling the distributor to add additional sales.

The products merchandised on the carousel are impulse buy items. The items are packed so they cost the contractor only a few dollars, and most are less than \$10 each.

Easy to Profit

DEVCO displays provide a typical distributor branch with easy add-on sales that build profits. Each display can generate significant sales and margins for the store while providing contractors with the parts they need to finish the job. These self-service displays are a great way to increase revenue with minimal effort.

The Perfect Plan

Each DEVCO Merchandising display comes with a complete plan-o-gram to make merchandising it simple and fast. And there are three different versions available so you can choose the display that's right for your business and customers.

And when you purchase the DEVCO products to fill it up, the merchandising rack is **loaned free of charge.**

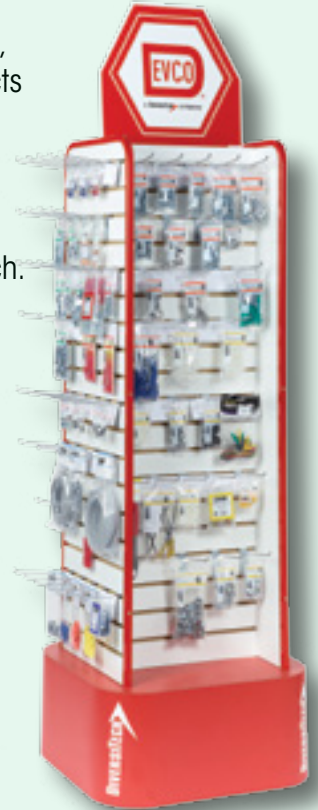

Display Rack	Featured Products
EZC	Solderless terminals, ground connectors, fasteners, anchor kits, cable ties, washers, hex nuts, cable clamps, sheet metal screws and hose clamps
Electrical	Ground adaptors, outlets, boxes, bushings, cable connectors, extension rings, indicator lights, plugs and connectors, receptacles, reducing washers, toggle switches and hook up wire
Combo	Solderless terminals, insulated rings, ground adaptors, covers, reducing washers, plugs and connectors, hook up wire, fasteners, hex nuts and self drilling screws



PLAN-O-GRAM FOR DEVCO ELEC RACK (MKT-POP-DEVELEC)

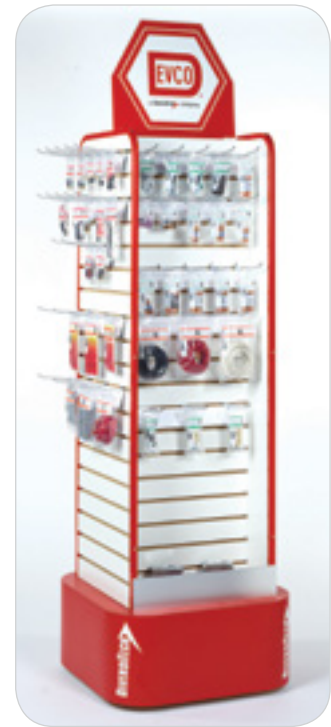
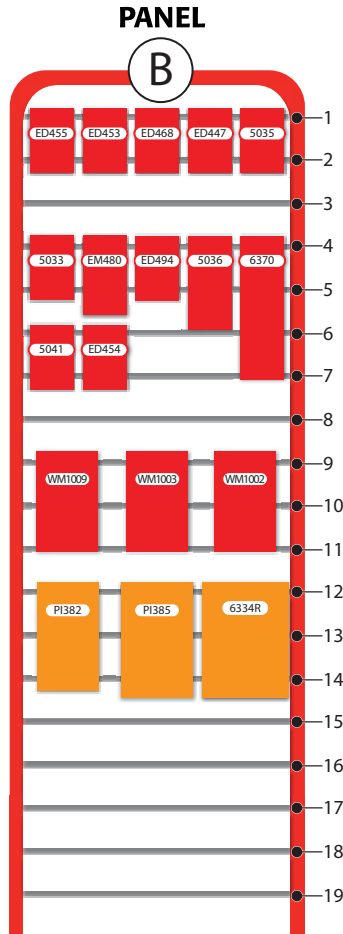
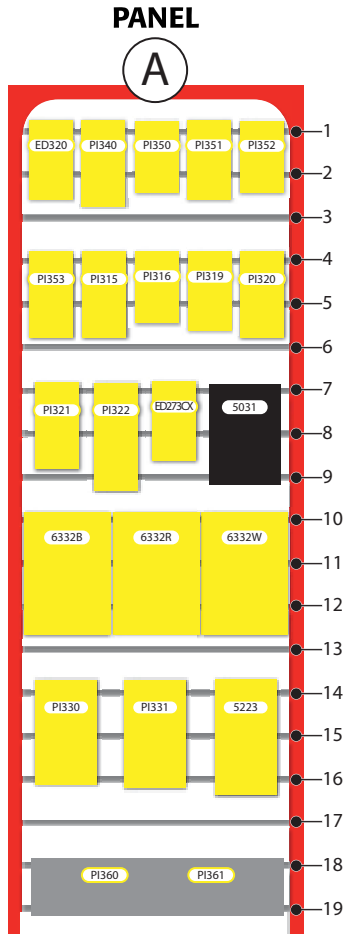

MKT-POP-DEVELEC

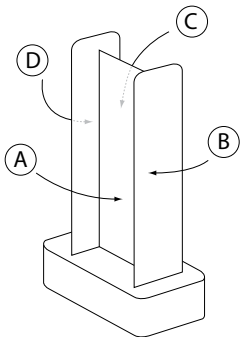
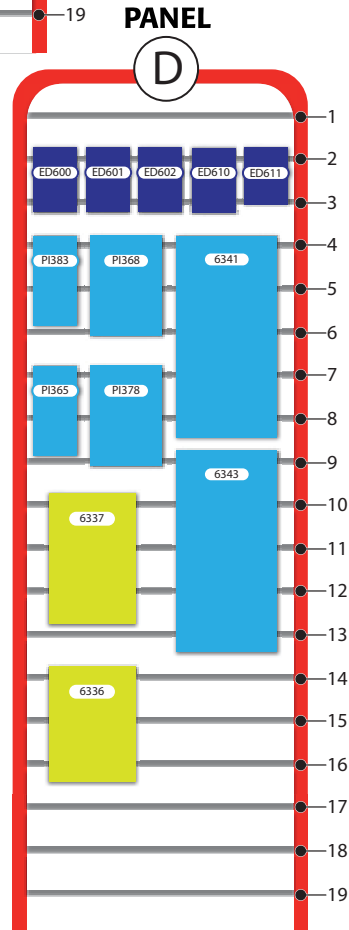
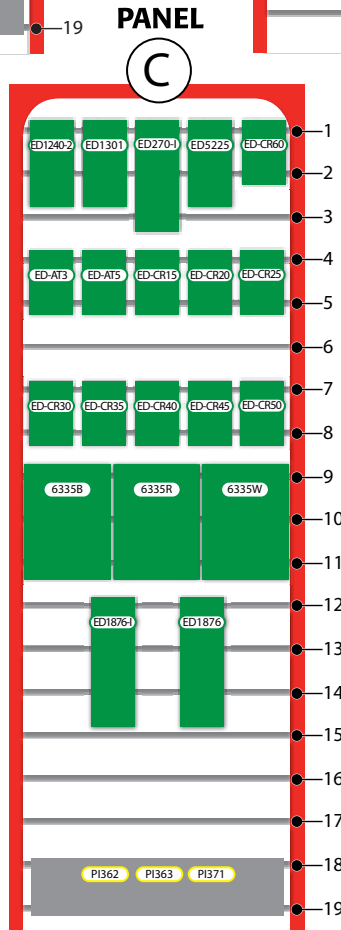

MKT-POP-DEVELEC
Merchandising Rack
72" x 22" x 20.5"

NOTE: Item numbers in RED indicate Made in the U.S.A.



PLAN-O-GRAM FOR DEVCO EZC RACK (MKT-POP-DEVEZC)

DEVCO

PANEL A

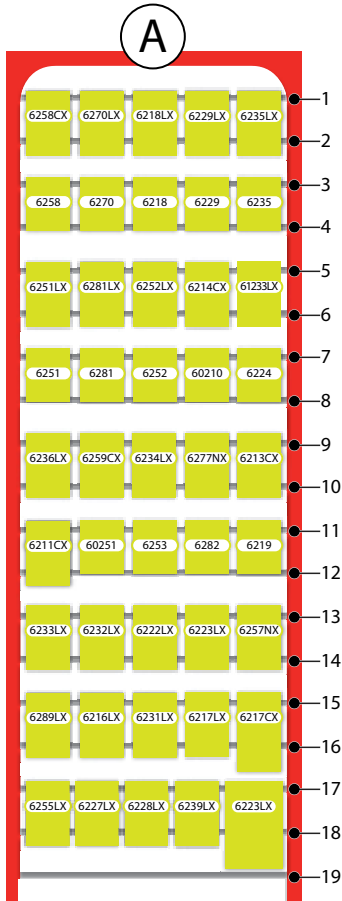

PANEL B

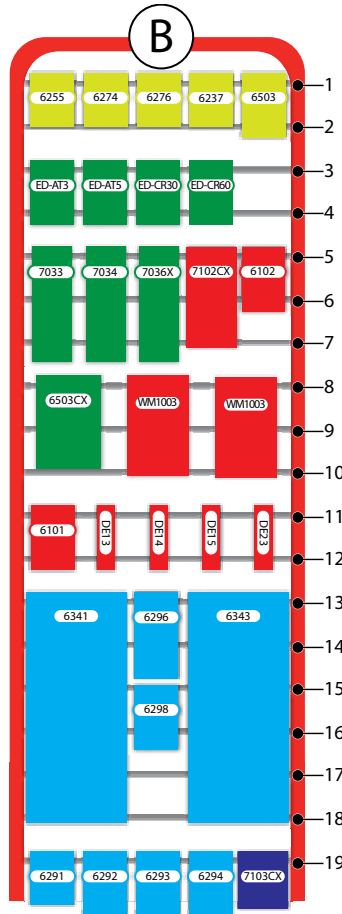

MKT-POP-DEVEZC

PANEL C

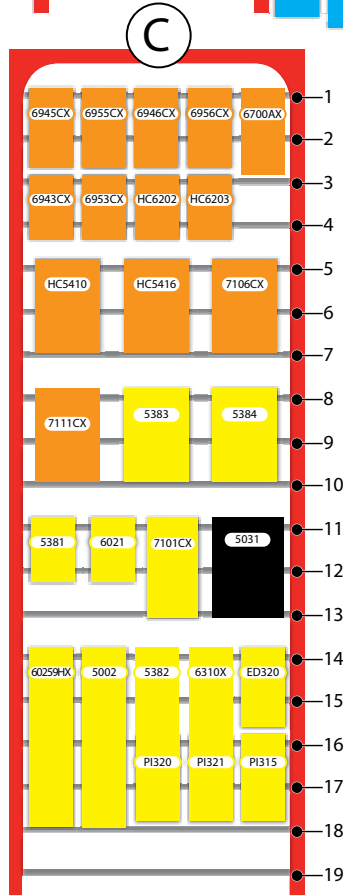

PANEL D

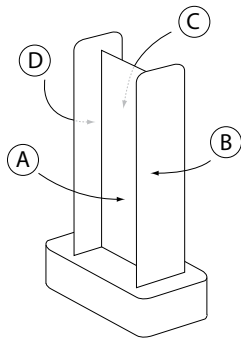
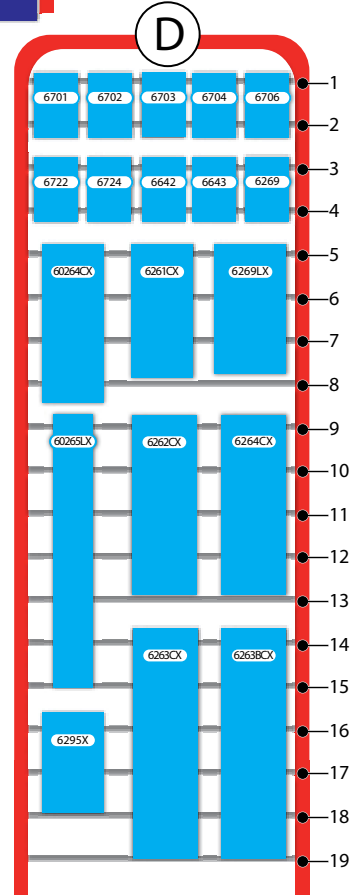

MKT-POP-DEVEZC
Merchandising Rack
72" x 22" x 20.5"



PLAN-O-GRAM FOR DEVCO COMBO RACK (MKT-POP-DEVCOMBO)

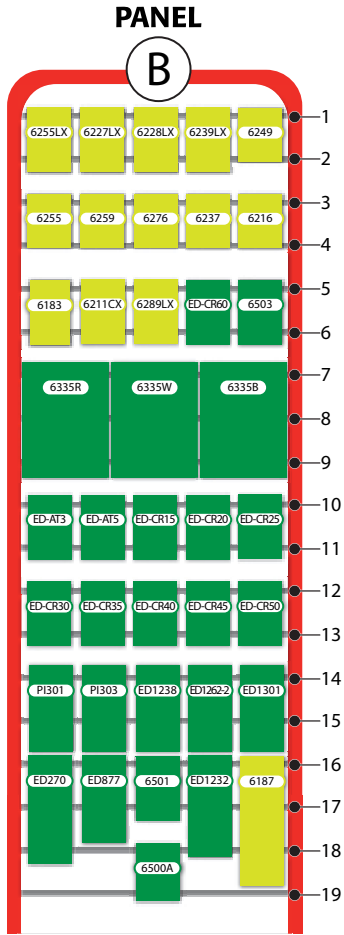
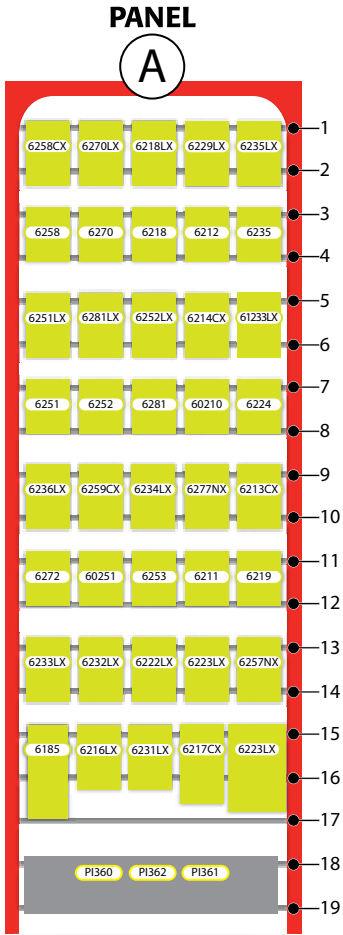

MKT-POP-DEVCOMBO

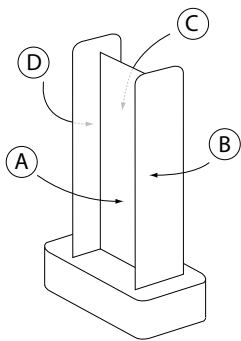
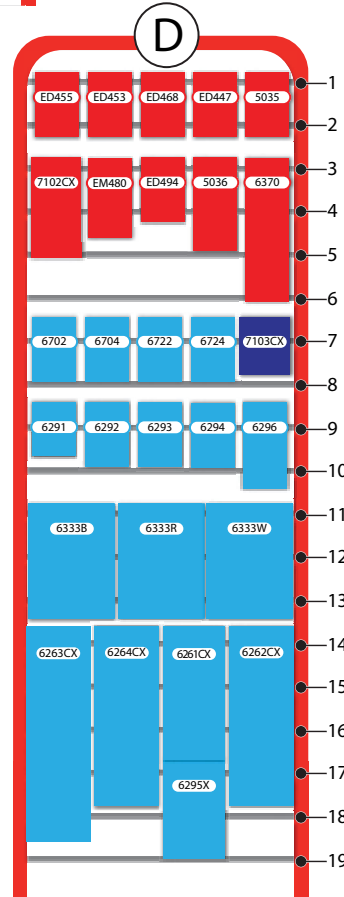

MKT-POP-DEVCOMBO Merchandising Rack 72" x 22" x 20.5"



DEVCO RACKS MASTER ITEM LIST (BY RACK)

This DEVCO product list includes any DEVCO item that is part of the plan-o-gram display for either the EZC, ELEC or COMBO versions of the DEVCO rack. This cross reference indicates on which display rack each item should be placed.

ITEM #	ITEM DESCRIPTION	ELEC	EZC	COMBO	ITEM #	ITEM DESCRIPTION	ELEC	EZC	COMBO
5002	Crimp Tool w/ Cutter & Stripper Ins.		X	X	6703	Flat Washer 5/16in Uss zn Pltd.		X	
5031	Test Leads (ins. Alligator clips) Low Voltage 22in 8pcs	X	X		6704	Flat Washer 3/8in Uss zn Pltd.		X	X
5033	Alligator Clips (steel) 2in long for probes .075in-.08in	X			6706	Flat Washer 1/2in Uss zn Pltd.		X	
5035	Alligator Clips (copper) B&R Ins 2in long	X		X	6722	Fender Washer 1/4in zn Pltd.		X	X
5036	Test Clip (steel 20A) B&R Insulators 2-7/16in long	X		X	6724	Fender Washer 3/8in zn Pltd.		X	X
5041	Test Leads Low Voltage Hook Ty22ga 36in red & black	X			7033	Toggle Bolt w/wing 3/16inx4inzn Pltd.		X	
5223	Triple Outlet 2 Pole 3 Wire 15A-125V Polarized plastic	X			7034	Toggle Bolt w/wing 1/4inx4in zn Pltd.		X	
5381	Nylon Cable Clamp 1/8in I.D.		X		60210	Tab Ad. Ins. .250 16-14 multi stack male & female		X	X
5382	Nylon Cable Clamp 1/4in I.D.		X	X	60251	Slip-On F 12-10 Non-Ins. .250		X	X
5383	Nylon Cable Clamp 3/8in I.D.		X		60259HX	Comp. Lead Kit 12in 10ga wire		X	X
5384	Nylon Cable Clamp 1/2in I.D.		X	X	60264CX	Cable Tie 6in w/ #8 Hole 30# 1-3/8in B. Dia nat 100/PK		X	
6021	Rnd Head Screw (#6 8 10-32 x 1/2in 1-1/2in) zn Pltd.		X		60265LX	Cable Tie 14in 50# 4in B. Dia natural 50 pcs		X	
6101	Motor Shaft Keys (1/8in 3/16in 1/4in 3/16in x 1/4in) zn Pltd.		X		61233LX	Slip-on M & F 16-14 .250 Full Ins Nylon 50 pcs		X	X
6102	Motor Shaft Keys (1/4insq 5/16insq 3/8insq) zn Pltd.		X		6211CX	Tab Ad. S. F Dbl M Non-Ins. 100 pcs		X	X
6183	Terminal Block 20A-250V 6 pos			X	6213CX	Flag F QD 16-14 Non-Ins. .250 100 pcs		X	X
6185	Terminal Block 20A-250V 10 pos			X	6214CX	Slip-on F 16-14 Non-Ins. .250 100 pcs		X	X
6187	Terminal Block 20A-250V 14 pos			X	6216LX	Ring 16-14 Ins. #10 Stud 50 pcs		X	X
6211	Tab Ad. S. F Dbl M .250 Non-Ins.			X	6217CX	Butt Conn. 16-14 Ins. 100 pcs		X	X
6212	Dbl. M. Tab Ad. . S. F . Non-Ins.			X	6217LX	Butt Conn. 16-14 Ins. 50 pcs		X	X
6216	Ring 16-14 Ins. #10 Stud			X	6218LX	Slip-on F 16-14 Ins. .250 50 pcs		X	X
6218	Slip-on F 16-14 Ins. .250		X	X	6222LX	Dead End Conn. 22-14 Fully Ins. 50 pcs		X	X
6219	Slip-on M 16-14 Ins. .250		X	X	6223LX	Dead End Conn. 18-10 Fully Ins. 50 pcs		X	X
6224	Flag F QD 12-10 Non-Ins. .250		X	X	6227LX	Spade 16-14 Ins. #8 Stud		X	X
6229	Slip-on F 16-14 Full Ins. .250		X		6228LX	Spade 16-14 Ins. #10 Stud 50 pcs		X	X
6235	Slip-on F 22-18 Ins. .250		X	X	6229LX	Slip-on F 16-14 Full Ins. .250		X	X
6237	Spade 22-18 Ins. #8 Stud		X	X	6231LX	Butt Conn. 12-10 Ins. 50 pcs		X	X
6249	M Tab 1 pair bent 90 Non-Ins.			X	6232LX	Butt Conn. 22-18 Ins. 50 pcs		X	X
6251	Slip-on F 12-10 Ins. .250		X	X	6233LX	Slip-on F 16-14 .250 Full Ins. Nylon 50 pcs		X	X
6252	Ring 12-10 Ins. #10 Stud		X	X	6234LX	Slip-on M 16-14 .250 Full Ins. Nylon 50 pcs		X	X
6253	Ring 12-10 Ins. 1/4in Stud		X	X	6235LX	Slip-on F 22-18 Ins. .250 50 pcs		X	X
6255	Spade 12-10 Ins. #10 Stud		X	X	6236LX	Ring 22-18 Ins. #8 Stud 50 pcs		X	X
6258	Comp. Flag F. 16-14 Non-Ins. .250		X	X	6239LX	Spr. Spade 16-14 Ins. #8 Stud		X	X
6259	Comp. Flag F. 12-10 Non-Ins. .250			X	6251LX	Slip-on F 12-10 Ins. .250		X	X
6269	Cable Tie Mount		X		6252LX	Ring 12-10 Ins. #10 Stud		X	X
6270	Comp. Flag F. 12-8 Non-Ins. .250		X	X	6255LX	Spade 12-10 Ins. #10 Stud 50 pcs		X	X
6272	Ring 16-14 Ins. #6 Stud			X	6257NX	Ring #8 Ins. 1/4in Stud 25 pc		X	X
6274	Spade 16-14 Ins. #6 Stud		X		6258CX	Comp. Flag F. 16-14 Non-Ins. .250 100 pcs		X	X
6276	Spr. Spade 16-14 Ins. #6 Stud		X	X	6259CX	Comp. Flag F. 12-10 Non-Ins. .250 100 pcs		X	X
6281	Slip-on F 16-14 Ins. .187		X	X	6261CX	Cable Tie 6in 18# 1-3/8in B. Dia natural 100 pcs		X	X
6282	Slip-on F 22-18 Ins. .187		X		6262CX	Cable Tie 7-1/2in 50# 1-3/4in B. Dia natural 100 pcs		X	X
6291	Wire Connector Mini-Gray		X	X	6263CX	Cable Tie 11in 50# 3in B. Dia natural 100 pcs		X	X
6292	Wire Connector Tiny-Blue		X	X	6263BCX	Cable Tie 11in 50# 3in B. Dia black 100 pcs		X	
6293	Wire Connector Small-Orange		X	X	6264CX	Cable Tie 7in w/ #10 Hole 50# 1-3/4in B. Dia nat 100/PK		X	X
6294	Wire Connector Medium-Yellow		X	X	6269LX	Cable Tie Mount 50 pcs		X	
6296	Wire Connector Large-Red		X	X	6270LX	Comp. Flag F. 12-8 Non-Ins. .250 50 pcs		X	X
6298	Wire Connector XLarge-Gray		X		6277NX	Flag F QD 16-14 .250 Fully Ins. Nylon 25 pcs		X	X
6336	Thermostat Wire 3 Conduct. 40 ft.	X			6281LX	Slip-on F 16-14 Ins. .187 50 pcs		X	X
6337	Thermostat Wire 5 Conduct. 40 ft.	X			6289LX	Bullet Plug & Rec. 16-14 Ins. 50 pcs		X	X
6341	SJTO Service Cord 16 GA 20 ft.	X	X		6295X	Assorted Wire Connectors		X	X
6343	SJTO Service Cord 14 GA 20 ft.	X	X		6310X	Grease Fitting Assortment box		X	
6370	Heat Shrink Tubing Assort. B&W 1/8in & 1/4in supplied 6in	X		X	6332B	Hook-up Wire 16ga blk. 48 ft	X		
6413	Fin. Hex Nut 1/4in-20 zn Pltd.			X	6332R	Hook-up Wire 16ga red. 48 ft	X		
6501	Fin. Hex Nut 1/4in-20 zn Pltd.		X	X	6332W	Hook-up Wire 16ga wht. 48 ft	X		
6503	Fin. Hex Nut 3/8in-16 zn Pltd.		X	X	6333B	Hook-up Wire 14ga blk. 48 ft			X
6642	HH Cap Screw 3/8in-16 x 1in		X		6333G	Hook-up Wire 14ga grn. 48 ft			
6643	HH Cap Screw 3/8in-16 x 1 1/2in		X		6333R	Hook-up Wire 14ga red. 48 ft			X
6701	Flat Washer 3/16in Uss zn Pltd.		X		6333W	Hook-up Wire 14ga wht. 48 ft			X
6702	Flat Washer 1/4in Uss zn Pltd.		X	X	6334B	Hook-up Wire 12ga blk. 48 ft			X

continued



DEVCO RACKS MASTER ITEM LIST (BY RACK) cont'd

ITEM #	ITEM DESCRIPTION	ELEC	EZC	COMBO
6334R	Hook-up Wire 12ga red 48 ft	X		X
6334W	Hook-up Wire 12ga wht. 48 ft			X
6335B	Hook-up Wire 10ga blk. 48 ft	X		X
6335R	Hook-up Wire 10ga red 48 ft	X		X
6335W	Hook-up Wire 10ga wht. 48 ft	X		X
6500A	Asst Mach. Screw Hex Nuts 6-32 8-32 10-32 zn Pltd.			X
6503CX	Fin. Hex Nut 3/8in-16 zn Pltd. 100 pcs		X	
6700AX	Flat Washer Assortment Pack 3/16 1/4 5/16 3/8 1/2 5/8 inch		X	
6943CX	Self Drilling Screw #8x1/2in 1/4in Hex Head zn Pltd. 100/PK		X	X
6945CX	Self Drilling Screw #8x3/4in 1/4in Hex Head zn Pltd. 100/PK		X	X
6946CX	Self Drilling Screw #8x1in 1/4in Hex Head zn Pltd. 100/PK		X	X
6953CX	Drill Tip Screw #10x1/2in 5/16in Hex Head 100/PK		X	X
6955CX	Drill Tip Screw #10x3/4in 5/16in Hex Head 100/PK		X	X
6956CX	Self Drilling Screw #10x1in 5/16in Hex Head zn Pltd. 100/PK		X	X
7036X	Toggle Bolt w/wing 3/8inx4in zn Pltd.		X	
7101CX	Anch Kit Yellow #8x1in w 3/16in bit 100 s + 100 a		X	X
7102CX	Anch Kit Red #10x1-1/4in w 1/4in bit 100 s + 100 a		X	X
7103CX	Anch Kit Blue #4x3/4in w 5/32in bit 100 s + 100 a		X	X
7106CX	Plug Anchor Kit Green #10x1in 1/4in bit 100 s +100 a bag		X	
7111CX	Plug Anchor Kit Blue #14x1in w 5/16in bit 100 s +100 a bag		X	
DE13	Magnetic Hex Chuck 1/4in x 1-3/4in		X	
DE14	Magnetic Hex Chuck 5/16in x 1-3/4in		X	
DE15	Magnetic Hex Chuck 3/8in x 1-7/8 in		X	
DE23	Magnetic Hex Chuck 1/4in x 2-9/16 in		X	
ED1232	Toggle Switch D.P. 30A-120/277V brown			X
ED1238	Toggle Switch S.P. 20A-120/277V brown			X
ED1240-2	Toggle Switch S.P. 15A-120/277V brown	X		
ED1262-2	Toggle Switch D.P. 15A-120/277V brown			X
ED1301	Toggle Switch S.P. 15A-120V brown	X		X
ED1876	Single Receptacle 20A-250V 2 pl. 3 wr. brown	X		
ED1876-I	Single Receptacle 20A-250V 2 pl. 3 wr. ivory	X		
ED270	Duplex Receptacle 15A-125V 2 pl. 3 wr. brown			X
ED270-I	Duplex Receptacle 15A-125V 2 pl. 3 wr. ivory	X		
ED273CX	Electrical Staple insul size #5 5/8in x 1/4in 100/PK	X		X
ED2867	Armored Plug 15A-125V 2pl. 3 wr. vinyl enclosed			X
ED2887	Armored Connector 15A-125V 2pl. 3 wr. vinyl enclosed			X
ED320	Vinyl Grommet Asst. contains: ED300 thru ED316	X	X	X
ED447	Bat Handle Switch metal SPST on-off 10A/277V-20A/125V AC	X		X
ED453	Bat Handle Switch metal DPDT on-on 10A/277V-20A/125V AC	X		X
ED454	Bat Handle Switch metal SPDT on-on 10A/277V-20A/125V AC	X		
ED455	Bat Handle Switch metal DPST on-off 10A/277V-20A/125V AC	X		X
ED468	Bat Handle Switch metal SPDT on-off-on 10A/277V-20A/125V	X		X
ED494	Bat Handle Switch metal DPDT on-off-on 10A/277V-20A/125V	X		X
ED5225	Switch & Receptacle 2p 3w (sw:15A-120VAC& rec:15A-125VAC) brn	X		
ED600	Indicator Light 28V red PC lens incandescent bulb	X		
ED601	Indicator Light 28V green PC lens incandescent bulb	X		
ED602	Indicator Light 28V amber PC lens incandescent bulb	X		
ED610	Indicator Light 105-125V AC red nylon lens neon bulb	X		
ED611	Indicator Light 105-125V AC gm PC lensneon blb-G2B Imp&resstr	X		
ED877	Duplex Receptacle 20A-125V 2 pl. 3 wr. brown			X
EM480	In-Line Fuse Holder 1-1/4 x 1/4in fuses to 20A/32V 14ga	X		X
ED-AT3	Blade Fuses - 3 Amp - Purple, Pack of 10	X	X	X
ED-AT5	Blade Fuses - 5 Amp - Tan, Pack of 10	X	X	X
ED-CR15	Dual Element Fuses - 15 Amp, Pack of 2	X		X
ED-CR20	Dual Element Fuses - 20 Amp, Pack of 2	X		X
ED-CR25	Dual Element Fuses - 25 Amp, Pack of 2	X		X
ED-CR30	Dual Element Fuses - 30 Amp, Pack of 2	X	X	X
ED-CR35	Dual Element Fuses - 35 Amp, Pack of 2	X		X
ED-CR40	Dual Element Fuses - 40 Amp, Pack of 2	X		X
ED-CR45	Dual Element Fuses - 45 Amp, Pack of 2	X		X

ITEM #	ITEM DESCRIPTION	ELEC	EZC	COMBO
ED-CR50	Dual Element Fuses - 50 Amp, Pack of 2	X		X
ED-CR60	Dual Element Fuses - 60 Amp, Pack of 2	X	X	X
HC5410	Hose Clamp 9/16in-1-1/8in SSHousing&band st hex screw		X	X
HC5416	Hose Clamp 3/4in-1-1/2in SSHousing&band st hex screw		X	
HC6202	Hose Clamp 1/4in-5/8in SS housing&band st hex screw		X	X
HC6203	Hose Clamp 5/16in-7/8in SSHousing&band st hex screw		X	X
PI301	Cond Nip 1/2in offset zn w pltd. stl locknuts insul. bushings			X
PI303	Cond Nip 1/2in strt galv steel w pltd. stl lock insul.			X
PI310	Reduc. Wash 3/4in to 1/2in Rsd Fin Galv St			X
PI312	BX Conct set screw 3/8in Tr. 1/2in KO. zn die cast			X
PI315	BX Connector 90 3/8inTr. 1/2in KO zn die cast	X	X	X
PI316	Knockout Seal for 1/2in KO zn Pltd. steel	X		
PI319	Romex Connector 3/4in Tr. 3/4in KO. zn Pltd. die cast	X		
PI320	Romex Connector 3/8in Tr. 1/2in KO. zn Pltd. die cast 25/PK	X	X	X
PI321	Romex Connector 3/8in Tr. 1/2 in KO. zn Pltd. die cast	X	X	X
PI322	BX Conct str sqze 3/8in Tr. 1/2in KO. zn die cast	X		
PI328	Split Bolt Connector Cu use (6 max sol & 7 max strmd)			X
PI330	Romex Stop plastic 3/8inx1/2in for 2 cond. romex 12/2-14/2	X		
PI331	Plastic in Anti-Shortin Bush 14/2 14/3 & 12/2 BX cable	X		
PI340	Combo Cable Connector for romex & BX 3/8in Tr. 1/2in KO	X		
PI350	Metal LT Conn straight 1/2in Tr. 1/2in K.O	X		
PI351	Metal LT Conn straight 3/4in Tr. 3/4in K.O.	X		
PI352	Liquid Tight Connector 90 1/2in Tr. 1/2in K.O. zn die cast	X		
PI353	Liquid Tight Connector 90 3/4in Tr. 3/4in K.O. zn die cast	X		
PI360	Box galv. steel 4in x 2-1/8inx 1-7/8in 1/2in KO 13 in ³	X		X
PI361	Box galv. steel 4in x 2-1/8inx 2-1/8in 1/2in KO 14.5 in ³	X		X
PI362	1900 Box galv. steel 4X4X1-1/2 1/2&3/4 KO 21 in ³	X		X
PI363	1900 Box galv. steel 4X4X2-1/8in 1/2&3/4 KO 30.3 in ³	X		X
PI365	Utility Cover Toggle Switch 2-11/32in x 4-1/4in Pltd. steel	X		
PI368	1900 Cover Sw/Dup Rec cad fin. steel 4in x 4in raisd 1/2in	X		X
PI371	1900 Cover Blank Flat galv. steel	X		X
PI378	1900 Cover Duplex Recep cadil fin. steel 4X4 raisd 1/2in	X		
PI381	Fuse Outlet & Switch w cover 1/2HP-125V AC galv. steel			X
PI382	Weatherproof Cover Blank Al 1 Gang w gasket anodized	X		
PI385	Wthrprf Box AL2-3/4inx4-1/2inx23 1/2in holes 2 plugs 19in ³	X		
WM1002	Cable Marker Book alpha numer	X		
WM1003	Cable Marker Book numeric contains 10 each: 1 - 45	X	X	
WM1009	Cable Marker Book line & term	X		



SLIP-ON SOLDERLESS TERMINALS

Insulated Male Slip-Ons

These male terminals crimp to the wires which relieves the need to solder. A variety of sizes are available and the slip ons are fully insulated in either vinyl or nylon.



CATALOG NO.	DESCRIPTION	WIRE RANGE	TAB SIZE	UOM	ORDER MULTIPLE
60219	Insulated Male Slip-On, pack of 23	22-18	.250	PK	1
60220	Insulated Male Slip-On, pack of 23	16-14	.187	PK	1
60220LX	Insulated Male Slip-On, pack of 50	16-14	.187	PK	1
6219	Insulated Male Slip-On, pack of 22	16-14	.250	PK	1
6219LX	Insulated Male Slip-On, pack of 50	16-14	.250	PK	1
61221LX	Insulated Male Slip-On, pack of 50	12-10	.250	PK	1
61221CX	Insulated Male Slip-On, pack of 100	12-10	.250	PK	1

Insulated Female Slip-Ons

These female terminals crimp to the wires which relieves the need to solder. A variety of sizes are available and the slip ons are fully insulated in either vinyl or nylon.



CATALOG NO.	DESCRIPTION	WIRE RANGE	TAB SIZE	UOM	ORDER MULTIPLE
6282	Insulated Female Slip-On, pack of 22	22-18	.187	PK	1
6282LX	Insulated Female Slip-On, pack of 50	22-18	.187	PK	1
6235	Insulated Female Slip-On, pack of 22	22-18	.250	PK	1
6235LX	Insulated Female Slip-On, pack of 50	22-18	.250	PK	1
6235CX	Insulated Female Slip-On, pack of 100	22-18	.250	PK	1
6281	Insulated Female Slip-On, pack of 22	16-14	.187	PK	1
6281LX	Insulated Female Slip-On, pack of 50	16-14	.187	PK	1
6218	Insulated Female Slip-On, pack of 22	16-14	.250	PK	1
6218LX	Insulated Female Slip-On, pack of 50	16-14	.250	PK	1
6218CX	Insulated Female Slip-On, pack of 100	16-14	.250	PK	1
6251	Insulated Female Slip-On, pack of 17	12-10	.250	PK	1
6251LX	Insulated Female Slip-On, pack of 50	12-10	.250	PK	1
6251CX	Insulated Female Slip-On, pack of 100	12-10	.250	PK	1
61223LX	Insulated Female Slip-On, pack of 50	12-10	.340	PK	1

Fully Insulated Female Slip-Ons

These female terminals crimp to the wires which relieves the need to solder. A variety of sizes are available and the slip ons are fully insulated in either vinyl or nylon. This terminal features insulation grip. This terminal is usually supplied vinyl and has an insulation grip.



CATALOG NO.	DESCRIPTION	WIRE RANGE	TAB SIZE	UOM	ORDER MULTIPLE
6229**	Fully Insulated Female Slip-On, pack of 11	16-14	.250	PK	1
6229LX**	Fully Insulated Female Slip-On, pack of 50	16-14	.250	PK	1
6233	Fully Insulated Female Slip-On, pack of 14	16-14	.250	PK	1
6233LX	Fully Insulated Female Slip-On, pack of 50	16-14	.250	PK	1
6233CX	Fully Insulated Female Slip-On, pack of 100	16-14	.250	PK	1
61234LX	Fully Insulated Female Slip-On, pack of 50	12-10	.250	PK	1

*This terminal features insulation grip.

**This terminal is usually supplied vinyl and has an insulation grip.

Non-Insulated Male Slip-Ons

These non insulated male terminals crimp to the wires which relieves the need to solder. A variety of sizes are available



CATALOG NO.	DESCRIPTION	WIRE RANGE	TAB SIZE	UOM	ORDER MULTIPLE
6220	Non-Insulated Male Slip-On, pack of 38	16-14	.250	PK	1
6220CX	Non-Insulated Male Slip-On, pack of 100	16-14	.250	PK	1
61220	Non-Insulated Male Slip-On, pack of 37	16-14	.250	PK	1

Non-Insulated Female Slip-Ons

These non insulated female terminals crimp to the wires which relieves the need to solder. A variety of sizes are available. This terminal features insulation grip.



CATALOG NO.	DESCRIPTION	WIRE RANGE	TAB SIZE	UOM	ORDER MULTIPLE
6214	Non-Insulated Female Slip-On, pack of 35	16-14	.250	PK	1
6214CX	Non-Insulated Female Slip-On, pack of 100	16-14	.250	PK	1
60251	Non-Insulated Female Slip-On, pack of 26	12-10	.250	PK	1
60251CX	Non-Insulated Female Slip-On, pack of 100	12-10	.250	PK	1

*This terminal features insulation grip.

Fully Insulated Male Slip-Ons

These male terminals crimp to the wires which relieves the need to solder. A variety of sizes are available and the slip ons are fully insulated in either vinyl or nylon.



CATALOG NO.	DESCRIPTION	WIRE RANGE	TAB SIZE	UOM	ORDER MULTIPLE
6234	Fully Insulated Male Slip-On, pack of 14	16-14	.250	PK	1
6234LX	Fully Insulated Male Slip-On, pack of 50	16-14	.250	PK	1
61235LX	Fully Insulated Male Slip-On, pack of 50	12-10	.250	PK	1

Non-Insulated Flag Female Slip-Ons

These non insulated female terminals crimp to the wires which relieves the need to solder. A variety of sizes are available. Part 6213 features insulation grip.



CATALOG NO.	DESCRIPTION	WIRE RANGE	TAB SIZE	UOM	ORDER MULTIPLE
6213	Non-Insulated Flag Female Slip-On, pack of 34	16-14	.250	PK	1
6213CX	Non-Insulated Flag Female Slip-On, pack of 100	16-14	.250	PK	1
6224	Non-Insulated Flag Female Slip-On, pack of 20	12-10	.250	PK	1
6224CX	Non-Insulated Flag Female Slip-On, pack of 100	12-10	.250	PK	1

SLIP-ON SOLDERLESS TERMINALS cont'd

Fully Insulated Flag Female Slip-Ons

These female terminals crimp to the wires which relieves the need to solder. A variety of sizes are available and the slip-ons are fully insulated in either vinyl or nylon.



CATALOG NO.	DESCRIPTION	WIRE RANGE	TAB SIZE	UOM	ORDER MULTIPLE
6277	Fully Insulated Flag Female Slip-On, pack of 9	16-14	.250	PK	1
6277NX	Fully Insulated Flag Female Slip-On, pack of 25	16-14	.250	PK	1

Combination Pack: Set of 6233 and 6234

Our Combination pack holds both a Fully Insulated Male and Female Slip On.



CATALOG NO.	DESCRIPTION	WIRE RANGE	TAB SIZE	UOM	ORDER MULTIPLE
61233LX	Set of Fully Insulated M/F Slip-Ons, pack of 25 pairs	16-14	.250	PK	1

Flag Female Compressor Terminal Kit

Parts 6258, 6271, 6259, 6273, 6270 in a four compartment, clear plastic box. Parts 6270 and 6273 are put in the same compartment.



CATALOG NO.	DESCRIPTION	UOM	ORDER MULTIPLE
6200HX	Flag Female Compressor Terminal Kit	EA	1

Flag Female Compressor Terminals

Also known as hermetic header terminals, these non-insulated terminals are designed with a larger distance between the "rolls" to allow for the rod in hermetic header applications. The increased distance allows the rod to slip in between them. Parts 6258 and 6259 are notched for bending. The notches are cut between the slip-on portion and the conductor barrel and enable the back of the slip-on portion to be folded against the conductor barrel after the wire connection is made. This terminal features insulation grip.



CATALOG NO.	DESCRIPTION	WIRE RANGE	FITS	UOM	ORDER MULTIPLE
6270	Flag Female Compressor Terminal, pack of 9	12-8	.250 tab	PK	1
6270LX	Flag Female Compressor Terminal, pack of 50	12-8	.250 tab	PK	1
6258*	Flag Female Compressor Terminal, pack of 17	16-14	.250 tab	PK	1
6258CX*	Flag Female Compressor Terminal, pack of 100	16-14	.250 tab	PK	1
6259	Flag Female Compressor Terminal, pack of 14	12-10	.250 tab	PK	1
6259CX	Flag Female Compressor Terminal, pack of 100	12-10	.250 tab	PK	1

* This terminal features insulation grip.

Compressor Lead Kit

Our Compressor Lead kit includes the following products: a flag female compressor terminal (.250 tab; part 62589), a waterproof butt connector (12 10 wire range; part 62231), and a piece of 10 gauge wire.



CATALOG NO.	DESCRIPTION	UOM	ORDER MULTIPLE
60259HX	Compressor Lead Kit with 12" wire	EA	1

SPECIAL PURPOSE SOLDERLESS TERMINALS

Insulated Plugs

These insulated terminals crimp to the wires which relieves the need to solder.



CATALOG NO.	DESCRIPTION	WIRE RANGE	UOM	ORDER MULTIPLE
6283	Insulated Plugs, pack of 17	22-18	PK	1
6283LX	Insulated Plugs, pack of 50	22-18	PK	1
6285	Insulated Plugs, pack of 17	16-14	PK	1
6285LX	Insulated Plugs, pack of 50	16-14	PK	1

Combination Packs

These insulated terminals crimp to the wires which relieves the need to solder.



CATALOG NO.	DESCRIPTION	UOM	ORDER MULTIPLE
6288	Combination Pack with parts 6283 and 6284, pack of 7 pairs	PK	1
6288LX	Combination Pack with parts 6283 and 6284, pack of 25 pairs	PK	1
6289	Combination Pack with parts 6285 and 6286, pack of 7 pairs	PK	1
6289LX	Combination Pack with parts 6285 and 6286, pack of 25 pairs	PK	1

Fully Insulated Receptacles

These insulated terminals crimp to the wires which relieves the need to solder.

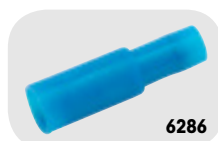

CATALOG NO.	DESCRIPTION	WIRE RANGE	UOM	ORDER MULTIPLE
6286	Fully Insulated Receptacles, pack of 12	16-14	PK	1

**SPECIAL PURPOSE SOLDERLESS TERMINALS cont'd****Tab Adapters – Quick Disconnect with Screw**

These insulated terminals crimp to the wires which relieves the need to solder.



CATALOG NO.	DESCRIPTION	UOM	ORDER MULTIPLE
6209	Fits .250 Tab, #6-32 x 1/4" Screw, pack of 5	PK	1
6209LX	Fits .250 Tab, #6-32 x 1/4" Screw, pack of 50	PK	1

Tab Adapters – Single Female Double Male Tabs

These insulated terminals crimp to the wires which relieves the need to solder. .250 male, .250 female.



CATALOG NO.	DESCRIPTION	TAB SIZE	UOM	ORDER MULTIPLE
6208	Tab Adapter; 1 female, 2 male; Bent 90°, pack of 12	.250	PK	1
6208LX	Tab Adapter; 1 female, 2 male; Bent 90°, pack of 50	.250	PK	1
6211	Tab Adapter; 1 female, 2 male; Wye, pack of 27	.250	PK	1
6211CX	Tab Adapter; 1 female, 2 male; Wye, pack of 100	.250	PK	1
6212	Tab Adapter; 1 female, 2 male; Stacked, pack of 16	.250	PK	1
6212CX	Tab Adapter; 1 female, 2 male; Stacked, pack of 100	.250	PK	1

Tap Connectors

These insulated terminals crimp to the wires which relieves the need to solder. Designed to make tap splices.



CATALOG NO.	DESCRIPTION	WIRE RANGE	UOM	ORDER MULTIPLE
6241	Tap Splice – blue, pack of 15	16-14	PK	1

Tab Adapters – Piggy Back Slip-Ons

These insulated terminals crimp to the wires which relieves the need to solder. Multi-stack, .250 male tab, .250 female slip-on.



CATALOG NO.	DESCRIPTION	WIRE RANGE	UOM	ORDER MULTIPLE
6210	Non-Insulated Piggy Back Slip-Ons, pack of 20	16-14	PK	1
6210LX	Insulated Piggy Back Slip-Ons, pack of 11	16-14	PK	1
6210LX	Insulated Piggy Back Slip-Ons, pack of 50	16-14	PK	1
6210CX	Insulated Piggy Back Slip-Ons, pack of 100	16-14	PK	1

Tab Adapters – Male Tabs

These insulated terminals crimp to the wires which relieves the need to solder.



CATALOG NO.	DESCRIPTION	TAB SIZE	STUD	UOM	ORDER MULTIPLE
6230	Male Tabs – Straight, pack of 28	.250	#8	PK	1
6230CX	Male Tabs – Straight, pack of 100	.250	#8	PK	1

Fully Insulated Dead End Connectors

These insulated terminals crimp to the wires which relieves the need to solder.



CATALOG NO.	DESCRIPTION	WIRE RANGE	UOM	ORDER MULTIPLE
6222	Fully Insulated Dead End Connectors, pack of 27	22-14	PK	1
6222LX	Fully Insulated Dead End Connectors, pack of 50	22-14	PK	1
6223	Fully Insulated Dead End Connectors, pack of 21	18-10	PK	1
6223LX	Fully Insulated Dead End Connectors, pack of 50	18-10	PK	1

STANDARD SOLDERLESS TERMINALS**Insulated Hooks**

These insulated terminals crimp to the wires which relieves the need to solder.



CATALOG NO.	DESCRIPTION	WIRE RANGE	STUD	UOM	ORDER MULTIPLE
6242	Insulated Hooks, pack of 22	22-18	#8	PK	1
6242LX	Insulated Hooks, pack of 50	22-18	#8	PK	1
6244	Insulated Hooks, pack of 20	16-14	#8	PK	1
6244LX	Insulated Hooks, pack of 50	16-14	#8	PK	1

Insulated Butt Connectors

These insulated terminals crimp to the wires which relieves the need to solder.



CATALOG NO.	DESCRIPTION	WIRE RANGE	UOM	ORDER MULTIPLE
6232	Insulated Butt Connector, pack of 26	22-18	PK	1
6232LX	Insulated Butt Connector, pack of 50	22-18	PK	1
6232CX	Insulated Butt Connector, pack of 100	22-18	PK	1
6217	Insulated Butt Connector, pack of 27	16-14	PK	1
6217LX	Insulated Butt Connector, pack of 50	16-14	PK	1
6217CX	Insulated Butt Connector, pack of 100	16-14	PK	1
6231	Insulated Butt Connector, pack of 16	12-10	PK	1
6231LX	Insulated Butt Connector, pack of 50	12-10	PK	1
6231CX	Insulated Butt Connector, pack of 100	12-10	PK	1
6287	Insulated Butt Connector, pack of 5	22-18	PK	1
6287XX	Insulated Butt Connector, pack of 10	8	PK	1
6287NX	Insulated Butt Connector, pack of 25	8	PK	1
6287CX	Insulated Butt Connector, pack of 100	8	PK	1

STANDARD SOLDERLESS TERMINALS cont'd

Butt Connector Assortment Kit

This Assortment is a perfect addition to the HVAC kit. It includes an Insulated Butt Connector, a Non Insulated Butt Connector, and a Nylon Insulated Butt Connector. Includes parts 6217, 6231, and 6232.



6200BSX

CATALOG NO.	DESCRIPTION	UOM	ORDER MULTIPLE
6200BSX	Butt Connector Assortment Kit	EA	1

Insulated Spades

These insulated terminals crimp to the wires which relieves the need to solder.



61214

CATALOG NO.	DESCRIPTION	WIRE RANGE	STUD	UOM	ORDER MULTIPLE
61214	Insulated Spades, pack of 23	22-18	#6	PK	1
6237	Insulated Spades, pack of 22	22-18	#8	PK	1
6237LX	Insulated Spades, pack of 50	22-18	#8	PK	1
61256LX	Insulated Spades, pack of 50	22-18	#10	PK	1
6274	Insulated Spades, pack of 22	16-14	#6	PK	1
6274LX	Insulated Spades, pack of 50	16-14	#6	PK	1
6227	Insulated Spades, pack of 22	16-14	#8	PK	1
6227LX	Insulated Spades, pack of 50	16-14	#8	PK	1
6228	Insulated Spades, pack of 22	16-14	#10	PK	1
6228LX	Insulated Spades, pack of 50	16-14	#10	PK	1
60254	Insulated Spades, pack of 18	12-10	#8	PK	1
60254LX	Insulated Spades, pack of 50	12-10	#8	PK	1
60254CX	Insulated Spades, pack of 100	12-10	#8	PK	1
6255	Insulated Spades, pack of 17	12-10	#10	PK	1
6255LX	Insulated Spades, pack of 50	12-10	#10	PK	1
6255CX	Insulated Spades, pack of 100	12-10	#10	PK	1

Insulated Flange Spades

These insulated terminals crimp to the wires which relieves the need to solder.



61255

CATALOG NO.	DESCRIPTION	WIRE RANGE	STUD	UOM	ORDER MULTIPLE
61255	Insulated Flange Spades, pack of 16	12-10	#10	PK	1
61255LX	Insulated Flange Spades, pack of 50	12-10	#10	PK	1

Non-Insulated Rings

These non insulated terminals crimp to the wires which relieves the need to solder.



60206

CATALOG NO.	DESCRIPTION	WIRE RANGE	STUD	UOM	ORDER MULTIPLE
60206	Non-Insulated Rings, pack of 25	22-18	#10	PK	1
6215	Non-Insulated Rings, pack of 27	16-14	#8	PK	1
60205	Non-Insulated Rings, pack of 21	16-14	1/4"	PK	1
60205CX	Non-Insulated Rings, pack of 100	16-14	1/4"	PK	1

Non-Insulated Spades

These non insulated terminals crimp to the wires which relieves the need to solder.



6226

CATALOG NO.	DESCRIPTION	WIRE RANGE	STUD	UOM	ORDER MULTIPLE
6226	Non-Insulated Spades, pack of 23	16-14	#10	PK	1
6226CX	Non-Insulated Spades, pack of 100	16-14	#10	PK	1

Insulated Spring Spades

These insulated terminals crimp to the wires which relieves the need to solder.



6238

CATALOG NO.	DESCRIPTION	WIRE RANGE	STUD	UOM	ORDER MULTIPLE
6238	Insulated Spring Spades, pack of 22	22-18	#8	PK	1
6238LX	Insulated Spring Spades, pack of 50	22-18	#8	PK	1
6276	Insulated Spring Spades, pack of 21	16-14	#6	PK	1
6276LX	Insulated Spring Spades, pack of 50	16-14	#6	PK	1
6239	Insulated Spring Spades, pack of 22	16-14	#8	PK	1
6239LX	Insulated Spring Spades, pack of 50	16-14	#8	PK	1
60256	Insulated Spring Spades, pack of 17	12-10	#8	PK	1
60256CX	Insulated Spring Spades, pack of 100	12-10	#8	PK	1

Insulated Rings

These insulated terminals crimp to the wires which relieves the need to solder.



61202

CATALOG NO.	DESCRIPTION	WIRE RANGE	STUD	UOM	ORDER MULTIPLE
61202	Insulated Rings, pack of 22	22-18	#6	PK	1
6236LX	Insulated Rings, pack of 50	22-18	#8	PK	1
6272	Insulated Rings, pack of 22	16-14	#6	PK	1
6216	Insulated Rings, pack of 23	16-14	#10	PK	1
6216LX	Insulated Rings, pack of 50	16-14	#10	PK	1
6216CX	Insulated Rings, pack of 100	16-14	#10	PK	1
60247	Insulated Rings, pack of 17	12-10	#6	PK	1
60252CX	Insulated Rings, pack of 100	12-10	#8	PK	1
6252	Insulated Rings, pack of 17	12-10	#10	PK	1
6252LX	Insulated Rings, pack of 50	12-10	#10	PK	1
6253LX	Insulated Rings, pack of 50	12-10	1/4"	PK	1
6253CX	Insulated Rings, pack of 100	12-10	1/4"	PK	1
6257	Insulated Rings, pack of 6	8	1/4"	PK	1
6257NX	Insulated Rings, pack of 25	8	1/4"	PK	1
61252	Insulated Rings, pack of 5	6	5/16"	PK	1
61252NX	Insulated Rings, pack of 25	6	5/16"	PK	1

**HIGH TEMPERATURE SOLDERLESS TERMINALS****High Temperature Male Slip-Ons**

The High Temperature Male Slip Ons are constructed of nickel plated steel. These non insulated terminals are rated at 900 degree F (482 degree C).



CATALOG NO.	DESCRIPTION	WIRE RANGE	TAB SIZE	UOM	ORDER MULTIPLE
4220	High Temp. Male Slip-Ons, pack of 21	16-14	.250	PK	1
4220CX	High Temp. Male Slip-Ons, pack of 100	16-14	.250	PK	1
4219	High Temp. Male Slip-Ons, pack of 21	12-10	.250	PK	1

High Temperature Flag Female Slip-Ons

The High Temperature Flag Female Slip Ons are constructed of nickel plated steel. These non insulated terminals are rated at 900 degree F (482 degree C).



CATALOG NO.	DESCRIPTION	WIRE RANGE	TAB SIZE	UOM	ORDER MULTIPLE
4213	High Temp. Flag Female Slip-Ons, pack of 16	16-14	.250	PK	1
4213CX	High Temp. Flag Female Slip-Ons, pack of 100	16-14	.250	PK	1
4224	High Temp. Flag Female Slip-Ons, pack of 11	12-10	.250	PK	1
4224NX	High Temp. Flag Female Slip-Ons, pack of 25	12-10	.250	PK	1
4224CX	High Temp. Flag Female Slip-Ons, pack of 100	12-10	.250	PK	1

High Temperature Rings

The High Temperature Rings are constructed of nickel plated steel. These non insulated terminals are rated at 900 degree F (482 degree C).



CATALOG NO.	DESCRIPTION	WIRE RANGE	STUD	UOM	ORDER MULTIPLE
4215	High Temp. Rings, pack of 21	16-14	#10	PK	1
4215CX	High Temp. Rings, pack of 100	16-14	#10	PK	1
4205CX	High Temp. Rings, pack of 100	16-14	1/4"	PK	1
4252	High Temp. Rings, pack of 14	12-10	#10	PK	1
4252CX	High Temp. Rings, pack of 100	12-10	#10	PK	1
4253	High Temp. Rings, pack of 14	12-10	1/4"	PK	1
4253CX	High Temp. Rings, pack of 100	12-10	1/4"	PK	1

High Temperature Female Slip-Ons

The High Temperature Female Slip Ons are constructed of nickel plated steel. These non insulated terminals are rated at 900 degree F (482 degree C).



CATALOG NO.	DESCRIPTION	WIRE RANGE	TAB SIZE	UOM	ORDER MULTIPLE
4221	High Temp. Female Slip-Ons, pack of 20	16-14	.187	PK	1
4221CX	High Temp. Female Slip-Ons, pack of 100	16-14	.187	PK	1
4214	High Temp. Female Slip-Ons, pack of 21	16-14	.250	PK	1
4214CX	High Temp. Female Slip-Ons, pack of 100	16-14	.250	PK	1
4204	High Temp. Female Slip-Ons, pack of 17	12-10	.250	PK	1
4204CX	High Temp. Female Slip-Ons, pack of 100	12-10	.250	PK	1

High Temperature Spades

The High Temperature Spades Slip Ons are constructed of nickel plated steel. These non insulated terminals are rated at 900 degree F (482 degree C).



CATALOG NO.	DESCRIPTION	WIRE RANGE	STUD	UOM	ORDER MULTIPLE
4226	High Temp. Spades, pack of 23	16-14	#10	PK	1
4226CX	High Temp. Spades, pack of 100	16-14	#10	PK	1
4254CX	High Temp. Spades, pack of 100	12-10	#10	PK	1

High Temperature Butt Connectors

The High Temperature Butt Connectors are constructed of nickel plated steel. These non insulated terminals are rated at 900 degree F (482 degree C).



CATALOG NO.	DESCRIPTION	WIRE RANGE	UOM	ORDER MULTIPLE
4231	High Temp. Butt Connectors, pack of 17	12-10	PK	1

High Temperature Assortment

The High Temperature Assortment Pack holds terminals that are constructed of nickel plated steel. These non insulated terminals are rated at 900 degree F (482 degree C). Includes parts 4213, 4215, and 4204, and 4254.



CATALOG NO.	DESCRIPTION	UOM	ORDER MULTIPLE
4200AX	High Temp. Assortment	EA	1



DEVCO TERMINAL KITS

CATALOG NO.	DESCRIPTION	TERMINALS															
	NOTE: Some kits have parts not shown in chart. Please refer to the DESCRIPTION for these parts. Except where noted, kits come in clear plastic boxes.			HIGH TEMP													
6200HX	Flag Female Compressor Terminal Kit: 8-18 wire range in a 4-compartment box with parts 6270 and 6273 in the same compartment.										6258	6259	6270	6271	6273		
6200MX 6200MSX*	.187, .250 tabs; 12-10 wire range; #8, #10 studs in a 13-compartment polypropylene box.	6217 6231 6232	6218 6235 6251 6281		6216 6252			6213				6259				6211	
6201MX	.187, .250 tabs; 22-10 wire range; #8, #10 studs in a 21-compartment metal box. (Includes parts 6233, 6234, and 6277, not shown in chart).	6217 6231 6232	6218 6235 6251 6281 6282		6216 6236 6252	6228	6238 6239		6224		6258	6259				6211	
6202MX	Insulated Terminal Kit: .187, .250 tabs; 22-10 wire range; #8, #10, #6, 1/4" studs in an 18-compartment box. Parts 6233 & 6234, and parts 6222 & 6223 are pairs (not shown in chart).	6217 6231 6232	6218 6235 6251 6281 6282		6216 6252 6253 6272 60246	60254	6238 6239										
6203MX	Non-Insulated Terminal Kit: Includes High Temp. Terminals and Flag Female Compressor Terminals. .250 tab; 22-10 wire range; #8, #10 studs in an 18-compartment box. (Includes parts 6209 and 6210, not shown in chart).			4204 4213 4214 4215 4252 4254				6214	6213	6224		6258	6259	6270 6271	6230	6208	6211
4200AX	High Temperature Terminal Kit: .250 tab; 16-10 wire; #10 stud in a bag.			4204 4213 4215 4254													
6200X	.250 tab; 16-14 wire; #8 stud in a 6-compartment box.	6217						6214	6213		6215				6230		6211
6200AX	.250 tab; 16-14 wire range; #8, #10 studs in a 6-compartment box.	6217	6218		6216			6213							6230		6211
6200BX	.250 tab; 16-14 wire; #8 stud in a 4-compartment box.							6214	6213		6215						6211
6200BSX	22-10 wire range in a bag.	6217 6231 6232															
6200CX	.250 tab; 16-14 wire; #10 stud in a 4-compartment box.		6218		6216			6213									6211
6200DX	.250 tab; 12-10 wire range; #8, #10 studs in a 6-compartment box.	6231	6251		6252				6224						6230		6211

*Contains a crimper.



ANCHORS

Metal Drive Anchors

The anchors offer a Quick and Easy Solution for Light Duty Anchoring Jobs in Concrete and Masonry and Easy through type fastening, even when used in bottomless holes

7236RLX



CATALOG NO.	DESCRIPTION	SIZE	EMBEDMENT	PULLOUT LOAD	UOM	ORDER MULTIPLE
7233RLX	Drive Anchor, pack of 50	1/4" X 3/4"	5/8"	500 lb.	PK	1
7234RLX	Drive Anchor, pack of 50	1/4" X 1"	7/8"	944 lb.	PK	1
7235RLX	Drive Anchor, pack of 50	1/4" X 1-1/4"	1-1/8"	1,146 lb.	PK	1
7236RLX	Drive Anchor, pack of 50	1/4" X 1-1/2"	1-3/8"	854 lb.	PK	1

Drop-In Expansion Anchor Setting Tool

This tool is great for use while setting an anchor.

7146



CATALOG NO.	DESCRIPTION	UOM	ORDER MULTIPLE
7146	For use with anchor part number 7142	EA	1

Self-Drilling Gypsum Wallboard Anchors

These anchors pre drill precise holes in gypsum wallboard with no special tools required. The anchors are easily installed with a #2 or #3 Phillips screwdriver, slotted driver, or power driver. Plastic plugs toggles and toggles are easily replaced with the deep threaded products. There is a full range to cover all wall fastening applications and are available in corrosion resistant and non conductive white nylon. The product has a low profile head and can easily be backed out. They provide and strong engagement in 3/4in., 1/2in., and 5/8in. gypsum wallboard and are supplied with combo head screws.

7321X



CATALOG NO.	DESCRIPTION	SCREW SIZE	MAX. FIXTURE	UOM	ORDER MULTIPLE
7316X	E-Z Ancor [®] ; nylon, pack of 10	#8 x 1-1/4"	3/4"	PK	1
7316L	E-Z Ancor [®] ; nylon, pack of 50	#8 x 1-1/4"	3/4"	PK	1
7311L	E-Z Ancor [®] ; zinc die cast*, pack of 50	#6 x 1-1/4"	3/4"	PK	1
7317X	E-Z Ancor Lite [™] ; nylon, pack of 10	#6 x 1-1/4"	3/4"	PK	1
7317L	E-Z Ancor Lite [™] ; nylon, pack of 50	#6 x 1-1/4"	3/4"	PK	1
7321X	E-Z Toggle [™] ; zinc die cast; heavy-duty, pack of 10	#8 x 2-1/8"	5/8"	PK	1

*Smaller version of the E-Z Ancor[®] with a versatile core that can use #6 or #8 sheet metal screws or #6, #7, #8 drywall screws.

Drive Fasteners

These steel fasteners can be driven into dry wall like a nail and are secured by turning the screw down completely to expand the ribs.

7303



CATALOG NO.	DESCRIPTION	HOLE SIZE	GRIP RANGE	UOM	ORDER MULTIPLE
7301	Drive Fastener, pack of 6	1/4"	3/16" to 3/8"	PK	1
7302	Drive Fastener, pack of 6	1/4"	1/8" to 1/2"	PK	1
7303	Drive Fastener, pack of 6	1/4"	1/8" to 3/16"	PK	1

Drop-In Expansion Anchors

These heavy duty anchors are made of carbon steel. They are set by means of an internal plug and setting tool.































7142



CATALOG NO.	DESCRIPTION	BOLT SIZE	THREADS PER INCH	HOLE DEPTH	THREAD DEPTH	DRILL BIT SIZE	UOM	ORDER MULTIPLE
7142	Anchor, pack of 4	3/8"	18	1-5/8"	1/2"	1/2"	PK	1
7142LX	Anchor, pack of 50	3/8"	18	1-5/8"	1/2"	1/2"	PK	1



DEVCO PLASTIC ANCHOR KITS

CATALOG NO.		ANCHOR	DRILL SIZE	DRILL BIT INCLUDED	SCREW	SCREW SIZE
SMALL PACK*	100 PACK					
	7103CX		<u>5/32</u> 			#4 x 3/4"
	7101CX		<u>3/16</u> 			#8 x 1"
	7101HCX					#8 x 1"
	7102CX		<u>1/4</u> 			#10 x 1-1/4"
	7102HCX					#10 x 1"
	7106CX		<u>1/4</u> 			#10 x 1
7106			<u>1/4</u> 	None		#10 x 1"
7105LX			<u>5/16</u> 			#14 x 1-1/2"
7111X	7111CX		<u>5/16</u> 			#14 x 1"
	7111HCX					#14 x 1"

*SMALL PACK	COUNT
7106	28
7111X	40
7105LX	50

**BOXES, RINGS, AND COVERS****Steel Utility Boxes***

Steel Utility Boxes are used for convenience outlets, switch boxes and small junction boxes. Galvanized steel.

**PI360**

CATALOG NO.	LENGTH	WIDTH	DEPTH	CAPACITY (cubic in.)	KNOCKOUT (in.)	UOM	ORDER MULTIPLE
PI360	4"	2-1/8"	1-7/8"	13.0	1/2	EA	1
PI361	4"	2-1/8"	2-1/8"	14.5	1/2	EA	1
PI361-3/4	4"	2-1/8"	2-1/8"	14.5	3/4 & 1/2	EA	1

Steel Octagon Box*

Steel Utility Boxes are used for convenience outlets, switch boxes and small junction boxes. Galvanized steel.

**PI364**

CATALOG NO.	LENGTH	WIDTH	DEPTH	CAPACITY (cubic in.)	KNOCKOUT (in.)	UOM	ORDER MULTIPLE
PI364	4"	4"	1-1/2"	15.5	3/4 & 1/2	EA	1

Device Rings*

Device rings are designed for projects of preexisting locations. They can help narrow an opening for a box in the sheet rock. They are also known as Plaster Rings. Galvanized steel.

**PI387**

CATALOG NO.	DESCRIPTION	NUMBER DEVICES	RAISED	UOM	ORDER MULTIPLE
PI387	1900 Device Ring	1	1/2"	EA	1

Utility Covers*

These covers are 4 1/4in. x 2 11/32in. and are designed for appliances or emergency oil burners.

**PI383**

CATALOG NO.	DESCRIPTION	UOM	ORDER MULTIPLE
PI383	Appliance Switch, .4687" dia. hole, baked cadilite finish	EA	1
PI374	Red finish, "Emergency Gas Burner" in white letters	EA	1

Steel 1900 Boxes*

Steel Utility Boxes are used for convenience outlets, switch boxes and small junction boxes. Galvanized steel.

**PI362**

CATALOG NO.	LENGTH	WIDTH	DEPTH	CAPACITY (cubic in.)	KNOCKOUT (in.)	UOM	ORDER MULTIPLE
PI362	4"	4"	1-1/2"	21.0	3/4 & 1/2	EA	1
PI363	4"	4"	2-1/8"	30.3	3/4 & 1/2	EA	1

Extension Rings*

Extension rings are used when extra cubic inch capacity is needed for additional wiring. Galvanized steel.

**PI390**

CATALOG NO.	LENGTH	WIDTH	DEPTH	CAPACITY (cubic in.)	KNOCKOUT (in.)	UOM	ORDER MULTIPLE
PI390	4"	2-1/8"	1-7/8"	13.0	1/2	EA	1
PI391	4"	4"	1-1/2"	21.0	3/4 & 1/2	EA	1

Plated Steel Utility Covers*

Ideal for exposed work applications, providing an easy method for the installation of electrical devices (switches, receptacles, fans, lights, etc.)

**PI365**

CATALOG NO.	DESCRIPTION	WIDTH	LENGTH	UOM	ORDER MULTIPLE
PI365	Toggle Switch	2-11/32"	4-1/4"	EA	1
PI366	Duplex Receptacle	2-11/32"	4-1/4"	EA	1
PI367	Blank Cover	2-11/32"	4-1/4"	EA	1
PI375	Standard Single Receptacle	2-11/32"	4-1/4"	EA	1

Utility Plates*

These plates are 4 1/4in. x 2 11/32in. and are designed for emergency oil burners.

**PI393**

CATALOG NO.	DESCRIPTION	UOM	ORDER MULTIPLE
PI393	Red finish, "Emergency Oil Burner" in white letters	EA	1
PI394	Red finish, "Emergency Gas Burner" in white letters	EA	1

*Items in this section are Underwriter's Laboratories listed or recognized under the prime manufacturer's name.

BOXES, RINGS, AND COVERS cont'd

Steel 1900 Covers*

The covers are baked in a cadilite finished steel and are raised 1/2in. with fully depressed corners. Size: 4" x 4".



CATALOG NO.	DESCRIPTION	UOM	ORDER MULTIPLE
PI377	Single Toggle	EA	1
PI378	Single Duplex Receptacle	EA	1
PI379	One Standard Single Receptacle	EA	1
PI368	Toggle Switch and Duplex Receptacle	EA	1
PI370	Toggle Switch and Standard Single Receptacle	EA	1
PI371	Flat, Blank, Galvanized steel (not Cadilite finished)	EA	1

Weatherproof Covers*

These covers can be used with item PI385 and come with gaskets.

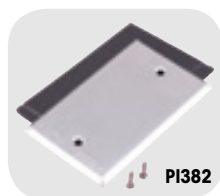

CATALOG NO.	DESCRIPTION	UOM	ORDER MULTIPLE
PI382	Blank Cover	EA	1
PI386	Lever Switch Cover for standard toggle type switches	EA	1
PI389	Duplex Receptacle Cover	EA	1
PI389-GFI	GFI Receptacle Cover	EA	1

Weatherproof Boxes*

Heavy duty die cast aluminum with baked aluminum finish. Boxes have two closure plugs and three holes. Item is Underwriter's Laboratories listed or recognized under the prime manufacturer's name.



CATALOG NO.	LENGTH	WIDTH	DEPTH	CAPACITY (cubic in.)	HOLE SIZE (in.)	UOM	ORDER MULTIPLE
PI385	4-1/2"	2-3/4"	2"	19.0	1/2	EA	1
PI385-34	4-1/2"	2-3/4"	2"	19.0	3/4	EA	1

Weatherproof Box with Lever Switch Cover*

The box is heavy duty die cast aluminum with baked aluminum finish and has two closure plugs and three holes. The cover comes with the gaskets. Includes parts PI385 and PI386.



CATALOG NO.	DESCRIPTION	UOM	ORDER MULTIPLE
PI384	Weatherproof Box and Lever Switch Cover	EA	1

Safety Plates*

Safety plates, also called nail in plates, or nail plates, install quickly and protect wire, cable and pipes that may be installed in upright wood stud walls.



CATALOG NO.	DESCRIPTION	UOM	ORDER MULTIPLE
PI232CX	Safety Plate – approximately 6"	EA	100

BULBS

Incandescent Light Bulbs

Multi-filaments support increased bulb light. Filaments have solid nickel leads. Brass base is rust and freeze resistant. Bulbs are designed for 130 volts. Rough Service bulbs are designed for maximum vibration resistance. Toughcoat helps prevent shattering on impact for superior safety. Comes in standard pack of six.



CATALOG NO.	DESCRIPTION	WATTS	UOM	ORDER MULTIPLE
5231	Rough Service Bulbs, pack of 6	75	PK	1
5232	Rough Service Bulbs, pack of 6	100	PK	1

*Items in this section are Underwriter's Laboratories listed or recognized under the prime manufacturer's name.



CABLE CONNECTORS

Zinc Plated Die Cast Steel Romex Connectors*

These zinc plated die cast connectors are for use with Romex, Service, and UF Cables.

PI319



CATALOG NO.	DESCRIPTION	TRADE SIZE	KNOCKOUT	UOM	ORDER MULTIPLE
PI321	Zinc plated die cast Romex Connector, pack of 8	3/8"	1/2"	PK	1
PI320	Zinc plated die cast Romex Connector, pack of 25	3/8"	1/2"	PK	1
PI319	Zinc plated die cast Romex Connector, pack of 4	3/4"	3/4"	PK	1
PI319CX	Zinc plated die cast Romex Connector, pack of 100	3/4"	3/4"	PK	1

BX and Greenfield Connectors*

These connectors are used to terminate Flexible Metal Conduit to a knock out in a dry location box or enclosure. Zinc die cast.



CATALOG NO.	DESCRIPTION	TRADE SIZE	KNOCKOUT	UOM	ORDER MULTIPLE
PI311	Set Screw Type Connector, 25 per pack	3/8"	1/2"	PK	1
PI312	Set Screw Type Connector, 8 per pack	3/8"	1/2"	PK	1
PI322	Straight Connector, squeeze type, for armored cable and flexible conduit, 8 per pack	3/8"	1/2"	PK	1
PI315	90° Connector, 3 per pack	3/8"	1/2"	PK	1
PI341	90° Connector, 4 per pack	1/2"	1/2"	PK	1
PI340	Combination Cable Connector suitable for Romex or BX and Greenfield, 8 per pack	3/8"	1/2"	PK	1
PI318	Duplex Connector with single screw, clamp type, 2 per pack	3/8"	1/2"	PK	1

Thinwall E.M.T. Connectors*

These are used to join EMT conduit to boxes on enclosures. Zinc die cast.

PI411



CATALOG NO.	DESCRIPTION	TRADE SIZE	KNOCKOUT	UOM	ORDER MULTIPLE
PI411	Compression Type Connectors, 8 per pack	1/2"	1/2"	PK	1
PI412	Compression Type Connectors, 8 per pack	3/4"	3/4"	PK	1
PI416	Compression Type Couplings, 8 per pack	3/4"		PK	1
PI426	Compression Type Straight Connectors for connecting E.M.T. to Liquid-Tight, 8 per pack	3/4"		PK	1
PI419	Set Screw Type Connectors, 8 per pack	1/2"	1/2"	PK	1

Rigid Conduit Bodies*

These bodies are Aluminum and can be use indoor or outdoor. Use to gain access to the interior of a raceway for wire pulling, splicing (with limitations as specified by the NEC), and maintenance. This item comes with cover and gasket.



PI458

CATALOG NO.	DESCRIPTION	TRADE SIZE	BODY TYPE	UOM	ORDER MULTIPLE
PI458	Includes steel cover, screws, gasket	1/2"	Back (LB)	EA	1
PI459	Includes steel cover, screws, gasket	3/4"	Back (LB)	EA	1

Liquid-Tite Connectors*

These connectors are made of zinc die cast and can be used with Flexible Metal Conduits and non metallic conduits. Zinc die cast.



PI352

CATALOG NO.	DESCRIPTION	TRADE SIZE	KNOCKOUT	UOM	ORDER MULTIPLE
PI350	Straight Liquid-Tite Connector, 2 per pack	1/2"	1/2"	PK	1
PI351	Straight Liquid-Tite Connector, 2 per pack	3/4"	3/4"	PK	1
PI352	90° Liquid-Tite Connector	1/2"	1/2"	EA	1
PI353	90° Liquid-Tite Connector	3/4"	3/4"	EA	1

CABLE TIES AND ACCESSORIES

Heavy Duty Nylon Cable Ties

Black ties are weather and UV resistant. Items in this section are Underwriters' Laboratories listed or recognized under the prime manufacturer's name.

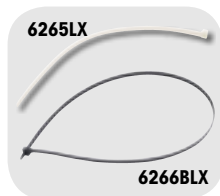

CATALOG NO.	DESCRIPTION	LENGTH	COLOR	MAX. BUNDLE DIAMETER	TENSILE STRENGTH	UOM	ORDER MULTIPLE
6265BLX	Nylon; Heavy-duty, pack of 50	14"	Black	4"	175 lb.	PK	1
6265BCX	Nylon; Heavy-duty, pack of 100	14"	Black	4"	175 lb.	PK	1
6266BLX	Nylon; Heavy-duty, pack of 50	36"	Black	11"	175 lb.	PK	1

Nylon Cable Ties

Black ties are weather and UV resistant. Items in this section are Underwriters' Laboratories listed or recognized under the prime manufacturer's name.



CATALOG NO.	DESCRIPTION	LENGTH	COLOR	MAX. BUNDLE DIAMETER	TENSILE STRENGTH	UOM	ORDER MULTIPLE
6267MX	Nylon Cable Ties, pack of 1,000	4"	Natural	13/16"	18 lb.	PK	1
6261CX	Nylon Cable Ties, pack of 100	6"	Natural	1-3/8"	18 lb.	PK	1
6261BCX	Nylon Cable Ties, pack of 100	6"	Black	1-3/8"	18 lb.	PK	1
6268BMX	Nylon Cable Ties, pack of 1,000	6"	Black	1-3/8"	30 lb.	PK	1
6262LX	Nylon Cable Ties, pack of 50	7-1/2"	Natural	1-3/4"	50 lb.	PK	1
6262CX	Nylon Cable Ties, pack of 100	7-1/2"	Natural	1-3/4"	50 lb.	PK	1
6262MX	Nylon Cable Ties, pack of 1,000	7-1/2"	Natural	1-3/4"	50 lb.	PK	1
6262BLX	Nylon Cable Ties, pack of 50	7-1/2"	Black	1-3/4"	50 lb.	PK	1
6262BCX	Nylon Cable Ties, pack of 100	7-1/2"	Black	1-3/4"	50 lb.	PK	1
6262BMX	Nylon Cable Ties, pack of 1,000	7-1/2"	Black	1-3/4"	50 lb.	PK	1
6263NX	Nylon Cable Ties, pack of 25	11"	Natural	3"	50 lb.	PK	1
6263LX	Nylon Cable Ties, pack of 50	11"	Natural	3"	50 lb.	PK	1
6263CX	Nylon Cable Ties, pack of 100	11"	Natural	3"	50 lb.	PK	1
6263DX	Nylon Cable Ties, pack of 500	11"	Natural	3"	50 lb.	PK	1
6263BNX	Nylon Cable Ties, pack of 25	11"	Black	3"	50 lb.	PK	1
6263BLX	Nylon Cable Ties, pack of 50	11"	Black	3"	50 lb.	PK	1
6263BCX	Nylon Cable Ties, pack of 100	11"	Black	3"	50 lb.	PK	1
6263BDX	Nylon Cable Ties, pack of 500	11"	Black	3"	50 lb.	PK	1
60265LX	Nylon Cable Ties, pack of 50	14"	Natural	4"	50 lb.	PK	1
60265BLX	Nylon Cable Ties, pack of 50	14"	Black	4"	50 lb.	PK	1

Nylon Cable Ties with Mounting Hole

Black ties are weather and UV resistant. Items in this section are Underwriters' Laboratories listed or recognized under the prime manufacturer's name.

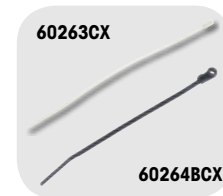

CATALOG NO.	DESCRIPTION	MOUNTING HOLE	LENGTH	COLOR	MAX. BUNDLE DIAMETER	TENSILE STRENGTH	UOM	ORDER MULTIPLE
60264CX	Tie w/mtg. hole, pack of 100	#8	6"	Natural	1-3/8"	30 lb.	PK	1
60264BCX	Tie w/mtg. hole, pack of 100	#8	6"	Black	1-3/8"	30 lb.	PK	1
6264LX	Tie w/mtg. hole, pack of 50	#10	7"	Natural	1-3/4"	50 lb.	PK	1
6264CX	Tie w/mtg. hole, pack of 100	#10	7"	Natural	1-3/4"	50 lb.	PK	1
6264BLX	Tie w/mtg. hole, pack of 50	#10	7"	Black	1-3/4"	50 lb.	PK	1
6264BCX	Tie w/mtg. hole, pack of 100	#10	7"	Black	1-3/4"	50 lb.	PK	1
6264BMX	Tie w/mtg. hole, pack of 1,000	#10	7"	Black	1-3/4"	50 lb.	PK	1
60263CX	Tie w/mtg. hole, pack of 100	#10	11"	Natural	3"	50 lb.	PK	1
60263BLX	Tie w/mtg. hole, pack of 50	#10	11"	Black	3"	50 lb.	PK	1
60263BCX	Tie w/mtg. hole, pack of 100	#10	11"	Black	3"	50 lb.	PK	1

Black Nylon Cable Tie Assortment

Black ties are weather and UV resistant. Items in this section are Underwriters' Laboratories listed or recognized under the prime manufacturer's name.

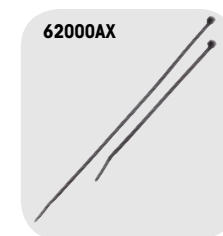

CATALOG NO.	DESCRIPTION	LENGTH	COLOR	MAX. BUNDLE DIAMETER	TENSILE STRENGTH	UOM	ORDER MULTIPLE
62000AX	Assortment	7-1/2" 11"	Black Black	1-3/4" 3"	50 lb. 50 lb.	PK	1

Cable Tie Mounts

Approximately 1in. square adhesive backed. These mounts can be mounted with a screw and will accept up to 75 lb. ties.



CATALOG NO.	DESCRIPTION	UOM	ORDER MULTIPLE
6269	Cable Tie Mounts; 1" square; adhesive backed, pack of 11	PK	1
6269LX	Cable Tie Mounts; 1" square; adhesive backed, pack of 50	PK	1
6269CX	Cable Tie Mounts; 1" square; adhesive backed, pack of 100	PK	1
6269MX	Cable Tie Mounts; 1" square; adhesive backed, pack of 1,000	PK	1

**CONDUIT FITTINGS****Straps**

Our zinc plated steel straps are designed to hold conduit pipe.



CATALOG NO.	DESCRIPTION	UOM	ORDER MULTIPLE
PI306	Straps fit 1/2" E.M.T. Conduit, pack of 20	PK	1
PI306CX	Straps fit 1/2" E.M.T. Conduit, pack of 100	PK	1
PI307	Straps fit 3/4" E.M.T. Conduit, pack of 12	PK	1
PI307CX	Straps fit 3/4" E.M.T. Conduit, pack of 100	PK	1
PI908	Straps fit 1" E.M.T. Conduit, pack of 10	PK	1
PI908CX	Straps fit 1" E.M.T. Conduit, pack of 100	PK	1
PI909LX	Straps fit 1-1/4" E.M.T. Conduit, pack of 50	PK	1
PI206	Straps for 14-2 Romex, pack of 20	PK	1

Knockout Seals and Hole Plug

CATALOG NO.	DESCRIPTION	UOM	ORDER MULTIPLE
PI316	For 1/2" knockouts, zinc plated steel, pack of 10	PK	1
PI317	For 3/4" knockouts, zinc plated steel, pack of 10	PK	1
ED406	Nylon Hole Plug for 3/8" hole, pack of 28	PK	1

Conduit Nipples*

PI301 is zinc die cast steel. PI303 is galvanized steel. All come with plated steel locknuts and plastic insulating bushings.



CATALOG NO.	DESCRIPTION	SIZE	CONNECTION	UOM	ORDER MULTIPLE
PI301	Conduit Nipple, pack of 2	1/2"	Offset	PK	1
PI303	Conduit Nipple, pack of 2	1/2" x 2"	Straight	PK	1

Electrical Staples

We have steel, insulated copper finish, and plastic electrical staples available.



CATALOG NO.	DESCRIPTION	SIZE	UOM	ORDER MULTIPLE
PI330	Plastic; for 2 conductor Romex and other NM cable conductor; 12/2-14/2 range; UV protected, pack of 50	3/8" x 1/2"	PK	1
PI332	Plastic; for 3 conductor Romex and other NM cable conductor; 12/3-14/3 range; UV protected, pack of 50	3/8" x 3/4"	PK	1
PI309	Steel; non-insulated for Romex and NM cable; 14/2-10/3 range, pack of 154	1" x 1/2"	PK	1
ED273	Insulated coppered finish; size #5, pack of 50	5/8" x 1/4"	PK	1
ED273CX	Insulated coppered finish; size #5, pack of 100	5/8" x 1/4"	PK	1

Reducing Washers

Reducing washers are for reducing knockout holes. These washers have raised flanges for a tight fit and are made of galvanized steel. PI308 reduces hole to fit appliance switch.



CATALOG NO.	DESCRIPTION	UOM	ORDER MULTIPLE
PI304	Reducing Washer - reduces hole from 1" to 1/2", pack of 10	PK	1
PI305	Reducing Washer - reduces hole from 1" to 3/4", pack of 10	PK	1
PI310	Reducing Washer - reduces hole from 3/4" to 1/2", pack of 28	PK	1
PI310LX	Reducing Washer - reduces hole from 3/4" to 1/2", pack of 50	PK	1
PI912	Reducing Washer - reduces hole from 2" to 3/4", pack of 5	PK	1
PI912LX	Reducing Washer - reduces hole from 2" to 3/4", pack of 50	PK	1
PI913	Reducing Washer - reduces hole from 1-1/2" to 1/2", pack of 4	PK	1
PI914	Reducing Washer - reduces hole from 1-1/2" to 3/4", pack of 4	PK	1

Conduit Nipples*

Used to connect two electrical utility boxes where room is limited. Zinc die cast steel. Comes with plated steel locknuts.



CATALOG NO.	DESCRIPTION	SIZE	CONNECTION	UOM	ORDER MULTIPLE
PI203	Conduit Nipple, pack of 6	1/2"	Straight	PK	1

Bushings and Locknuts

The locknuts and bushing are straight connectors provide excellent pullout strength and can be installed without disassembly. The compression nut ratchet prevents unintentional loosening.



CATALOG NO.	DESCRIPTION	UOM	ORDER MULTIPLE
PI331	Plastic "Anti-Short" Bushings for 14/2, 14/3, 12/2 BX cable, pack of 35	PK	1

GENERAL TOOLS

Devco Crimpers

Crimps insulated and non insulated terminals 22 to 10 AWG, cuts bolts #4 40 through #10 24, and strips stranded wire 22 to 10 AWG and solid wire 18 to 8 AWG. Features two precision ground wire cutters, one on the nose and the other behind the pivot point. Plastic cushion handle.



5002

CATALOG NO.	DESCRIPTION	UOM	ORDER MULTIPLE
5002	Devco Crimpers; plastic coated handle	EA	1

Blind Rivet Tools

Heavy duty hand rivet tool that offers long handles to increase leverage and to secure the rivet in the nosepiece while the tool is in use. Powerful riveting capacity with 4 standard nosepieces to set 3/32", 1/8", 5/32", and 3/16" blind rivets.



5107

CATALOG NO.	DESCRIPTION	UOM	ORDER MULTIPLE
5107	Heavy-duty tool; 4 interchangeable nose pieces to accommodate 3/32", 1/8", 5/32", 3/16" steel or aluminum rivets	EA	1

Magnetic Hex Chucks

Magnetic Hex Chucks may be used with an electric drill to drive hex washer head screws.



DE15

CATALOG NO.	DESCRIPTION	HEX HEAD SIZE	HEX HEAD DIAMETER	LENGTH	UOM	ORDER MULTIPLE
DE13	Magnetic Hex Chuck	1/4"	7/16"	1-3/4"	EA	1
DE14	Magnetic Hex Chuck	5/16"	1/2"	1-3/4"	EA	1
DE15	Magnetic Hex Chuck	3/8"	9/16"	1-7/8"	EA	1
DE23	Magnetic Hex Chuck	1/4"	7/16"	2-9/16"	EA	1
DE24	Magnetic Hex Chuck	5/16"	1/2"	2-9/16"	EA	1
DE33**	Magnetic Hex Chuck	1/4"	7/16"	3"	EA	1

**Magnetic insert bit holder with a "C" ring retainer

NUTS AND BOLTS

Finished Hex Nuts

The hex nuts are zinc plated steel.



6501

CATALOG NO.	DESCRIPTION	SIZE	UOM	ORDER MULTIPLE
6501	Finished Hex Nuts, pack of 60	1/4" - 20	PK	1
6501CX	Finished Hex Nuts, pack of 100	1/4" - 20	PK	1
6502	Finished Hex Nuts, pack of 38	5/16" - 18	PK	1
6503	Finished Hex Nuts, pack of 25	3/8" - 16	PK	1
6503CX	Finished Hex Nuts, pack of 100	3/8" - 16	PK	1
6505	Finished Hex Nuts, pack of 11	1/2" - 13	PK	1
6505LX	Finished Hex Nuts, pack of 50	1/2" - 13	PK	1

Machine Screw Hex Nuts

The hex nuts are zinc plated steel.



6526

CATALOG NO.	DESCRIPTION	SIZE	UOM	ORDER MULTIPLE
6526	Machine Screw Hex Nuts, pack of 49	#8 - 32	PK	1
6528	Machine Screw Hex Nuts, pack of 44	#10 - 24	PK	1
6500A	Assortment, 23 of each	#6-32, #8-32, #10-32	EA	1

Toggle Bolts

The toggle bolts are slotted round head machine screws with spring wings and are made of zinc plated steel.

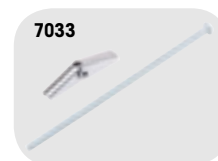

7033

CATALOG NO.	DESCRIPTION	LENGTH	BOLT SIZE	HOLE SIZE	UOM	ORDER MULTIPLE
7033	Toggle Bolts, pack of 6	4"	3/16"	1/2"	PK	1
7034	Toggle Bolts, pack of 5	4"	1/4"	5/8"	PK	1
7036X	Toggle Bolts, pack of 4	4"	3/8"	1"	PK	1
7066X	Toggle Bolts, pack of 4	6"	3/8"	1"	PK	1

**NUTS AND BOLTS cont'd****Stove Bolts**

Stove Bolts are a combination of slotted round head machine screws and finished hex nuts. They are made of zinc plated steel.



CATALOG NO.	DESCRIPTION	SIZE	LENGTH	UOM	ORDER MULTIPLE
6401	Stove Bolts, pack of 42	#10 - 24	1/2"	PK	1
6402	Stove Bolts, pack of 38	#10 - 24	3/4"	PK	1
6403	Stove Bolts, pack of 34	#10 - 24	1"	PK	1
6404	Stove Bolts, pack of 27	#10 - 24	1-1/2"	PK	1
6411	Stove Bolts, pack of 22	1/4" - 20	1/2"	PK	1
6412	Stove Bolts, pack of 20	1/4" - 20	3/4"	PK	1
6413	Stove Bolts, pack of 18	1/4" - 20	1"	PK	1
6414	Stove Bolts, pack of 15	1/4" - 20	1-1/2"	PK	1
6415	Stove Bolts, pack of 13	1/4" - 20	2"	PK	1
6416	Stove Bolts, pack of 11	1/4" - 20	2-1/2"	PK	1

Flat Washers

These washers are zinc plated steel with a USS Classification.

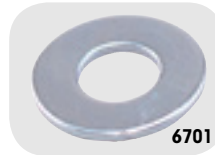

CATALOG NO.	DESCRIPTION	SIZE	INNER DIAMETER	OUTER DIAMETER	UOM	ORDER MULTIPLE
6701	Flat Washers (USS), pack of 160	3/16"	1/4"	9/16"	PK	1
6702	Flat Washers (USS), pack of 72	1/4"	5/16"	3/4"	PK	1
6703	Flat Washers (USS), pack of 33	5/16"	3/8"	7/8"	PK	1
6704	Flat Washers (USS), pack of 37	3/8"	7/16"	1"	PK	1
6704-2X	Flat Washers (USS), pack of 134	3/8"	7/16"	1"	PK	1
6706	Flat Washers (USS), pack of 11	1/2"	9/16"	1-3/8"	PK	1
6706-2X	Flat Washers (USS), pack of 52	1/2"	9/16"	1-3/8"	PK	1
6700AX	Assortment	All sizes included			EA	1

Fender Washers

These washers are made of zinc plated steel.

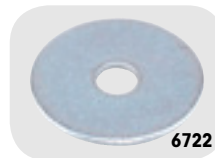

CATALOG NO.	DESCRIPTION	SIZE	INNER DIAMETER	OUTER DIAMETER	UOM	ORDER MULTIPLE
6722	Fender Washers, pack of 20	1/4"	9/32"	1-1/4"	PK	1
6722-2X	Fender Washers, pack of 92	1/4"	9/32"	1-1/4"	PK	1
6724	Fender Washers, pack of 12	3/8"	13/32"	1-1/2"	PK	1
6724-2X	Fender Washers, pack of 66	3/8"	13/32"	1-1/2"	PK	1

Motor Bolts

Motor Bolts are all thread rods made of zinc metal steel. Each Bolt includes four machine screw hex nuts.



CATALOG NO.	DESCRIPTION	SIZE	LENGTH	UOM	ORDER MULTIPLE
6108	Motor Bolts, pack of 16	#8 - 32	1-1/2"	PK	1
6109	Motor Bolts, pack of 16	#10 - 32	1-1/2"	PK	1

Hex Head Cap Screws

Hex Screw Cap Screws are made of low carbon, grade 2 steel and are USS Classified. The total thread length on these screws equal 2x diameter + 1/4in.



CATALOG NO.	DESCRIPTION	SIZE	LENGTH	UOM	ORDER MULTIPLE
6601	Hex Head Cap Screws, pack of 28	1/4" - 20	3/4"	PK	1
6602	Hex Head Cap Screws, pack of 25	1/4" - 20	1"	PK	1
6603	Hex Head Cap Screws, pack of 18	1/4" - 20	1-1/2"	PK	1
6622	Hex Head Cap Screws, pack of 15	5/16" - 18	1"	PK	1
6623	Hex Head Cap Screws, pack of 12	5/16" - 18	1-1/2"	PK	1
6641	Hex Head Cap Screws, pack of 14	3/8" - 16	3/4"	PK	1
6642	Hex Head Cap Screws, pack of 12	3/8" - 16	1"	PK	1
6643	Hex Head Cap Screws, pack of 8	3/8" - 16	1-1/2"	PK	1
6644	Hex Head Cap Screws, pack of 7	3/8" - 16	2"	PK	1
6645	Hex Head Cap Screws, pack of 5	3/8" - 16	2-1/2"	PK	1
6685	Hex Head Cap Screws, pack of 3	1/2" - 13	2-1/2"	PK	1
6683	Hex Head Cap Screws, pack of 5	1/2" - 13	1-1/2"	PK	1

Medium Split Lock Washers

Spring type. These washers are made of zinc plated steel.



CATALOG NO.	DESCRIPTION	SIZE	UOM	ORDER MULTIPLE
6730	Medium Split Lock Washers, pack of 95	3/16"	PK	1
6731	Medium Split Lock Washers, pack of 72	1/4"	PK	1
6732	Medium Split Lock Washers, pack of 59	5/16"	PK	1
6733	Medium Split Lock Washers, pack of 38	3/8"	PK	1
6735	Medium Split Lock Washers, pack of 18	1/2"	PK	1

POWER CORDS AND WORK LIGHTS

Round Extension Cords*

Comes in bright orange or yellow, depending upon availability.



CATALOG NO.	DESCRIPTION	WIRE	LENGTH	RATING	UOM	ORDER MULTIPLE
5225	Round Extension Cord	16/3	25'	13A/125V	EA	1
5230	Round Extension Cord	14/3	100'	13A/125V	EA	1

Trouble Lights*

These all weather lights are extra flexible with metal guards.



CATALOG NO.	DESCRIPTION	WIRE	CORD LENGTH	RATING	UOM	ORDER MULTIPLE
5200	Trouble Light	16/3	25'	13A/125V	EA	1
5201	Trouble Light	16/3	50'	13A/125V	EA	1

SCREWS

Combo Head Sheet Metal Screws

These screws are used on sheet metal items.



CATALOG NO.	DESCRIPTION	LENGTH	SCREW SIZE	UOM	ORDER MULTIPLE
6853	Combo Head Screws, pack of 48	1/2"	#10	PK	1
6855	Combo Head Screws, pack of 46	3/4"	#10	PK	1
6858	Combo Head Screws, pack of 26	1-1/2"	#10	PK	1
6859	Combo Head Screws, pack of 19	2"	#10	PK	1
6865	Combo Head Screws, pack of 32	3/4"	#12	PK	1
6866	Combo Head Screws, pack of 26	1"	#12	PK	1
6868	Combo Head Screws, pack of 18	1-1/2"	#12	PK	1
6876	Combo Head Screws, pack of 20	1"	#14	PK	1
6878	Combo Head Screws, pack of 15	1-1/2"	#14	PK	1

Sheet Metal Screw Assortments

6800BX and 6800HX come in a four compartment, clear plastic box.



CATALOG NO.	DESCRIPTION	UOM	ORDER MULTIPLE
6800HX	Slotted Hex Washer Head Screws: #6 x 3/8", #8 x 1/2", #8 x 3/4", #10 x 3/4", #10 x 1"	EA	1

Self-Drilling Screw Repair Kit

These screws are used for replacements in striped holes.



CATALOG NO.	DESCRIPTION	UOM	ORDER MULTIPLE
6900AX	Contains: #12 x 3/4", #12 x 1", #14 x 3/4", #14 x 1"	EA	1

Self-Drilling Screws

Zinc plated steel. Self drilling screws drill and tap holes in one step. Hex washer heads. #8 and #10 screws are designed for use with material thickness of .035" to .110"; #12 and #14 screws are designed for use with .110" to .220" material thickness.



CATALOG NO.	DESCRIPTION	UOM	ORDER MULTIPLE
6943CX	Hex Head Self Drilling Screw, 1/4in. Head #8 x 1/2in., 100 pcs	EA	1
6945CX	Hex Head Self Drilling Screw, Zinc Plated, #8 x 3/4in., 100 pcs	EA	1
6946CX	Hex Head Self Drilling Screw, 1/4in. Head #8 x 1in, 100 pcs	EA	1
6953CX	Hex Washer Head Self Drilling Screws 5/16in. Head #10 x 1/2in 100 pcs	EA	1
6955CX	Hex Head Self Drilling Screw, 5/16in. Head #10 x 3/4in., 100 pcs	EA	1
6956CX	Hex Washer Head Self Drilling Screws 5/16in. Head #10 x 1in 100 pcs	EA	1

*Items in this section are Underwriter's Laboratories listed or recognized under the prime manufacturer's name.



SPECIALTY FASTENERS

Nylon Cable Clamps

These cable clamps are perfect for securing wire or pipes.



CATALOG NO.	DESCRIPTION	FITS PIPE OUTER DIAMETER	THICKNESS	WIDTH	UOM	ORDER MULTIPLE
5381	Nylon Cable Clamps, pack of 54	1/8"	.050"	3/8"	PK	1
5382	Nylon Cable Clamps, pack of 48	1/4"	.050"	3/8"	PK	1
5383	Nylon Cable Clamps, pack of 41	3/8"	.050"	3/8"	PK	1
5384	Nylon Cable Clamps, pack of 35	1/2"	.050"	3/8"	PK	1
5385	Nylon Cable Clamps, pack of 21	5/8"	.060"	1/2"	PK	1
5380AX	Assortment	1/8" - 1"			EA	1

Pipe Hanging Strap

Non plated Steel Pipe hanging Strap is perfect for hanging pipes, fastening faucets and valves, as well as repair jobs.



CATALOG NO.	DESCRIPTION	SIZE	UOM	ORDER MULTIPLE
PI335	Pipe Hanging Strap, 28 gauge AWG	3/4" x 10'	EA	1

Cotter Pins

Cotter Pins provide smooth locking between two parts. This set includes an assortment of regular Cotter Pins with extended prongs.



CATALOG NO.	DESCRIPTION	UOM	ORDER MULTIPLE
6011	Cotter Pins: 1/16" x 1-1/2"; 3/32" x 1-1/2"; 1/8" x 1-1/2", pack of 51	PK	1

Motor Shaft Key Assortments

You can use choose from either a large assortment or a small assortment. The keys are made of cold rolled 1018 steel and are zinc plated.



CATALOG NO.	DESCRIPTION	UOM	ORDER MULTIPLE
6101	Small Assortment includes: 1/8" x 1/8" x 1-3/16"; 3/16" x 3/16" x 1-3/16"; 3/16" x 1/4" x 1-3/16"; 1/4" x 1/4" x 1-3/4"	EA	1
6102	Large Assortment includes: 1/4" x 1/4" x 1-3/4"; 5/16" x 5/16" x 3"; 3/8" x 3/8" x 3"	EA	1

Hose Clamps

Hose Clamps have stainless steel housings and bands. The screws are plated steel and have slotted hex heads allowing a socket wrench, nut driver, or screwdriver to be used.



CATALOG NO.	DESCRIPTION	SAE NO.	SAE DIAMETER RANGE (in.)	APPROX. RANGE (in.)	UOM	ORDER MULTIPLE
HC6202	Hose Clamps, pack of 6	*	N/A	1/4 to 5/8	PK	1
HC6203	Hose Clamps, pack of 6	6	.44 - .78	5/16 to 7/8	PK	1
HC5410	Hose Clamps, pack of 6	10	.56 - 1.06	9/16 to 1-1/8	PK	1
HC5410X	Hose Clamps, pack of 10	10	.56 - 1.06	9/16 to 1-1/8	PK	1
HC5416	Hose Clamps, pack of 6	16	.81 - 1.50	3/4 to 1-1/2	PK	1
HC5416X	Hose Clamps, pack of 10	16	.81 - 1.50	3/4 to 1-1/2	PK	1
HC5420	Hose Clamps, pack of 6	20	.81 - 1.75	13/16 to 1-3/4	PK	1
HC5424	Hose Clamps, pack of 6	24	1.06 - 2.00	1-1/16 to 2	PK	1
HC5436	Hose Clamps, pack of 4	36	1.81 - 2.75	1-1/2 to 2-3/4	PK	1
HC5436X	Hose Clamps, pack of 10	36	1.81 - 2.75	1-1/2 to 2-3/4	PK	1

Nylon Rods

These nylon rods can be used with load bearing capability. Used for smaller machined parts, such as electrical insulators and food contact parts.

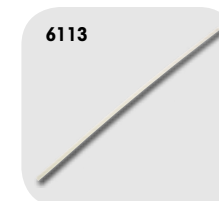

CATALOG NO.	DESCRIPTION	DIAMETER	THREADS (in.)	LENGTH	UOM	ORDER MULTIPLE
6113	Nylon Rods; All-Thread, pack of 4	3/8"	16	2'	PK	1

Set Screws

Set Screws have cup points and hex socket heads. Class 3A threads. Made of heat treated alloy steel.



CATALOG NO.	DESCRIPTION	SIZE	UOM	ORDER MULTIPLE
6002	Set Screws, pack of 33	#8-32 x 3/16"	PK	1
6003	Set Screws, pack of 25	#10-32 x 3/16"	PK	1
6004	Set Screws, pack of 27	1/4"-28 x 1/4"	PK	1
6006	Set Screws, pack of 19	5/16"-18 x 5/16"	PK	1
6007	Set Screws, pack of 14	3/8"-16 x 3/8"	PK	1
6000	Large Assortment; course thread	1/4"-20; 5/16"-18; 3/8"-16	EA	1
6001	Small Assortment; fine thread	#8-32; #10-32; 1/4"-28	EA	1

SPECIALTY FITTINGS

Grease Fittings

Case hardened steel fittings plated with yellow dip chromate and built-in ball checks. Assortment available in clear plastic box.

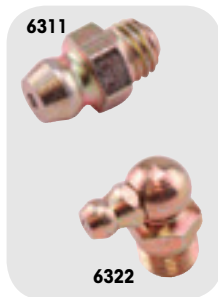

CATALOG NO.	DESCRIPTION	UOM	ORDER MULTIPLE
6311	Grease Fittings: 1/4"-28 Tapered Thread; straight, pack of 8	PK	1
6312	Grease Fittings: 1/8" Pipe Thread; straight, pack of 5	PK	1
6321	Grease Fittings: 1/4"-28 Tapered Thread; 90°, pack of 3	PK	1
6322	Grease Fittings: 1/8" Pipe Thread; 90°, pack of 3	PK	1
6310X	Assortment includes: 6311, 6312, 6321, 6322	EA	1

STORAGE CONTAINERS

Metal Parts Boxes

Metal Parts Boxes are prime cold rolled steel with baked gray enamel finish. The finish is rust and acid resistant. Each box comes with high impact plastic tray, positive pull down catch, and stick back parts labels for lid interiors.



CATALOG NO.	DESCRIPTION	NO. OF COMPARTMENTS	DIMENSIONS (L x W x D)	UOM	ORDER MULTIPLE
8200M	Metal Parts Box	21	13-3/8" x 9-1/4" x 2"	EA	1
8220M	Metal Parts Box	24	18" x 12" x 3"	EA	1

Satchel Style Case

Parts box made from rugged copolymer material with high impact translucent lid and handle on the side. 15 removable dividers allow up to 24 compartments.



CATALOG NO.	DESCRIPTION	NO. OF COMPARTMENTS	DIMENSIONS (L x W x D)	UOM	ORDER MULTIPLE
8233	Satchel Style Case	Up to 24	15" x 11-3/4" x 2-1/2"	EA	1

Styrene Parts Boxes

This box is ideal for holding your different sized nuts and bolts along with your additional bits. It can be stored in a tool box as well.



CATALOG NO.	DESCRIPTION	COLOR	NO. OF COMPARTMENTS	DIMENSIONS (L x W x D)	UOM	ORDER MULTIPLE
8207	Styrene Parts Box	Clear	4	4-7/8" x 3-1/4" x 1-1/8"	EA	1
8208	Styrene Parts Box	Clear	6	4-7/8" x 3-1/4" x 1-1/8"	EA	1

Polypropylene Parts Boxes

This box is ideal for holding your different sized nuts and bolts along with your additional bits. It can be stored in a tool box as well.

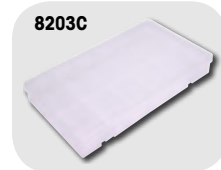

CATALOG NO.	DESCRIPTION	COLOR	NO. OF COMPARTMENTS	DIMENSIONS (L x W x D)	UOM	ORDER MULTIPLE
8201	Polypropylene Parts Box	Yellow	13	11" x 6-3/4" x 1-1/4"	EA	1
8201C	Polypropylene Parts Box Translucent		13	11" x 6-3/4" x 1-1/4"	EA	1
8202	Polypropylene Parts Box	Yellow	18	11" x 6-3/4" x 1-1/4"	EA	1
8203	Polypropylene Parts Box	Yellow	24	11" x 6-3/4" x 1-1/4"	EA	1
8203C	Polypropylene Parts Box Translucent		24	13-1/8" x 9" x 2-5/8"	EA	1

TAPES

Tape

Vinyl electrical tape. Part 5247 holds up to 7 pounds per square inch when attached to steel surface.



CATALOG NO.	DESCRIPTION	LENGTH	UOM	ORDER MULTIPLE
5255	Vinyl Electrical Tape	3/4" x 60'	EA	1

Teflon® Tape

This PTFE Tape is made of non toxic, pure white PTFE. The tape can be used with chemicals, solvents, oxygen, and on food lines. The product can withstand up to 2000 psi of pressure.



CATALOG NO.	DESCRIPTION	LENGTH	UOM	ORDER MULTIPLE
5246	Teflon® Thread Seal Tape	1/2" x 520"	EA	1



TESTERS, LEADS, CLIPS, FUSES

Clips

The clips are alligator clips and have vinyl red and black insulators.



CATALOG NO.	DESCRIPTION	UOM	ORDER MULTIPLE
5033	Steel Alligator Clips for use with test probes (.075"-.080"); 1-31/32" long; jaws open 5/16" max.; pack of 2 red, 2 black, 4 clips	PK	1
5035	Copper Alligator Clips; 1-31/32" long; jaws open 5/16" max.; crimper slotted screw connection, pack of 2 red, 2 black, 4 clips	PK	1
5036	Steel Test Clips; 20A, 2-7/16" long; jaws open 5/8" max.; crimper slotted screw connection, pack of 1 red, 1 black, 2 clips	PK	1

Blade (Auto) Fuses

These fuses are used to protect circuits in the wiring harness that are usually found under the hood, in a fuse panel or supplementary panel near the battery. MAX fuses are used in domestic and import vehicles.

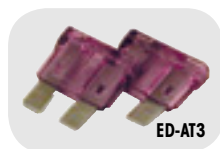

CATALOG NO.	DESCRIPTION	UOM	ORDER MULTIPLE
ED-AT3	Blade Fuse – 3 Amp – Purple, pack of 10	PK	1
ED-AT5	Blade Fuse – 5 Amp – Tan, pack of 10	PK	1

Test Leads

These are replacement leads.



CATALOG NO.	DESCRIPTION	UOM	ORDER MULTIPLE
5031	Low Voltage Test Leads; eight 22" long, color-coded leads with fully insulated alligator clips	EA	1
5041	Small Hook Type Low Voltage Test Leads; retractable hooks, 36" thermoplastic 22 gauge wire, nylon body/plunger, red/black	EA	1
5042	Large Hook Type Low Voltage Test Leads; retractable hooks, 36" PVC insulated 20 gauge wire, nylon body/plunger, red/black	EA	1
5046	Flexible Test Leads; steel alligator clips with vinyl red and black insulators; 36" 20 gauge wire; extremely flexible	EA	1

Dual Element Fuses – 250V

Provides time delay for temporary over-current conditions and motor running protection for heating and air conditioning equipment. Eliminates unnecessary maintenance from harmless overloads.



CATALOG NO.	DESCRIPTION	UOM	ORDER MULTIPLE
ED-CR15	Dual Element Fuse – 15 Amps, pack of 2	PK	1
ED-CR20	Dual Element Fuse – 20 Amps, pack of 2	PK	1
ED-CR25	Dual Element Fuse – 25 Amps, pack of 2	PK	1
ED-CR30	Dual Element Fuse – 30 Amps, pack of 2	PK	1
ED-CR35	Dual Element Fuse – 35 Amps, pack of 2	PK	1
ED-CR40	Dual Element Fuse – 40 Amps, pack of 2	PK	1
ED-CR45	Dual Element Fuse – 45 Amps, pack of 2	PK	1
ED-CR50	Dual Element Fuse – 50 Amps, pack of 2	PK	1
ED-CR60	Dual Element Fuse – 60 Amps, pack of 2	PK	1

U.L. Class RK-5, Standard for Safety 198E, Current Limiting Fuses, Interrupting Rating 200,000 Amps. rms. A.C.

WIRE

TFFN Stranded Hook-Up Wire*

Packaged in handy dispenser bag. Polyvinyl chloride insulation. Wire rating: 600V, 90°C. Insulation: oil resistant nylon coating.



CATALOG NO.	COLOR	GAUGE	STRANDS	O.D.	LENGTH	UOM	ORDER MULTIPLE
60331B	Black, pack of 50'	18	16	.09"	48'	PK	1
60331BE	Blue, pack of 50'	18	16	.09"	48'	PK	1
60331R	Red, pack of 50'	18	16	.09"	48'	PK	1
6332B	Black, pack of 50'	16	26	.10"	48'	PK	1
6332G	Green, pack of 50'	16	26	.10"	48'	PK	1
6332R	Red, pack of 50'	16	26	.10"	48'	PK	1
6332W	White, pack of 50'	16	26	.10"	48'	PK	1

THHN Stranded Hook-Up Wire*

Packaged in handy dispenser bag. Polyvinyl chloride insulation. Wire rating: 600V, 90°C. Insulation: oil resistant nylon coating.

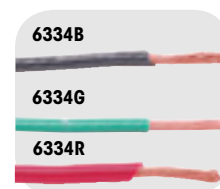

CATALOG NO.	COLOR	GAUGE	STRANDS	O.D.	LENGTH	UOM	ORDER MULTIPLE
6333B	Black, pack of 50'	14	19	.11"	48'	PK	1
6333G	Green, pack of 50'	14	19	.11"	48'	PK	1
6333R	Red, pack of 50'	14	19	.11"	48'	PK	1
6333W	White, pack of 50'	14	19	.11"	48'	PK	1
6334B	Black, pack of 50'	12	19	.13"	48'	PK	1
6334G	Green, pack of 50'	12	19	.13"	48'	PK	1
6334R	Red, pack of 50'	12	19	.13"	48'	PK	1
6334W	White, pack of 50'	12	19	.13"	48'	PK	1
6335B	Black, pack of 50'	10	19	.17"	48'	PK	1
6335G	Green, pack of 50'	10	19	.17"	48'	PK	1
6335R	Red, pack of 50'	10	19	.17"	48'	PK	1
6335W	White, pack of 50'	10	19	.17"	48'	PK	1
6360B	Black, pack of 50'	8	19	.22"	25'	PK	1
6360R	Red, pack of 50'	8	19	.22"	25'	PK	1
6360W	White, pack of 50'	8	19	.22"	25'	PK	1

WIRE cont'd

Thermostat Wire*

Thermoplastic insulated, jacketed wire for low voltage applications. Conductors are solid copper, individually insulated and color coded.



CATALOG NO.	DESCRIPTION	CONDUCTORS	WIRE GAUGE	LENGTH	UOM	ORDER MULTIPLE
6331	Thermostat Wire, pack of 40'	2	20	40'	PK	1
6336	Thermostat Wire, pack of 40'	3	20	40'	PK	1
6330-4	Thermostat Wire, pack of 40'	4	20	40'	PK	1
6337	Thermostat Wire, pack of 40'	5	20	40'	PK	1
6330-6	Thermostat Wire, pack of 40'	6	20	40'	PK	1
6338	Thermostat Wire, pack of 40'	8	20	40'	PK	1
6339	Thermostat Wire, pack of 25'	10	20	25'	PK	1
6339XL	Thermostat Wire, pack of 40'	10	20	40'	PK	1

High Temperature Range Wire*

200°C glass braided, three conductor twisted wire. 600V; silicone rubber insulated. This product also contains a crimper.



CATALOG NO.	COLOR	WIRE GAUGE	LENGTH	UOM	ORDER MULTIPLE
6383-35	Black, Red, and White, pack of 5'	14	5'	PK	1
6383-325	Black, Red, and White, pack of 25'	14	25'	PK	1
6384-35	Black, Red, and White, pack of 5'	12	5'	PK	1
6384-325	Black, Red, and White, pack of 25'	12	25'	PK	1

SJTO Service Cord*

Features stranded bare copper, PVC insulation; PVC jacket. Cord is oil resistant. Cords have 3 individually insulated conductors. Ratings: 300V; 60°C.

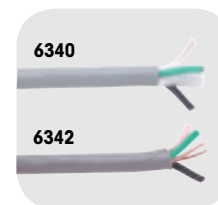

CATALOG NO.	DESCRIPTION	WIRE GAUGE	LENGTH	UOM	ORDER MULTIPLE
6340	SJTO Service Cord, pack of 12'	16	12'	PK	1
6341	SJTO Service Cord, pack of 20'	16	20'	PK	1
6342	SJTO Service Cord, pack of 12'	14	12'	PK	1
6343	SJTO Service Cord, pack of 20'	14	20'	PK	1

Stranded High Temperature Wire*

Thermoplastic equipment insulated wire. CSA listed at 105°C; 600V. Insulation thickness: .03". MTW/AWM/TEW

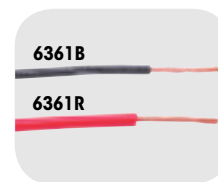

CATALOG NO.	COLOR	GAUGE	STRANDS	O.D.	LENGTH	UOM	ORDER MULTIPLE
6361B	Black, pack of 48'	18	16	.113"	48'	PK	1
6361R	Red, pack of 48'	18	16	.113"	48'	PK	1
6362B	Black, pack of 48'	16	26	.125"	48'	PK	1
6362R	Red, pack of 48'	16	26	.125"	48'	PK	1
6362W	White, pack of 48'	16	26	.125"	48'	PK	1
6363B	Black, pack of 48'	14	19	.139"	48'	PK	1
6363R	Red, pack of 48'	14	19	.139"	48'	PK	1
6363W	White, pack of 48'	14	19	.139"	48'	PK	1
6364B	Black, pack of 48'	12	19	.158"	48'	PK	1
6364R	Red, pack of 48'	12	19	.158"	48'	PK	1
6364W	White, pack of 48'	12	19	.158"	48'	PK	1
6365B	Black, pack of 48'	10	19	.182"	48'	PK	1
6365R	Red, pack of 48'	10	19	.182"	48'	PK	1
6365W	White, pack of 48'	10	19	.182"	48'	PK	1

WIRING DEVICES

Thermoplastic Handle Plug*

This plug is a standard grade with flexible spring prongs and is furnished with a face washer. This product's rating is a 15A 125V and also contains a crimper.



CATALOG NO.	DESCRIPTION	MAX. CORD DIAMETER	POLES	WIRES	MATERIAL	UOM	ORDER MULTIPLE
ED179	Handle Plug	.406"	2	2	Thermoplastic	EA	1

Grounding Rubber Handle Plug*

The rubber back design allows for sure grip and protection against dirt and moisture entry. This plug is designed to operate in the widest possible temperature ranges.



CATALOG NO.	DESCRIPTION	FITS CORD DIAMETER	POLES	WIRES	RATING	UOM	ORDER MULTIPLE
ED1703	Grounding Handle Plug	.25"-.60"	2	3	20A-250V	EA	1
ED1709	Grounding Handle Plug	.25"-.60"	2	3	15A-125V	EA	1

*Items in this section are Underwriter's Laboratories listed or recognized under the prime manufacturer's name.



WIRING DEVICES cont'd

Tandem Grounding Rubber Handle Plug*

The rubber back design allows for sure grip and protection against dirt and moisture entry. This plug is designed to operate in the widest possible temperature ranges



CATALOG NO.	DESCRIPTION	FITS CORD DIAMETER	POLES	WIRES	RATING	UOM	ORDER MULTIPLE
ED1711	Tandem Handle Plug	.25"-.60"	2	3	15A-250V	EA	1

Armored Plug*

This plug has a round dead front and is vinyl enclosed.



CATALOG NO.	DESCRIPTION	FITS CORD DIAMETER	POLES	WIRES	RATING	UOM	ORDER MULTIPLE
ED2867	Armored Plug	.25"-.625"	2	3	15A-125V	EA	1

Right Angle Plug*

Our right angle plug is ergonomically designed fluted body with radial gripping ridge creates an ideal surface for gripping and pulling.



CATALOG NO.	DESCRIPTION	FITS CORD DIAMETER	POLES	WIRES	RATING	UOM	ORDER MULTIPLE
ED4409	Right Angle Plug	.25"-.655"	2	3	20A-125V	EA	1
ED4509	Right Angle Plug	.25"-.655"	2	3	20A-250V	EA	1
ED4867	Right Angle Plug	.25"-.655"	2	3	15A-125V	EA	1

Rubber Connector*

This is a standard grade rubber connector with a 3 pole opening.



CATALOG NO.	DESCRIPTION	FITS CORD DIAMETER	POLES	WIRES	RATING	UOM	ORDER MULTIPLE
ED252	Rubber Connector	.25"-.60"	2	3	15A-125V	EA	1

Armored Connector*

The Armor Connector is ideal for shops, garages, and heavier duty work areas. Vinyl enclosed.



CATALOG NO.	DESCRIPTION	FITS CORD DIAMETER	POLES	WIRES	RATING	UOM	ORDER MULTIPLE
ED2887	Armored Connector	.225"-.60"	2	3	15A-125V	EA	1

Ground Adapter*

This adapter is polarized with 2 pole to 3 wire grounding. The body is made of polypropylene.



CATALOG NO.	DESCRIPTION	RATING	UOM	ORDER MULTIPLE
ED419	Ground Adapter	15A-125V	EA	2

Triple Outlets*

These outlets are polarized and are made of high impact resistant plastic.



CATALOG NO.	DESCRIPTION	RATING	UOM	ORDER MULTIPLE
5223	Heavy duty, 2 pole, 3 wire	15A-125V	EA	1

Power Supply Replacement Cords*

For power tools or appliances. Black vinyl cord is flexible in very cold environments. Wire type is SJEW-A.



CATALOG NO.	DESCRIPTION	WIRE	RATING	LENGTH	UOM	ORDER MULTIPLE
5240	Black Replacement Cord	16/3	13A/125V	10'	EA	1
5242	Black Replacement Cord	14/3	15A/125V	10'	EA	1

*Items in this section are Underwriter's Laboratories listed or recognized under the prime manufacturer's name.



WIRING DEVICES cont'd

Receptacles*

Our receptacles are available in either singles or duplexes. This is a 2 pole, 3 wire product with ground included. Standard Grade.



CATALOG NO.	DESCRIPTION	RATING	COLOR	UOM	ORDER MULTIPLE
ED1876	Single Receptacle	20A-250V	Brown	EA	1
ED1876-I	Single Receptacle	20A-250V	Ivory	EA	1
ED1877	Single Receptacle	20A-125V	Brown	EA	1
ED270**	Duplex Receptacle	15A-125V	Brown	EA	1
ED270-I**	Duplex Receptacle	15A-125V	Ivory	EA	1
ED877	Duplex Receptacle	20A-125V	Brown	EA	1

**Standard Grade

Metal Bat Handle Toggle Switches*

Features black phenolic plastic case; brass terminals; steel and zinc chromate frame and support; all other external parts are brass/bright nickel. These heavy duty toggle switches have screw terminals. Part ED447 has an "ON-OFF" face plate.

Specifications: 10A/277V-20A/125V AC
Single Pole: 3/4HP 125-250V AC
Double Pole: 1-1/2HP 125-250V AC



CATALOG NO.	DESCRIPTION	SEQUENCE	CIRCUIT	UOM	ORDER MULTIPLE
ED447	Bat Handle Toggle Switch	ON-OFF	Single Pole, Single Throw	EA	1
ED453	Bat Handle Toggle Switch	ON-ON	Double Pole, Double Throw	EA	1
ED454	Bat Handle Toggle Switch	ON-ON	Single Pole, Double Throw	EA	1
ED455	Bat Handle Toggle Switch	ON-OFF	Double Pole, Single Throw	EA	1
ED468	Bat Handle Toggle Switch	ON-OFF-ON	Single Pole, Double Throw	EA	1
ED494	Bat Handle Toggle Switch	ON-OFF-ON	Double Pole, Double Throw	EA	1
ED448B	Bat Handle Toggle Switch	ON-OFF	Single Pole, Single Throw	EA	1

Toggle Switch with Neon Pilot Light Combination Device*

Switch: 15A-120V AC
Neon Pilot Light: 1/25W, 120V AC



CATALOG NO.	DESCRIPTION	UOM	ORDER MULTIPLE
ED277	Toggle Switch with Neon Pilot Light - Brown Body	EA	1

Utility Fuse Outlets*

This is designed to break up electrical surges on equipment.



CATALOG NO.	DESCRIPTION	UOM	ORDER MULTIPLE
PI381	Utility Fuse Outlet and Switch with Cover; 1/2HP-125V AC only; galvanized steel construction	EA	1

Toggle Switch and Receptacle Combination Device*

This device is a single pole switch with 15A 120V AC. The receptacle is 15A 125V AC and it is a 2 pole, three wire grounding.



CATALOG NO.	DESCRIPTION	UOM	ORDER MULTIPLE
ED5225	Toggle Switch and Receptacle - Brown Body	EA	1

Toggle Switches*

Our toggle switch is a silent switch with ground included. Standard Grade.



CATALOG NO.	DESCRIPTION	RATING	COLOR	UOM	ORDER MULTIPLE
ED1240-2	Single Pole	15A-120/277V AC	Brown	EA	1
ED1238	Single Pole	20A-120/277V AC	Brown	EA	1
ED1301**	Single Pole	15A-120V AC	Brown	EA	1
ED1301-I**	Single Pole	15A-120V AC	Ivory	EA	1
ED1262-2	Double Pole	15A-120/277V AC	Brown	EA	1
ED1262-2I	Double Pole	15A-120/277V AC	Ivory	EA	1
ED1232	Double Pole	30A-120/277V AC	Brown	EA	1

**Standard Grade

Porcelain Outlet Box Lampholders*

Features one-piece pull chain. Two screw terminals, 2 pole, 2 wire. 4-1/2" outer diameter. These lamp holders fit 3-1/4" and 4" boxes. Rating: Lampholder: 660W/125V. Outlet: 15A/125V.



CATALOG NO.	DESCRIPTION	UOM	ORDER MULTIPLE
ED9726	Porcelain Outlet Box Lampholder - U ground outlet	EA	1

*Items in this section are Underwriter's Laboratories listed or recognized under the prime manufacturer's name.



WIRING DEVICES cont'd

Fuse Holders

Used to mount and protect fuses, fuse holders also enable fuses to be changed quickly and easily. Fuse holders are used in a variety of applications, including consumer electronics, industrial, telecom and datacom, automotive, and many others.

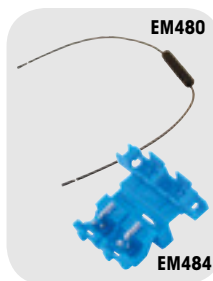

CATALOG NO.	DESCRIPTION	UOM	ORDER MULTIPLE
EM480	In-Line Fuse Holder for use with 1-1/4 x 1/4" fuses up to 20 amps, 32 volts, 15" lead; 14 gauge red vinyl insulated wire	EA	1
EM484	Self-Stripping Fuse Holder mates with blade-type fuse .205 x .025". 18-14 AWG. Size: 1.37" L x .44" H x .95" W Max. Insulation Outer Diameter: .145"	EA	2

Vinyl Grommet Assortment Packs

These grommets exhibit high dielectric strength and are oil, ozone, and UV resistant.



CATALOG NO.	DESCRIPTION	UOM	ORDER MULTIPLE
ED320	General Assortment – contains all grommet sizes	EA	1

Heat Shrink Tubing*

Heat Shrink Tubing is made of flame-retardant polyolefin. Thin walled, all purpose tubing. Rated 600V, 125°C. 2500 volts/mil. dielectric strength. Inert to fungus. Virtually unaffected by corrosives, common fluids, and solvents. Pieces are 6" in length.



CATALOG NO.	COLOR	INNER DIAMETER		UOM	ORDER MULTIPLE
		MAX SUPPLIED	MIN. RECOVERED		
63076B	Black, pack of 10	3/8"	3/16"	PK	1
63077B	Black, pack of 10	1/2"	1/4"	PK	1

Heat Shrink Tubing Assortments*

Heat Shrink Tubing is made of flame-retardant polyolefin. Thin walled, all purpose tubing. Rated 600V, 125°C. 2500 volts/mil. dielectric strength. Inert to fungus. Virtually unaffected by corrosives, common fluids, and solvents. Pieces are 6" in length.



CATALOG NO.	COLOR	INNER DIAMETER		UOM	ORDER MULTIPLE
		MAX SUPPLIED	MIN. RECOVERED		
6370	Black & White, pack of 12	1/8", 1/4"	1/16", 1/8"	PK	1
6371	Black & White, pack of 7	1/8", 1/4", 3/8"	1/16", 1/8", 3/16"	PK	1
63070	Black, pack of 3	3/8" – 1/2"	3/16" – 1/4"	PK	1

6180 Series Terminal Blocks*

These terminal blocks are constructed of high barrier thermoplastic are rated 20A 250V.

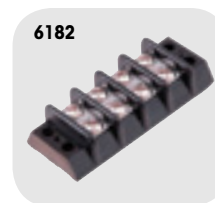

CATALOG NO.	DESCRIPTION	NO. OF POSITIONS	LENGTH (in.)	WIDTH (in.)	SCREW SIZE	MAX. WIRE SIZE	UOM	ORDER MULTIPLE
6182	Terminal Block	4	2.16	.88	6-32	22-14	EA	1
6183	Terminal Block	6	2.91	.88	6-32	22-14	EA	1
6184	Terminal Block	8	3.66	.88	6-32	22-14	EA	1
6185	Terminal Block	10	4.41	.88	6-32	22-14	EA	1
6186	Terminal Block	12	5.16	.88	6-32	22-14	EA	1
6187	Terminal Block	14	5.91	.88	6-32	22-14	EA	1

6190 Series Terminal Blocks*

These terminal blocks are constructed of phenolic 9/16in. centers. They are rated 30A 600V.



CATALOG NO.	DESCRIPTION	NO. OF POSITIONS	LENGTH (in.)	WIDTH (in.)	SCREW SIZE	MAX. WIRE SIZE	UOM	ORDER MULTIPLE
6193	Terminal Block	6	4.34	1.31	8-32	14-12	EA	1
6194	Terminal Block	8	5.47	1.31	8-32	14-12	EA	1
6195X	Terminal Block	10	6.59	1.31	8-32	14-12	EA	1

Terminal Block Jumpers*

These jumpers connect two positions on a terminal block and are made of nickel plated brass.



CATALOG NO.	DESCRIPTION	UOM	ORDER MULTIPLE
6278CX	Jumpers for Terminal Block 6180 Series, pack of 100	PK	1

WIRING DEVICES cont'd

Indicator Lights

Terminals are tin plated brass. Wire leads are 22 AWG, 4.4–4.8" long, 1/2" stripped. Mounting will snap-fit into .500–.505 diameter hole in .020–.100" thick panels.



Indicator Lights*

Terminals are tin plated brass. Wire leads are 22 AWG, 4.4–4.8" long, 1/2" stripped. .31" minimum diameter mounting.



CATALOG NO.	LENS COLOR	LENS MATERIAL	VOLTAGE	BULB TYPE	UOM	ORDER MULTIPLE
ED600	Red, pack of 2	Polycarbonate	28V	Incandescent	PK	1
ED601	Green, pack of 2	Polycarbonate	28V	Incandescent	PK	1
ED602	Amber, pack of 2	Polycarbonate	28V	Incandescent	PK	1
ED603	Blue, pack of 2	Polycarbonate	28V	Incandescent	PK	1
ED610	Red, pack of 2	Nylon	105–125V AC	Neon	PK	1
ED611	Green, pack of 2	Polycarbonate	105–125V AC	Neon**	PK	1
ED612	Amber, pack of 2	Nylon	105–125V AC	Neon	PK	1
ED613	Blue, pack of 2	Polycarbonate	105–125V AC	Neon†	PK	1
ED620	Red, pack of 2	Polycarbonate	208–250V AC	Neon	PK	1
ED621	Green, pack of 2	Polycarbonate	208–250V AC	Neon**	PK	1

CATALOG NO.	LENS COLOR	LENS MATERIAL	VOLTAGE	BULB TYPE	UOM	ORDER MULTIPLE
ED710	Red, pack of 2	Polycarbonate	105–125V AC	Neon	PK	1

Standard Wire Connectors*

Connectors are color coded with spring inserts. Heat resistant (105°C) thermoplastic. Connectors are for copper to copper connections. Parts 6294 and 6296 can connect aluminum to aluminum and copper to aluminum (dry locations only).



Winged Wire Connectors*

Durable thermoplastic material. Flame retardant, abrasion resistant, non porous, and non corrosive. Expandable spring grips into the wire and adjusts itself to the wire size and shape so pre twisting is unnecessary. Even during temperature changes, they resist vibrations and retain holding power. Parts 8284 and 8286 are for use with copper to copper, aluminum to aluminum, and copper to aluminum (dry locations only).



CATALOG NO.	DESCRIPTION	UOM	ORDER MULTIPLE
6291	Mini Gray Standard Wire Connectors, pack of 29	PK	1
6291CX	Mini Gray Standard Wire Connectors, pack of 100	PK	1
6292	Tiny Blue Standard Wire Connectors, pack of 25	PK	1
6292CX	Tiny Blue Standard Wire Connectors, pack of 100	PK	1
6293	Small Orange Standard Wire Connectors, pack of 20	PK	1
6293CX	Small Orange Standard Wire Connectors, pack of 100	PK	1
6294	Medium Yellow Standard Wire Connectors, pack of 18	PK	1
6294CX	Medium Yellow Standard Wire Connectors, pack of 100	PK	1
6296	Large Red Standard Wire Connectors, pack of 12	PK	1
6296CX	Large Red Standard Wire Connectors, pack of 100	PK	1
6298	X-Large Gray Standard Wire Connectors, pack of 6	PK	1
6298LX	X-Large Gray Standard Wire Connectors, pack of 50	PK	1
6295X	Assortment: Includes 6291, 6292, 6293, 6294, 6296	EA	1

CATALOG NO.	DESCRIPTION	UOM	ORDER MULTIPLE
8284	Small Yellow Winged Wire Connectors, pack of 18	PK	1
8284CX-B	Small Yellow Winged Wire Connectors, pack of 100	PK	1
8286	Medium Red Winged Wire Connectors, pack of 14	PK	1
8286CX-B	Medium Red Winged Wire Connectors, pack of 100	PK	1
8282LX	X-Large Blue Winged Wire Connectors, pack of 50	PK	1

-B indicates boxed product. All other catalog numbers are poly bagged.

Porcelain Wire Connectors*

For high temperature applications over 105°C (300 volts maximum). For stranded copper connections only.



CATALOG NO.	DESCRIPTION	UOM	ORDER MULTIPLE
4293	Small White Porcelain Wire Connectors, pack of 17	PK	1
4293CX	Small White Porcelain Wire Connectors, pack of 100	PK	1
4294	Medium White Porcelain Wire Connectors, pack of 15	PK	1
4294CX	Medium White Porcelain Wire Connectors, pack of 100	PK	1
4296	Large White Porcelain Wire Connectors, pack of 13	PK	1
4296CX	Large White Porcelain Wire Connectors, pack of 100	PK	1

Aluminum Solderless Lugs*

Our aluminum solder less lug are made from high strength aluminum alloy. These lugs are suitable for use with either copper or aluminum conductors.



CATALOG NO.	DESCRIPTION	WIRE RANGE	AMP RATING	UOM	ORDER MULTIPLE
PI221	Small Lug for aluminum or copper wire, pack of 6	4-14	2	PK	1
PI222	Large Lug for aluminum or copper wire, pack of 6	2-14	2	PK	1

*Items in this section are Underwriter's Laboratories listed or recognized under the prime manufacturer's name.

**Neon bulb incorporates G2B lamp and resistor.

† Neon bulb incorporates T2B lamp and resistor.



WIRING DEVICES cont'd

Electrolytic Copper Solderless Lugs*

Our solder less lugs are manufactured from high strength pure electrolytic copper to insure both maximum strength and conductivity.



CATALOG NO.	DESCRIPTION	WIRE RANGE	AMP RATING	UOM	ORDER MULTIPLE
PI226	Small Lug for copper wire, pack of 6	10-14	25	PK	1
PI227	Medium Lug for copper wire, pack of 6	6-14	35-50	PK	1
PI228	Large Lug for copper wire, pack of 6	4-14	70	PK	1

Pigtails

The wire has a #10 spade on one end and a 10 32 x 3/8in. slotted round head screw on the other. This allows for easy positioning in the outlet box.

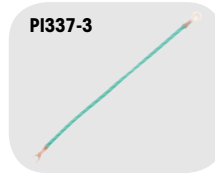

CATALOG NO.	DESCRIPTION	WIRE LENGTH	WIRE GAUGE	WIRE TYPE	UOM	ORDER MULTIPLE
PI337-3	Pigtails, pack of 5	8"	14	Stranded	PK	1

Cable Markers

Cable markers come in books of 450 markers with matching terminal markers. Markers are mounted on dispenser cards in the book. Cable markers are suitable for above and below ground applications. Books are made of vinyl impregnated cloth that resists moderate amounts of dirt, oil and heat. The blank Write-On Markers (WM1014) are made of durable vinyl film that resists water, oils, and fungus. They can also withstand extremes in temperature.



CATALOG NO.	DESCRIPTION	UOM	ORDER MULTIPLE
WM1002	Alpha-Numeric Cable Marker Book; contains 10 each: A-Z, 0-15, +, -, /	EA	1
WM1003	Numeric Cable Marker Book; contains 10 each: 1-45	EA	1
WM1009	Line and Terminal Cable Marker Book; contains 45 each: 1, 2, 3, A, B, C; contains 30 each: T1, T2, T3, L1, L2, L3	EA	1
WM1014	180 Blank Write-On Markers, 1/2" x 1-1/2"	EA	1

Split Bolt Connectors*

These connectors are made of silicone bronze and are designed for copper use only.



CATALOG NO.	DESCRIPTION	MAX. SOLID WIRE	MAX. STRANDED WIRE	UOM	ORDER MULTIPLE
PI326	Split Bolt Connector, pack of 3	10	12	PK	1
PI327	Split Bolt Connector, pack of 3	8	8	PK	1
PI328	Split Bolt Connector, pack of 3	6	7	PK	1
PI929	Split Bolt Connector, pack of 3	4	5	PK	1

Ground Fitting Clamp*

A ground fitting clamp is ideal for surface mounting small amounts of electrical wiring or communication cables.



CATALOG NO.	DESCRIPTION	UOM	ORDER MULTIPLE
PI237	For 8, 6, 4 bare grounding wire; fits 1/2"-1" pipe	EA	1

*Items in this section are Underwriter's Laboratories listed or recognized under the prime manufacturer's name.

ELECTRICAL

Bearings.....	142
Capacitors.....	146-147
Conduit, Fittings, Cable	144-145
Contactors.....	150-151
DiversiTech Electrical Disconnects.....	143
Eaton Electrical Disconnects.....	144
Electrical Supplies	156-158
Electrical Tapes	158
Fan Centers.....	152
Fuses	153-154
Hard Start Kits	149
Monitors.....	155
Motor Brackets	142
Motor Run Capacitors (USA Made).....	148-149
Motors	138-141
Relays.....	152
Stranded Copper THHN Wire	162-163
Terminals, Connectors.....	159
Thermal Controls	160
Thermostat Guards	161
Thermostat Wire	162
Thermostats	161
Time Delays	154
Transformers	151
Whips	142-143
Wire Connectors.....	163-164
Wire/Cable Ties, Mounts, Clamps	164-165



A/C Disconnect Switches

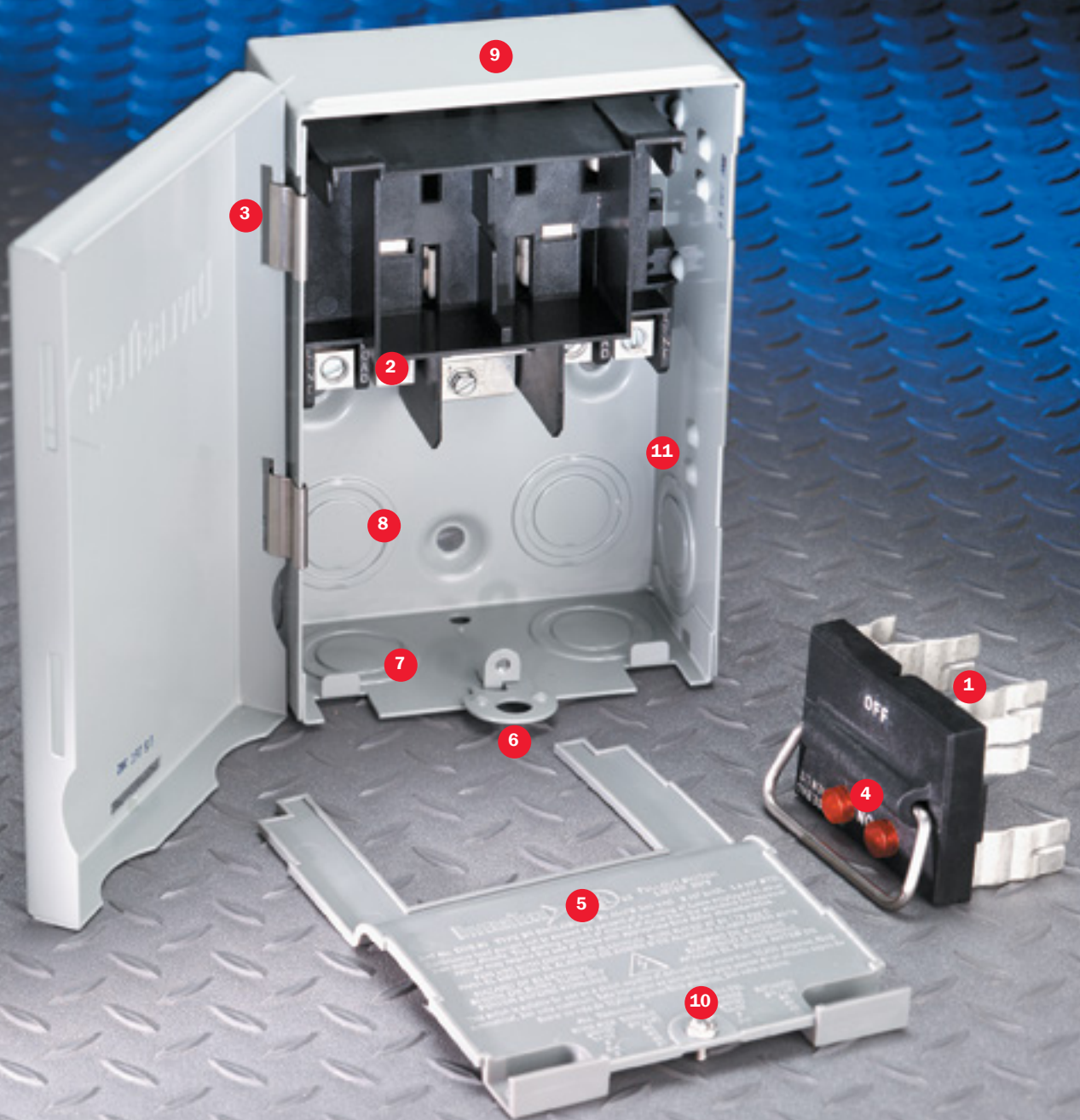

A/C DISCONNECT FEATURES AND BENEFITS

- 1 Fuses install into pull-out handle
- 2 Line, load, and ground terminals aligned for easy hook up with heavy wires
- 3 Reversible side-opening door
- 4 Indicator lights for blown fuses
- 5 Full dead front
- 6 Folding pivot locking tab
- 7 Knockouts accommodate three sizes (1/2", 3/4", and 1")
- 8 Rear entry knockouts
- 9 Heavy gauge steel case
- 10 Standard 1/4" head screw on dead front
- 11 Large internal wiring space



FUSES INSTALL INTO PULL-OUT HANDLE

The DiversiTech disconnect switch is available in two versions – fusible and non-fusible. On the fusible configuration, the pull-out handle also functions as a removable fuse holder. This feature permits easy removal and replacement of fuses. Rather than requiring a fuse puller to reach inside the disconnect switch and remove the blown fuses, one can easily change the fuses with the fuse holder removed from the disconnect switch.

INDICATOR LIGHT FOR BLOWN FUSE

The fusible disconnect switch has an indicator light for fuse condition. When a fuse is blown, the red indicator light illuminates to show not only that a fuse is bad, but specifically, which fuse needs replacement. This feature provides rapid troubleshooting for the contractor inspecting an installation. One can tell instantly (visually) whether a fuse is bad.



MOUNTING AND INLINE WIRING

A unique feature to the DiversiTech disconnect switch is the design of wiring terminals inline. This straight-line arrangement provides for quick and easy wire connection — no need to cut the connection wires to different lengths. All wires are easily installed without unnecessary bending or twisting.

REVERSIBLE SIDE OPENING DOOR

The unique reversible side opening door provides for easy field change from left-hand hinge to right-hand hinge. The standard left-hand hinge is adequate for most all installations except for tight, inside, right-hand corners. In these instances, simply remove the two stainless steel hinge clips and move them to the right-hand side. This permits the door to hinge on the right.



Fractional Horsepower Motors

FEATURES AND BENEFITS



COLOR PACKAGING

Bright, colorful, easy to read packaging removes confusion about motors. The distributor can easily identify the stock of motors on the shelf. The application, voltage, and horsepower of a motor are visible at a glance.



CARTON HANDLE

The motor carton has been designed with an innovative handle to make the motors much easier to carry.



CAPACITOR SIZE

The appropriate size 370 VAC run capacitor is noted on every motor carton.



LARGER DIAGRAM

An extra large wiring diagram is supplied on the motor itself, on the motor carton, and also in the installation and safety instruction sheet. This large wiring diagram makes it very easy to read.

CROSS REFERENCE GUIDE	
WG840728	
208-230 VAC	1/4 hp
MARS	03728
PACKARD	63128
GEMLINE	EM3728
MARATHON	X213
AD SMITH	F3E10295
FASCO	D809

CROSS REFERENCE

For your convenience, Wagner provides a complete manufacturer cross-reference on the side of every motor carton.



EXTENDED BOLTS

Extended mounting bolts provide for easier installation in cramped spaces. With the longer bolts, the installer is able to more easily start the threaded mounting nut.



BALL BEARINGS

Ball bearing design improves motor performance and reliability. It also increases heat endurance and motor life. Now standard on Condenser Fan Motor models.



REVERSING PLUG

The electrical reversing plug simplifies rotation direction changes.



Wagner Motors are available in many different versions to meet motor application needs.

- Direct Drive Furnace Blower Motors
- Multiple Horsepower Motors
- Condenser Fan Motors
- High Temperature Condenser Fan Motors



All Wagner Motors have a 2 year warranty.

MULTIPLE HORSEPOWER MOTORS

Multiple horsepower motors allow the contractor and distributor to consolidate multiple part codes into a single stocking unit. The multiple horsepower motor allows the contractor to carry one motor that can be used as a replacement for a wide variety of OEM and other replacement motors, saving time and money.



- All the features and benefits of standard motors
- Plus multiple horsepower
- Variety of voltages, applications, and speeds are available.



Evergreen®

EVER EFFICIENT. EVER RELIABLE. EVER PROFITABLE.



Simplify your Work.™

NOTE: Item numbers in **RED** indicate Made in the U.S.A.



Upgrade/Replace Indoor PSC Blower motors with Evergreen® IM



RESIDENTIAL/LIGHT COMMERCIAL HVAC SYSTEMS

- Reduce truck stock
- Increase energy savings
- Increase comfort and home health
- Decrease continuous fan noise and power consumption
- Easy drop-in replacement - connects directly to fan boards or relays
- Two year warranty

FURNACE AIR HANDLERS
INCLUDES PACKAGE SYSTEMS

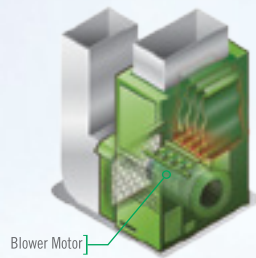

Blower Motor

Evergreen® IM

Replace Permanent Split Capacitor (PSC), direct drive, induction motors with the following ratings:

Horsepower: 1/4-1
RPM Rating: 1075
Voltage: 120 & 208-230
Rotation: CW & CCW



[PSC]

Replace OEM ECM X13 motors with Evergreen® EM



RESIDENTIAL/LIGHT COMMERCIAL HVAC SYSTEMS

- Replaces X13 and similar Constant Torque ECM
- Maintains system efficiency and performance
- Compatible with OEM harness
- Pre-programmed for truck stock
- No complex wiring or configuration
- Two year warranty

FURNACE AIR HANDLERS
INCLUDES PACKAGE SYSTEMS

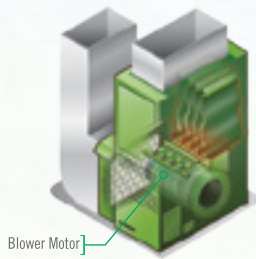

Blower Motor

Evergreen® EM

Replaces OEM Constant Torque ECM built with 24v speed taps with the following ratings:

Horsepower: 1/3-1
RPM Rating: 1070
Voltage: 115 or 208-230
Rotation: CW & CCW

[Constant Torque ECM Genteq X13 or Similar Competitors' Models]



Upgrade/Replace PSC Outdoor Fan motors with Evergreen® OM



- Drop-in replacement for induction motors
- Easy Retrofit - line voltage connections
- Quiet start and operation
- Dual rotation (CW/CCW)
- Efficiency up to 80%
- Two year warranty

A/C & HEAT PUMP UNITS
INCLUDES PACKAGE SYSTEMS

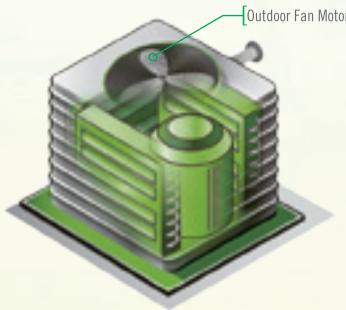

Outdoor Fan Motor

Evergreen® OM

[PSC]

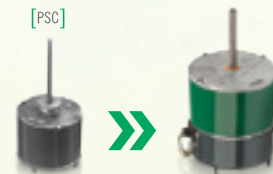

Digital 3-Phase Line Voltage Monitor

The DTP-3 is an automatic digital voltage monitor and control system.

By continuously measuring the incoming line voltage, the DTP-3 monitor will detect voltages outside of the tolerance that you set.

If these limits are exceeded, the response timer is started. This timer may be set to a long time value to avoid nuisance tripping, or to a short time value to offer a higher level of load protection.

If the voltage remains outside of the selected tolerance after the time has elapsed, the DTP-3 will turn off its output relay and protect your device. While the load is off, an additional lockout timer is activated to avoid rapid restarts.

- Read Line and Load Side Voltage Instantly
- Simple Three Button Access for Easy Monitoring and Set-Up
- Fault Memory Records Problems for Later Display
- Six Digital Voltmeters Built In
- Sequential Start Timer Built In
- Lock Out Timer Built In
- Response Timer Built In

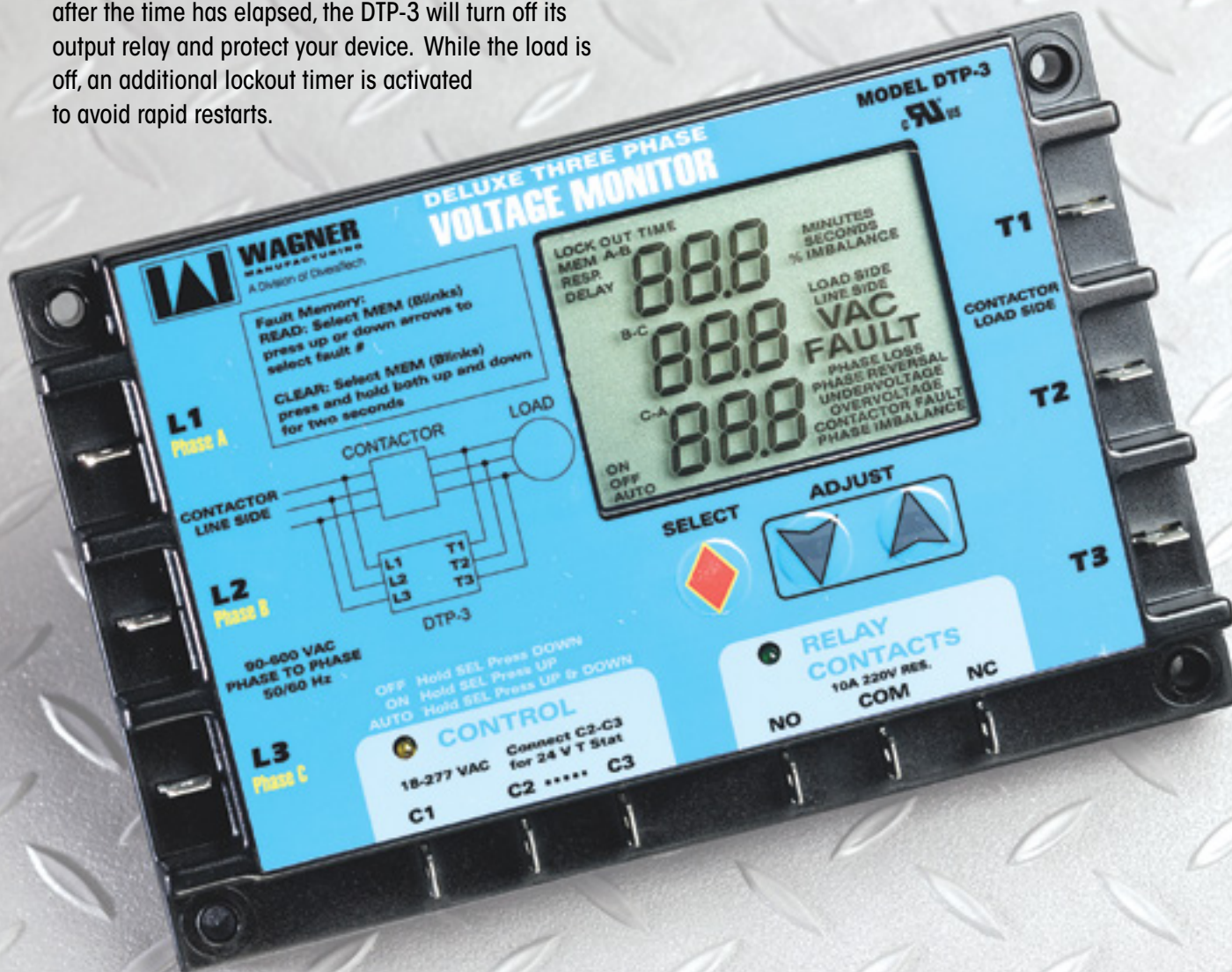

FEATURES AND BENEFITS

Large Digital LCD Display

Provides instant display of the system's operating voltage, not just indicator lights. System setup is simplified by using the display to set the exact voltage range you want to monitor. Other controls use dials for system adjustment that can lead to inaccurate settings and motor burnout.

Super Simple Operation

Just three buttons set up everything. Easy adjustment of voltage tolerance and timers.

Small Size

Small footprint and low profile fits where other can't.

10 Amp Rated Output Relay with Isolated Contacts

Powerful relay can connect to just about any control circuit. Normally-Open and Normally-Closed contacts are provided for connection to any type of system, motor control or alarm.

2 LED Indicators

Glowing light-emitting-diodes show applied control voltage and output relay operation at a glance.

Precision Digital Circuitry

Completely eliminates the ambiguity associated with analog controls and screwdriver adjustments.

Adjustable Response Time

This timer sets the amount of time between when a voltage outside of the selected tolerance is detected and when the output relay is de-energized. Setting low time values offers faster protection. Setting longer times provides greater resistance to nuisance tripping.

Adjustable Delay Time

This timer sets the amount of time before the protected system is allowed to restart. Typically this timer is set to a value which allows the protected system to bleed-off high pressures or to cool down to a safe value for restarting.

Broad Voltage Adjustment Range

User adjustable monitored voltage range from 160 to 650 VAC. This broad adjustment range incorporates voltages for the majority of compressor installation requirements. Therefore, this single unit can be used across a broad range of installations.

DTP-3 FACTS

Protection

Loss of Phase, Phase Reversal, Voltage Imbalance, Low Voltage, High Voltage.

Display

Large custom LCD indicates all operating conditions at a glance. Three large sets of digits provide easy system troubleshooting.

Voltmeter

Simultaneous display of all three line voltage pairs. One button switches to contactor load side voltage reading.

Input Voltage Range

90 – 650 VAC at 50 or 60 hertz.

Voltage Trip Point

Adjustable in 1 percent increments between 6% and 18% of the selected operating voltage. Restart voltage set point fixed at +3%.

Voltage Symmetry

Adjustable imbalance set point from 2% to 25% of selected operating voltage.

Lockout Delay Timer

Fully adjustable 0 to 720 seconds (0 to 12 minutes). Digital display shows remaining time and user set points.

Sequential Start Timer

0 – 30 seconds in 1 second increments.

Response Timer

0.1 to 20 seconds digital display shows remaining time and user set points.

Memory

Up to 25 previous fault conditions are recorded for display as desired.

Monitor Digital Trifasico de Linea de Voltaje

El DTP-3 es un monitor de voltaje y sistema de control automático digital.

Por estar midiendo continuamente la entrada de la línea de voltaje, este monitor detectará voltajes fuera de la tolerancia que se fijó.

Si este limite es excedido arrancará el Regulador de respuesta. Este regulador podrá ser fijado a una mayor escala de tiempo para evitar el ruido molesto del corte y arranque, o a una escala menor de tiempo para ofrecer un mayor nivel de protección de carga.

Si el voltaje permanece fuera de la tolerancia seleccionada después que el tiempo ha transcurrido, el DTP-3 apagará su relevador de rendimiento y protegerá su aparato. Mientras la carga esta apagada un regulador de cierre adicional es activado para evitar arranques inmediatos.

- Lectura de línea y de la carga de voltaje instantáneamente
- Tres simples botones de acceso para fácil monitoreo e instalación
- Registro de problemas en falla de memoria para posterior exhibición
- Seis voltímetros digitales integrados
- Regulador de arranque secuencial integrado
- Regulador de cierre integrado
- Regulador de respuesta integrado

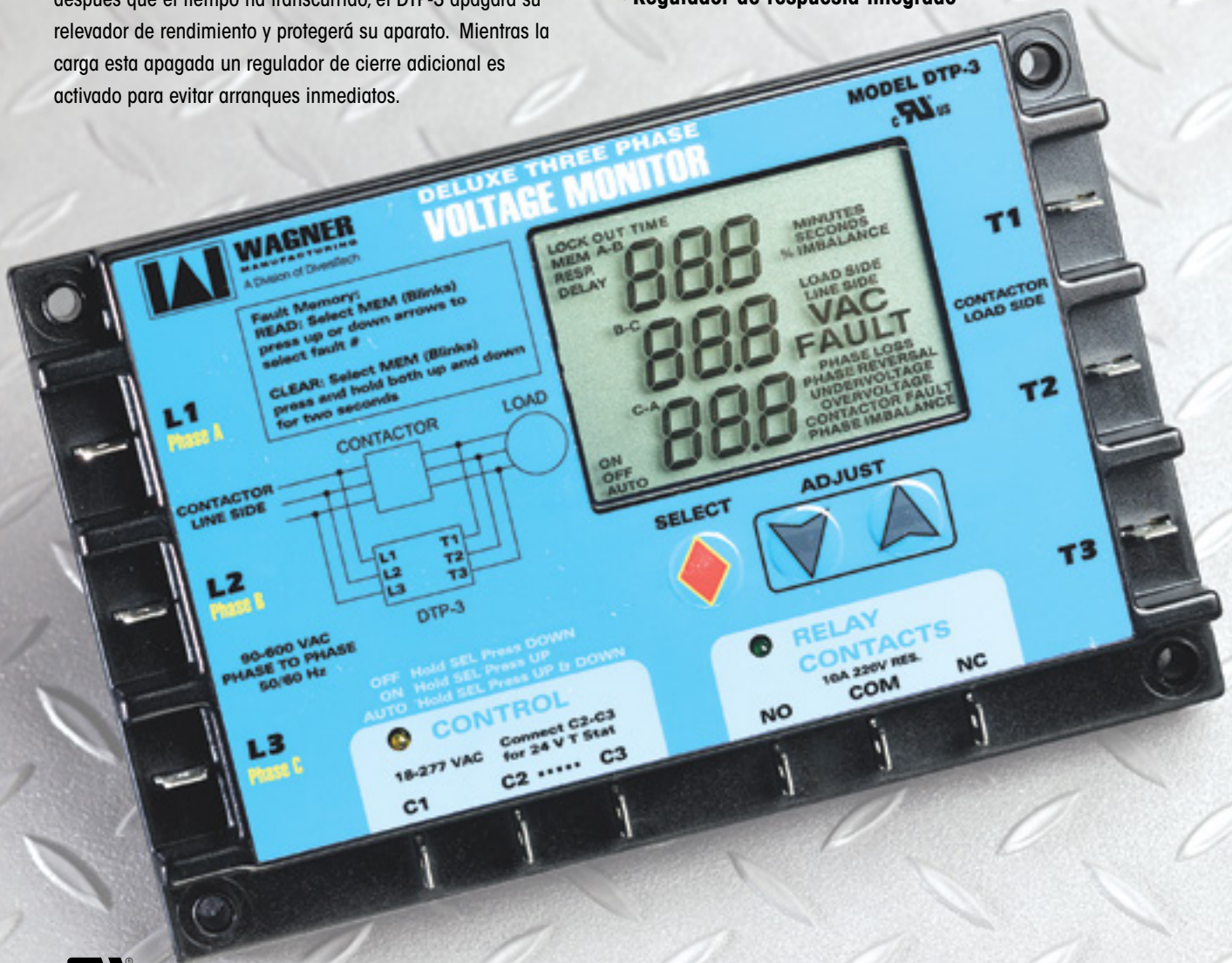

DTP-3 CARACTERISTICAS Y BENEFICIOS

La gran pantalla digital LCD

suministra al instante la operación del sistema de voltaje no solo luces indicadoras. El sistema programable es simplificado por usar la pantalla para fijar el rango exacto de voltaje que quiera monitorear. Otros controles usan botones para ajustar el sistema, que pueden dirigir hacia una programación inexacta y falla de motor.

Operación super simple

solo tres botones operan todo. Fácil ajuste de tolerancia de voltaje y reguladores de tiempo.

Pequeña medida

y su práctico contorno el cual se ajusta donde otros no pueden.

Relevador de salida de 10 amps con contactos aislados

Relevador de poder que puede conectarse con cualquier circuito de control. Normalmente-Abierto y Normalmente-Cerrado contactos son suministrados para conectarse a cualquier tipo de sistema, control de motor o alarma.

2 indicadores LED

muestran el voltaje de control aplicado y la operación del relevador de salida en un solo vistazo.

Los circuitos de precisión digital

eliminan completamente la ambigüedad asociada con controles análogos y ajustes de desarmador.

Regulador de respuesta ajustable

Este regulador fija la cantidad de tiempo cuando un voltaje externo de la tolerancia seleccionada es detectado y cuando el relevador de salida es de-energizado. El fijar valores de tiempo bajos ofrece una más rápida protección. El fijar un tiempo prolongado suministra gran resistencia evitando el ruido molesto del corte y arranque.

Regulador retardador de tiempo ajustable

Este regulador fija la cantidad de tiempo antes que al sistema de protección se le permita re-iniciar. Típicamente este regulador es fijado a un valor el cual permita al sistema de protección descargar altas presiones o que se enfríe a un valor seguro para re-iniciar.

Amplio ajuste del rango de voltaje

El usuario monitorea el rango ajustable del voltaje de 160 a 650 VAC. Este amplio rango de ajuste incorpora voltajes para la mayoría de los requerimientos de instalación de compresores. Así mismo, esta unidad puede ser usada a través de un rango amplio de instalaciones.

DTP-3 HECHOS

Proteccion

Pérdida de fase, cambio de fase, desequilibrio de voltaje, bajo voltaje, alto voltaje.

Pantalla

Los LCD hechos a la medida indican todas las condiciones de operación en un vistazo. Tres juegos grandes de dígitos suministran fácilmente los problemas del sistema.

Voltimetro

Pantalla simultanea de las tres líneas pares de voltaje. Un botón cambia al contactor para la lectura de la carga de voltaje.

Suministro de voltaje

90-650 VAC a 50 o 60 hertz.

Margen de error del voltaje

Ajustable en un porcentaje de entre 6% y 18% de la operación del voltaje seleccionado. Re-inicio con un +3% del voltaje establecido.

Simetria del voltaje

Desequilibrio ajustable establecido de 2% a 25% de la operación del voltaje seleccionado.

Regulador retardador de cierre

Completamente ajustable de 0 a 720 segundos (0 a 12 minutos) la pantalla digital muestra el tiempo restante y los puntos establecidos por el usuario.

Arrancador secuencial de tiempo

0 – 30 segundos en incrementos de 1 segundo.

Regulador de respuesta

0.1 a 20 segundos la pantalla digital muestra el tiempo restante y los puntos establecidos por el usuario.

Memoria

Hasta 25 condiciones de falla previas son almacenadas para mostrarse según se requiera.

MOTORS

Wagner® Single Speed Condenser Fan Motors

- Installs with all Standard 48 Frame Mounting Brackets
- Standard Shaft Length, Diameter, and Flats
- Drain Holes with Plugs in both end plates
- Automatic Thermal Overload Protector
- Standard 48 Frame Motor Casing Size
- Low Power Consumption
- 60 C Ambient Design
- Electrically Reversible
- Continuous Air Over
- Class B Insulation
- Quiet Operation
- Extended Studs
- 30" Leads
- 60 HZ



BALL BEARINGS NOW STANDARD



CATALOG NO.	HP	VOLTAGE	SPEED	FLA	UOM	ORDER MULTIPLE
WG840727	1/6	208-230	1075/1	1.3	EA	1
WG840728	1/4	208-230	1075/1	2.2	EA	1
WG840729	1/3	208-230	1075/1	2.8	EA	1
WG840730	1/2	208-230	1075/1	4.2	EA	1
WG840731	3/4	208-230	1075/1	4.5	EA	1
WG840204	1/4	208-230	825/1	1.5	EA	1
WG840205	1/3	208-230	825/1	2.2	EA	1

Wagner® High Temperature Condenser Fan Motors

- 70°C Ambient Temperature
- Installs with all Standard 48 Frame Mounting Brackets
- Standard Shaft Length, Diameter, and Flats
- Drain Holes with Plugs in both end plates
- Automatic Thermal Overload Protector
- Standard 48 Frame Motor Casing Size
- Low Power Consumption
- Electrically Reversible
- Continuous Air Over
- Class B Insulation
- Quiet Operation
- Extended Studs
- 30" Leads
- 60 HZ



BALL BEARINGS NOW STANDARD



CATALOG NO.	HP	VOLTAGE	SPEED	FLA	UOM	ORDER MULTIPLE
WG840728HT	1/4	208-230	1075/1	2.2	EA	1
WG840729HT	1/3	208-230	1075/1	2.8	EA	1
WG840730HT	1/2	208-230	1075/1	4.2	EA	1
WG840731HT	3/4	208-230	1075/1	5.3	EA	1
WG840736HT	1/4	460	1075/1	1.65	EA	1
WG840737HT	1/3	460	1075/1	2.85	EA	1
WG840738HT	1/2	460	1075/1	4.3	EA	1
WG840739HT	3/4	460	1075/1	5.3	EA	1
WG840204HT	1/4	208-230	825/1	1.5	EA	1
WG840205HT	1/3	208-230	825/1	2.2	EA	1

Wagner® Multiple Horsepower Condenser Fan Motors

The Multi-Horsepower motors are specially designed to cover a range of applications. The condenser fan motors range from 1/2 to 1/5; 1/3 to 1/6 both at 1075 rpm; 1/3 to 1/6 at 825rpm. These motors feature reversing plugs, extended thru bolts 36 inch leads and are designed for 370 volt capacitors. Installs with all 48 frame mounting brackets.



BALL BEARINGS NOW STANDARD



CATALOG NO.	APPLICATION	VOLTAGE	SPEED	(1) HP-FLA	(2) HP-FLA	(3) HP-FLA	(4) HP-FLA	(5) HP-FLA	UOM	ORDER MULTIPLE
WG840465	CF	208-230	1075/2	1/3-2.8	1/4-2.0	1/5-1.7	1/6-1.5	-	EA	1
WG840468	CF	208-230	1075/2	1/2-3.0	1/3-2.5	1/4-2.0	1/5-1.3	-	EA	1
WG840469	CF	208-230	825/2	1/3-2.1	1/4-1.7	1/5-1.5	1/6-1.2	-	EA	1

Wagner® Direct Drive Furnace Blower Motors

- Installs with all Standard 48 Frame Mounting Brackets
- Standard Shaft Length, Diameter, and Flats
- Uses 370V Capacitors
- Standard 48 Frame Motor Casing Size
- 2.5" Diameter Hub Rings included
- Low Power Consumption
- Automatic Thermal Overload Protector
- Continuous Duty, Air Over
- Electrically Reversible
- Class B Insulation
- Speed: 1075/3
- Quiet Operation
- 60 HZ

CATALOG NO.	HP	VOLTAGE	SPEED	FLA	UOM	ORDER MULTIPLE
WG840583	1/4	115	1075/3	4.6	EA	1
WG840584	1/4	208-230	1075/3	2.2	EA	1
WG840585	1/3	115	1075/3	6.7	EA	1
WG840586	1/3	208-230	1075/3	2.9	EA	1
WG840587	1/2	115	1075/3	10.2	EA	1
WG840588	1/2	208-230	1075/3	5.0	EA	1
WG840589	3/4	115	1075/3	11.3	EA	1
WG840590	3/4	208-230	1075/3	5.4	EA	1
WG840595	1	115	1075/3	12.6	EA	1
WG840596	1	208-230	1075/3	5.59	EA	1

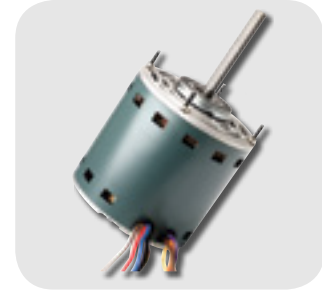

Wagner® Multiple Horsepower Furnace Blower Motors

The Multi-Horsepower motors are specially designed to cover a range of applications. The direct drive furnace blower motors range from 1/2 to 1/6 in both 115 and 230 volts and 3/4 to 1/5 in both 115 and 230 volts all at 1075rpm. These motors feature reversing plugs, extended thru bolts 36 inch leads and are designed for 370 volt capacitors. Installs with all 48 frame mounting brackets.

CATALOG NO.	APPLICATION	VOLTAGE	SPEED	(1) HP-FLA	(2) HP-FLA	(3) HP-FLA	(4) HP-FLA	(5) HP-FLA	UOM	ORDER MULTIPLE
WG840463	DDFB	115	1075/4	1/2-7.0	1/3-6.7	1/4-4.4	1/5-3.2	1/6-2.4	EA	1
WG840464	DDFB	208-230	1075/4	1/2-3.9	1/3-3.6	1/4-2.5	1/5-1.8	1/6-1.3	EA	1
WG840466	DDFB	115	1075/4	3/4-8.1	1/2-6.6	1/3-4.6	1/4-3.8	1/5-3.1	EA	1
WG840467	DDFB	208-230	1075/4	3/4-3.8	1/2-3.7	1/3-2.5	1/4-1.8	1/5-1.7	EA	1

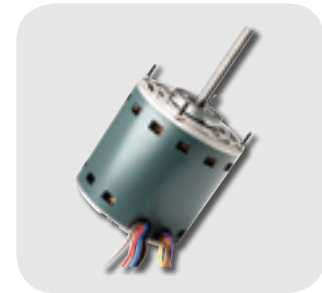

Genteq® Single Speed Condenser Fan Motors

- Standard 48 frame size
- Single speed with reversible rotation
- Designed for 370V capacitors with mounting holes
- 26" motor leads
- 6" shaft extension
- Automatic thermal overload protection

CATALOG NO.	HP	VOLTAGE	SPEED	FLA	UOM	ORDER MULTIPLE
3727	1/6	208/230	1075/1	1.0	EA	1
3728	1/4	208/230	1075/1	1.8	EA	1
3729	1/3	208/230	1075/1	2.3	EA	1
3730	1/2	208/230	1075/1	3.5	EA	1
3731	3/4	208/230	1075/1	4.7	EA	1
3202*	1/8	208/230	825/1	0.9	EA	1
3203*	1/6	208/230	825/1	1.0	EA	1
3205*	1/3	208/230	825/1	1.9	EA	1
3746	1/2	208/230	825/1	3.4	EA	1

*Ball Bearing



MOTORS cont'd

Genteq® High Temperature Condenser Fan Motors

- Standard 48 frame size
- Designed for 70°C ambient operation
- 48" motor leads
- Extended thru bolts on both ends
- Drain holes in both endshields with plug
- Automatic thermal overload protection
- Ball Bearing

CATALOG NO.	HP	VOLTAGE	SPEED	FLA	UOM	ORDER MULTIPLE
3726HS	1/6	208/230	1075/1	1.0	EA	1
3732HS	1/4	208/230	1075/1	1.7	EA	1
3733HS	1/3	208/230	1075/1	2.6	EA	1
3734HS	1/2	208/230	1075/1	3.0	EA	1
3735HS	3/4	208/230	1075/1	4.1	EA	1
3203HS	1/6	208/230	825/1	0.9	EA	1
3204HS	1/4	208/230	825/1	1.3	EA	1
3205HS	1/3	208/230	825/1	1.8	EA	1
3747HS	1/2	208/230	825/1	2.8	EA	1
3736HS	1/4	460	1075/1	0.7	EA	1
3737HS	1/3	460	1075/1	1.2	EA	1
3738HS	1/2	460	1075/1	1.7	EA	1
3739HS	3/4	460	1075/1	2.0	EA	1
3469HS	1/3-1/6	208/230	825/2	2.0	EA	1
3465HS	1/3-1/6	208/230	1075/2	2.5	EA	1
3468HS	1/2-1/5	208/230	1075/2	3.1	EA	1
3459HS	1/3-1/8	208/230	825/1	1.8	EA	1
3458HS	1/3-1/6	208/230	1075/1	2.6	EA	1



Genteq® Multiple Horsepower Condenser Fan Motors

- Standard 48 frame size
- One or two speeds with reversible rotation
- Extended clamp screws and resilient rings with Rheem mounting holes
- Hardware included
- Water slinger on shaft
- Automatic thermal overload protection
- Ball Bearing

CATALOG NO.	HP	VOLTAGE	SPEED	FLA	UOM	ORDER MULTIPLE
3458	1/3-1/6	208/230	1075/1	2.7	EA	1
3459	1/3-1/8	208/230	825/1	1.9	EA	1
3465	1/3-1/6	208/230	1075/2	6.2	EA	1
3468	1/3-1/6	208/230	1075/2	4.2	EA	1
3469	1/2-1/5	208/230	825/2	8.4	EA	1



Genteq® Direct Drive Furnace Blower Motors

- Standard 48 frame size
- 3 speeds at 1075 RPM
- 115V or 208-230V options available
- 4" shaft extension
- Reversible rotation
- Mounting holes for capacitor mounting bracket
- Automatic thermal overload protection

CATALOG NO.	HP	VOLTAGE	SPEED	FLA	UOM	ORDER MULTIPLE
3583	1/4	115	1075/3	4.2	EA	1
3584	1/4	208/230	1075/3	2.0	EA	1
3585	1/3	115	1075/3	6.1	EA	1
3586	1/3	208/230	1075/3	2.7	EA	1
3587	1/2	115	1075/3	9.0	EA	1
3588	1/2	208/230	1075/3	5.0	EA	1
3589	3/4	115	1075/3	11.8	EA	1
3590	3/4	208/230	1075/3	5.0	EA	1
3595*	1	115	1075/3	11.8	EA	1
3596*	1	208/230	1075/3	5.6	EA	1

*Ball Bearing



MOTORS cont'd

Genteq® Multiple Horsepower Furnace Blower Motors

- Standard 48 frame size
- Four speeds with reversible rotation
- Extended clamp screws and resilient rings with Rheem mounting holes
- Hardware included
- 115V or 208-230V options available
- Automatic thermal overload protection

CATALOG NO.	HP	VOLTAGE	SPEED	FLA	UOM	ORDER MULTIPLE
3463	1/2-1/6	115	1075/4	6.2	EA	1
3464	1/2-1/6	208/230	1075/4	2.7	EA	1
3466*	3/4-1/5	115	1075/4	8.5	EA	1
3467*	3/4-1/5	208/230	1075/4	4.2	EA	1

*Ball Bearing

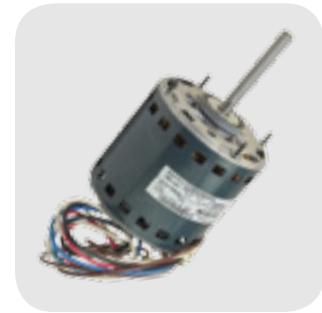

Evergreen® ECM Motors

- Standard 48 frame size
- Multi-speed, constant torque, brushless DC motor
- EM series is designed to replace X13 or equivalent ECM motors.
- OM and IM series are designed to replace PSC motors.
- Soft Start and Off Ramp for quiet operation
- Encapsulated electronics
- 4kV surge protection
- Electronic overload protection

CATALOG NO.	HP	VOLTAGE	SPEED	FLA	TYPE	UOM	ORDER MULTIPLE
6103E	1/3	115	600-1200	4.8	EM SERIES	EA	1
6203E	1/3	208/230	600-1200	2.8	EM SERIES	EA	1
6105E	1/2	115	600-1200	6.8	EM SERIES	EA	1
6205E	1/2	208/230	600-1200	4.1	EM SERIES	EA	1
6107E	3/4	115	600-1200	8.4	EM SERIES	EA	1
6207E	3/4	208/230	600-1200	6.0	EM SERIES	EA	1
6110E	1	115	600-1200	10.9	EM SERIES	EA	1
6210E	1	208/230	600-1200	7.6	EM SERIES	EA	1
6301	1/5	208/230	850-1100	2.8	OM SERIES	EA	1
6303	1/3	208/230	850-1100	3.5	OM SERIES	EA	1
6005	1/2	115/230	1000-1075	6.7/4.0	IM SERIES	EA	1
6010	1	115/230	1000-1075	11.0/6.7	IM SERIES	EA	1



Fasco® 3.3 in. Walk-In Cooler/Freezer Refrigeration Motors

The Fasco 3-in1 motor is a universal replacement motor for walk-in cooler and freezer evaporator applications. This motor replaces 1/12, 1/15 & 1/20hp PSC and Shaded pole motors. Designed for use down to 40°C applications with low temp lubrication.

CATALOG NO.	HP	VOLTAGE	SPEED	FLA	UOM	ORDER MULTIPLE
9721	1/12, 1/15, 1/20	115/208-230	1550	1.1/0.5	EA	1



Wellington® ECM Refrigeration Motors

Wellington ECM Refrigeration Motors are electronically commutated brushless DC motors. Top quality electronics and design make these motors extremely efficient, quiet and reliable. Long design life and reliability are the result of Wellington's moisture proof patented design and the use of ball bearings; and allow significant maintenance and cost savings. Wellington motors use the same mounting systems as shaded pole motors and are provided with a plug in connection for easy, fast replacement.

CATALOG NO.	WATT	VOLTAGE	SPEED	FLA	UOM	ORDER MULTIPLE
ECR01-9W	9	115	1500	0.23	EA	1
ECR01-12W	12	115	1550	0.31	EA	1



MOTOR BRACKETS

DiversiTech® Motors Bracket

These brackets help hold the motor securely.



CATALOG NO.	DESCRIPTION	UOM	ORDER MULTIPLE
DMB-1	Fixed Lug Assembly for 5-1/2" diameter motors	EA	1
DMB-2	Adjustable Lug Assembly for 5-1/2" diameter motors	EA	1

Motor Mount – Flex Bracket

Torsion Flex Bracket holds motor securely. Fits 5- 1/2" motors. Typically used for Goodman equipment.



CATALOG NO.	DESCRIPTION	UOM	ORDER MULTIPLE
DMB-3	5-1/2" Motor Mount Torsion Flex Bracket	EA	1

Rheem Motor Bracket

These brackets help hold the motor securely.



CATALOG NO.	DESCRIPTION	UOM	ORDER MULTIPLE
A60306K	Mounting Plate for Rheem Condensing Units	EA	1

BEARINGS

Cushioned Pillow Blocks

These blocks are used to reduce noise from vibration from motors.

CATALOG NO.	DESCRIPTION	INDUSTRY NO.	LAU NO.	BEARING SHAFT SIZE	UOM	ORDER MULTIPLE
535-BB1	Bronze Bearing Pillow Block	NAH8A		1/2"	EA	1
535-BB2	Bronze Bearing Pillow Block	NAH10A	38-2204-01	5/8"	EA	1
535-BB3	Bronze Bearing Pillow Block	NAH12A	38-2086-01	3/4"	EA	1
535-BB4	Bronze Bearing Pillow Block	NAH16A	38-2087-01	1"	EA	1



Side Flange Mount Pillow Blocks

These blocks are used to reduce noise from vibration from motors.

CATALOG NO.	DESCRIPTION	INDUSTRY NO.	BEARING SHAFT SIZE	UOM	ORDER MULTIPLE
535-BB6	Cushioned Flange Block	NVH10A	5/8"	EA	1



WHIPS

DiversiWhips

Liquid tight flexible conduit system. A labor saving convenience kit for A/C unit hookup. Also use for heat pumps, refrigeration, hot tubs, swimming pools and outdoor lighting. Three distinct wire colors for ease of hook up. 1 straight and 1 90 degree metallic or non metallic connector. 90 degree connector is removable for straight connections. (Second straight connector not included.) U.L. and C.U.L Listed.



DiversiWhips Pallet Packs

DiversiWhips are now available in a convenient, bulk packaged pallet pack at a discounted price. Pallet pack makes an attractive floor standing display. 1 straight and 1 90 degrees metallic or non metallic connector.



CATALOG NO.	DESCRIPTION	UOM	ORDER MULTIPLE
6-12-4	1/2 x 4' #10 THHN Wire – Metallic Connectors	EA	6
6-12-6	1/2 x 6' #10 THHN Wire – Metallic Connectors	EA	6
6-34-4	3/4 x 4' #8 THHN Wire – Metallic Connectors	EA	6
6-34-6	3/4 x 6' #8 THHN Wire – Metallic Connectors	EA	6
6-34-8	3/4 x 8' #8 THHN Wire – Metallic Connectors	EA	3
6-12-4NM	1/2 x 4' #10 THHN Wire – Non-Metallic Connectors	EA	6
6-12-6NM	1/2 x 6' #10 THHN Wire – Non-Metallic Connectors	EA	6
6-34-4NM	3/4 x 4' #8 THHN Wire – Non-Metallic Connectors	EA	6
6-34-6NM	3/4 x 6' #8 THHN Wire – Non-Metallic Connectors	EA	6
6-34-8NM	3/4 x 8' #8 THHN Wire – Non-Metallic Connectors	EA	3

CATALOG NO.	DESCRIPTION	UOM	ORDER MULTIPLE
B6-12-4	1/2 x 4' #10 THHN Wire – Metallic Connectors	EA	90
B6-12-6	1/2 x 6' #10 THHN Wire – Metallic Connectors	EA	60
B6-34-6	3/4 x 6' #8 THHN Wire – Metallic Connectors	EA	45
B6-12-4NM	1/2 x 4' #10 THHN Wire – Non-Metallic Connectors	EA	90
B6-12-6NM	1/2 x 6' #10 THHN Wire – Non-Metallic Connectors	EA	60
B6-34-4NM	3/4 x 4' #8 THHN Wire – Non-Metallic Connectors	EA	60
B6-34-6NM	3/4 x 6' #8 THHN Wire – Non-Metallic Connectors	EA	45

*For DiversiWhips produced with 2 straight connectors, add S to part number (ex: 6-12-4S).

DiversiWhips for the Swimming Pool Industry

A labor saving kit for hookup of swimming pool motors, pumps, filters, and timers. Three distinct wire colors for ease of hookup. 1 straight and 1 90 degree non-metallic connector included.



6-12-6NMP

CATALOG NO.	DESCRIPTION	UOM	ORDER MULTIPLE
6-12-4NMP	1/2 x 4' #12 THHN Wire – In Bag	EA	6
6-12-6NMP	1/2 x 6' #12 THHN Wire – In Bag	EA	6
6-12-8NMP	1/2 x 8' #12 THHN Wire – In Bag	EA	6
6-12-4NMSP	1/2 x 4' #10 THHN Wire – In Box	EA	6
6-12-6NMSP	1/2 x 6' #10 THHN Wire – In Box	EA	6
6-34-4NMSP	3/4 x 4' #8 THHN Wire – In Box	EA	6
6-34-6NMSP	3/4 x 6' #8 THHN Wire – In Box	EA	6

Solid Wire Whips

6-12-4NMSWP	1/2 x 4' #12 Solid 3 Wire – Non-Metallic Conn.	EA	6
6-12-6NMSWP	1/2 x 6' #12 Solid 3 Wire – Non-Metallic Conn.	EA	6
6-12-8NMSWP	1/2 x 8' #12 Solid 3 Wire – Non-Metallic Conn.	EA	3
6-12-6NM4SWP	1/2 x 6' #12 Solid 4 Wire – Non-Metallic Conn.	EA	6

DiversiWhips with Extended Length Wires

DiversiWhips are available with extra long lead wires for those difficult to wire applications. These whips offer 10in. of lead wire on the straight side and 18in. of lead wire on the 90 degree side.



6-12-4R

CATALOG NO.	DESCRIPTION	UOM	ORDER MULTIPLE
6-12-6R	1/2 x 6' #10 THHN Wire – Metallic Connectors	EA	6
6-34-4R	3/4 x 4' #8 THHN Wire – Metallic Connectors	EA	6
6-34-6R	3/4 x 6' #8 THHN Wire – Metallic Connectors	EA	6
6-12-4NMR	1/2 x 4' #10 THHN Wire – Non-Metallic Connectors	EA	6
6-12-6NMR	1/2 x 6' #10 THHN Wire – Non-Metallic Connectors	EA	6
6-34-4NMR	3/4 x 4' #8 THHN Wire – Non-Metallic Connectors	EA	6
6-34-6NMR	3/4 x 6' #8 THHN Wire – Non-Metallic Connectors	EA	6

DIVERSITECH ELECTRICAL DISCONNECTS

Disconnects—Metal Case

Fused model designed with fuses in pull out handle for easy replacement. The line, load, and ground terminals are aligned for ease of wiring. This product has a reversible door which opens to either the left or right. The side open door opens more than 180 degrees for maximum access and has a full dead front. The fused models have indicator lights for blown fuses. This is rain tight and sleet resistant. The UL Listed number is IRF9, NEMA Type 3R and the US Patent is 6,630,637.



DDS-60

CATALOG NO.	DESCRIPTION	UOM	ORDER MULTIPLE
DDS-30	30A Fusible Disconnect Switch	EA	10
DDS-60	60A Fusible Disconnect Switch	EA	10
DDS-60U	60A Non-Fusible Disconnect Switch	EA	10

Disconnects—Non-Metallic Case

This 60 amp non-fusible disconnect is housed in a lightweight, non-metallic case. It features a side opening door with more than 180° access, full dead front, and a locking tab.



750-P60NF

CATALOG NO.	DESCRIPTION	UOM	ORDER MULTIPLE
750-P60NF	60A Non Fusible Disconnect Switch, Non-Metallic Case, Plastic	EA	10

Low Profile Disconnects—Metal Case

This low profile disconnect switch is a slightly smaller design than that of the standard DiversiTech disconnects. This has a side opening door with a full dead front. This is rain tight and sleet resistant. The UL Listed number is IRF9, NEMA Type 3R.



EDS-12-6NM

EDS-60U

CATALOG NO.	DESCRIPTION	UOM	ORDER MULTIPLE
EDS-60U	60A Non-Fusible Disconnect Switch	EA	10
EDS-12-6NM	Disconnect and Whip Combo Kit	EA	3

EATON ELECTRICAL DISCONNECTS

Eaton Switch A/C Disconnect

This A/C Disconnect is 60 amps switch rated for 10 HP motors at 240VAC. The switch is an on off circuit breaker with no pull out head that could be lost or stolen. It has easy-to-remove front cover with no screws or fasteners to remove.



DPB222R



CATALOG NO.	DESCRIPTION	UOM	ORDER MULTIPLE
DPB222R	60A molded case switch	EA	1

Eaton Three Phase Disconnects

These disconnects are UL listed and meet UL 98 for enclosed switches and NEMA Std. KS-1. They are suitable as service entrance equipment when applied with neutral or ground lug kit. They come with rainproof NEMA 3R enclosure.



DG322NRB



CATALOG NO.	DESCRIPTION	UOM	ORDER MULTIPLE
DG321NRB	Fusible 30 Amp, 240VAC	EA	1
DG322NRB	Fusible 60 Amp, 240VAC	EA	1
DG322URB	Non-fusible 60 Amp, 240VAC	EA	1

CONDUIT, FITTINGS, CABLE

DiversiTite™ Flexible Conduit

For electrical applications: outside, inside and industrial uses including transformer connections, air conditioning and heating. Joins with metallic or non-metallic connectors, easy to cut. Impact resistant, chemical resistant, and will not kink. U.L. and C.U.L. Listed. For use as indicated in Article 351 of the 1987 NEC.



750-12100

CATALOG NO.	DESCRIPTION	UOM	ORDER MULTIPLE
750-38100	3/8" x 100' Liquid Tite Conduit – Non-Metallic, 100' per roll	EA	1
750-12100	1/2" x 100' Liquid Tite Conduit – Non-Metallic, 100' per roll	EA	1
750-500	1/2" x 100' Liquid Tite Conduit – Metallic, 100' per roll	EA	1
750-34100	3/4" x 100' Liquid Tite Conduit – Non-Metallic, 100' per roll	EA	1
750-600	3/4" x 100' Liquid Tite Conduit – Metallic, 100' per roll	EA	1
750-10100	1" x 100' Liquid Tite Conduit – Non-Metallic, 100' per roll	EA	1
750-125100	1-1/4" x 100' Liquid Tite Conduit – Non-Metallic, 100' per roll	EA	1
750-1550	1-1/2" x 50' Liquid Tite Conduit – Non-Metallic, 50' per roll	EA	1
750-2050	2" x 50' Liquid Tite Conduit – Non-Metallic, 50' per roll	EA	1
750-10500	1" x 500' Liquid Tite Conduit – Non-Metallic, 500' per roll	EA	1
750-121000	1/2" x 1000' Liquid Tite Conduit – Non-Metallic, 1000' per roll	EA	1
750-34800	3/4" x 800' Liquid Tite Conduit – Non-Metallic, 800' per roll	EA	1

Single Piece Liquid Tite Fittings

Conduit threads onto ferrule and up inside the outer body. An inside taper squeezes down on the outside of conduit for a superior liquid tight seal. The cut portion of the conduit does not show, giving a more finished appearance. Easy to use at a lower cost than regular liquid tite fittings.



750-SLTC9050

750-SLTC50

CATALOG NO.	DESCRIPTION	UOM	ORDER MULTIPLE
750-SLTC50	1/2" Straight Screw-On Fitting	EA	25
750-SLTC9050	1/2" 90° Screw-On Fitting	EA	25
750-SLTC75	3/4" Straight Screw-On Fitting	EA	25
750-SLTC9075	3/4" 90° Screw-On Fitting	EA	25

Liquid Tite Connectors

For use with metallic and non metallic liquid tite conduit, Type B. Provides smooth connection, no sharp edges to strip wire. Wiring easily pulled through. U. L. Listed. C.U.L. Listed.



750-MLT50 750-NMLT50

750-NMLT9050

CATALOG NO.	DESCRIPTION	UOM	ORDER MULTIPLE
750-NMLT50	1/2" Non-Metallic Straight Connector	EA	25
750-NMLT4550	1/2" Non-Metallic 45 Degree Elbow Connector	EA	10
750-NMLT9050	1/2" Non-Metallic 90 Degree Elbow Connector	EA	10
750-NMLT75	3/4" Non-Metallic Straight Connector	EA	10
750-NMLT4575	3/4" Non-Metallic 45 Degree Elbow Connector	EA	10
750-NMLT9075	3/4" Non-Metallic 90 Degree Elbow Connector	EA	10
750-NMLT100	1" Non-Metallic Straight Connector	EA	5
750-NMLT90100	1" Non-Metallic 90 Degree Elbow Connector	EA	5
750-MLT50	1/2" Metallic Straight Connector	EA	25
750-MLT9050	1/2" Metallic 90 Degree Elbow Connector	EA	10
750-MLT75	3/4" Metallic Straight Connector	EA	10
750-NMLT9075	3/4" Metallic 90 Degree Elbow Connector	EA	10
750-NMLT125	1-1/4" Non-Metallic Straight Connector	EA	1
750-NMLT90125	1-1/4" Non-Metallic 90 Degree Elbow Connector	EA	1
750-NMLT5090-F	1/2" Non-Metallic Adjustable Connector	EA	10
750-NMLT7590-F	3/4" Non-Metallic Adjustable Connector	EA	10
750-TZNMLT200	2" NM Topaz	EA	2
750-TZNMLT90200	2" NM Topaz 90 Degree	EA	1
750-TZNMLT150	1-1/2" NM Topaz	EA	5
750-TZNMLT90150	1-1/2" NM Topaz 90 Degree	EA	2
750-TZNMLT125	1-1/4" NM Topaz	EA	5
750-TZNMLT90125	1-1/4" NM Topaz 90 Degree	EA	2
750-TZNMLT100	1" NM Topaz	EA	5
750-TZNMLT90100	1" NM Topaz 90 Degree	EA	5
750-TZNMLT38	3/8" NM Topaz	EA	10
750-TZNMLT9038	3/8" NM Topaz 90 Degree	EA	25
750-TZNMLT50	1/2" NM Topaz	EA	25
750-TZNMLT9050	1/2" NM Topaz 90 Degree	EA	10
750-TZNMLT75	3/4" NM Topaz	EA	10
750-TZNMLT9075	3/4" NM Topaz 90 Degree	EA	10

CONDUIT, FITTINGS, CABLE cont'd

Aluminum Armored MC Cable

90° C Rated aluminum metal clad cable system. THHN solid copper with specially compounded heat-resistant U.L. Listed insulation and jacket. Flexible interlocked aluminum armor. Extremely durable – withstands severe handling. U.L. Listed #4. Conforms to NEC article 333.



CATALOG NO.	DESCRIPTION	UOM	ORDER MULTIPLE
640-122	12-2 Aluminum Armored MC Cable – 100' per roll EA	EA	1
640-142	14-2 Aluminum Armored MC Cable – 100' per roll EA	EA	1

Romex Connectors – Metallic

These Metallic Romex Connectors are made of zinc die cast are cable connectors for Romex wire. U.L. Listed C.S.A. Approved.



CATALOG NO.	DESCRIPTION	UOM	ORDER MULTIPLE
750-RC841	3/8" Romex Connector for 1/2" Knockouts	EA	100
750-RC842	3/4" Romex Connector for 3/4" Knockouts	EA	50

U.L. Listed and C.S.A. Approved.

BX Set Screw Connectors

These connectors are for BX cable range of .445 to .630 in diameter. This product is UL listed and CSA approved.



CATALOG NO.	DESCRIPTION	UOM	ORDER MULTIPLE
640-845	Trade Size – 3/8"	EA	100

Non-Metallic Sheathed Cable (Romex Wire)

600V building wire. Easy to pull and strip, flame and moisture resistant. Saves time, labor and money. Color coded conductors of copper, PVC insulation and outer jacket with ground. U.L. Listed 719 Federal Specifications J C94.



CATALOG NO.	DESCRIPTION	UOM	ORDER MULTIPLE
620-6-2	6 AWG, 2 Conductors with Ground – 125' per pack	EA	1
620-8-2	8 AWG, 2 Conductors with Ground – 125' per pack	EA	1
620-10-2	10 AWG, 2 Conductors with Ground – 250' per pack	EA	1
620-12-2	12 AWG, 2 Conductors with Ground – 250' per pack	EA	1
620-14-2	14 AWG, 2 Conductors with Ground – 250' per pack	EA	1

U.L. Listed 719 Federal Specifications J-C94.

EMT (Thinwall) Fittings

These are used to join EMT conduit to boxes on enclosures.



CATALOG NO.	DESCRIPTION	UOM	ORDER MULTIPLE
625-800	Set Screw Connector – 1/2"	EA	50
625-801	Set Screw Connector – 3/4"	EA	25
625-304	Strap – One Hole – 1/2"	EA	100
625-305	Strap – One Hole – 3/4"	EA	100
625-810	Set Screw Coupling – 1/2"	EA	50
625-811	Set Screw Coupling – 3/4"	EA	25

Cable Staples

Cable Staples for NMB Cable (Romex) and Copper Insulated Staples for thermostat wire.



CATALOG NO.	DESCRIPTION	UOM	ORDER MULTIPLE
625-183	Romex Staples – 1/2", pack of 100	PK	1
625-IS5	Copper Insulated #5 Staples for T-Stat Wire	EA	100

CAPACITORS

Motor Run Capacitors—370VAC, Metal, Oval Can

These single capacitance oval, metal can capacitors are designed for continuous run.



CATALOG NO.	uf	UOM	ORDER MULTIPLE
37030H	3	EA	1
37040H	4	EA	1
37050H	5	EA	1
37050HB	5	EA	100*
37060H	6	EA	1
37075H	7.5	EA	1
37075HB	7.5	EA	100*
37100H	10	EA	1
37100HB	10	EA	100*
37125H	12.5	EA	1
37150H	15	EA	1
37175H	17.5	EA	1
37200H	20	EA	1
37250H	25	EA	1
37300H	30	EA	1
37350H	35	EA	1
37400H	40	EA	1
37450H	45	EA	1
37500H	50	EA	1
37600H	60	EA	1
37700H	70	EA	1
37800H	80	EA	1

*100 per pack

Motor Run Capacitors—370VAC

This single capacitance round, metal can capacitors are designed for continuous run.



CATALOG NO.	uf	UOM	ORDER MULTIPLE
37050R	5	EA	1
37075R	7.5	EA	1
37125R	12.5	EA	1
37150R	15	EA	1
37175R	17.5	EA	1
37200R	20	EA	1
37250R	25	EA	1
37300R	30	EA	1
37350R	35	EA	1
37400R	40	EA	1
37450R	45	EA	1
37500R	50	EA	1
37550R	55	EA	1
37600R	60	EA	1
37800R	80	EA	1

Motor Run Capacitors—370VAC

Dual capacitance. Oval, metal can.



CATALOG NO.	uf	UOM	ORDER MULTIPLE
3GJ0515	15+5	EA	1
3GJ0520	20+5	EA	1
3GJ1520	20+15	EA	1
3GJ0525	25+5	EA	1
3GJ1025	25+10	EA	1
3GJ0330	30+3	EA	1
3GJ0530	30+5	EA	1
3GJ7530	30+7.5	EA	1
3GJ0535	35+5	EA	1
3GJ7535	35+7.5	EA	1
3GJ7545	45+7.5	EA	1
3GJ0540	40+5	EA	1
3GJ0545	45+5	EA	1
3GJ0555	55+5	EA	1
3GJ7555	55+7.5	EA	1
3GJ1060	60+10	EA	1

Motor Run Capacitors—370VAC

This dual capacitance round metal can capacitors are designed for continuous run.



CATALOG NO.	uf	UOM	ORDER MULTIPLE
3GR0515	15+5	EA	1
3GR0520	20+5	EA	1
3GR0325	25+3	EA	1
3GR0425	25+4	EA	1
3GR0525	25+5	EA	1
3GR0330	30+3	EA	1
3GR0530	30+5	EA	1
3GR7530	30+7.5	EA	1
3GR0335	35+3	EA	1
3GR0435	35+4	EA	1
3GR0535	35+5	EA	1
3GR1035	35+10	EA	1
3GR0340	40+3	EA	1
3GR0540	40+5	EA	1
3GR7540	40+7.5	EA	1
3GR0545	45+5	EA	1
3GR0550	50+5	EA	1
3GR0555	55+5	EA	1
3GR7555	55+7.5	EA	1
3GR0560	60+5	EA	1
3GR7560	60+7.5	EA	1
3GR0570	70+5	EA	1
3GR0580	80+5	EA	1
3GR7580	80+7.5	EA	1
3GR1080	80+10	EA	1

Motor Run Capacitors—440VAC

These single capacitance oval, metal can capacitors are designed for continuous run.



CATALOG NO.	uf	UOM	ORDER MULTIPLE
45020H	2	EA	1
45030H	3	EA	1
45040H	4	EA	1
45050H	5	EA	1
45060H	6	EA	1
45075H	7.5	EA	1
45100H	10	EA	1
45125H	12.5	EA	1
45150H	15	EA	1
45175H	17.5	EA	1
45200H	20	EA	1
45250H	25	EA	1
45300H	30	EA	1
45350H	35	EA	1
45400H	40	EA	1
45450H	45	EA	1
45500H	50	EA	1
45550H	55	EA	1
45600H	60	EA	1
45700H	70	EA	1
45800H	80	EA	1

Motor Run Capacitor—440VAC

Single capacitance. Round, metal can.



CATALOG NO.	uf	UOM	ORDER MULTIPLE
45050R	5	EA	1
45075R	7.5	EA	1
45100R	10	EA	1
45125R	12.5	EA	1
45150R	15	EA	1
45200R	20	EA	1
45250R	25	EA	1
45300R	30	EA	1
45350R	35	EA	1
45400R	40	EA	1
45450R	45	EA	1
45500R	50	EA	1
45550R	55	EA	1
45600R	60	EA	1
45700R	70	EA	1
45800R	80	EA	1

Motor Run Capacitor—440VAC

Dual capacitance. Oval, metal can.



CATALOG NO.	uf	UOM	ORDER MULTIPLE
4JJ0525	25+5	EA	1
4JJ0530	30+5	EA	1
4JJ0535	35+5	EA	1
4JJ0540	40+5	EA	1
4JJ0545	45+5	EA	1
4JJ0555	55+5	EA	1
4JJ7535	35+7.5	EA	1
4JJ7540	40+7.5	EA	1
4JJ7545	45+7.5	EA	1
4JJ1055	55+10	EA	1
4JJ0560	60+5	EA	1

Motor Run Capacitor—440VAC

Dual capacitance. Round, metal can.



CATALOG NO.	uf	UOM	ORDER MULTIPLE
4JR0520	20+5	EA	1
4JR0525	25+5	EA	1
4JR7525	25+7.5	EA	1
4JR0530	30+5	EA	1
4JR7530	30+7.5	EA	1
4JR0535	35+5	EA	1
4JR7535	35+7.5	EA	1
4JR0440	40+4	EA	1
4JR0540	40+5	EA	1
4JR7540	40+7.5	EA	1
4JR0545	45+5	EA	1
4JR7545	45+7.5	EA	1
4JR0550	50+5	EA	1
4JR7550	50+7.5	EA	1
4JR0555	55+5	EA	1
4JR1055	55+10	EA	1
4JR7555	55+7.5	EA	1
4JR0560	60+5	EA	1
4JR7560	60+7.5	EA	1
4JR1060	60+10	EA	1
4JR0570	70+5	EA	1
4JR7570	70+7.5	EA	1
4JR0580	80+5	EA	1
4JR7580	80+7.5	EA	1
4JR1080	80+10	EA	1

MOTOR RUN CAPACITORS (USA MADE)

Made in the U.S.A. Capacitors Round Metal Can

Line of made in the USA capacitors featuring dual voltage for both 370V and 440V applications. Designed specifically for the demands of aftermarket service parts.



CATALOG NO.	VOLTAGE	uf	UOM	ORDER MULTIPLE
4JR0525U	370V/440V	25+5	EA	1
4JR0530U	370V/440V	30+5	EA	1
4JR7530U	370V/440V	30+7.5	EA	1
4JR0535U	370V/440V	35+5	EA	1
4JR7535U	370V/440V	35+7.5	EA	1
4JR0540U	370V/440V	40+5	EA	1
4JR7540U	370V/440V	40+7.5	EA	1
4JR0545U	370V/440V	45+5	EA	1
4JR7545U	370V/440V	45+7.5	EA	1
4JR0550U	370V/440V	50+5	EA	1
4JR7550U	370V/440V	50+7.5	EA	1
4JR0555U	370V/440V	55+5	EA	1
4JR7555U	370V/440V	55+7.5	EA	1
4JR0560U	370V/440V	60+5	EA	1
4JR7560U	370V/440V	60+7.5	EA	1
4JR0580U	370V/440V	80+5	EA	1

Motor Start Capacitors – 110/125 VAC

Variable capacitance. Round, plastic can.



CATALOG NO.	uf	UOM	ORDER MULTIPLE
56-72	56-72	EA	1
88-108	88-108	EA	1
108-130	108-130	EA	1
124-156	124-156	EA	1
145-175	145-175	EA	1
161-193	161-193	EA	1
189-227	189-227	EA	1
200-240	200-240	EA	1
216-259	216-259	EA	1
233-292	233-292	EA	1
270-324	270-324	EA	1
324-388	324-388	EA	1
340-408	340-408	EA	1
378-440	378-440	EA	1
400-480	400-480	EA	1
460-552	460-552	EA	1
540-648	540-648	EA	1
590-708	590-708	EA	1
708-850	708-850	EA	1
829-995	829-995	EA	1
1000-1200	1000-1200	EA	1

Made in the U.S.A. Capacitors Oval Metal Can

Line of made in the USA capacitors featuring dual voltage for both 370V and 440V applications. Designed specifically for the demands of aftermarket service parts.



CATALOG NO.	VOLTAGE	uf	UOM	ORDER MULTIPLE
45050HU	370V/440V	5	EA	1
45075HU	370V/440V	7.5	EA	1
45100HU	370V/440V	10	EA	1
45150HU	370V/440V	15	EA	1
45200HU	370V/440V	20	EA	1
45250HU	370V/440V	25	EA	1
45300HU	370V/440V	30	EA	1
45350HU	370V/440V	35	EA	1
45400HU	370V/440V	40	EA	1
45450HU	370V/440V	45	EA	1
45125HU	370V/440V	12.5	EA	1
45500HU	370V/440V	50	EA	1
45600HU	370V/440V	60	EA	1
45700HU	370V/440V	70	EA	1
45800HU	370V/440V	80	EA	1

Motor Start Capacitors – 220/250 VAC

Variable capacitance. Round, plastic can.



CATALOG NO.	uf	UOM	ORDER MULTIPLE
43-53220	43-53	EA	1
56-72220	56-72	EA	1
72-88220	72-88	EA	1
88-108220	88-108	EA	1
108-130220	108-130	EA	1
124-156220	124-156	EA	1
145-175220	145-175	EA	1
161-193220	161-193	EA	1
189-227220	189-227	EA	1
216-259220	216-259	EA	1
233-292220	233-292	EA	1
270-324220	270-324	EA	1

MOTOR RUN CAPACITORS (USA MADE) cont'd

Motor Start Capacitors – 330 VAC

Variable capacitance. Round, plastic can.



CATALOG NO.	uf	UOM	ORDER MULTIPLE
72-88330	72-88	EA	1
88-108330	88-108	EA	1
108-130330	108-130	EA	1
124-156330	124-156	EA	1
145-175330	145-175	EA	1
161-193330	161-193	EA	1
189-227330	189-227	EA	1
216-259330	216-259	EA	1
270-324330	270-324	EA	1

HARD START KITS

Torque Plus—Hard Start Kits

Totally solid state, our DST 5 is just right for all permanent split capacitor (PSC) compressors from 1/2 to 10 H.P. It can be used on units that operate on 120 through 288 Volts. The DST 6 offers a larger capacitor for severely hard to start compressors. The DST 6 can be used on all PSC single phase compressors from 1 1/2 to 10 H.P. A unique combination of relay and safety timer. The capacitor is automatically disconnected in 0.5 seconds if the compressor fails to start.



CATALOG NO.	DESCRIPTION	UOM	ORDER MULTIPLE
DST-5	Torque Plus – 300% Torque Multiplier	EA	1
DST-6	Torque Plus – 500% Torque Multiplier	EA	1

DiversiTech Hard Start Kits

DiversiTech hard start kits reduce contractor call backs by boosting the starting capacitor for a compressor. This prevents home brownouts and improves homeowner satisfaction with your service. DiversiTech's hard start kits feature a potential relay that disconnects the start capacitor from the circuit at exactly the moment it is no longer needed to boost the compressor. This results in a precision compressor start even under hard starting conditions. Replaces the Kickstart KS-1 and the 5-n-1 kit.



CATALOG NO.	DESCRIPTION	UOM	ORDER MULTIPLE
HSK1	Hard Start Kit for 3.5 to 5HP Compressor	EA	1
HSK5	Hard Start Kit for 1 to 3HP Compressor	EA	1

CONTACTORS

DiversiTech® Two Pole Definite Purpose Contactors

Definite purpose contactors can be used for heating, air conditioning, refrigeration, data processing, and food service equipment. Quick connect terminals provide for easy wiring. This contactor comes as a two pole on a small frame.



EC30224

CATALOG NO.	FL AMPS	COIL VAC	UOM	ORDER MULTIPLE
EC25224	25	24	EA	1
EC25120	25	120	EA	1
EC252240	25	240	EA	1
EC252277	25	277	EA	1
EC30224	30	24	EA	1
EC302120	30	120	EA	1
EC302240	30	240	EA	1
EC40224	40	24	EA	1
EC402120	40	120	EA	1
EC402240	40	240	EA	1

Eaton Definite Purpose Contactors - Three and Four Pole

These are Eaton's standard line of C25 DP contactors. They feature pressure plates with quick connects for 25A and 30A contactors, and lugs and quick connects for 40A to 90A contactors. They are UL recognized and CSA certified components. These contactors are designed for the HVAC and refrigeration applications.



DPE303120

DPE404120



CATALOG NO.	POLES	FL AMPS	COIL VAC	UOM	ORDER MULTIPLE
DPE253120	3	25	120	EA	1
DPE25324	3	25	24	EA	1
DPE253240	3	25	240	EA	1
DPE303120	3	30	120	EA	1
DPE30324	3	30	24	EA	1
DPE303240	3	30	240	EA	1
DPE303277	3	30	277	EA	1
DPE303480	3	30	480	EA	1
DPE403120	3	40	120	EA	1
DPE40324	3	40	24	EA	1
DPE403240	3	40	240	EA	1
DPE403480	3	40	480	EA	1
DPE503120	3	50	120	EA	1
DPE50324	3	50	24	EA	1
DPE503240	3	50	240	EA	1
DPE603120	3	60	120	EA	1
DPE60324	3	60	24	EA	1
DPE603240	3	60	240	EA	1
DPE753120	3	75	120	EA	1
DPE75324	3	75	24	EA	1
DPE753240	3	75	240	EA	1
DPE903120	3	90	120	EA	1
DPE90324	3	90	24	EA	1
DPE903240	3	90	240	EA	1
DPE304120	4	30	120	EA	1
DPE30424	4	30	24	EA	1
DPE304240	4	30	240	EA	1
DPE304277	4	30	277	EA	1
DPE404120	4	40	120	EA	1
DPE404240	4	40	240	EA	1
DPE404277	4	40	277	EA	1

DiversiTech® Three Pole Definite Purpose Contactors

Definite purpose contactors can be used for heating, air conditioning, refrigeration, data processing, and food service equipment. Quick connect terminals provide for easy wiring. This contactor comes as a three pole on a large frame.



EC30324

CATALOG NO.	FL AMPS	COIL VAC	UOM	ORDER MULTIPLE
EC30324	30	24	EA	1
EC303120	30	120	EA	1
EC303240	30	240	EA	1
EC303277	30	277	EA	1
EC40324	40	24	EA	1
EC403120	40	120	EA	1
EC403240	40	240	EA	1
EC403277	40	277	EA	1
EC50324	50	24	EA	1
EC503120	50	120	EA	1
EC503240	50	240	EA	1
EC503277	50	277	EA	1
EC60324	60	24	EA	1
EC603120	60	120	EA	1
EC603240	60	240	EA	1
EC603277	60	277	EA	1
EC75324	75	24	EA	1
EC753120	75	120	EA	1
EC753240	75	240	EA	1
EC753277	75	277	EA	1
EC90324	90	24	EA	1
EC903120	90	120	EA	1
EC903240	90	240	EA	1
EC903277	90	277	EA	1

Eaton Definite Purpose Contactors - One and Two Pole

These are single- and two-pole, Type C25 contactors feature a compact, efficient design with a low VA coil and straight-through wiring. Its housing design effectively limits dust and other contaminants from magnet structure—reduces or eliminates noise. They are UL recognized/CSA certified, ampere rated devices are well suited for use in heating/air conditioning, refrigeration, data processing and food service applications.



DPE30124

DPE30224



CATALOG NO.	POLES	FL AMPS	COIL VAC	UOM	ORDER MULTIPLE
DPE301120	1	30	120	EA	1
DPE30124	1	30	24	EA	1
DPE301240	1	30	240	EA	1
DPE401120	1	40	120	EA	1
DPE40124	1	40	24	EA	1
DPE252120	2	25	120	EA	1
DPE25224	2	25	24	EA	1
DPE252240	2	25	240	EA	1
DPE302120	2	30	120	EA	1
DPE30224	2	30	24	EA	1
DPE302240	2	30	240	EA	1
DPE302277	2	30	277	EA	1
DPE402120	2	40	120	EA	1
DPE40224	2	40	24	EA	1
DPE402240	2	40	240	EA	1
DPE402480	2	40	480	EA	1
DPE602120	2	60	120	EA	1

CONTACTORS cont'd

Eaton Contactor Accessories

These auxiliary contacts are side mounted contact kits for Eaton's definite purpose contactors with contact rating of 15A to 75A.



CATALOG NO.	DESCRIPTION	UOM	ORDER MULTIPLE
DPEAUX10	15-75A, 1NO	EA	1
DPEAUX11	15-75A, 1NO-1NC	EA	1
DPEAUX11QC	15-75A, 1NO-1NC with Quick Connect	EA	1
DPEAUX20	15-75A, 2NO	EA	1
DPEAUX22	25-75A, 2NO-2NC	EA	1

TRANSFORMERS

**Transformers – Class 2 1585
UL Recognized**

The transformers provide the power source for heating, air conditioning, or refrigeration systems.



CATALOG NO.	VA	PRI	SEC	UOM	ORDER MULTIPLE
T1401	40	120	24	EA	1
T1404	40	120/208/240	24	EA	1

**Transformers – Class 2 1585
UL Recognized**

The transformers provide the power source for heating, air conditioning, or refrigeration systems.

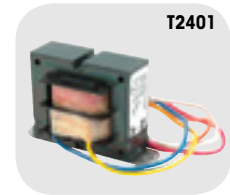

CATALOG NO.	VA	PRI	SEC	UOM	ORDER MULTIPLE
T2401	40	120	24	EA	1
T2403	40	208/240	24	EA	1
T2404	40	120/208/240	24	EA	1

**Transformers – Class 2 1585
UL Recognized**

The transformers provide the power source for heating, air conditioning, or refrigeration systems. These are multi mounted with wire connection secondary.



CATALOG NO.	VA	PRI	SEC	UOM	ORDER MULTIPLE
T3401	40	120	24	EA	1
T3403	40	120/208/240	24	EA	1
T3501	50	120/208/240	24	EA	1
T5401	40	120	24	EA	1

**Transformers – Class 2 1585
UL Recognized**

Heavy duty with external fuse (T67XX) or circuit breaker (T77XX).



CATALOG NO.	VA	PRI	SEC	UOM	ORDER MULTIPLE
T6752	75	120/208/240	24	EA	1
T6753	75	120/208/240/480	24	EA	1
T7752	75	120/208/240/480	24	EA	1

RELAYS

General Purpose Relays – 9400 Series

This product features quick connect terminals with universal mounting with break away tabs.

CATALOG NO.	DESCRIPTION	AMPS RES	FLA/LRA@125V	FLA/LRA@250V	COIL VOLTAGE	UOM	ORDER MULTIPLE
D90-360	SPST-NO	18	12/60	8/48	24 VAC	EA	1
D90-370	SPDT	18	12/60	8/48	24 VAC	EA	1
D90-372	SPDT	18	12/60	8/48	120 VAC	EA	1
D90-380	SPST NO+NC	18	12/60	8/48	24 VAC	EA	1
D90-382	SPST NO+NC	18	12/60	8/48	120 VAC	EA	1
D90-384	SPST NO+NC	18	12/60	8/48	240 VAC	EA	1



General Purpose Relays – 8400 Series

This product features quick connect terminals with universal mounting with break away tabs



CATALOG NO.	DESCRIPTION	AMPS RES/IND	COIL VOLTAGE	UOM	ORDER MULTIPLE
D90-290Q	SPST-NO	16/8	24 VAC	EA	1
D90-291Q	SPST-NO	16/8	120 VAC	EA	1
D90-292Q	SPST-NO	16/8	240 VAC	EA	1
D90-293Q	SPDT	8/8	24 VAC	EA	1
D90-294Q	SPDT	8/8	120 VAC	EA	1
D90-295Q	SPDT	8/8	240 VAC	EA	1

Potential Relays

The Potential Relay has SPST NC configurations and offers a variety of mounting positions.



CATALOG NO.	COIL VOLTAGE	PICK-UP MIN	PICK-UP MAX	DROP-OUT MAX	UOM	ORDER MULTIPLE
DPR063	168	140	153	45	EA	1
DPR064	395	242	272	140	EA	1
DPR066	395	223	252	130	EA	1

General Purpose Switching Relays

The Switching Relay has quick connect terminals for termination. The base is designed for easy replacement of competitive relays.



CATALOG NO.	COIL VOLTAGE	TERMINALS 1-2-3	TERMINALS 4-5-6	UOM	ORDER MULTIPLE
D-90340	24	POWER	POWER	EA	1
D-90341	110/120	POWER	POWER	EA	1
D-90342	208/240	POWER	POWER	EA	1

FAN CENTERS

The fan centers offer low voltage for one and two speed fan motors; auxiliary circuits in heating cooling, or heating/ cooling applications. This has a DPDT Relay and is UL rated. There are color coded pre stripped leads on this center. This product has a 24V coil voltage, power, and duty rated contacts. It mounts directly to a 4in. electrical box.



CATALOG NO.	VOLTAGE	UOM	ORDER MULTIPLE
D-90113	120	EA	1
D-90118	208/240	EA	1

FUSES

Dual Element Fuses – 250V

Provides time delay for temporary over current conditions and motor running protection for heating and air conditioning equipment. Eliminates unnecessary maintenance from harmless overloads. U.L. Class RK 5, Standard for Safety 198E, Current Limiting Fuses, Interrupting Rating 200,000 Amps. rms. A.C.



7-CRNR40

CATALOG NO.	DESCRIPTION	UOM	ORDER MULTIPLE
7-CRNR15	15 Amps	EA	10
7-CRNR20	20 Amps	EA	10
7-CRNR25	25 Amps	EA	10
7-CRNR30	30 Amps	EA	10
7-CRNR35	35 Amps	EA	10
7-CRNR40	40 Amps	EA	10
7-CRNR45	45 Amps	EA	10
7-CRNR50	50 Amps	EA	10
7-CRNR60	60 Amps	EA	10
7-CRNR70	70 Amps	EA	5
7-CRNR80	80 Amps	EA	5
7-CRNR90	90 Amps	EA	5
7-CRNR100	100 Amps	EA	5

U.L. Class RK-5, Standard for Safety 198E, Current Limiting Fuses, Interrupting Rating 200,000 Amps. rms. A.C.

Time Delay Fuses – 600V

These plugs offer safe protection during momentary overload. No adapter necessary. U.L. Listed.



626-HASR15

CATALOG NO.	DESCRIPTION	UOM	ORDER MULTIPLE
626-HASR10	10 Amp	EA	10
626-HASR15	15 Amp	EA	10
626-HASR20	20 Amp	EA	10
626-HASR25	25 Amp	EA	10
626-HASR30	30 Amp	EA	10
626-HASR40	40 Amp	EA	10
626-HASR60	60 Amp	EA	10

U.L. Listed.

Plug Fuses

Expels gases caused by the blowing fuse, but doesn't allow flame to escape. Glass top for safety against shock. Positive visual indication of OK condition or blown condition. Distinguishes between overload and dead short conditions. Magnifying center of face. Shapes of face openings identify ratings. Meets Federal Specification WF 791E/Gen. Type 791/1. Base "W" fuses. U.L. Listed.



626-30

CATALOG NO.	DESCRIPTION	UOM	ORDER MULTIPLE
626-15	Plug Fuse Type TL – 15 Amp	EA	4
626-20	Plug Fuse Type TL – 20 Amp	EA	4
626-25	Plug Fuse Type TL – 25 Amp	EA	4
626-30	Plug Fuse Type TL – 30 Amp	EA	4

U.L. Listed.

One Time Fuses

Protection to lighting, heating, and other non transient circuits. U.L. Class H, Standard for Safety 1988, One Time Fuse Interrupting Rating 10,000 Amps. rms. A.C.



7-10KOTN40

CATALOG NO.	DESCRIPTION	UOM	ORDER MULTIPLE
7-10KOTN30	30 Amps	EA	10
7-10KOTN35	35 Amps	EA	10
7-10KOTN40	40 Amps	EA	10
7-10KOTN45	45 Amps	EA	10
7-10KOTN50	50 Amps	EA	10
7-10KOTN60	60 Amps	EA	10
7-10KOTN70	70 Amps	EA	5
7-10KOTN80	80 Amps	EA	5
7-10KOTN90	90 Amps	EA	5
7-10KOTN100	100 Amps	EA	5

U.L. Class H, Standard for Safety 1988, One Time Fuse Interrupting Rating 10,000 Amps. rms. A.C.

Time Delay Plug Fuses

These plugs offer safe protection during momentary overload. No adapter necessary. U.L. Listed.



626-30T

CATALOG NO.	DESCRIPTION	UOM	ORDER MULTIPLE
626-10T	Type "T" Plug Fuse – 10 Amp	EA	4
626-15T	Type "T" Plug Fuse – 15 Amp	EA	4
626-20T	Type "T" Plug Fuse – 20 Amp	EA	4
626-25T	Type "T" Plug Fuse – 25 Amp	EA	4
626-30T	Type "T" Plug Fuse – 30 Amp	EA	4

U.L. Listed.

Type "S" Non-Tamper Fuses

Provides specific overcurrent protection. Time delay element protects against premature blowing from motors in air conditioners or compressors. Visual indication of good or blown condition. U.L. Listed. C.S.A. Approved.



626-30S

CATALOG NO.	DESCRIPTION	UOM	ORDER MULTIPLE
626-6S	Type "S" Fuse – 6.25 Amp	EA	4
626-10S	Type "S" Fuse – 10 Amp	EA	4
626-15S	Type "S" Fuse – 15 Amp	EA	4
626-20S	Type "S" Fuse – 20 Amp	EA	4
626-25S	Type "S" Fuse – 25 Amp	EA	4
626-30S	Type "S" Fuse – 30 Amp	EA	4

U.L. Listed. C.S.A. Approved.

FUSES cont'd

In-Line Fuse Holder

For fusing all control circuits up to 30 amp. Features rigid plastic protective covering for each fuse. Used on AC and DC circuits. U.L. Listed.

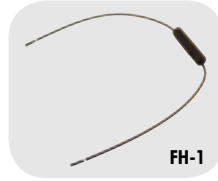

CATALOG NO.	DESCRIPTION	UOM	ORDER MULTIPLE
FH-1	In-Line Fuse Holder	EA	10

U.L. Listed.

Fuse Pullers

Our fuse pullers are used to safely pull fuses



CATALOG NO.	DESCRIPTION	UOM	ORDER MULTIPLE
626-38071	Fuse Puller – For Fuse Sizes 1/4" to 1/2"	EA	1
626-38073	Fuse Puller – For Fuse Sizes 1" to 1-3/4"	EA	1

Fuseblocks

The fuse blocks are designed to allow the fuse to blow or burn out before the component can be damaged.



CATALOG NO.	DESCRIPTION	UOM	ORDER MULTIPLE
626-23133	Fuseblock – 1 Pole Screw Class H, 250V	EA	1
626-23233	Fuseblock – 2 Pole Screw Class H, 250V	EA	1
626-23333	Fuseblock – 3 Pole Screw Class H, 250V	EA	1
626-26311	Fuseblock – 3 Pole Box Lug Class H, 250V	EA	1

Blade (Auto) Fuses

These fuses are fast acting low voltage supplementary fuses, automotive blade style fuse.



CATALOG NO.	DESCRIPTION	UOM	ORDER MULTIPLE
626-AT0003	Blade Fuse – 3 Amp – Purple, pack of 5	EA	100
626-AT0005	Blade Fuse – 5 Amp – Tan, pack of 5	EA	100

Fuse Adapters

Fuse adapters are used to retrofit fuses into existing installations.



CATALOG NO.	DESCRIPTION	UOM	ORDER MULTIPLE
626-38632	Fuse Adapter – 60 to 30 Reducer for Class H, 250V	EA	1
626-38636	Fuse Adapter – 60 to 30 Reducer for Class H, 600V	EA	1

Box Cover Units

The maximum amps on this box cover unit are 15 and the maximum AC voltage of 125. These units are designed for use with the Type T plug fuses. U.L. Listed and C.S.A. Certified.



CATALOG NO.	DESCRIPTION	UOM	ORDER MULTIPLE
620-608	Switch/Fuse Combo (ESSU)	EA	1
620-6081	Plug Fuse Base Only (ESOU)	EA	1
620-6082	Receptacle/Fuse Combo (ESRU)	EA	1
620-6083	Switch/Fuse Combo Square (ESSY)	EA	1

U.L. Listed and C.S.A. Certified.

TIME DELAYS

Adjustable Delay on Break Timer

Adjusts from 6 seconds to 8 minutes. Spin-proof knob. Works with 24, 120 or 240 VAC control circuits. Supports up to 1.0 Amps. Two wire hookup for easy installation. Solid state with quick disconnect terminals. Mounts with one self-tapping screw. Conformal coated circuitry protects against moisture and shock. UR recognized for USA and Canada. Works with anticipator type thermostats.

HOW IT WORKS: Immediately upon application of power, the Delay on Break timer enables circuit operation. Once power is interrupted, the circuit opens for the time set on the dial. After the time period elapses, the circuit closes, allowing the protected motor or compressor to start. For typical HVAC applications, the operation of the timer is transparent and will go unnoticed.



CATALOG NO.	DESCRIPTION	UOM	ORDER MULTIPLE
ADB-1	Adjustable Delay on Break	EA	1
ADB-2	Adjustable Delay on Break w/Wire Leads	EA	1

Adjustable Delay on Make Timer

Ideal for random starting of multiple units. Adjusts from 6 seconds to 8 minutes. Spin proof knob. Works with 24, 120 or 240 VAC control circuits. Supports up to 1.0 Amps. Two wire hookup for easy installation. Solid state with quick-disconnect terminals. Mounts with one self-tapping screw. Conformal coated circuitry protects against moisture and shock. UR recognized for US and Canada. Works with anticipator type thermostats.

HOW IT WORKS: These timers delay circuit closure upon application of power. Only after the set time period elapses and power remains ON will the circuit close, allowing the protected motor or compressor to start. For typical HVAC installations, timers are adjusted to random times to prevent power circuit overloads, thus are often called random start timers.



CATALOG NO.	DESCRIPTION	UOM	ORDER MULTIPLE
ADM-1	Adjustable Delay on Make	EA	1
ADM-2	Adjustable Delay on Make w/Wire Leads	EA	1

Digital Three Phase Line Voltage Monitor

Offers continuous protection against voltage anomalies which can damage compressors, motors and other sensitive electrically operated devices.

PROTECTION: Loss of Phase, Phase Reversal, Voltage Imbalance, Low Voltage, High Voltage

DISPLAY: Large custom LCD display indicates all operating conditions at a glance. Three large sets of digits provide easy system troubleshooting.

VOLTMETER: Three independent voltmeters read both line and contactor load (backside) voltages.

MONITORED VOLTAGE: 160 to 600 Volts 50-60 Hz.

POWER SUPPLY: Power for the WPC-500 is automatically derived from any active phase. System operation is not dependent on the control voltage or a specific phase for power.

CONTROL VOLTAGE: 19-277 VAC. Anticipator load is provided for operation with 24 volt electronic and mechanical thermostats.

OPERATING VOLTAGE SET POINT: 175 to 650 VAC. Digitally adjustable in one volt increments.

VOLTAGE TRIP POINT: Adjustable in 1% increments between 6% and 18% of selected operating voltage. Restart voltage set point (hysteresis) fixed at cutout voltage + 3%.

VOLTAGE SYMMETRY: Adjustable imbalance trip point from 2% to 25% of selected operating voltage.

RESPONSE TIMES:

Phase Loss/Reversal: 100 mS max.

Imbalance: Adjustable Response Timer

Over or Under Voltage: Adjustable Response Timer

LOCKOUT DELAY TIMER: Fully adjustable 0 to 720 Seconds (0 to 12 minutes). Digital display shows re-remaining time and user set points.

SEQUENTIAL START TIMER: 0 to 30 seconds in one second increments.

RESPONSE TIMER: 0.1 to 20 Seconds. Digital display shows remaining time and user set points.

MEMORY: Up to 25 past fault conditions are stored for later retrieval and analysis. The faults may be displayed or cleared by the front panel buttons.



DTP-3

Digital Single Phase Line Voltage Monitor

Automatic voltage monitor and control system. Continuously measures incoming line voltage, allowing detection of any voltage outside the tolerances that you set. If these limits are exceeded, the response timer begins counting. You may also set response time – a short time for a quick response or a long time to avoid nuisance tripping. If the voltage remains outside the tolerance after the time has elapsed, the DSP-1 will turn off its output relay and protect your device. While output is off, an additional delay timer activates to avoid rapid restarts.

FEATURES:

- Digital voltmeter displays instantaneous line voltage;
- Automatic voltage tester adjusts from 90 to 300 volts;
- Adjustable response timer (0.1 to 10 sec.) prevents nuisance tripping;
- Adjustable delay timer (1 to 720 sec.) prevents rapid restarts;
- Digital display makes for easy viewing and operation

SPECIFICATIONS:

- Voltmeter: 70 to 325 Volts
- Voltage Set Point: 90 to 300 Volts
- Tolerance Limits: 6 to 18%
- Response Timer: 0.1 to 10 seconds
- Delay Timer: 1 to 720 seconds
- Output Relay: 10 Amps, 250 VAC resistive, single-pole/double-throw
- Control Input: 18 to 250 VAC with anticipator load for 24 volt thermostats



DSP-1

CATALOG NO.	DESCRIPTION	UOM	ORDER MULTIPLE
DSP-1	Digital Single Phase Motor Protector	EA	1

CATALOG NO.	DESCRIPTION	UOM	ORDER MULTIPLE
DTP-3	Digital 3-Phase Motor Protector	EA	1

ELECTRICAL SUPPLIES

Electrical Toggle Switches

Side wire design with automatic grounding and large binding head terminal screws for fast wiring. Lubricated cam provides smooth lever action. U.L. Listed. C.S.A. Certified. Verified to Federal Spec. WS896E



620-601

CATALOG NO.	DESCRIPTION	UOM	ORDER MULTIPLE
620-600	20A-1 HP 120V, Single Pole, Brown	EA	10
620-601	20A-1 HP 120V, Single Pole, Ivory	EA	10
625-CS120W	20A-1HP 120V Single Pole, White	EA	10
625-1301W	15A-1/2HP 120V Single Pole, White	EA	10
620-604	15A-1/2 HP 120V, Single Pole, Brown	EA	10
620-605	15A-1/2 HP 120V, Single Pole, Ivory	EA	10

U.L. Listed. C.S.A. Certified. Verified to Federal Spec. WS896E.

Electrical Outlet Boxes, Extensions and Covers

We have 4in. steel octagon boxes, extensions, and covers available. Conforms to Article 370 of NEC. U.L. Listed.



620-300 620-303
620-304 620-306

CATALOG NO.	DESCRIPTION	UOM	ORDER MULTIPLE
620-300	1-1/2" Deep, 1/2" and 3/4" K.O.s	EA	50
620-303	Flat Blank Cover	EA	50
620-304	Flat, Duplex Receptacle Cover	EA	50
620-306	Flat Cover 1/2" K.O. in Center	EA	50

Conforms to Article 370 of NEC. U.L. Listed.

Electrical Outlet Boxes, Extensions and Covers

We have 4 11/16in. steel square boxes, extensions, and covers available. Conforms to Article 370 of NEC. U.L. Listed.



620-502

CATALOG NO.	DESCRIPTION	UOM	ORDER MULTIPLE
620-502	Raised Cover for Single Device	EA	25

Conforms to Article 370 of NEC. U.L. Listed.

Electrical Duplex Receptacles

Automatic grounding for fast installation. Heavy duty mounting strap for additional assembly strength. Copper alloy power/ground contacts for optimum continuity. Side wire design with large binding head terminal screws for fast wiring. U.L. Listed. C.S.A. Certified (NEMA 5 15 Type).

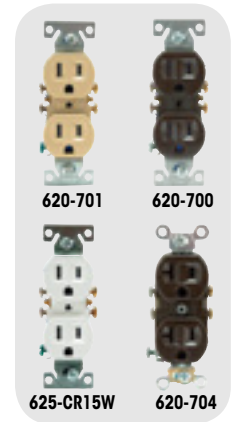

620-701 620-700
625-CR15W 620-704

CATALOG NO.	DESCRIPTION	UOM	ORDER MULTIPLE
620-700	15A, 125V, Brown	EA	10
620-701	15A, 125V, Ivory	EA	10
625-CR15W	15A 125V, White	EA	10
620-702	20A, 125V, Brown	EA	10
620-703	20A, 125V, Ivory	EA	10
625-CR20W	20A 125V, White	EA	10
620-704	15A, 125V, Brown – Residential	EA	10
620-705	15A, 125V, Ivory – Residential	EA	10
625-270W	15A 125V, White – Residential	EA	10

U.L. Listed. C.S.A. Certified (NEMA 5-15 Type).

Electrical Outlet Boxes, Extensions and Covers

We have 4in. steel square boxes, extensions, and covers available. Conforms to Article 370 of NEC. U.L. Listed.



620-400 620-403
620-404 620-405
620-406 620-411

CATALOG NO.	DESCRIPTION	UOM	ORDER MULTIPLE
620-400	1-1/4" Deep, 1/2" K.O.s	EA	50
620-401	2-1/8" Deep, 1/2" and 3/4" K.O.s	EA	25
620-403	1-1/2" Deep, 1/2" K.O.s	EA	50
620-404	1-1/2" Deep, 1/2" and 3/4" K.O.s Extension	EA	50
620-405	Flat Cover 1/2" K.O. in Center	EA	50
620-406	Flat Blank Cover	EA	50
620-408	Flat, One Toggle Switch Cover	EA	50
620-409	Flat, One Duplex Receptacle Cover	EA	50
620-411	One Switch and One Duplex Receptacle Cover	EA	50

Conforms to Article 370 of NEC. U.L. Listed.

Electrical Outlet Boxes, Extensions and Covers

Standard steel utility (Handy) boxes and covers.



CATALOG NO.	DESCRIPTION	UOM	ORDER MULTIPLE
620-200	1-1/2" Deep, 1/2" K.O.s	EA	50
620-201	1-7/8" Deep, 1/2" K.O.s	EA	50
620-202	2-1/8" Deep, 1/2" K.O.s	EA	50
620-20134	1-7/8" Deep, 3/4" K.O.s	EA	50
620-252	Flat, Two Duplex Receptacle Cover	EA	100
620-253	Flat, Toggle Switch Cover	EA	100
620-254	Flat Blank Cover	EA	100
620-255	Flat Cover 1/2" K.O.	EA	100

Conforms to Article 370 of NEC. U.L. Listed.

Switch/Plug Combo

Use with air handlers and condensate pumps. Touch-A-Matic design, with exclusive spring loaded steel ball mechanism for smooth, positive contact movement. Small neon pilot light ON when switch is ON, is built-in to the switch on switch/receptacle.



CATALOG NO.	DESCRIPTION	UOM	ORDER MULTIPLE
620-274W	White 2P 3W Grounding—15A 120V	EA	10

U.L. Listed. C.S.A. Approved.

Eaton Circuit Breakers - Type BR

Type BR Circuit Breakers are 1-inch per pole plug-on circuit breakers designed for Eaton's Type BR Loadcenters. They are 10 kAIC arc fault circuit interrupters rated for 120VAC or 240VAC applications.



CATALOG NO.	DESCRIPTION	UOM	ORDER MULTIPLE
BR115	Single Pole, 15A	EA	10
BR120	Single Pole, 20A	EA	10
BR130	Single Pole, 30A	EA	10
BR140	Single Pole, 40A	EA	10
BR150	Single Pole, 50A	EA	10
BR215	Two Pole, 15A	EA	5
BR220	Two Pole, 20A	EA	5
BR230	Two Pole, 30A	EA	5
BR240	Two Pole, 40A	EA	5
BR250	Two Pole, 50A	EA	5
BR260	Two Pole, 60A	EA	5
BR270	Two Pole, 70A	EA	5
BR2100	Two Pole, 100A	EA	5

Plastic Wall Plates

Non flammable thermoplastic, phenolic or urea material. Color matched 1/2in. long steel mounting screws furnished. Smooth surface – no recessed areas to collect dirt, discolor. Easy to clean. Full weight and thickness provide high dielectric strength, minimum moisture absorption, impact resistance. Warp resistant, fit flush to wall. U.L. Listed. C.S.A. Approved.



CATALOG NO.	DESCRIPTION	UOM	ORDER MULTIPLE
625-2132B	Duplex Receptacle Cover – Brown	EA	25
625-2132V	Duplex Receptacle Cover – Ivory	EA	10
625-2132W	Duplex Receptacle Cover – White	EA	10
625-2134B	Single Toggle Cover – Brown	EA	25
625-2134V	Single Toggle Cover – Ivory	EA	25
625-2134W	Single Toggle Cover – White	EA	25

U.L. Listed. C.S.A. Approved.

Switch Covers

Our switch covers come with gas, oil, or emergency already printed on them.

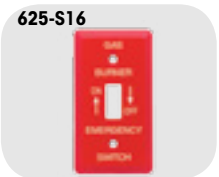

CATALOG NO.	SIZE	TYPE	DESCRIPTION	UOM	ORDER MULTIPLE
625-S17	4" X 4"	Gas	4" Square Box	EA	10
625-S16	4-1/4" X 2-3/4"	Gas	Utility/Handy Box	EA	1
625-S15	4-1/2" X 2-1/2"	Gas	Flush Mount	EA	25
625-S14	4" X 4"	Oil	4" Square Box	EA	1
625-S13	4-1/4" x 2-3/4"	Oil	Utility/Handy Box	EA	1
625-S19	4-1/2" X 2-1/2"	Oil	Flush Mount	EA	1
625-S20	4-3/4" X 2-1/2"	Emergency	Switch Plate	EA	1
625-S18	3/4"		Switch Guard (Wall plate/ switch not included)	EA	1

Eaton Circuit Breakers - Type CH

Type CH Circuit Breakers are 3/4-inch per pole plug-on circuit breakers designed for Eaton's Type CH Loadcenters. They are 10 kAIC arc fault circuit interrupters rated for 120VAC or 240VAC applications.



CATALOG NO.	DESCRIPTION	UOM	ORDER MULTIPLE
CH115	Single Pole, 15A	EA	10
CH120	Single Pole, 20A	EA	10
CH215	Two Pole, 15A	EA	5
CH220	Two Pole, 20A	EA	5
CH230	Two Pole, 30A	EA	5
CH240	Two Pole, 40A	EA	5
CH250	Two Pole, 50A	EA	5
CH260	Two Pole, 60A	EA	5

ELECTRICAL SUPPLIES cont'd

Toggle Switches

These switches are available in single pole double pole. They are UL listed and furnished with screw terminals. The ratings are A:20A 125VAC, 20 250 VAC, 1 HP at 120 240 V and B 15A 125/250 VAC, ¾ HP at 240 V.



CATALOG NO.	DESCRIPTION	RATING	UOM	ORDER MULTIPLE
TS-1	Toggle Switch – SP-ST – ON/OFF	A	EA	1
TS-3	Toggle Switch – SP-DT-CO – ON/OFF/ON	B	EA	1
TS-4	Toggle Switch – DP-ST – ON/OFF	A	EA	1
TS-5	Toggle Switch – DP-DT – ON/OFF	A	EA	1

Toggle Switch Cover

Weatherproof body for toggle switches up to 15/16" long.



CATALOG NO.	DESCRIPTION	UOM	ORDER MULTIPLE
625-B1	Toggle Switch Cover	EA	5

Power Supply Cord (Pigtails)

Stranded bare copper conductors. Grounding conductors. PVC jacket. Right and straight angle male plug. 110 Volt. 16 AWG x 6' long. SPT 2.



CATALOG NO.	DESCRIPTION	UOM	ORDER MULTIPLE
625-16-6	Power Supply Cord – Straight Plug	EA	50
625-16-690	Power Supply Cord – 90 Degree Plug	EA	50

ELECTRICAL TAPES

Scotch 3M Super 33+ Electrical Tape

Premium grade, 7 mil thick, all-weather vinyl insulating tape. Performs continuously in a temperature ambient of up to 220°F and as low as 0°F. Resealable plastic case. Made in USA.



CATALOG NO.	DESCRIPTION	UOM	ORDER MULTIPLE
ET33	Super 33+ Electrical Tape – 3/4" x 66'	EA	10

Scotch 3M Super 88 Electrical Tape

Premium grade, 8.5 mil thick, all-weather vinyl insulating tape. Performs continuously in a temperature ambient of up to 220°F and as low as 0°F. Excellent resistance to abrasion, moisture, acids and corrosion. Packaged in a resealable plastic case. Made in the USA.



CATALOG NO.	DESCRIPTION	UOM	ORDER MULTIPLE
ET44	Super 88 Electrical Tape – 3/4" x 66'	EA	10

Scotch 35 Vinyl Electrical Tape

This 7 mil premium grade electrical vinyl tape stretches to conform to virtually any shape that requires color-coded insulation. Abrasion and weather resistant. Measures 3/4" x 66'.



CATALOG NO.	DESCRIPTION	UOM	ORDER MULTIPLE
ET35N	Vinyl Electrical Tape – Orange	EA	10
ET35G	Vinyl Electrical Tape – Green	EA	10
ET35R	Vinyl Electrical Tape – Red	EA	10
ET35W	Vinyl Electrical Tape – White	EA	10

Glass Cloth, Moisture Sealing, and Economy Electrical Tapes

This is a woven glass cloth tape designed to operate in 600 volt dry applications, requiring high mechanical strength and resistance to high temperatures. The glass cloth is specially treated and prepared to provide corrosion free protection. It will not shrink, rot, or burn and has a high tensile strength. It contains pressure sensitive thermosetting adhesive which performs as Class B temperature (266 degrees F / 130 degrees C). Provides heat stable insulation for hot spot applications. Highlight: Color White. Width 1/2in. Length 66 ft. Thickness 7 mil. Tensile Strength (2) 150 lb./in. Material Glass Cloth.



CATALOG NO.	DESCRIPTION	UOM	ORDER MULTIPLE
GC275	1/2" x 66' Glass Cloth Electrical Tape by 3M	EA	10
GC277	3/4" x 66' Glass Cloth Electrical Tape by 3M	EA	10
ET130C1	1" x 30' Moisture Sealing Splicing Tape by 3M	EA	24
ET22	3/4" x 66' Hiawatha Electrical Tape by 3M	EA	10
AT-1700	3/4" x 66' TemFlex™ by 3M	EA	10

Economy Electrical Tape

This tape is suitable for use up to 175 F (80C) and not more than 600V. The electrical tape is excellent for adhesion and UL listed.



CATALOG NO.	DESCRIPTION	UOM	ORDER MULTIPLE
6-3460	3/4" x 60' Economy Electrical Tape	EA	10

TERMINALS, CONNECTORS

Compressor Repair Kit

Finally, a product that simplifies the repair of burned or damaged spade terminals when reconnecting or replacing a compressor. Fits both non burned and burned terminals. Connects to the compressor via precision brass cylinders that fit over the terminals and connect with stainless steel set screws. Wires are permanently attached. Standard factory 600V, 65 strand machine wire. Easy to install and guaranteed for the life of the compressor.



CATALOG NO.	DESCRIPTION	UOM	ORDER MULTIPLE
TLC-3-8	3 Wire, 8 Gauge Connection Kit	EA	1
TLC-3-10	3 Wire, 10 Gauge Connection Kit	EA	1
TLC-3-12	3 Wire, 12 Gauge Connection Kit	EA	1

Replacement Compressor Leads

Extreme heat within compressors typically causes failure of wiring insulation. This can cause corrosion to the inner strands of copper within the wire used for compressor hook up. This reduces the power flow to the compressor causing the unit to overheat and can prevent the compressor from starting. A MINIMUM of 12in. of wire must be removed. The DiversiTech Replacement Compressor Leads are ideal for replacing this corroded wiring. 24in. leads also available for replacing wire all the way to the contactor and capacitor.



CATALOG NO.	DESCRIPTION	UOM	ORDER MULTIPLE
CC33	Compressor Leads – 12" with Butt, pack of 3	PK	1
CC33-18	Compressor Leads – 18" with Butt, pack of 3	PK	1
CC33-24	Compressor Leads – 24" with Ring, pack of 3	PK	1

Grommets – Vinyl (By Panel Hole Size)

Grommets safely route cables and wires through sharp edged cutouts.



CATALOG NO.	DESCRIPTION	UOM	ORDER MULTIPLE
GV04*	Grommets – 1/4", pack of 18	PK	1
GV05*	Grommets – 5/16", pack of 15	PK	1
GV06*	Grommets – 3/8", pack of 18	PK	1
GV07	Grommets – 7/16", pack of 12	PK	1
GV08*	Grommets – 1/2", pack of 12	PK	1
GV10*	Grommets – 5/8", pack of 7	PK	1
GV12	Grommets – 3/4", pack of 3	PK	1
GV14*	Grommets – 7/8", pack of 4	PK	1
GV16*	Grommets – 1", pack of 4	PK	1
GVA1	Assortment – Small – GV04, GV05, GV06, GV07, GV08, pack of 15	PK	1
GVA2	Assortment – Large – GV08, GV10, GV12, GV14, GV16, pack of 5	PK	1

Sizes shown above also available in 100 packs. Replace "" with "C" for part number.

Transparent Plastic Boxes with Terminal Assortments

Boxes are made of soft, pliable, durable K resin with 18 compartments containing the most popular terminals, including hi temp and compressor terminals.



CATALOG NO.	DESCRIPTION	UOM	ORDER MULTIPLE
PA10	180 Terminals (10 Each Kind)	EA	1
PA25	360 Terminals (20 Each Kind)	EA	1
PA25AP	Appliance Parts Technician Assortment (mostly Hi-Temp)	EA	1
PA18	"K" Resin Plastic Box Only	EA	1

Compartmented Storage Boxes

These boxes can be used to store your compressor terminals, nylon ties and clamps.



CATALOG NO.	DESCRIPTION	UOM	ORDER MULTIPLE
MB21	21 Compartmented Metal Box	EA	1
MB22	21 Compartmented Metal Box w/230 popular EA items including hi-temp and compressor terminals, nylon ties and clamps	EA	1

Heat Shrink Tubing – Polyolefin 50% Shrink, Black Commercial Grade

Our shrinking tube is economical and mechanically tough heat shrinkable tubing used for insulating, jacketing and identification.



CATALOG NO.	DESCRIPTION	UOM	ORDER MULTIPLE
HS03	3/16" I.D. Expanded – 4" Long, pack of 8	PK	1*
HS04	1/4" I.D. Expanded – 4" Long, pack of 7	PK	1*
HS04-100	1/4" I.D. Expanded, 100' roll	EA	1
HS06	3/8" I.D. Expanded – 4" Long, pack of 6	PK	1*
HS08	1/2" I.D. Expanded – 4" Long, pack of 5	PK	1*
HS16	1" I.D. Expanded – 4" Long, pack of 3	PK	1*
HSA1	Assorted 3/16", 1/4", 3/8" – 4" Long, pack of 7	PK	1
HSA2	Assorted 1/2", 3/4", 1" – 4" Long, pack of 4	PK	1

Available in lengths up to 250 ft.

*These items are also available in bulk. To order, enter the catalog number followed by the letter "B". For example, HS03B is the bulk part number for HS03. Bulk items are priced and shipped by the foot.

THERMAL CONTROLS

Fusible Links

Fusible Links are temperature sensitive, one time devices. Engineered as safety links, they open the circuit if the designed limit temperature is reached.

CATALOG NO.	FUSIBLE TEMP °F	TYPE	PRONG TYPE	QTY/PACK	UOM	ORDER MULTIPLE
HFL-4257	257°	In-Line		pack of 4	PK	1
HFL-4300	300°	In-Line		pack of 4	PK	1
HFL-4333	333°	In-Line		pack of 4	PK	1
HFL-5257	257°	Face Plate	Straight	pack of 2	PK	1
HFL-5258	257°	Face Plate	Right Angle	pack of 2	PK	1
HFL-5300	300°	Face Plate	Straight	pack of 2	PK	1
HFL-5301	300°	Face Plate	Right Angle	pack of 2	PK	1
HFL-5333	333°	Face Plate	Straight	pack of 2	PK	1



Replacement Element Kits

Field repair damaged element sections of electric heaters. Each kit contains a specific KW replacement element, two ceramic terminal insulator sets, plated bolts, nuts and washers.

CATALOG NO.	WATTAGE AT		IN PLACE LENGTH (INCHES)		UOM	ORDER MULTIPLE
	240V	208V	MINIMUM	MAXIMUM		
HEK-400	4000	3000	45"	135"	EA	1
HEK-500	5000	3750	54"	162"	EA	1



Sequencers

The sequencers are used in electric heat systems to stage blower motors and heating elements. All sequencers are for 24V control.

CATALOG NO.	NO. CIRCUITS	KILXON NO.	SWITCH CONFIGURATION	DELAY ON TIME MIN.-MAX. SECONDS	DELAY OFF TIME MIN.-MAX. SECONDS	UOM	ORDER MULTIPLE
HDR-101	1 Main	60000A0211	SPST-NO	1-24	45-75	EA	1
HDR-102	1 Main	60000A0147	SPST-NO	30-75	1-40	EA	1
HDR-201	2 Main	60000E0110	DPST-NO	1-24	45-75	EA	1
HDR-202	2 Main	60000E0109	DPST-NO	30-70	1-40	EA	1
HDR-211	2 Main Staged	60200A0117	DPST-NO	30-110	1-40	EA	1
HDR-212	2 Main Staged	60200A0127	DPST-NO	1-25	50-110	EA	1
HDR-221	3 Main Staged	51172-131-1	DPST-NO SPST-NO	1-25	50-110	EA	1
HDR-222	4 Main Staged	51172-131-2	2 DPST-NO	1-40	50-110	EA	1

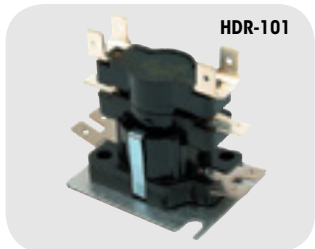

Manual Reset Fire Stat

This bi metal switch is used as a manual reset. When temperature condition is met, the device opens. The manual reset can only be reset after proper cool down of the switch. The HMR 130 is a popular fire stat in ducted air distribution systems. Should temperatures in the duct exceed 130 degree F, the switch opens, shutting down the whole system so no fire or smoke can be spread by the fan.

CATALOG NO.	DESCRIPTION	UOM	ORDER MULTIPLE
HMR-130	Bi-metal Manual Reset Fire Stat	EA	1



THERMOSTATS

LuxPro Thermostats

LuxPro thermostats are designed to be a reliable, simple solution to in home comfort, so that everyone can enjoy the benefits and comforts of advanced temperature control. Diversitech offers a variety of LuxPro models and options to match any installation need.



675-P521U

CATALOG NO.	DESCRIPTION	UOM	ORDER MULTIPLE
675-P521U	5-2 program, 2 H/1 C, Programmable	EA	1
675-P621U	5-1-1 program, 2 H/1 C, Programmable	EA	1
675-P721UT	7 Day, 2 H/1 C, Programmable, Touchscreen	EA	1
675-P722U	7 Day, Programmable, 2 H/2 C for Conventional, 2 H/1 C for Heat Pumps	EA	1
675-PSD010BF	Digital for Heat Only, with Fan Switch	EA	1
675-PSD111	1 H/1 C, Non-Programmable, Vertical/Horizontal	EA	1
675-PSDH121	1 or 2 H/C, Non-Programmable, Vertical/Horizontal	EA	1
675-PSM30SA	Heat Only Mechanical	EA	1
675-PSM40SA	Heating & Cool Mechanical	EA	1
675-PSP722E	3 H/2 C, Programmable for Heat Pumps, 2 H/2 C for Conventional	EA	1

THERMOSTAT GUARDS

Plastic Thermostat Guards

Use to prevent tampering with thermostats. The covers are clear, allowing complete viewing of the thermostat and current settings. Furnished complete with ring and/or solid base. Includes vent holes for easy airflow across the thermostat. Lockable with universal key. Internal dimensional clearance/sizing for thermostats as noted.



585-TG1

CATALOG NO.	DESCRIPTION	T-STAT CLEARANCE	UOM	ORDER MULTIPLE
585-TG	Clear Plastic w/Two Bases	8-1/4" x 4-1/2" x 3-1/4"	EA	1
585-TG1	Clear Plastic w/Two Bases	5-3/4" x 3-1/2" x 2-3/4"	EA	1
585-TG2	Clear Plastic w/Two Bases	4-3/4" x 4-1/4" x 2-3/4"	EA	1
585-TG5	Clear Plastic w/Solid Base	3-1/2" x 3-1/4" x 2-1/4"	EA	1
585-TG6	Clear Plastic w/Two Bases	6-1/4" x 3-3/4" x 1-3/4"	EA	1
585-F336	Key for Thermostat Guard		EA	1

Steel Thermostat Guards

Steel thermostat guards are used to prevent tampering with thermostats. The covers are steel, giving complete tamper protection of the thermostat, and physical impact protection. Great for warehouse and industrial locations. Furnished complete with ring and/or solid base as noted. Includes vent holes for easy airflow across the thermostat. Lockable with universal key. Internal dimensional clearance/sizing for thermostats as noted.



585-TG4

CATALOG NO.	DESCRIPTION	T-STAT CLEARANCE	UOM	ORDER MULTIPLE
585-TG3	Beige Steel w/Solid Base	6" x 4" x 3"	EA	1
585-TG4	Beige Steel w/Ring Base	6" x 4" x 3"	EA	1
585-TG7	Beige Steel w/Solid Base	5-1/2" x 3-1/2" x 2-3/4"	EA	1
585-TG8	Beige Steel w/Ring Base	5" x 3" x 2-3/4"	EA	1
585-TG9	Beige Steel w/Two Bases	6" x 4" x 3"	EA	1

Cross Reference

DIVERSITECH PART NO.	BEKO PART NO.	BRAMEC PART NO.	MARS PART NO.
585-TG	BTG-UK2	13012	70220
585-TG1	BTG-RK	13016	70210
585-TG2	BTG-K	13008	70205
585-TG3	BTG-UM	13010	70223
585-TG4	BTG-UWM	13011	70224
585-TG5	BTG-EK	13004	70201
585-TG6	BTG-DK	13018	70217
585-TG7	BTG-54VL	13002	70215
585-TG8	BTG-54VLW	13001	70216

THERMOSTAT WIRE

Thermostat Wire

Class 2 thermostat wire for indoor wiring needs. Soft drawn bare copper wire, semi rigid PVC insulation and PVC overall jacket. Packaged on aluminum spool.



Plenum Thermostat Wire

The Plenum Thermostat Wire is UL Listed type CL2P NEC Article 725 and is designed for use in thermostat control applications.



CATALOG NO.	DESCRIPTION	UOM	ORDER MULTIPLE
620-18-2	18 AWG, 2 Conductors – 500 ft. Spool	EA	4
620-18-3	18 AWG, 3 Conductors – 500 ft. Spool	EA	4
620-18-4	18 AWG, 4 Conductors – 250 ft. Spool	EA	4
620-18-5	18 AWG, 5 Conductors – 250 ft. Spool	EA	4
620-18-6	18 AWG, 6 Conductors – 250 ft. Spool	EA	4
620-18-7	18 AWG, 7 Conductors – 250 ft. Spool	EA	4
620-18-8	18 AWG, 8 Conductors – 250 ft. Spool	EA	4
620-18-10	18 AWG, 10 Conductors – 250 ft. Spool	EA	4
620-18-12	18 AWG, 12 Conductors – 250 ft. Spool	EA	4
620-20-2	20 AWG, 2 Conductors – 500 ft. Spool	EA	4
620-20-3	20 AWG, 3 Conductors – 500 ft. Spool	EA	4
620-20-4	20 AWG, 4 Conductors – 250 ft. Spool	EA	4
620-20-5	20 AWG, 5 Conductors – 250 ft. Spool	EA	4
620-20-6	20 AWG, 6 Conductors – 250 ft. Spool	EA	4
620-20-7	20 AWG, 7 Conductors – 250 ft. Spool	EA	4
620-20-8	20 AWG, 8 Conductors – 250 ft. Spool	EA	4
620-20-10	20 AWG, 10 Conductors – 250 ft. Spool	EA	4

U.L. Listed. Meets Subject 13 per Article 725, 1990 NEC.

CATALOG NO.	DESCRIPTION	UOM	ORDER MULTIPLE
620-18-2P	18 AWG, 2 Conductors – 500 ft. Spool	EA	4
620-18-3P	18 AWG, 3 Conductors – 500 ft. Spool	EA	4
620-18-6P	18 AWG, 6 Conductors – 250 ft. Spool	EA	4
620-18-8P	18 AWG, 8 Conductors – 250 ft. Spool	EA	4

Wire for Mini-Split Installation

Wire and cabling specific for mini split installation power supply and control circuits.



CATALOG NO.	DESCRIPTION	UOM	ORDER MULTIPLE
230-18-4	Stranded Shielded CL3R, 50' per roll	EA	1
230-16-2	Stranded Shielded CL3R, 50' per roll	EA	1
230-14-4	Stranded Non-Shielded CL3R, 50' per roll	EA	1
230-14-7	Stranded Non-Shielded CL3R, 50' per roll	EA	1
230-14-4S	Stranded Shielded CL3R, 50' per roll	EA	1

STRANDED COPPER THHN WIRE

Stranded Copper Wire in Clear Dispenser Pack, 194°F

This copper wire is UL listed and THHN wire. It is 19 strand copper and is 600 V as well as 90C Stranded.



Stranded Copper Wire on Spool

This copper wire is UL listed and THHN wire. It is 19 strand copper and is 600 V as well as 90C Stranded. This comes 100 ft. per spool.



CATALOG NO.	DESCRIPTION	UOM	ORDER MULTIPLE
W801	08 Gauge, 10 ft., Black	EA	1
W802	08 Gauge, 10 ft., Red	EA	1
W803	08 Gauge, 10 ft., Green	EA	1
W804	08 Gauge, 10 ft., Blue	EA	1
W805	08 Gauge, 10 ft., White	EA	1
W101	10 Gauge, 10 ft., Black	EA	1
W102	10 Gauge, 10 ft., Red	EA	1
W103	10 Gauge, 10 ft., Green	EA	1
W104	10 Gauge, 10 ft., Blue	EA	1
W105	10 Gauge, 10 ft., White	EA	1
W121	12 Gauge, 15 ft., Black	EA	1
W122	12 Gauge, 15 ft., Red	EA	1
W123	12 Gauge, 15 ft., Green	EA	1
W124	12 Gauge, 15 ft., Blue	EA	1
W125	12 Gauge, 15 ft., White	EA	1
W141	14 Gauge, 20 ft., Black	EA	1
W142	14 Gauge, 20 ft., Red	EA	1
W143	14 Gauge, 20 ft., Green	EA	1
W144	14 Gauge, 20 ft., Blue	EA	1
W145	14 Gauge, 20 ft., White	EA	1

CATALOG NO.	DESCRIPTION	UOM	ORDER MULTIPLE
W801-100	08 Gauge, 100 ft. Spool, Black	EA	1
W802-100	08 Gauge, 100 ft. Spool, Red	EA	1
W803-100	08 Gauge, 100 ft. Spool, Green	EA	1
W804-100	08 Gauge, 100 ft. Spool, Blue	EA	1
W805-100	08 Gauge, 100 ft. Spool, White	EA	1
W101-100	10 Gauge, 100 ft. Spool, Black	EA	1
W102-100	10 Gauge, 100 ft. Spool, Red	EA	1
W103-100	10 Gauge, 100 ft. Spool, Green	EA	1
W104-100	10 Gauge, 100 ft. Spool, Blue	EA	1
W105-100	10 Gauge, 100 ft. Spool, White	EA	1
W121-100	12 Gauge, 100 ft. Spool, Black	EA	1
W122-100	12 Gauge, 100 ft. Spool, Red	EA	1
W123-100	12 Gauge, 100 ft. Spool, Green	EA	1
W124-100	12 Gauge, 100 ft. Spool, Blue	EA	1
W125-100	12 Gauge, 100 ft. Spool, White	EA	1
W141-100	14 Gauge, 100 ft. Spool, Black	EA	1
W142-100	14 Gauge, 100 ft. Spool, Red	EA	1
W143-100	14 Gauge, 100 ft. Spool, Green	EA	1
W144-100	14 Gauge, 100 ft. Spool, Blue	EA	1
W145-100	14 Gauge, 100 ft. Spool, White	EA	1

STRANDED COPPER THHN WIRE cont'd

Stranded Copper Wire on Spool

This copper wire is UL listed and THHN wire. It is 19 strand copper and is 600 V as well as 90C Stranded. This comes 50 ft. per spool.



CATALOG NO.	DESCRIPTION	UOM	ORDER MULTIPLE
W801-50	08 Gauge, 50 ft. Spool, Black	EA	1
W802-50	08 Gauge, 50 ft. Spool, Red	EA	1
W803-50	08 Gauge, 50 ft. Spool, Green	EA	1
W804-50	08 Gauge, 50 ft. Spool, Blue	EA	1
W101-50	10 Gauge, 50 ft. Spool, Black	EA	1
W102-50	10 Gauge, 50 ft. Spool, Red	EA	1
W103-50	10 Gauge, 50 ft. Spool, Green	EA	1
W104-50	10 Gauge, 50 ft. Spool, Blue	EA	1
W105-50	10 Gauge, 50 ft. Spool, White	EA	1
W121-50	12 Gauge, 50 ft. Spool, Black	EA	1
W122-50	12 Gauge, 50 ft. Spool, Red	EA	1
W123-50	12 Gauge, 50 ft. Spool, Green	EA	1
W124-50	12 Gauge, 50 ft. Spool, Blue	EA	1
W125-50	12 Gauge, 50 ft. Spool, White	EA	1
W141-50	14 Gauge, 50 ft. Spool, Black	EA	1
W142-50	14 Gauge, 50 ft. Spool, Red	EA	1
W143-50	14 Gauge, 50 ft. Spool, Green	EA	1
W144-50	14 Gauge, 50 ft. Spool, Blue	EA	1
W145-50	14 Gauge, 50 ft. Spool, White	EA	1

High Temperature Wire, 400°F (204°C), 600 V.

7 strand tin coated copper wire with silicone rubber insulation protected by a braided fiberglass jacket. Use on the front of all gas furnaces with spark ignition because of flame roll out on start up. Also on all power feeds to electric strip and duct heaters. Also used on all heat producing food preparation equipment.



CATALOG NO.	DESCRIPTION	UOM	ORDER MULTIPLE
WHT20	14 gauge, 10 ft. black, 10 ft. white	EA	1
WHTB14-50	14 gauge, black, 50 ft.	EA	1
WHTR14-50	14 gauge, red, 50 ft.	EA	1
WHTW14-50	14 gauge, white, 50 ft.	EA	1
WHTB12-20	12 gauge, black, 20 ft.	EA	1
WHTB12-50	12 gauge, black, 50 ft.	EA	1
WHTB10-20	10 gauge, black, 20 ft.	EA	1
WHTB10-50	10 gauge, black, 50 ft.	EA	1

WIRE CONNECTORS

Wire Connectors—Screw On, U.L. Listed, C.S.A Approved

Color coded connectors make quick, secure connections for positive continuity. High dielectric thermoplastic shell resists chemical action from hydrocarbons, dilute acid or alkaline solutions. Deep skirt design prevents exposure of bare wire.



CATALOG NO.	DESCRIPTION	UOM	ORDER MULTIPLE
623-001	Gray Screw-On – Size 71B, #22 to #16 AWG, 300V Max., pack of 100	PK	1
623-002	Blue Screw-On – Size 72B, #22 to #16 AWG, 300V Max., pack of 100	PK	1
623-003	Orange Screw-On – Size 73B, #22 to #14 AWG, 600V Max., pack of 100	PK	1
623-004	Yellow Screw-On – Size 74B, #18 to #10 AWG, 600V Max., pack of 100	PK	1
623-005	Red Screw-On – Size 76B, #18 to #10 AWG, 600V Max., pack of 100	PK	1
623-MIX	Wire connector assortment, Pack of 570	PK	1

U.L. Listed, CSA Approved.

Wire Connectors—Winged, U.L. Listed, C.S.A Approved

Wings give surer grip; offset center design provides great twisting leverage. Expandable square-wire spring instantly adjusts to shape and size to create a strong, vibration-resistant connection. Same tough shell as screw-on type.



CATALOG NO.	DESCRIPTION	UOM	ORDER MULTIPLE
623-000	Lg. Gray Winged – Size 78B, #14 to #8 AWG, 600V Max., pack of 50	PK	1
623-006	Yellow Winged – Size 84, #22 to #10 AWG, 600V Max., pack of 100	PK	1
623-007	Red Winged – Size 86, #18 to #10 AWG, 600V Max., pack of 100	PK	1
623-008	Blue Winged – Size 89, #10 to #6, 600V Max., pack of 50	PK	1

U.L. Listed, C.S.A. Approved.

WIRE CONNECTORS cont'd

Wire Connectors—Screw On, U.L. Listed, C.S.A Approved

Color coded connectors make quick, secure connections for positive continuity. High dielectric thermoplastic shell resists chemical action from hydrocarbons, dilute acid or alkaline solutions. Deep skirt design prevents exposure of bare wire. New handy carry handle and grip bottle. U.L. Listed. C.S.A. Approved.



CATALOG NO.	DESCRIPTION	UOM	ORDER MULTIPLE
623-012	Blue Screw-On – Size 72B, #22 to #16 AWG, 300V Max., pack of 600	PK	1
623-013	Orange Screw-On – Size 73B, #22 to #14 AWG, 600V Max., pack of 300	PK	1
623-014	Yellow Screw-On – Size 74B, #18 to #10 AWG, 600V Max., pack of 200	PK	1

U.L. Listed. CSA Approved.

Porcelain Wire Connectors

Porcelain Wire Connectors are used in high temperature applications such as appliances.



CATALOG NO.	DESCRIPTION	AWG	UOM	ORDER MULTIPLE
CPN1	Porcelain – Small, pack of 15	22-16, 2 Strand Wire	PK	1
CPN1C	Porcelain – Small, pack of 100	22-16, 2 Strand Wire	PK	1
CPN2	Porcelain – Medium, pack of 10	18-14, 2 Strand Wire	PK	1
CPN2C	Porcelain – Medium, pack of 100	18-14, 2 Strand Wire	PK	1
CPN3	Porcelain – Large, pack of 10	18-14, 3 Strand Wire	PK	1
CPN3C	Porcelain – Large, pack of 100	18-14, 3 Strand Wire	PK	1
CPN2M	Porcelain – Medium, pack of 1000	18-14, 2 Strand Wire	PK	1

Wire Connectors—Contractor Packs, U.L. Listed, C.S.A Approved

These connectors have a high dielectric thermoplastic shell. These are UL listed and CSA approved. This product is great for making quick and secure connections.

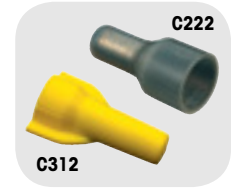

CATALOG NO.	DESCRIPTION	UOM	ORDER MULTIPLE
C222	Closed End Connectors 22-14 W, pack of 18	PK	1
C222C	Closed End Connectors 22-14 W, pack of 100	PK	1
C223	Closed End Connectors 18-10 W, pack of 15	PK	1
C223C	Closed End Connectors 18-10 W, pack of 100	PK	1
C241	Blue Wire Connectors 22-16 W, pack of 20	PK	1
C243	Orange Wire Connectors 22-14 W, pack of 15	PK	1
C245	Yellow Wire Connectors 18-10 W, pack of 13	PK	1
C247	Red Wire Connectors 18-10 W, pack of 10	PK	1
C312	Yellow Winged Wire Connectors, pack of 13	PK	1
C312L	Yellow Winged Wire Connectors, pack of 50	PK	1
C512	Red Winged Wire Connectors, pack of 10	PK	1
C512L	Red Winged Wire Connectors, pack of 50	PK	1

U.L. Listed. CSA Approved.

WIRE/CABLE TIES, MOUNTS, CLAMPS

Cable Tie Assortment Pack

6.6 nylon, the heavy duty duct straps feature smooth insertion, and a locking mechanism that gives ductwork a firm hold. Accommodates 7 to 15 inch duct. Tensioning tool for 32"+ allows operator to adjust strap to any desired tension.



CATALOG NO.	DESCRIPTION	UOM	ORDER MULTIPLE
7-711	Natural Cable Tie Assortment – 7" and 11", pack of 150	PK	25
7-711-B	Black Cable Tie Assortment – 7" and 11", pack of 150	PK	25
7-5811	Natural Cable Tie Assortment – 5", 8", and 11", pack of 450	PK	30
7-5811-B	Black Cable Tie Assortment – 5", 8", and 11", pack of 450	PK	30

Heavy Duty Cable Ties

6.6 nylon, the heavy duty duct straps feature smooth insertion, and a locking mechanism that gives ductwork a firm hold. Accommodates 7 to 15 inch duct. Tensioning tool for 32"+ allows operator to adjust strap to any desired tension.

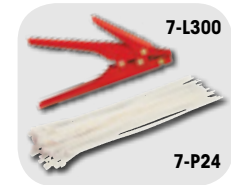

CATALOG NO.	DESCRIPTION	UOM	ORDER MULTIPLE
7-P24	24" Long – Fits up to 6" Duct – 175 lb. Tensile	EA	50
7-P36	36" Long – Fits up to 10" Duct – 175 lb. Tensile	EA	50
7-P36B	36" Long – Black – Fits up to 10" Duct – 175 lb. Tensile	EA	50
7-P48	48" Long – Fits up to 14" Duct – 175 lb. Tensile	EA	50
7-P48B	48" Long – Black – Fits up to 14" Duct – 175 lb. Tensile	EA	25
7-L300	Tensioning Tool for 120-175 lb. Ties	EA	1

WIRE/CABLE TIES, MOUNTS, CLAMPS cont'd

White Nylon Ties with Mounting Hole

These wire ties are perfect for securing wires. You can choose from an assortment of sizes.

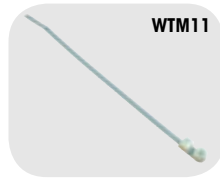

CATALOG NO.	DESCRIPTION	TENSILE STRENGTH	UOM	ORDER MULTIPLE
WTM05	White Wire Ties with Mounting Hole – 5" Nylon, pack of 13	18	PK	1
WTM05C	White Wire Ties with Mounting Hole – 5" Nylon, pack of 100	18	PK	1
WTM07	White Wire Ties with Mounting Hole – 7" Nylon, pack of 11	50	PK	1
WTM07C	White Wire Ties with Mounting Hole – 7" Nylon, pack of 100	50	PK	1
WTM11	White Wire Ties with Mounting Hole – 11" Nylon, pack of 6	50	PK	1
WTM11C	White Wire Ties with Mounting Hole – 11" Nylon, pack of 100	50	PK	1
WTM14	White Wire Ties with Mounting Hole – 14" Nylon, pack of 5	50	PK	1
WTM14C	White Wire Ties with Mounting Hole – 14" Nylon, pack of 100	50	PK	1

Black Nylon Ties with Mounting Hole

These wire ties are perfect for securing wires. You can choose from an assortment of sizes.



CATALOG NO.	DESCRIPTION	TENSILE STRENGTH	UOM	ORDER MULTIPLE
WTMB05	Black Wire Ties with Mounting Hole – 5" Nylon, pack of 12	18	PK	1
WTMB05C	Black Wire Ties with Mounting Hole – 5" Nylon, pack of 100	18	PK	1
WTMB07	Black Wire Ties with Mounting Hole – 7" Nylon, pack of 10	50	PK	1
WTMB07C	Black Wire Ties with Mounting Hole – 7" Nylon, pack of 100	50	PK	1
WTMB11	Black Wire Ties with Mounting Hole – 11" Nylon, pack of 6	50	PK	1
WTMB11C	Black Wire Ties with Mounting Hole – 11" Nylon, pack of 100	50	PK	1
WTMB14	Black Wire Ties with Mounting Hole – 14" Nylon, pack of 5	50	PK	1
WTMB14C	Black Wire Ties with Mounting Hole – 14" Nylon, pack of 100	50	PK	1

Wire and Cable Clamps – Nylon

These wire ties are perfect for securing wires. You can choose from an assortment of diameter sizes.



CATALOG NO.	DESCRIPTION	UOM	ORDER MULTIPLE
WC02	Wire and Cable Clamps – 1/8" Diameter, pack of 40	PK	1
WC03	Wire and Cable Clamps – 3/16" Diameter, pack of 40	PK	1
WC04	Wire and Cable Clamps – 1/4" Diameter, pack of 35	PK	1
WC05	Wire and Cable Clamps – 5/16" Diameter, pack of 35	PK	1
WC06	Wire and Cable Clamps – 3/8" Diameter, pack of 30	PK	1
WC07	Wire and Cable Clamps – 7/16" Diameter, pack of 30	PK	1
WC08	Wire and Cable Clamps – 1/2" Diameter, pack of 25	PK	1
WC09	Wire and Cable Clamps – 9/16" Diameter, pack of 20	PK	1
WC10	Wire and Cable Clamps – 5/8" Diameter, pack of 20	PK	1
WC12	Wire and Cable Clamps – 3/4" Diameter, pack of 15	PK	1
WC14	Wire and Cable Clamps – 7/8" Diameter, pack of 15	PK	1
WC16	Wire and Cable Clamps – 1" Diameter, pack of 14	PK	1
WCA1	Wire and Cable Clamps Assortment – 1/8" to 1", pack of 26	PK	1

All above sizes are available in 100 packs. Add "C" to the end of the part number.

White Nylon Wire Ties

These wire ties are perfect for securing wires. You can choose from an assortment of sizes.

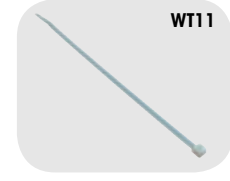

CATALOG NO.	DESCRIPTION	TENSILE STRENGTH	UOM	ORDER MULTIPLE
WT04	White Wire Ties – 4" Nylon, pack of 40	18	PK	1
WT04C	White Wire Ties – 4" Nylon, pack of 100	18	PK	1
WT05	White Wire Ties – 5" Nylon, pack of 35	18	PK	1
WT05C	White Wire Ties – 5" Nylon, pack of 100	18	PK	1
WT07	White Wire Ties – 7" Nylon, pack of 30	50	PK	1
WT07C	White Wire Ties – 7" Nylon, pack of 100	50	PK	1
WT07M	White Wire Ties – 7" Nylon, pack of 1000	50	PK	1
WT11	White Wire Ties – 11" Nylon, pack of 15	50	PK	1
WT11C	White Wire Ties – 11" Nylon, pack of 100	50	PK	1
WT11L	White Wire Ties – 11" Nylon, pack of 50	50	PK	1
WT15	White Wire Ties – 15" Nylon, pack of 12	50	PK	1
WT15C	White Wire Ties – 15" Nylon, pack of 100	50	PK	1
WTA1	White Wire Ties – Assorted 4", 7", and 11" Nylon, pack of 30		PK	1

Black Nylon Wire Ties

These wire ties are perfect for securing wires. You can choose from an assortment of sizes. Ultraviolet resistant for outdoor use.

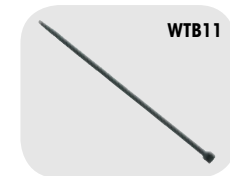

CATALOG NO.	DESCRIPTION	TENSILE STRENGTH	UOM	ORDER MULTIPLE
WTB05	Black Wire Ties – 6" Nylon, pack of 35	18	PK	1
WTB05C	Black Wire Ties – 6" Nylon, pack of 100	18	PK	1
WTB05M	Black Wire Ties – 6" Nylon, pack of 1000	18	PK	1
WTB07	Black Wire Ties – 7" Nylon, pack of 30	50	PK	1
WTB07C	Black Wire Ties – 7" Nylon, pack of 100	50	PK	1
WTB07M	Black Wire Ties – 7" Nylon, pack of 1000	50	PK	1
WTB11	Black Wire Ties – 11" Nylon, pack of 15	50	PK	1
WTB11C	Black Wire Ties – 11" Nylon, pack of 100	50	PK	1
WTB11CR	Black Wire Ties, Releasable – 11" Nylon, pack of 100	50	PK	25
WTB11D	Black Wire Ties – 11" Nylon, pack of 500	50	PK	1
WTB11M	Black Wire Ties – 11" Nylon, pack of 1000	50	PK	1
WTB15	Black Wire Ties – 14" Nylon, pack of 12	50	PK	1
WTB15C	Black Wire Ties – 14" Nylon, pack of 100	50	PK	1
WTBA1	Black Wire Ties – Assorted 4", 7", and 11" Nylon, pack of 28	50	PK	1

Wire Tie Mounts

These mounts are use for mounting wires in electrical work.



CATALOG NO.	DESCRIPTION	UOM	ORDER MULTIPLE
WTM1	White Wire Tie Mounts – Adhesive Back, pack of 4	PK	1
WTM1C	White Wire Tie Mounts – Adhesive Back, pack of 100	PK	1
WTM2	White Wire Tie Mounts – #8 Screw, pack of 7	PK	1
WTM2C	White Wire Tie Mounts – #8 Screw, pack of 100	PK	1

Do **MORE** with **DEVCO**®

DEVCO products help you do even more for your customers. Offering a broad selection of the parts your contractors need to finish the job, DEVCO helps you provide them all the finishing touches they need for any project. So stock up today and do more with DEVCO.



TOOLS

Allen Wrenches	169
Brushes.....	169-171
Channellock® Products	172
Clipboards.....	172
Electrical Supplies	172
Fin Tools.....	173
Flashlights and Lanterns By Rayovac®.....	173
Gauges	175
Manometers, Pressure.....	175
Measuring Tapes, Staples and Staple Guns	176
Meters, Detectors, Alarms	176
Miscellaneous Tools.....	176-177
Monitors.....	177
Nut Setters	178
Refractometers	178
Rehvac Nitrogen Purging Equipment.....	168
Rehvac Refillable Gas Cylinders.....	168
Retrieving Tool	178
Saws and Saw Blades.....	179
Screwdrivers, Driver Sets.....	179
Snips, Notchers, Crimpers, Seamers	180
Straps, Truck Rope.....	180-181
Test Leads	181-182
Testers	182
Thermometers/Probes.....	183
Tube Working Tools	183-184
Welding Torches, Supplies	184
Worklights by Cliplight®	174-175



REHVAC NITROGEN PURGING EQUIPMENT

Regulators

Rehvac nitrogen and CO₂ regulators feature a machined brass piston with internal bleed-down safety. This design makes the Rehvac regulator long lasting and reliable.



CT-475M

CATALOG NO.	DESCRIPTION	UOM	ORDER MULTIPLE
CA-252C	Rehvac Adjustable Regulator, 0-250psi	EA	1
CT-475M	Regulator, N/CO ₂ – 0-475 psi	EA	1
GT-750	Rehvac Nitrogen Regulator 0-750psi	EA	1

Hoses

Rehvac hoses are designed specifically for air, nitrogen, or CO₂ service. Featuring a 600psi working pressure and a 2200psi burst pressure, Rehvac hoses are abrasion resistant and long lasting.



CW-30

CATALOG NO.	DESCRIPTION	UOM	ORDER MULTIPLE
CW-30	Rehvac 30" Whip Hose	EA	1

Nitrogen Purge Tool

The Nitrogen Purge Tool is a quick and easy way to purge copper pipes with nitrogen. Then, with a turn of the dial, quickly switch to a very low flow of nitrogen to properly braze the copper. It has a durable aluminum design so you can just throw it into your tool bag when you are done.



DP-1

CATALOG NO.	DESCRIPTION	UOM	ORDER MULTIPLE
DP-1	Nitrogen Purge Tool	EA	1

Flowmeters

The Rehvac Nitrogen Purge Flow-meter is the perfect tool for purging the line-set before brazing. This flowmeter attaches to the 1/4" flare fitting on a regulator and delivers a metered flow. The flow rate can be increased for the purge process and restricted for the brazing process. Maximum operating pressure is 50 psi. Flowmeter works well with our CT-475M Regulator.



GAU225-PURGE

CATALOG NO.	DESCRIPTION	UOM	ORDER MULTIPLE
GAU225-PURGE	Rehvac Nitrogen Purge Flowmeter	EA	1

Gauges

Rehvac replacement gauges are reliable and easy to read.



GA-06

CATALOG NO.	DESCRIPTION	UOM	ORDER MULTIPLE
GA-06	Rehvac 600psi Low Pressure Replacement Gauge	EA	1
GA-30	Rehvac 3000psi High Pressure Replacement Gauge	EA	1

REHVAC REFILLABLE GAS CYLINDERS

Nitrogen Cylinders

Rehvac aluminum nitrogen cylinders from DiversiTech are commonly used in the HVAC industry for line cleaning and purging, pressure testing and braze purging. Made in the USA.



N20-SD

CATALOG NO.	DESCRIPTION	UOM	ORDER MULTIPLE
N20-SD	Rehvac Nitrogen Cylinder 57 cu ft	EA	1

CO₂ Cylinders

Rehvac aluminum CO₂ cylinders from DiversiTech are commonly used in the HVAC industry for condensate line cleaning. Made in the USA.



C10

CATALOG NO.	DESCRIPTION	UOM	ORDER MULTIPLE
C10	Rehvac 10# Aluminum Cylinder	EA	1
C1-2-6	Rehvac 1.2# Cylinder	EA	1
C20	Rehvac 20# Aluminum Cylinder	EA	1
C20-D	Rehvac 20# Cylinder with Siphon Tube	EA	1
C2-5	Rehvac Cylinder, 2.5#	EA	1
C2-5S	Rehvac 2.5# Cylinder with Straight Valve	EA	1
C5	Rehvac 5# Aluminum Cylinder	EA	1

ALLEN WRENCHES

Allen Wrenches – Long Arm

Most needed combination of Allen Wrenches packaged in clearly marked vinyl pouches.



CATALOG NO.	DESCRIPTION	UOM	ORDER MULTIPLE
AW-712	7 Keys, 12" long arm series: 5/64", 3/32", 1/8", 5/32", 3/16", 7/32", 1/4"	EA	1
AW-96	9 Keys, 6" long arm series: 5/64", 3/32", 1/8", 5/32", 3/16", 7/32", 1/4", 5/16", 3/8"	EA	1

Allen Wrenches

The finest quality wrenches available anywhere.

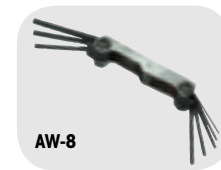

CATALOG NO.	DESCRIPTION	UOM	ORDER MULTIPLE
AW-8	3" Handle, 8 Bits, Standard Fold-Ups .050", 1/16", 5/64", 3/32", 7/64", 1/8", 9/64", 5/32"	EA	1
AW-9	4" Handle, 9 Bits, Standard Fold-Ups 5/64", 3/32", 7/64", 1/8", 9/64", 5/32", 3/16", 7/32", 1/4"	EA	1

Allen Wrenches – Individual Sizes

These Allen Wrenches are sold in individual sizes. These are great for specific projects.

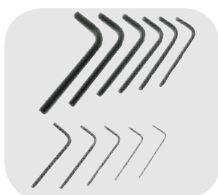

CATALOG NO.	DESCRIPTION	UOM	ORDER MULTIPLE
AW-712-10	Allen Wrench 12" x 5/32"	EA	25
AW-712-8	Allen Wrench 12" x 1/8"	EA	25
AW-96-10	Allen Wrench 6" x 5/32"	EA	25
AW-96-8	Allen Wrench 6" x 1/8"	EA	25

BRUSHES

Chip Brushes

100% pure bristle, wood handle. Poly sleeve over bristles. Inexpensive (use once and throw away). Excellent for applying duct adhesive.



CATALOG NO.	DESCRIPTION	UOM	ORDER MULTIPLE
B-501	Chip Brush – 1"	EA	36
B-502	Chip Brush – 1-1/2"	EA	36
B-503	Chip Brush – 2"	EA	24
B-504	Chip Brush – 2-1/2"	EA	12
B-505	Chip Brush – 3"	EA	12

Welder's Brush

Stainless steel bristles used for cleaning all metals. Great for cleaning aluminum prior to soldering.

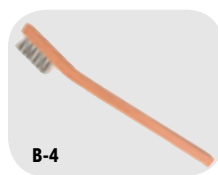

CATALOG NO.	DESCRIPTION	UOM	ORDER MULTIPLE
B-4	Welder's Brush	EA	12

Tin Handle Acid Brushes

Manufactured with electrolyte tin plate and filled with 100% pure stiff horsehair, tied with a steel staple. This combination gives lasting qualities when used with heat and acids or other cleaning agents.

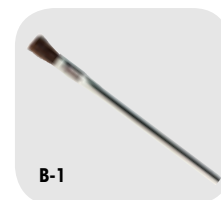

CATALOG NO.	DESCRIPTION	UOM	ORDER MULTIPLE
B-1	Tin Handle Acid Brush 3/8"	EA	144
B-2	Tin Handle Acid Brush 1/2"	EA	144

Refrigerator Coil Brush

Clean refrigerator coils, fan blades and areas under and behind appliances. 27-1/2" in length with 11-3/4" brush length. Bristles are 3/4" on the end tapering to 1-1/2" toward the handle.



CATALOG NO.	DESCRIPTION	UOM	ORDER MULTIPLE
B-27	Refrigerator Coil Brush	EA	1

BRUSHES cont'd

Parts Cleaning Brush

The heavy duty black polypropylene bristles are secured in a strong plastic handle.



CATALOG NO.	DESCRIPTION	UOM	ORDER MULTIPLE
542-25015	Parts Cleaning Brush	EA	12

Duct Cleaning Brush

These brushes are made of black fiber bristles twisted in wire. They are 1 1/8in. diameter by 7in. brush x 48in. overall length. These are idea for cleaning hard to reach areas in duct work.

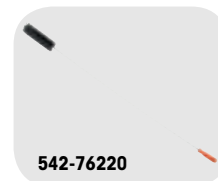

CATALOG NO.	DESCRIPTION	UOM	ORDER MULTIPLE
542-76220	Duct Cleaning Brush	EA	1

2-in-1 Copper Tube Cleaning Brush

Easy to hold combination tool that really works. One end cleans the fitting. The other cleans the tube.



CATALOG NO.	DESCRIPTION	UOM	ORDER MULTIPLE
B-996	2-in-1 Copper Tube Cleaning Brush – 1/2" ID (5/8" OD)	EA	1
B-998	2-in-1 Copper Tube Cleaning Brush – 3/4" ID (7/8" OD)	EA	1

Outside Tube Cleaning Brushes

A tough molded plastic holder allows for a comfortable sure grip. The brush has high carbon steel bristles and comes 6 to a box.

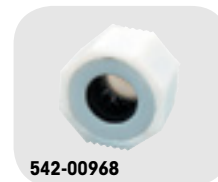

CATALOG NO.	DESCRIPTION	UOM	ORDER MULTIPLE
542-00968	Outside Tube Cleaning Brush – 3/4" ID (7/8" OD)	EA	6

Copper Tube Fitting Brushes

Highest quality brushes to clean fittings faster, easier and more safely. Made with strong, resilient, rustproof stainless steel bristles secured in a 4-ply wire with easy-to-grip plastic handle. Economy models feature same quality stainless steel, but secured in 2-ply wire.



CATALOG NO.	DESCRIPTION	UOM	ORDER MULTIPLE
B-124	Copper Tube Fitting Brush – Economy 1/4" O.D., 9/32" Brush Dia.	EA	6
B-125	Copper Tube Fitting Brush – Economy 3/8" O.D., 13/32" Brush Dia.	EA	6
B-126	Copper Tube Fitting Brush – Economy 1/2" O.D., 17/32" Brush Dia.	EA	6
B-127	Copper Tube Fitting Brush – Economy 5/8" O.D., 11/16" Brush Dia.	EA	6
B-128	Copper Tube Fitting Brush – Economy 3/4" O.D., 13/16" Brush Dia.	EA	6
B-129	Copper Tube Fitting Brush – Economy 7/8" O.D., 15/16" Brush Dia.	EA	6
B-131	Copper Tube Fitting Brush – Economy 1-1/8" O.D., 1-1/4" Brush Dia.	EA	6
B-132	Copper Tube Fitting Brush – Economy 1-3/8" O.D., 1-1/2" Brush Dia.	EA	6
B-924	Copper Tube Fitting Brush – 1/4" O.D., 9/32" Brush Dia.	EA	1
B-925	Copper Tube Fitting Brush – 3/8" O.D., 13/32" Brush Dia.	EA	1
B-926	Copper Tube Fitting Brush – 1/2" O.D., 17/32" Brush Dia.	EA	1
B-927	Copper Tube Fitting Brush – 5/8" O.D., 11/16" Brush Dia.	EA	1
B-928	Copper Tube Fitting Brush – 3/4" O.D., 13/16" Brush Dia.	EA	1
B-929	Copper Tube Fitting Brush – 7/8" O.D., 15/16" Brush Dia.	EA	1
B-930	Copper Tube Fitting Brush – 1" O.D., 1-1/8" Brush Dia.	EA	1
B-931	Copper Tube Fitting Brush – 1-1/8" O.D., 1-1/4" Brush Dia.	EA	1
B-932	Copper Tube Fitting Brush – 1-3/8" O.D., 1-1/2" Brush Dia.	EA	1
B-934	Copper Tube Fitting Brush – 1-5/8" O.D., 1-3/4" Brush Dia.	EA	1
B-935	Copper Tube Fitting Brush – 2-1/8" O.D., 2-1/4" Brush Dia.	EA	1

BRUSHES cont'd

Carbon Steel Curved Handle Scratch Brush

Carbon Steel Curved Handle Scratch Brushes are used for general purpose cleaning.



B-10

CATALOG NO.	DESCRIPTION	UOM	ORDER MULTIPLE
B-10	Carbon Steel Curved Handle Scratch Brush	EA	1

Fin Whisk

A plastic handled whisk for cleaning condenser and evaporator fins.



B-26

CATALOG NO.	DESCRIPTION	UOM	ORDER MULTIPLE
B-26	Fin Whisk Brush	EA	12

Condenser/Heat Exchanger Brushes

Ideal for cleaning mineral deposits from inside metal tubes. Especially recommended for use with power tools, although handle for manual use is available.



B-604

CATALOG NO.	DESCRIPTION	UOM	ORDER MULTIPLE
B-604	Condenser/Heat Exchanger Brush – 3/8" Brass 12-24 Female	EA	1
B-610	Condenser/Heat Exchanger Brush – 1/2" Brass 12-24 Female	EA	1
B-616	Condenser/Heat Exchanger Brush – 5/8" Brass 12-24 Female	EA	1
B-622	Condenser/Heat Exchanger Brush – 3/4" Brass 12-24 Female	EA	1
B-628	Condenser/Heat Exchanger Brush – 7/8" Brass 12-24 Female	EA	1
B-633	Condenser/Heat Exchanger Brush – 7/8" Brass 12-24 Female	EA	1
B-704	Condenser/Heat Exchanger Brush – 1" Nylon 12-24 Female	EA	1
B-716	Condenser/Heat Exchanger Brush – 5/8" Nylon 12-24 Female	EA	1
B-722	Condenser/Heat Exchanger Brush – 3/4" Nylon 12-24 Female	EA	1
B-733	Condenser/Heat Exchanger Brush – 1" Nylon 12-24 Female	EA	1
B-802	Condenser/Heat Exchanger Brush – 1/4" Stainless 8-32 Female	EA	1
B-807	Condenser/Heat Exchanger Brush – 7/16" Stainless 12-24 Female	EA	1
B-816	Condenser/Heat Exchanger Brush – 5/8" Stainless 12-24 Female	EA	1

Condenser/Heat Exchanger Brushes for Commercial Tube Cleaning

For all commercial power tube cleaning machines. 1/4" and 3/8" dia. brushes have 8-32 female threads. 7/16"-1" brushes have 1/4-28 male threads. Use 7/16"-1" brushes for both CW and CCW rotation using a 1/4-28 NF jam locknut.



B-210

CATALOG NO.	DESCRIPTION	UOM	ORDER MULTIPLE
B-210	Condenser/Heat Exchanger Brush – 1/2" Brass 1/4-28 Male	EA	1
B-216	Condenser/Heat Exchanger Brush – 5/8" Brass 1/4-28 Male	EA	1
B-304	Condenser/Heat Exchanger Brush – 3/8" Nylon 8-32 Female	EA	1
B-307	Condenser/Heat Exchanger Brush – 7/16" Nylon 1/4-28 Male	EA	1
B-316	Condenser/Heat Exchanger Brush – 5/8" Nylon 1/4-28 Male	EA	1
B-319	Condenser/Heat Exchanger Brush – 11/16" Nylon 1/4-28 Male	EA	1
B-322	Condenser/Heat Exchanger Brush – 3/4" Nylon 1/4-28 Male	EA	1
B-328	Condenser/Heat Exchanger Brush – 7/8" Nylon 1/4-28 Male	EA	1
B-333	Condenser/Heat Exchanger Brush – 1" Nylon 1/4-28 Male	EA	1
B-428	Condenser/Heat Exchanger Brush – 7/8" Stainless 1/4-28 Male	EA	1
B-433	Condenser/Heat Exchanger Brush – 1" Stainless 1/4-28 Male	EA	1

Extension Rods for Condenser Tube Brushes

Aluminum rods can be threaded into each other to make an endless length with these extension rods.



BE-24

CATALOG NO.	DESCRIPTION	UOM	ORDER MULTIPLE
BE-24	24" Rods w/male thread one end, female other 12-24 thread size	EA	3
BE-36	36" Rods w/male thread one end, female other 12-24 thread size	EA	3
BE-48	48" Rods for 1/4" brushes only 8-32 thread size	EA	3
BH-1	Handgrip – 4" long threads into rods	EA	1

CHANNELLOCK® PRODUCTS

Tongue and Groove Pliers

These patented design pliers have permalock fasteners and reinforcing edge. The grips are also dipped in plastic for a more comfortable hold.



CATALOG NO.	DESCRIPTION	UOM	ORDER MULTIPLE
545-420	9-1/2" Tongue and Groove Pliers	EA	1
545-422	9-1/2" Curved Jaw Tongue and Groove Pliers	EA	1
545-424	4-1/2" Tongue and Groove Pliers	EA	1
545-426	6-1/2" Tongue and Groove Pliers	EA	1

CATALOG NO.	DESCRIPTION	UOM	ORDER MULTIPLE
545-430	10" Tongue and Groove Pliers	EA	1
545-440	12" Tongue and Groove Pliers	EA	1
545-442	12" Curved Jaw Tongue and Groove Pliers	EA	1
545-460	16" Tongue and Groove Pliers	EA	1

CLIPBOARDS

Clipboards and Form Holders

Rugged aluminum construction to protect your paperwork and forms. Smooth aluminum surfaces provide excellent writing support.

CATALOG NO.	DESCRIPTION	UOM	ORDER MULTIPLE
30306	SNAPAK Clipboard on Box w/Hinged Back – 8-1/2" x 12"	EA	1
30309	REDI-RITE Clipboard on Box – 8-1/2" x 12"	EA	1
30310	CRUISER MATE 2 Compartment Clipboard – 8-1/2" x 12"	EA	1

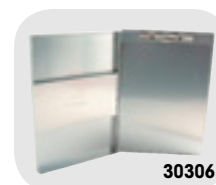

ELECTRICAL SUPPLIES

Outdoor Extension Cord

Heavy duty, round, vinyl extension cord designed for industrial use. Orange vinyl jacket protects against oil, grease, ozone, and gives added flexibility at below freezing temperatures. Vinyl plugs and connectors are molded on and won't break or pull off cord.



CATALOG NO.	DESCRIPTION	UOM	ORDER MULTIPLE
7-ECC12100	100' Extension Cord, 12/3 SJTW-A, 15 AMP	EA	3
7-ECC1225	25' Extension Cord, 12/3 SJTW-A, 15 AMP	EA	10
7-ECC1250	50' Extension Cord, 12/3 SJTW-A, 15 AMP	EA	6
7-ECC16100	100' 13 Amp Extension Cord SJTW-A 16/3	EA	6
7-ECC1625	25' 15 Amp Extension Cord SJTW-A 16/3	EA	24
7-ECC1650	50' 15 Amp Extension Cord SJTW-A 16/3	EA	12
7-ECC50725	25' 15 AMP Extension Cord SJTW-A 14/3	EA	14
7-ECC50730	50' 15 AMP Extension Cord SJTW-A 14/3	EA	10
7-ECC50735	100' 13 AMP Extension Cord SJTW-A 14/3	EA	5

Type: SJTW-A U.L. Listed, meets OSHA Requirements.

Power Blocks

Professional design gives contractors and industrial personnel maximum flexibility in arranging portable power needs at the job site. Vinyl connectors are solid molded for high resistance to breakage and abuse.



CATALOG NO.	DESCRIPTION	UOM	ORDER MULTIPLE
7-AD010000	Triple tap power block adapter converts single 15 AMP 125V U-ground outlet to 3 15A, 125V U-ground outlets	EA	10

Metal Guard Trouble Lights

Designed for rugged use by contractors and industrial. Tough plastic handles are heat and shock resistant, with switch and 15A, 125V grounding side outlet.



CATALOG NO.	DESCRIPTION	UOM	ORDER MULTIPLE
7-TLC10625	25' Metal Guard Trouble Light	EA	1
7-TLC10630	50' Metal Guard Trouble Light	EA	1

AWG: 16/3 TYPE: SJTW-A U.L. Listed, meets OSHA Requirements.

Rough Service Light Bulbs

Designed to withstand unusual shock and abuse on drop cords, mechanic trouble lights, extension cords and anywhere else severe shocks may be encountered. 4 bulbs per box for 100 watt bulbs. 4 bulbs per box for 75 watt bulbs. 120/case.

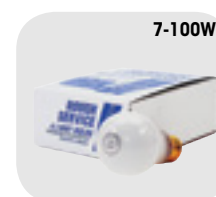

CATALOG NO.	DESCRIPTION	UOM	ORDER MULTIPLE
7-75W	75 Watt Rough Service Bulb – Bulk Packed	EA	120
7-100W	100 Watt Rough Service Bulb – Bulk Packed	EA	120

Cable Clamp PRO

The Cable Clamp PRO is the ultimate reusable cable management tool. Featuring a unique push button release and integrally attached carry handle serrated for easy grip. Carry handle also includes built-in lanyard hole allowing for attachment of rope, wire, or hook. Lanyard hole may be used for tethering of Cable Clamp PRO to cords, cable, and other devices. The medium size is for bundles up to 2-inch and the large size is for bundles up to 3-inch.



CATALOG NO.	DESCRIPTION	UOM	ORDER MULTIPLE
CCP-M	Cable Clamp PRO Display Box with 34 Medium	EA	34
CCP-L	Cable Clamp PRO Display Box with 24 Large	EA	25

FIN TOOLS

Multi-Head Fin-Tool

Conveniently straightens and cleans condenser and evaporator fins. Each nylon head slides into the master handle and tightens in place. Heads are designed to fit units with fin spacing of 4–24 fins per inch. Each head is engraved with its own size and is color coded for fast identification. Heads are angled so that when inserted in the handle, the hand is a safe distance from the sharp fins. Heads may also be reversed in the handle so that combing with an upward stroke (recommended method) may be done easily with proper leverage. The master handle rests comfortably in a man size grip, is rigid and long lasting.

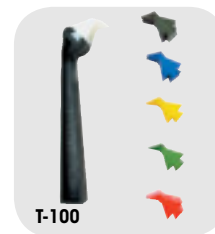

CATALOG NO.	DESCRIPTION	UOM	ORDER MULTIPLE
T-1	Handle Only – Black	EA	1
T-8	Head 8 FPI – Orange, pack of 3	PK	1
T-9	Head 9 FPI – Yellow, pack of 3	PK	1
T-10	Head 10 FPI – Natural, pack of 3	PK	1
T-100	Kit – 1 Handle and 6 Heads: 8, 9, 10, 11, 12, 14	EA	12
T-101	Kit – 1 Handle and 6 Heads: 13, 15, 16, 17, 18, 20	EA	12
T-11	Head 11 FPI – Blue, pack of 3	PK	1
T-12	Head 12 FPI – Green, pack of 3	PK	1
T-14	Head 14 FPI – Lt. Green, pack of 3	PK	1
T-13	Head 13 FPI – Pink, pack of 3	PK	1

Fin-Tool

Long lasting metal fin straightener. Straightens and cleans condenser and evaporator fins. One tool for all units. The heavy duty spring wire bristles automatically adjust to ALL fin spacings. An exclusive tension adjustment band is featured to allow maximum rigidity and ease of operation. Straightens most severely damaged fins.



CATALOG NO.	DESCRIPTION	UOM	ORDER MULTIPLE
T-200	Fin-Tool	EA	1
T-300	Fin-Tool with heavy duty bicycle handle	EA	12

CATALOG NO.	DESCRIPTION	UOM	ORDER MULTIPLE
T-15	Head 15 FPI – Aqua, pack of 3	PK	1
T-16	Head 16 FPI – Brown, pack of 3	PK	1
T-20	Head 20 FPI – Purple, pack of 3	PK	1
T-21	Head 21 & 22 FPI – Rose (for Carrier unit), pack of 3	PK	1

U.S. Patent No. 4,018,076.

SuperComb

Easier to grip, easier to use tool for straightening condenser and evaporator fins. Straightens 50% more fins in one stroke. Keeps hands a safe distance from fins. Easy to grip, strong, durable, heavy duty nylon. Color coded for easy identification. Sold individually or 6 per set. Sales display available.



CATALOG NO.	DESCRIPTION	UOM	ORDER MULTIPLE
T-400	Set of 6 – 1 Ea.: T-408, T-409, T-411, T-410, T-417, T-418	EA	1
T-408	8 and 10 FPI – Orange	EA	1
T-409	9 and 15 FPI – Yellow	EA	1
T-411	11 and 13 FPI – Blue	EA	1
T-412	12 and 14 FPI – Green	EA	1
T-417	16 and 17 FPI – Lime	EA	1
T-418	18 and 20 FPI – Red	EA	1

FLASHLIGHTS AND LANTERNS BY RAYOVAC®

Rayovac is the Industrial Product Leader!

Rayovac is the leader in the industrial battery market and has been for years, with an estimated 50% share of the traditional industrial distribution channel. Rayovac introduced the top-selling industrial flashlight to the market, and set the quality standard by which all other industrial flashlights are measured today. Whether your customer is searching for a toolbox-tough flashlight or high-performance batteries, Rayovac offers a broad range of products to meet your needs.

Rayovac Industrial Flashlights and Lanterns

Rayovac Industrial Flashlights are made of toolbox tough polypropylene construction which makes them scratch resistant and they have an unbreakable lens. There is a full lifetime warranty on this USA made product.



CATALOG NO.	DESCRIPTION	UOM	ORDER MULTIPLE
7-301K	Krypton Beam Lantern with 918 Battery	EA	1

Rayovac LED Flashlights

This flashlight is water resistant with a machined aluminum with knurled grip and a bronze finish. There is a full lifetime warranty on this USA made product. A holster is included with this item.



CATALOG NO.	DESCRIPTION	UOM	ORDER MULTIPLE
7-SE4W3C	Sportsman Extra 3C Lumen	EA	4
7-SPHW3AAA-BX	Sportsman 3AAA 20 Lumen	EA	6

WORKLIGHTS BY CLIPLIGHT®

Clipstrip™ / Clipstrip 2™

Clipstrip™ is a powerful pocket light with 140 lumens and includes a pivoting magnetic clip. It is available in yellow or camo with three AAA batteries included.



CATALOG NO.	DESCRIPTION	UOM	ORDER MULTIPLE
111112	Clipstrip™ Pocket Light	EA	12
111116	Clipstrip™ Pocket Camo Light	EA	12
111118	Clipstrip 2™ Pocket Light	EA	9

PIVOT™

The PIVOT™ is a light that has a 360° swivel hook with 240 lumens and magnetic base and back. Three AA batteries included.



CATALOG NO.	DESCRIPTION	UOM	ORDER MULTIPLE
111114	PIVOT™ Pivoting Worklight	EA	9

PIVOT™ 33

The Pivot™ 33 is a light that has a 360° swivel hook with 160 lumens and magnetic back and pivoting base. Lights on front and top with three AA batteries included. Available in yellow or camo.



CATALOG NO.	DESCRIPTION	UOM	ORDER MULTIPLE
24-458	PIVOT™ 33 Worklight	EA	9
24-460	PIVOT™ 33 Worklight, Camo	EA	9

Clip-On Zoom Light

The Clip-On Zoom Light provided 150 lumens, 90° pivoting capability coupled with the ability to zoom from broad to narrow. It includes a magnetic base and includes three AAA batteries.



CATALOG NO.	DESCRIPTION	UOM	ORDER MULTIPLE
111128	Clip-On Zoom Worklight	EA	8

HEMImini™

The HEMImini™ has up to 1000 lumens of power (4 hours - full power) with a 4400 mAh lithium-ion rechargeable battery. It includes a 180 degree swivel hook with an optional magnetic cover (410239).



CATALOG NO.	DESCRIPTION	UOM	ORDER MULTIPLE
114301	HEMImini™ Worklight	EA	1
410239	Magnetic Cover for HEMImini™ Worklight	EA	1

Clipstrip™ Aqua

Clipstrip™ Aqua is a waterproof light with 180 lumens and includes a magnetic clip and floats. It is available in yellow and comes with a rechargeable 2200 mAh lithium-ion battery. Sold individually.



CATALOG NO.	DESCRIPTION	UOM	ORDER MULTIPLE
111113	Clipstrip™ Aqua Light	EA	1

PIVOT™ mini

The PIVOT™ mini is a light that has a 360° swivel hook with 120 lumens and magnetic back and base. Lights on front and top with three AAA batteries included. Available in yellow or camo.



CATALOG NO.	DESCRIPTION	UOM	ORDER MULTIPLE
111115	PIVOT™ mini Pivoting Worklight	EA	12
111117	PIVOT™ mini Pivoting Worklight, Camo	EA	12

PIVOT™ Tough-Light

The PIVOT™ Tough Light has 150 lumens with a hanging hook and magnetic base. It also has 180 degree pivoting capability with three AAA batteries included.

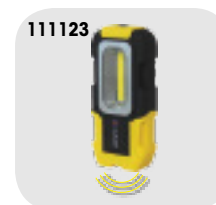

CATALOG NO.	DESCRIPTION	UOM	ORDER MULTIPLE
111123	PIVOT™ Tough-Light Worklight	EA	8

Cliplight Extends

The Cliplight Extends has 120 lumens at the top and 140 lumens in the front with a pivoting head. The light comes with a telescopic system and magnetic base. Four AAA batteries included.



CATALOG NO.	DESCRIPTION	UOM	ORDER MULTIPLE
111130	Cliplight Extends Worklight	EA	8

HEMIPLUS™ 2

The HEMIPLUS™ 2 has up to 1200 lumens of power (4 hours - full power) with a 4400 mAh lithium-ion rechargeable battery. It includes a metal hook and removable magnetic cover.



CATALOG NO.	DESCRIPTION	UOM	ORDER MULTIPLE
114302	HEMIPLUS™ 2 Worklight	EA	1

WORKLIGHTS BY CLIPLIGHT® cont'd

Spotlight

The Spotlight is a cordless work light solution with up to 1200 lumens of power (3 hours - full power) with a 4000 mAh lithium-ion rechargeable battery. It includes two adjustable joints on magnetic stand for different angles. It has three power modes including a dimmer.

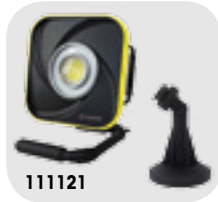

CATALOG NO.	DESCRIPTION	UOM	ORDER MULTIPLE
111121	Spotlight Cordless Worklight	EA	1

GAUGES

Manifold Gauge

DiversiTech's MG-1 Manifold Gauge provides the technician with a precision diagnostic and monitoring analog gauge set complete with hoses.

The Manifold Gauge and Hose Set includes:

- 2 valve brass manifold
- 5' long high pressure hose set
- For use with the following refrigerants:
 - R-410A
 - R-22
 - R-407C
- Detailed gauge readings in PSI °F

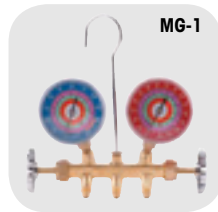

CATALOG NO.	DESCRIPTION	UOM	ORDER MULTIPLE
MG-1	Manifold Gauge and Hose Set	EA	1
MG-RGB	Replacement Gauge – blue	EA	1
MG-RGR	Replacement Gauge – red	EA	1

MANOMETERS, PRESSURE

Hydrogauge Manometer

Economical Pressure measurements.

- Replaces ordinary U-tube manometers
 - Measures gas pressure easily and efficiently
 - Direct reading, no plus or minus readings to add together as in old fashioned U-tubes
 - Fills like a glass of water, no more air bubbles
 - Strong magnet for mounting
 - Heavy-duty construction
 - Made of industrial grade, flexible PVC plastic
 - Lightweight; Easy to use
 - 6-HG15 water column height: 15"
 - Plastic: 30" to 36" of industrial grade flexible plastic
 - Hose fitting: All brass
- Includes: Mounting magnet.

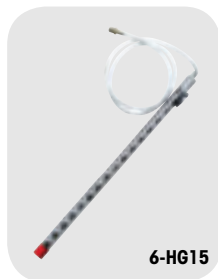

CATALOG NO.	DESCRIPTION	UOM	ORDER MULTIPLE
6-HG15	Hydrogauge Manometer	EA	1

Gas Pressure Test Kit

Rugged, Heavy Duty Field Use.

- Measure Natural gas (methane) or LP gas pressure across appliance manifolds.
 - Test gas stoves, furnaces, dryers and other gas appliances. Can also be used for other non-corrosive gases.
 - Large 2" sensitive diaphragm gauge is calibrated in inches of water column, also shows ounces per square inch
 - Magnified lens
 - Easier to use than a manometer
 - Range: 0 to 35 inches of water column (in. H₂O) 0 to 20 ounces per square inch (oz./in²)
- Includes: 2" sensitive diaphragm gauge; 3' of rubber tubing; brass fitting for quick connection to the appliance manifold 3/8" NPT; molded hard case.



CATALOG NO.	DESCRIPTION	UOM	ORDER MULTIPLE
6-GPK035	Gas Pressure Test Kit	EA	1

MEASURING TAPES, STAPLES AND STAPLE GUNS

Power Measuring Tapes

Rust resistant yellow lacquered blade with easy to read inch/foot markings (English). Neon case has belt clips and finger-tip blade lock.

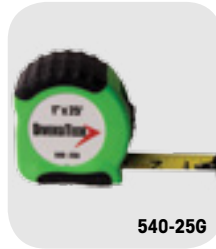

CATALOG NO.	DESCRIPTION	UOM	ORDER MULTIPLE
540-256	Power Tape – Neon Green 1" x 25'	EA	6

T-50 Series Staples and Staple Guns

The #1 selling staple gun in the world! Used extensively by building contractors, home do-it-yourselfers and specialty trade applications for tacking insulation, ceiling tile, window screening, cornerite, and 1001 other jobs ranging from light to heavy duty work. The T-50 Outward Clinch Staple Gun is ideal for fiberglass ductwork.

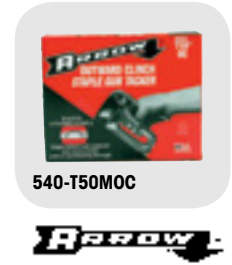

CATALOG NO.	DESCRIPTION	UOM	ORDER MULTIPLE
540-506	3/8" Leg Staples for T50 Staple Guns (1,250)	EA	4
540-508	1/2" Leg Staples for T50 Staple Guns (1,250)	EA	4
540-509	9/16" Leg Staples for T50 Staple Guns (1,250)	EA	4
540-T50M	T50M Heavy Duty Staple Gun Tacker	EA	1
540-T50MOC	T50MOC Outward Clinch Staple Gun	EA	1

METERS, DETECTORS, ALARMS

Digital UL Listed Multimeter

Economical Electrical Readings.

- 7 Functions – 20 Ranges
- High Impact Thermoplastic Case
- Simple Operation
- Small Pocket Size
- Safety Recessed Test Lead Connections
- Ranges and Accuracy
- AC Voltage: 0-200/600 Vac, ±2.5%
- DC Voltage: 0-200mV/2/20/200/600 Vdc, ±2%
- DCCurrent: 0-2000uA/20m/200mA/10A dc, ±1%
- Resistance: 0-200/2k/20k/200k/2M/20M Ω , ±1.5%

Includes: Battery Test; Diode Test; Continuity Buzzer.

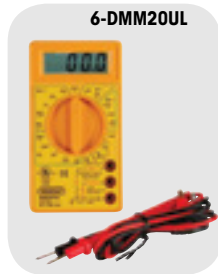

CATALOG NO.	DESCRIPTION	UOM	ORDER MULTIPLE
6-DMM20UL	Digital UL Listed Multimeter	EA	1

MISCELLANEOUS TOOLS

Compressor TOTE

Makes light work of a heavy job. Powder coated, strong steel construction. Recommended for use with all compressors up to 5 tons. Compatible with high efficiency compressors. Pick up a compressor up a ladder. Now with black protective finish.



CATALOG NO.	DESCRIPTION	UOM	ORDER MULTIPLE
ACT-6	Compressor Tote	EA	6

Mechanical Screw Starter

A simple, easy way to end fumbling with hard to position screws. Just insert the screw on the prongs of the screw starter, and a simple twist will lock the screw ready for trouble free starting. Tool automatically releases and resets. Use with ferrous or non-ferrous screws. Nylon handle.



CATALOG NO.	DESCRIPTION	UOM	ORDER MULTIPLE
S-3	One End Slotted, Phillips on Other, 9-1/4"	EA	1

MISCELLANEOUS TOOLS cont'd

Expando Adjustable Condenser Tube Cleaner

Removes mineral scale and sludge from inside water-cooled condenser tubes fast! Saves time-consuming brushing or flushing. Attaches to a threaded rod which fits into an Expando handle or your electric drill. With a reaming action, the stainless steel blades scrape inside the tube, providing an unrestricted flow. Virtually clogproof, it expands or reduces in diameter to fit scale deposits—not just the tube. Use EC-810 couplings for connecting additional rods. Thread size 1/4" x 28.



E-5

CATALOG NO.	DESCRIPTION	UOM	ORDER MULTIPLE
E-10	Condenser Tube Cleaner – 5/8" to 3/4" I.D. Tubes	EA	1
E-5	Condenser Tube Cleaner – 5/16" to 3/8" I.D. Tubes	EA	1
E-6	Condenser Tube Cleaner – 3/8" to 1/2" I.D. Tubes	EA	1
E-8	Condenser Tube Cleaner – 1/2" to 5/8" I.D. Tubes	EA	1
EB-10	Blades for E-10	EA	1
EB-8	Blades for E-8	EA	1
EC-56	Couplings for E-5 and E-6	EA	3
EC-810	Couplings for E-8 and E-10	EA	3

Telescopic Inspection Mirror

Fast, accurate visual inspection of hidden areas with an almost limitless number of positions. Double ball joint links swivel mirrors for viewing to 360°. Precision engineered links are made from tempered spring steel to withstand the stresses of constant repositioning. Moves freely, holds desired position.



M-1

CATALOG NO.	DESCRIPTION	UOM	ORDER MULTIPLE
M-1	Mirror – 1-1/4" Circular – extends 6-1/4" to 18-1/4"	EA	1
M-1R	Replacement Head for M-1	EA	1
M-2	Mirror – 2-1/4" Circular – extends 10" to 14"	EA	1
M-2R	Replacement Head for M-2	EA	1
M-3	Mirror – 2-1/8" x 3-1/2" Rectangular – extends 11-1/4" to 15-1/4"	EA	1
M-3R	Replacement Head for M-3	EA	1
M-4	Mirror – 7/8" Circular – extends 6-1/2"	EA	1
M-5	Mirror – 1" x 2" Oval – extends 8-1/2"	EA	1

4-Piece Hook and Pick Set

For separating wires, removing small fuses, "O" rings, retrieving washers and loose parts too small to pick up with your fingers. Bright-dipped, anodized hex-shaped aluminum handles with powerful magnet on end. Handy screw-in hook, pick, point and scribe. High carbon polished needle steel. All in a compact zip-lock vinyl pouch that fits in your shirt pocket! Set includes four screw-in tips plus handle.

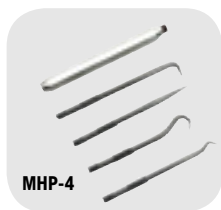

MHP-4

CATALOG NO.	DESCRIPTION	UOM	ORDER MULTIPLE
MHP-4	4-Piece Hook and Pick Set	EA	1

MONITORS

007 Control Checker

A lifetime tool for monitoring and checking safety controls and operating controls. One unit for all voltages 24-460 VAC or DC without switching dials or meters. Compact, 4 oz, reliable. Saves troubleshooting. For normally closed controls, 007 connects in parallel with safety control. When the safety control opens in response to a problem in the system, 007 red LED turns on and remains on until reset manually. With intermittent problem, the LED remains on indicating the control is open. For operating controls, 007 verifies the status of all types indicating if there is power to the holding coil, the NC contact is open or closed, the thermostat contacts are open or closed, there is power to the contactor or starting holding coil, the overloads are open or closed, or there is a bad connection either on control or power side. NOTE: May use with lockout relays. Features battery check and reset switch. Includes 9-volt battery. 007 may be used over and over.



TC-007

CATALOG NO.	DESCRIPTION	UOM	ORDER MULTIPLE
TC-007	007 Control Checker	EA	1

U.S. Pat. No. 4,092,625.

Tattle-Tale Control Monitor

Identifies open controls in seconds. A single use monitoring device for determining which safety control has opened in response to a malfunction. Saves wasted hours tracing a safety control shutdown, even if intermittent. A quick, inexpensive way to visually spot where the problem is. Simply install in parallel with each safety control. When a control opens, the red indicator flag pops up. You will know immediately which area of the system is experiencing problems. Disposable, safe, simple to use, and pocket sized. Monitors safety controls, fuses, overload relays, motor protectors, freeze controls, limit controls, safety switches, fusible links, or steam control. CAUTION: Not to be used with lockout relays, use TC-007.

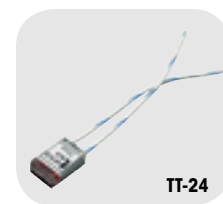

TT-24

CATALOG NO.	DESCRIPTION	UOM	ORDER MULTIPLE
TT-120	Tattle-Tale Control Monitor – 120 Volt AC or DC, pack of 3	PK	1
TT-24	Tattle-Tale Control Monitor – 24 Volt AC or DC, pack of 3	PK	1
TT-240	Tattle-Tale Control Monitor – 240 Volt AC or DC, pack of 3	PK	1

Tolerance on all voltages shown is ± 20%. U.S. Pat. No. 4,250,480.

NUT SETTERS

Nut Setter – Power

The Magnetic hex driver nut setter can be used with any 1/4in. power bit and are individually packed.



CATALOG NO.	DESCRIPTION	UOM	ORDER MULTIPLE
5-MSH1/4MC	Hex Drive – 1/4", 1-3/4" long, 1/4" nut	EA	30
5-MSH5/16MC	Hex Drive – 1/4", 1-3/4" long, 5/16" nut	EA	30

Magnetic Nut Setters – Bulk

Magnet hex driver setter to be used with any 1/4in. power bit and are package in bulk.



CATALOG NO.	DESCRIPTION	UOM	ORDER MULTIPLE
540-400	Magnetic Nut Setters – 1/4", pack of 30	EA	1
540-500	Magnetic Nut Setters – 5/16", pack of 30	EA	1

REFRACTOMETERS

Refractometer

The Refractometer can measure the freezing point of coolants, glycol and the Charge Condition of Batteries



CATALOG NO.	DESCRIPTION	UOM	ORDER MULTIPLE
6-REF401	Refractometer	EA	1

RETRIEVING TOOL

Reach-It

Our Reach-It is made of durable chrome plated brass and retracts to 5in. long. A match can quickly be inserted with the Reach-It.



CATALOG NO.	DESCRIPTION	UOM	ORDER MULTIPLE
R-1	Reach-It – extends to 26-3/4"	EA	12

SAWS AND SAW BLADES

Deluxe Hi-Tension Hacksaw

Hackframe featuring handle and end pieces made of die cast aluminum. Lightweight yet rigid and highly tensioned (up to 25,000 psi) for cleaner, surer cut. Permanent blade pins feature versatile angling (up to 55°) for flush cutting. Blade can be inserted in handle to be used as compass saw. Frame will fit most standard tool boxes.



CATALOG NO.	DESCRIPTION	UOM	ORDER MULTIPLE
540-278BM0024	Replacement Blades for Hacksaw Frame 12" x 24T	EA	10
540-278HX0002	Hacksaw Frame with Blade	EA	1

Bi-Metal Reciprocating Saw Blades

Premium high speed steel with a flexible alloy back. Bi-metal blades fit all reciprocating saws with 1/2" shank.

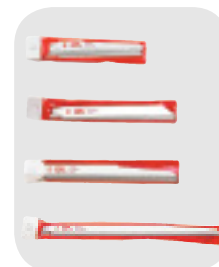

CATALOG NO.	DESCRIPTION	UOM	ORDER MULTIPLE
540-RBCCRF	Cast Iron-Ceramic Tile Carbide Grit 8" Long	EA	1
540-RB125W	12" x 6T Wood and Nail 3/4" x 12" x .050	EA	5
540-RB414M	4" x 14T Short Metal Cutting 3/4" x 4" x .035	EA	5
540-RB418M	4" x 18T Short Metal Cutting 5/8" x 4" x .035	EA	5
540-RB424M	4" x 24T Thin Short Metal Cutting 5/8" x 4" x .035	EA	5
540-RB610HDM	6" x 10T HD Metal Cutting 3/4" x 6" x .035	EA	5
540-RB614HDM	6" x 14T HD Metal Cutting 3/4" x 6" x .035	EA	5
540-RB618HDM	6" x 18T HD Metal Cutting 3/4" x 6" x .035	EA	5
540-RB624HDM	6" x 24T HD Metal Cutting 3/4" x 6" x .035	EA	5
540-RB636DW	Drywall Cutting with V Head 5/8" x 6" x .035	EA	5
540-RB636W	6" x 6T Wood and Nail Slope 3/4" x 6" x .050	EA	5
540-RB656WS	6" x 6T Wood and Nail Scroll 3/4" x 6" x .050	EA	5
540-RB810HDM	8" x 10T HD Metal Cutting 3/4" x 8" x .035	EA	5
540-RB814HDM	8" x 14T HD Metal Cutting 3/4" x 8" x .035	EA	5
540-RB956W	9" x 6T Wood and Nail 3/4" x 9" x .050	EA	5

SCREWDRIVERS, DRIVER SETS

Pocket 4-in-1 Mini Screwdriver

This screwdriver set is ideal for technicians, hobbyists, and do it yourselfers. There are 2 double-ended vanadium blades. You can change blades instantly and the blades are held in the carrier handled. The dimensions are 1/16in. and 1/8in. slotted tips and #1 and #00 cross point. The Mini Screwdriver comes in with a convenient pocket clip and capped ends.

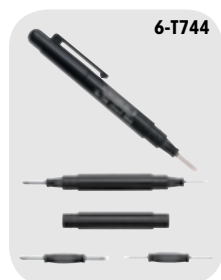

CATALOG NO.	DESCRIPTION	UOM	ORDER MULTIPLE
6-T744	Pocket 4-in-1 Mini Screwdriver – Length: 5-1/8" (130mm)	EA	1

Combination Screwdrivers

Multiple bits in one handy screwdriver. No need for a toolbox for those quick jobs. Lifetime guarantee.



CATALOG NO.	DESCRIPTION	UOM	ORDER MULTIPLE
5-41	4-in-1 with #1 and #2 Phillips, 3/16 and 5/16 Slotted	EA	12
5-61	6-in-1 with #1 and #2 Phillips, 3/16 and 5/16 Slotted 1/4 Nut Driver, 5/16 Nut Driver	EA	12

SNIPS, NOTCHERS, CRIMPERS, SEAMERS

Aviation Snips

Moly alloy tool steel blade is hot drop-forged and scientifically heat-treated to provide a strong, longer lasting cutting edge. Durable serrated blades are designed to grip the metal for cutting ease. The patent pending spring on these snips is guaranteed to last for the life of the tool. Will cut 18 gauge cold-rolled steel.



CATALOG NO.	DESCRIPTION	UOM	ORDER MULTIPLE
540-6716B	Aviation Snip – Bulldog Notching Snip – Blue Handle	EA	6
540-6716L	Aviation Snip – Cuts Left – Red Handle	EA	6
540-6716R	Aviation Snip – Cuts Right – Green Handle	EA	6
540-6716S	Aviation Snip – Cuts Straight – Yellow Handle	EA	6

HVAC Tools

Hot drop-forged carbon steel blades. Compound leverage action handles. Heavy duty plastic grips.



CATALOG NO.	DESCRIPTION	UOM	ORDER MULTIPLE
540-FCTMC5	8" Crimper – 22 Ga. Crimping Capacity	EA	1
540-FCTMN1	8" Notcher – 31° Cutting Angle	EA	1
540-FCTMS1	3" Straight Seamer – 22 Ga. Capacity	EA	1
540-FCTMS2	3" Offset Seamer – 22 Ga. Capacity	EA	1

Offset Snips

The same high quality construction as the Aviation Snips with an additional advantage – the Offset Snips allow your hand to stay above metal for cutting ease and comfort.



CATALOG NO.	DESCRIPTION	UOM	ORDER MULTIPLE
540-6510L	Offset Snip – Cuts Left – Red Handle	EA	6
540-6510R	Offset Snip – Cuts Right – Green Handle	EA	6

Upright Snips

This snip significantly improves sheet metal cutting. The ergonomic design allows for easier cutting in tight places, improved safety by elevating hands above metal working surfaces, and increases wrist range motion.



CATALOG NO.	DESCRIPTION	UOM	ORDER MULTIPLE
540-6900L	Upright Snips – Left-handed Model	EA	6
540-6900R	Upright Snips – Right-handed Model	EA	6

STRAPS, TRUCK ROPE

Truck Rope

All-purpose high strength polypropylene truck rope is C.H.P. approved.



CATALOG NO.	DESCRIPTION	UOM	ORDER MULTIPLE
25001	Truck Rope – 3/8" x 50'	EA	1
CR070	Truck Rope – 3/8" x 50' (Yellow)	EA	1

Lashing Strap

Quickly lashes and secures refrigerators, air conditioners, washers, driers, etc. Strong nylon webbing rated at 3000 lbs. and end hooks at 1200 lbs. tensile strength. Hand loop for easy tightening. Steel cam lever buckle is easy to adjust and releases quickly. Secures a maximum load of 1000 pounds. 12' long.



CATALOG NO.	DESCRIPTION	UOM	ORDER MULTIPLE
HS-144	Lashing Strap – 144"	EA	6

STRAPS, TRUCK ROPE cont'd

Ratchet Strap

Easy ratcheting permits tie-down of appliances securely. An innovative latch and a fast release cam reduces socket wear. Cadmium-plated steel buckle has a positive lock that eliminates release due to vibration. When closed, the handle locks the latch into the sprocket to prevent inadvertent release. 16' nylon webbing rated at 3000 PSI tensile. Vinyl coated end hooks rated at 1200 PSI tensile.



CATALOG NO.	DESCRIPTION	UOM	ORDER MULTIPLE
HS-192	Ratchet Strap – 16'	EA	3

Hanging Strap

Strong, versatile, easy way to secure loose gear safely. Tie down ladders, tubing, cylinders or almost anything in seconds. Cannot snap back. Strong, durable 1" polypropylene webbing. Reinforced grommet lets you hang it up, tie it up, hook it up or attach it permanently. Spring loaded adjustable buckle. Easy to get firm tension with no slipping. Make an endless length by connecting 2 or more together.



CATALOG NO.	DESCRIPTION	UOM	ORDER MULTIPLE
HS-30	Hanging Strap – 31"	EA	24
HS-30-2	Hanging Strap – 31", 2 Straps per Card, pack of 12	PK	1
HS-60	Hanging Strap – 60"	EA	24
HS-60-2	Hanging Strap – 60", 2 Straps per Card, pack of 12	PK	1

Canopy Strap

Canopy ties are ideal for stretching or holding tarps and canopies tight. Easy to use and install and won't damage tarps or canopies. Convenient ball design for easy installation and securing. 10" length.



CATALOG NO.	DESCRIPTION	UOM	ORDER MULTIPLE
RS-TS10	Canopy Straps, 10 in, pack of 12	PK	1

TEST LEADS

Test Leads

Alligator clips are covered by pure vinyl boots for flexibility at any temperature without cracking.



CATALOG NO.	DESCRIPTION	UOM	ORDER MULTIPLE
ACK4	2 Red and 2 Black Boots w/4 Alligator Clips	EA	1
FTL3	Pair, Red and Black – 36"	EA	1
FTL3D	Pair, Red and Black – Super Heavy Duty – 36"	EA	1

Rubber Tie Down Strap

Can stretch to double its length. Quickly ties down ladders, tubing, cylinders or almost anything. Extra heavy steel "S" hooks on each end. Resists cracking and deterioration.



CATALOG NO.	DESCRIPTION	UOM	ORDER MULTIPLE
RS-9	Rubber Tie Down Strap – 10"	EA	10
RS-15	Rubber Tie Down Strap – 15"	EA	10
RS-20	Rubber Tie Down Strap – 20"	EA	10
RS-31	Rubber Tie Down Strap – 31"	EA	10
RS-41	Rubber Tie Down Strap – 41"	EA	10

Carabiners

Carabiners come in a 2 piece package and are made of 8 mm anodized aluminum. Great for attaching ropes and clipping to tool belts. For indoor or outdoor use – work or leisure. Various colors.

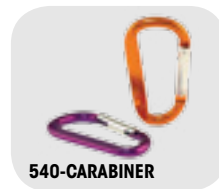

CATALOG NO.	DESCRIPTION	UOM	ORDER MULTIPLE
540-CARABINER	Carabiner Clip, pack of 2	PK	1

Multi Color Test Leads

Easy to use multi-colored test leads. 5 colors (white, red, black, yellow, green) with 2 connections each for easy testing on the job. Wire is 18 gauge, 18" long.



CATALOG NO.	DESCRIPTION	UOM	ORDER MULTIPLE
CT800	Multi Color Test Leads	EA	1

TEST LEADS cont'd

Magjumper

Magjumper from DiversiTech is a magnetic jumper for low voltage troubleshooting. It features a 20" length with magnetic tips that won't pop off like alligator clips sometimes can. It stays flexible even in cold weather and is perfect for recessed terminals. Magjumper is ideal for use on control boards, zone panels, thermostats, hydronics and automation controllers.



CATALOG NO.	DESCRIPTION	UOM	ORDER MULTIPLE
MAG-1	Magjumper Terminal Kit	EA	1

TESTERS

Test Cord (Female)

Heavy duty red and black boots are on this cord. The cord has large clips, 3 wires, and is 24in. With this cord, you can get power in remote areas without an 110V outlet. The voltage is 3 to 20 V and has 125 AMPs. The wire gauge is 16 and the weight is .36 lb.



CATALOG NO.	DESCRIPTION	UOM	ORDER MULTIPLE
6-CT700F	Test Cord (Female)	EA	1

Leak Test Gauge

This Gas gauge test is ideal for teasing all new installations of or leaks and passing inspection code. The special sensitive diaphragm gauges for more accurate low pressure readings.



CATALOG NO.	DESCRIPTION	UOM	ORDER MULTIPLE
TG-05	Leak Test Gauge – 3/4" FPT., 15 psi	EA	1
TG-30-12	Leak Test Gauge – 1/2" FPT. Conn., 30 psi	EA	1
TG-30	Leak Test Gauge – 3/4" FPT. Conn., 30 psi	EA	1
TG-30-1	Leak Test Gauge – 1" FPT. Conn., 30 psi	EA	1

LED Screwdriver Continuity Tester

A Screwdriver/Tester you can see! The tester is a self-test with AC Voltage test of 70 to 250 BAC. You can also check continuity and fuses. There is also a polarity check and the product has bright red LED. When the tip of the tester is in direct contact with the live (HOT) part of the AC voltage, the red LED lights up for an easier read and better accuracy.



CATALOG NO.	DESCRIPTION	UOM	ORDER MULTIPLE
6-ST600LED	Red LED Screwdriver Continuity Tester	EA	1

THERMOMETERS/PROBES

Digital Thermometer

Temperature range from -40° F to 230° F. Packaged on attractive display card.



CATALOG NO.	DESCRIPTION	UOM	ORDER MULTIPLE
541-300	Digital Thermometer	EA	1

Deluxe Digital Pocket Thermometer

Deluxe Digital Pocket Thermometers are water and drop resistant and have a rugged construction. There is an auto power off and an F/C Switch. The probe is 2.5in. and the range is from -40 degrees F to 300 degrees F or -40 degrees C to 150 degrees C. This thermometer comes with a protective cover with clip.



CATALOG NO.	DESCRIPTION	UOM	ORDER MULTIPLE
6-HDT303K	Deluxe Digital Pocket Thermometer	EA	1

Refrigerator/Freezer Analog Thermometer

This analog thermometer is stainless steel and can be used either hanging or free standing. The easy to read round dial is in F only. There are temperature indicators with a range -20 to 80 F (-29 to 27 C)



CATALOG NO.	DESCRIPTION	UOM	ORDER MULTIPLE
6-FT80R	Refrigerator/Freezer Analog Thermometer	EA	1

Pocket Thermometers

1" diameter dials with 5" stems (.145 dia.). Adjustable for recalibration. All stainless steel construction. Polycarbonate crystal. 1% accuracy full scale. Plastic pocket sheath included.

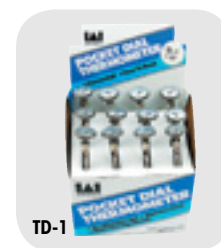

CATALOG NO.	DESCRIPTION	UOM	ORDER MULTIPLE
TD-1	Pocket Thermometer – 0°F to 220°F	EA	12
TD-2	Pocket Thermometer – -40°F to 160°F	EA	12

Horizontal Refrigerator/Freezer Analog Thermometer

With this analog thermometer, you can use it either hanging or free standing. The easy to ready display can be seen with a horizontal reading. Both F and C scales are reflected on the thermometer and the range is -40 to 80 degrees F (-40 to 27C).



CATALOG NO.	DESCRIPTION	UOM	ORDER MULTIPLE
6-FT80H	Horizontal Refrigerator/Freezer Analog Thermometer	EA	1

Analog Pocket Thermometer with Magnifying Lens

- Range 6-320: -40° to 160°F
 - Range 6-321: -0° to 220°F
 - Rugged stainless steel probe
- Includes: Protective sheath with pocket clip.

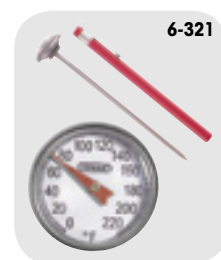

CATALOG NO.	DESCRIPTION	UOM	ORDER MULTIPLE
6-321	Analog Pocket Thermometer: Range -0° to 220°F	EA	1

TUBE WORKING TOOLS

Kut-All Plastic Tube and Hose Cutter

Tough, durable nylon. Blade closes into its own handle for safe handling. Replaceable high carbon, teflon coated steel blades. Ideal for cutting up to 1-1/8" I.D. plastic tubing, reinforced plastic tubing, rigid plastic pipe, and rubber hose.



CATALOG NO.	DESCRIPTION	UOM	ORDER MULTIPLE
PK-2	Kut-All Plastic Tube and Hose Cutter	EA	1

Little Helper™ – All Purpose Cutter

Cuts up to 1-1/4" polyethylene, thinwall PVC, ABS, rubber hose, NM conduit and clear vinyl tubing. Reversible stainless steel blade, like two blades in one. Sturdy all metal construction.



CATALOG NO.	DESCRIPTION	UOM	ORDER MULTIPLE
548-001	Little Helper™ – Carded	EA	1

TUBE WORKING TOOLS cont'd

One-Handed PVC/Hose Cutter

The ratchet system holds the blade in place while you adjust your grip to increase the pressure. The high carbon steel blade maintains sharpness and resists chipping. These cutters can be used for cutting PVC, CPVC, Polyethylene, PEX, and ABS tubing. The cutters have a quick-blade reset and can be used as a one handed operation. With the handle locking strap for safe storage, the easy replacing blade feature, and the ergonomically designed handle, these cutters are a perfect addition to any tool box.



CATALOG NO.	DESCRIPTION	UOM	ORDER MULTIPLE
6-T1191	Capacity: 1/8" to 1-5/8"; Length: 8-1/4" (210mm)	EA	1

Swivel Head Deburring Tool

This Swivel head Deburring Tool has the professional quality and the performance of a higher price deburring tool without the price tag. This product has two interchangeable blades.



CATALOG NO.	DESCRIPTION	UOM	ORDER MULTIPLE
6-T482	Handle length: 5-1/8" (130mm)	EA	1

Big Helper™ PVC Pipe Cutter

Ratchet style pipe cutters cut up to 2-1/2 in. Sch. 40 PVC Pipe. Ratchet action requires minimal pressure to easily cut through PVC pipe. Molybdenum stainless steel blade won't rust or break and lasts twice as long as most competitor's. The Mega-Cutter is now available – the strongest pipe cutter on the market today!



CATALOG NO.	DESCRIPTION	UOM	ORDER MULTIPLE
548-003	1 in. O.D. Cutting Capacity	EA	1
548-005	1-1/4 in. O.D. Cutting Capacity	EA	1
548-007	2-1/2 in. O.D. Mega-Cutter	EA	1
548-009	1-5/8 in. O.D. Cutting Capacity	EA	1

WELDING TORCHES, SUPPLIES

Heat Resistant Cloth

This flame barrier drop cloth withstands temperatures to 3,000°F. No asbestos. Protects walls, floors, equipment, components and adjacent surfaces from torch flames when soldering, brazing or welding. All cloths have edges taped and sewn with grommets at each corner. Highly resistant to many chemicals and acids.

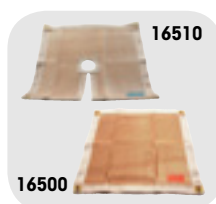

CATALOG NO.	DESCRIPTION	UOM	ORDER MULTIPLE
16500	18" x 18" Plain	EA	1
16510	18" x 18" Keyhole w/cutout for draping over pipes/tubes	EA	1
16520	36" x 36" Plain	EA	1

Map-Pro and Propane Gas

Map-Pro and Propane Gas are tanks that can be used to weld products.



CATALOG NO.	DESCRIPTION	UOM	ORDER MULTIPLE
525-MT1	Map-Pro Gas – 14 oz.	EA	12
525-PT1	Propane Gas – 14.1 oz.	EA	12

Portable Hand Torch

Self igniting hand torch eliminates the need for a flint lighter. Lightweight and portable, this flame tool can be operated with Propane or MAP-Pro™ (Propylene). Features trigger lock with instant safety release, full size comfort grip and 360° swivel tip. Operates in any position, even upside down. Includes swirl combustion tip end.



CATALOG NO.	DESCRIPTION	UOM	ORDER MULTIPLE
525-TORCH	Portable Hand Torch	EA	1

PLUMBING

CPVC-CTS Pipe and Fittings.....	186
Nylon Fittings	186-187
Oatey® Products	188
PVC Condensate Pipe	190
PVC DWV Fittings	190
PVC Primer and Cement	189
PVC Schedule 40 Pressure Fittings	191-193
Supports	194
Tubing, Clamps, and Kits	194



CPVC-CTS PIPE AND FITTINGS

CPVC-CTS Pipe by FlowGuard® Gold™

CTS = Copper Tube Size

CATALOG NO.	DESCRIPTION	UOM	ORDER MULTIPLE
4700-12	1/2" x 10' CPVC Pipe, 500'	EA	500'
4700-34	3/4" x 10' CPVC Pipe, 250'	EA	250'



4700-12

CPVC-CTS Fittings by FlowGuard® Gold™

CTS = Copper Tube Size

CATALOG NO.	DESCRIPTION	UOM	ORDER MULTIPLE
4701-12	1/2" Coupling S x S	EA	20
4704-12	1/2" Adapter M x S	EA	20
4707-12	1/2" 90° Elbow S x S	EA	20
4711-12	1/2" Tee S x S x S	EA	20
47072-12	1/2" 90° Street Ell S x S	EA	10
4718-12	3/4" x 1/2" CPVC Bushing	EA	10
4701-34	3/4" Coupling S x S	EA	20
4703-34	3/4" Adapter F x S	EA	25
4704-34	3/4" Adapter M x S	EA	10
4707-34	3/4" 90° Elbow S x S	EA	20
4711-34	3/4" Tee S x S x S	EA	20
47072-34	3/4" 90° Street Ell S x S	EA	10



4703-34

NYLON FITTINGS*

Male Adapter (Barb x MIPT)



701-001

CATALOG NO.	DESCRIPTION	UOM	ORDER MULTIPLE
701-001	Adapter – 1/2 Barb x 1/2 MIPT, pack of 2	PK	1
701-002	Adapter – 1/2 Barb x 3/4 MIPT, pack of 2	PK	1
701-003	Adapter – 1/2 Barb x 3/8 MIPT, pack of 2	PK	1
701-007	Adapter – 3/4 Barb x 3/4 MIPT, pack of 2	PK	1
701-012	Adapter – 3/8 Barb x 1/2 MIPT, pack of 2	PK	1
701-013	Adapter – 3/8 Barb x 3/8 MIPT, pack of 2	PK	1
701-014	Adapter – 5/8 Barb x 3/4 MIPT, pack of 2	PK	1
701-043	Adapter – 3/8 Barb x 3/4 MIPT, pack of 2	PK	1

Female Adapter (Barb x FIPT)



701-006

CATALOG NO.	DESCRIPTION	UOM	ORDER MULTIPLE
701-006	Adapter – 3/4 Barb x 3/4 NPT, pack of 2	PK	1
701-041	Adapter – 1/2 Barb x 1/2 NPT, pack of 2	PK	1

Bushing (MIPT x FIPT)



701-015

CATALOG NO.	DESCRIPTION	UOM	ORDER MULTIPLE
701-015	Bushing – 1 MIPT x 3/4 FIPT, pack of 2	PK	1
701-017	Bushing – 3/4 MIPT x 1/2 FIPT, pack of 2	PK	1

Garden Hose Adapters



701-008

CATALOG NO.	DESCRIPTION	UOM	ORDER MULTIPLE
701-008	Adapter – 3/4 MGHT x 3/4 FGHT, pack of 2	PK	1
701-009	Adapter – 3/4 MGHT x 3/4 FIPT, pack of 2	PK	1
701-011	Adapter – 3/4 MIPT x 3/4 FGHT, pack of 2	PK	1

*All fittings packaged with identification. To order nylon fittings in bulk, enter catalog number followed by the letter "B." For example, 701-001B is the bulk part number for 701-001. Bulk sold in packs of 100.

Elbow (Barb x Barb)



CATALOG NO.	DESCRIPTION	UOM	ORDER MULTIPLE
701-018	Elbow – 1/2 Barb, pack of 2	PK	1
701-023	Elbow – 3/4 Barb, pack of 2	PK	1
701-040	Elbow – 5/8 Barb, pack of 2	PK	1
701-046	Elbow – 3/8 Barb, pack of 2	PK	1

Female Adapter Elbow (Barb x FIPT)



CATALOG NO.	DESCRIPTION	UOM	ORDER MULTIPLE
701-019	Elbow – 1/2 Barb x 3/4 NPT, pack of 2	PK	1

Male Adapter Elbow (Barb x MIPT)



CATALOG NO.	DESCRIPTION	UOM	ORDER MULTIPLE
701-020	Elbow – 1/2 Barb x 3/4 MIPT, pack of 2	PK	1
701-025	Elbow – 3/4 Barb x 3/4 MIPT, pack of 2	PK	1
701-028	Elbow – 5/8 Barb x 3/4 MIPT, pack of 2	PK	1

Hose Mender (Barb x Barb)



CATALOG NO.	DESCRIPTION	UOM	ORDER MULTIPLE
701-029	Hose Mender – 1/2 Barb, pack of 2	PK	1
701-030	Hose Mender – 1/4 Barb, pack of 2	PK	1
701-031	Hose Mender – 3/4 Barb, pack of 2	PK	1
701-032	Hose Mender – 3/8 Barb, pack of 2	PK	1
701-033	Hose Mender – 5/8 Barb, pack of 2	PK	1

Tee (Barb x Barb x Barb)



CATALOG NO.	DESCRIPTION	UOM	ORDER MULTIPLE
701-034	Tee – 1/2 Barb, pack of 2	PK	1
701-035	Tee – 1/2 x 3/4 x 1/2 Barb, pack of 2	PK	1
701-037	Tee – 3/4 Barb, pack of 2	PK	1
701-038	Tee – 3/8 Barb, pack of 2	PK	1
701-039	Tee – 5/8 Barb, pack of 2	PK	1

*All fittings packaged with identification. To order nylon fittings in bulk, enter catalog number followed by the letter "B." For example, 701-001B is the bulk part number for 701-001. Bulk sold in packs of 100.

OATEY® PRODUCTS

PVC Cement – Clear

PVC Cement is clear. All cans have brushtop applicator.



5-12

CATALOG NO.	DESCRIPTION	UOM	ORDER MULTIPLE
5-14	Oatey #31012 – 1/4 Pint	EA	24
5-12	Oatey #31013 – 1/2 Pint	EA	24
5-10	Oatey #31014 – 1 Pint	EA	24
5-32	Oatey #31015 – 32 oz.	EA	12

Purple Primer for PVC Pipe and Fittings (Black Label)

Recommended for all PVC and CPVC installations – all sizes/schedules. Purple tinted primer formulated to remove surface dirt and grease as well as soften the pipe surface to allow for a fast, secure and permanent solvent weld. For use in areas where codes call for primer verification.



530-30756

CATALOG NO.	DESCRIPTION	UOM	ORDER MULTIPLE
530-30755	Purple Primer – 4 oz.	EA	24
530-30756	Purple Primer – 8 oz.	EA	24
530-30757	Purple Primer – 16 oz.	EA	24

NSF and UPC listed. Exceeds ASTM F-656.

Heavy Duty PVC Cement

Heavy bodied clear cement recommended for use on PVC pipe and fittings up to 12" in diameter for Sch. 40 and Sch. 80 potable water pressure pipe, gas, conduit, drain waste and vent pipe. Exceeds ASTM D-2564.



530-30863

CATALOG NO.	DESCRIPTION	UOM	ORDER MULTIPLE
530-30850	Heavy Duty Cement – 4 oz.	EA	24
530-30863	Heavy Duty Cement – 8 oz.	EA	24
530-30876	Heavy Duty Cement – 16 oz.	EA	24

Rain-R-Shine Blue Cement

Medium bodied blue colored cement for PVC pipe and fittings up to 6 inches in diameter. A very fast setting cement formulated for wet conditions and/or when quick pressurization and fast installation is needed. Exceeds ASTM D-2564.



530-30891

CATALOG NO.	DESCRIPTION	UOM	ORDER MULTIPLE
530-30890	Rain-R-Shine Cement – 4 oz.	EA	24
530-30891	Rain-R-Shine Cement – 8 oz.	EA	24
530-30893	Rain-R-Shine Cement – 16 oz.	EA	24

PVC Primer – Clear

Recommended for all PVC and CPVC applications. Can be used on all sizes and schedules. Formulated to remove all surface dirt, grease, and grime as well as soften the pipe in preparation for solvent cement. This primer can be used when you want a cleaner installation. Meets ASTM F-656 and is NSF listed.



530-30752

CATALOG NO.	DESCRIPTION	UOM	ORDER MULTIPLE
530-30752	PVC Primer – Clear – 16 oz.	EA	24
530-30753	PVC Primer – Clear – 32 oz.	EA	12

All-Purpose Clear Cement for ABS, PVC and CPVC Pipe and Fittings

Heavy-bodied clear cement recommended for use on ABS, PVC, and CPVC pipe and fittings up to 12" in diameter. Flows freely and provides a thick layer of cement on the pipe. Apply at temperatures 40° to 90°F.



530-30821

CATALOG NO.	DESCRIPTION	UOM	ORDER MULTIPLE
530-30818	Clear Cement – 4 oz.	EA	24
530-30821	Clear Cement – 8 oz.	EA	24
530-30834	Clear Cement – 16 oz.	EA	24

PVC Gray Cement for High Efficiency Furnaces, Vent and Make-Up Air

Medium-bodied gray colored cement for use on Sch. 40 conduit, drain waste, and vent pipe. Flows freely and covers with a thicker layer than regular PVC. Can be applied at temperatures 40° to 100°F.



530-30884

CATALOG NO.	DESCRIPTION	UOM	ORDER MULTIPLE
530-30884	Gray Cement – 8 oz.	EA	24
530-30885	Gray Cement – 16 oz.	EA	24

NSF and UPC listed. Exceeds ASTM D-2564.

All Weather PVC Cement

Medium bodied cement for PVC pipe and fittings up to 6". Formulated for fast initial set-up from -15°F to 100°F. Exceeds ASTM D-2564.



530-31132

CATALOG NO.	DESCRIPTION	UOM	ORDER MULTIPLE
530-31132	All Weather Cement – 16 oz.	EA	24
530-31133	All Weather Cement – 32 oz.	EA	12

PVC PRIMER AND CEMENT

Pro-Weld™ PVC Cement (Regular Body)

Pro-Weld™ PVC Cement is a clear, regular bodied solvent cement designed to be used on Type I and II PVC pipe and fittings up to and including 4 inch diameter. Pro-Weld™ meets ASTM Standard D-2564.



CATALOG NO.	DESCRIPTION	UOM	ORDER MULTIPLE
PW-4	Pro-Weld™ – 4 oz. Brush-Top Container – Regular Body	EA	24
PW-8	Pro-Weld™ – 8 oz. Brush-Top Container – Regular Body	EA	24
PW-16	Pro-Weld™ – 16 oz. Brush-Top Container – Regular Body	EA	24
PW-32	Pro-Weld™ – 32 oz. Brush-Top Container – Regular Body	EA	12

Pro-Weld™ PVC Cement (Heavy Body)

Pro-Weld™ Heavy Body is a clear, heavy bodied, very high strength industrial grade PVC cement. It has a medium setting time and works with all rigid schedule 40 and 80 pipe diameters up to 12 inches. Complies with ASTM D2564 and NSF.



CATALOG NO.	DESCRIPTION	UOM	ORDER MULTIPLE
PWH-4	Pro-Weld™ – 4 oz. Brush-Top Container – Heavy Body	EA	24
PWH-8	Pro-Weld™ – 8 oz. Brush-Top Container – Heavy Body	EA	24
PWH-16	Pro-Weld™ – 16 oz. Brush-Top Container – Heavy Body	EA	24

Pro-Weld™ PVC Cement (Pool and Turf – Blue)

Pro-Weld™ Blue Pool and Turf is a blue colored, medium bodied, high strength PVC cement for welding rigid or flexible PVC in wet conditions where the system needs to be pressurized quickly. Pro-Weld Blue Pool and Turf sets up very fast and works with all rigid and flexible schedule 40 and 80 pipe diameters up to 6 inches. Complies with ASTM D2564 and NSF.

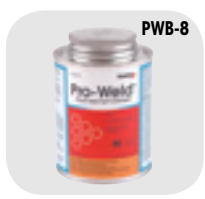

CATALOG NO.	DESCRIPTION	UOM	ORDER MULTIPLE
PWB-4	Pro-Weld™ – 4 oz. Brush-Top Container – Pool and Turf – Blue	EA	24
PWB-8	Pro-Weld™ – 8 oz. Brush-Top Container – Pool and Turf – Blue	EA	24
PWB-16	Pro-Weld™ – 16 oz. Brush-Top Container – Pool and Turf – Blue	EA	24
PWB-32	Pro-Weld™ – 32 oz. Brush-Top Container – Pool and Turf – Blue	EA	24

Pro-Weld™ PVC Cement (Universal – PVC/ABS/CPVC)

Pro-Weld™ Universal Cement is a clear, medium bodied, high strength cement for use on PVC to PVC, CPVC to CPVC, and ABS to ABS connections. Pro-Weld Universal sets up fast and works with all rigid schedule 40 and 80 piping up to 6 inches in diameter. Complies with ASTM D2564, D2235, and F493.

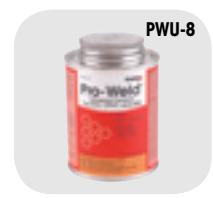

CATALOG NO.	DESCRIPTION	UOM	ORDER MULTIPLE
PWU-4	Pro-Weld™ – 4 oz. Brush-Top Container – Universal – PVC/ABS/CPVC	EA	24
PWU-8	Pro-Weld™ – 8 oz. Brush-Top Container – Universal – PVC/ABS/CPVC	EA	24
PWU-16	Pro-Weld™ – 16 oz. Brush-Top Container – Universal – PVC/ABS/CPVC	EA	24

Pro-Prime™ PVC Primer (Purple)

A purple-tinted primer formulated to remove dirt and oil from the surface of Type I and II PVC piping, as well as soften the piping in preparation for solvent welding. Pro-Prime™ contains purple pigment which provides verification that the primer has been applied to the pipe surface. Pro-Prime™ meets ASTM Standard F-656.



CATALOG NO.	DESCRIPTION	UOM	ORDER MULTIPLE
PP-4	Pro-Prime™ – 4 oz. Brush-Top Container	EA	24
PP-8	Pro-Prime™ – 8 oz. Brush-Top Container	EA	24
PP-16	Pro-Prime™ – 16 oz. Brush-Top Container	EA	24
PP-32	Pro-Prime™ – 32 oz. Can	EA	12

Pro-Prime™ Clear PVC Primer

Clear primer that removes dirt and oil from the surface of Type I and II PVC piping. Softens the piping to prepare for solvent welding. Pro-Prime Clear primer meets ASTM Standard F-656.



CATALOG NO.	DESCRIPTION	UOM	ORDER MULTIPLE
PPC-8	Pro-Prime™ Clear – 8 oz. Brush-Top Container	EA	24
PPC-16	Pro-Prime™ Clear – 16 oz. Brush-Top Container	EA	24

Pro-Weld™ Weather-ALL

Pro-Weld™ PVC Cement is a clear, regular bodied solvent cement designed to be used on Type I and II PVC pipe and fittings up to and including 4 inch diameter. Pro-Weld™ meets ASTM Standard D-2564 and is usable in cold weather to -15°F and hot weather to 110°F.

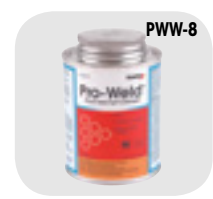

CATALOG NO.	DESCRIPTION	UOM	ORDER MULTIPLE
PWW-4	Pro-Weld™ – 4 oz. Brush-Top Container – All Weather Regular Body	EA	24
PWW-8	Pro-Weld™ – 8 oz. Brush-Top Container – All Weather Regular Body	EA	24
PWW-16	Pro-Weld™ – 16 oz. Brush-Top Container – All Weather Regular Body	EA	24

PVC CONDENSATE PIPE

Polyvinyl Chloride, White PVC 1120



CATALOG NO.	DESCRIPTION	UOM	ORDER MULTIPLE
5-2002	3/4" PVC – PSI 200 – 10' Straight End	EA	500'
5-2005	3/4" PVC – PSI 200 – 20' Belled End	EA	500'
5-401	3/4" PVC – Sch. 40 – 10' Straight End	EA	500'
5-407	3/4" PVC – Sch. 40 – 20' Belled End	EA	500'
5-404	2" PVC – Sch. 40/DWW, ASTM 2665 – 10' Straight End	EA	100'
5-405	3" PVC – Sch. 40/DWW, ASTM 2665 – 10' Straight End	EA	50'
5-416	1" PVC – Sch. 40 – 20' Belled End	EA	200'
5-417	1-1/4" PVC – Sch. 40 – 20' Belled End	EA	200'
5-418	1-1/2" PVC – Sch. 40 – 20' Belled End	EA	200'

PVC DWV FITTINGS

Couplings (Hub x Hub)



CATALOG NO.	DESCRIPTION	UOM	ORDER MULTIPLE
5-100020	2" Couplings (Hub x Hub)	EA	100
5-100030	3" Couplings (Hub x Hub)	EA	60
510-D102251	2" x 1-1/2" Couplings (Hub x Hub)	EA	25
510-D102338	3" x 2" Couplings (Hub x Hub)	EA	20

90 Elbow (Hub x Hub)



CATALOG NO.	DESCRIPTION	UOM	ORDER MULTIPLE
5-300020	2" 90 Elbow (Hub x Hub)	EA	50
5-300030	3" 90 Elbow (Hub x Hub)	EA	25
510-D304020	2" Long Sweep 90 Elbow (Hub x Hub)	EA	25
510-D304030	3" Long Sweep 90 Elbow (Hub x Hub)	EA	10

45 Elbows



CATALOG NO.	DESCRIPTION	UOM	ORDER MULTIPLE
5-321020	2" 45 Elbow (Hub x Hub)	EA	50
5-321030	3" 45 Elbow (Hub x Hub)	EA	20
510-D323020	2" 45 Street Elbow (Hub x SPIG)	EA	50
510-D323030	3" 45 Street Elbow (Hub x SPIG)	EA	20

DWV Bend Fittings



CATALOG NO.	DESCRIPTION	UOM	ORDER MULTIPLE
510-D309020	2" Long Sweep (Hub x SPIG)	EA	25
510-D309030	3" Long Sweep (Hub x SPIG)	EA	20

DWV Vent Tee



CATALOG NO.	DESCRIPTION	UOM	ORDER MULTIPLE
510-D441020	2" Vent Tee	EA	25

DWV Bushings



CATALOG NO.	DESCRIPTION	UOM	ORDER MULTIPLE
510-437338	3" x 2" Reducing Bushing (SPIG x SLIP)	EA	10
510-438338	3" x 2" Bushing (SPIG x FIPT)	EA	10

PVC SCHEDULE 40 PRESSURE FITTINGS

Tee (Slip x Slip x Slip)



CATALOG NO.	DESCRIPTION	UOM	ORDER MULTIPLE
5-401005	1/2" Tee	EA	50
5-401007	3/4" Tee	EA	50
5-401010	1" Tee	EA	50
5-401020	2" Tee	EA	25
5-401030	3" Tee	EA	10

90 Ell (Slip x Slip)

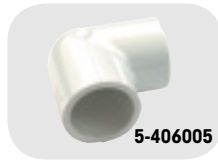

CATALOG NO.	DESCRIPTION	UOM	ORDER MULTIPLE
5-406005	1/2" 90 Ell	EA	50
5-406007	3/4" 90 Ell	EA	50
5-406010	1" 90 Ell	EA	50
5-406020	2" 90 Ell	EA	25
5-406030	3" 90 Ell	EA	10

90 Ell (Slip x FIPT)



CATALOG NO.	DESCRIPTION	UOM	ORDER MULTIPLE
5-407005	1/2" 90 Ell	EA	50
5-407007	3/4" 90 Ell	EA	50
5-407074	1/2" x 3/4" 90 Ell Reducer	EA	50
5-407131	1" x 3/4" 90 Ell Reducer	EA	50

90 Street Ell (SPIG x Slip)



CATALOG NO.	DESCRIPTION	UOM	ORDER MULTIPLE
5-409005	1/2" 90 Street Ell	EA	50
5-409007	3/4" 90 Street Ell	EA	50
5-409010	1" 90 Street Ell	EA	50

Tee (Slip x FIPT x Slip)



CATALOG NO.	DESCRIPTION	UOM	ORDER MULTIPLE
5-402007	3/4" Tee (S x S x FIPT)	EA	50

Traps

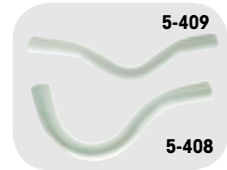

CATALOG NO.	DESCRIPTION	UOM	ORDER MULTIPLE
5-408	3/4" "P" Trap	EA	100
5-409	3/4" Running Trap	EA	100
5-410	3/4" Mini "P" Trap	EA	100
5-411	1" "P" Trap	EA	50
5-412	1/2" "P" Trap	EA	100
5-414	3/4" "J" Trap	EA	100

90 Ell Reducing (Slip x FIPT)



CATALOG NO.	DESCRIPTION	UOM	ORDER MULTIPLE
5-407131	1" x 3/4" 90 Ell Reducing	EA	50

45 Ell (Slip x Slip)



CATALOG NO.	DESCRIPTION	UOM	ORDER MULTIPLE
5-417005	1/2" 45 Ell	EA	50
5-417007	3/4" 45 Ell	EA	50
5-417010	1" 45 Ell	EA	50
5-417012	1-1/4" 45 Ell	EA	25
5-417020	2" 45 Ell	EA	25
5-417030	3" 45 Ell	EA	10

PVC SCHEDULE 40 PRESSURE FITTINGS cont'd

Plug (Slip)



CATALOG NO.	DESCRIPTION	UOM	ORDER MULTIPLE
5-449005	1/2" Plug	EA	50
5-449007	3/4" Plug	EA	50
5-449030	3" Plug	EA	10

90 Street Ell (MIPT x Slip)



CATALOG NO.	DESCRIPTION	UOM	ORDER MULTIPLE
5-410005	1/2" 90 Street Ell	EA	50
5-410007	3/4" 90 Street Ell	EA	50
5-410010	1" 90 Street Ell	EA	50

Female Adapter (Slip x FIPT)



CATALOG NO.	DESCRIPTION	UOM	ORDER MULTIPLE
5-435005	1/2" Female Adapter	EA	100
5-435007	3/4" Female Adapter	EA	50

Female Adapter Reducing (Slip x FIPT)



CATALOG NO.	DESCRIPTION	UOM	ORDER MULTIPLE
5-435101	3/4" x 1/2" Female Adapter Reducing	EA	50
5-435102	3/4" x 1" Female Adapter Reducing	EA	50

Coupling (Slip x Slip)



CATALOG NO.	DESCRIPTION	UOM	ORDER MULTIPLE
5-429005	1/2" Coupling	EA	100
5-429007	3/4" Coupling	EA	50
5-429010	1" Coupling	EA	50
5-429015	1-1/2" Coupling	EA	25
5-429020	2" Coupling	EA	25
5-429030	3" Coupling	EA	10

Cap (Slip)



CATALOG NO.	DESCRIPTION	UOM	ORDER MULTIPLE
5-447007	3/4" Cap	EA	100

Male Adapter (MIPT x Slip)



CATALOG NO.	DESCRIPTION	UOM	ORDER MULTIPLE
5-436005	1/2" Male Adapter	EA	100
5-436007	3/4" Male Adapter	EA	50
5-436010	1" Male Adapter	EA	50
5-436020	2" Male Adapter	EA	25
5-436030	3" Male Adapter	EA	10

Plug (MIPT)



CATALOG NO.	DESCRIPTION	UOM	ORDER MULTIPLE
5-450007	3/4" Plug	EA	50

Male Adapter Reducing (MIPT x Slip)



CATALOG NO.	DESCRIPTION	UOM	ORDER MULTIPLE
5-436074	1/2" x 3/4" Male Adapter Reducing	EA	50
5-436101	3/4" x 1/2" Male Adapter Reducing	EA	50
5-436102	3/4" x 1" Male Adapter Reducing	EA	50
5-436131	1" x 3/4" Male Adapter Reducing	EA	50

Reducer Bushing (SPIG x Slip)



CATALOG NO.	DESCRIPTION	UOM	ORDER MULTIPLE
5-437101	3/4" x 1/2" Reducer Bushing	EA	100
5-437130	1" x 1/2" Reducer Bushing	EA	100
5-437131	1" x 3/4" Reducer Bushing	EA	100
5-437210	1-1/2" x 3/4" Reducer Bushing	EA	25

Reducer Bushing (SPIG X FIPT)



CATALOG NO.	DESCRIPTION	UOM	ORDER MULTIPLE
5-438101	3/4" x 1/2" Reducer Bushing	EA	100
5-438131	1" x 3/4" Reducer Bushing	EA	100

Cap (FIPT)



CATALOG NO.	DESCRIPTION	UOM	ORDER MULTIPLE
5-448007	3/4" Cap	EA	100

Adapter (Insert x Slip)



CATALOG NO.	DESCRIPTION	UOM	ORDER MULTIPLE
5-474007	3/4" Adapter (Insert x Slip)	EA	50

Clean Out Tee



CATALOG NO.	DESCRIPTION	UOM	ORDER MULTIPLE
510-3400-10	3/4" Clean Out Tee	EA	10
510-3400	3/4" Clean Out Tee	EA	50

3/4" Rubber Elbow

Allows for quick disconnect and reconnect of drain lines. Made of 60 DURO EPDM.



CATALOG NO.	DESCRIPTION	UOM	ORDER MULTIPLE
5-520	3/4" Rubber Elbows	EA	50

SUPPORTS

Plastic DWV J-Hooks



CATALOG NO.	DESCRIPTION	UOM	ORDER MULTIPLE
515-J2000	2" x 9" DWV Swiveling J-Hook	EA	25
515-J3000	3" x 7-1/2" DWV Swiveling J-Hook	EA	25

TUBING, CLAMPS, AND KITS

Polyethylene Tubing

F.D.A. approved, flexible, non-toxic tubing. Tasteless and odorless, lightweight, low density. Ideal for drinking water lines, evaporative coolers, and radiant heating. I.D.: 11/64", O.D.: 1/4", Wall: 0.040, Max. W/P (in.) 150 PSI @ 70F.



CATALOG NO.	DESCRIPTION	UOM	ORDER MULTIPLE
PE-104	Polyethylene Tubing - 11/64ID, 1/4OD, 100FT	EA	1
PE-014	Polyethylene Tubing - 1/8ID, 1/4OD, 100FT	EA	1
PE-038	Polyethylene Tubing - 1/4ID, 3/8 OD, 100FT	EA	1
PE-058	Polyethylene Tubing - 1/2ID, 5/8OD, 100FT	EA	1

Icemaker Kit

Supplies water to most refrigerators with automatic icemakers, humidifiers and evaporative coolers. Contains self-tapping valve and all necessary fittings.



CATALOG NO.	DESCRIPTION	UOM	ORDER MULTIPLE
750-401	Icemaker Kit - Poly Tube - 25'	EA	1
750-402	Icemaker Kit - Copper - 25'	EA	1

Hose Clamps

Partial stainless, worm drive, adjustable. 300 series stainless steel 1/2" band with plated 5/16" slotted hex head screw and housing, except the B-4H which has a 5/16" band and 1/4" nut. Recommended for most applications. 100% interlock construction features one-piece housing which directly locks into band. Spot weld free design.

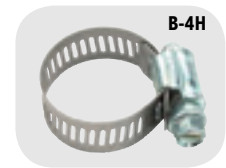

CATALOG NO.	DESCRIPTION	UOM	ORDER MULTIPLE
B-4H	No. 4, 7/32" - 5/8" dia., 3/16" - 5/16" hose I.D.	EA	10
B-6H	No. 6, 3/8" - 7/8" dia., 1/4" - 3/8" hose I.D.	EA	10
B-8H	No. 8, 7/16" - 1" dia., 5/16" - 1/2" hose I.D.	EA	10
B-10H	No. 10, 9/16" - 1-1/16" dia., 3/8" - 5/8" hose I.D.	EA	10
B-12H	No. 12, 9/16" - 1-1/4" dia., 5/8" - 3/4" hose I.D.	EA	10
B-16H	No. 16, 11/16" - 1-1/2" dia., 3/4" - 1" hose I.D.	EA	10
B-20H	No. 20, 3/4" - 1-3/4" dia., 1" - 1-1/4" hose I.D.	EA	10
B-24H	No. 24, 1-1/16" - 2" dia., 1-1/4" - 1-1/2" hose I.D.	EA	10
B-28H	No. 28, 1-5/16" - 2-1/4" dia., 1-1/4" - 1-3/4" hose I.D.	EA	10
B-32H	No. 32, 1-9/16" - 2-1/2" dia., 1-1/2" - 2" hose I.D.	EA	10
B-36H	No. 36, 1-13/16" - 2-3/4" dia., 1-3/4" - 2-1/4" hose I.D.	EA	10

Self Tapping Water Valve

Installs on all copper tube lines from 3/8" O.D. to 1-1/8" O.D. without shutting off water. No drilling required. Features 1/4" compression fitting. Stainless steel piercing needle. Special molded gasket seals on both tubing and valve. Will not slip or turn on tubing.



CATALOG NO.	DESCRIPTION	UOM	ORDER MULTIPLE
QAV-2	Self Tapping Water Tap Valve	EA	1

DUCTLESS SYSTEMS

SpeediChannel™ Line Set Cover System 201
 Fittings..... 201-204
 Roof Inlets..... 204



SpeediChannel™ Line Set Cover System

DiversiTech SpeediChannel™ is an innovative channel system used to cover air conditioning line sets. The two part system has a base and a cover. The base is fastened to a wall or ceiling, then a clever little plastic clip (SpeediClip™) snaps into a channel already molded into the base. Then, using standard cable ties, the line set, cables, control wires, and/or condensate drain line are fastened in place. The cover then snaps simply on top of the base.

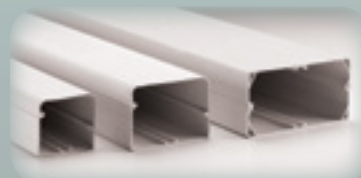

The SpeediChannel™ system is available in three widths – 3", 4", and 6". Each piece of Speedi-Channel™ is 6-1/2 feet long. A complete line of couplings, elbows, and tees are available for the SpeediChannel™ system.

Manufactured from rigid PVC, the SpeediChannel™ system comes in two popular colors. A Natural color that matches most mini-split condensing units or can be painted as desired to match any wall color. Use paint made for plastic only. A brown Terrastone color is also available which is popular with homeowners. the PVC used in the SpeediChannel system is resistant to UV light and is UL rated.



DiversiTech recommends attaching the base to the wall or ceiling and the line sets to the system every 15" to allow for the system to carry the full weight of the line sets.

The SpeediChannel™ can also be used inside.



Now available in Brown



*Cut your installation time!
SpeediClip™— fastest
SpeediChannel™
installation.*

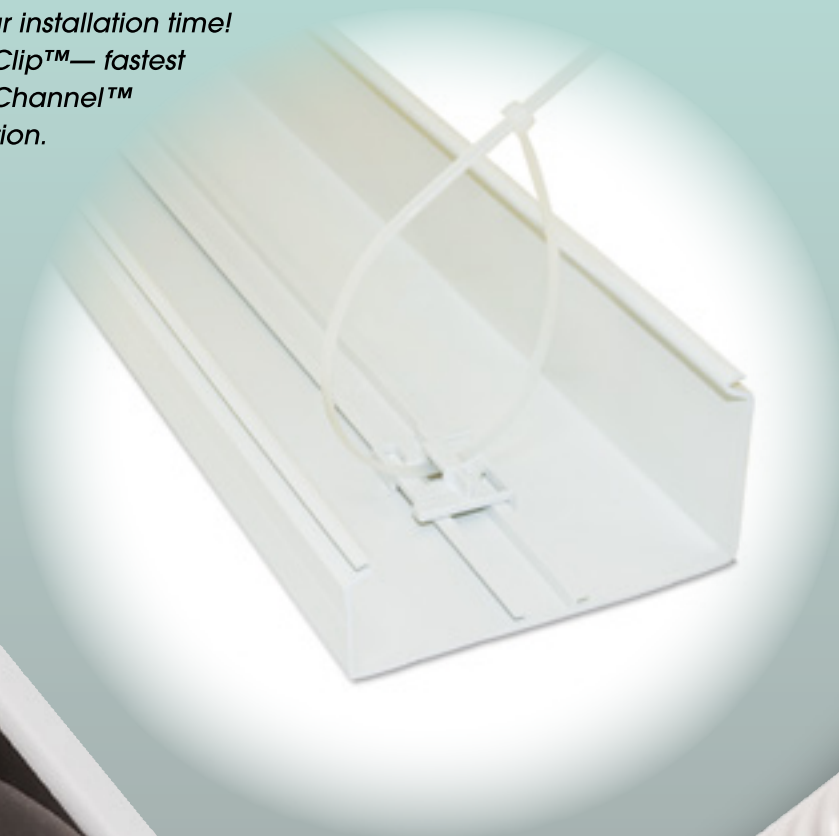

DiversiTech SpeediChannel™ System

SIZING CHART AND SELECTION INFORMATION

Maximum Line Set, Drain Pipe, and Cable Capacity using 3/8" Insulation

Model	230-D3	230-D4	230-D6
Dimensions	3" x 2-1/2"	4" x 2-3/4"	6" x 3"
Length	78"	78"	78"

Mini-Split Systems – Liquid and Suction Line with 3/8" Insulation

Liquid Line	3/8"	2 x 1/4"	1 x 1/4" + 2 x 3/8"
Suction Line	5/8"	2 x 3/8"	1 x 1/2" + 2 x 5/8"
Drain Hose	3/4" OD	2 x 3/4" OD	3 x 3/4" OD
Power Cable	1 x UF 14-3	2 x 1/2" SealTite	3 x 1/2" SealTite
Control Cable	1 Pair 18 AWG	2 Pairs 18 AWG	3 Pairs 18 AWG
Nominal Tonnage	1–3 Tons	1x3 Ton or 2x1 Ton	1x3 Ton or 2x2 Ton

Conventional Split Systems – Liquid Line Plain, Suction Line with 3/8" Insulation

Liquid Line	3/8"	3/8"	3/8"
Suction Line	3/4" or 7/8"	1-1/8"	1-1/8"
Drain Hose	3/4" PVC	3/4" PVC	3/4" PVC
Power Cable	1 x UF 14-2	1 x 1/2" SealTite	1 x 1/2" SealTite
Control Cable	1 Pair 18 AWG	1 Pair 18 AWG	1 Pair 18 AWG
Nominal Tonnage	Up to 3.5 Tons	4–5 Tons	7.5 Tons and up

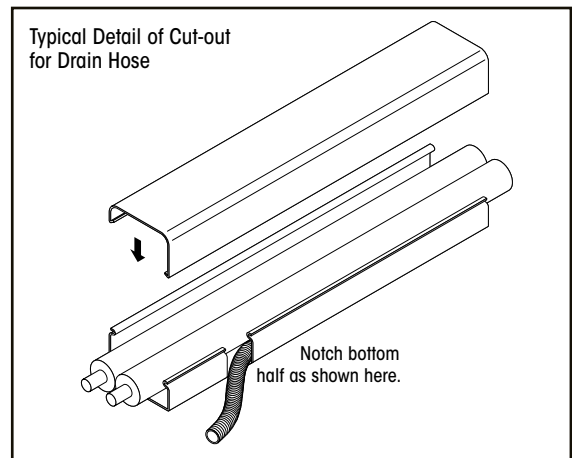
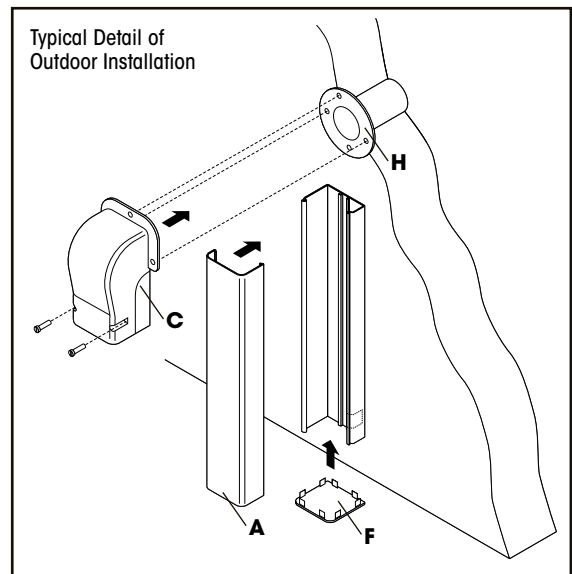
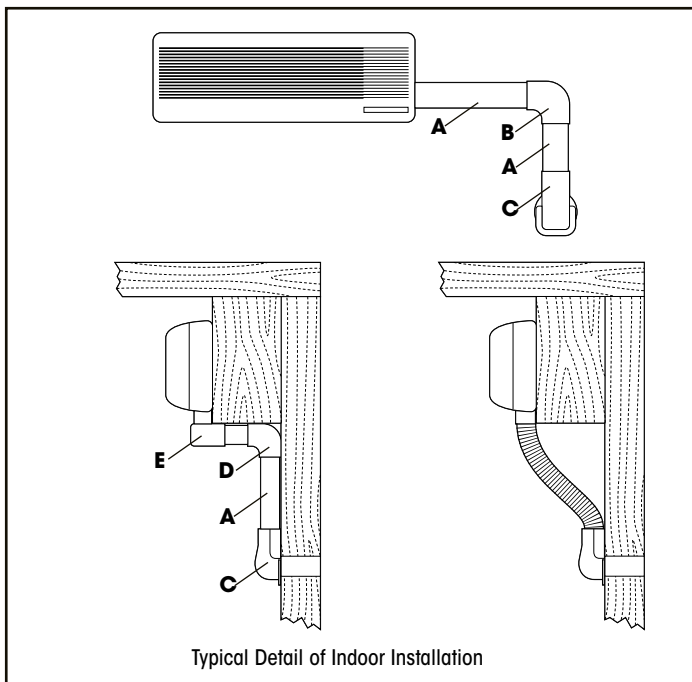

- A - 230-D
- B - 230-FB
- C - 230-WC
- D - 230-EB
- E - 230-EIN
- F - 230-DC
- G - 230-FJ
- H - 230-WS2

NOTE:
Suffix parts A-G
with the duct
size needed
(3,4, or 6)

Typical Detail of Flex Joint Application

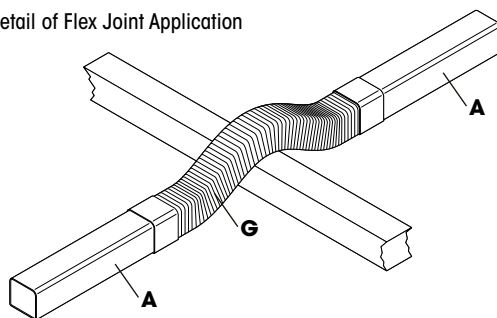

DiversiTech SpeediChannel™ System

TECHNICAL SPECIFICATIONS

Color	Natural or Brown in select 3" & 4" sizes		
Size	230-D3: 3" x 2-1/2" OD	230-D4: 4" x 2-3/4" OD	230-D6: 6" x 3-1/8" OD
Material	Weather Resistant PVC, UV Stabilized and Fire Resistant		
Fire Rating	Meets UL 94V-0		
Temperature Range	-4°F TO 140°F		
Weather Resistance	Tested to over 2,000 hours		
Fixing Screws	Stainless Steel		

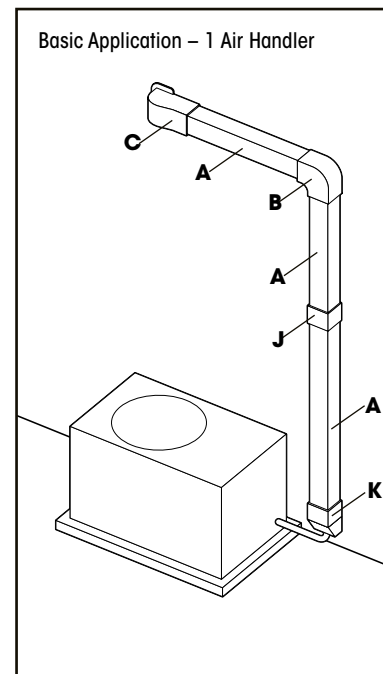
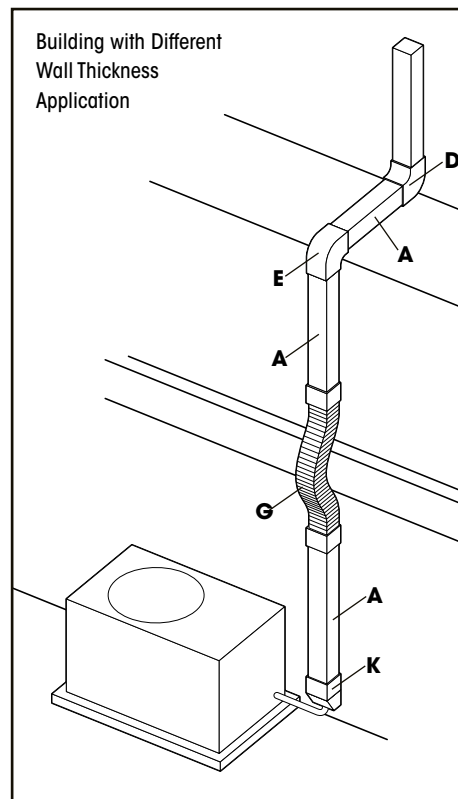
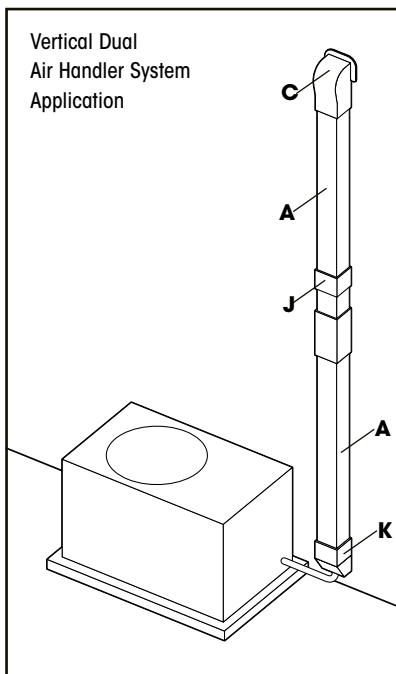
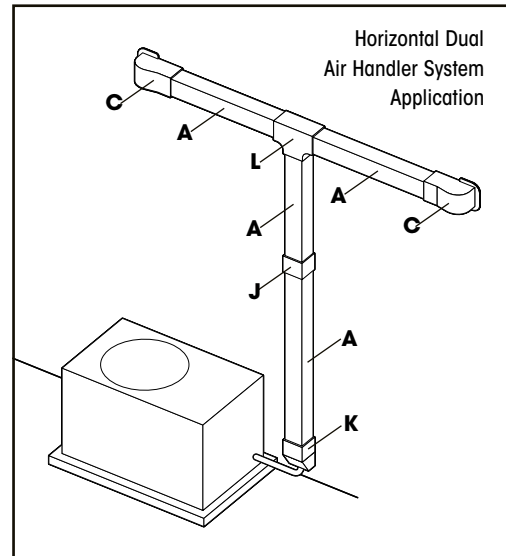
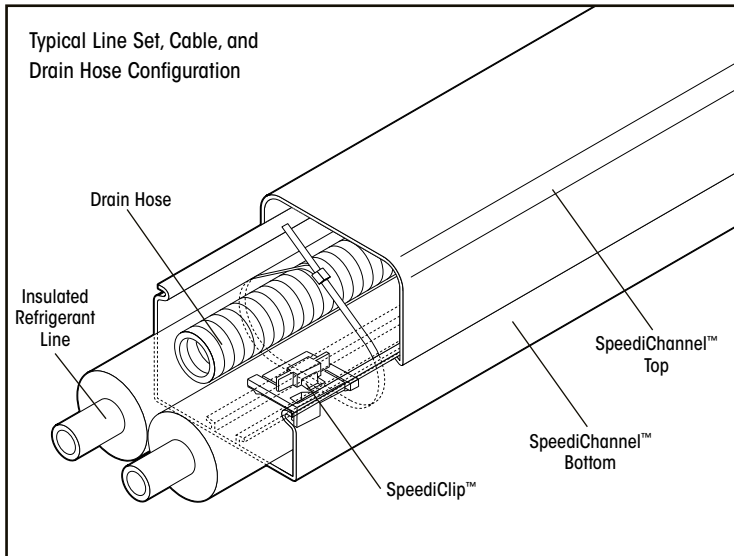

- A - 230-D
- B - 230-FB
- C - 230-WC
- D - 230-EB
- E - 230-EIN
- F - 230-DC
- G - 230-FJ
- H - 230-WS2
- J - 230-CP
- K - 230-DE
- L - 230-TC

NOTE:
Suffix parts A-G
with the duct
size needed
(3, 4, or 6)

SpeediChannel™ System Installation

Step 1

Attach the SpeediChannel™ base to the wall about every 15 inches with screws suitable for the wall construction (siding, stucco, brick, etc.). Screw through the center of the molded rail. Slide the connecting piece (elbow, union, tee, etc.) under the SpeediChannel™ before attaching the end of the channel to the wall. When cutting lengths of SpeediChannel™, allow 1/8" gap between the end of the SpeediChannel™ and the stop inside the fitting to allow for thermal expansion.



Step 4

Attach the SpeediChannel™ to the base.



Step 2

Attach one SpeediClip™ with cable tie about every 20 inches along the inside sliding rail.



Step 5

Attach the fitting covers with the screws provided.



Step 3

Install the line set, drain line, and wires inside the SpeediChannel™. Test the equipment installation prior to tightening the cable ties. Tighten the cable ties snug, but not so tight they damage the tubing insulation or kink the drain line. Trim excess length from the cable tie.



Step 6

When complete, paint the SpeediChannel™ to match surface of installation (if desired).

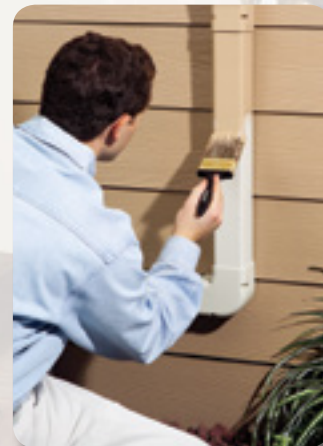

SPEEDICHANNEL™ LINE SET COVER SYSTEM

SpeediChannel™

The DiversiTech SpeediChannel™ is available in three widths, all in 6-1/2 feet lengths. Includes pack of SpeediClips™.

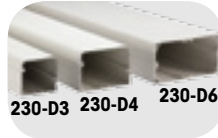

CATALOG NO.	DESCRIPTION	UOM	ORDER MULTIPLE
230-D3	3" SpeediChannel™	EA	6
230-D3B	3" SpeediChannel™, Brown	EA	6
230-D4	4" SpeediChannel™	EA	6
230-D4B	4" SpeediChannel™, Brown	EA	6
230-D6	6" SpeediChannel™	EA	5

Channel must ship LTL.

FITTINGS

Adjustable Flat Bend

Adjustable flat bends flex from 45 to 90 degrees and make it easy to route the SpeediChannel™ around an obstacle. Each adjustable bend is individually packed and includes stainless steel screws.



CATALOG NO.	DESCRIPTION	ORDER UOM	ORDER MULTIPLE
230-AFB3	3in. Adjustable Flat Bend	EA	10
230-AFB4	4in. Adjustable Flat Bend	EA	10

Soffit Fittings

Ideal for outdoor applications where the SpeediChannel™ runs up an exterior wall and enters the house vertically through the soffit. Its large flat surface area easily covers the rough opening cut in the soffit. Furnished in two parts, the Soffit Fitting easily snaps onto the SpeediChannel™ for a clean installation.



CATALOG NO.	DESCRIPTION	ORDER UOM	ORDER MULTIPLE
230-SF3	3" Soffit Fitting	EA	10
230-SF4	4" Soffit Fitting	EA	10

Wall Penetration

Wall sleeves and penetration covers are used to transition from the SpeediChannel™ system to a through wall penetration. The wall sleeve creates a neat hole through the wall, and the line set is covered by the wall cover. DiversiTech's wall covers are designed to allow for easy installation - even after the line set has been installed. A unique hooking and fastening arrangement allows for quick and easy installation. Each wall cover is individually packed, and is furnished complete with stainless steel screws to attach the wall cover to the base. Three screws (supplied by others) are needed to fasten the wall cover to whatever type of wall construction the system is being installed on.



CATALOG NO.	DESCRIPTION	UOM	ORDER MULTIPLE
230-WC3	3" Wall Penetration Cover	EA	10
230-WC3B	3" Wall Penetration Cover, Brown	EA	10
230-WC4	4" Wall Penetration Cover	EA	10
230-WC4B	4" Wall Penetration Cover, Brown	EA	10
230-WC6	6" Wall Penetration Cover	EA	10
230-WS2	2-1/2" Wall Sleeve	EA	10

90° Flat Bend

90° flat bends are used to route the SpeediChannel™ around an obstacle. Each bend is individually packed, and is furnished complete with stainless steel screws.



CATALOG NO.	DESCRIPTION	UOM	ORDER MULTIPLE
230-FB3	3" 90 degree Flat Bend	EA	10
230-FB3B	3" 90 degree Flat Bend, Brown	EA	10
230-FB4	4" 90 degree Flat Bend	EA	10
230-FB4B	4" 90 degree Flat Bend, Brown	EA	10
230-FB6	6" 90 degree Flat Bend	EA	10

FITTINGS cont'd

90° Long Radius Bend

90° long radius flat bends are used to route the SpeediChannel™ around an obstacle. The long radius of the elbow allows a gentle bending radius on the copper line set. Each elbow is individually packed, and is furnished complete with stainless steel screws.



230-LFB4

CATALOG NO.	DESCRIPTION	UOM	ORDER MULTIPLE
230-LFB3	3" 90 degree Long Radius Bend	EA	10
230-LFB3B	3" 90 degree Long Radius Bend, Brown	EA	10
230-LFB4	4" 90 degree Long Radius Bend	EA	10
230-LFB4B	4" 90 degree Long Radius Bend, Brown	EA	10
230-LFB6	6" 90 degree Long Radius Bend	EA	10

90° Inside Elbow

90° inside elbows are used to route the SpeediChannel™ around an inside corner. Each elbow is individually packed, and is furnished complete with stainless steel screws.



230-EB3



CATALOG NO.	DESCRIPTION	UOM	ORDER MULTIPLE
230-EB3	3" 90 degree Inside Elbow	EA	10
230-EB3B	3" 90 degree Inside Elbow, Brown	EA	10
230-EB4	4" 90 degree Inside Elbow	EA	10
230-EB4B	4" 90 degree Inside Elbow, Brown	EA	10
230-EB6	6" 90 degree Inside Elbow	EA	10

Union Coupling

Used for joining two pieces of SpeediChannel™ — each cover being the same size. Each coupling is individually packed, and is furnished complete with stainless steel screws.



230-CP3



CATALOG NO.	DESCRIPTION	UOM	ORDER MULTIPLE
230-CP3	3" Union Coupling	EA	10
230-CP3B	3" Union Coupling, Brown	EA	10
230-CP4	4" Union Coupling	EA	10
230-CP4B	4" Union Coupling, Brown	EA	10
230-CP6	6" Union Coupling	EA	10

45° Flat Bend

45° flat bends are used to route the SpeediChannel™ around an obstacle. Each bend is individually packed, and is furnished complete with stainless steel screws.



230-FB453

CATALOG NO.	DESCRIPTION	UOM	ORDER MULTIPLE
230-FB453	3" 45 degree Flat Bend	EA	10
230-FB453B	3" 45 degree Flat Bend, Brown	EA	10
230-FB454	4" 45 degree Flat Bend	EA	10
230-FB454B	4" 45 degree Flat Bend, Brown	EA	10
230-FB456	6" 45 degree Flat Bend	EA	10

90° Outside Elbow

90° outside elbows are used to route the SpeediChannel™ around an outside corner. Each elbow is individually packed, and is furnished complete with stainless steel screws.



230-EIN3



CATALOG NO.	DESCRIPTION	UOM	ORDER MULTIPLE
230-EIN3	3" 90 degree Outside Elbow	EA	10
230-EIN3B	3" 90 degree Outside Elbow, Brown	EA	10
230-EIN4	4" 90 degree Outside Elbow	EA	10
230-EIN4B	4" 90 degree Outside Elbow, Brown	EA	10
230-EIN6	6" 90 degree Outside Elbow	EA	10

T-Joint

Used for creating a tee connection between three pieces of SpeediChannel™ — all covers being the same size. The tee can be combined with the reducing coupling to join SpeediChannel™s of different sizes. Each tee is individually packed, and is furnished complete with stainless steel screws.



230-TJ4



CATALOG NO.	DESCRIPTION	UOM	ORDER MULTIPLE
230-TJ4	4" T-Joint	EA	10
230-TJ4B	4" T-Joint, Brown	EA	10
230-TJ6	6" T-Joint	EA	10

FITTINGS cont'd

Flex Joint

An accordion style piece of SpeediChannel™, the flex joint can be extremely flexible routing a SpeediChannel™ system around virtually any type of obstacle. Each joint is 20" long and can be combined together for longer flex runs. Unlike competitor systems, the DiversiTech flex joint does NOT require the use of a union coupling. The DiversiTech flex joint slides tightly inside the SpeediChannel™ system.



230-FJ3

CATALOG NO.	DESCRIPTION	UOM	ORDER MULTIPLE
230-FJ3	3" Flex Joint	EA	10
230-FJ4	4" Flex Joint	EA	10

Duct End

The duct end is used to terminate a run of SpeediChannel™ to a small opening – just large enough for the line set and condensate drain line to pass through. Gives a neat/clean installation.



230-DE3 230-DE4



CATALOG NO.	DESCRIPTION	UOM	ORDER MULTIPLE
230-DE3	3" Duct End	EA	10
230-DE3B	3" Duct End, Brown	EA	10
230-DE4	4" Duct End	EA	10
230-DE4B	4" Duct End, Brown	EA	10
230-DE6	6" Duct End	EA	10

Flat Wall Escutcheon

Typically used to cover a rough opening in a soffit, wall, or ceiling penetration. One side of the escutcheon is flat to allow for a SpeediChannel™ run going along a wall, and penetrating through an adjacent wall or ceiling. This is the most common type of wall penetration. Furnished in two parts, the escutcheon easily snaps onto the SpeediChannel™.



230-FR3



CATALOG NO.	DESCRIPTION	UOM	ORDER MULTIPLE
230-FR3	3" Flat Wall Escutcheon	EA	10
230-FR4	4" Flat Wall Escutcheon	EA	10
230-FR6	6" Flat Wall Escutcheon	EA	10

Reducer Coupling

Used for joining two pieces of SpeediChannel™ — each cover being a different size. Each coupling is individually packed, and is furnished complete with stainless steel screws.



230-TC34



CATALOG NO.	DESCRIPTION	UOM	ORDER MULTIPLE
230-TC34	3" x 4" Reducer Coupling	EA	10
230-TC46	4" x 6" Reducer Coupling	EA	10

Cap

Used to cap the end of a SpeediChannel™ run. Easily snaps into the end of the SpeediChannel™.



230-DC3

CATALOG NO.	DESCRIPTION	UOM	ORDER MULTIPLE
230-DC3	3" Cap	EA	10
230-DC4	4" Cap	EA	10
230-DC6	6" Cap	EA	10

Wall Escutcheon

Typically used to cover a rough opening in a wall or ceiling penetration. The hole in the escutcheon is centered to allow for a free standing SpeediChannel™ to penetrate through a wall or ceiling. This is the fairly un-common type of wall or ceiling penetration. Check carefully, as you may need the Flat Wall Escutcheon. Furnished in two parts, the escutcheon easily snaps onto the SpeediChannel™.



230-WR3



CATALOG NO.	DESCRIPTION	UOM	ORDER MULTIPLE
230-WR3	3" Wall Escutcheon	EA	10
230-WR4	4" Wall Escutcheon	EA	10
230-WR6	6" Wall Escutcheon	EA	10

FITTINGS cont'd

SpeediChannel™ Accessories

A variety of accessories that are complementary or required for installing DiversiTech's SpeediChannel™ system.

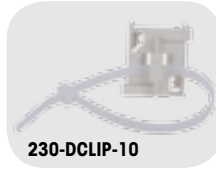

CATALOG NO.	DESCRIPTION	UOM	ORDER MULTIPLE
230-DCLIP-10	SpeediClip™ and 11" Cable Ties, pack of 10	PK	1
230-DCLIP	*SpeediClip™, pack of 50	PK	1
230-DSCREW	SpeediChannel™ screws, pack of 100	PK	1
WTB11C	Black Wire Ties – 11", pack of 100	PK	1

Universal Pump Elbow

The Universal Pump Elbow lets an installer use any mini pump of their choice and install it with SpeediChannel. Includes pump elbow and reservoir mounting brackets to fit most mini-split pumps.



CATALOG NO.	DESCRIPTION	UOM	ORDER MULTIPLE
230-PFB3	Universal Pump Elbow	EA	1

SpeediChannel™ Kits

The SpeediChannel™ Fitting Kit provides a simple mix of the basic fittings used in a typical SpeediChannel™ installation job. Included are one coupling, one wall penetration, one inside elbow, one long radius flat bend, and one pack of ten SpeediClips and 11" cable ties. The 230-IKC3 and 230-IKC4 Installation Kits include three 48" pieces of channel and selected fittings.



CATALOG NO.	DESCRIPTION	UOM	ORDER MULTIPLE
230-IK3	3" SpeediChannel™ Fitting Kit	EA	1
230-IK4	4" SpeediChannel™ Fitting Kit	EA	1
230-IKC3	3" SpeediChannel™ Installation Kit	EA	1
230-IKC4	4" SpeediChannel™ Installation Kit	EA	1

ROOF INLETS

Roof Inlets

"Roof entrance" adapters for linesets are the ultimate solution for a professional flat roof installation. Manufactured from UV weather resistant plastics, the Roof Inlet combines a series of features:

- The Roof Inlet body part is equipped with a slope avoiding possible damage to the insulation and preventing kinks into the copper tubes.
- The Roof Inlet base holes allow a steady fixation (depending on the roof surface type and composition).
- The Roof Inlet cap is firmly fixed to the body with stainless steel bolts.



CATALOG NO.	DESCRIPTION	UOM	ORDER MULTIPLE
230-INJ462	SpeediChannel™ Roof Inlet – 10"	EA	2

MAINTENANCE CHEMICALS

Accessories	221
Additives	230
Coil Cleaners	220-221
Coil Cleaning Aerosols	222
Drain Pan Disinfectant	222
Flushing Products	223
Glycols	222-223
Hoses, Sprayers	224
Ice Machine Products	225
Leak Detectors and Accessories	225-226
Leak Sealants	226
Maintenance Chemical Quick Reference Guide	218-219
Odor Neutralizers	227
Pan Treatments/Disinfectants	227-228
Refrigeration Oils	228-229
System Cleaners	229
Test Kits	229
Thread Sealants	230
Vacuum Pump Oil	230



Triple-D® Universal Coil Cleaner

Triple-D is a Universal Coil Cleaner suitable for use on condenser and evaporator coils. It is metal safe and does not attack aluminum or copper coil components, extending equipment life and diminishing potential for refrigerant leaks. Triple-D is a more versatile product than conventional acid or non-acid coil cleaners. One product does it all — truly a Universal Coil Cleaner.

FEATURES

BENEFITS

Universal Coil Cleaner One product for multiple applications reduces inventory and eliminates potential product mis-application.

Metal Compatible Conventional foaming acid coil cleaners actually attack and chemically react with the aluminum coil components. This reaction is exhibited by a foaming action. Conventional foaming non-acid coil cleaners are so strong (because they lack the unique inhibitor in Triple-D) they also attack the aluminum coil components. The attack/reaction dissolves the aluminum, destroying the heat-transfer ability of the coil, and creates the potential for refrigerant leaks. Over time, the reduction in heat transfer ability for the coil increases energy consumption significantly.

Super Concentrated Lower cost per mixed gallon. Triple-D is a 6:1 dilution ratio, making 7 gallons of usable product per gallon of concentrate.

Multiple Packages/Forms Available as a concentrated liquid, pre-diluted liquid, aerosol, or Granular Coil Cleaner. Same product — different packages.

NSF Registered Assurance that Triple-D is an ideal cleaner for restaurants, hospitals, government institutions, and any food preparation area. Rinse thoroughly after use.

Safe for Rubber Roofs Does not damage engineered polymeric or rubber roofing.

Corrosion Inhibited Conventional foaming acid and non-acid coil cleaners actually attack and chemically react with the aluminum (and sometimes copper) coil components. This reaction is exhibited by a foaming action. The reaction dissolves the aluminum, destroying the heat-transfer ability of the coil, creating the potential for refrigerant leaks.

Biodegradable Triple-D is manufactured from chemicals that break down naturally in the environment. When a coil is cleaned, the rinse water is typically washed away.

Non-Foaming Foaming of coil cleaners is exhibited when the cleaner chemically reacts with the aluminum (and sometimes the copper) coil components. This reaction is exhibited by a foaming action. The reaction dissolves the aluminum, destroying the heat-transfer ability of the coil, and creates the potential for refrigerant leaks. Additionally, foaming action on foaming coil cleaners is an exothermic (heat generating) chemical reaction. This heat is extreme and can damage coils.

Non-Toxic Triple-D is manufactured from chemicals that break down naturally in the environment. When a coil is cleaned, the rinse water is typically washed away. Conventional acid coil cleaners contain dangerous hydrofluoric acid that is extremely toxic to humans and animals.

Inhibited Non-Acid Formulation Triple-D contains a unique inhibitor that allows for a very strong alkaline (non-acid) formulation that effectively cleans coils. Other non-acid coil cleaners are either too weak to effectively clean a coil, or are so strong (and hence foaming) that they attack the aluminum coil.

Aluminum Loss of Foaming Coil Cleaners vs. Triple-D®

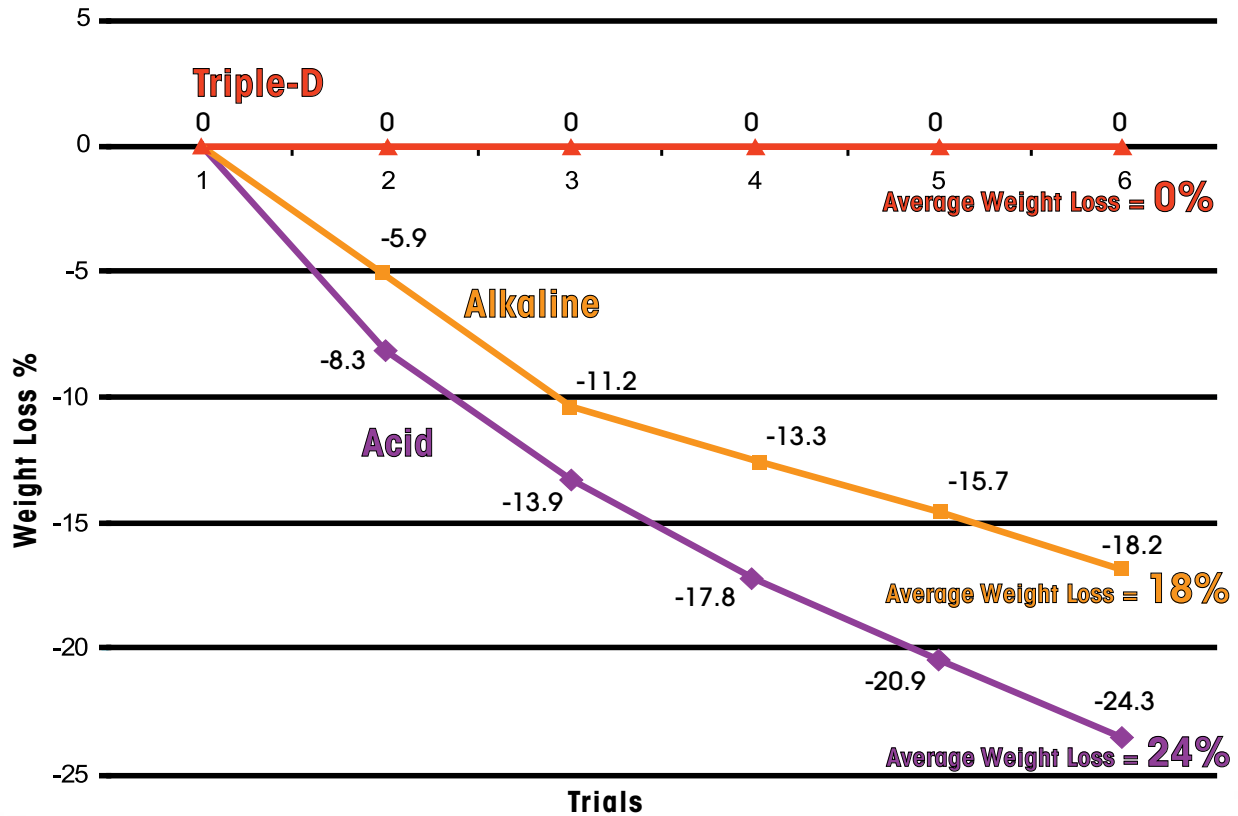

As shown above, conventional foaming acid coil cleaners and foaming non-acid coil cleaners actually attack and chemically react with the aluminum coil components. This reaction is exhibited by a foaming action. The attack/reaction dissolves the aluminum, destroying the heat-transfer ability of the coil creating the potential for refrigerant leaks.



SUPER SEAL FLEX INJECT[®]

STOPS LEAKS PERMANENTLY



FASTEST - EASIEST - PROVEN

DiversiTech introduces Super Seal Flex Inject, a NEW refrigerant leak sealant solution that will save both Contractors and Home Owners time and money!



3X SEALING POWER

Patent pending Flex Inject triple power sealant is the fastest, most effective proven way to permanently seal and prevent air conditioning and refrigeration (HVAC/R) leaks



NO TOOLS REQUIRED

Flex Inject installs in seconds - no tools or gauges required. The Flex Inject sealant goes to work immediately traveling through the system with both the oil and refrigerant stopping leaks dead in their tracks.



COMPATIBLE WITH ALL OILS & REFRIGERANTS

Works with all compressors, heat pumps, condensers, recovery units, and other system components. Will not plug up manifold gauges, TXVs, pistons or cap tubes. Compatible with all oils and refrigerants including R-410A requiring no pump down or recovery.



POLYMER FREE

The polymer free formula has unique metal bonding properties that create a permanent protective barrier to keep the refrigerant from escaping and is microchannel friendly.

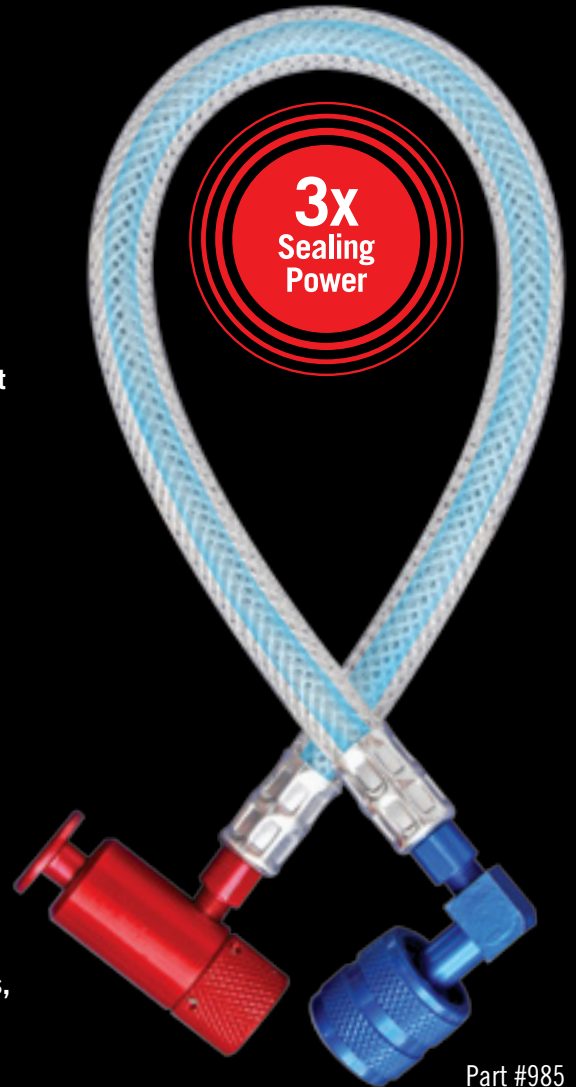

Part #985
Patent Pending

ALL SYSTEMS | UP TO 20KW

UP TO **6 TONS**

www.diversitech.com/flexinject
800.995.2222



Super Seal Flex Inject®



**No manifold gauge
or hoses needed
Just Connect HI & LOW -
PUSH TO GO!**

QUICK & EASY INSTALLATION: INSTALL INTO FULLY-CHARGED SYSTEM

1. Ensure system is running.
2. Connect the red push button valve to the high side service port.*
3. Connect the blue low loss fitting to the low side service port.
4. Remove puck and press red button for 3 to 5 seconds to inject sealant.
5. Once sealant is dispensed, disconnect red push button valve from system.
6. Remove blue low loss fitting from system.

NO SYSTEM RUN TIME REQUIRED AFTER INJECTION

*IF NO HIGHSIDE PORT IS AVAILABLE - ATTACH RED PUSH BUTTON VALVE TO A REFRIGERANT CYLINDER & FOLLOW STEPS 3-6.

FREE MERCHANDISER AVAILABLE*



ITEM# MKT-MERCH-FLEX

WHY SUPER SEAL FLEX INJECT IS THE OBVIOUS CHOICE

Feature	DiversiTech Super Seal Flex Inject	Nu-Calgon EasySeal Direct Inject
Sealant Power	Triple	Single
Hose	Flexible	Rigid
Equipment Required	None	Manifold Gauge and Hoses
Sealant-Refrigerant Integration	No Run Time Required	60 Minutes with System Running
Valve Protection	Push Button Valve Allows for a Controlled Refrigerant Flow with Automatic Shut Off	One Way Check Valve
Compressor Protection	Misting Orifice Prevents Liquid Slugging	None

REFRIGERANT LEAK SEALANT SOLUTION PART NUMBER CONVERSION TABLE

DiversiTech		Nu-Calgon	
PRODUCT	PART #	PRODUCT	PART #
Super Seal Flex Inject with Integrated Hose - Up to 6 tons	985	EasySeal-SS Direct Inject – Fractional to 1.5 tons	4050-05
		EasySeal Direct Inject – 6 pc. BULK – 1.5 to 5 tons	4050-07
		EasySeal Direct Inject – 1.5 to 5 tons	4050-08

*REQUIRES TWO SIX PACK ORDERS AT TIME OF PURCHASE; LIMITED TO 200

Pro-Flush® HVAC Flushing Solvent

Pro-Flush® answers your need for a professional quality flushing solvent with the components to match.

- Formulated for R-410A retrofits, refrigerant conversions and compressor burnouts
- Lower cost solution than competitive pre-charged kits
- Solvents are non-VOC, conform to EPA SNAP standards, and are non-HAZMAT
- Low toxicity and residue free
- Flash Point: No flash point to boiling (41°C/106°F) - TAG Closed Cup (per ASTM D-56)
- Kit includes reusable tank with a pressure relief valve for added safety, a hose, and an injector trigger nozzle
- Better delivery system



FREQUENTLY ASKED QUESTIONS

Q: What refrigerants is Pro-Flush® compatible with?

A: Pro-Flush® is compatible with CFC and HFC refrigerants and compressor oils.

Q: Is Pro-Flush® safe to use?

A: Pro-Flush® is safe, nontoxic, and residue free. In addition, Pro-Flush® conforms to EPA's Significant New Alternatives Program (SNAP) standards.

Q: Is Pro-Flush® HAZMAT?

A: Pro-Flush® is not HAZMAT for storage or ground transportation.

Q: What is the advantage of the reusable injector tank?

A:

1. The reusable tank lowers cost since you only need to buy the Pro-Flush® refill cans.
2. Pre-charged cans include refrigerant propellants which are more expensive to use than nitrogen.
3. The trigger assembly allows for infinite control of dosage insuring more economical use of the solvent.
4. Using nitrogen as the propellant is less expensive and more environmentally friendly than using HFC-134A. HFC-134A is a powerful greenhouse gas. One kilogram of HFC-134A has the same global warming impact as 1,430 kilograms of carbon dioxide (<http://www.epa.gov/cpd/mac/service>).

Q: Can the injector tank be over pressurized during nitrogen pressurization?

A: Over pressurization is highly unlikely but possible. The injector valve has a reseating pressure relief safety valve set at 200 psi. This helps prevent potential bursting and resultant injury.

Q: What if I don't require the entire can of Pro-Flush® Solvent to clean a system or line set?

A: The injection nozzle allows you to control the dose rate and any left over solvent can be stored in the injector for future use.

Q: How does the dose rate for Pro-Flush® for burnouts and retrofits compare with the competitors?

A: For R22 to 410A conversions, we recommend 3-second bursts of solvent. An 8 oz. can of Pro-Flush™ will treat up to 250 feet of liquid line. For burnouts, we recommend 2-3 oz. per ton. Pro-Flush™ uses less solvent per application than Nu-Calgon. Treatment results will vary depending on the application and conditions of the line set when serviced.

Q: Why do you recommend only charging the injector tank to 50psi, then injecting in 3 second bursts?

A: Tests are conclusive that injecting the solvent at lower pressure assures longer solvent to oil contact time. In addition, the smaller volume delivered in short bursts assists in completely dissolving contaminants. In this case, less is better.

Q: Is nitrogen necessary for use with Pro-Flush®?

A: Nitrogen is used as the propellant for Pro-Flush®. Nitrogen is required with all flushing systems to purge any residual solvent and contaminants through the system.

Q: Do pre-charged canister systems dispense 100% of the flushing solvent?

A: In many cases pre-charged canister systems will not fully dispense the flushing solvent depending on temperature. At lower temperatures, the R-134a propellant provides less pressure and may leave solvent in the canister. The Pro-Flush® system allows contractors to add additional nitrogen if there is still solvent left, regardless of temperature.



SEAL-N-GO[®]

SELF-SEALING REFRIGERANT[™]

410A + SUPER SEAL **ADVANCED**[™]



9410SSR*

HOW DOES SEAL-N-GO WORK?

SEAL-N-GO makes charging 410A systems faster & easier than ever. Portable, easy to handle, self-sealing refrigerant, permanently seals & prevent leaks.

ADDED BENEFITS

- Light-weight, compact, portable
- Tops off multiple systems
- Perfect for mini-split installs
- Permanently seals & prevent leaks
- Eliminates moisture

FAST - EASY - 1 STEP
push button application



Reusable charging hose with easy-to-read gauge sold seperately. **20133***



Self-Sealing Refrigerant



Eliminates Moisture



Time Saver



Equipment Safe

SUPER CHANGE™

FAST & EASY R22 SYSTEM RETROFIT

- Eliminates oil change out
- Replaces R22 line set conversion flush
- Ideal for dry charged units, retrofits, & drop-in refrigerants
- Maximizes oil return & heat transfer, including POE charged compressors

HOW DOES SUPER CHANGE™ WORK?

SUPER CHANGE™ creates a strong compatibility link between all oils to any HFC refrigerants, including POE-based R407C & R410A – eliminating compressor downtime & line set flush. It boosts efficiency plus extends compressor life by maximizing heat transfer & oil return with drop-in refrigerants.



Compatible



Eliminates Moisture



Equipment Safe



Boosts Efficiency

ADDED BENEFITS

- Reduces oil logging – critical in systems with long line set runs & rises
- Introduces antioxidants to reduce corrosion & restore lubricants
- Rejuvenates O-rings & gaskets – no change out required
- Required hose sold separately



20122
REUSABLE HOSE SOLD SEPARATELY



SOLD AS
6 PACK
COUNTER
DISPLAY



981*
ALL SYSTEMS UP TO 6 TONS

APPLICATION GUIDE

SYSTEM TONNAGE	Up to 3 Tons	3.5 - 6 Tons	6+ Tons
SYSTEM OIL CHARGE	Up to 32 oz	Up to 64 oz	128+ oz
Conversion not requiring oil change out	1 can	1 can	2 cans/gallon
Conversion requiring oil change out	1 can	2 cans	4 cans/gallon
Conversion to R410A	1 can	1 can	2 cans/gallon
R22 line set conversion flush	1 can	1 can	2 cans/gallon
For oil logging or long line set runs and rises	1 can	1 can	2 cans/gallon

It will take approximately 24 hours of operation for the full effect to be achieved.

Condensate Pan Treatments – SIMPLIFIED

THE NEED

Environmental debris, slime, rust, etc. accumulate in condensate drain pans resulting in:

- Indoor Air Quality problems including musty odors and Dirty Sock Syndrome
- Pan overflows caused by plugged drain lines
- Equipment malfunction

THE SOLUTION

Use pan treatment products as part of a regular preventive maintenance program to:

- Eliminate one of the causes of Sick Building Syndrome
- Stop costly overflow problems that damage floors, ceilings, and furniture
- Reduce unscheduled service calls

THE PRODUCTS

EXTENDED RELEASE TREATMENTS

- Several manufacturers produce various time release products
- Highest value — most active ingredient per dollar
- Easiest maintenance program — dose only once every three months or longer
- Only effective solution for equipment larger than six tons

RAPID RELEASE TREATMENTS

- Lowest cost per tablet
- Shortest time between dosing



Super



Best



Good



Economy

Flow-Plus™ Condensate Pan Treatment

- A true water activated, time release treatment
- Water soluble polymer leaves no residue or carrier to be removed
- Adheres to drain pans — eliminates product floating and blocking the drain line
- No corrosive vapors — safe for computer rooms
- Recommended dosage — choose size according to equipment tonnage. Each size is designed to last a minimum of three months.

FLOW-PLUS-25	— 1/2 to 3 tons
FLOW-PLUS-200	— 1/2 to 3 tons
FLOW-PLUS-6	— 3 to 5 tons
FLOW-PLUS-10	— 5 to 20 tons
FLOW-PLUS-125	— 20 to 50 tons

STACKABLE!
This unique feature increases the time between maintenance visits.

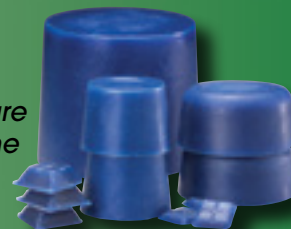

Pro-Treat® 151 Premium Condensate Drain Pan Treatment

- EPA Registered
- Kills algae and eliminates odors
- Fast acting
- Residual effect of the clean pan lasts for a month
- No corrosive vapors — safe for computer rooms
- Recommended dosage: 1 tablet for every 3 tons each month

Pro-Treat® 161 Condensate Drain Pan Treatment

- More active ingredient than the economy version
- Fast acting
- Residual effect of the clean pan lasts for about a month
- No corrosive vapors — safe for computer rooms
- Recommended dosage: 2 tablets for every 3 tons each month

Pro-Treat® 200 Condensate Drain Pan Treatment

- Lowest cost product per tablet
- Sufficient active ingredient to treat the pan
- No corrosive vapors — safe for computer rooms
- Recommended dosage: 3 tablets for every 3 tons each month

3-STEP PROCESS for Solving IAQ Problems

1



STEP 2: DISINFECT

SANI C-N-D™ Coil and Drain Pan Disinfectant

Disinfect and deodorize the evaporator coil and drain pan with SANI C-N-D™, an EPA registered biocide, fungicide, viricide, and mildewstat. The broad spectrum biocide in SANI C-N-D™ assures control of many airborne pathogens that can be spread via contaminated air handling equipment.

STEP 1: CLEAN

TRIPLE-D® Degreaser • Detergent • Deodorant

Clean the evaporator coil and condensate pan with TRIPLE-D, a USDA authorized non-foaming alkaline coil cleaner. Cleaning the dirt from the coil and pan not only improves equipment efficiency, but also removes an important source of contamination that can create slime and sludge in the drain pan and cause pan overflow.



2

The American Lung Association states that most people spend 90% of their time indoors¹. DiversiTech offers the 3-STEP PROCESS to help control IAQ problems caused by the micro-organisms in the atmosphere in which we live and work.

¹www.lungusa.org

STEP 3: MAINTAIN

FLOW-PLUS™ Condensate Pan Treatment

Place FLOW-PLUS™ in the condensate pan (choose size according to equipment tonnage below). FLOW-PLUS™ is a totally soluble long term polymer treatment that keeps the drain pan and condensate lines clean for a minimum of three months. This prevents pan overflow problems.

PRODUCT NO.	EQUIPMENT TONNAGE
FLOW-PLUS-25	1/2 to 3 tons
FLOW-PLUS-200	1/2 to 3 tons
FLOW-PLUS-6	3 to 5 tons
FLOW-PLUS-10	5 to 20 tons
FLOW-PLUS-125	20 to 50 tons

3



Why clean coils?

CONDENSER COIL

Cleaning the condenser coil does one thing — improves the heat transfer efficiency between the refrigerant inside the coil and the ambient air outside. The more efficient this heat transfer, the more efficiently the cooling system operates.

With efficient heat transfer and an efficiently operating condensing unit, the system consumes less energy because it draws less current. By lowering current consumed in the unit, the life of the equipment is extended.

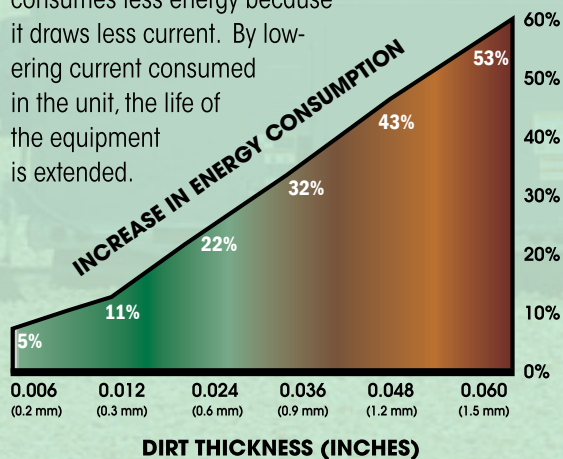

EVAPORATOR COIL

Cleaning the evaporator coil improves indoor air quality. It addresses building related illness and sick building syndrome.

How frequently should coils be cleaned?

We recommend a minimum of twice per year, more frequently if there is dirty ambient air.



Maintenance Chemical Solution Quick Reference Guide

EQUIPMENT TYPE	PRODUCT TYPE			
	TRIPLE-D	ECO-COIL	PRO-BROWN	PRO-BLUE
Condenser Units	X	X	X	X
(No-Rinse)		X		
Evaporator Units	X	X		
(No-Rinse)	X	X		
Rubber Roof Tops	X			
Fan Blades, Grilles, Etc.	X	X		
Electronic Air Filters	X	X		
Permanent Filters	X	X		
Microchannel Coils	X	X		
Small Condenser Coils	X	X	X	X
Small Evaporator Coils	X	X		
Mini-Splits	X	X		
APPLICATION SOLUTION				
Brightener			X	X
Condensate "Gunk"	X	X	X	X
Degreasing	X	X	X	X
Deodorizer	X	X		
Dirt and Grime	X	X	X	X
Disinfectant	USE SANI C-N-D COIL AND DRAIN DISINFECTANT			
Hersite Coated Coils		X		
Oxide Deposits			X	X
Remove Minerals				
CHEMICAL TYPE				
Alkaline	X	X	X	X
Acidic				
DILUTION (PRODUCT: H2O)				
Condensers	1:6	1:3	1:3	1:3
Evaporators	1:10	1:6		
Evaporators (No-Rinse)	1:20	1:6		
PACKAGING AVAILABLE				
19 Ounce Aerosol	TRIPLE-D-AER	ECO-COIL-AER	PRO-BROWN-AER	PRO-BLUE-AER
1 Quart Trigger Sprayer	TRIPLE-D-RTU			
32 Oz. Bottle	TRIPLE-D-32	ECO-COIL-32	PRO-BROWN-32	PRO-BLUE-32
1 Gallon	TRIPLE-D	ECO-COIL	PRO-BROWN	PRO-BLUE
5 Gallon	TRIPLE-D-5	ECO-COIL-5	PRO-BROWN-5	PRO-BLUE-5
55 Gallon Drum	TRIPLE-D-55	ECO-COIL-55	PRO-BROWN-55	PRO-BLUE-55
1 LB Granular	TRIPLE-D-GRAN			
ENVIRONMENTAL				
Biodegradable	X	X	X	X
Meets EPA's Design for the Environment Alternative Program as Green		X		
FOOD COMPLIANCE				
USDA Approved	X	X		X
NSF Registered	X	X		X

EQUIPMENT TYPE	PRODUCT TYPE			
	PRO-GREEN	PRO-RED+	PRO-YELLOW	PRO-KLEEN
Condenser Units	X	X	X	X
(No-Rinse)	X			
Evaporator Units	X			
(No-Rinse)	X			
Rubber Roof Tops				
Fan Blades, Grilles, Etc.	X			
Electronic Air Filters	X			
Permanent Filters	X			
Microchannel Coils	X			
Small Condenser Coils	X	X	X	X
Small Evaporator Coils	X			
Mini-Splits	X			
APPLICATION SOLUTION				
Brightener		X	X	X
Condensate "Gunk"	X	X	X	X
Degreasing		X	X	X
Deodorizer				
Dirt and Grime	X	X	X	X
Disinfectant	USE SANI C-N-D COIL AND DRAIN DISINFECTANT			
Heresite Coated Coils				
Oxide Deposits		X	X	X
Remove Minerals				X
CHEMICAL TYPE				
Alkaline	X	X	X	
Acidic				X
DILUTION (PRODUCT: H2O)				
Condensers	1:3	1:3	1:2	1:3
Evaporators	1:3			
Evaporators (No-Rinse)	1:3			
PACKAGING AVAILABLE				
19 Ounce Aerosol	PRO-GREEN-AER	PRO-RED+AER	PRO-YELLOW-AER	
1 Quart Trigger Sprayer				
32 Oz. Bottle	PRO-GREEN-32	PRO-RED+32	PRO-YELLOW-32	
1 Gallon	PRO-GREEN	PRO-RED+	PRO-YELLOW	PRO-KLEEN
5 Gallon	PRO-GREEN-5	PRO-RED+5	PRO-YELLOW-5	PRO-KLEEN-5
55 Gallon Drum	PRO-GREEN-55	PRO-RED+55	PRO-YELLOW-55	PRO-KLEEN-55
1 LB Granular				
ENVIRONMENTAL				
Biodegradable	X	X	X	X
Meets EPA's Design for the Environment Alternative Program as Green				
FOOD COMPLIANCE				
USDA Approved	X			
NSF Registered	X			

COIL CLEANERS

Triple-D® Universal Coil Cleaner

Triple-D® is the ultimate universal coil cleaner that can be used on condensers, evaporators, microchannels, roof-top units, and mini-split applications. The triple active synergistic highly effective solution is formulated to remove a broad range of soils while degreasing and deodorizing. It is ideal for cleaning most metals including aluminum and copper while extending equipment life and diminishing the potential for refrigerant leaks. Using 75% less than comparable products, it reduces the amount of solution needed to clean. Triple-D® is biodegradable, NSF approved and available in seven different packaging configurations.

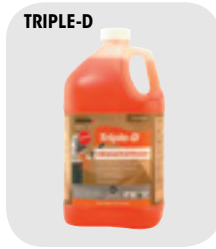

CATALOG NO.	DESCRIPTION	UOM	ORDER MULTIPLE
TRIPLE-D	Triple-D® – 1 gallon concentrate	EA	4
TRIPLE-D-5	Triple-D® – 5 gallon concentrate	EA	1
TRIPLE-D-AER	Triple-D® – 19 oz. Aerosol	EA	12
TRIPLE-D-AER-6	Triple-D® – 19 oz. Aerosol	EA	6
TRIPLE-D-GRAN	Triple-D® – 1 lb. Granular	EA	12
TRIPLE-D-32	Triple-D® – 32 oz. bottle – concentrate	EA	12
TRIPLE-D-RTU	Triple-D® – 1 quart trigger sprayer – pre-diluted	EA	12
TRIPLE-D-55	Triple-D® – 55 gallon drum	EA	1

Eco-Coil™ Environmentally Friendly Coil Cleaner

Eco-Coil™ is an environmentally friendly no rinse non-corrosive cleaner ideal for evaporator and condenser coils, electronic and permanent filters, fan blades, grilles, mini-split and microchannel applications. Eco-coil quickly cleans away dirt, dust, and deposits while deodorizing with no harmful risks to animal, aquatic or plant life. Tested to provide the highest level of performance, Eco-Coil not only reduces the number of products required to clean but also has different water mixture ratios to maximize solution usage. Furthermore, it brightens, biodegradable, NSF approved, and meets the EPA's Design for the Environment Alternative Program as a "green" product.



CATALOG NO.	DESCRIPTION	UOM	ORDER MULTIPLE
ECO-COIL-32	Eco-Coil™ Environmentally Friendly Coil Cleaner – 32 oz. bottle	EA	12
ECO-COIL	Eco-Coil™ Environmentally Friendly Coil Cleaner – 1 gallon container	EA	4
ECO-COIL-5	Eco-Coil™ Environmentally Friendly Coil Cleaner – 5 gallon pail	EA	1
ECO-COIL-55	Eco-Coil™ Environmentally Friendly Coil Cleaner – 55 gallon drum	EA	1
ECO-COIL-AER	Eco-Coil™ – 19 oz. Aerosol	EA	1

Pro-Brown™

Pro-Brown™ is a heavy duty alkaline cleaner that pulls out deeply embedded dirt removing greasy soils and oxidation while brightening and cleaning coils. Ideal for air-cooled condensers and mini-splits thanks to its dual action foaming capabilities. It is biodegradable and NSF approved.



CATALOG NO.	DESCRIPTION	UOM	ORDER MULTIPLE
PRO-BROWN-32	Pro-Brown™ Foaming Coil Cleaner – 32 oz. bottle	EA	12
PRO-BROWN	Pro-Brown™ Foaming Coil Cleaner – 1 gallon container	EA	4
PRO-BROWN-5	Pro-Brown™ Foaming Coil Cleaner – 5 gallon pail	EA	1
PRO-BROWN-55	Pro-Brown™ Foaming Coil Cleaner – 55 gallon drum	EA	1
PRO-BROWN-AER	Pro-Brown™ – 19 oz. Aerosol	EA	6

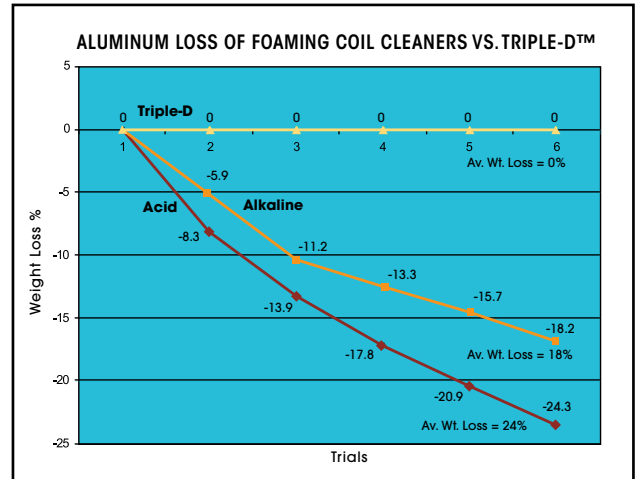

Conventional foaming acid and non-acid coil cleaners attack and chemically react with the aluminum coil components. This reaction is exhibited by a foaming action. The attack/reaction dissolves the aluminum, destroying the heat-transfer ability of the coil and creating the potential for refrigerant leaks.

Pro-Blue™

Pro-Blue™ is a heavy foaming alkaline-based solution designed for condensers and mini-splits that penetrates dirt and grease removing deposits resulting in clean and brightened coils. Pro-Blue is biodegradable, NSF approved, and available in numerous packaging configurations.



CATALOG NO.	DESCRIPTION	UOM	ORDER MULTIPLE
PRO-BLUE-32	Pro-Blue™ Foaming Concentrate (non-acid) – 32 oz. bottle	EA	12
PRO-BLUE	Pro-Blue™ Foaming Concentrate (non-acid) – 1 gallon container	EA	4
PRO-BLUE-5	Pro-Blue™ Foaming Concentrate (non-acid) – 5 gallon pail	EA	1
PRO-BLUE-55	Pro-Blue™ Foaming Concentrate (non-acid) – 55 gallon drum	EA	1
PRO-BLUE-AER	Pro-Blue™ – 19 oz. Aerosol	EA	6

Pro-Green™

Pro-Green™ is a no rinse, mild alkaline coil cleaner that can be used on air-cooled condensers, evaporators, electronic and permanent filters, fan blades, grilles, mini-split and microchannel applications. Pro-Green cleans deposits on coils and rids condensate pans of slime. It is NSF approved for use in federally inspected plants and available in numerous packaging configurations.



CATALOG NO.	DESCRIPTION	UOM	ORDER MULTIPLE
PRO-GREEN-32	Pro-Green™ No Rinse (non-toxic) – 32 oz. bottle	EA	12
PRO-GREEN	Pro-Green™ No Rinse (non-toxic) – 1 gallon container	EA	4
PRO-GREEN-5	Pro-Green™ No Rinse (non-toxic) – 5 gallon pail	EA	1
PRO-GREEN-55	Pro-Green™ No Rinse (non-toxic) – 55 gallon drum	EA	1
PRO-GREEN-AER	Pro-Green™ – 19 oz. Aerosol	EA	6

COIL CLEANERS cont'd

Pro-Red Plus™

Pro-Red Plus™ is a fast acting cleaning solution for condensers, microchannels, and mini-splits that foams and lifts away stubborn deposits including tarnish and corrosion. Its non-acid formula is as effective as conventional acid cleaners without the use of hydrofluoric acid. The vigorous foaming action eliminates the need for prolonged soaking, steam cleaning or scrubbing coils and without emitting corrosive fumes or rusting ferrous metals. Pro-Red Plus™ is biodegradable, NSF approved, and available in a number of convenient packaging solutions.



CATALOG NO.	DESCRIPTION	UOM	ORDER MULTIPLE
PRO-RED+32	Pro-Red Plus™ Cleaner and Brightener (non-acid) – 32 oz. bottle	EA	12
PRO-RED+	Pro-Red Plus™ Cleaner and Brightener (non-acid) – 1 gallon container	EA	4
PRO-RED+5	Pro-Red Plus™ Cleaner and Brightener (non-acid) – 5 gallon pail	EA	1
PRO-RED+55	Pro-Red Plus™ Cleaner and Brightener (non-acid) – 55 gallon drum	EA	1
PRO-RED+AER	Pro-Red Plus™ – 19 oz. Aerosol	EA	6

Pro-Yellow™

Pro-Yellow™ is a powerful cleaner ideal for condensers, microchannels, and mini-splits that targets large concentrations of dirt and grime. With its heavy foaming alkaline-based solution, debris will be removed from the coil while providing excellent brightening. Pro-Yellow is biodegradable, NSF approved and available in a number of packaging solutions.



CATALOG NO.	DESCRIPTION	UOM	ORDER MULTIPLE
PRO-YELLOW-32	Pro-Yellow™ (non-toxic) – 32 oz. bottle	EA	12
PRO-YELLOW	Pro-Yellow™ (non-toxic) – 1 gallon container	EA	4
PRO-YELLOW-5	Pro-Yellow™ (non-toxic) – 5 gallon pail	EA	1
PRO-YELLOW-55	Pro-Yellow™ (non-toxic) – 55 gallon drum	EA	1
PRO-YELLOW-AER	Pro-Yellow™ – 19 oz. Aerosol	EA	6

Pro-Kleen™

A unique foaming acid coil cleaner designed to replace hazardous hydrofluoric acid coil cleaners. It contains a synergistic combination of mineral acids, corrosion inhibitors, biodegradable surfactants, penetrants, and degreasers that emulsify, solubilize and neutralize soils leaving a clean, bright, efficient coil surface.



CATALOG NO.	DESCRIPTION	UOM	ORDER MULTIPLE
PRO-KLEEN	Pro-Kleen™ Outdoor Coil Cleaner – 1 gallon container	EA	4
PRO-KLEEN-5	Pro-Kleen™ Outdoor Coil Cleaner – 5 gallon pail	EA	1
PRO-KLEEN-55	Pro-Kleen™ Outdoor Coil Cleaner – 55 gallon drum	EA	1

ACCESSORIES

Coil Guard™

Ideally used in coastal areas, where salt air accelerates rust and decay. Highly recommended for use in all geographical areas to prolong the life of a unit. When applied properly, Coil Guard™ dries quickly and immediately resists salt spray, alcohol, acids, and soap solutions. Weather will not blacken it. Coil Guard™ has high dielectric properties and has no effect on heat transfer. Our blue tinted product is used to ensure complete coverage of coating.



CATALOG NO.	DESCRIPTION	UOM	ORDER MULTIPLE
CG-AER	Clear Coil Guard™ – 20 oz. Aerosol	EA	12
CGB-AER	Blue Coil Guard™ – 20 oz. Aerosol	EA	12

Cool-Weld™ Heat Barrier Spray

Spray on thick gel formula that protects surfaces from heat and damage. Odorless, non-toxic gel coats rubber, plastic, and painted surfaces to shield them during welding or soldering.



CATALOG NO.	DESCRIPTION	UOM	ORDER MULTIPLE
COOLWELD-32	Cool-Weld™ Heat Barrier Spray – 32 oz. Container	EA	12

Pan-Patch™

Pan-Patch™ is a two part epoxy coating with anti-microbial additives designed for HVAC applications. It is a self leveling formula that is ideal in a damp or wet environment. Pan-Patch™ resists corrosion and stops pan leaks without replacing the pan. Light gray in color, one gallon covers about 160 square feet with 10 mil thickness.



CATALOG NO.	DESCRIPTION	COVERAGE	UOM	ORDER MULTIPLE
PANPATCH-BAG	Pan-Patch™ Pan Sealant – Bag, pack of 10	8 sq. ft.	EA	10
PANPATCH	Pan-Patch™ Pan Sealant – 1 Gallon	160 sq. ft.	EA	4

COIL CLEANING AEROSOLS

Saf-N-Kleen™ Aerosol Solvent Coil Cleaner

High-solvency formula quickly and easily dissolves dirt, grease, oil or other residue while the blasting nozzle separates the materials from the surface. Non-flammable, non-conductive formula is safe to use on live equipment. Not for use in California.

357-20



CATALOG NO.	DESCRIPTION	UOM	ORDER MULTIPLE
357-20	Saf-N-Kleen™ Solvent Coil Cleaner – 18 oz. Aerosol	EA	12

Foam-Plus™ Aerosol Foaming Coil Cleaner

Heavy-duty foaming detergent coil cleaner in an aerosol can. Non-flammable and water-based with no chlorinated solvents. Blasting foam stream reaches into tight areas for maximum cleaning. The foaming alkaline detergent quickly liquifies dirt, grease, oil or other residue and is completely self-rinsing on condensate producing coils.

358-20



CATALOG NO.	DESCRIPTION	UOM	ORDER MULTIPLE
358-20	Foam-Plus™ Foaming Coil Cleaner – 19 oz.	EA	12
358-20S	Foam-Plus™ - Spanish Label - 19 oz.	EA	12

DRAIN PAN DISINFECTANT

Sani C-N-D™ Coil and Drain Pan Disinfectant

Sani C-N-D™ is an EPA registered disinfectant, fungicide, mildewstat and viricide. It is ready-to-use and assures consistent, effective results. Sani C-N-D™ destroys "dirty sock," mildew and other malodors.

SANI-CND



CATALOG NO.	DESCRIPTION	UOM	ORDER MULTIPLE
SANI-CND-32	Sani C-N-D™ Disinfectant – 32 oz. Container	EA	12
SANI-CND	Sani C-N-D™ Disinfectant – 1 Gal. Container	EA	4
SANI-CND-5	Sani C-N-D™ Disinfectant – 5 Gallon Pail	EA	1
SANI-CND-55	Sani C-N-D™ Disinfectant – 55 Gallon Drum	EA	1

Pan-Kote Heavy Duty Drain Pan Patch

A super-durable rubberized coating used to fill-in and patch HVAC drain pans. Seals out rust and corrosion. Stays flexible in variable weather conditions.

641-14



CATALOG NO.	DESCRIPTION	UOM	ORDER MULTIPLE
641-14	Pan-Kote Drain Pan Patch – 14 oz. Aerosol	EA	12

GLYCOLS

DiversiTech produces the most complete line of industrial coolant and heat transfer products in the HVAC/R Industry. Our product line includes ProTek PG propylene glycol products formulated with food-grade corrosion inhibitors and ProTek EG ethylene glycol products for industrial applications. Both product groups are designed to provide freeze and burst protection and are formulated with inhibitors and antifoam agents to provide long-term stability against system corrosion and fouling.

ProTek EG™

An inhibited ethylene glycol based heat transfer fluid designed for use in hydronic, chilled and closed water.

CATALOG NO.	DESCRIPTION	GLYCOL/WATER RATIO	UOM	ORDER MULTIPLE
EG	ProTek EG™ – 1 Gallon Jug	95/5	EA	4
EG-5	ProTek EG™ – 5 Gallon Pail	95/5	EA	1
EG-55	ProTek EG™ – 55 Gallon Drum	95/5	EA	1



ProTek™ Closed Loop Heat Transfer Fluid

ProTek™ for closed loop water recirculation systems is a blue liquid. Available in three concentrations: original ProTek-100™, ProTek-50™, and ProTek-Plus™. Each concentration may be further diluted to alter freeze and burst temperatures. Refer to the technical data sheet for specific information.

PG-50



CATALOG NO.	DESCRIPTION	GLYCOL/WATER RATIO	UOM	ORDER MULTIPLE
PG-50	ProTek-50™ – 1 Gallon Jug	35/65	EA	4
PG-50-5	ProTek-50™ – 5 Gallon Pail	35/65	EA	1
PG-50-55	ProTek-50™ – 55 Gallon Drum	35/65	EA	1

ProTek™ PG 100

ProTek 100™ is an inhibited propylene glycol based industrial heat transfer fluid and antifreeze that contains food grade corrosion inhibitors. It is suitable for use in potable water systems. ProTek 100™ is designed to provide freeze and burst protection, excellent thermal conductance, protection against corrosion and fouling and long term stability in closed recirculating water loops. ProTek 100™ provides burst protection to 100°F. Freeze points and burst points are controlled by the propylene glycol to water ratio.

PG-100



CATALOG NO.	DESCRIPTION	GLYCOL/WATER RATIO	UOM	ORDER MULTIPLE
PG-100	ProTek-100™ – 1 Gallon Jug	70/30	EA	4
PG-100-5	ProTek-100™ – 5 Gallon Pail	70/30	EA	1
PG-100-55	ProTek-100™ – 55 Gallon Drum	70/30	EA	1

ProTek™ PG Plus

ProTek PLUS™ is an inhibited propylene glycol based industrial heat transfer fluid and anti freeze that contains food grade corrosion inhibitors. It is suitable for use in potable water systems. ProTek PLUS™ is designed to provide freeze and burst protection, excellent thermal conductance, protection against corrosion and fouling and long term stability in closed recirculating water loops. ProTek PLUS™ must be mixed with water to provide freeze and burst protection. Freeze points and burst points are controlled by the propylene glycol to water ratio.



CATALOG NO.	DESCRIPTION	GLYCOL/ WATER RATIO	UOM	ORDER MULTIPLE
PG-PLUS	ProTek-Plus™ – 1 Gallon Jug	95/5	EA	4
PG-PLUS-5	ProTek-Plus™ – 5 Gallon Pail	95/5	EA	1
PG-PLUS-55	ProTek-Plus™ – 55 Gallon Drum	95/5	EA	1

ProTek BG™ for Cast Iron Water Boilers

A red liquid boiler grade product formulated specifically with corrosion inhibitors necessary for use in water boilers.



CATALOG NO.	DESCRIPTION	GLYCOL/ WATER RATIO	UOM	ORDER MULTIPLE
PG-BG	ProTek-BG™ – 1 Gallon Jug	70/30	EA	4
PG-BG-5	ProTek-BG™ – 5 Gallon Pail	70/30	EA	1
PG-BG-55	ProTek-BG™ – 55 Gallon Drum	70/30	EA	1

FLUSHING PRODUCTS

Pro-Flush® HVAC Flushing Solvent

A flushing solvent for A/C and refrigeration systems formulated for R410A retrofits, refrigerant conversions and compressor burnouts. Compatible with all refrigerants and compressor oils. All solvents in Pro-Flush® are non VOC and conform to EPA SNAP standards: low toxicity and residue free. Available as a kit or in an 8 or 16 oz. solvent refill. The kit makes servicing quick, easy, and safe, as well as assuring you get to the job site with all necessary hardware in hand for 1 stop servicing. The kit includes: 8 oz. container of Pro-Flush® solvent, refillable Pro-Flush® injector tool pressure tank, pressure relief valve for added safety, large rubber adapter that flushes up to 1-1/4" line sets, service hose.



CATALOG NO.	DESCRIPTION	UOM	ORDER MULTIPLE
PF-KIT	Pro-Flush® Kit – injector, 8 oz. refill, nozzle adapter and hose	EA	3
PF-08	Pro-Flush® HVAC Flushing Solvent – 8 oz. Refill	EA	6
PF-16	Pro-Flush® HVAC Flushing Solvent – 16 oz. Refill	EA	6
PF-ADAPTER	Pro-Flush® Line Set Adapter	EA	1
PF-IGUN	Replacement Injector Tool	EA	1
PF-IHOSE	2' Replacement Hose	EA	1

Super Change™

Super Change eliminates oil change outs replacing R22 line set conversion flushes. Ideal for dry charged units, retrofits, and drop-in refrigerants, Super Change maximizes oil return and heat transfer including POE charged compressors. Reusable hose (20122) sold separately.



CATALOG NO.	DESCRIPTION	UOM	ORDER MULTIPLE
981	Super Change™ - Up to 6 Tons	EA	6
20122	Reusable Charging Hose for Super Change™	EA	1

HOSES, SPRAYERS

Power Sprayer

DiversiTech's Power Sprayer makes coil cleaning easier and faster! Designed as a backpack sprayer, it holds up to 4 gallons of coil cleaning solution. The battery powered unit will spray continuously for 10 hours on a single charge. Included are three different nozzles to give you the right spray for any situation. It also features: padded backpack straps for a comfortable fit, plug-in charger for fast recharging, a convenient center mount handle, an extra long spray wand with curved tip for accurate application, and a large on/off valve which can lock in position for easier spraying of big jobs. The large tank opening also makes it easy to add coil cleaner and mix to the correct ratio. The Power Sprayer is compatible with all DiversiTech coil cleaners.



CATALOG NO.	DESCRIPTION	UOM	ORDER MULTIPLE
PS-1	Battery powered/rechargeable backpack sprayer for coil cleaning	EA	1

Dial-a-Mix Sprayer

Save time and money by dialing in the exact mix ratio to properly clean the coil. This sprayer features 5 mix ratios, a 1/2 gallon capacity bottle and a quick disconnect for fast and easy rinsing.



CATALOG NO.	DESCRIPTION	UOM	ORDER MULTIPLE
540-GUN	Dial-a-Mix Sprayer	EA	6

Garden Hose

High quality product priced for high volume sales. Soft-Flex formulation makes the 5 ply Hose easy to handle. Withstands 500 psi water pressure. Heavy duty solid brass couplings and collar. Full Lifetime Guarantee!

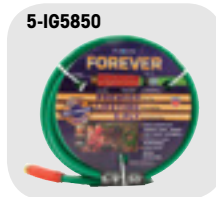

CATALOG NO.	DESCRIPTION	UOM	ORDER MULTIPLE
5-IG5850	Green Flexon 5-Ply Forever Garden Hose	EA	5

All Purpose Sprayers

Lightweight, versatile gallon size bottle has a 28" flexible hose and easy-to-carry handle. Best for big jobs in hard-to-reach places. Adjustable nozzle will atomize any low viscosity liquid. Adjusts from a mist to a 12" jet stream or anything in between. One pint container has a measured ounce guide. Ideal for water treatment chemicals.



CATALOG NO.	DESCRIPTION	UOM	ORDER MULTIPLE
BS-16	Pint Size Sprayer	EA	12
BS-32	Quart Size Sprayer	EA	12

Compression Sprayers

Acid impervious poly design with a 36" (91cm) reinforced hose, shut-off with lock-on feature for continuous spraying, a 2-piece nozzle that's detachable for easy clean up and fits directly to the shut-off or extension wand. The Hand-Held Sprayer has a 48 oz. (1.4 l) capacity, perfect for small areas. All sprayers have a full 5 year warranty.



CATALOG NO.	DESCRIPTION	UOM	ORDER MULTIPLE
1002	Hand Held Sprayer	EA	1
2601	1 Gallon Wand Sprayer	EA	1
2602	2 Gallon Wand Sprayer	EA	1
2603	3 Gallon Wand Sprayer	EA	1

Hot Water Hose

High burst strength. 500 PSI. Withstands hot water up to 160°F. EPDM tube. Heavy duty solid brass couplings.



CATALOG NO.	DESCRIPTION	UOM	ORDER MULTIPLE
5-HW5850	5/8" x 50' Hot Water Hose	EA	5

Pistol Grips & Water Nozzle

Pistol Grip – 540-572 Insulated:
For spraying hot or cold water. Heavy-duty, self adjusting "duck" packing for lifetime proof seal.
Water Nozzle – 540-573 Un-insulated:
Heavy-duty and holds open clip for continuous spraying. Self-adjusting "duck" for leak proof seal.



CATALOG NO.	DESCRIPTION	UOM	ORDER MULTIPLE
540-572	Insulated Pistol Grip	EA	12
540-573	Uninsulated Water Nozzle	EA	12

ICE MACHINE PRODUCTS

Super-Kool™ Nickel-Safe and Metal-Safe Ice Machine Cleaner

An economical, fast-acting, non-foaming acid sequestrant formula that quickly removes soil and mineral buildup. This safe, highly-concentrated, inhibited formula will not attack nickel or other metal components. USDA AUTHORIZED



CATALOG NO.	DESCRIPTION	UOM	ORDER MULTIPLE
SUPER-KOOL-16	Super-Kool™ Ice Machine Cleaner – 16 oz. Bottle	EA	12
SUPER-KOOL	Super-Kool™ Ice Machine Cleaner – 1 Gallon Container	EA	4

LEAK DETECTORS AND ACCESSORIES

Bubble-N-Trouble™ Freeze Protected Spray-On Leak Detector

Non-corrosive, non-toxic, and biodegradable. Does not attack metal or interfere with brazing or soldering. Spray-on application allows easy access for hard to reach places. Tacking agent holds solution on test surface making Bubble-N-Trouble™ very economical. USDA AUTHORIZED



CATALOG NO.	DESCRIPTION	UOM	ORDER MULTIPLE
BNT-32	Bubble-N-Trouble™ Freeze Protected Leak Detector – 32 oz. Spray	EA	12
BNT-1	Bubble-N-Trouble™ Freeze Protected Leak Detector – 1 Gallon Container	EA	4

Pro-Bubble™ Leak Detector

Easy-to-use, high-bubbling, viscoelastic blue leak detector. New improved formula.



CATALOG NO.	DESCRIPTION	UOM	ORDER MULTIPLE
PRO-BUBBLE-32	Pro-Bubble™ Leak Detector – 32 oz. Bottle with Spray Top	EA	12

Radiant Leak Finder™

Radiant color and viscous clinging formula exposes the smallest leaks. Freeze-protected – remains effective down to 0° F.



CATALOG NO.	DESCRIPTION	UOM	ORDER MULTIPLE
RLF-8	Radiant Leak Finder™ – 8 oz. Container	EA	12

Flash™ UV Dye

Flash is an advanced class of highly concentrated dyes that uses DRY R™ instead of POE oil as its carrier. Flash will not react with moisture and travels with the speed of the refrigerant once installed finding leaks within minutes. Using a patented misting orifice (20122 reusable hose sold separately), Flash™ uses the refrigerant as the propellant ensuring a no-mess injection every time.



CATALOG NO.	DESCRIPTION	UOM	ORDER MULTIPLE
980	Flash Universal UV Dye - Up to 5 Tons	EA	12
20122	Reusable Hose, Clear	EA	1

Flash™ UV Leak Detection Kit

Flash™ UV leak detection kit include 3 cans of Flash dye, a reusable clear hose, heavy-duty storage case, and choice of UV light.



CATALOG NO.	DESCRIPTION	UOM	ORDER MULTIPLE
98084KIT	Flash™ with 3 cans, hose, and SEEKERmini™ Worklight	EA	1
98087KIT	Flash™ with 3 cans, hose, and SEEKERmini™ Worklight	EA	1

SEEKERmini™

High powered UV light with 3 AAA batteries included with no UV enhancing glasses required.



CATALOG NO.	DESCRIPTION	UOM	ORDER MULTIPLE
84DCPLUS	SEEKERmini™ UV LED Worklight	EA	1

LEAK DETECTORS AND ACCESSORIES cont'd

SEEKERmax™

High powered UV light with rechargeable 2200 mAh lithium-ion battery with no UV enhancing glasses required.



CATALOG NO.	DESCRIPTION	UOM	ORDER MULTIPLE
87DCPLUS	SEEKERmax™ UV LED Worklight	EA	1

UV Pocket Light

UV Pocket Light with 3 AAA batteries included.



CATALOG NO.	DESCRIPTION	UOM	ORDER MULTIPLE
89DC	UV Pocket Light	EA	12

LEAK SEALANTS

Super Seal Flex Inject®

Super Seal Flex Inject® is the fastest, most effective proven way to permanently seal and prevent minor air conditioning and refrigeration (AC/R) leaks. With no tools or gauges required, the Flex Inject® sealant works by travelling through the system with the oil and refrigerant fixing leaks immediately (up to 300 microns). Flex Inject® works with all compressors, heat pumps, condensers, and other system components and it will not plug up manifold gauges, metering devices, thermostatic expansion valves (TXVs), pistons or cause cap tube blockages. It meets the ASHRAE ARI 700 refrigerant standard and is compatible with any refrigerant including R-410A with no pump downs or recoveries required. Flex Inject® is suitable for use in aluminum and copper coils and is microchannel friendly.



CATALOG NO.	DESCRIPTION	UOM	ORDER MULTIPLE
985	Super Seal Flex Inject®	EA	6

Super Seal Total™

Super Seal Total includes a stop leak sealant, Dry R, and Flash with all the benefits of Super Seal Advanced plus UV dye. Hose included.

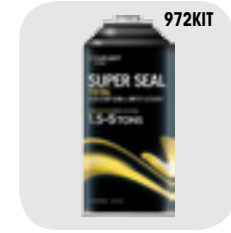

CATALOG NO.	DESCRIPTION	UOM	ORDER MULTIPLE
971KIT	Super Seal Total™ - Up to 1.5 Tons	EA	12
972KIT	Super Seal Total™ - 1.5 Tons to 5 Tons	EA	12

Super Seal Advanced™

Super Seal Advanced includes a stop leak sealant and Dry R. Provides for a fast install with no pump down or recovery even for R410A. Compatible with all oils and refrigerants. Hose included.

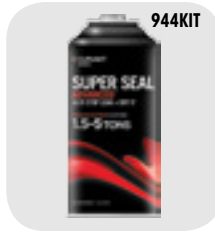

CATALOG NO.	DESCRIPTION	UOM	ORDER MULTIPLE
947KIT	Super Seal Advanced™ - Up to 1.5 Tons	EA	12
944KIT	Super Seal Advanced™ - 1.5 to 5 Tons	EA	12
948KIT	Super Seal Advanced™ - 5+ Tons	EA	12

Super Seal Sure Shot™

Sure Shot includes a stop leak sealant and Eco Boost. Hose and cartridge included.



CATALOG NO.	DESCRIPTION	UOM	ORDER MULTIPLE
983KIT	Super Seal Sure Shot™ - Up to 6 Tons	EA	12
984	Super Seal Sure Shot™ Replacement Cartridge - Up to 6 Tons	EA	12
940	Super Seal Sure Shot™, 1/4 in. SAE Reusable Hose	EA	1

Seal-N-Go® Self-Sealing Refrigerant

Seal-N-Go® is an excellent solution for taking R410A refrigerant on job sites and includes Super Seal Advanced™. It allows technicians to fill and stop and prevent leaks simultaneously. With a reusable charging hose (sold separately), the 25.7 ounce lightweight cannister is great for topping off multiple systems and perfect for mini-split installs. Reusable charging hose (20133) sold separately.



CATALOG NO.	DESCRIPTION	UOM	ORDER MULTIPLE
9410SSR	Seal-N-Go® 25.7 R410 Refrigerant plus Super Seal Advanced™	EA	6
20133	Reusable Charging Hose with Gauge	EA	1

ODOR NEUTRALIZERS

Duct-Fresh Gel

A non-toxic, super-effective odor neutralizer for HVAC ducts, proficient at destroying stubborn odors including pet, smoke, and musty smells in residential, industrial and commercial applications. Effective for up to 6 months.



DUCT-FRESH-8

CATALOG NO.	DESCRIPTION	UOM	ORDER MULTIPLE
DUCT-FRESH-8	Duct-Fresh Gel – 8 oz.	EA	12
DUCT-FRESH-16	Duct-Fresh Gel – 16 oz.	EA	8

The Purifier™

The Purifier is an electric device that removes stubborn odors like tobacco smoke. It eliminates mold, mildew and bacteria from HVAC systems. The Purifier completes most jobs in just 20 minutes. Includes programmable timer with LCD display.



170AIR

CATALOG NO.	DESCRIPTION	UOM	ORDER MULTIPLE
170AIR	The Purifier™ Fresh Air Ozone Machine	EA	1
170AIRFAN	Replacement Fan	EA	1
170AIRPCB	Replacement Circuit Board	EA	1
UVEC-07G	12V Charger for Cigarette Lighter	EA	1
410211	Replacement AC Adapter	EA	1
410212	Replacement UV Bulb	EA	1

Duct-Fresh Spray

A non-toxic, instantaneous, super-effective odor neutralizer for HVAC ducts. Destroys stubborn pet odors, smoke, and musty smells in residential, industrial and commercial applications. Great for spot-treating malodor problem areas.



DUCT-FRESH-32

CATALOG NO.	DESCRIPTION	UOM	ORDER MULTIPLE
DUCT-FRESH-32	Duct-Fresh Spray – 1 Quart	EA	12

Odor-Aid™

Disinfects and deodorizes with an easy pump spray. Eliminates bacteria, germs and microorganisms that cause offensive odors.



171AIR

CATALOG NO.	DESCRIPTION	UOM	ORDER MULTIPLE
171AIR	Odor-Aid™ – 7 oz. Bottle with Spray Top	EA	12

PAN TREATMENTS/DISINFECTANTS

Flow-Plus™ Condensate Pan Treatment

A unique polymer formula that maintains condensate flow and prevents drain pan overflow. 100% active. No residue—no waste—nonclogging. Effective, long-term condensate activated release. Environmentally safe, non-toxic, and non-corrosive. Also economical with sizes to meet all tonnage requirements.



FLOW-PLUS-200

CATALOG NO.	EQUIPMENT TONNAGE
FLOW-PLUS-25	1/2 to 3 tons
FLOW-PLUS-200	1/2 to 3 tons
FLOW-PLUS-6	3 to 5 tons
FLOW-PLUS-10	5 to 20 tons
FLOW-PLUS-125	20 to 50 tons

CATALOG NO.	DESCRIPTION	UOM	ORDER MULTIPLE
FLOW-PLUS-25	Flow-Plus™ Condensate Pan Treatment – 25 Tabs/Jar	EA	12
FLOW-PLUS-200	Flow-Plus™ Condensate Pan Treatment – 200 Tabs/Jar	EA	4
FLOW-PLUS-6	Flow-Plus™ Condensate Pan Treatment – 6 - 1 oz. Blocks	EA	12
FLOW-PLUS-10	Flow-Plus™ Condensate Pan Treatment – 10 oz. Tubs	EA	18
FLOW-PLUS-125	Flow-Plus™ Condensate Pan Treatment – 1.25 lb. Tubs	EA	8

Pro-Treat® 350 Condensate Drain Pan Treatment

Place a Pro-Treat® 350 tablet in a condensate drain pan and condensed moisture will slowly dissolve the tablet, thinly coating the pan surface to give prolonged cleaning action on sludge. Dosage: one or two tablets are recommended in each pan per month. For industrial use only!



PROTREAT-350

CATALOG NO.	DESCRIPTION	UOM	ORDER MULTIPLE
PROTREAT-350	Pro-Treat® 350 Condensate Pan Treatment – 100 Tablets per Jar	EA	24

Pro-Treat® Pan Strips

Pro-Treat® Pan Strips kill odor causing bacteria and last up to 6 months. Use in the primary drain pan of cooling units such as air conditioners and refrigerators. Pro-Treat® Pan Strips control foul-smelling odors caused by mildew, fungi, bacteria, algae, and slime. For use in hotels, schools, colleges, hospitals, nursing homes, airports, and many other locations.



PS-075

CATALOG NO.	DESCRIPTION	STRIPS/PACK	UOM	ORDER MULTIPLE
PS-075	Pro-Treat® Pan Strips – for up to 3/4 Ton	10	EA	12
PS-01	Pro-Treat® Pan Strips – for 1 to 2 Ton	10	EA	12
PS-03	Pro-Treat® Pan Strips – for 3 to 5 Ton	6	EA	24
PS-07	Pro-Treat® Pan Strips – for 7 to 12 Ton	2	EA	24
PS-20	Pro-Treat® Pan Strips – for 20 to 25 Ton	1	EA	24
PS-40	Pro-Treat® Pan Strips – for 40 to 50 Ton	1	EA	12

EPA Registration #6836-254-69966

PAN TREATMENTS/DISINFECTANTS cont'd

Pro-Treat® 151 Premium Condensate Drain Pan Treatment

Pro-Treat® 151 premium tablets penetrate and help remove sludge that can plug drain pans and drain lines and foul humidifier pans. Kills odors associated with slime and sludge, minimizing maintenance problems from overflow and water damage caused by fouled pans, plugged traps, or drain lines. Tablets are 100% soluble, easy-to-use, and do not form any deposits in the pan or drain line. Approved for computer rooms. Dosage: 1 tablet per 3 tons each month. PROTREAT-151 is EPA registered.



CATALOG NO.	DESCRIPTION	UOM	ORDER MULTIPLE
PROTREAT-151	Pro-Treat® 151 Premium Drain Pan Treatment – 100 Tablets/Jar	EA	12

Pro-Treat® 161 Condensate Drain Pan Treatment

Controls odors and eliminates condensate drain pan overflows and the resulting water damage. 100% soluble, easy-to-use, non-corrosive, and non-toxic. Use regularly to assure season-long, trouble-free condensate drain pan performance. Approved for computer rooms. Dosage: 2 tablets per 3 tons each month.



CATALOG NO.	DESCRIPTION	UOM	ORDER MULTIPLE
PROTREAT-161	Pro-Treat® 161 Drain Pan Treatment – 100 Tablets/Jar	EA	12

Pro-Treat® 217 Economy Condensate Drain Pan Treatment

Economical with 200 tablets per jar. Safe, non corrosive, odor free and 100% soluble. Approved for computer rooms. Convenient, easy to use tablet form provides prolonged cleaning action. Dosage 3 tablets per 3 tons per month.



CATALOG NO.	DESCRIPTION	UOM	ORDER MULTIPLE
PROTREAT-217	Pro-Treat® 217 Economy Drain Pan Treatment – 200 Tablets/Jar	EA	12

Pro-Treat® 152 King-Size Premium Condensate Drain Pan Treatment

Economical, safe, effective king-size tablets last three times longer. Safe, non-corrosive, odor-free and 100% soluble. Computer room approved. Keeps drain pans and condensate lines clean and free flowing. Dosage: 1 tablet per 3 tons per 3 months.



CATALOG NO.	DESCRIPTION	UOM	ORDER MULTIPLE
PROTREAT-152	Pro-Treat® 152 King-Size Premium Drain Pan Treatment – 12 Tablets/Jar	EA	6

Pro-Treat® 200 Economy Condensate Drain Pan Treatment

Economical with 200 tablets per jar. Safe, non-corrosive, odor-free and 100% soluble. Approved for computer rooms. Convenient, easy-to-use tablet form provides prolonged cleaning action. Dosage: 3 tablets per 3 tons per month.



CATALOG NO.	DESCRIPTION	UOM	ORDER MULTIPLE
PROTREAT-200	Pro-Treat® 200 Economy Drain Pan Treatment – 200 Tablets/Jar	EA	12

REFRIGERATION OILS

Pro-Lube™ Mineral Oil

Specialty Chemical mineral oil (by Calumet) is a superior mineral naphthenic refrigeration oil designed to meet the operating requirements of modern residential and commercial air conditioning and refrigeration compressors. These oils have a low pour point, low wax floc temperature and are chemically and thermally stable in the presence of refrigerants. OEM approved by Copeland, Carlyle, Trane, and other major compressor manufacturers. Always follow compressor manufacturer's oil viscosity recommendations. Mineral oil is specially recommended for lubrication of compressors containing ammonia, R-11, 12, 13, 22, 113, 114, 123, 500 and 502 refrigerants in residential, industrial and commercial service. DO NOT USE WITH HFC REFRIGERANTS SUCH AS R-134A.



CATALOG NO.	DESCRIPTION	UOM	ORDER MULTIPLE
3WF-01	SUS150 ISO32 Pro-Lube™ Mineral Oil – 1 Gallon Jug	EA	4
4WF-01	SUS300 ISO68 Pro-Lube™ Mineral Oil – 1 Gallon Jug	EA	4

Pro-Lube-ALK™ Alkylbenzene

Specialty Chemical alkylbenzene is recommended for refrigeration, air conditioning, and heat pump applications using HCFC and CFC refrigerants. An excellent choice when retrofitting to the new refrigerants which are HCFC based such as R-401A (MP-39), R-401B (MP-66), R-402A (HP-80), R-402B (HP-81). OEM approved by Copeland and other compressor manufacturers.



CATALOG NO.	DESCRIPTION	UOM	ORDER MULTIPLE
ALK150-01	SUS150 ISO32 Pro-Lube™ Alkylbenzene – 1 Gallon Jug	EA	4
ALK150-05	SUS150 ISO32 Pro-Lube™ Alkylbenzene – 5 Gallon Drum	EA	1
ALK200-01	SUS200 ISO46 Pro-Lube™ Alkylbenzene – 1 Gallon Jug	EA	4
ALK300-01	SUS300 ISO68 Pro-Lube™ Alkylbenzene – 1 Gallon Jug	EA	4

REFRIGERATION OILS cont'd

Pro-Lube-POE™ Polyolester

Specialty Chemical POE is custom formulated for use in refrigeration compressors. This series contains no ozone depleting substances and is compatible with new HFC refrigerants as well as existing CFC and HCFC refrigerants. POE is also compatible with traditional mineral oil lubricants.



POE32-32

CATALOG NO.	DESCRIPTION	UOM	ORDER MULTIPLE
POE32-32	SUS150 ISO32 Pro-Lube-POE™ Polyolester – 1 Quart Can	EA	12
POE32-01	SUS150 ISO32 Pro-Lube-POE™ Polyolester – 1 Gallon Can	EA	6
POE68-32	SUS300 ISO68 Pro-Lube-POE™ Polyolester – 1 Quart Can	EA	12
POE68-01	SUS300 ISO68 Pro-Lube-POE™ Polyolester – 1 Gallon Can	EA	6
POE100-32	SUS500 ISO100 Pro-Lube-POE™ Polyolester – 1 Quart Can	EA	12
POE100-01	SUS500 ISO100 Pro-Lube-POE™ Polyolester – 1 Gallon Can	EA	6

SYSTEM CLEANERS

D'Scale™ Acid Scale Remover for Cooling Towers

D'Scale™ will not create corrosive acidic foam. D'Scale™ has pH indicating dye. The color changes to yellow when acid has been consumed. Each gallon dissolves 3 pounds of scale.



D-SCALE

CATALOG NO.	DESCRIPTION	UOM	ORDER MULTIPLE
D-SCALE	D'Scale™ Acid Scale Remover – 1 Gallon Container	EA	4

TEST KITS

Acid Test Kit™

Detects acid in refrigeration oil. Convenient, one-step test means no chemicals to mix. Easy to evaluate. Color change indicates acidity; color intensity reveals the amount of acid present in the oil sample.



ATK-4

ATK-1

ATK-1P

CATALOG NO.	DESCRIPTION	UOM	ORDER MULTIPLE
ATK-4	Acid Test Kit™, pack of 4	EA	4
ATK-1	Acid Test Kit™	EA	1
ATK-1P	Acid Test Kit™ for POE Oil	EA	1

THREAD SEALANTS

PRO-TITE™ Resin Based Thread Sealant

Resin based thread sealant that adheres to internal surfaces, fills voids while forming a flexible fluid tight seal. Specifically formulated for use on metals and plastics subject to extreme vibration. Serviceable at temperatures from 100°F (73°C) to 400°F (204°C) and from full vacuum to 10,000 PSI. Pro Tite™ is impervious to most chemicals including refrigerants, petroleum products, gases, steam, etc. Alcohol based.



CATALOG NO.	DESCRIPTION	UOM	ORDER MULTIPLE
CLL-1	Pro-Tite™ Thread Sealant – 1-1/3 oz. Squeeze Tube	EA	12
CLL-4	Pro-Tite™ Thread Sealant – 4 oz. Brush Top	EA	12

VACUUM PUMP OIL

Pro-Lube-VAC™ Vacuum Pump Oil

Specialty Chemical VP-68 Premium Vacuum Pump Oil is now based on a highly refined paraffinic based stock. This new improved formulation is lighter in color and provides better viscosity and oxidation stability than the previous formulation. VP-68 provides excellent cold start performance; formulated to meet minimum moisture content specifications.



CATALOG NO.	DESCRIPTION	UOM	ORDER MULTIPLE
VP68-32	Pro-Lube-VAC™ Vacuum Pump Oil – 1 Quart Jug	EA	12
VP68-01	Pro-Lube-VAC™ Vacuum Pump Oil – 1 Gallon Jug	EA	4
VP68-05	Pro-Lube-VAC™ Vacuum Pump Oil – 5 Gallon Pail	EA	1

ADDITIVES

Acid Eliminator

Keeps acid away; compatible with all refrigerants and oils. Chemically neutralizes and prevents acids that are formed in air conditioning and refrigeration systems due to refrigerant and refrigeration oil break-down, moisture, and compressor burnout. Easy-to-use, no complicated charts. Works fast, circulates quickly, and leaves no solids or solid residuals. Will not harm system components. Can prevent system breakdown.



CATALOG NO.	DESCRIPTION	UOM	ORDER MULTIPLE
ACID-ELIM	Acid Eliminator – 4 oz. Plastic Bottle	EA	12

Dry R™

DRY R™ enhances the function of driers and metering devices by removing non-condensables, eliminating ice crystals, and breaking down blockages by removing scale and sludge on moving parts such as TXVs.



CATALOG NO.	DESCRIPTION	UOM	ORDER MULTIPLE
973KIT	Dry R™ Moisture Eliminator - Up to 5 tons	EA	12

Pro-Thaw™ Liquid Dryer for Refrigerants

Chemically dries all refrigerants (R-12, R-22, R-134a, etc.), methyl chloride and methylene chloride. Frees up systems frozen due to moisture contamination in 5 minutes and prevents refreezing. Does not contain any dissolved solids, leaves no residue and works with or without solid dryers.



CATALOG NO.	DESCRIPTION	UOM	ORDER MULTIPLE
PRO-THAW-1	Pro-Thaw™ – 1 oz. Plastic Bottle	EA	24
PRO-THAW	Pro-Thaw™ – 4 oz. Plastic Bottle	EA	12

INLINE COMPONENTS

Access Fittings 236
 Brass Fittings..... 238-240
 Copper Fittings 233-235
 Cushion Clamps 240
 Driers, Sight Glasses 241-242
 Line Piercing Valves and Tools 237
 Refrigerant Charging..... 242
 Refrigerant Labels..... 245
 Refrigerant Recovery Products 245
 Refrigerant Tubing 243-244
 Reversing Valves..... 244
 Sentry™ Refrigerant Locking Caps 246
 Tubing Insulation 247





REFRIGERANT LOCKING CAPS

Sentry™ Refrigerant Locking Caps meet the International Residential Code (IRC) and International Mechanical Code (IMC) requirement that all outdoor access ports on A/C and refrigerant equipment must be tamper resistant. Sentry™ Locking Caps safeguard against refrigerant theft and inhalant abuse. These locking caps are anodized in industry color codes for easy identification and prevent accidental mixing of refrigerant gases.

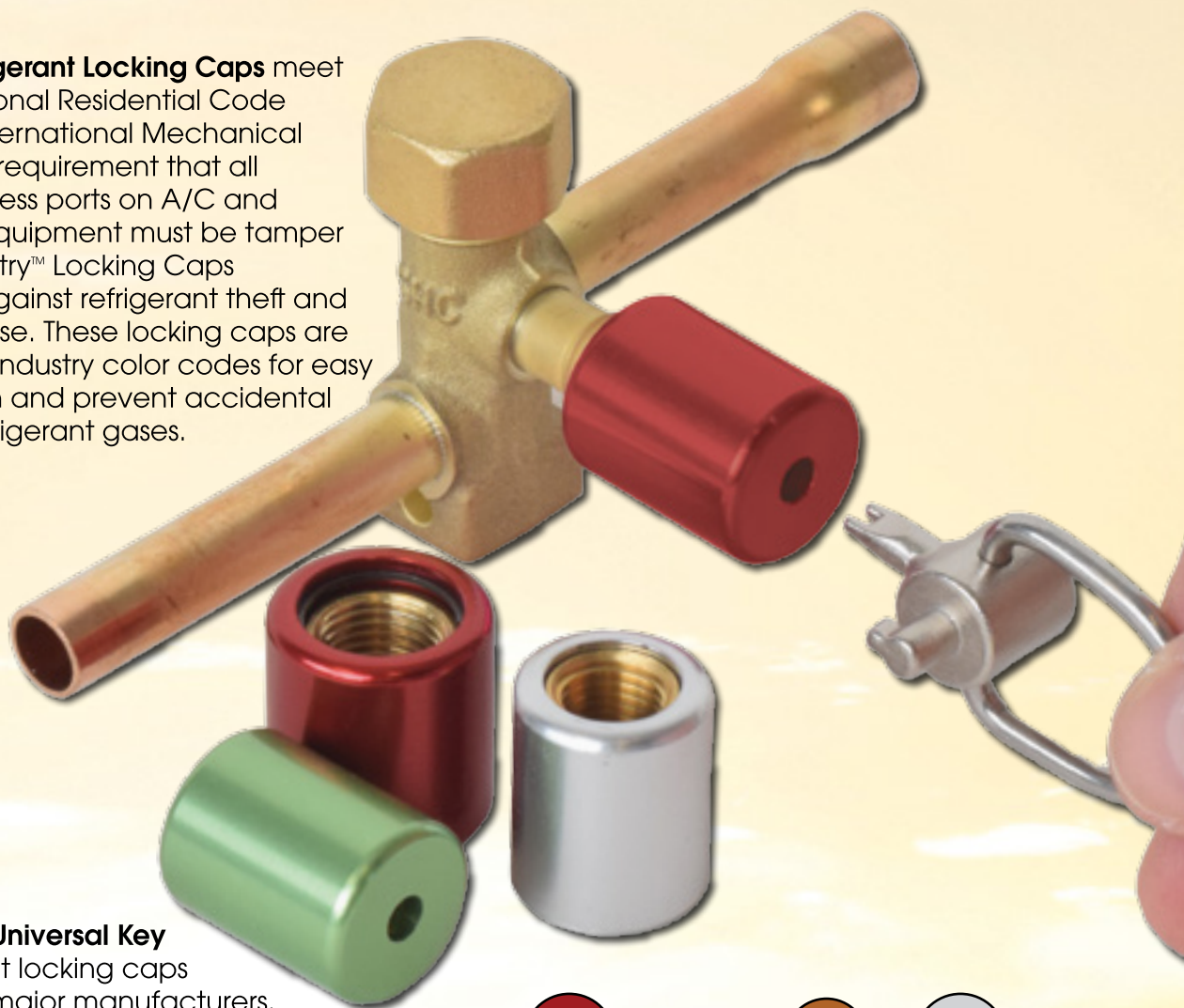

The **Sentry™ Universal Key** fits refrigerant locking caps from all the major manufacturers. It saves time hunting for the right key at the job site. It fits locking caps with these key holes:

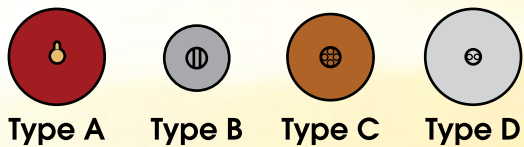

Code Compliant

Meets the IMC & IRC code requirement.



Deters Refrigerant Theft

Tamper resistant cap design.

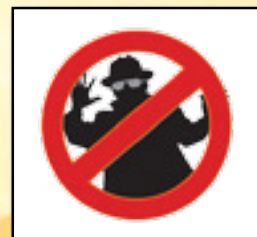

Weather Proof

Anodized aluminum casing with threaded brass insert.

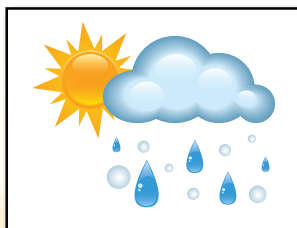

Universal Key Included

Fits refrigerant locking caps from all major manufacturers.



COPPER FITTINGS

Male Adapter C x M



CATALOG NO.	O.D. SIZE	I.D. SIZE	UOM	ORDER MULTIPLE
C101-0050	5/8" x 1/2"	1/2" x 1/2"	EA	25
C101-0100	7/8" x 3/4"	3/4" x 3/4"	EA	25
C101-0150	1-1/8" x 1"	1" x 1"	EA	10
C101-0222	1-3/8" x 1"	1-1/4" x 1"	EA	10

Female Adapter C x F



CATALOG NO.	O.D. SIZE	I.D. SIZE	UOM	ORDER MULTIPLE
C105-0057	5/8" x 3/4"	1/2" x 3/4"	EA	25
C105-0100	7/8" x 3/4"	3/4" x 3/4"	EA	25
C105-0150	1-1/8" x 1"	1" x 1"	EA	10
C105-0215	1-3/8" x 1-1/4"	1-1/4" x 1-1/4"	EA	10

Male Adapter Ftg. x M



CATALOG NO.	O.D. SIZE	I.D. SIZE	UOM	ORDER MULTIPLE
C114-0215	1-3/8" x 1-1/4"	1-1/4" x 1-1/4"	EA	10

90 Degree Long Turn Street Ell Ftg. x C



CATALOG NO.	O.D. SIZE	I.D. SIZE	UOM	ORDER MULTIPLE
C272-0002	3/8"	1/4"	EA	25
C272-0025	1/2"	3/8"	EA	25
C272-0050	5/8"	1/2"	EA	25
C272-0090	3/4"	5/8"	EA	25
C272-0100	7/8"	3/4"	EA	10
C272-0150	1-1/8"	1"	EA	10
C272-0215	1-3/8"	1-1/4"	EA	10

90 Degree Ell C x C



CATALOG NO.	O.D. SIZE	I.D. SIZE	UOM	ORDER MULTIPLE
C235-0002	3/8"	1/4"	EA	25
C235-0025	1/2"	3/8"	EA	25
C235-0050	5/8"	1/2"	EA	25
C235-0090	3/4"	5/8"	EA	25
C235-0100	7/8"	3/4"	EA	25
C235-0150	1-1/8"	1"	EA	10
C235-0215	1-3/8"	1-1/4"	EA	10

45 Degree Ell C x C



CATALOG NO.	O.D. SIZE	I.D. SIZE	UOM	ORDER MULTIPLE
C290-0002	3/8"	1/4"	EA	25
C290-0025	1/2"	3/8"	EA	25
C290-0050	5/8"	1/2"	EA	25
C290-0090	3/4"	5/8"	EA	25
C290-0100	7/8"	3/4"	EA	25
C290-0150	1-1/8"	1"	EA	10
C290-0215	1-3/8"	1-1/4"	EA	60
C290-0390	2-1/8"	2"	EA	18

90 Degree Street Ell Ftg. x C



CATALOG NO.	O.D. SIZE	I.D. SIZE	UOM	ORDER MULTIPLE
C254-0002	3/8"	1/4"	EA	25
C254-0100	7/8"	3/4"	EA	25
C254-0150	1-1/8"	1"	EA	10

COPPER FITTINGS cont'd

90 Degree Long Turn Ell C x C



CATALOG NO.	O.D. SIZE	I.D. SIZE	UOM	ORDER MULTIPLE
C242-0001	1/4"	1/8"	EA	25
C242-0002	3/8"	1/4"	EA	25
C242-0025	1/2"	3/8"	EA	25
C242-0050	5/8"	1/2"	EA	25
C242-0090	3/4"	5/8"	EA	25
C242-0100	7/8"	3/4"	EA	10
C242-0150	1-1/8"	1"	EA	10
C242-0215	1-3/8"	1-1/4"	EA	35
C242-0295	1-5/8"	1-1/2"	EA	25
C242-0390	2-1/8"	2"	EA	12

Coupling (Socket) with Rolled Tube Stop C x C



CATALOG NO.	O.D. SIZE	I.D. SIZE	UOM	ORDER MULTIPLE
C165-0001	1/4"	1/8"	EA	25
C165-0002	3/8"	1/4"	EA	25
C165-0025	1/2"	3/8"	EA	25
C165-0050	5/8"	1/2"	EA	25
C165-0090	3/4"	5/8"	EA	25
C165-0100	7/8"	3/4"	EA	25
C165-0150	1-1/8"	1"	EA	10
C165-0215	1-3/8"	1-1/4"	EA	10
C165-0295	1-5/8"	1-1/2"	EA	60
C165-0390	2-1/8"	2"	EA	40

Reducer Coupling w/Stop C x C



CATALOG NO.	O.D. SIZE	I.D. SIZE	UOM	ORDER MULTIPLE
C165-0007	3/8" x 1/4"	1/4" x 1/8"	EA	25
C165-0032	1/2" x 3/8"	3/8" x 1/4"	EA	25
C165-0058	5/8" x 1/2"	1/2" x 3/8"	EA	25
C165-0093	3/4" x 5/8"	5/8" x 1/2"	EA	25
C165-0094	3/4" x 1/2"	5/8" x 3/8"	EA	25
C165-0107	7/8" x 5/8"	3/4" x 1/2"	EA	25
C165-0149	7/8" x 3/4"	3/4" x 5/8"	EA	25
C165-0159	1-1/8" x 7/8"	1" x 3/4"	EA	10
C165-1498	1-1/8" x 3/4"	1" x 5/8"	EA	10
C165-0222	1-3/8" x 1-1/8"	1-1/4" x 1"	EA	10
C165-0223	1-3/8" x 7/8"	1-1/4" x 3/4"	EA	10
C165-0304	1-5/8" x 1-1/8"	1-1/2" x 1"	EA	10
C165-0305	1-5/8" x 7/8"	1-1/2" x 3/4"	EA	10
C165-0399	2-1/8" x 1-3/8"	2" x 1-1/4"	EA	50

45 Degree Street Ell Ftg. x C



CATALOG NO.	O.D. SIZE	I.D. SIZE	UOM	ORDER MULTIPLE
C295-0002	3/8"	1/4"	EA	25
C295-0090	3/4"	5/8"	EA	25
C295-0100	7/8"	3/4"	EA	25
C295-0150	1-1/8"	1"	EA	10

Fitting Reducer Coupling Ftg. x C



CATALOG NO.	O.D. SIZE	I.D. SIZE	UOM	ORDER MULTIPLE
C410-0032	1/2" x 3/8"	3/8" x 1/4"	EA	25
C410-0058	5/8" x 1/2"	1/2" x 3/8"	EA	25
C410-0093	3/4" x 5/8"	5/8" x 1/2"	EA	25
C410-0107	7/8" x 5/8"	3/4" x 1/2"	EA	25
C410-0149	7/8" x 3/4"	3/4" x 5/8"	EA	25
C410-0159	1-1/8" x 7/8"	1" x 3/4"	EA	10
C410-0222	1-3/8" x 1-1/8"	1-1/4" x 1"	EA	10
C410-0306	1-5/8" x 5/8"	1-1/2" x 1/2"	EA	10

Cap



CATALOG NO.	O.D. SIZE	I.D. SIZE	UOM	ORDER MULTIPLE
C154-0002	3/8"	1/4"	EA	25
C154-0090	3/4"	5/8"	EA	25
C154-0100	7/8"	3/4"	EA	25

Union C x Brass



CATALOG NO.	O.D. SIZE	I.D. SIZE	UOM	ORDER MULTIPLE
C657-0100	7/8"	3/4"	EA	100

Flush Bushing



C142-0058

CATALOG NO.	O.D. SIZE	I.D. SIZE	UOM	ORDER MULTIPLE
C142-0058	5/8" x 1/4"	1/2" x 1/4"	EA	25

U-Type Strap



CATALOG NO.	O.D. SIZE	I.D. SIZE	UOM	ORDER MULTIPLE
C947-0025	1/2"	3/8"	EA	25
C947-0050	5/8"	1/2"	EA	25
C947-0100	7/8"	3/4"	EA	25
C947-0150	1-1/8"	1"	EA	25
C947-0215	1-3/8"	1-1/4"	EA	100
C947-0295	1-5/8"	1-1/2"	EA	100
C947-0390	2-1/8"	2"	EA	50

Copper Coupling with No Stop



C172-0100

CATALOG NO.	O.D. SIZE	I.D. SIZE	UOM	ORDER MULTIPLE
C172-0090	3/4"	5/8"	EA	25
C172-0100	7/8"	3/4"	EA	25
C172-0150	1-1/8"	1"	EA	10
C172-0215	1-3/8"	1-1/4"	EA	10

P-Traps



C533-0050

CATALOG NO.	O.D. SIZE	I.D. SIZE	UOM	ORDER MULTIPLE
C533-0050	5/8	1/2	EA	5
C533-0150	1-1/8	1	EA	3

Reducing Tee C x C x C



C460-0305

CATALOG NO.	O.D. SIZE	I.D. SIZE	UOM	ORDER MULTIPLE
C460-0222	1-3/8" x 1-3/8" x 1-1/8"	1-1/4" x 1-1/4" x 1"	EA	40
C460-0305	1-5/8" x 1-5/8" x 7/8"	1-1/2" x 1-1/2" x 3/4"	EA	35
C460-0414	2-1/8" x 1-5/8" x 1-5/8"	2" x 1-1/2" x 1-1/2"	EA	10
C460-0429	2-1/8" x 1-3/8" x 2-1/8"	2" x 1-1/4" x 2"	EA	10
C460-0432	2-1/8" x 1-3/8" x 1-1/8"	2" x 1-1/4" x 1"	EA	20

Copper Coupling w/Dimple Stop



C170-0003

CATALOG NO.	O.D. SIZE	I.D. SIZE	UOM	ORDER MULTIPLE
C170-0003	5/16	1/4	EA	25

Tee C x C x C



C460-0090

CATALOG NO.	O.D. SIZE	I.D. SIZE	UOM	ORDER MULTIPLE
C460-0002	3/8"	1/4"	EA	25
C460-0025	1/2"	3/8"	EA	25
C460-0050	5/8"	1/2"	EA	25
C460-0090	3/4"	5/8"	EA	25
C460-0100	7/8"	3/4"	EA	10
C460-0150	1-1/8"	1"	EA	10
C460-0215	1-3/8"	1-1/4"	EA	35
C460-0295	1-5/8"	1-1/2"	EA	20
C460-0390	2-1/8"	2"	EA	10

ACCESS FITTINGS

A convenient low-cost port for refrigeration servicing. May be installed in any position on either high or low side for charging, purging, quick testing or pressure checking. DiversiTech's access fittings have 1/4" SAE male flare access ports and include a quick seal cap and a stainless and brass special refrigerant valve core.

CATALOG NO.	DESCRIPTION	CONNECTION	QTY PER PACK	UOM	ORDER MULT.
VA-3-346	3 Way Solder Type, pack of 6	For 3/16" O.D. tube or 1/4" and 3/8" solder fitting	6	PK	1
VA-34	Straight Solder Type, pack of 6	3/16" O.D.S. x 1/4" O.D.F.	6	PK	1
VA-46	Straight Solder Type, pack of 6	1/4" O.D.S. x 3/8" O.D.F.	6	PK	1
VA-68	Straight Solder Type, pack of 6	3/8" O.D.S. x 1/2" O.D.F.	6	PK	1
VAU-24	Half Union, pack of 6	1/8" MPT	6	PK	1
VAU-45	Half Union, pack of 6	1/4" MPT	6	PK	1
VAX-2	Extended Copper Tube	1/8" O.D. tube	6	PK	1
VAX-3	Extended Copper Tube	3/16" O.D. x 1/8" I.D.	6	PK	1
VAX-4	Extended Copper Tube	1/4" O.D. x 3/16" I.D.	6	PK	1
VAX-5	Extended Copper Tube	5/16" O.D. x 1/4" I.D.	3	PK	1
VAX-6	Extended Copper Tube	3/8" O.D. x 5/16" I.D.	3	PK	1
VAX-8	Extended Copper Tube	1/2" O.D.	3	PK	1
VS-4	Swivel Nut w/Depressor, pack of 6	1/4" female flare forged swivel nut	6	PK	1
VST-4	Swivel Tee w/Permanent Depressor, pack of 3	1/4" Access on run x 1/4" female flare w/depressor on female swivel branch end	3	PK	1
VST-44	Swivel Tee w/Perm. Depressor, pack of 3	1/4" Access on run x 1/4" access on "T" - female swivel on run	3	PK	1
VTR-24	Threaded Tee, pack of 3	1/8" MPT x 1/4" male flare on run x access on branch	3	PK	1
VTS-10	Solder Tee Type	5/8" O.D. tube	1	EA	1
VTS-12	Solder Tee Type	3/4" O.D. tube	1	EA	1
VTS-14	Solder Tee Type	7/8" O.D. tube	1	EA	1
VTS-46	Solder Tee Type, pack of 3	1/4" O.D.S. x 5/16" O.D.F.	3	PK	1
VTS-56	Solder Tee Type, pack of 3	5/16" O.D.S. x 3/8" O.D.F.	3	PK	1
VTS-68	Solder Tee Type, pack of 3	3/8" O.D.S.	3	PK	1
VTS-810	Solder Tee Type, pack of 3	1/2" O.D.S.	3	PK	1
VTS-3-12	Solder Tube Elbow	3/4" O.D.S.	1	EA	1
VTS-3-14	Solder Tube Elbow	7/8" O.D.S.	1	EA	1
VC-4	Flare Cap, pack of 12	1/4"	12	PK	1
VC-4R	Flare Cap w/Core Remover, pack of 12	1/4"	12	PK	1
VVC-1	Valve Core, pack of 6		6	PK	1



Brass Adapters

The MSA-45 is used on the new R410 Mini Split systems that have the larger unique fitting on the service valve. The description of that fitting is 1/2" acme Male-20 UN. This adapter will screw onto the 1/2" Acme Male-20 UN fitting and allow you to connect a standard 1/4 service hose to it.



CATALOG NO.	DESCRIPTION	UOM	ORDER MULTIPLE
MSA-45	1/4" Male flare x 1/2" - 20 UNF Female	EA	1
MSA-44	1/4" Female flare swivel w/depressor tip and seal x 1/4" MPT, pack of 2	PK	1

Cop-Cap™ Locking Valve Cover

An effective way to discourage and prevent the removal of refrigerant. COP-CAP™ fits this standard service valve on all central AC units and mini-splits. It helps prevent access by unauthorized persons and can only be removed with the included special tool. Simply thread COP-CAP™ assembly onto existing 1/4" flare connection on system and lock set screw in place with hex wrench provided.



- Seals service valve to prevent leaks
- Prevents illegal venting or theft of refrigerant
- Stops unauthorized access in unsecured areas

CATALOG NO.	DESCRIPTION	UOM	ORDER MULTIPLE
VCC-4	Cop-Cap™, Pack of 2	PK	1
VCC-4B	Cop-Cap™ bulk, 100 per case	EA	100

LINE PIERCING VALVES AND TOOLS

Quick-Tap

Features a valve core in the 1/4" male port. Simply pierce the line and back seat the needle. Flow starts when depressor type charging hose is connected. Flow shuts off automatically when hose is removed. If valve core is not desired, it may be removed. Connect hose, pierce line and back seat needle. This method offers full unrestricted flow. Valve core can be removed or changed at any time without loss of refrigerant if needle is front seated.

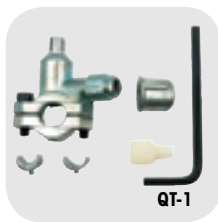

CATALOG NO.	DESCRIPTION	UOM	ORDER MULTIPLE
QT-1	Quick-Tap – 1/4", 5/16", 3/8" O.D. Tube Size	EA	1
QT-2	Quick-Tap – 1/2", 5/8" O.D. Tube Size	EA	1

MAC—The Ultimate in Line Piercing Valves

Install valve. Connect charging hose. Service. That's all there is to it! MAC features uniport: 1 connection for piercing and servicing. Sealed with refrigerant resistant "O" rings. Needle automatically back seats after servicing, leaving line free of restriction. Connect to tubing with 2 socket-head screws. (Hex wrench is included with each valve.) Needle depressor is inserted into head of needle. Wing cap is turned down easily by hand until line is pierced. Wing cap is removed and system may be serviced with any charging hose with built-in depressor. When hose is removed, spring loaded needle back-seats forming a leak proof seal. Needle depressor is discarded and wing cap forms extra precautionary seal.



CATALOG NO.	DESCRIPTION	UOM	ORDER MULTIPLE
QTM-1	MAC Line Piercing Valve – 1/4", 5/16", 3/8" O.D. Tube Size	EA	36
QTM-2	MAC Line Piercing Valve – 1/2", 5/8" O.D. Tube Size	EA	36

Copper Saddle Valve

For copper-to-copper brazing. Penetrates line in one easy operation with no holes to drill. Steel pin with valve core pierces line and is locked into valve body by tightening cap. Teflon ring assures positive seal. Available in sizes from 1/4" to 1-1/8".



CATALOG NO.	DESCRIPTION	UOM	ORDER MULTIPLE
VLC-4	Copper Saddle Valve – 1/4" O.D. Tube Size, pack of 6	PK	1
VLC-5	Copper Saddle Valve – 5/16" O.D. Tube Size, pack of 6	PK	1
VLC-6	Copper Saddle Valve – 3/8" O.D. Tube Size, pack of 6	PK	1
VLC-8	Copper Saddle Valve – 1/2" O.D. Tube Size, pack of 4	PK	1
VLC-10	Copper Saddle Valve – 5/8" O.D. Tube Size, pack of 3	PK	1
VLC-12	Copper Saddle Valve – 3/4" O.D. Tube Size, pack of 2	PK	1
VLC-18	Copper Saddle Valve – 1-1/8" O.D. Tube Size, pack of 2	PK	1
VLC-25	Additional Teflon Rings, pack of 25	PK	1

Quick-Tap-2

Identical to Quick-Tap except that a nylon handle replaces the hex wrench. Phillips-head screws are used.



CATALOG NO.	DESCRIPTION	UOM	ORDER MULTIPLE
QTH-1	Quick-Tap-2 – 1/4", 5/16", 3/8" O.D. Tube Size	EA	1
QTH-2	Quick-Tap-2 – 1/2", 5/8" O.D. Tube Size	EA	1

Insta-Tap Refrigerant Recovery Tool

The fastest, easiest way to evacuate refrigerant before disposal of a unit. Snaps onto refrigerant line for full and immediate flow. Punctures super large hole for maximum full flow discharge to recovery unit. One tool fits all sizes from 3/16" to 7/8" O.D. hard tubing. Replaceable needle.



CATALOG NO.	DESCRIPTION	UOM	ORDER MULTIPLE
QT-100	Quick-Tap-2 – 1/4", 5/16", 3/8" O.D. Tube Size	EA	1
QT-100N	Replaceable Hardened Steel Needle and Gasket	EA	1
QT-100G	Replacement Gasket Only	EA	3

Core Storer

All steel valve core remover and storage container. Completely knurled for easier grip, eliminating slippage when using with oily or greasy hands. Core Storer features a compartment for storing extra valve cores. Four replacement cores are included with each tool.



CATALOG NO.	DESCRIPTION	UOM	ORDER MULTIPLE
VCR-1	Core Remover and Storer	EA	1

Core Removal Tool

Designed to remove and replace valve cores without losing the refrigerant charge. Connects to any 1/4" male flare fitting. Saves time, saves refrigerant.



CATALOG NO.	DESCRIPTION	UOM	ORDER MULTIPLE
VCRT-1	Core Removal Tool	EA	1
VCRT-1R	Replacement Rod Assembly	EA	1
VCRT-1S	Replacement Shut-off Stem	EA	1

BRASS FITTINGS

Compression Sleeve



CATALOG NO.	DESCRIPTION	UOM	ORDER MULTIPLE
D60A-4	1/4" Compression Sleeve	EA	100
D60A-8	1/2" Compression Sleeve	EA	100
D60A-10	5/8" Compression Sleeve	EA	100

Compression Nut



CATALOG NO.	DESCRIPTION	UOM	ORDER MULTIPLE
D61A-4	1/4" Compression Nut	EA	10
D61A-8	1/2" Compression Nut	EA	10

Compression Union



CATALOG NO.	DESCRIPTION	UOM	ORDER MULTIPLE
D62A-44	1/4" Compression Union	EA	10
D62A-66	3/8" Compression Union	EA	10
D62A-88	1/2" Compression Union	EA	10
D62A-1010	5/8" Compression Union	EA	10

Flare x MIP Elbow



CATALOG NO.	DESCRIPTION	UOM	ORDER MULTIPLE
DE1-4B	1/4" Flare x 1/4" MIP Elbow	EA	10
DE1-6C	3/8" Flare x 3/8" MIP Elbow	EA	10
DE1-8D	1/2" Flare x 1/2" MIP Elbow	EA	10
DE1-12E	3/4" Flare x 3/4" MIP Elbow	EA	10

Compression Connector



CATALOG NO.	DESCRIPTION	UOM	ORDER MULTIPLE
D68A-4B	1/4" x 1/4" Compression Connector	EA	10
D68A-6C	3/8" x 3/8" Compression Connector	EA	10
D68A-8D	1/2" x 1/2" Compression Connector	EA	10
D68A-6D	3/8" x 1/2" Compression Connector	EA	10

Compression Elbow



CATALOG NO.	DESCRIPTION	UOM	ORDER MULTIPLE
D69A-4A	1/4" x 1/8" Compression Elbow	EA	10
D69A-8D	1/2" x 1/2" Compression Elbow	EA	10

Compression Tee



CATALOG NO.	DESCRIPTION	UOM	ORDER MULTIPLE
D64A-44	1/4" Compression Tee	EA	10
D64A-66	3/8" Compression Tee	EA	10
D64A-88	1/2" Compression Tee	EA	10
D64A-1010	5/8" Compression Tee	EA	10

Flare x MIP Reducing Elbow



CATALOG NO.	DESCRIPTION	UOM	ORDER MULTIPLE
DE1-6B	3/8" Flare x 1/4" MIP Reducing Elbow	EA	10
DE1-6D	3/8" Flare x 1/2" MIP Reducing Elbow	EA	10
DE1-8E	1/2" Flare x 3/4" MIP Reducing Elbow	EA	10
DE1-10D	5/8" Flare x 1/2" MIP Reducing Elbow	EA	10

Short Nut



CATALOG NO.	DESCRIPTION	UOM	ORDER MULTIPLE
DN1-3	3/16" Short Nut	EA	10
DN1-4	1/4" Short Nut	EA	10
DN1-6	3/8" Short Nut	EA	10
DN1-10	5/8" Short Nut	EA	10
DN1-12	3/4" Short Nut	EA	10
DN1-14	7/8" Short Nut	EA	5

Cap



CATALOG NO.	DESCRIPTION	UOM	ORDER MULTIPLE
DN5-4	1/4" Cap	EA	10
DN5-6	3/8" Cap	EA	10

Short Forged Flare Nut



CATALOG NO.	DESCRIPTION	UOM	ORDER MULTIPLE
DNS4-4	1/4" Short Forged Flare Nut	EA	10
DNS4-6	3/8" Short Forged Flare Nut	EA	10
DNS4-8	1/2" Short Forged Flare Nut	EA	10
DNS4-10	5/8" Short Forged Flare Nut	EA	10
DNS4-12	3/4" Short Forged Flare Nut	EA	10
DNS4-14	7/8" Short Forged Flare Nut	EA	5

Plug



CATALOG NO.	DESCRIPTION	UOM	ORDER MULTIPLE
DP2-4	1/4" Plug	EA	10
DP2-6	3/8" Plug	EA	10
DP2-8	1/2" Plug	EA	10
DP2-10	5/8" Plug	EA	10

Flare Tee



CATALOG NO.	DESCRIPTION	UOM	ORDER MULTIPLE
DT2-4	1/4" Flare Tee	EA	10
DT2-6	3/8" Flare Tee	EA	10
DT2-8	1/2" Flare Tee	EA	10
DT2-10	5/8" Flare Tee	EA	5

Flare x MIP Union

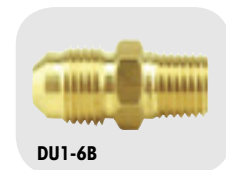

CATALOG NO.	DESCRIPTION	UOM	ORDER MULTIPLE
DU1-4A	1/4" Flare x 1/8" MIP Union	EA	10
DU1-4B	1/4" Flare x 1/4" MIP Union	EA	10
DU1-6B	3/8" Flare x 1/4" MIP Union	EA	10
DU1-6C	3/8" Flare x 3/8" MIP Union	EA	10
DU1-6D	3/8" Flare x 1/2" MIP Union	EA	10
DU1-6E	3/8" Flare x 3/4" MIP Union	EA	10
DU1-8B	1/2" Flare x 1/4" MIP Union	EA	10
DU1-8D	1/2" Flare x 1/2" MIP Union	EA	10
DU1-8E	1/2" Flare x 3/4" MIP Union	EA	10
DU1-10D	5/8" Flare x 1/2" MIP Union	EA	10
DU1-10E	5/8" Flare x 3/4" MIP Union	EA	10
DU1-12D	3/4" Flare x 1/2" MIP Union	EA	10

Flare Union

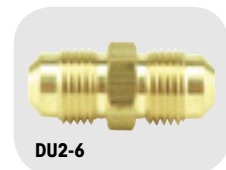

CATALOG NO.	DESCRIPTION	UOM	ORDER MULTIPLE
DU2-4	1/4" Flare Union	EA	10
DU2-6	3/8" Flare Union	EA	10
DU2-8	1/2" Flare Union	EA	10
DU2-10	5/8" Flare Union	EA	10
DU2-12	3/4" Flare Union	EA	10
DU2-14	7/8" Flare Union	EA	5

BRASS FITTINGS cont'd

Flare x FIP Union



CATALOG NO.	DESCRIPTION	UOM	ORDER MULTIPLE
DU3-6D	3/8" x 1/2" Flare x FIP Union	EA	10
DU3-8D	1/2" x 1/2" Flare x FIP Union	EA	10
DU3-10E	5/8" x 3/4" Flare x FIP Union	EA	10

Flare x Flare Swivel Union

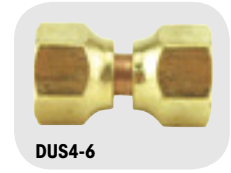

CATALOG NO.	DESCRIPTION	UOM	ORDER MULTIPLE
DUS4-4	1/4" Flare x 1/4" Flare Swivel Union	EA	10
DUS4-6	3/8" Flare x 3/8" Flare Swivel Union	EA	10

CUSHION CLAMPS

Cushion Clamps

An industry standard universal clamp that mounts to standard strut. Steel with electro-dichromate finish to resist corrosion. The lock nut has a nylon insert for a positive lock. The polymeric grommet withstands temperatures from -25°C to 125°C and resists the effects of most oils, chemicals, and industrial cleaning compounds.

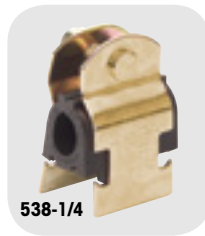

CATALOG NO.	DESCRIPTION	UOM	ORDER MULTIPLE
538-1/4	Cushion Clamp – 1/4"	EA	25
538-3/8	Cushion Clamp – 3/8"	EA	25
538-1/2	Cushion Clamp – 1/2"	EA	25
538-5/8	Cushion Clamp – 5/8"	EA	25
538-3/4	Cushion Clamp – 3/4"	EA	25
538-7/8	Cushion Clamp – 7/8"	EA	25
538-1-1/8	Cushion Clamp – 1-1/8"	EA	10
538-1-3/8	Cushion Clamp – 1-3/8"	EA	10
538-1-5/8	Cushion Clamp – 1-5/8"	EA	10
538-2-1/8	Cushion Clamp – 2-1/8"	EA	10
538-2-5/8	Cushion Clamp – 2-5/8"	EA	10
538-3-1/8	Cushion Clamp – 3-1/8"	EA	10
538-3-5/8	Cushion Clamp – 3-5/8"	EA	10
538-4-1/8	Cushion Clamp – 4-1/8"	EA	10

Liquid Line Driers

High moisture and acid capacity. Maximum filtration capacity. Exceptional compatibility with new polyester oils. Compatible with all existing and new refrigerants and blends including 134a, 401A/B, 402A/B, 404A, 407A/B/C, 410A, 502, 507A. Spring loaded, molecular sieve XH-9 dessicant. Solid copper sweat fittings. Powder paint exterior coating surpasses 500 hour ASTM salt spray test and resists corrosion. Eliminates concern of additive stripping.



Suction Line Driers

The solid-core clean-up dryer was developed for use in a system suction line. The compact design incorporates a large outside diameter shell, which results in a shorter lay-in length, and a larger core, which provides a greater filtration area for maximum operating efficiency. The core material has controlled porosity which effectively removes and holds a maximum amount of contaminants with a minimum of pressure drop. It collects and holds inorganic acids and other harmful contaminants from a motor burnout. This binding process protects the core from acid decomposition. Access valves on both the inlet and outlet sides make it easy to measure pressure accurately. Occasionally, enough contaminant matter may collect in the filter core to cause a slight pressure drop. The access valves on the SLD make it easy to determine if a pressure drop exists and to measure the amount of the drop. The original DSLD, solid core, XH-9 molecular sieve dessicant suction line filter dryer. High acid capacity. Low pressure drop – exceptionally high flow rates. Designed for system clean-up. 500 hours salt spray protection. Shortest system cut-out lengths allow installation in tight areas. Two access valves simplify pressure drop measurement. Flare or solid copper sweat fittings.



CATALOG NO.	VIRGINIA KMP	CONNECTION	CUBIC INCH	UOM	ORDER MULTIPLE
DAD032	WLD-032 FLARE	1/4	3	EA	1
DAD032S	WLD-032 SWEAT	1/4	3	EA	1
DAD052	WLD-052 FLARE	1/4	5	EA	1
DAD052S	WLD-052 SWEAT	1/4	5	EA	1
DAD053S	WLD-053 SWEAT	3/8	5	EA	1
DAD082	WLD-082 FLARE	1/4	8	EA	1
DAD082S	WLD-082 SWEAT	1/4	8	EA	1
DAD083S	WLD-083 SWEAT	3/8	8	EA	1
DAD084S	WLD-084 SWEAT	1/2	8	EA	1
DAD163	WLD-163 FLARE	3/8	16	EA	1
DAD163S	WLD-163 SWEAT	3/8	16	EA	1
DAD164S	WLD-164 SWEAT	1/2	16	EA	1
DAD303	WLD303 FLARE	3/8	30	EA	1
DAD303S	WLD-303 SWEAT	3/8	30	EA	1
DAD304S	WLD-304 SWEAT	1/2	30	EA	1
DAD305	WLD-305 FLARE	5/8	30	EA	1
DAD305S	WLD-305 SWEAT	5/8	30	EA	1

CATALOG NO.	VIRGINIA KMP	CONNECTION	CUBIC INCH	UOM	ORDER MULTIPLE
DSL13-5SVHH	AL-24-55C Sweat	5/8	13	EA	1
DSL13-6SVHH	AL-30-6SC Sweat	3/4	13	EA	1
DSL27-7SVHH	AL-30-7SC Sweat	7/8	27	EA	1
DSL27-9SVHH	AL-44-9SC Sweat	1-1/8	27	EA	1
DSL54-11SVHH	AL-75-11SC Sweat	1-3/8	54	EA	1
DSS-SLD306SV	VSD-6 & S Sweat	3/4	30	EA	1
DSS-SLD307SV	VSD-7 & S Sweat	7/8	30	EA	1

Universal Spun Copper Driers

Manufactured with the latest generation molecular sieves compatible with more than 20 different types of refrigerants, including R-134A. They can be used in all hermetic and open refrigeration systems using CFC, HCFC and HFC gases and mixes such as commercial and domestic refrigerators, freezers and air conditioners ranging from 1/8 to 2.0 HP. Hermetically sealed with extended ends.

CATALOG NO.	OUTLET	INLET	DIAMETER	LENGTH GRAMS	DESSICANT R12	RECOMM. R22	TONNAGE QUANTITY	UOM	ORDER MULTIPLE
DX-3	1/4"	1/4"	3/4"	7-11/16"	10	1/3	1/2	EA	24
DX-4	Multiple	1/4"	1"	9"	18	3/4	1-1/2	EA	1
DXA-5	1/4"	1/4"	1"	9-1/4"	20	3/4	1-1/2	EA	1



REFRIGERANT TUBING cont'd

White Pipe™

White Pipe pre-insulated refrigerant line is ideal for a variety of installation jobs and works for every air conditioning application including ductless mini-split, heat pump and centralized air ducted units. Available in a variety of sizes and lengths.



CATALOG NO.	DESCRIPTION	UOM	ORDER MULTIPLE
WP1214-50	White Pipe, 1/4 x 1/2 in x 50 ft	EA	13
WP1238-50	White Pipe, 3/8 x 1/2 in x 50 ft	EA	11
WP1212-50	White Pipe, 1/2 x 1/2 in x 50 ft	EA	10
WP1258-50	White Pipe, 5/8 x 1/2 in x 50 ft	EA	7
WP1234-50	White Pipe, 3/4 x 1/2 in x 50 ft	EA	5
WP1278-50	White Pipe, 7/8 x 1/2 in x 50 ft	EA	5
WP1214-164	White Pipe, 1/4 x 1/2 in x 164 ft	EA	5
WP1238-164	White Pipe, 3/8 x 1/2 in x 164 ft	EA	4
WP1212-164	White Pipe, 1/2 x 1/2 in x 164 ft	EA	4
WP1258-164	White Pipe, 5/8 x 1/2 in x 164 ft	EA	3
WP1234-82	White Pipe, 3/4 x 1/2 in x 82 ft	EA	3
WP1278-82	White Pipe, 7/8 x 1/2 in x 82 ft	EA	3

Flexible Refrigerant Line

Flexible Refrigerant Line, with installed flare nut, allows a kink-free connection from the mini-split wall unit to the lineset for easier and faster installation.



CATALOG NO.	DESCRIPTION	UOM	ORDER MULTIPLE
FRL14-F	Flexible Refrigerant Line – 1/4 in. x 36"	EA	15
FRL38-F	Flexible Refrigerant Line – 3/8 in. x 36"	EA	14
FRL12-F	Flexible Refrigerant Line – 1/2 in. x 36"	EA	11
FRL58-F	Flexible Refrigerant Line – 5/8 in. x 36"	EA	10

REVERSING VALVES

Reversing Valves

The DiversiTech line of 4-Way Reversing Valves are optimally designed as drop in replacements for the most popular heat pump applications. See the cross reference chart for Sanhua and Ranco Crosses. Solenoid Coils sold separately.



CATALOG NO.	DESCRIPTION	UOM	ORDER MULTIPLE
DRV2-408060-170	4-Way Reversing Valve 3/8" x 1/2" 2 Tons	EA	1
DRV2-408060-270	4-Way Reversing Valve 3/8" x 1/2" 2 Tons U	EA	1
DRV3-410080-770	4-Way Reversing Valve 1/2" x 5/8" 3 Tons	EA	1
DRV3-412080-870	4-Way Reversing Valve 1/2" x 5/8" 3 Tons	EA	1
DRV6-412080-170	4-Way Reversing Valve 1/2" x 3/4" 5 Tons	EA	1
DRV6-414080-170	4-Way Reversing Valve 1/2" x 7/8" 5 Tons	EA	1
DRV6-414120-170	4-Way Reversing Valve 3/4" x 7/8" 5 Tons	EA	1
DRV10-414120-170	4-Way Reversing Valve 3/4" x 7/8" 10 Tons	EA	1
DRV10-414080-170	4-Way Reversing Valve 1/2" x 7/8" 10 Tons	EA	1
DRV10-418140-170	4-Way Reversing Valve 7/8" x 1-1/8" 10 Tons	EA	1
SHF-4-10FA4	24 Volt Solenoid Coil	EA	1
SHF-4-10FA2	120 Volt Solenoid Coil	EA	1
SHF-4-10FA5	220 Volt Solenoid Coil	EA	1

DiversiTech Line Sets

DiversiTech Line Sets are individually packaged in sturdy corrugated cardboard, designed and tested for individual parcel shipment.

Line Sets are designed for air conditioning and refrigeration systems. The copper tube is refrigeration grade tubing to ASTM B280. The suction line is pre-insulated with Armaflex AP pipe insulation. This insulation is a black flexible elastomeric thermal insulation. The expanded closed-cell structure makes it an efficient insulation. It is manufactured without the use of CFC's, HFC's or HCFC's. AP Armaflex contains Microban® antimicrobial product protection for added defense against mold on the

insulation. DiversiTech Min-Split Line Sets are similar to Standard Line Sets but come with additional insulation on the liquid line and flared line ends. Copper tubing complies with ASTM B280 for Seamless Copper Tube for ACR.

AP Armaflex insulation meets ASTM C534, Type I – Tubular Grade 1, ASTM E84, NFPA 255, UL723, CAN/ULC S102, UL94 5V-5A, V-0 (E55798), NFPA 90A/90B, UL181, ASTM G21/C1338, ASTM G22, ASTM D1056 2B1, MIL-P-15280J form T, MIL-C-3133C grade SBE3, MEA 96-85-M, and City of LA RR7642.



D40680250B3B6

STANDARD LINE SETS

CATALOG NO.	LENGTH (FT)	INSULATION WALL	SUCTION LINE	LIQUID LINE	UOM	ORDER MULTIPLE
D61220250	25	1/2	3/4	3/8	EA	1
D61220300	30	1/2	3/4	3/8	EA	1
D61220350	35	1/2	3/4	3/8	EA	1
D61220400	40	1/2	3/4	3/8	EA	1
D61220500	50	1/2	3/4	3/8	EA	1
D61230250	25	3/4	3/4	3/8	EA	1
D61230300	30	3/4	3/4	3/8	EA	1
D61230350	35	3/4	3/4	3/8	EA	1
D61230400	40	3/4	3/4	3/8	EA	1
D61230500	50	3/4	3/4	3/8	EA	1
D61280250	25	3/8	3/4	3/8	EA	1
D61280300	30	3/8	3/4	3/8	EA	1
D61280350	35	3/8	3/4	3/8	EA	1
D61280400	40	3/8	3/4	3/8	EA	1
D61280500	50	3/8	3/4	3/8	EA	1
D61420250	25	1/2	7/8	3/8	EA	1
D61420300	30	1/2	7/8	3/8	EA	1
D61420350	35	1/2	7/8	3/8	EA	1
D61420400	40	1/2	7/8	3/8	EA	1
D61420500	50	1/2	7/8	3/8	EA	1
D61430250	25	3/4	7/8	3/8	EA	1
D61430300	30	3/4	7/8	3/8	EA	1
D61430350	35	3/4	7/8	3/8	EA	1
D61430400	40	3/4	7/8	3/8	EA	1
D61430500	50	3/4	7/8	3/8	EA	1
D61480250	25	3/8	7/8	3/8	EA	1
D61480300	30	3/8	7/8	3/8	EA	1
D61480350	35	3/8	7/8	3/8	EA	1
D61480400	40	3/8	7/8	3/8	EA	1
D61480500	50	3/8	7/8	3/8	EA	1
D61820250	25	3/8	1-1/8	1/2	EA	1
D61820500	50	3/8	1-1/8	1/2	EA	1
D61830250	25	3/4	1-1/8	3/8	EA	1
D61830300	30	3/4	1-1/8	3/8	EA	1
D61830350	35	3/4	1-1/8	3/8	EA	1
D61830400	40	3/4	1-1/8	3/8	EA	1
D61830500	50	3/4	1-1/8	3/8	EA	1
D61880250	25	3/8	1-1/8	3/8	EA	1
D61880300	30	3/8	1-1/8	3/8	EA	1
D61880350	35	3/8	1-1/8	3/8	EA	1
D61880400	40	3/8	1-1/8	3/8	EA	1
D61880500	50	3/8	1-1/8	3/8	EA	1

MINI-SPLIT LINE SETS

CATALOG NO.	LENGTH (FT)	INSULATION WALL	SUCTION LINE	LIQUID LINE	UOM	ORDER MULTIPLE
D40680250B3B6	25	3/8	3/8	1/4	EA	1
D40680350B3B6	35	3/8	3/8	1/4	EA	1
D40680500B3B6	50	3/8	3/8	1/4	EA	1
D40880250B3B6	25	3/8	1/2	1/4	EA	1
D40880350B3B6	35	3/8	1/2	1/4	EA	1
D40880500B3B6	50	3/8	1/2	1/4	EA	1
D41080250B3B6	25	3/8	5/8	1/4	EA	1
D41080350B3B6	35	3/8	5/8	1/4	EA	1
D41080500B3B6	50	3/8	5/8	1/4	EA	1
D61080250B3B6	25	3/8	5/8	3/8	EA	1
D61080350B3B6	35	3/8	5/8	3/8	EA	1
D61080500B3B6	50	3/8	5/8	3/8	EA	1
D40620250B3B6	25	1/2	3/8	1/4	EA	1
D40620350B3B6	35	1/2	3/8	1/4	EA	1
D40620500B3B6	50	1/2	3/8	1/4	EA	1
D40820250B3B6	25	1/2	1/2	1/4	EA	1
D40820350B3B6	35	1/2	1/2	1/4	EA	1
D40820500B3B6	50	1/2	1/2	1/4	EA	1
D41020250B3B6	25	1/2	5/8	1/4	EA	1
D41020350B3B6	35	1/2	5/8	1/4	EA	1
D41020500B3B6	50	1/2	5/8	1/4	EA	1
D61020250B3B6	25	1/2	5/8	3/8	EA	1
D61020350B3B6	35	1/2	5/8	3/8	EA	1
D61020500B3B6	50	1/2	5/8	3/8	EA	1

If ordering by pallet, 15 line sets are packed per pallet.

REFRIGERANT TUBING cont'd

White Pipe™

White Pipe pre-insulated refrigerant line is ideal for a variety of installation jobs and works for every air conditioning application including ductless mini-split, heat pump and centralized air ducted units. Available in a variety of sizes and lengths.



CATALOG NO.	DESCRIPTION	UOM	ORDER MULTIPLE
WP1214-50	White Pipe, 1/4 x 1/2 in x 50 ft	EA	13
WP1238-50	White Pipe, 3/8 x 1/2 in x 50 ft	EA	11
WP1212-50	White Pipe, 1/2 x 1/2 in x 50 ft	EA	10
WP1258-50	White Pipe, 5/8 x 1/2 in x 50 ft	EA	7
WP1234-50	White Pipe, 3/4 x 1/2 in x 50 ft	EA	5
WP1278-50	White Pipe, 7/8 x 1/2 in x 50 ft	EA	5
WP1214-164	White Pipe, 1/4 x 1/2 in x 164 ft	EA	5
WP1238-164	White Pipe, 3/8 x 1/2 in x 164 ft	EA	4
WP1212-164	White Pipe, 1/2 x 1/2 in x 164 ft	EA	4
WP1258-164	White Pipe, 5/8 x 1/2 in x 164 ft	EA	3
WP1234-82	White Pipe, 3/4 x 1/2 in x 82 ft	EA	3
WP1278-82	White Pipe, 7/8 x 1/2 in x 82 ft	EA	3

Flexible Refrigerant Line

Flexible Refrigerant Line, with installed flare nut, allows a kink-free connection from the mini-split wall unit to the lineset for easier and faster installation.



CATALOG NO.	DESCRIPTION	UOM	ORDER MULTIPLE
FRL14-F	Flexible Refrigerant Line – 1/4 in. x 36"	EA	5
FRL38-F	Flexible Refrigerant Line – 3/8 in. x 36"	EA	5
FRL12-F	Flexible Refrigerant Line – 1/2 in. x 36"	EA	5
FRL58-F	Flexible Refrigerant Line – 5/8 in. x 36"	EA	5

REVERSING VALVES

Reversing Valves

The DiversiTech line of 4-Way Reversing Valves are optimally designed as drop in replacements for the most popular heat pump applications. See the cross reference chart for Sanhua and Ranco Crosses. Solenoid Coils sold separately.



CATALOG NO.	DESCRIPTION	UOM	ORDER MULTIPLE
DRV2-408060-170	4-Way Reversing Valve 3/8" x 1/2" 2 Tons	EA	1
DRV2-408060-270	4-Way Reversing Valve 3/8" x 1/2" 2 Tons U	EA	1
DRV3-410080-770	4-Way Reversing Valve 1/2" x 5/8" 3 Tons	EA	1
DRV3-412080-870	4-Way Reversing Valve 1/2" x 5/8" 3 Tons	EA	1
DRV6-412080-170	4-Way Reversing Valve 1/2" x 3/4" 5 Tons	EA	1
DRV6-414080-170	4-Way Reversing Valve 1/2" x 7/8" 5 Tons	EA	1
DRV6-414120-170	4-Way Reversing Valve 3/4" x 7/8" 5 Tons	EA	1
DRV10-414120-170	4-Way Reversing Valve 3/4" x 7/8" 10 Tons	EA	1
DRV10-414080-170	4-Way Reversing Valve 1/2" x 7/8" 10 Tons	EA	1
DRV10-418140-170	4-Way Reversing Valve 7/8" x 1-1/8" 10 Tons	EA	1
SHF-4-10FA4	24 Volt Solenoid Coil	EA	1
SHF-4-10FA2	120 Volt Solenoid Coil	EA	1
SHF-4-10FA5	220 Volt Solenoid Coil	EA	1

REFRIGERANT LABELS

DiversiTech Refrigerant ID Labels

These 3" x 4" self-adhesive vinyl labels use a high-tack acrylic adhesive and UV cured screen printing. Color coded to conform to refrigerant labeling convention. Each label indicates the type of refrigerant (eg. R-11), the chemical name (eg. Trichloromonofluoromethane) and the UN No. (eg. UN 1078). Avoid costly mistakes by properly identifying the type of refrigerant contained in recovery cylinders and air conditioning and refrigeration equipment.



DiversiTech Refrigerant ID Labels (cont'd)

CATALOG NO.	DESCRIPTION	UOM	ORDER MULTIPLE
SYSTEM REFRIGERANT/OIL LABELS (3" x 4")			
04850	Refrigerant Removed Labels, pack of 10	PK	1
SYSTEM LUBRICANT IDENTIFICATION LABELS (2" x 3")			
04871	Mineral Oil Labels, pack of 10	PK	1
04872	Alkylbenzine Oil Labels, pack of 10	PK	1

CATALOG NO.	DESCRIPTION	UOM	ORDER MULTIPLE
REFRIGERANT IDENTIFICATION LABELS (3" x 4")			
04010	R-408A (FX10) Refrigerant ID Labels, pack of 10	PK	1
04011	R-11 Refrigerant ID Labels, pack of 10	PK	1
04012	R-12 Refrigerant ID Labels, pack of 10	PK	1
04022	R-22 Refrigerant ID Labels, pack of 10	PK	1
04134	R-134a Refrigerant ID Labels, pack of 10	PK	1
04402	R-402A (HP80) Refrigerant ID Labels, pack of 10	PK	1
04404	R-404A (HP62/FX70) Refrigerant ID Labels, pack of 10	PK	1
04407	R-407C (SUVA 9000/KLEA 66) Refrigerant ID Labels, pack of 10	PK	1
04410	R-410A (AZ20) Refrigerant ID Labels, pack of 10	PK	1
04421	R-421A Refrigerant ID Labels, pack of 10	PK	1
04451	R-401B (MP66) Refrigerant ID Labels, pack of 10	PK	1
04500	R-500 Refrigerant ID Labels, pack of 10	PK	1
04507	R-507 (AZ50) Refrigerant ID Labels, pack of 10	PK	1

REFRIGERANT RECOVERY PRODUCTS

Refrigerant Recovery Cylinders

DOT Classified for recovery, recycling, service and reclaim. Liquid and vapor valves ("Y" valve or separate valve configurations) are installed in all cylinders. Painted yellow/gray per ARI guidelines. Float switches have 3-pin Brad Harrison connectors.

CATALOG NO.	DESCRIPTION	DOT CLASS	3/4" NPT PLUG	FLOAT SWITCH	WATER CAP.	TARE WT.	UOM	ORDER MULTIPLE
02033	30 lb.	4BA400	YES	NO	26.2 lbs.	17 lbs.	EA	1
02053	50 lb.	4BA400	YES	NO	47.7 lbs.	28 lbs.	EA	1
02100	100 lb.	4BW400	NO	NO	123 lbs.	48 lbs.	EA	1
02255	250 lb.	4BW260	YES	NO	239 lbs.	85 lbs.	EA	1



Caution: Never overfill cylinders. Maximum refrigerant capacity is limited to 80% of the water capacity of the cylinder in lbs. (see table above). DOT requires cylinders to be retested every five years. Some recovery equipment uses weight scales to cut off refrigerant fill at 80% of capacity. Be sure cylinder tare weight is correct for this type of equipment.

DOT Classification Example: 4BA400: 400 psi working pressure; 800 psi test pressure (double the working pressure); 1,600 psi minimum burst pressure (double the test pressure). Pressure relief/safety valve is set to release at between 75-100% of the test pressure. For example, in the 4BA400 tanks which have a 800 psi test pressure, the relief valve opens at between 600 psi and 800 psi.

SENTRY REFRIGERANT LOCKING CAPS

Sentry™ Refrigerant Locking Caps - R-410, Red, 1/4"

The Sentry™ Refrigerant Locking Caps are quick and easy way to comply with the IRC and IMC codes requirement that all outdoor access ports on A/C and refrigerant equipment have to be tamper resistant. This cap is anodized in red color for easy identification of R-410 refrigerant. It is designed for 1/4" access ports. An O-ring seal is also pre-installed to prevent leaks.

RSC-RED-02



CATALOG NO.	DESCRIPTION	UOM	ORDER MULTIPLE
RSC-RED-02	Sentry™ Refrigerant Locking Caps - 1/4", Red, 2 pcs Pack w/ Universal Key	PK	1
RSC-RED-04K	Sentry™ Refrigerant Locking Caps - 1/4", Red, 4 pcs Pack w/ Universal Key	PK	1
RSC-RED-10	Sentry™ Refrigerant Locking Caps - 1/4", Red, 10 pcs Pack	PK	1
RSC-RED-50K	Sentry™ Refrigerant Locking Caps - 1/4", Red, 50 pcs Pack w/ Universal Keys	PK	1

Sentry™ Refrigerant Locking Caps - R-410, Red, 5/16"

The Sentry™ Refrigerant Locking Caps are quick and easy way to comply with the IRC and IMC codes requirement that all outdoor access ports on A/C and refrigerant equipment have to be tamper resistant. This cap is anodized in red color for easy identification of R-410 refrigerant. It is designed for 5/16" access ports typically used on mini-splits and European styles of A/C systems. An O-ring seal is also pre-installed to prevent leaks.

RSC-RED-02-E



CATALOG NO.	DESCRIPTION	UOM	ORDER MULTIPLE
RSC-RED-02-E	Sentry™ Refrigerant Locking Caps - 5/16", Red, 2 pcs Pack w/ Universal Key	PK	1
RSC-RED-04K-E	Sentry™ Refrigerant Locking Caps - 5/16", Red, 4 pcs Pack w/ Universal Key	PK	1
RSC-RED-10-E	Sentry™ Refrigerant Locking Caps - 5/16", Red, 10 pcs Pack	PK	1
RSC-RED-50K-E	Sentry™ Refrigerant Locking Caps - 5/16", Red, 50 pcs Pack w/ Universal Keys	PK	1

Sentry™ Universal Key for Refrigerant Locking Caps

This Universal Key is not only for DiversiTech's Sentry™ Refrigerant Locking Caps. It has three different keys that is fit to lock and unlock most of the refrigerant locking caps in the market. It is compact and easy to carry. This is the key contractors needed to get the job done!

RSC-TOOL



CATALOG NO.	DESCRIPTION	UOM	ORDER MULTIPLE
RSC-TOOL	Universal Key for Refrigerant Locking Caps	EA	1

Sentry™ Refrigerant Locking Caps - R-22, Green, 1/4"

The Sentry™ Refrigerant Locking Caps are quick and easy way to comply with the IRC and IMC codes requirement that all outdoor access ports on A/C and refrigerant equipment have to be tamper resistant. This cap is anodized in green color for easy identification of R-22 refrigerant. It is designed for 1/4" access ports. An O-ring seal is also pre-installed to prevent leaks.

RSC-GRN-02



CATALOG NO.	DESCRIPTION	UOM	ORDER MULTIPLE
RSC-GRN-02	Sentry™ Refrigerant Locking Caps - 1/4", Green, 2 pcs Pack w/ Universal Key	PK	1
RSC-GRN-04K	Sentry™ Refrigerant Locking Caps - 1/4", Green, 4 pcs Pack w/ Universal Key	PK	1
RSC-GRN-10	Sentry™ Refrigerant Locking Caps - 1/4", Green, 10 pcs Pack	PK	1
RSC-GRN-50K	Sentry™ Refrigerant Locking Caps - 1/4", Green, 50 pcs Pack w/ Universal Keys	PK	1

Sentry™ Refrigerant Locking Caps - Universal, Silver, 1/4"

The Sentry™ Refrigerant Locking Caps are quick and easy way to comply with the IRC and IMC codes requirement that all outdoor access ports on A/C and refrigerant equipment have to be tamper resistant. This cap is anodized in silver color and could be used on different types of refrigerants. It is designed for 1/4" access ports. An O-ring seal is also pre-installed to prevent leaks.

RSC-SLV-02



CATALOG NO.	DESCRIPTION	UOM	ORDER MULTIPLE
RSC-SLV-02	Sentry™ Refrigerant Locking Caps - 1/4", Silver, 2 pcs Pack w/ Universal Key	PK	1
RSC-SLV-04K	Sentry™ Refrigerant Locking Caps - 1/4", Silver, 4 pcs Pack w/ Universal Key	PK	1
RSC-SLV-10	Sentry™ Refrigerant Locking Caps - 1/4", Silver, 10 pcs Pack	PK	1
RSC-SLV-50K	Sentry™ Refrigerant Locking Caps - 1/4", Silver, 50 pcs Pack w/ Universal Keys	PK	1
RSC-SLV-500	Sentry™ Refrigerant Locking Caps - 1/4", Silver, 500 pcs Pack	PK	1



Tubing Insulation

Highest quality tubing insulation by Armacell. AC Accoflex® tubing insulation is a flexible rubber product from the inventors of elastomeric foam insulation. It is designed exclusively for HVAC, with a tough surface and excellent resistance to ultraviolet damage, condensation and mold.



3/8" WALL

CATALOG NO.	DESCRIPTION	UOM	ORDER MULTIPLE
7-3838	3/8" ID x 3/8" Wall, pack of 600'	PK	1
7-3812	1/2" ID x 3/8" Wall, pack of 480'	PK	1
7-3858	5/8" ID x 3/8" Wall, pack of 390'	PK	1
7-3834	3/4" ID x 3/8" Wall, pack of 330'	PK	1
7-3878	7/8" ID x 3/8" Wall, pack of 270'	PK	1
7-381-18	1-1/8" ID x 3/8" Wall, pack of 210'	PK	1
7-381-38	1-3/8" ID x 3/8" Wall, pack of 180'	PK	1
7-381-58	1-5/8" ID x 3/8" Wall, pack of 120'	PK	1
7-382-18	2-1/8" ID x 3/8" Wall, pack of 96'	PK	1
7-382-58	2-5/8" ID x 3/8" Wall, pack of 72'	PK	1

1/2" WALL

CATALOG NO.	DESCRIPTION	UOM	ORDER MULTIPLE
7-1238	3/8" ID x 1/2" Wall, pack of 450'	PK	1
7-1212	1/2" ID x 1/2" Wall, pack of 396'	PK	1
7-1258	5/8" ID x 1/2" Wall, pack of 300'	PK	1
7-1234	3/4" ID x 1/2" Wall, pack of 240'	PK	1
7-1278	7/8" ID x 1/2" Wall, pack of 210'	PK	1
7-121-18	1-1/8" ID x 1/2" Wall, pack of 150'	PK	1
7-121-38	1-3/8" ID x 1/2" Wall, pack of 120'	PK	1
7-121-58	1-5/8" ID x 1/2" Wall, pack of 90'	PK	1
7-122-18	2-1/8" ID x 1/2" Wall, pack of 60'	PK	1
7-122-58	2-5/8" ID x 1/2" Wall, pack of 60'	PK	1
7-123-18	3-1/8" ID x 1/2" Wall, pack of 42'	PK	1

3/4" WALL

CATALOG NO.	DESCRIPTION	UOM	ORDER MULTIPLE
7-3438	3/8" ID x 3/4" Wall, pack of 240'	PK	1
7-3412	1/2" ID x 3/4" Wall, pack of 210'	PK	1
7-3458	5/8" ID x 3/4" Wall, pack of 144'	PK	1
7-3434	3/4" ID x 3/4" Wall, pack of 138'	PK	1
7-3478	7/8" ID x 3/4" Wall, pack of 120'	PK	1
7-341-18	1-1/8" ID x 3/4" Wall, pack of 90'	PK	1
7-341-58	1-5/8" ID x 3/4" Wall, pack of 60'	PK	1
7-342-18	2-1/8" ID x 3/4" Wall, pack of 54'	PK	1
7-342-58	2-5/8" ID x 3/4" Wall, pack of 48'	PK	1

1" WALL

CATALOG NO.	DESCRIPTION	UOM	ORDER MULTIPLE
7-1058	5/8" ID x 1" Wall, pack of 120'	PK	1
7-1078	7/8" ID x 1" Wall, pack of 90'	PK	1

Triple-D®

Universal Coil Cleaner

Triple-D is a Universal Coil Cleaner suitable for use on condenser and evaporator coils. It is metal safe and does not attack aluminum or copper coil components, extending equipment life and diminishing potential for refrigerant leaks. Triple-D is a safer, more versatile product than conventional acid or non-acid coil cleaners.

All of the organic materials in this product are readily biodegradable

BIODEGRADABLE



- Metal Safe
- Biodegradable
- Super Concentrated
- Inhibited Non-Acid Formulation
- Available in Multiple Packages/Forms
- Non-Foaming / Non-Toxic
- Safe for Rubber Roofs
- Corrosion Inhibited
- NSF Registered



One product does it all - truly a Universal Coil Cleaner

DISTRIBUTOR SUPPORT

D
I
S
T
R
I
B
U
T
O
R

S
U
P
P
O
R
T



LITERATURE

Catalogs

CATALOG NO.	DESCRIPTION	STANDARD PACK
LIT-CAT-CD	HVAC Catalog on CD	10
LIT-CAT-HVAC	Issue 21 Catalog	10
LIT-CAT-NEW	New Products Catalog	10
LIT-CAT-SEAL	Cliplight® Catalog	10
LIT-CAT-QS	Quick-Sling® Catalog	10

Tri-Folds

Each DiversiTech tri-fold brochure has a specific product focus. The tri-folds can be used as counter handouts, or mailed to a contractor. Brochure holders are also available. Most tri-folds are 8-1/2" high by 3-5/8" wide.

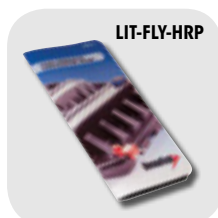

CATALOG NO.	DESCRIPTION	STANDARD PACK
LIT-FLY-3D	Triple-D™ Brochure	25
LIT-FLY-3D-S	Triple-D™ Brochure (Spanish)	25
LIT-FLY-BPPOOL	The Black Pad® Brochure	25
LIT-FLY-CDLC	Condensate Drain Line Cleaners Brochure	25
LIT-FLY-CLAD	CladLite® Pad Brochure	25
LIT-FLY-CLRVUE	ClearVue™ Pump Brochure	25
LIT-FLY-COND	Condensate Monitoring Switches Brochure	25
LIT-FLY-CS1200	CS1200 A/C Shutoff Brochure	25
LIT-FLY-CVKUBE	ClearVueKube™ Pump Brochure	25
LIT-FLY-CVKUBE-S	ClearVueKube™ Pump Brochure (Spanish)	25
LIT-FLY-CVMINI	ClearVue™ Mini Pump Brochure	25
LIT-FLY-CVMINI-S	ClearVue™ Mini Pump Brochure (Spanish)	25
LIT-FLY-DISC	Fusible Disconnect Brochure	25
LIT-FLY-DST10	Hard Start Kit Brochure	25
LIT-FLY-DTP3	Three Phase Motor Protector Brochure	25
LIT-FLY-DTP3ES	Three Phase Motor Protector Brochure (Spanish)	25
LIT-FLY-ELITE	E Lite® Pad Brochure	25
LIT-FLY-ET	A/C Easy Tee® Brochure	25
LIT-FLY-FLEX	Flex Inject® Brochure	25
LIT-FLY-FLOW	Flow Plus™ Brochure	25
LIT-FLY-FOOT	Hef-T-Foot™ Brochure	25
LIT-FLY-GG	Drain Gun Brochure	25
LIT-FLY-HEAT	Heat Pump Pad™ Brochure	25
LIT-FLY-HEF	Hef-T-Pad Brochure	25
LIT-FLY-HPAD	Hurricane Pad Brochure	25
LIT-FLY-HRP	High Rise Pan™ Brochure	25
LIT-FLY-HSI	Universal Hot Surface Igniter Brochure	25
LIT-FLY-MDP	Metal Drain Pan Brochure	25
LIT-FLY-MOTORS	Motor Brochure	25
LIT-FLY-MSPLIT	SpeediChannel™ Brochure	25
LIT-FLY-PF	Pro-Flush Brochure	25
LIT-FLY-PF-S	Pro-Flush Brochure (Spanish)	25
LIT-FLY-PUMP	Condensate Pump Brochure	25
LIT-FLY-QS	Quick-Sling® Brochure	25
LIT-FLY-RSC	Sentry™ Refrigerant Locking Caps Brochure	25
LIT-FLY-SEAL	Cliplight® Brochure	25
LIT-FLY-SPRAYER	Power Sprayer Brochure	25
LIT-FLY-SPRAYER-S	Power Sprayer Brochure (Spanish)	25
LIT-FLY-UC	UltraLite® Pad Brochure	25
LIT-FLY-UCSTRAP	UltraLite® Earthquake Pad Brochure	25
LIT-FLY-UV	Pure-Beam™ UV Light Brochure	25
LIT-FLY-VENTS	Vent Termination Kits Brochure	25
LIT-FLY-WS	Wet Switch® Brochure	25

Literature Holders

CATALOG NO.	DESCRIPTION	STANDARD PACK
MKT-POP-BROCH	Brochure Holder w/DiversiTech Logo Imprinted	1
MKT-POP-BROCH4	4-Pocket Brochure Holder	1
MKT-POP-EASEL	Acrylic Tri-Fold Brochure Holder	1

Samples/Demos



CATALOG NO.	DESCRIPTION	STANDARD PACK
6-HK2748-SAM	High Rise Pan – 27" x 48"	1
6-M3030-SAM	Metal Drain Pan – 30" x 30"	1
6-P3030L-SAM	Molded Drain Pan – 30" x 30" w/hole	1
MKT-POP-DUCTSAM	SpeediChannel Rep Sample Kit (Duct & Flat Elbow)	1
MKT-POP-WSDEMO	Wet Switch Demo Kit	1
MKT-SAM-ELEC	Sample Packet for Electrical	1
MKT-SAM-HSI	Sample Kit for TrueStart Hot Surface Igniters	1

Posters

CATALOG NO.	DESCRIPTION	STANDARD PACK
MKT-POSTER-CLRVUE	ClearVue™ Pump Poster	1
MKT-POSTER-HPAD	The Hurricane Pad poster	1
MKT-POSTER-MSPLIT	SpeediChannel™ Parts Poster	1
MKT-BANNER	Diversitech Vinyl Banner 2' x 5'	1

**P.O.P. Merchandisers/
Displays**

CATALOG NO.	DESCRIPTION	STANDARD PACK
MKT-MERCH-USACAPS	Merchandising kit for USA Capacitors	1
MKT-MERCH-CHEM	Chemical Display for Gondola	1
MKT-MERCH-FLEX	Flex-Inject® Counter Display	1
MKT-MERCH-RSC	Sentry™ Wall Display	1
MKT-MERCH-SEAL12	Super Seal Display	12
MKT-MERCH-SEAL30	Super Seal Display	30
MKT-POP-CHEM	DiversiTech/Specialty Chemical Display 26" base x 73" height	1
MKT-POP-CLRGOND	ClearVue™ Pump Display for Gondola	1
MKT-POP-CLRSHELF	ClearVue™ Pump Shelf Talker	1
MKT-POP-CLRSTAND	ClearVue™ Pump Banner Stand	1
MKT-POP-CP22	CP22 Pump Gondola Display	1
MKT-POP-CVTUBE	ClearVueTube Display	1
MKT-POP-DEVBACKS	DEVCO Background Graphics for pegboard	Set of 2
MKT-POP-DEVBACKSSLAT	DEVCO Background Graphics for Slatwall	
MKT-POP-DEVCOMBO	DEVCO Display Rack – Combo	1
MKT-POP-DEVELEC	DEVCO Display Rack – Electrical	1
MKT-POP-DEVEZC	DEVCO Display Rack – EZC	1
MKT-POP-DTBACKS	DiversiTech Background Graphics for pegboard	Set of 2
MKT-POP-DTBACKSSLAT	Diversitech Background Graphics for Slatwall	1
MKT-POP-DUCT	SpeediChannel Merchandising Display	1
MKT-POP-HSI	Merchandiser Display for TrueStart Hot Surface Igniters	1
MKT-POP-PF	Pro-Flush Display	1
MKT-POP-WS	Wet Switch Counter Display	1
MKT-POP-CDLC	Condensate Drain Line Cleaner Display	1
MKT-POP-ET	A/C Easy Tee Merchandiser	1



MKT-POP-CHEM

MKT-POP-DEVCOMBO

MKT-POP-DEVELEC

MKT-POP-DEVEZC

U.S. GENERAL TERMS AND CONDITIONS**General Policy****WE ARE COMMITTED TO DO WHAT IT TAKES TO DELIVER WORLD CLASS SERVICE AND PRODUCTS.**

All items not ordered in multiples of standard package quantities will automatically be increased to the next standard package quantity. All purchase orders submitted by our customers are assumed as accepting our general terms and conditions as stated herein, any conflicting terms stated on the purchase order cannot supersede our terms.

Order Discrepancies:

All order discrepancies must be reported to us within 5 working days from the date of delivery. Any discrepancies reported after this period cannot be honored.

Terms:

1% 15 days. Net 30 days. Late charges of 1-1/2% per month will be charged following the due date of the invoice. Prices subject to change without notice.

Minimum Order:

\$100.00 minimum order on all original orders. \$15.00 Broken Pallet Charge will be added for each pad size less than the standard pallet quantities.

Freight Policy

CONTINENTAL U.S.: All orders in excess of \$2,000 will ship prepaid. This policy applies to any combination of DiversiTech, Wagner, Specialty Chemical, and Devco products.

Pick Up Allowance

3% of net invoice, 24-hour notice requested. Order must qualify for prepaid freight to receive pick up allowance.

Lost or Damaged Freight

Although we take special care to insure the safe arrival of your merchandise, our responsibility for damages cease when the customer accepts the shipment. To protect your interest, we suggest that you thoroughly inspect all items before accepting delivery. If your order was damaged in shipment or contains a shortage, report the loss or damage AT ONCE to DiversiTech. Any claims for lost or damaged freight must be noted on the Bill of Lading at the time of delivery. If damage is present, you MUST hold the original carton and merchandise for credit by your Sales Representative – otherwise, no claim can be honored.

Returns:

No merchandise will be accepted for return without prior authorization. Call our Customer Service Department to request permission to return goods. Instructions on method of return will be given to you at that time. All returns are subject to a 25% restocking charge.

Warranty Disclaimer

DiversiTech has made a diligent effort to illustrate and describe the products in this catalog accurately; however, such illustrations and descriptions are for the sole purpose of identification, and do not express or imply a warranty that the products are merchantable or fit for a particular purpose, or that the products will necessarily conform to the illustrations or descriptions. DiversiTech assumes no liability for typographical or photographic errors.

DiversiTech reserves the right to make changes in design, material or finish in an effort to improve our products without special notification. If necessary, DiversiTech reserves the right to replace any product shown in catalog with another comparable product without special notification. All DiversiTech products include a 1 year standard limited warranty unless otherwise noted.

DiversiTech's ULTRALITE®, CLADLITE®, and E LITE® Limited Lifetime Warranty

To the original owner of the ULTRALITE®, CLADLITE®, or E LITE® equipment base, DiversiTech warrants the base to be free of defects in materials and workmanship for the life of the equipment under which it is installed so long as the installing homeowner lives there. All defective merchandise must be returned to the factory, transportation prepaid, and if the same is found to be defective, it will be repaired or replaced free of charge, F.O.B. factory. This warranty does not cover replacement labor cost, or any cost claim incident to the defect, replacement, or reinstallation, nor field repair expenses. This warranty gives you specific legal rights and you may also have other rights which vary from state to state. Some states do not allow the exclusion or limitation of incidental or consequential damages, so the above limitation of exclusion may not apply to you.

Exclusions and Limitations

DiversiTech's ULTRALITE®, CLADLITE®, and E LITE® equipment pads are designed and manufactured to be used as bases for light, ground supported equipment such as air conditioning condensers, swimming pool filters and heat pumps. Use of ULTRALITE®, CLADLITE®, and E LITE® pads for purposes other than those listed above or improper installation of ULTRALITE®, CLADLITE®, and E LITE® pads may result in pad failure. DiversiTech Corporation disclaims any liability due to such misuse or improper installation. If you have questions concerning the proper installation or use of DiversiTech's ULTRALITE®, CLADLITE®, and E LITE® equipment pads, you should contact our Customer Service Department at (800)995-2222.

Made in the U.S.A.

All item numbers in RED indicate Made in the U.S.A. This information was accurate at time of catalog printing. Visit www.diversitech.com to verify country of origin for any DiversiTech product.

DOMESTIC CREDIT APPLICATION

COMPANY NAME: _____	For internal use only CUSTOMER #: _____
----------------------------	---

SHIP TO _____ **PHONE #** _____
ADDRESS _____ **FAX #** _____
CITY/STATE _____ **ZIP CODE** _____
E-MAIL _____

BILL TO _____
NAME _____ **PHONE #** _____
ADDRESS _____ **FAX #** _____
CITY/STATE _____ **ZIP CODE** _____
E-MAIL _____

PRINCIPALS**BUYING GROUP MEMBER**

BUSINESS STRUCTURE*: CORPORATION _____ PARTNERSHIP _____ INDIVIDUAL _____ *Please check one
CREDIT LIMIT REQUESTED _____ **DUNS #** _____
ESTIMATED SALES VOLUME _____ **FEDERAL TAX ID #** _____
YEARS IN BUSINESS _____

BANK REFERENCE

NAME _____ **PHONE #** _____
ADDRESS _____ **OFFICER** _____
CITY/STATE _____ **ZIP CODE** _____
ACCOUNT # _____

THREE MAJOR TRADE REFERENCES (U.S. based are preferred)

NAME _____ **TITLE** _____
CONTACT _____ **PHONE #** _____
CITY/STATE/ZIP _____ **FAX #** _____
E-MAIL _____ **ACCOUNT NUMBER** _____

NAME _____ **TITLE** _____
CONTACT _____ **PHONE #** _____
CITY/STATE/ZIP _____ **FAX #** _____
E-MAIL _____ **ACCOUNT NUMBER** _____

NAME _____ **TITLE** _____
CONTACT _____ **PHONE #** _____
CITY/STATE/ZIP _____ **FAX #** _____
E-MAIL _____ **ACCOUNT NUMBER** _____

CATEGORY INDEX

007 Control Checker.....	177	Adjustable Delay on Break Time	154	Braided Vinyl Tubing.....	81
2-in-1 Copper Tube Cleaning Brush	170	Adjustable Delay on Make Timer	154	Brass Adapters.....	236
3/4™ Rubber Elbow.....	193	Adjustable Equipment Risers..	30	Brass Fittings.....	238-240
3-36® Multi-Purpose Lubricant	88	Adjustable Flat Bend.....	201	Brushes.....	169-171
45 Degree Ell	52	Aerosols.....	84	Bubble-N-Trouble™ Leak Detector	225
45 Degree Ell C x C	233	Air Handler Base - Heavy Duty Adjustable	33	Bug Spray	94
45 Degree Flat Bend.....	201	Air Handler Blocks	30	Bulbs	111
45 Degree Street Ell Ftg. x C.	234	All Purpose Cleaning Pads	84	Bushing	52
45 Elbows	190	All Purpose Enamel	88	Bushing (MIPT x FIPT)	186
45 Ell (Slip x Slip).....	191	All Purpose Lubricant.....	88	Bushings and Locknuts	114
4-Piece Hook and Pick Set ...	177	All Purpose Sprayers.....	223	Butt Connector Assortment Kit .	105
6180 Series Terminal Blocks	124	All Weather PVC Cement.....	188	Butt Connectors – Insulated .	104
6190 Series Terminal Blocks	124	Allen Wrenches	169	BX and Greenfield Connectors	112
90 Degree Ell	52	All-Purpose Clear Cement ...	188	BX Set Screw Connectors	145
90 Degree Ell C x C	233	Aluminum Armored MC Cable	145	Cable Connectors.....	112
90 Degree Flat Bend.....	201	Aluminum Dryer Vent Hoods, Kits, and Fittings	40	Cable Markers	126
90 Degree Inside Elbow.....	202	Aluminum Foil Tape	42	Cable Staples.....	145
90 Degree Long Radius Bend	202	Aluminum Solderless Lugs...	125	Cable Tie Assortment Pack ...	164
90 Degree Long Turn Ell C x C.....	234	Anchor Kit	93	Cable Tie Mounts.....	113
90 Degree Long Turn Street Ell Ftg. x C.....	233	Anchors	108-109	Cable Ties and Accessories ..	113
90 Degree Outside Elbow ...	202	Angle Iron Brackets.....	32	Canopy Strap	181
90 Degree Street Ell	52	Anti-Vibration Pads	24	Canvas Drop Cloths	86
90 Degree Street Ell Ftg. x C.	233	Armored Connector	122	Cap.....	234
90 Elbow (Hub x Hub)	190	Armored Plug	122	Cap (FIPT)	193
90 Ell (Slip x FIPT)	191	Aviation Snips.....	180	Cap (Slip)	192
90 Ell (Slip x Slip).....	191	Batteries.....	85	Capacitors.....	146-147
90 Ell Reducing (Slip x FIPT)	191	Bearings.....	142	Carabiners	181
90 Ell Reducing (Slip x Slip).	191	Bi Flow Driers	242	Carbon Monoxide & Smoke Alarms	49
90 Street Ell (MIPT x Slip).....	191	Big Helper™ - PVC Pipe Cutter.	184	Carbon Steel Curved Handle Scratch Brush.....	170
90 Street Ell (SPIG x Slip).....	191	Bi-Metal Reciprocating Saw Blades.....	179	Carton Sealing Tape.....	85
A/C Brackets.....	32	Black Jack Roof Cement	93	Carton Tape Dispenser.....	85
A/C Condensate Drain Pan Fittings.....	80	Black Nylon Cable Tie Assortment.....	113	Catalogs	250
A/C Easy Tee.....	78	Black Nylon Ties with Mounting Hole.....	165	Caulk Gun.....	92
A/C Riser Blocks	30	Black Nylon Wire Ties....	165, 204	Caulking Sealant	92
A/C Secondary Condensate Drain Pans	79	Black Steel Welded Nipples....	51	CBC II Contact Cleaner	84
Abrasive Cloths.....	84	Blade Auto Fuses	120	Channellock® Products	172
Access Fittings	235	Blind Rivet Tools.....	115	Channels	201
Accessories.....	221	Boiler Bracket	31	Chip Brushes.....	169
Acid Eliminator™	230	Boiler Pump	76	Chlor-Free® Degreaser	86
Acid Test Kits	229	Box Cover Units	154	Circuit Breakers	157
Acrylic Latex Painter's Caulk ...	92	Boxes, Rings, and Covers .	110-111	Citrus Degreaser.....	86
Adapter (Insert x Slip)	193			CladLite® Pads.....	20
Additives	230			Clean Out Tee.....	193

ClearVue™ Pump	76	Brushes.....	171	Digital Single Phase Line Voltage Monitor	155
ClearVue™ Traps	78	Conduit Fittings	114	Digital Three Phase Line Voltage Monitor	155
ClearVue™ Tube & Traps	78	Conduit Nipples.....	114	Digital UL Listed Multimeter..	176
Clipboards.....	172	Conduit, Fittings, Cable .	144-145	Direct Drive Furnace Blower Motors	139
Clipboards and Form Holders	172	Contact Cleaners.....	85-86	Direct Replacement Igniters ...	48
Cliplight Extends.....	174	Contacto Accessories.....	151	Disconnect Switches.....	143
Clip-On Zoom Light.....	174	Contactors	150-151	Disconnects - Metal Case ...	143
Clips	120	Cool Weld™ Heat Barrier Spray	221	Disconnects - Non-Metallic Case	143
Clipstrip™/Clipstrip 2™	174	236	DiversiGum™ Sealing Compound	92
Clipstrip™ Aqua	174	Cop Cap™ Locking Valve Cover	236	Diversitech Flexible Conduit .	144
Cloth Duct Tape	44	235	Diversitech Line Sets.....	243
CO ₂ Cylinders	168	Copper Coupling with Dimple Stop.....	235	DiversiTech® Gas Connectors .	50
CO ₂ Detectors.....	49	Copper Coupling with No Stop.....	235	DiversiTech® Refrigerant ID Labels.....	245
Coil Cleaners.....	220-221	Copper Fittings	233-235	DiversiTech® Three Pole Definite Purpose Contactors	150
Coil Cleaning Aerosols.....	222	Copper Saddle Valve.....	237	DiversiTech® Two Pole Definite Purpose Contactors	150
Coil Guard™	221	Copper Tube Fitting Brushes. .	170	DiversiWhips	142
Combination CO & Smoke Alarms	49	Core Removal Tool	237	DiversiWhips for the Swimming Pool Industry	142
Combination Couplings	112	Core Storer.....	237	DiversiWhips Pallet Packs.....	142
Combination Packs.....	103	Cork Insulation Tape	82	DiversiWhips with Extended Length Wires	143
Combination Screwdrivers ...	179	Cotter Pins	118	Dormont 20 Series	50
Combo Head Sheet Metal Screws	117	Coupling	52	Dormont 20 Series with Valve	51
Compartmented Storage Boxes.....	159	Coupling (Slip x Slip).....	192	Dormont 30 Series	50
Compression Connector	238	Coupling (Socket) with Rolled Tube Stop C x C	234	Dormont Gas Valves and Connectors	50-51
Compression Elbow	238	Couplings (Hub x Hub)	190	Drain Dawg™ and Drain Kat™ Fittings.....	79
Compression Nut.....	238	CP-22 Low Profile Pumps	76	Drain Gun and Cartridges	78
Compression Sleeve	238	CP-22 Pumps	76	Drain Gun™	78
Compression Sprayers	224	CP-MINI-L pump	77	Drain Line, Tubing	81
Compression Tee	238	CPVC-CTS Pipe and Fittings..	186	Drain Pan Disinfectant, Sealant	222
Compression Union	238	CPVC-CTS Pipe by FlowGuard® Gold™	186	Drain Pans	80
Compressor Lead Kit.....	103	Cross (Slip x Slip x Slip x Slip)	192	Drain Trap Kits	78
Compressor Repair Kit	159	192	DrainDawg™	78
Compressor TOTE.....	176	CS1200 AC Shutoff Switch	77	DrainKat™	78
Concentric Vents	49	Cushion Clamps.....	240	Driers, Sight Glasses	241-242
Condensate Cop™	77	Cushioned Pillow Blocks	142	Drive Fasteners.....	108
Condensate Drain Line Cleaning	78-79	Cutting Oil.....	88	Drop Cloths	86
Condensate Drain Line Switches	77	Cylinder Valves	168		
Condensate Drain Pans	81	D'Scale™ Acid Scale Remover	229		
Condensate Drain Pans, Fittings, Adapters	79-81	Definite Purpose Contactors. .	150		
Condensate Pumps	76-77	Degreasers.....	86		
Condenser Equipment Mounting	32	Deluxe Hi-Tension Hacksaw ..	179		
Condenser Fan Motors.....	138	Devco® Crimpers	115		
Condenser/Heat Exchanger		Devco® Plastic Anchor Kits ...	109		
		Device Rings	110		
		Dial-a-Mix Sprayer	224		

Drop-In Expansion Anchor Setting Tool.....	108	Electrical Toggle Switches	156	Flare x MIP Elbow	238
Drop-In Expansion Anchors ..	108	Electrolytic Copper Solderless Lugs.....	126	Flare x MIP Reducing Elbow .	238
Dry R.....	230	Electronic Degreaser	87	Flare x MIP Union	239
Dryer Duct, Vent Hose, Hose Clamps	40-41	EMT (Thinwall) Fittings.....	145	Flash UV Dye.....	225
Dryer Hose Clamps	41	Epoxy Coated Gas Connectors	50	Flashlights and Lanterns By Rayovac	173
Dryer Vent Hose.....	40	Equipment Stands	33-34	Flat Wall Escutcheon	203
Dual Element Fuses	120	EVA Anti-Vibration Pad	24	Flat Washers	116
Duct Cleaning Brush.....	170	Evergreen® ECM Motors.....	141	Flex Duct Tape	42
Duct End.....	203	Expando Adjustable Condenser Tube Cleaner	177	Flex Inject®.....	226
Duct Fans.....	39	Extension Cords.....	172	Flex Joint	203
Duct Strap - Metallic - Roll	41	Extension Rings	110	Flexible Refrigerant Line.....	244
Duct Strap, Ties, Clamps	41-42	Extension Rods for Condenser Tube Brushes.....	171	Flexi-Patch™	91
Duct Tape	42	Fan Centers.....	152	Flow Plus™ Condensate Pan Treatment.....	227
Duct-Fresh Gel	227	Fasco® 3.3in Walk-In Cooler/Freezer Refrigeration Motors	141	Flowmeters	168
Duct-Fresh Spray	227	Fast Cure Epoxy.....	91	Flue Caps.....	39
Dust Masks	90	Fast Orange® Hand Cleaner ...	86	Flush Bushing.....	235
DWV Bend Fittings.....	190	Felt Tip Markers	89	Flushing Products.....	223
DWV Bushings.....	190	Female Adapter (Barb x FIPT)	186	Foam Insulation Tape.....	82
DWV Vent Tee	190	Female Adapter (Slip x FIPT)	192	Foam Sealant - One Component	91
E Life® Pads	19	Female Adapter C x F.....	233	Foam Sealant - Two Component	92
Eaton Circuit Breakers, Type BR	157	Female Adapter Elbow (Barb x FIPT).....	187	Foam-Plus™ Aerosol Foaming Coil Cleaner	222
Eaton Circuit Breakers, Type CH	157	Female Adapter Reducing (Slip x FIPT).....	192	Foil Scrim Kraft Tape	42
Eaton Contactor Accessories	151	Fender Washers	116	Fully Insulated Dead End Connectors	104
Eaton Definite Purpose Contactors - One and Two Pole.....	150	Fin Tools	173	Fully Insulated Female Slip-Ons	102
Eaton Definite Purpose Contactors - Three and Four Pole.....	150	Fin Whisk	171	Fully Insulated Flag Female Slip-Ons	103
Eaton Electrical Disconnects	144	Finished Hex Nuts.....	115	Fully Insulated Male Slip-Ons	102
Eaton Switch A/C Disconnect	144	Fin-Tool	173	Fully Insulated Receptacles..	103
Eaton Three Phase Disconnects	144	Firestop Products for Class A Buildings.....	92	Furnace Mounting Blocks.....	30
Eco-Coil™ Environ. Friendly Coil Cleaner	220	First Aid Kits.....	90	Furnace Pans	80
Economy Electrical Tape	158	Fitting Reducer Coupling Ftg. x C.....	234	Furnace Pump.....	76
EcoPad™	23	Fittings.....	201-204	Fuse Adapters.....	154
Egg Crate Louvers - Air Return	39	Flag Disconnects.....	103	Fuse Holders	154
Elbow (Barb x Barb).....	186	Flag Female Compressor Terminal Kit	103	Fuse Pullers	154
Elbow (FIPT x FIPT).....	187	Flag Female Compressor Terminals	103	Fuseblocks	154
Electrical Duplex Receptacles	155	Flame Sensor	49	Fuses.....	153-154
Electrical Outlet Boxes, Extentions and Covers	156	Flare Tee.....	239	Fusible Links	160
Electrical Staples	114	Flare Union	239	Garden Hose	224
Electrical Supplies	156-158	Flare x FIP Union.....	240	Garden Hose Adapters	186
Electrical Tapes.....	158	Flare x Flare Swivel Union	240	Gas Ball Valve.....	50

Gauges.....	175	Heavy Duty High Rise Pans	80	Incandescent Light Bulbs	111
General Purpose Pumps	76	Heavy Duty Nylon Cable Ties	113	Incandescent Light Bulbs	111
General Purpose Relays.....	152	Heavy Duty PVC Cement	188	Indicator Lights.....	125
General Purpose Spray Paint..	89	Heavy Duty Silicone Mold		Industrial Enamel	89
General Purpose Switching		Release.....	88	Industrial Towels	87
Relays.....	152	Heavy Duty Work Gloves	90	In-Line Fuse Holder.....	154
General Tools	115	Hef-T-Block™	30	Insta-Charge.....	242
Genteq® Direct Drive Furnace		Hef-T-Brackets™	31	Insta-Tap Refrigerant Recovery	
Blower Motors	140	Hef-T-Foot™	31	Tool.....	237
Genteq® High Temperature		Hef-T-Pad™	22	Insulated Butt Connectors	104
Condenser Fan Motors.....	140	HEMImini™	174	Insulated Female Slip-Ons ...	102
Genteq® Multiple Horsepower		HEMIPLUS™2	174	Insulated Flange Spades.....	105
Condenser Fan Motors.....	140	Hex Head Cap Screws.....	116	Insulated Hooks.....	104
Genteq® Multiple Horsepower		HF™ Contact Cleaner	85	Insulated Male Slip-Ons	102
Furnace Blower Motors	141	High Heat Spray Paint	89	Insulated Plugs.....	103
Genteq® Single Speed Condenser		High Rise Pans™	80	Insulated Rings.....	105
Fan Motors.....	139	High Temp Red Silicone		Insulated Spades.....	105
Geocel Caulking Sealant	92	Sealant	92	Insulated Spring Spades	105
Glass Cleaner.....	84	High Temperature Assortment ..	106	Iso-Cube Economy Anti-Vibration	
Glass Cloth, Economy Electrical		High Temperature Butt Connectors		Pad.....	24
Tapes	158	106	J-B Weld	91
Gloves.....	90	High Temperature Female Slip-Ons		Kimberly-Clark Waterless Hand	
Glycols.....	222-223	106	Wipes	86
Gorilla Tube™ Clear Vinyl Tubing		High Temperature Flag Female		Kimtex® Towels	87
.....	81	Slip-Ons	106	Knock'er Loose® Penetrating	
Grease Fittings	119	High Temperature Male Slip-Ons		Solvent.....	87
Grip-Cut™	84	106	Knockout Seals and Hole	
Grommets - Vinyl	159	High Temperature Rings	106	Plug.....	114
Ground Adapter.....	122	High Temperature Solderless		Kut-All Plastic Tube and Hose	
Ground Fitting Clamp.....	126	Terminals	106	Cutter.....	183
Grounding Rubber Handle		High Temperature Spades	106	Lashing Strap	180
Plug.....	121	High Temperature Wire.....	163	Latex Gloves.....	90
Hand Cleaners	86	Horizontal Refrigerator/Freezer		Leak Detectors & Accessories	
Hanging Brackets	36	Analog Therm.....	183	225-226
Hanging Strap	181	Horizontal Vent Term Kits.....	49	Leak Test Gauge	182
Hanging Wire	41	Hose Clamps.....	118	Leather Work Gloves.....	90
Hard Start Kits	149	Hose Mender (Barb x Barb)..	187	LED Screwdriver Continuity	
Heat Pump Pad™	23	Hoses	168	Tester.....	182
Heat Pump Risers	30	Hoses, Sprayers	224	Line Piercing Valves and	
Heat Resistant Cloth	184	Hot Surface Igniters	48	Tools.....	237
Heat Shrink Tubing.....	124	Hot Water Hose	224	Liquid Line Driers.....	241
Heat Shrink Tubing - Polyolefin		Hurricane Pad™	23	Liquid Tite Connectors.....	112
50% Shrink.....	159	Hurricane Pad™ Attachment		Liquid Tite Connectors.....	144
Heat Shrink Tubing Assortments		Bracket.....	21	Literature.....	250
.....	124	HVAC Tools	180	Literature Holders	250
Heavy Duty Bracket.....	31	Hydroguage Manometer	175	Little Helper™ - All Purpose Cutter	
Heavy Duty Cable Ties.....	41, 164	Ice Machine Products	225	183
Heavy Duty Degreaser	86	Icemaker Kit	194	Louvered Dryer Vent Hood	42
Heavy Duty Degreaser II.....	86	Igniters.....	48		

Rubber Tie Down Strap.....	181	Sheet Metal Screw Assortments	117	Steel Thermostat Guards	161
Safety Plates	111	Sheet Metal Screws	93-94	Steel Utility Boxes	110
Safety Supplies, Devices	90	Sheet Metal Screws Drill Point	94	Stick-E-Tape.....	42
Saf-N-Kleen™ Aerosol Solvent Coil Cleaner.....	222	Sheet Metal Screws Taper Point.....	94	Sting Less Wasp & Hornet Killer	94
Samples/Demos	250	Shoe Covers.....	90	Storage Containers.....	119
Sani C-N-D™ Coil and Drain Pan Disinfectant.....	222	Shop Towels	87	Stove Bolts	116
Satchel Style Case.....	119	Short Forged Flare Nut.....	239	Stranded Copper THHN Wire	162-163
Saws and Saw Blades.....	179	Short Nut	239	Stranded Copper Wire on Spool	163
Scotch 35 Vinyl Electrical Tape	158	Side Flange Mount Pillow Blocks	142	Stranded Copper Wire, 194° F.	162
Scotch 3M Super 33+ Electrical Tape.....	158	Sight Glasses	242	Stranded High Temperature Wire	121
Scotch 3M Super 88 Electrical Tape.....	158	Silicone Sealant	92	Strapping Hanger Iron.....	41
Scotch® Electrical Tapes.....	158	Single Piece Liquid Tite Fittings	144	Straps	114
Screwdrivers, Driver Sets	179	SJTO Service Cord	121	Straps, Truck Rope.....	180-181
Screwloose® Industrial Penetrating Oil	87	Slip-On Solderless Terminals	102-103	Styrene Parts Boxes	119
Screws	93-94, 117	Smoke Detectors	49	Suction Line Driers	241
Sealant, Epoxy, Glue	91	Smokeys	39	Super Change	223
Sealing Compounds, Adhesive	91-93	Snips, Notchers, Crimpers, Seamers	180	Super Glue.....	91
Seal-N-Go® Self-Sealing Refrigerant	226	Soffit Fitting	201	Super Seal Flex-Inject®	226
SeekerMax™	226	SP-400™ Corrosion Inhibitor... ..	88	Super Stands.....	34
SeekerMini™	225	Spade Terminals	105	SuperComb.....	173
Self Tapping Water Valve	194	Spark Electrode	49	Super-Kool™ Ice Machine Cleaner	225
Self-Drilling Gypsum Wallboard Anchors	108	Special Purpose Solderless Terminals	103-104	Supports	194
Self-Drilling Screw Repair Kit	117	Specialty Fasteners.....	118	Sure Shot	226
Self-Drilling Screws.....	117	Specialty Fittings	119	Sure-Stick Heavy Duty Adhesive	84
Semi-Rigid Aluminum Duct	40	SpeediChannel™	201	Sweat-Free Pipe Insulation Spray	84
Sentry Refrigerant Locking Caps	246	SpeediChannel™ Accessories .	204	Switch Covers.....	157
Sentry Refrigerant Locking Caps R-22, Green, 1/4"	246	SpeediChannel™ Kits	204	Switch/Plug Combo	157
Sentry Refrigerant Locking Caps R-410, Red, 1/4"	246	SpeediChannel™ Line Set Cover System.....	201	Swivel Head Deburring Tool..	184
Sentry Refrigerant Locking Caps R-410, Red, 5/16"	246	SpeediChannel™ Line Set Cover System.....	201	System Cleaners.....	229
Sentry Refrigerant Locking Caps Universal, Silver, 1/4"	246	Split Bolt Connectors	126	T-50 Series Staples and Staple Guns.....	176
Sentry Universal Key for Refrigerant Locking Caps.....	246	Spotlight	175	Tab Adapters - Male Tabs.....	104
Sequencers.....	160	Sprayers.....	224	Tab Adapters - Piggy Back Slip-Ons	104
Set Screws	118	Standard Line Sets.....	243	Tab Adapters - Quick Disconnect with Screw	104
Sheet Metal Screw Assortment Kit	93	Standard Solderless Terminals	104-105	Tab Adapters - Single Fem Dbl Male Tabs.....	104
		Standard Wire Connectors ...	125	Tandem Grounding Rubber Handle	122
		Staples.....	145	Tap Connectors	104
		Sta-Plex™ Premium Red Grease	88	Tapes	42, 82, 119
		Steel 1900 Boxes	110		
		Steel 1900 Covers.....	111		
		Steel Octagon Box	110		

Pro-Air Industrial Grade Spray Adhesive	93	Pro-Weld™ PVC Cement (Pool and Turf - Blue)	189	Reach-It	178
Pro-Blue™	220	Pro-Weld™ PVC Cement (Regular Body)	189	Receptacles	123
Pro-Brown™	220	Pro-Weld™ PVC Cement (Universal)	189	Reducer Bushing (SPIG X FIPT)	193
Pro-Bubble™ Leak Detector... ..	225	Pro-Weld™ Weather - ALL.....	189	Reducer Bushing (SPIG x Slip)	193
Pro-Flush® Accessories	223	Pro-Yellow™	221	Reducer Coupling.....	203
Pro-Flush® HVAC Flushing Solvent.....	223	PTFE Tape	82	Reducer Coupling w/Stop C x C	234
Pro-Green™	220	P-Traps	235	Reducing Coupling	52
Pro-Kleen™	221	Pull-A-Spout Oiler	88	Reducing Tee.....	52
Pro-Lube-ALK™ Alkylbenzene.	228	Pump Parts & Accessories	76	Reducing Tee C x C x C	235
Pro-Lube-POE™ Polyolester	229	Pumps	76-77	Reducing Washers.....	114
Pro-Lube™ Mineral Oil	228	Pure-Beam™ Ultraviolet Light..	40	Refractometer.....	178
Pro-Lube-VAC™ Vacuum Pump Oil	230	Purple Primer for PVC Pipe and Fittings	188	Refrigerant Charging.....	242
Pro-Prime™ Clear PVC Primer	189	PVC Cement - Clear.....	188	Refrigerant Labels.....	245
Pro-Prime™ PVC Primer (Purple)	189	PVC Condensate Pipe	190	Refrigerant Recovery Cylinders	245
Pro-Red Plus™	221	PVC Condensate Pipe - White	190	Refrigerant Recovery Products	245
ProTek BG™ for Cast Iron Water Boilers	223	PVC DWV Fittings.....	190	Refrigerant Safety Caps.....	246
ProTek EG™	222	PVC Gray Cement for High Efficiency Furnaces, Vent and Make-up Air	188	Refrigerant Tubing.....	243-244
ProTek™ Closed Loop Heat Transfer Fluid.....	222	PVC Primer - Clear.....	188	Refrigeration Oils.....	228-229
ProTek™ PG 100	222	PVC Primer and Cement	189	Refrigerator Coil Brush	169
ProTek™ PG Plus	223	PVC Schedule 40 Pressure Fittings.....	191-193	Refrigerator/Freezer Analog Thermometer.....	183
Pro-Thaw™ Liquid Dryer for Refrigerants.....	230	QD® Contact Cleaner.....	85	Regulators.....	168
PRO-TITE™ Resin Based Thread Sealant	230	Quick Heat Pump Stand.....	32	Rehvac Nitrogen Purging Equipment	168
Pro-Treat® 151 Premium Condensate Drain Pan Treatment	228	Quick Stand	33	Rehvac Refillable Gas Cylinders	168
Pro-Treat® 152 King-Size Premium Condensate Drain Pan Treatment	228	Quick Swivel "U" Mount.....	36	Relays.....	152
Pro-Treat® 161 Condensate Drain Pan Treatment	228	Quick Swivel Flush Mount w/"H" Bracket.....	36	Replacement Compressor Leads	159
Pro-Treat® 200 Economy Condensate Drain Pan Treatment	228	Quick Swivel Flush Mount w/"I" Bracket.....	36	Replacement Element Kits ...	160
Pro-Treat® 217 Economy Condensate Drain Pan Treatment	228	Quick-Sling®	36	Rheem Motor Bracket	142
Pro-Treat® 350 Condensate Drain Pan Treatment	227	Quick-Sling® Accessories	36	Right Angle Plug	122
Pro-Treat® Pan Strips	227	Quick-Tap	237	Rigid Conduit Bodies	112
Pro-Weld™ PVC Cement (Heavy Body).....	189	Quick-Tap-2	237	Romex Connectors - Metallic	145
		Radiant Leak Finder™	225	Roof Flashing	39
		Rain-R-Shine Blue Cement ...	188	Roof Inlets.....	204
		Ratchet Strap	181	Roof Louver	39
		Rayovac Industrial Flashlights and Lanterns	173	Rope.....	180
		Rayovac Industrial Max Alkaline Batteries.....	85	Rough Service Light Bulbs....	172
		Rayovac Lantern Batteries.....	85	Round Extension Cords.....	117
		Rayovac LED Flashlights	173	Rubber / Cork Anti-Vibration Pad	24
				Rubber Anti-Vibration Pad	24
				Rubber Connector	122

Rubber Tie Down Strap.....	181	Sheet Metal Screw Assortments	117	Steel Thermostat Guards	161
Safety Plates	111	Sheet Metal Screws	93-94	Steel Utility Boxes	110
Safety Supplies, Devices	90	Sheet Metal Screws Drill Point	94	Stick-E-Tape.....	44
Saf-N-Kleen™ Aerosol Solvent Coil Cleaner.....	222	Sheet Metal Screws Taper Point.....	94	Sting Less Wasp & Hornet Killer	94
Samples/Demos	250	Shoe Covers.....	90	Storage Containers.....	119
Sani C-N-D™ Coil and Drain Pan Disinfectant.....	222	Shop Towels	87	Stove Bolts	116
Satchel Style Case.....	119	Short Forged Flare Nut.....	239	Stranded Copper THHN Wire	162-163
Saws and Saw Blades.....	179	Short Nut	239	Stranded Copper Wire on Spool	163
Scotch 35 Vinyl Electrical Tape	158	Side Flange Mount Pillow Blocks	142	Stranded Copper Wire, 194° F.	162
Scotch 3M Super 33+ Electrical Tape.....	158	Sight Glasses	242	Stranded High Temperature Wire	121
Scotch 3M Super 88 Electrical Tape.....	158	Silicone Sealant	92	Strapping Hanger Iron.....	41
Scotch® Electrical Tapes.....	158	Single Piece Liquid Tite Fittings	144	Straps	114
Screwdrivers, Driver Sets	179	SJTO Service Cord	121	Straps, Truck Rope.....	180-181
Screwloose® Industrial Penetrating Oil	87	Slip-On Solderless Terminals	102-103	Styrene Parts Boxes	119
Screws	93-94, 117	Smoke Detectors	49	Suction Line Driers	241
Sealant, Epoxy, Glue	91	Smokeys	39	Super Change	223
Sealing Compounds, Adhesive	91-93	Snips, Notchers, Crimpers, Seamers	180	Super Glue.....	91
Seal-N-Go® Self-Sealing Refrigerant	226	Soffit Fitting	201	Super Seal Flex-Inject®	226
SeekerMax™	226	SP-400™ Corrosion Inhibitor... ..	88	Super Stands.....	34
SeekerMini™	225	Spade Terminals	105	SuperComb.....	173
Self Tapping Water Valve	194	Spark Electrode	49	Super-Kool™ Ice Machine Cleaner	225
Self-Drilling Gypsum Wallboard Anchors	108	Special Purpose Solderless Terminals	103-104	Supports	194
Self-Drilling Screw Repair Kit	117	Specialty Fasteners.....	118	Sure Shot	226
Self-Drilling Screws.....	117	Specialty Fittings	119	Sure-Stick Heavy Duty Adhesive	84
Semi-Rigid Aluminum Duct	40	SpeediChannel™	201	Sweat-Free Pipe Insulation Spray	84
Sentry Refrigerant Locking Caps	246	SpeediChannel™ Accessories .	204	Switch Covers.....	157
Sentry Refrigerant Locking Caps R-22, Green, 1/4"	246	SpeediChannel™ Kits	204	Switch/Plug Combo	157
Sentry Refrigerant Locking Caps R-410, Red, 1/4"	246	SpeediChannel™ Line Set Cover System.....	201	Swivel Head Deburring Tool..	184
Sentry Refrigerant Locking Caps R-410, Red, 5/16"	246	Split Bolt Connectors	126	System Cleaners.....	229
Sentry Refrigerant Locking Caps Universal, Silver, 1/4"	246	Spotlight	175	T-50 Series Staples and Staple Guns.....	176
Sentry Universal Key for Refrigerant Locking Caps.....	246	Sprayers.....	224	Tab Adapters - Male Tabs.....	104
Sequencers.....	160	Standard Line Sets.....	243	Tab Adapters - Piggy Back Slip-Ons	104
Set Screws	118	Standard Solderless Terminals	104-105	Tab Adapters - Quick Disconnect with Screw	104
Sheet Metal Screw Assortment Kit	93	Standard Wire Connectors ...	125	Tab Adapters - Single Fem Dbl Male Tabs.....	104
Sheet Metal Screw Assortments	117	Staples.....	145	Tandem Grounding Rubber Handle	122
Sheet Metal Screws	93-94	Sta-Plex™ Premium Red Grease	88	Tap Connectors	104
Sheet Metal Screws Drill Point	94	Steel 1900 Boxes	110	Tapes	42, 82, 119
Sheet Metal Screws Taper Point.....	94	Steel 1900 Covers.....	111		
Shoe Covers.....	90	Steel Octagon Box	110		
Shop Towels	87				
Short Forged Flare Nut.....	239				
Short Nut	239				
Side Flange Mount Pillow Blocks	142				
Sight Glasses	242				
Silicone Sealant	92				
Single Piece Liquid Tite Fittings	144				
SJTO Service Cord	121				
Slip-On Solderless Terminals	102-103				
Smoke Detectors	49				
Smokeys	39				
Snips, Notchers, Crimpers, Seamers	180				
Soffit Fitting	201				
SP-400™ Corrosion Inhibitor... ..	88				
Spade Terminals	105				
Spark Electrode	49				
Special Purpose Solderless Terminals	103-104				
Specialty Fasteners.....	118				
Specialty Fittings	119				
SpeediChannel™	201				
SpeediChannel™ Accessories .	204				
SpeediChannel™ Kits	204				
SpeediChannel™ Line Set Cover System.....	201				
Split Bolt Connectors	126				
Spotlight	175				
Sprayers.....	224				
Standard Line Sets.....	243				
Standard Solderless Terminals	104-105				
Standard Wire Connectors ...	125				
Staples.....	145				
Sta-Plex™ Premium Red Grease	88				
Steel 1900 Boxes	110				
Steel 1900 Covers.....	111				
Steel Octagon Box	110				

Tattle-Tale Control Monitor.....	177	Combo Device.....	123	Versa Cap® Flue and Hot Stack 39
Tee.....	52	Toggle Switches.....	123, 158	Vinyl Grommet Assortment	Packs..... 124
Tee (Barb x Barb x Barb)	187	Tongue and Groove Pliers	172	Vinyl Grommets.....	124
Tee (Slip x FIPT x Slip).....	191	Torches	184	Wagner® Adhesive Sealant	91
Tee (Slip x Slip x Slip)	191	Torque Plus - Hard Start Kits .	149	Wagner® Direct Drive Furnace	Blower Motors
Tee C x C x C.....	235	Transformers	151 139	
Teflon Tape	119	Transformers - Class 2.....	151	Wagner® High Temperature	Condenser Fan Motors.....
Telescopic Inspection Mirror.	177	Transparent Plastic Boxes with	 138	
Teri® Towels	87	Terminal Asst.....	159	Wagner® Multiple Horsepower	Condenser Fan Motors.....
Terminal Block Jumpers.....	124	Traps	191 138	
Terminal Kits.....	107	Tri-Fold Brochures	250	Wagner® Multiple Horsepower	Furnace Blower Motors
Terminals, Connectors.....	159	Triple Outlets	122 139	
Terry Towels	87	Triple-D™ Universal Coil Cleaner 220	Wagner® Singe Speed Condenser	Fan Motors.....
Test Cord (Female)	182	Trouble Lights.....	117 138	
Test Kits, Strips, and Prevent .	229	Truck Rope	180	Wall Escutcheon.....	203
Test Leads	181-182	TrueStart® Ignition Accessories 48-49	Wall Penetration.....	201
Testers	120, 182 48-49		Wasp, Hornet, and Yellow Jacket	Killers.....
Testers, Leads, Clips, Fuses ...	120	Truestart® Pilot Burners	48 94	
TFFN Stranded Hook-Up Wire.	120	Tube Working Tools	183-184	Water Heater Pans.....	80
The Black Pad®.....	22	Tubing Insulation	247	Waterless Hand Wipes	86
The Hurricane Pad™	21	Tubing, Clamps, and Kits	194	Waterproof Box with Lever Switch	Cover
The Hurricane Pad™ Bracket...	21	Type "S" Non-Tamper Fuses..	153 111	
The Hurricane Pad™ MD.....	21	Type 2 Wall Brackets.....	31	Waterproof Covers.....	111
The Hurricane T-Class Pad™	21	Type 3 Wall Brackets.....	31	WD-40®	88
The Purifier™.....	227	UL Listed Foil Tape	42	Weatherproof Boxes	111
Thermal Controls	160	Ultra Lite 3-36® Lubricant.....	88	Welder's Brush	169
Thermometers	183	UltraLite® Earthquake Pads....	19	Welding Torches, Supplies....	184
Thermometers/Probes.....	183	Ultralite® Lightweight Concrete	Equipment Pads	Wellington ECM Refrigeration	Motors
Thermoplastic Handle Plug ..	121 18-19	 141	
Thermostat Guards	161	UltraLite® Wedge Pads	19	Wet Switch Flood Detector	77
Thermostat Wire	121, 162	UltraViolet Light	40	Whips	142-143
Thermostats	161	Union.....	53	White Lithium Grease	88
THHN Stranded Hook-Up Wire	120	Union C x Brass	234	White Nylon Ties with Mounting	Hole.....
Thinwall E.M.T. Connectors...	112	Union Coupling	202 165	
Thread Sealant with Teflon	91	Universal Alarm	77	White Nylon Wire Ties	165
Thread Sealants	230	Universal Carbide Igniters	48	White Pipe	244
Three Phase Disconnects.....	144	Universal Pump Elbow	204	Winged Wire Connectors	125
Three Pole Definite Purpose	Contactors	Universal Spun Copper Driers	241	Wire.....	120-121, 162-163
..... 150		Upright Snips.....	180	Wire and Cable Clamps - Nylon 165
Time Delay Fuses	153	Utility Covers	110	Wire Connectors.....	163-164
Time Delay Plug Fuses.....	153	Utility Fuse Outlets.....	123	Wire for Mini-Split Installation ..	162
Time Delays	154	Utility Plates	110	Wire Tie Mounts.....	165
Tin Handle Acid Brushes	169	U-Type Strap.....	235 164-165	
T-Joint.....	202	Vacuum Pump Oil	230	Wiring Devices	121-126
Toggle Bolts.....	115	Valve Action Marker	89	Wolverine® Universal Hot Surface	
Toggle Switch and Receptacle	Combo Device.....	Valve Action Paint Marker.....	89		
..... 123		Vent Termination Kits.....	49		
Toggle Switch Cover	158	Ventilation Products.....	39		
Toggle Switch Neon Pilot Light					

CATEGORY INDEX cont'd

Igniter	48
Workhorse® Manufactured Rags	87
Worklights by Cliplight®	174-175
WypAll Plus	87
WypAll ShopPro X80 Towels ...	87
Zinc Plated DC Steel Romex Connectors	112
Zinc-It® Instant Cold Galvanize™	
Zinc Rich Galvanize Coating ..	88

PART NUMBER INDEX

01714 91	14145 39	230-18-4 162	230-EB6 202	230-WC4B 201
01724 91	14175 39	230-AFB3 201	230-EIN3 202	230-WC6 201
02033 245	14250 39	230-AFB4 201	230-EIN3B 202	230-WR3 203
02053 245	14340 39	230-B1HD 31	230-EIN4 202	230-WR4 203
02100 245	145-175 148	230-B2L 31	230-EIN4B 202	230-WR6 203
02255 245	145-175220 .. 148	230-B2M 31	230-EIN6 202	230-WS2 201
04010 245	145-175330 .. 149	230-B2XL 32	230-FB3 201	233-292 148
04011 245	161-193 148	230-B3L 31	230-FB3B 201	233-292220 ... 148
04012 245	161-193220 ... 148	230-B3M 31	230-FB4 201	23559 30
04022 245	161-193330 ... 149	230-BP17W 30	230-FB453 202	2424-2 20
04134 245	1636-2 20	230-CP3 202	230-FB453B ... 202	2424-3 20
04402 245	1636-3 20	230-CP3B 202	230-FB454 202	2436-2 20
04404 245	16491 92	230-CP4 202	230-FB454B ... 202	2436-3 20
04407 245	16500 184	230-CP4B 202	230-FB456 202	2442-2 20
04410 245	16510 184	230-CP6 202	230-FB4B 201	24-458 174
04421 245	16520 184	230-D3 201	230-FB6 201	24-460 174
04451 245	18001 92	230-D3B 201	230-FJ3 203	2448-3 20
04500 245	18002 92	230-D4 201	230-FJ4 203	2454-2 20
04507 245	18003 92	230-D4B 201	230-FR3 203	2460-3 20
04850 245	18415 39	230-D6 201	230-FR4 203	25001 180
04871 245	189-227 148	230-DC3 203	230-FR6 203	25720 39
04872 245	189-227220 .. 148	230-DC4 203	230-IK3 204	2601 224
1000-1200 148	189-227330 ... 149	230-DC6 203	230-IK4 204	2602 224
10012 92	200-240 148	230-DCLIP 204	230-IKC3 204	2603 224
1002 224	20122 223	230-DCLIP-10 . 204	230-IKC4 204	26-2 20
108-130 148	20122 225	230-DE3 203	230-INJ465 ... 204	2626-2 20
108-130220 ... 148	20133 226	230-DE3B 203	230-LFB3 202	2626-3 20
108-130330 .. 149	20-3132-18 50	230-DE4 203	230-LFB3B 202	2660-2 20
111112 174	20-3132-24 50	230-DE4B 203	230-LFB4 202	270-324 148
111113 174	20-3132-36 50	230-DE6 203	230-LFB4B 202	270-324220 ... 148
111114 174	20-3132-48 50	230-DL16 81	230-LFB6 202	270-324330 ... 149
111115 174	20-3135-18 51	230-DL16-20 ... 81	230-MB14W 30	30-2 22
111116 174	20-3135-24 51	230-DLF16 81	230-MB17W 30	3030-2 20
111117 174	20-3135-36 51	230-DLF18 81	230-MB36B 30	3030-3 20
111118 174	20-3135-48 51	230-DLF20 81	230-MBCW 30	30306 172
111121 175	21367 81	230-DLF25 81	230-PFB3 204	30309 172
111123 174	216-259 148	230-DLF32 81	230-SF3 201	30310 172
111128 174	216-259220 ... 148	230-DLFY 81	230-SF4 201	30-3131-24 50
111130 174	216-259330 ... 149	230-DPML 81	230-TC34 203	30-3131-36 50
114301 174	22068 158	230-DPPL 81	230-TC46 203	30-3131-48 50
114302 174	22098 30	230-DPPM 81	230-TJ4 202	30-3132-12 50
124-156 148	23010 90	230-DSCREW . 204	230-TJ4B 202	30-3132-18 50
124-156220 ... 148	230-14-4 162	230-EB3 202	230-TJ6 202	30-3132-24 50
124-156330 ... 149	230-14-4S 162	230-EB3B 202	230-WC3 201	30-3132-30 50
12601 81	230-14-7 162	230-EB4 202	230-WC3B 201	30-3132-36 50
14062 81	230-16-2 162	230-EB4B 202	230-WC4 201	30-3132-48 50

PART NUMBER INDEX cont'd

30-3132-60 50	3587 140	3732HS 140	3GR0340 146	4224CX 106
30-3132-72 50	3588 140	3733HS 140	3GR0425 146	4224NX 106
3036-2 20	3589 140	3734HS 140	3GR0435 146	4226 106
3036-3 20	3590 140	37350H 146	3GR0515 146	4226CX 106
3060-3 20	3595 140	37350R 146	3GR0520 146	4231 106
3143-2 20	3596 140	3735HS 140	3GR0525 146	4252 106
3143-3 20	362-16 84	3736HS 140	3GR0530 146	4252CX 106
315-20 84	3636-2 20	3737HS 140	3GR0535 146	4253 106
3202 139	3636-3 20	3738HS 140	3GR0540 146	4253CX 106
3203 139	3640-2 20	3739HS 140	3GR0545 146	4254CX 106
3203HS 140	3640-3 20	37400H 146	3GR0550 146	42897 39
3204HS 140	3648-2 20	37400R 146	3GR0555 146	4293 125
3205 139	3648-3 20	37450H 146	3GR0560 146	4293CX 125
3205HS 140	3650-3 20	37450R 146	3GR0570 146	4294 125
32-2 20	3654-2 20	3746 139	3GR0580 146	4294CX 125
32-3 20	3660-3 20	3747HS 140	3GR1035 146	4296 125
3232-2 20	3678-3 20	37500H 146	3GR1080 146	4296CX 125
3232-3 20	37030H 146	37500R 146	3GR7530 146	43-53220 148
3237-3 20	37040H 146	37550R 146	3GR7540 146	436-20 94
324-388 148	37050H 146	37600H 146	3GR7555 146	45020H 147
325-12 84	37050HB 146	37600R 146	3GR7560 146	45030H 147
33025 39	37050R 146	37700H 146	3GR7580 146	45040H 147
3345-3 20	37060H 146	37800H 146	3WF-01 228	45050H 147
340-408 148	37075H 146	37800R 146	400-480 148	45050HU 148
3434-2 20	37075HB 146	378-440 148	4042-3 20	45050R 147
3458 140	37075R 146	3842-3 20	4054-3 20	45060H 147
3458HS 140	37100H 146	3870-3 20	4062-3 20	45075H 147
3459 140	37100HB 146	3GJ0330 146	410239 174	45075HU 148
3459HS 140	37125H 146	3GJ0515 146	4147-3 20	45075R 147
3463 141	37125R 146	3GJ0520 146	4183-3 20	45100H 147
3464 141	37150H 146	3GJ0525 146	4200AX 106	45100HU 148
3465 140	37150R 146	3GJ0530 146	4204 106	45100R 147
3465HS 140	37175H 146	3GJ0535 146	4204CX 106	45125H 147
3466 141	37175R 146	3GJ0540 146	4205CX 106	45125HU 148
3467 141	37200H 146	3GJ0545 146	4213 106	45125R 147
3468 140	37200R 146	3GJ0555 146	4213CX 106	45150H 147
3468HS 140	37250H 146	3GJ1025 146	4214 106	45150HU 148
3469 140	37250R 146	3GJ1060 146	4214CX 106	45150R 147
3469HS 140	3726HS 140	3GJ1520 146	4215 106	45175H 147
357-20 222	3727 139	3GJ7530 146	4215CX 106	45200H 147
358-20 222	3728 139	3GJ7535 146	4219 106	45200HU 148
358-20S 222	3729 139	3GJ7545 146	4220 106	45200R 147
3583 140	3730 139	3GJ7555 146	4220CX 106	45250H 147
3584 140	37300H 146	3GR0325 146	4221 106	45250HU 148
3585 140	37300R 146	3GR0330 146	4221CX 106	45250R 147
3586 140	3731 139	3GR0335 146	4224 106	45300H 147

PART NUMBER INDEX cont'd

45300HU 148	4JJ0535 147	4JR7560.....147	5-2002 190	5380AX..... 118
45300R 147	4JJ0540 147	4JR7560U.....148	5-2005 190	5381 118
45350H 147	4JJ0545 147	4JR7570.....147	5201 117	538-1/2 240
45350HU 148	4JJ0555 147	4JR7580.....147	5223 122	538-1/4 240
45350R 147	4JJ0560 147	4WF-01 228	5225 117	538-1-1/8 240
45400H 147	4JJ1055 147	5002 115	5230 117	538-1-3/8 240
45400HU 148	4JJ7535 147	50302 42	5231 111	538-1-5/8 240
45400R 147	4JJ7540 147	5031 120	5232 111	5382 118
45450H 147	4JJ7545 147	5033 120	5240 122	538-2-1/8 240
45450HU 148	4JR0440 147	5035 120	5242 122	538-2-5/8 240
45450R 147	4JR0520 147	5036 120	5246 119	5383 118
45500H 147	4JR0525 147	5041 120	5252-3 20	538-3/4 240
45500HU 148	4JR0525U 148	5042 120	5255 119	538-3/8 240
45500R 147	4JR0530 147	5046 120	525-MT1 184	538-3-1/8 240
4550-3 20	4JR0530U 148	5053-3 20	525-PT1 184	538-3-5/8 240
45550H 147	4JR0535 147	5056-3 20	525-TORCH 184	5384 118
45550R 147	4JR0535U 148	5-05790 87	5-300020 190	538-4-1/8 240
4558-3 20	4JR0540 147	5058-3 20	5-300030 190	5385 118
45600H 147	4JR0540U 148	5070-3 20	530-30752 188	538-5/8 240
45600HU 148	4JR0545 147	5-10 188	530-30753 188	538-7/8 240
45600R 147	4JR0545U 148	5-100020 190	530-30755 188	5-401 190
45700H 147	4JR0550 147	5-100030 190	530-30756 188	5-401005 191
45700HU 148	4JR0550U 148	510-3400 193	530-30757 188	540-1005L..... 90
45700R 147	4JR0555 147	510-3400-10 193	530-30818 188	5-401007 191
45800H 147	4JR0555U 148	510-437338 190	530-30821 188	5-401010 191
45800HU 148	4JR0560 147	510-438338 190	530-30834 188	5-401020 191
45800R 147	4JR0560U 148	5107 115	530-30850 188	5-401030 191
460-552 148	4JR0570 147	510-D102251 190	530-30863 188	5-402007 191
4700-12 186	4JR0580 147	510-D102338 190	530-30876 188	540-2110C 85
4700-34 186	4JR0580U 148	510-D304020 190	530-30884 188	540-2114 90
4701-12 186	4JR1055 147	510-D304030 190	530-30885 188	540-2200 90
4701-34 186	4JR1060 147	510-D309020 190	530-30890 188	540-25G 176
4703-34 186	4JR1080 147	510-D309030 190	530-30891 188	540-278BM0024
4704-12 186	4JR7525 147	510-D323020 190	530-30893 188 179
4704-34 186	4JR7530 147	510-D323030 190	530-31132 188	540-278HX0002
4707-12 186	4JR7530U 148	510-D441020 190	530-31133 188 179
47072-12 186	4JR7535 147	5-11830 39	5-32 188	5-404 190
47072-34 186	4JR7535U 148	5-11840 39	5-321020 190	540-400 178
4707-34 186	4JR7540 147	5-11853 39	5-321030 190	5-405 190
4711-12 186	4JR7540U 148	5-11866 39	5-33570 87	540-500 178
4711-34 186	4JR7545 147	5-11879 39	5-34790 87	540-506 176
4718-12 186	4JR7545U 148	5-12 188	535-BB1 142	540-508 176
4766-3 20	4JR7550 147	5-14 188	535-BB2 142	540-509 176
4848-3 20	4JR7550U 148	515-J2000 194	535-BB3 142	540-572 224
4JJ0525 147	4JR7555 147	515-J3000 194	535-BB4 142	540-573 224
4JJ0530 147	4JR7555U 148	5200 117	535-BB6 142	5-406005 191

PART NUMBER INDEX *cont'd*

5-406007 191	540-RB414M .. 179	542-76220 170	5-500 90	5-SCR61-2DPBULK 94
5-406010 191	540-RB418M .. 179	5-429005 192	5-520 193	5-SCR63-8 94
5-406020 191	540-RB424M .. 179	5-429007 192	5557-3 22	5-SCR63-8BULK.94
5-406030 191	540-RB610HDM 179	5-429010 192	5-61 179	5-SCR71-2 94
540-648 148	540-RB614HDM 179	5-429015 192	56-72 148	5-SCR71-2BULK.94
540-6510L 180	540-RB618HDM 179	5-429020 192	56-72220 148	5-SCR81 94
540-6510R 180	540-RB618HDM 179	5-429030 192	585-F336..... 161	5-SCR81-12-10094
540-6716B 180	540-RB624HDM 179	5-435005 192	585-TG 161	5-SCR81-12BULK 94
540-6716L 180	540-RB636DW 179	5-435007 192	585-TG1 161	5-SCR81-12W ... 94
540-6716R 180	540-RB636W .. 179	5-435101 192	585-TG2 161	5-SCR81-12WTBUL 94
540-6716S 180	540-RB656WS 179	5-435102 192	585-TG3 161	5-SCR81-2 94
540-6900L 180	540-RB810HDM 179	5-436005 192	585-TG4 161	5-SCR81-25M ... 94
540-6900R 180	540-RB814HDM 179	5-436007 192	585-TG5 161	5-SCR81-2BULK.94
5-407 190	540-RB814HDM 179	5-436010 192	585-TG6 161	5-SCR81-2DP ... 94
5-407005 191	540-RB956W .. 179	5-436020 192	585-TG7 161	5-SCR81-2DPBULK 94
5-407007 191	540-T50M 176	5-436030 192	585-TG8 161	5-SCR81-2DPBULK 94
5-407074 191	540-T50MOC .. 176	5-436074 193	585-TG9 161	5-SCR81-2DPBULK 94
5-407131 191	5-41 179	5-436101 193	590-708 148	5-SCR81-2DPBULK 94
5-407131 191	5-410 191	5-436102 193	5-HW5850 224	5-SCR81-25M ... 94
540-799 89	5-410005 192	5-436131 193	5-IG5850 224	5-SCR81-2BULK.94
5-408 191	5-410007 192	5-437101 193	5-MSH1/4MC... 178	5-SCR81DP 94
540-800 89	5-410010 192	5-437130 193	5-MSH5/16MC. 178	5-SCR81DPBULK 94
540-805 89	5-41041 87	5-437131 193	5-SCR101 94	5-SCR81DPBULK 94
540-806 89	5-411 191	5-437210 193	5-SCR101-12DP 94	5-SCR82 94
540-807 89	5-411 191	5-438101 193	5-SCR101-12DPBULK 94	5-SCR82-100 ... 94
540-808 89	5-412 191	5-438131 193	5-SCR101-2BULK 94	5-SCR82BULK ... 94
540-811B 89	5-414 191	5-447007 192	5-SCR101-2DPBULK 94	5-SCR82W 94
5-409 191	5-41411 87	5-448007 193	5-SCR101-2DP .. 94	5-SCR83-4 94
5-409005 191	5-41455 87	5-449005 192	5-SCR101-2DPBULK 94	5-SCR83-4BULK.94
5-409007 191	5-416 190	5-449007 192	5-SCR101-2DPBULK 94	5-SCR83-4DP ... 94
5-409010 191	5-417 190	5-449030 192	5-SCR101BULK.. 94	5-SCR83-4DPBULK 94
540-AK100..... 93	5-417005 191	5-450007 192	5-SCR101DP 94	5-SCR83-4DPBULK 94
540-BH1L 90	5-417007 191	545-420 172	5-SCR101DPBULK 94	5-SCR-AK..... 93
540-CARABINER 181	5-417010 191	545-422 172	5-SCR101DPBULK 94	5-SCRMS..... 93
540-DB6 93	5-417012 191	545-424 172	5-SCR102DP 94	6000 118
540-DISP..... 85	5-417020 191	545-426 172	5-SCR102DPBULK 94	6001 118
540-FCTMC5 .. 180	5-417030 191	545-430 172	5-SCR102DPBULK 94	6002 118
540-FCTMN1 ... 180	5-418 190	545-440 172	5-SCR103-4 94	6003 118
540-FCTMS1 .. 180	542-00968 170	545-442 172	5-SCR103-4BULK 94	6004 118
540-FCTMS2 ... 180	542-25015 170	545-460 172	5-SCR103-4DP .94	6005 141
540-GUN..... 224	542-272 86	5-474007 193	5-SCR103-4DPBULK 94	6006 118
540-HU1L..... 90		548-001 183	5-SCR103-4DPBULK 94	6007 118
540-LG1M..... 90		548-003 184	5-SCR61-2DP ... 94	6010 141
540-R8CCRF ... 179		548-005 184		6011 118
540-RB125W .. 179		548-007 184		60205 105
		548-009 184		60205CX 105

PART NUMBER INDEX cont'd

60206 105	61234LX 102	620-18-2P 162	620-601 156	6223 104
60210 104	61235LX 102	620-18-3 162	620-604 156	6223LX 104
60210CX 104	6-12-4 142	620-18-3P 162	620-605 156	6224 102
60210LX 104	6-12-4NM 142	620-18-4 162	620-608 154	6224CX 102
60219 102	6-12-4NMP 143	620-18-5 162	620-6081 154	6226 105
60220 102	6-12-4NMR 143	620-18-6 162	620-6082 154	6226CX 105
60220LX 102	6-12-4NMSP 143	620-18-6P 162	620-6083 154	6227 105
60247 105	6-12-4NMSWP 143	620-18-7 162	620-6-2 145	6227LX 105
60251 102	61252 105	620-18-8 162	620-700 156	6228 105
60251CX 102	61252NX 105	620-18-8P 162	620-701 156	6228LX 105
60252CX 105	61255 105	620-200 157	620-702 156	6229 102
60254 105	61255LX 105	620-201 157	620-703 156	6229LX 102
60254CX 105	61256LX 105	620-20-10 162	620-704 156	6230 104
60254LX 105	6-12-6 142	620-20134 157	620-705 156	623-000 163
60256 105	6-12-6NM 142	620-202 157	6207E 141	623-001 163
60256CX 105	6-12-6NM4SWP 143	620-20-2 162	6208 104	623-002 163
60259HX 103	6-12-6NMP 143	620-20-3 162	620-8-2 145	623-003 163
60263BCX 113	6-12-6NMP 143	620-20-4 162	6208LX 104	623-004 163
60263BLX 113	6-12-6NMR 143	620-20-5 162	6209 104	623-005 163
60263CX 113	6-12-6NMSP 143	620-20-6 162	6209LX 104	623-006 163
60264BCX 113	6-12-6NMSWP 143	620-20-7 162	6210 104	623-007 163
60264CX 113	6-12-6R 143	620-20-8 162	6210E 141	623-008 163
60265BLX 113	6-12-8NMP 143	6-202-1 92	6211 104	623-012 164
60265LX 113	6-12-8NMSWP 143	6-202-2 92	6211CX 104	623-013 164
60331B 120	6182 124	620-252 157	6212 104	623-014 164
60331BE 120	6183 124	620-253 157	6212CX 104	6230CX 104
60331R 120	6-1838L 79	620-254 157	6213 102	6231 104
6067-3 20	6-1838S 79	620-255 157	6213CX 102	6231CX 104
6-1 80	6184 124	620-274W 157	6214 102	6231LX 104
6101 118	6-1846S 79	620-300 156	6214CX 102	6232 104
6102 118	6185 124	620-303 156	6215 105	6232CX 104
6103E 141	6186 124	620-304 156	6216 105	6232LX 104
6105E 141	6187 124	620-306 156	6216CX 105	6233 102
6107E 141	6193 124	6203E 141	6216LX 105	6233CX 102
6108 116	6194 124	620-400 156	6217 104	6233LX 102
6109 116	6195X 124	620-401 156	6217CX 104	6234 102
6110E 141	6-2 80	620-403 156	6217LX 104	6234LX 102
6113 118	62000AX 113	620-404 156	6218 102	6235 102
6-1200 39	6200BSX 105	620-405 156	6218CX 102	6235CX 102
61202 105	6200HX 103	620-406 156	6218LX 102	6235LX 102
61214 105	620-10-2 145	620-408 156	6219 102	6236LX 105
61220 102	620-12-2 145	620-409 156	6219LX 102	6237 105
61221CX 102	620-14-2 145	620-411 156	6220 102	6237LX 105
61221LX 102	620-18-10 162	620-502 156	6220CX 102	6238 105
61223LX 102	620-18-12 162	6205E 141	6222 104	6238LX 105
61233LX 103	620-18-2 162	620-600 156	6222LX 104	6239 105

PART NUMBER INDEX cont'd

6239LX 105	625-B1 158	6263BLX 113	6281 102	6-321 183
623-MIX 163	625-CR15W .. 156	6263BNX 113	6281LX 102	6322 119
6241 104	625-CR20W .. 156	6263CX 113	6282 102	6-3263L 79
6242 104	625-CS120W . 156	6263DX 113	6282LX 102	6-3263S 79
6-2424L 79	625-IS5 145	6263LX 113	6283 103	6-330 82
6242LX 104	625-S13 157	6263NX 113	6283LX 103	6330-4 121
6244 104	625-S14 157	6264BCX 113	6285 103	6330-6 121
6244LX 104	625-S15 157	6264BLX 113	6285LX 103	6331 121
6251 102	625-S16 157	6264BMX 113	6286 103	6332B 120
625-1301W ... 156	625-S17 157	6264CX 113	6287 104	6332G 120
625-16-6 158	625-S18 157	6264LX 113	6287CX 104	6332R 120
625-16-690 ... 158	625-S19 157	6265BCX 113	6287NX 104	6332W 120
625-183 145	625-S20 157	6265BLX 113	6287XX 104	6333B 120
6251CX 102	626-10S 153	6266BLX 113	6288 103	6333G 120
6251LX 102	626-10T 153	626-6S 153	6288LX 103	6333R 120
6252 105	626-15 153	6267MX 113	6289 103	6333W 120
625-2132B ... 157	626-15S 153	6268BMX 113	6289LX 103	6334B 120
625-2132V ... 157	626-15T 153	6269 113	6291 125	6334G 120
625-2132W ... 157	6261BCX 113	6269CX 113	6291CX 125	6334R 120
625-2134B ... 157	6261CX 113	6269LX 113	6292 125	6334W 120
625-2134V ... 157	626-20 153	6269MX 113	6292CX 125	6335B 120
625-2134W ... 157	626-20S 153	626-AT0003 ... 154	6293 125	6335G 120
625-270W 156	626-20T 153	626-AT0005 ... 154	6293CX 125	6335R 120
6252LX 105	626-23133 ... 154	626-HASR10 .. 153	6294 125	6335W 120
625-304 145	626-23233 ... 154	626-HASR15 .. 153	6294CX 125	6336 121
625-305 145	626-23333 ... 154	626-HASR20 .. 153	6295X 125	6337 121
6253CX 105	626-25 153	626-HASR25 ... 153	6296 125	6338 121
6253LX 105	626-25S 153	626-HASR30 ... 153	6296CX 125	6339 121
6255 105	626-25T 153	626-HASR40 .. 153	6298 125	6339XL 121
6255CX 105	626-26311 154	626-HASR60 ... 153	6298LX 125	6340 121
6255LX 105	6-2626L 79	6270 103	6-3 80	6341 121
6257 105	6262BCX 113	6270LX 103	6301 141	6342 121
6257NX 105	6262BLX 113	6272 105	6303 141	6343 121
6258 103	6262BMX 113	6-2739L 79	6-3030L 79	6-34-4 142
625-800 145	6262CX 113	6274 105	6-3050L 79	6-34-4NM 142
625-801 145	6262LX 113	6-2748L 79	6-3050S 79	6-34-4NMR 143
625-810 145	6262MX 113	6-2748L-100 79	6-3060L 79	6-34-4NMSP .. 143
625-811 145	626-30 153	6-2748S 79	6-3060L-100 ... 79	6-34-4R 143
6258CX 103	626-30S 153	6274LX 105	6-3060S 79	6-34-6 142
6259 103	626-30T 153	6276 105	63070 124	6-34-6NM 142
6259CX 103	626-38071 154	6-2763L 79	63076B 124	6-34-6NMR 143
625-AF10 39	626-38073 154	6-2763S 79	63077B 124	6-34-6NMSP ... 143
625-AF12 39	626-38632 154	6276LX 105	6310X 119	6-34-6R 142
625-AF14 39	626-38636 154	6277 103	6311 119	6-34-8 142
625-AF6 39	6263BCX 113	6277NX 103	6312 119	6-34-8NM 142
625-AF8 39	6263BDX 113	6278CX 124	6321 119	6360B 120

PART NUMBER INDEX cont'd

6360R 120	6413 116	6644 116	6900AX..... 117	6-REF401 178
6360W 120	6414 116	6645 116	6943CX 117	6-ST600LED 182
6361B 121	6415 116	6683 116	6945CX 117	6-T1191 184
6361R 121	6416 116	6685 116	6946CX 117	6-T482..... 184
6362B 121	650-001 40	6700AX..... 116	6953CX 117	6-T744..... 179
6362R 121	650-002 40	6701 116	6955CX 117	701-001 186
6362W 121	650-003 40	6702 116	6956CX 117	701-002 186
6-3636L 79	650-005 40	6703 116	6-CT700F..... 182	701-003 186
6363B 121	650-006 40	6704 116	6-DMM20UL.... 176	701-006 186
6363R 121	650-008 41	6704-2X 116	6-FT80H 183	701-007 186
6363W 121	650-010 41	6706 116	6-FT80R 183	701-008 186
6364B 121	650-011 40	6706-2X 116	6-GPK035 175	701-009 186
6364R 121	650-012 40	6722 116	6-HAB-BG 33	701-011 186
6364W 121	650-013 40	6722-2X..... 116	6-HDT303K..... 183	701-012 186
6365B 121	650-014 40	6724 116	6-HG15..... 175	701-013 186
6365R 121	650-015 40	6724-2X..... 116	6-HK2748 80	701-014 186
6365W 121	650-016 40	6730 116	6-HK2748-1 80	701-015 186
6-3660L 79	650-017 40	6731 116	6-HK2748-SAM 250	701-017 186
6-3660S 79	650-020 41	6732 116	6-HK2748-SAM	701-018 187
6370 124	650-021 40	6733 116 251	701-019 187
6371 124	650-023 40	6-733 82	6-HK2766 80	701-020 187
6383-325 121	650-031 40	6-734 82	6-HK2766-1 80	701-023 187
6383-35 121	650-036 40	6735 116	6-HK3050 80	701-025 187
6384-325 121	650-038 40	6-735 82	6-HK3050-1 80	701-028 187
6384-35 121	650-074 40	6-736 82	6-HK3050HD 80	701-029 187
6-4 80	6500A 115	675-P521U 161	6-HK3060 80	701-030 187
6401 116	6501 115	675-P621U 161	6-HK3060-1 80	701-031 187
640-122 145	650-100 39	675-P721UT ... 161	6-HK3060HD 80	701-032 187
640-142 145	6501CX 115	675-P722U 161	6-HK3070HD 80	701-033 187
6402 116	6502 115	675-PSD010BF	6-HK3364FUR ... 80	701-034 187
6403 116	650-200 39 161	6-HK3378FUR.... 80	701-035 187
6404 116	6503 115	675-PSD111 ... 161	6-M22..... 80	701-037 187
640-845 145	650-300 39	675-PSDH121 161	6-M24 80	701-038 187
640-AF2 42	6503CX 115	675-PSM30SA 161	6-M26 80	701-039 187
640-AF25 42	6505 115	675-PSM40SA 161	6-M2748 80	701-040 187
640-AF3..... 42	6505LX..... 115	675-PSP722E.. 161	6-M2763 80	701-041 186
640-FD2B 42	6526 115	6800HX 117	6-M30..... 80	701-043 186
640-FD2S 42	6528 115	6853 117	6-M3030 80	701-046 187
640-FD3S..... 42	6601 116	6855 117	6-M3030-SAM. 250	7033 115
640-FSK2 42	6602 116	6858 117	6-M3030-SAM 251	7034 115
640-FSK3..... 42	6603 116	6859 117	6-M3050 80	7036X 115
640-UL25 42	6622 116	6865 117	6-M3060 80	7066X..... 115
640-UL3..... 42	6623 116	6866 117	6-M3263..... 80	708-850 148
6411 116	6641 116	6868 117	6-P3030L-SAM. 250	7-10 81
641-14 222	6642 116	6876 117	6-P3030L-SAM. 251	7-100 92
6412 116	6643 116	6878 117	6-R50A..... 39	710-001 41

PART NUMBER INDEX cont'd

710-002 41	7-14B 81	7-4000 92	750-RC841 145	7-80633 91
710-003 41	7-14P 81	7-4001 92	750-RC842 145	7-918 85
710-004 41	7-200 92	7-4100 92	750-SLTC50 144	7-944 85
710-005 41	7233RLX 108	7-4100 92	750-SLTC7 144	799-001 89
7-100W 172	7234RLX 108	741-001 88	750-SLTC9050 144	799-002 89
710-100 42	7235RLX 108	741-002 88	750-SLTC9075 144	799-003 89
710-101 42	7236RLX 108	741-003 88	750-TZNMLT100	799-004 89
710-102 42	72-88220 148	7-4101 92 144	799-005 89
710-103 42	72-88330 149	7-4200 92	750-TZNMLT125	799-006 89
710-182G 41	7301 108	7-4400 93 144	799-009 89
710-185G 41	7-301K 173	7-4500 93	750-TZNMLT150	799-010 89
7-1058 247	7302 108	750-10100 144 144	799-011 89
7-1078 247	7303 108	750-10500 144	750-TZNMLT200	799-012 89
710-A16100 41	7311L 108	750-12100 144 144	799-013 89
710-A1650 41	7-316 81	750-121000 .. 144	750-TZNMLT38.144	799-021 89
710-A1710 41	7-316 81	750-125100 .. 144	750-TZNMLT50	799-022 89
7-10KOTN100 153	7316L 108	750-1550 144 144	799-024 89
7-10KOTN30... 153	7316X 108	750-2050 144	750-TZNMLT75.144	799-025 89
7-10KOTN35 .. 153	7317L 108	750-34100 144	750-TZNMLT90100	799-040 89
7-10KOTN40 .. 153	7317X 108	750-34800 144 144	799-041 89
7-10KOTN45... 153	7321X 108	750-38100 144	750-TZNMLT90125	7-AD010000 ... 172
7-10KOTN50 .. 153	7-34 81	750-401 194 144	7-AL9V 85
7-10KOTN60... 153	7-341-18 247	750-402 194	750-TZNMLT90150	7-AL9V-8 85
7-10KOTN70 .. 153	7-3412 247	750-500 144 144	7-ALAA 85
7-10KOTN80 .. 153	7-341-58 247	750-600 144	750-TZNMLT90200	7-ALAA-24 85
7-10KOTN90 .. 153	7-342-18 247	750-MLT50..... 144 144	7-ALAAA 85
7-10P 81	7-342-58 247	750-MLT75..... 144	750-TZNMLT9038	7-ALAAA-18 85
710-P100 42	7-3434 247	750-MLT9050.. 144 144	7-ALC 85
7-12 81	7-3438 247	750-MLT9075.. 144	750-TZNMLT9050	7-ALC-12 85
7-121-18 247	7-3458 247	750-NMLT100.. 144 144	7-ALD 85
7-1212 247	7-3478 247	750-NMLT125. 144	750-TZNMLT9075	7-ALD-12 85
7-121-38 247	7-34B 81	750-NMLT4550.144 144	7-CRNR100 153
7-121-58 247	7-34P 81	750-NMLT4575.144	7-58 81	7-CRNR15 153
7-122-18 247	7-38 81	750-NMLT50 ... 144	7-5811 164	7-CRNR20 153
7-122-58 247	7-381-18 247	750-NMLT5090-F	7-5811-B 164	7-CRNR25 153
7-123-18 247	7-3812 247 144	7-58B 81	7-CRNR30 153
7-1234 247	7-381-38 247	750-NMLT75 ... 144	7-58P 81	7-CRNR35 153
7-1238 247	7-381-58 247	750-NMLT7590-F	770-15 84	7-CRNR40 153
7-1258 247	7-382-18 247 144	7-711 164	7-CRNR45 153
7-1278 247	7-382-58 247	750-NMLT90100	7-711-B 164	7-CRNR50 153
7-12B 81	7-3834 247 144	7-75W 172	7-CRNR60 153
7-12P 81	7-3838 247	750-NMLT90125	7-78 81	7-CRNR70 153
7-14 81	7-3858 247 144	7-78P 81	7-CRNR80 153
7142 108	7-3878 247	750-NMLT9050.144	7-80045 92	7-CRNR90 153
7142LX 108	7-38B 81	750-NMLT9075.144	7-806 85	7-CVMINITUBE .. 81
7146 108	7-38P 81	750-P60NF 143	7-80632 91	7-ECC12100 .. 172

PART NUMBER INDEX cont'd

7-ECC1225 172	88-108220 148	ACP36483 22	B-24H 194	B-926 170
7-ECC1250 172	88-108330 149	ACP38422 22	B-26..... 171	B-927 170
7-ECC16100 .. 172	89DC..... 226	ACR-1..... 30	B-27..... 169	B-928 170
7-ECC1625 172	8-FWH16..... 94	ACT-6 176	B-28H 194	B-929 170
7-ECC1650 172	8-WH16 94	ADB-1 154	B-304 171	B-930 170
7-ECC50725 .. 172	900-3 49	ADB-2 154	B-307 171	B-931 170
7-ECC50730 ... 172	900-4 49	ADM-1..... 154	B-316 171	B-932 170
7-ECC50735 ... 172	900-5 49	ADM-2..... 154	B-319 171	B-934 170
7-L300..... 41	900-6 49	AER-8 30	B-322 171	B-935 170
7-L300..... 164	91-2032 51	AER-8BL 30	B-328 171	B-996 170
7-P24 41	91-3042 51	AG-25 92	B-32H 194	B-998 170
7-P24 164	92-3232 51	ALK150-01 228	B-333 171	BE-24..... 171
7-P36 41	92-4242 51	ALK150-05 228	B-36H 194	BE-36..... 171
7-P36 164	940 226	ALK200-01 228	B-4..... 169	BE-48..... 171
7-P36B 41	9410SSR..... 226	ALK300-01 228	B-428 171	BH-1 171
7-P36B 164	944KIT 226	AP-DD 79	B-433 171	BNT-1 225
7-P48..... 41	947KIT 226	AP-DK..... 79	B-4H 194	BNT-32..... 225
7-P48 164	948KIT 226	AT-1700 158	B-501 169	BP-46..... 76
7-P48B 41	971KIT 226	ATK-1 229	B-502 169	BP-46-230..... 76
7-P48B 164	9721 141	ATK-1P..... 229	B-503 169	BPF-01 52
7-SE4W3C 173	972KIT 226	ATK-4 229	B-504 169	BPF-02 52
7-SPHW3AAA-BX	973KIT 230	AW-712..... 169	B-505 169	BPF-03 52
..... 173	980 225	AW-712-10 169	B-604 171	BPF-04 52
7-TLC10625 ... 172	98084KIT 225	AW-712-8 169	B-610 171	BPF-05 52
7-TLC10630.... 172	98087KIT 225	AW-8..... 169	B6-12-4 142	BPF-06 52
800-008 93	981 223	AW-9..... 169	B6-12-4NM 142	BPF-07 52
800-009 93	983KIT 226	AW-96..... 169	B6-12-6 142	BPF-08 52
8200M 119	984 226	AW-96-10 169	B6-12-6NM 142	BPF-09 52
8201 119	985 226	AW-96-8..... 169	B-616 171	BPF-10 52
8201C 119	A60306K..... 142	B-1 169	B-622 171	BPF-11 52
8202 119	ACB-30 32	B-10..... 171	B-628 171	BPF-12 52
8203 119	ACB-36 32	B-10H 194	B-633 171	BPF-13 52
8203C..... 119	ACB-42 32	B-124 170	B6-34-4NM 142	BPF-14 52
8207 119	ACB-48..... 32	B-125 170	B6-34-6 142	BPF-16 52
8208 119	ACID-ELIM 230	B-126 170	B6-34-6NM 142	BPF-17 52
8220M..... 119	ACK4 181	B-127 170	B-6H 194	BPF-18 52
8233 119	ACP-10..... 84	B-128 170	B-704 171	BPF-20 52
8282LX 125	ACP24242 22	B-129 170	B-716 171	BPF-21 52
8284 125	ACP24243 22	B-12H 194	B-722 171	BPF-22 52
8284CX 125	ACP24362 22	B-131 170	B-733 171	BPF-23 52
8286 125	ACP30302 22	B-132 170	B-802 171	BPF-25 53
8286CX 125	ACP30303 22	B-16H 194	B-807 171	BPF-26 53
829-995 148	ACP32322 22	B-2..... 169	B-816 171	BPF-27 53
84DCPLUS..... 225	ACP32323 22	B-20H 194	B-8H 194	BPF-28 53
87DCPLUS..... 226	ACP36362 22	B-210 171	B-924 170	BPF-29 53
88-108 148	ACP36363 22	B-216 171	B-925 170	BPF-31 53

PART NUMBER INDEX *cont'd*

BPF-32 53	BPN-52 51	C165-0058 234	C242-0390 234	C460-0295 235
BPF-33 53	BPN-53 51	C165-0090 234	C243 164	C460-0305 235
BPF-34 52	BPN-54 51	C165-0093 234	C245 164	C460-0390 235
BPN-1 51	BPN-6 51	C165-0094 234	C247 164	C460-0414 235
BPN-10 51	BPN-7 51	C165-0100 234	C2-5 168	C460-0429 235
BPN-11 51	BPN-8 51	C165-0107 234	C254-0002 233	C460-0432 235
BPN-12 51	BPN-9 51	C165-0149 234	C254-0100 233	C5 168
BPN-13 51	BPN-A12 51	C165-0150 234	C254-0150 233	C512 164
BPN-14 51	BPN-A34 51	C165-0159 234	C2-5S 168	C512L 164
BPN-15 51	BR115 157	C165-0215 234	C272-0002 233	C533-0050 235
BPN-16 51	BR120 157	C165-0222 234	C272-0025 233	C533-0150 235
BPN-17 51	BR130 157	C165-0223 234	C272-0050 233	C657-0100 234
BPN-18 51	BR140 157	C165-0295 234	C272-0090 233	C947-0025 235
BPN-19 51	BR150 157	C165-0304 234	C272-0100 233	C947-0050 235
BPN-2 51	BR2100 157	C165-0305 234	C272-0150 233	C947-0100 235
BPN-20 51	BR215 157	C165-0390 234	C272-0215 233	C947-0150 235
BPN-21 51	BR220 157	C165-0399 234	C290-0002 233	C947-0215 235
BPN-22 51	BR230 157	C165-1498 234	C290-0025 233	C947-0295 235
BPN-23 51	BR240 157	C170-0003 235	C290-0050 233	C947-0390 235
BPN-24 51	BR250 157	C172-0090 235	C290-0090 233	CA-252C 168
BPN-25 51	BR260 157	C172-0100 235	C290-0100 233	CAS-2712 91
BPN-26 51	BR270 157	C172-0150 235	C290-0150 233	CB-03 79
BPN-28 51	BS-16 224	C172-0215 235	C290-0215 233	CB-2 78
BPN-29 51	BS-25 79	C20 168	C290-0390 233	CC-1 77
BPN-3 51	BS-32 224	C20-D 168	C295-0002 234	CC33 159
BPN-30 51	C10 168	C222 164	C295-0090 234	CC33-18 159
BPN-31 51	C101-0050 233	C222C 164	C295-0100 234	CC33-24 159
BPN-32 51	C101-0100 233	C223 164	C295-0150 234	CCP-L 172
BPN-33 51	C101-0150 233	C223C 164	C312 164	CCP-M 172
BPN-34 51	C101-0222 233	C235-0002 233	C312L 164	CG-AER 221
BPN-35 51	C105-0057 233	C235-0025 233	C410-0032 234	CGB-AER 221
BPN-37 51	C105-0100 233	C235-0050 233	C410-0058 234	CH115 157
BPN-38 51	C105-0150 233	C235-0090 233	C410-0093 234	CH120 157
BPN-39 51	C105-0215 233	C235-0100 233	C410-0107 234	CH215 157
BPN-4 51	C114-0215 233	C235-0150 233	C410-0149 234	CH220 157
BPN-40 51	C1-2-6 168	C235-0215 233	C410-0159 234	CH230 157
BPN-41 51	C142-0058 235	C241 164	C410-0222 234	CH240 157
BPN-43 51	C154-0002 234	C242-0001 234	C410-0306 234	CH250 157
BPN-44 51	C154-0090 234	C242-0002 234	C460-0002 235	CH260 157
BPN-45 51	C154-0100 234	C242-0025 234	C460-0025 235	CK-141 79
BPN-46 51	C165-0001 234	C242-0050 234	C460-0050 235	CLL-1 230
BPN-47 51	C165-0002 234	C242-0090 234	C460-0090 235	CLL-4 230
BPN-48 51	C165-0007 234	C242-0100 234	C460-0100 235	CM-1000 49
BPN-5 51	C165-0025 234	C242-0150 234	C460-0150 235	CO-1 88
BPN-50 51	C165-0032 234	C242-0215 234	C460-0215 235	COOLWELD-32.221
BPN-51 51	C165-0050 234	C242-0295 234	C460-0222 235	CP-16 76

PART NUMBER INDEX cont'd

CP-16-230 76	CVENT-4 49	D40880500B3B6 243	D61420350 ... 243	D90-293Q..... 152
CP-22 76	CVENTCAP2 49	D41020250B3B6 243	D61420400 ... 243	D90-294Q 152
CP-22-230 76	CVENTCAP3 49 243	D61420500 ... 243	D90-295Q..... 152
CP-22-230T..... 76	CVENTCAP4 49	D41020350B3B6 243	D61430250 ... 243	D-90340 152
CP-22LP 76	CVMINI..... 76 243	D61430300.... 243	D-90341 152
CP-22LP-230.... 76	CV-PTRAP 78	D41020500B3B6 243	D61430350 ... 243	D-90342 152
CP-22T 76	CV-RTRAP 78 243	D61430400 ... 243	D90-360 152
CP-CV 76	CVS-2 49	D41080250B3B6 243	D61430500.... 243	D90-370 152
CP-M115 77	CVS-3 49 243	D61480250 ... 243	D90-372 152
CP-M230..... 77	CV-TUBE 78	D41080350B3B6 243	D61480300 ... 243	D90-380 152
CP-MINI-L..... 77	CW-15 79 243	D61480350 ... 243	D90-382 152
CPN1 164	CW-30 168	D41080500B3B6 243	D61480400 ... 243	D90-384 152
CPN1C 164	D20-3132-18 ... 50 243	D61480500 ... 243	DAD032 241
CPN2 164	D20-3132-24 ... 50	D60A-10 238	D61820250 ... 243	DAD032S 241
CPN2C 164	D20-3132-36 ... 50	D60A-4 238	D61820500.... 243	DAD052 241
CPN2M 164	D20-3132-48 ... 50	D60A-8 238	D61830250 ... 243	DAD052S 241
CPN3 164	D30-3131-24 ... 50	D61020250B3B6 243	D61830300 ... 243	DAD053S 241
CPN3C 164	D30-3131-36 ... 50 243	D61830350 ... 243	DAD082 241
CR070 180	D30-3131-48 ... 50	D61020350B3B6 243	D61830400.... 243	DAD082S 241
CR-1 88	D30-3132-18 ... 50 243	D61830500 ... 243	DAD083S 241
CRC-1 88	D30-3132-24 ... 50	D61020500B3B6 243	D61880250 ... 243	DAD084S 241
CRC-13 88	D30-3132-36 ... 50 243	D61880300.... 243	DAD163 241
CRC-1KB 87	D30-3132-48 ... 50	D61080250B3B6 243	D61880350.... 243	DAD163S 241
CRC-2 88	D40620250B3B6 243 243	D61880400.... 243	DAD164S 241
CRC-3 88 243	D61080350B3B6 243	D61880500.... 243	DAD303 241
CRC-4-140 85	D40620350B3B6 243 243	D61A-4 238	DAD303S 241
CRC-4CF 85 243	D61080500B3B6 243	D61A-8 238	DAD304S 241
CRC-4NU..... 86	D40620500B3B6 243 243	D62A-1010 238	DAD305 241
CRC-5 88 243	D61220250 ... 243	D62A-44 238	DAD305S 241
CRC-5BC 88	D40680250B3B6 243	D61220300 ... 243	D62A-66 238	DBF083 242
CRC-6 88 243	D61220350 ... 243	D62A-88 238	DBF083S..... 242
CRC-7-140 86	D40680350B3B6 243	D61220400 ... 243	D64A-1010 238	DBF084..... 242
CRC-7PS 86 243	D61220500 ... 243	D64A-44 238	DBF084S 242
CRC-7X 86	D40680500B3B6 243	D61230250 ... 243	D64A-66 238	DBF163..... 242
CRC-7Z 86 243	D61230300 ... 243	D64A-88 238	DBF163S 242
CRC-8 87	D40820250B3B6 243	D61230350 ... 243	D68A-4B 238	DBF164S..... 242
CRC-9 88 243	D61230400 ... 243	D68A-6C 238	DBF165S..... 242
CRC-CF2 88	D40820350B3B6 243	D61230500.... 243	D68A-6D 238	DC30-3132-18 .50
CS-1 77 243	D61280250 ... 243	D69A-4A 238	DC30-3132-24.. 50
CS1200 77	D40820500B3B6 243	D61280300 ... 243	D69A-8D 238	DC30-3132-36 .50
CS-2 77 243	D61280350 ... 243	D-90113 152	DC30-3132-48.. 50
CS-3 77	D40880250B3B6 243	D61280400 ... 243	D-90118 152	DC-4128 86
CT-475M 168 243	D61280500 ... 243	D90-290Q..... 152	DC-9128 86
CT800..... 181	D40880350B3B6 243	D61420250 ... 243	D90-291Q 152	DDS-30 143
CVENT-2 49 243	D61420300.... 243	D90-292Q 152	DDS-60 143
CVENT-3 49				DDS-60U 143

PART NUMBER INDEX cont'd

DE1-10D 238	DPE252240 ... 150	DPEAUX10 151	DSP-1 155	DX-3 241
DE1-12E 238	DPE253120 150	DPEAUX11 151	DSS-SLD306SV 241	DX-4 241
DE13 115	DPE25324 150	DPEAUX11QC . 151	DSS-SLD307SV. 241	DXA-5..... 241
DE14 115	DPE253240 ... 150	DPEAUX20..... 151	DST-5..... 149	E-10 177
DE1-4B 238	DPE301120 150	DPEAUX22..... 151	DST-6..... 149	E-5 177
DE15 115	DPE30124 150	DPR063 152	DT2-10..... 239	E-6 177
DE1-6B 238	DPE301240 150	DPR064 152	DT2-4 239	E-8..... 177
DE1-6C 238	DPE302120 150	DPR066 152	DT2-6 239	EB-10 177
DE1-6D 238	DPE30224 150	DPSG-2 242	DT2-8 239	EB-8 177
DE1-8D 238	DPE302240 ... 150	DPSG-2MF 242	DTK113 78	EC-1 41
DE1-8E 238	DPE302277 ... 150	DPSG-2S 242	DTK113B 78	EC252120 150
DE23 115	DPE303120 150	DPSG-3 242	DTK205..... 78	EC25224 150
DE24 115	DPE30324 150	DPSG-3MF..... 242	DTK207 78	EC252240 150
DE33 115	DPE303240 150	DPSG-3S 242	DTK210..... 78	EC252277 150
DEP052 91	DPE303277 ... 150	DPSG-4 242	DTP-3..... 155	EC302120 150
DEP8001 91	DPE303480 ... 150	DPSG-4MF..... 242	DTT-10 87	EC30224 150
DEP8002 91	DPE304120 ... 150	DRV10-414080-170 244	DTT-24 87	EC302240 150
DF-75 79	DPE30424 150	DRV10-414120-170 244	DU1-10D..... 239	EC303120 150
DG321NRB..... 144	DPE304240 ... 150	DRV10-418140-170 244	DU1-10E 239	EC30324 150
DG322NRB..... 144	DPE304277 ... 150	DRV10-418140-170 244	DU1-12D..... 239	EC303240 150
DG322URB..... 144	DPE401120 ... 150	DRV2-408060-170 244	DU1-4A 239	EC303277 150
DMB-1..... 142	DPE40124 150	DRV2-408060-270 244	DU1-4B 239	EC402120 150
DMB-2..... 142	DPE402120 ... 150	DRV3-410080-770 244	DU1-6B 239	EC40224 150
DMB-3..... 142	DPE40224 150	DRV3-412080-870 244	DU1-6C..... 239	EC402240 150
DN1-10 239	DPE402240 ... 150	DRV6-412080-170 244	DU1-6D..... 239	EC403120 150
DN1-12..... 239	DPE402480 ... 150	DSL13-5SVHH 241	DU1-6E 239	EC40324 150
DN1-14..... 239	DPE403120 ... 150	DSL13-6SVHH 241	DU1-8B 239	EC403240 150
DN1-3 239	DPE40324 150	DSL13-7SVHH 241	DU1-8D..... 239	EC403277 150
DN1-4 239	DPE403240 ... 150	DSL13-8SVHH 241	DU1-8E 239	EC503120 150
DN1-6 239	DPE403480 150	DSL27-9SVHH 241	DU2-10..... 239	EC50324 150
DN5-4 239	DPE404120 ... 150	DSL27-9SVHH 241	DU2-12 239	EC503240 150
DN5-6..... 239	DPE404240 ... 150	DSL54-11SVHH 241	DU2-14..... 239	EC503277 150
DNS4-10..... 239	DPE404277 150	DSCALE 229	DU2-4 239	EC-56 177
DNS4-12 239	DPE503120 150	DSL13-5SVHH 241	DU2-6 239	EC603120 150
DNS4-14..... 239	DPE50324 150	DSL13-6SVHH 241	DU2-8 239	EC60324 150
DNS4-4 239	DPE503240 150	DSL27-7SVHH 241	DU3-10E 240	EC603240 150
DNS4-6..... 239	DPE602120 150	DSL27-9SVHH 241	DU3-6D..... 240	EC603277 150
DNS4-8..... 239	DPE603120 ... 150	DSL54-11SVHH 241	DU3-8D..... 240	EC753120 150
DP-1 168	DPE60324 150	DSCALE 229	DUCT-FRESH-16 227	EC75324 150
DP2-10 239	DPE603240 ... 150	DSL13-5SVHH 241	DUCT-FRESH-32 227	EC753240 150
DP2-4 239	DPE753120 150	DSL13-6SVHH 241	DUCT-FRESH-8. 227	EC753277 150
DP2-6 239	DPE75324 150	DSL27-7SVHH 241	DUS4-4 240	EC810 177
DP2-8 239	DPE753240 ... 150	DSL27-9SVHH 241	DUS4-6 240	EC903120 150
DPB222R 144	DPE903120 ... 150	DSL54-11SVHH 241		EC90324 150
DPE252120 ... 150	DPE90324 150			EC903240 150
DPE25224 150	DPE903240 ... 150			EC903277 150

PART NUMBER INDEX cont'd

ECO-COIL 220	ED610 125	EL3648-3 19	FF-1000-S 31	GV07 159
ECO-COIL-32 ... 220	ED611 125	EL3842-2 19	FF-250-S 31	GV08 159
ECO-COIL-5 220	ED612 125	EL3842-3 19	FF-250-UNI 31	GV10 159
ECO-COIL-55 ... 220	ED613 125	EL3870-3 19	FF-400-S 31	GV12 159
ECR01-12W 141	ED620 125	EL4040-3 19	FF-600-S 31	GV14 159
ECR01-9W 141	ED621 125	EL4558-3 19	FH-1 154	GV16 159
ED1232 123	ED710 125	EL4848-3 19	FLOW-PLUS-10 .227	GVA1 159
ED1238 123	ED877 123	EL5252-3 19	FLOW-PLUS-125	GVA2 159
ED1240-2 123	ED9726 123	EL5658-3 19227	H1840-4 21
ED1262-2 123	ED-AT3 120	EM480 124	FLOW-PLUS-200	H2424-4 21
ED1262-2I 123	ED-AT5 120	EM484 124227	H2436-4 21
ED1301 123	ED-CR15 120	EP1838-3 23	FLOW-PLUS-25.227	H3030-4 21
ED1301-I 123	ED-CR20 120	EP2424-2 23	FLOW-PLUS-6...227	H3232-4 21
ED1703 121	ED-CR25 120	EP2424-3 23	FM0450 41	H3345-4 21
ED1709 121	ED-CR30 120	EP2436-2 23	FP-22 76	H3636-4 21
ED1711 122	ED-CR35 120	EP3030-2 23	FP-22-230 76	H3642-4 21
ED179 121	ED-CR40 120	EP3030-3 23	FP-36 91	H3648-4 21
ED1876 123	ED-CR45 120	EP3232-2 23	FRL12-F 244	H3652-4 21
ED1876-I 123	ED-CR50 120	EP3232-3 23	FRL14-F 244	H3654-4 21
ED1877 123	ED-CR60 120	EP3244-2 23	FRL38-F 244	H3672-4 21
ED252 122	EDS-12-6NM ... 143	EP3244-3 23	FRL58-F 244	H3842-4 21
ED270 123	EDS-60U 143	EP3636-2 23	FTL3 181	H3852-4 21
ED270-I 123	EG 222	EP3636-3 23	FTL3D 181	H3865-4 21
ED273 114	EG-5 222	EP3648-3 23	FULO425 40	H3872-4 21
ED273CX 114	EG-55 222	EP3842-2 23	FULO625 40	H4040-4 21
ED277 123	EL1838-3 19	EP3842-3 23	GA-06 168	H4242-4 21
ED2867 122	EL2424-2 19	EP4040-3 23	GA-30 168	H4558-4 21
ED2887 122	EL2424-3 19	ET130C1 158	GAU225-PURGE	H5557-4 21
ED320 124	EL2430-2 19	ET22 158168	HC-1 21
ED406 114	EL2436-2 19	ET33 158	GC275 158	HC-1-100 21
ED419 122	EL2436-3 19	ET35G 158	GC277 158	HC5410 118
ED4409 122	EL2626-2 19	ET35N 158	GG-1 78	HC5410X 118
ED447 123	EL3030-2 19	ET35R 158	GG-1A 78	HC5416 118
ED448B 123	EL3030-3 19	ET35W 158	GG-1BOR 78	HC5416X 118
ED4509 122	EL3036-2 19	ET44 158	GG-1H 78	HC5420 118
ED453 123	EL3040-2 19	ET75 79	GG-1NHL 78	HC5424 118
ED454 123	EL3232-2 19	ET75-KIT 79	GG-1TF 78	HC5436 118
ED455 123	EL3232-3 19	FA-01 79	GGC-12 78	HC5436X 118
ED468 123	EL3244-2 19	FA-02 79	GGC-6 78	HC6202 118
ED4867 122	EL3244-3 19	FA-03 79	GN-23H 93	HC6203 118
ED494 123	EL3434-2 19	FAK-10 90	GP1-4OBL 93	HCO-128 86
ED5225 123	EL3636-2 19	FAK-25 90	GT-750 168	HCO-15 86
ED600 125	EL3636-3 19	FB-1 30	GV04 159	HCO-7 86
ED601 125	EL3640-2 19	FC-73 48	GV05 159	HCP-15 86
ED602 125	EL3640-3 19	FC-74 48	GV06 159	HCP-7 86
ED603 125	EL3648-2 19	FC-87 49	GV07 159	HDR-101 160

PART NUMBER INDEX cont'd

HDR-102 160	HS-60-2 181	LIT-FLY-COND ... 250	M-4 177	MKT-POP-DEVELEC 251
HDR-201 160	HSA1 159	LIT-FLY-CS1200 250	M-5..... 177	MKT-POP-DEVEZC 251
HDR-202 160	HSA2..... 159	LIT-FLY-CVKUBE 250	MAG-1..... 182	MKT-POP-DEVEZC 251
HDR-211 160	HSK1 149	LIT-FLY-CVKUBE-S 250	MB21 159	MKT-POP-DTBACKS 251
HDR-212 160	HSK5..... 149	LIT-FLY-CVMINI . 250	MB22..... 159	MKT-POP-DTBACKS 251
HDR-221 160	HT1840-4..... 21	LIT-FLY-CVMINI-S 250	MBK-6 78	M K T - P O P - DTBACKSSLAT . 251
HDR-222 160	HT2424-4..... 21	LIT-FLY-DISC 250	MG-1 175	MKT-POP-DUCT . 251
HEK-400 160	HT2436-4..... 21	LIT-FLY-DST10 .. 250	MG-RGB 175	MKT-POP-DUCTSAM 251
HEK-500..... 160	HT3030-4..... 21	LIT-FLY-DTP3 250	MG-RGR 175	MKT-POP-DUCTSAM 251
HFL-4257 160	HT3232-4..... 21	LIT-FLY-DTP3ES. 250	MHP-4..... 177	MKT-POP-DUCTSAM 251
HFL-4300 160	HT3345-4..... 21	LIT-FLY-ELITE 250	MICN109 49	MKT-POP-DUCTSAM 251
HFL-4333 160	HT3636-4 21	LIT-FLY-ET 250	MKT-MERCH-CHEM 251	MKT-POP-EASEL. 250
HFL-5257 160	HT3648-4..... 21	LIT-FLY-FLOW 250	MKT-MERCH-FLEX 251	MKT-POP-ET 251
HFL-5258 160	HT3656-4..... 21	LIT-FLY-FOOT ... 250	MKT-MERCH-RSC 251	MKT-POP-HSI ... 251
HFL-5300 160	HT3842-4..... 21	LIT-FLY-GG..... 250	MKT-MERCH-SEAL12 251	MKT-POP-PF 251
HFL-5301 160	HT3852-4..... 21	LIT-FLY-HEAT 250	MKT-MERCH-SEAL30 251	MKT-POP-WS .. 251
HFL-5333 160	HT4040-4 21	LIT-FLY-HEF 250	MKT-MERCH-SEAL30 251	MKT-POP-WSDEMO 250
HMD1844-4 21	HT4242-4..... 21	LIT-FLY-HPAD 250	MKT-MERCH-SEAL30 251	MKT-POP-WSDEMO 251
HMD2436-4 21	HT4558-4..... 21	LIT-FLY-HRP 250	M K T - M E R C H - USACAPS 251	MKT-SAM-ELEC. 251
HMD3030-4 21	HVENT-2 49	LIT-FLY-HSI 250	MKT-POP-BROCH 250	MKT-SAM-ELEC 250
HMD3636-4 21	HVENT-3..... 49	LIT-FLY-MDP 250	MKT-POP-BROCH4 250	MKT-SAM-HSI ... 250
HMD3648-4 21	IGN-001 48	LIT-FLY-MOTORS. 250	MKT-POP-BROCH4 250	MKT-SAM-HSI ... 251
HMD3842-4 21	IGN-1R..... 48	LIT-FLY-MSPLIT . 250	MKT-POP-CDLC 251	MP-12 24
HMD4040-4 21	IGN-2 48	LIT-FLY-PF..... 250	MKT-POP-CHEM251	MP-12C..... 24
HMR-130..... 160	IGN-2-6P 48	LIT-FLY-PUMP... 250	MKT-POP-CLRGOND 251	MP-12E 24
HP3232-8 23	IGN-401 48	LIT-FLY-PF-S..... 250	MKT-POP-CLRSHELF 251	MP-18 24
HP3636-8 23	IGN-402 48	LIT-FLY-RSC 250	MKT-POP-CLRSTAND 251	MP-18C..... 24
HPR-12 30	IGN-403 48	LIT-FLY-SEAL 250	MKT-POP-CLRSHELF 251	MP-18E 24
HPR-3 30	IGN-409..... 48	LIT-FLY-SPRAYER250	MKT-POP-CP22 251	MP-2 24
HPR-3-2P 30	IQP-120 76	LIT-FLY-SPRAYER-S 250	MKT-POP-CVTUBE 251	MP-2C..... 24
HPR-3-2PG 30	IQP-120T 76	LIT-FLY-UC 250	MKT-POP-DEVBACKS 251	MP-2E 24
HPR-6..... 30	ISO-18 24	LIT-FLY-UCSTRAP 250	M K T - P O P - CP22 251	MP-3 24
HPR-6-2P 30	ISO-2 24	LIT-FLY-UV 250	MKT-POP-CVTUBE 251	MP-3C 24
HPR-6-2PG 30	ISO-4 24	LIT-FLY-VENTS .. 250	MKT-POP-DEVBACKS 251	MP-3E 24
HPR-EXT 30	JB8265..... 91	LIT-FLY-WS 250	MKT-POP-DEVBACKS 251	MP-4 24
HS03 159	LIT-CAT-CD 250	M-1 177	M K T - P O P - DEVBACKSSLAT 251	MP-4C 24
HS04 159	LIT-CAT-HVAC.... 250	M-1R 177	MKT-POP-DEVCOMBO 251	MP-4E..... 24
HS04-100 159	LIT-CAT-NEW.... 250	M-2 177		MP-6..... 24
HS06 159	LIT-CAT-QS 250	M-2R 177		MP-6C..... 24
HS08 159	LIT-CAT-SEAL ... 250	M-3 177		MP-6E 24
HS-144 180	LIT-FLY-3D 250	M-3R 177		MP-8 24
HS16 159	LIT-FLY-3D-S ... 250			MP-8C..... 24
HS-192 181	LIT-FLY-BPPOOL. 250			
HS-30 181	LIT-FLY-CDLC ... 250			
HS-30-2 181	LIT-FLY-CLAD 250			
HS-60 181	LIT-FLY-CLRVUE. 250			

PART NUMBER INDEX cont'd

MSA-44.....236	PI237.....126	PI368.....111	PP-4.....189	PRO-YELLOW-55.....221
MSA-45.....236	PI301.....114	PI370.....111	PP-8.....189	PRO-YELLOW-AER.....221
N20-SD.....168	PI303.....114	PI371.....111	PPC-16.....189	PS-01.....227
PA10.....159	PI304.....114	PI374.....110	PPC-8.....189	PS-03.....227
PA18.....159	PI305.....114	PI375.....110	PRO-BLUE.....220	PS-07.....227
PA25.....159	PI306.....114	PI377.....111	PRO-BLUE-32...220	PS-075.....227
PA25AP.....159	PI306CX.....114	PI378.....111	PRO-BLUE-5....220	PS-1.....224
PANPATCH.....221	PI307.....114	PI379.....111	PRO-BLUE-55...220	PS-20.....227
PANPATCH-BAG .221	PI307CX.....114	PI381.....123	PRO-BLUE-AER .220	PS-40.....227
PC-600-B.....42	PI309.....114	PI382.....111	PRO-BROWN...220	PW-16.....189
PC-600-S.....42	PI310.....114	PI383.....110	PRO-BROWN-32.....220	PW-32.....189
PC-609-B.....42	PI310LX.....114	PI384.....111	PRO-BROWN-5.220	PW-4.....189
PC-609-S.....42	PI311.....112	PI385.....111	PRO-BROWN-55.....220	PW-8.....189
PC-622-B.....42	PI312.....112	PI385-34.....111	PRO-BROWN-AER.....220	PWB-16.....189
PC-622-S.....42	PI315.....112	PI386.....111	PRO-BROWN-55.....220	PWB-32.....189
PC-857.....42	PI316.....114	PI387.....110	PRO-BUBBLE-32.....225	PWB-4.....189
PE-014.....194	PI317.....114	PI389.....111	PRO-GREEN....220	PWB-8.....189
PE-038.....194	PI318.....112	PI389-GFI.....111	PRO-GREEN-32.220	PWH-16.....189
PE-058.....194	PI319.....112	PI390.....110	PRO-GREEN-5.220	PWH-4.....189
PE-104.....194	PI319CX.....112	PI391.....110	PRO-GREEN-55.220	PWU-16.....189
PF-08.....223	PI320.....112	PI393.....110	PRO-GREEN-AER.....220	PWU-4.....189
PF-16.....223	PI321.....112	PI394.....110	PRO-KLEEN....221	PWU-8.....189
PF-ADAPTER....223	PI322.....112	PI411.....112	PRO-KLEEN-5..221	PWW-16.....189
PF-IGUN.....223	PI326.....126	PI412.....112	PRO-KLEEN-55.221	PWW-4.....189
PF-IHOSE.....223	PI327.....126	PI416.....112	PRO-RED+.....221	QAV-2.....194
PF-KIT.....223	PI328.....126	PI419.....112	PRO-RED+32...221	QN-S3.....79
PG-100.....222	PI330.....114	PI426.....112	PRO-RED+5....221	QSAC1000.....36
PG-100-5.....222	PI331.....114	PI458.....112	PRO-RED+55...221	QSAC1100.....36
PG-100-55.....222	PI332.....114	PI459.....112	PRO-RED+AER .221	QSAC2000.....36
PG-50.....222	PI335.....118	PI908.....114	PRO-THAW.....230	QSAC2100.....36
PG-50-5.....222	PI337-3.....126	PI908CX.....114	PRO-THAW-1...230	QSBB1000.....31
PG-50-55.....222	PI340.....112	PI909LX.....114	PRO-TREAT-151.228	QSBB2000.....31
PG-BG.....223	PI341.....112	PI912.....114	PRO-TREAT-152.228	QSLG1000.....36
PG-BG-5.....223	PI350.....112	PI912LX.....114	PRO-TREAT-161.228	QSLG2000.....36
PG-BG-55.....223	PI351.....112	PI913.....114	PRO-TREAT-200.228	QSMS1200.....32
PG-PLUS.....223	PI352.....112	PI914.....114	PRO-TREAT-217.228	QSMS1201.....32
PG-PLUS-5.....223	PI353.....112	PI929.....126	PRO-TREAT-350.227	QSMS1202.....32
PG-PLUS-55.....223	PI360.....110	PK-2.....183	PRO-YELLOW..221	QSMS1203.....32
PI203.....114	PI361.....110	POE100-01.....229	PRO-YELLOW-32.....221	QSMS1800.....32
PI206.....114	PI361-3/4.....110	POE100-32.....229	PRO-YELLOW-5.221	QSMS1801.....32
PI221.....125	PI362.....110	POE32-01.....229	PRO-YELLOW-5.....221	QSMS1802.....32
PI222.....125	PI363.....110	POE32-32.....229	PRO-YELLOW-5.....221	QSMS2400.....32
PI226.....126	PI364.....110	POE68-01.....229	PP-16.....189	
PI227.....126	PI365.....110	POE68-32.....229	PP-32.....189	
PI228.....126	PI366.....110			
PI232CX.....111	PI367.....110			

PART NUMBER INDEX cont'd

QSMS240132	QSSS1016-24 ...34	QSWB400032	RS-TS10.....181	T-400.....173
QSMS240232	QSSS1017-12 ..34	QSWI100036	S-3.....176	T-408.....173
QSRB100032	QSSS1017-18 ..34	QSWI200036	SANI-CND222	T-409.....173
QSSS100-1234	QSSS1017-24 ..34	QSWI300036	SANI-CND-32 ..222	T-411173
QSSS100-1234	QSSS1018-12 ..34	QSWI300136	SANI-CND-5222	T-412.....173
QSSS1003-12 ..34	QSSS1018-18 ..34	QSWI300236	SANI-CND-55...222	T-417173
QSSS1003-18 ..34	QSSS1018-24 ..34	QSWI400036	SC-190	T-418.....173
QSSS1003-24 ...34	QSSS1019-12 ..34	QSWI500036	SC-1084	T5401.....151
QSSS1004-12 ...34	QSSS1019-18 ...34	QSWI600036	SC-1SHU90	T6752.....151
QSSS1004-18 ...34	QSSS1019-24 ..34	QT-1237	SC-1WP90	T6753.....151
QSSS1004-24 ..34	QSSS1020-12 ...34	QT-100237	SC-2584	T7752.....151
QSSS1005-12 ...34	QSSS1020-18 ..34	QT-100G237	SCM-10.....84	T-8173
QSSS1005-18 ..34	QSSS1020-24 ...34	QT-100N237	SCM-25.....84	T-9173
QSSS1005-24 ...34	QSSS1021-12 ...34	QT-2.....237	SCM-5.....84	TC-007.....177
QSSS1006-12 ..34	QSSS1021-18 ...34	QTH-1237	SHF-4-10FA2 ..244	TC-25.....79
QSSS1006-18 ...34	QSSS1021-24 ...34	QTH-2237	SHF-4-10FA4 ..244	TD-1.....183
QSSS1006-24 ...34	QSSS1022-12 ...34	QTM-1.....237	SHF-4-10FA5 ...244	TD-2.....183
QSSS1007-12 ...34	QSSS1022-18 ..34	QTM-2.....237	ST-1087	TG-05182
QSSS1007-18 ..34	QSSS1022-24 ..34	R-1.....178	ST-2487	TG-1079
QSSS1007-24 ...34	QSSS1023-12 ...34	RC-1242	ST-487	TG-30182
QSSS1008-12 ..34	QSSS1023-18 ..34	RLF-8225	ST75.....79	TG-30-1182
QSSS1008-18 ...34	QSSS1023-24 ...34	RM-10.....93	SUPER-KOOL...225	TG-30-12182
QSSS1008-24 ..34	QSSS1024-12 ...34	RM-1G93	SUPER-KOOL-16	TG-87A.....79
QSSS1009-12 ...34	QSSS1024-18 ...34	RS-15181225	TLC-3-10159
QSSS1009-18 ...34	QSSS1024-24 ...34	RS-20181	T-1173	TLC-3-12159
QSSS1009-24 ..34	QSSS1025-12 ...34	RS-31181	T-10173	TLC-3-8159
QSSS1010-12 ...34	QSSS1025-18 ...34	RS-41.....181	T-100173	TRIPLE-D220
QSSS1010-18 ..34	QSSS1025-24 ...34	RS-9181	T-101173	TRIPLE-D-32....220
QSSS1010-24 ...34	QSSS3634	RSC-GRN-02...246	T-11173	TRIPLE-D-5220
QSSS1011-12 ..34	QSSS4834	RSC-GRN-04K .246	T-12173	TRIPLE-D-55 ...220
QSSS1011-18 ...34	QSSS5534	RSC-GRN-10 ...246	T-13173	TRIPLE-D-AER...220
QSSS1011-24 ...34	QSSS7034	RSC-GRN-50K ..246	T-14173	TRIPLE-D-GRAN
QSSS1012-12 ..34	QSTD100033	RSC-RED-02 ...246	T1401151220
QSSS1012-18 ..34	QSTD200033	RSC-RED-02-E .246	T1404.....151	TRIPLE-D-RTU ..220
QSSS1012-24 ..34	QSTD300033	RSC-RED-04K ..246	T-15173	TS-1158
QSSS1013-12 ..34	QSTD400033	RSC-RED-04K-E.246	T-16173	TS-3158
QSSS1013-18 ..34	QSTD400133	RSC-RED-10 ...246	T-20.....173	TS-4158
QSSS1013-24 ..34	QSTD400233	RSC-RED-10-E 246	T-200173	TS-5.....158
QSSS1014-12 ...34	QSTD500033	RSC-RED-50K...246	T-21173	TT-120177
QSSS1014-18 ..34	QSTD500133	RSC-RED-50K-E246	T2401151	TT-24177
QSSS1014-24 ...34	QSTD500233	RSC-SLV-02246	T2403151	TT-240177
QSSS1015-12 ...34	QSTD600033	RSC-SLV-04K ..246	T2404.....151	U3353-318
QSSS1015-18 ...34	QSTD600133	RSC-SLV-10246	T-300173	U3650-318
QSSS1015-24 ..34	QSWB100032	RSC-SLV-500 ...246	T3401151	U3654-318
QSSS1016-12 ...34	QSWB200032	RSC-SLV-50K...246	T3403151	U3660-318
QSSS1016-18 ...34	QSWB300032	RSC-TOOL.....246	T3501151	U3678-318

PART NUMBER INDEX cont'd

U3865-3 18	UC3132-3L 19	VCC-4B 236	W121-100 162	WC05 165
U3870-3 18	UC3143-2 18	VCR-1 237	W121-50 163	WC06 165
U4054-3 18	UC3232-2 18	VCRT-1 237	W122 162	WC07 165
U4550-3 18	UC3232-3 18	VCRT-1R 237	W122-100 162	WC08 165
U4558-3 18	UC3232-3CA 19	VCRT-1S 237	W122-50 163	WC09 165
U4848-3 18	UC3237-3 18	VLC-10 237	W123 162	WC10 165
U4854-3 18	UC3434-2 18	VLC-12 237	W123-100 162	WC12 165
U4866-3 18	UC3434-3 18	VLC-18 237	W123-50 163	WC14 165
U5053-3 18	UC3445-2 18	VLC-25 237	W124 162	WC16 165
U5056-3 18	UC3445-3 18	VLC-4 237	W124-100 162	WCA1 165
U5075-3 18	UC3445-3CA 19	VLC-5 237	W124-50 163	WG840204 138
U5079-3 18	UC3539-3L 19	VLC-6 237	W125 162	WG840204HT 138
U5252-3 18	UC3636-2 18	VLC-8 237	W125-100 162	WG840205 138
U5260-3 18	UC3636-3 18	VP68-01 230	W125-50 163	WG840205HT 138
U5557-3 18	UC3636-3CA 19	VP68-05 230	W141 162	WG840463 139
U6067-3 18	UC3640-2 18	VP68-32 230	W141-100 162	WG840464 139
UA-1 77	UC3642-3 18	VS-4 236	W141-50 163	WG840465 138
UC1636-2 18	UC3642-3CA 19	VST-4 236	W142 162	WG840466 139
UC1636-3 18	UC3648-2 18	VST-44 236	W142-100 162	WG840467 139
UC1838-3 18	UC3648-3 18	VTR-24 236	W142-50 163	WG840468 138
UC1838-3CA 19	UC3648-3CA 19	VTS-10 236	W143 162	WG840469 138
UC2424-2 18	UC3842-2 18	VTS-12 236	W143-100 162	WG840583 139
UC2424-3 18	UC3842-3 18	VTS-14 236	W143-50 163	WG840584 139
UC2424-3CA 19	UC4040-2 18	VTS-3-12 236	W144 162	WG840585 139
UC2430-2 18	UC4040-3 18	VTS-3-14 236	W144-100 162	WG840586 139
UC2430-3 18	UC4040-3CA 19	VTS-46 236	W144-50 163	WG840587 139
UC2436-2 18	UC4042-3 18	VTS-56 236	W145 162	WG840588 139
UC2436-3 18	UC4044-3L 19	VTS-68 236	W145-100 162	WG840589 139
UC2436-3CA 19	UC4347-3 18	VTS-810 236	W145-50 163	WG840590 139
UC2442-3 18	UV-1 40	VVC-1 236	W801 162	WG840595 139
UC2448-2 18	UV-BULB 40	W101 162	W801-100 162	WG840596 139
UC2448-3 18	VA-3-346 236	W101-100 162	W801-50 163	WG840727 138
UC2448-3CA 19	VA-34 236	W101-50 163	W802 162	WG840728 138
UC2626-2 18	VA-46 236	W102 162	W802-100 162	WG840728HT 138
UC2626-3 18	VA-68 236	W102-100 162	W802-50 163	WG840729 138
UC2628-2 18	VAU-24 236	W102-50 163	W803 162	WG840729HT 138
UC2636-3CA 19	VAU-45 236	W103 162	W803-100 162	WG840730 138
UC3030-2 18	VAX-2 236	W103-100 162	W803-50 163	WG840730HT 138
UC3030-3 18	VAX-3 236	W103-50 163	W804 162	WG840731 138
UC3030-3CA 19	VAX-4 236	W104 162	W804-100 162	WG840731HT 138
UC3036-2 18	VAX-5 236	W104-100 162	W804-50 163	WG840736HT 138
UC3036-3 18	VAX-6 236	W104-50 163	W805 162	WG840737HT 138
UC3036-3CA 19	VAX-8 236	W105 162	W805-100 162	WG840738HT 138
UC3040-2 18	VC-4 236	W105-100 162	WC02 165	WG840739HT 138
UC3040-3 18	VC-4R 236	W105-50 163	WC03 165	WHT20 163
UC3040-3CA 19	VCC-4 236	W121 162	WC04 165	WHTB10-20 163

PART NUMBER INDEX cont'd

WHTB10-50..... 163	WTB11D 165
WHTB12-20..... 163	WTB11M 165
WHTB12-50..... 163	WTB15 165
WHTB14-50..... 163	WTB15C 165
WHTR14-50 ... 163	WTBA1 165
WHTW14-50 ... 163	WTM05 165
WM1002..... 126	WTM05C 165
WM1003..... 126	WTM07 165
WM1009..... 126	WTM07C 165
WM1014..... 126	WTM1 165
WP1212-164 ..244	WTM11 165
WP1212-50 ...244	WTM11C 165
WP1214-164 ..244	WTM14 165
WP1214-50 ...244	WTM14C 165
WP1234-50 ...244	WTM1C 165
WP1234-82 ...244	WTM2 165
WP1238-164 .244	WTM2C 165
WP1238-50 ...244	WTMB05 165
WP1258-164 .244	WTMB05C 165
WP1258-50 ...244	WTMB07 165
WP1278-50 ...244	WTMB07C 165
WP1278-82 ...244	WTMB11 165
WS-1..... 77	WTMB11C 165
WT04 165	WTMB14 165
WT04C 165	WTMB14C 165
WT05 165	X2424211 22
WT05C 165	X2424311 22
WT07 165	X2430211 22
WT07C 165	X2436211 22
WT07M 165	X2436311 22
WT11 165	X3030211 22
WT11C 165	X3030311 22
WT11L 165	X3232211 22
WT15 165	X3232311 22
WT15C 165	X3244211 22
WTA1 165	X3636211 22
WTB05..... 165	X3636311 22
WTB05C 165	X3836211 22
WTB05M 165	X3842211 22
WTB07 165	X3848311 22
WTB07C..... 165	
WTB07M 165	
WTB11 165	
WTB11C..... 204	
WTB11C 165	
WTB11CR..... 165	

PADS

MOUNTING SYSTEMS

AIR MOVEMENT

HEATING PRODUCTS

CONDENSATE MANAGEMENT

GENERAL INDUSTRIAL

DEVCO

ELECTRICAL

TOOLS

PLUMBING

DUCTLESS SYSTEMS

MAINTENANCE CHEMICALS

INLINE COMPONENTS

ABOUT DIVERSITECH

Founded in 1971, DiversiTech® Corporation is North America's largest manufacturer of equipment pads and a leading manufacturer and supplier of components and related products for the heating, ventilating, air conditioning, and refrigeration (HVAC/R) industry. Headquartered in the Atlanta, Ga., metropolitan area, DiversiTech's mission for its wholesaler partners is to simplify their work. The Company is focused on growth through internal product development, external partnerships and acquisition. Manufacturing a suite of products, which includes a wide range of mechanical, electrical, chemical and structural parts for HVACR systems, DiversiTech brings unparalleled scaling capabilities and supplier expertise. The Company holds numerous patents and operates an advanced R&D materials division dedicated to bringing more value to its customers. The Company maintains over 1 million square feet of manufacturing and distribution space in key U.S., Canadian and European locations. DiversiTech has enjoyed a continued history of successful growth and has acquired industry recognized brand names including Wagner® Manufacturing, Specialty Chemical, EcoPad®, The Black Pad®, Quick-Sling® and Super Seal™. More information is available at www.diversitech.com.



E LITE
DiversiTech

HEF-T-PAD
DiversiTech

THE BLACK PAD
DiversiTech

ULTRALITE
DiversiTech

GLADLITE
DiversiTech

DOWNLOAD [http://media.
diversitech.com/doc/
DOC32509.pdf](http://media.diversitech.com/doc/DOC32509.pdf)

CORRECTIONS/COMMENTS
feedback@diversitech.com

LIT-CAT-HVAC
6650 Sugarloaf Parkway
Duluth, GA 30097
678.542.3600
800.995.2222
678.542.3700 Fax
www.diversitech.com
©2017 DiversiTech Corporation

DIVERSITECH®

