

Warwick
Hanger Company

The Warwick Hanger Company (a prime manufacturer and direct importer) has emerged a leader in the distribution and fabrication of residential and light commercial pipe hangers. Since our manufacturing facility's establishment in 1971, we have incorporated into our production process the latest techniques in advanced automation and robotics. This has resulted in a superior product line, competitive pricing, and immediate shipping, allowing our customers to maintain minimum inventories.

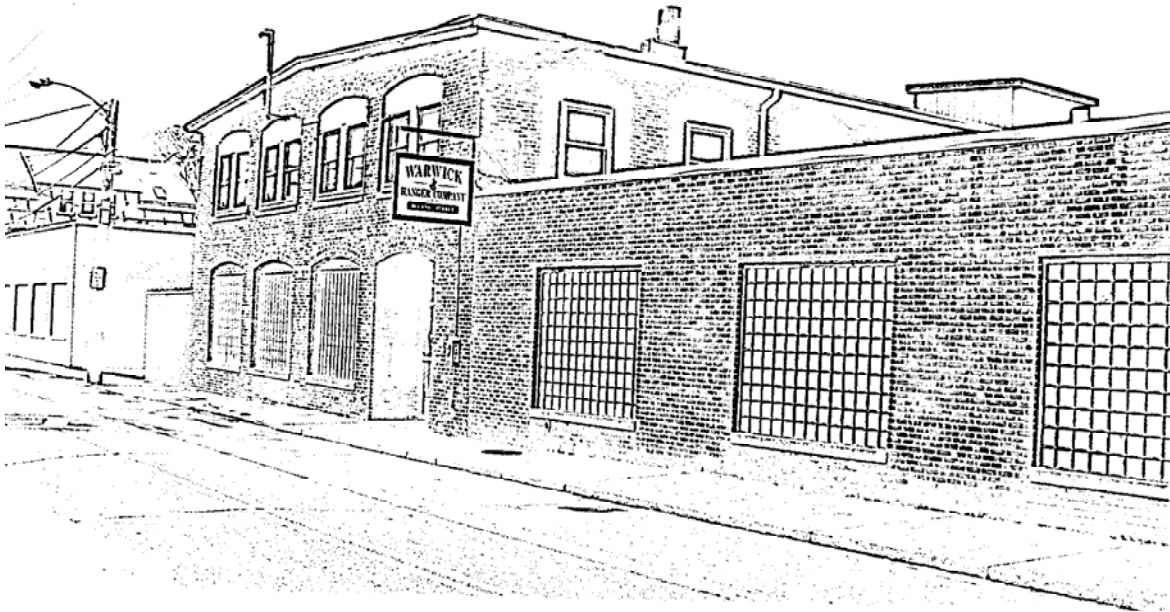

We currently occupy 80,000 square feet of manufacturing and warehouse space. We are fully confident you will be satisfied with our quality and performance. We are currently on line for EDI Transfers, and offer bar-coding on all of our products.

We would welcome a visit to our facilities by you or any of your staff, and look forward to a lasting, mutually successful relationship for our companies.

34 Canal Street-Westerly, RI 02891-Tel: 401-596-8062 Fax: 401-596-8063
www.WarwickHanger.com

Series 100
Copper Plated Tubing Clips

Size Range: 1/2" – 2"

Material: Carbon Steel

Finish: Copper Plating

Function: Used to clamp copper tubing flush to surface in both vertical and horizontal applications.

Our Copper Plated Tubing Clips are designed to snap onto the tubing for hands free nailing.



Copper Tubing Clips Are Packaged with Nails

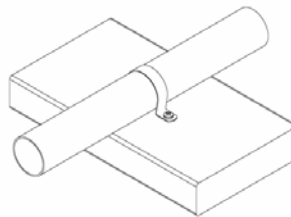

Part #	Size	Size Tubing	Packaged	Case Quantity
100-25	1/8"	3/16" O.D.	100	N/A
100-38	1/4"	3/8" O.D.	100	N/A
100-40	3/8"	1/2" O.D.	100	N/A
100-50	1/2"	5/8" O.D.	100	1000
100-75	3/4"	7/8" O.D.	100	1000
100-10	1"	1 1/8" O.D.	50	500
100-12	1 1/4"	1 3/8" O.D.	50	500
100-15	1 1/2"	1 5/8" O.D.	50	500
100-20	2"	2 1/8" O.D.	50	500

Manufactured At Our Rhode Island Facility

Hang It Faster!!!

Series 150-160-170 Plastic Pipe Clips



Size Range: 1/2" - 2"

Finish: Black

Function: Secures copper, CPVC and PEX to both wood and metal framework.

Material: High Density Polyethylene

Part #	Size	Description	Packaged	Case Quantity
150-50	1/2"	Standard	100	1000
150-75	3/4"	Standard	100	1000
150-10	1"	Standard	100	1000
150-12	1 1/4"	Standard	100	1000
160-50	1/2"	Suspension	100	1000
160-75	3/4"	Suspension	100	1000
160-10	1"	Suspension	100	1000
160-12	1 1/4"	Suspension	100	1000
160-15	1 1/2"	Suspension	100	1000
160-20	2"	Suspension	100	1000

Series 170 Plastic J Clip with Nail



Size Range: 3/8" - 1"

Finish: Black

Function: Secures copper, CPVC and PEX tubing.

Material: High Density Polyethylene

Part #	Size	Description	Packaged	Case Quantity
170-38	3/8"	J Clip With Nail	100	1000
170-50	1/2"	J Clip With Nail	100	1000
170-75	3/4"	J Clip With Nail	100	1000
170-10	1"	J Clip With Nail	100	1000

Hang It Faster!!!

Series 175

Plastic J Clip with Nail for FostaPex™

Size Range: 1/2" – 1"

Finish: Grey

Function: Secures FostaPex™.



Part #	Size	Description	Packaged	Case Quantity
175-50	1/2"	J Clip With Nail	100	1000
175-75	3/4"	J Clip With Nail	100	1000
175-10	1"	J Clip With Nail	100	1000

Series 176

Plastic Closed Clamp with Nail

Size Range: 1/2" – 3/4"

Finish: Black

Function: Secures copper, CPVC and PEX tubing.

Material: High Density Polyethylene



Part #	Size	Description	Packaged	Weight
176-50	1/2"	Plastic Closed Clamp with Nail	100	.04 Lbs
176-75	3/4"	Plastic Closed Clamp with Nail	100	.16 Lbs

Series 185

Bend Support

Size Range: 1/2" and 3/4"

Function: Plastic bend supports provide rigid 90 degree bends for pex tubing. The bend supports are made of glass reinforced nylon.



Part #	Size	Description	Packaged	Weight
185-50	1/2"	Bend Supports	25	.04 Lbs
185-75	3/4"	Bend Supports	25	.16 Lbs

Series 190 Glide Lock Pipe Clip



Size Range: 3/8" - 1"

Function: The Glide Lock Pipe Clip allows the pipe to glide back and forth freely while pipe is mounted to easily achieve your installation needs. Then with a simple squeeze of the locking fingers your pipe is locked securely into place.

Part #	Size	Description	Packaged	Case Quantity
190-50	1/2"	Glide Lock Clip	100	1000
190-75	3/4"	Glide Lock Clip	100	1000
190-10	1"	Glide Lock Clip	100	1000

Tube Isolation Clip

Size Range: 1/2" – 1"

Function: The Tube Isolation Clip insulates tube in wood and Metal studs and reduces water line noise and vibration. The Split design allows for use after piping runs.



Part #	Size	Description	Packaged	Case Quantity
186-50	1/2"	Tube Isolation Clip	100	1000
186-75	3/4"	Tube Isolation Clip	100	1000
186-10	1"	Tube Isolation Clip	100	1000

Hang It Faster!!!

Series 180 Manifold Pipe Clip

Size Range: 3/8" - 1 1/4"

Function: Whether you have 2, 3 or 20 pipes running side by side, the Manifold Clip has the ability to connect to each other to form a manifold system that keeps your pipes neat and organized. The snap lock cross arm completes the installation, giving you a strong and professional way to hang your pipe.

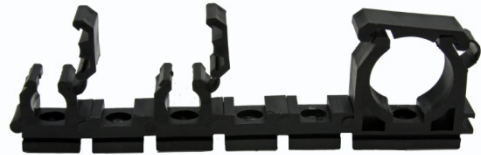

Part #	Size	Description	Packaged	Case Quantity
180-38	3/8"	Manifold Pipe Clip	100	1000
180-50	1/2"	Manifold Pipe Clip	100	1000
180-75	3/4"	Manifold Pipe Clip	100	1000
180-10	1"	Manifold Pipe Clip	100	1000
180-12	1 1/4"	Manifold Pipe Clip	100	1000

Manifold Pipe Clip Screws

Part #	Size	Description	Packaged	Case Quantity
2155-C-100	1 1/4" X #6	Drywall Screw	100	1000

Manifold Pipe Clip Spacers

Part #	Size	Description	Packaged	Case Quantity
181-10	7/8" Wide	Spacers	100	1000

Hang It Faster!!!

Series 195
The Pex Organizer



Size Range: 5/16", 3/8", 1/2" and 3/4"

Function: When it comes to installing Pex Tubing, The Pex Organizer gives you a clear and simple way to identify the specific use of the tube and communicate that use instantly or for future reference on the job sight. Simply insert the same numbered peg into each end of the tube then describe the use next to the corresponding number on the provided reference sheet. The Pex Organizer is a neat and professional way to relay information to everyone involved. When you are ready to make your Pex connections extract the peg which can then be attached to the tube using the peg clip. When your job is completed the Pex Organizer provides you and the homeowner with a complete labeled pex plumbing system.

Part #	Size	Color	Packaged
195-B-B	5/16"	Blue	1
195-B-R	5/16"	Red	1
195-C-B	3/8"	Blue	1
195-C-R	3/8"	Red	1
195-D-B	1/2"	Blue	1
195-D-R	1/2"	Red	1

Hang It Faster!!!

Series 130 Galvanized 2-Hole Pipe Clips

Size Range: 1/2" - 6"

Material: Carbon Steel

Finish: Galvanized Plating

Function: Used to clamp black iron pipe flush to the surface in both vertical and horizontal applications.

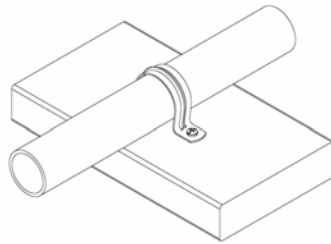
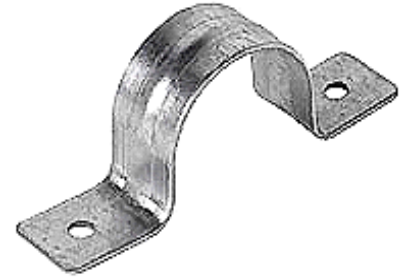

Part #	Size	Gage	Packaged	Case Quantity
130-50	1/2"	18 Gage	100	500
130-75	3/4"	18 Gage	100	500
130-38	3/8"	18 Gage	100	500
130-10	1"	18 Gage	50	500
130-12	1 1/4"	18 Gage	50	N/A
130-15	1 1/2"	18 Gage	50	N/A
130-20	2"	18 Gage	50	N/A
130-25	2 1/2"	18 Gage	50	N/A
130-30	3" Heavy	16 Gage	25	N/A
130-40	4" Heavy	16 Gage	25	N/A
130-60	6" Heavy	12 Gage	25	N/A

Manufactured At Our Rhode Island Facility

Hang It Faster!!!

34 Canal Street-Westerly, RI 02891-Tel: 401-596-8062 Fax: 401-596-8063
www.WarwickHanger.com

Series 300
Copper Plated Bell Hanger

Size Range: 1/2" - 2"
Material: Carbon Steel
Finish: Copper Plated
Function: Used to mount copper tubing.

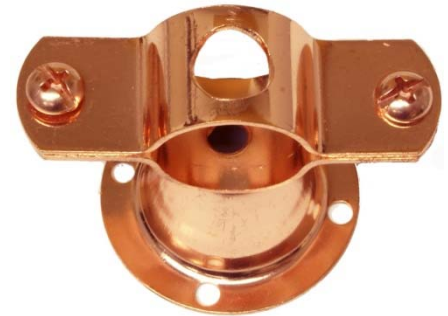

Our Copper Plated Bell Hanger has a patented access hole through the top which allows the hanger to be mounted to most flat surfaces without disassembling the cap. We have added 4 additional mounting holes around the base of the bell for additional mounting flexibility. Our hanger is used as a standoff clamp in both vertical and horizontal applications and provides 3/4" standoff.

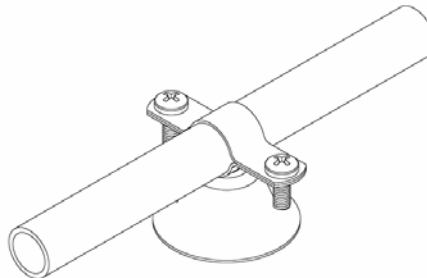

The Center Screw Has Been Pre-Installed

Part #	Size	Packaged	Case Quantity
300-2	1/2"	25	500
300-3	3/4"	25	500
300-4	1"	25	500
300-5	1 1/4"	25	N/A
300-6	1 1/2"	25	N/A
300-7	2"	25	N/A

Hang It Faster!!!

Series 300
Corrosion Resistant Bell Hangers

Size Range: 1/2" - 2"
Material: Carbon Steel
Finish: Baked Enamel
Function: Used to mount tubing.



Our Corrosion Resistant Bell Hangers are excellent for outdoor applications. (*outdoor showers, crawl spaces*)

The mounting and clamp screws are stainless steel. The bell has a powder coated finish and provides 3/4" standoff.

Screws Are Included and Packaged In Bags

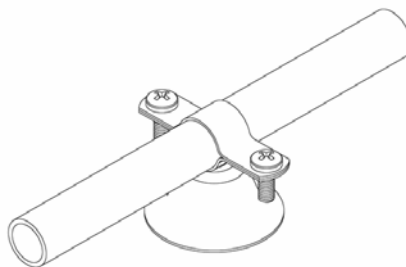

Part #	Size	Packaged
300-2-BP	1/2"	25
300-3-BP	3/4"	25
300-4-BP	1"	25
300-5-BP	1 1/4"	25
300-6-BP	1 1/2"	25
300-7-BP	2"	25

Manufactured At Our Rhode Island Facility

Hang It Faster!!!

Series IMP300
Narrow Copper Plated
Bell Hanger



Size Range: 1/2" - 2"
Material: Carbon Steel
Finish: Copper Plated
Function: Used to mount copper tubing.

The bell hanger is used as a standoff clamp in both vertical and horizontal applications and provides 3/4" standoff.

Part #	Size	Packaged	Case Quantity
IMP300-2	1/2"	25	500
IMP300-3	3/4"	25	500
IMP300-4	1"	25	500
IMP300-5	1 1/4"	25	N/A
IMP300-6	1 1/2"	25	N/A
IMP300-7	2"	25	N/A

Hang It Faster!!!

Series 1500 Trap Covers



Material: Stainless Steel
Finish: Polished Stainless

Part #	Description	Material	Weight	Packaged
1500-1	Raised	Stainless Steel	.130 Lbs	25
1500-2	Flat	Stainless Steel	.185 Lbs	25

Series 2113 Nailing Hooks

Material: Carbon Steel
Finish: Copper Plating
Function: These Copper Nailing Hooks are designed to nail directly into Wooden joists. They provide quick installation of small diameter copper tubing.



Part #	Finish	Size	Packaged	Case Quantity
2113-C	Copper Plated	3/8"	100	1000
2113-D	Copper Plated	1/2"	100	1000

Hang It Faster!!!

Series 325
Cone Riser

Size Range: 1/2" and 3/4"

Material: Carbon Steel

Finish: Copper Plated

Function: The Cone Riser is a highly efficient way to support vertical pipe sections to permit one plumber to make end connections unassisted. It also provides permanent support for copper pipes which can deteriorate under the stress of not being supported.



Part #	Size	Packaged	Case Quantity
325-2	1/2"	25	500
325-3	3/4"	25	500

Manufactured At Our Rhode Island Facility

Hang It Faster!!!

34 Canal Street-Westerly, RI 02891-Tel: 401-596-8062 Fax: 401-596-8063
www.WarwickHanger.com



Series 200
Natick Type Hangers

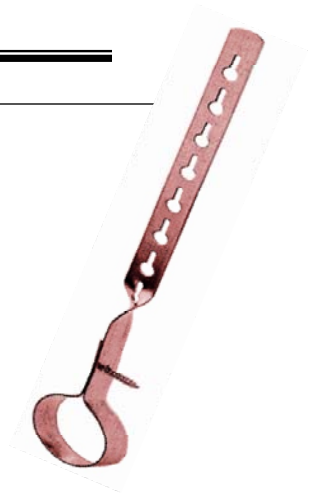

Size Range: 1/2" - 2"

Material: Carbon Steel

Finish: Copper Plating

Function: Used to suspend copper tubing from floor joists, used in horizontal applications.

*Nails are Included and
 Packaged In Bags*

Part #	Size	Packaged
200-1	1/2" x 6"	25
200-2	3/4" x 6"	25
200-3	1" x 6"	25
200-4	1 1/4" x 6"	25
200-5	1 1/2" x 6"	25
200-6	2" x 6"	25
200-7	1/2" x 12"	25
200-8	3/4" x 12"	25
200-9	1" x 12"	25
200-10	1 1/4" x 12"	25
200-11	1 1/2" x 12"	25
200-12	2" x 12"	25

Manufactured At Our Rhode Island Facility

Hang It Faster!!!

34 Canal Street-Westerly, RI 02891-Tel: 401-596-8062 Fax: 401-596-8063
www.WarwickHanger.com



Series IMP200 Import Natick Type Hangers

Size Range: 1/2" - 2"

Material: Carbon Steel

Finish: Copper Plating

Function: Used to suspend copper tubing from floor joists, used in horizontal applications.

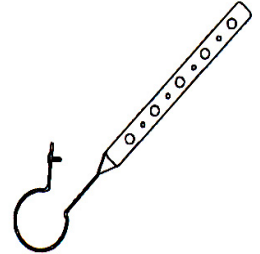

*Nails are Included and
Packaged In Bags*

Part #	Size	Packaged
IMP200-1	1/2" x 6"	25
IMP200-2	3/4" x 6"	25
IMP200-3	1" x 6"	25
IMP200-4	1 1/4" x 6"	25
IMP200-5	1 1/2" x 6"	25
IMP200-6	2" x 6"	25

Part #	Size	Packaged
IMP200-7	1/2" x 12"	25
IMP200-8	3/4" x 12"	25
IMP200-9	1" x 12"	25
IMP200-10	1 1/4" x 12"	25
IMP200-11	1 1/2" x 12"	25
IMP200-12	2" x 12"	25

Hang It Faster!!!



Series 400 Milford Type Hangers

Size Range: 1/2" - 2"

Material: Carbon Steel

Finish: Copper Plating

Function: Used to suspend copper tubing from floor joists and is used in horizontal applications.

Our Copper Plated Milford is the only milford hanger with the reinforced strap and patented keyholes, the keyhole allows for a faster and easier installation. The milford hanger is used to suspend copper tubing from floor joists and is used in horizontal applications.

Part #	Size	Packaged	Case Quantity
400-2	1/2" x 6"	25	500
400-3	3/4" x 6"	25	500
400-4	1" x 6"	25	500
400-5	1 1/4" x 6"	25	N/A
400-6	1 1/2" x 6"	25	N/A
400-7	2" x 6"	25	N/A

Part #	Size	Packaged	Case Quantity
400-8	1/2" x 12"	25	300
400-9	3/4" x 12"	25	300
400-10	1" x 12"	25	300
400-11	1 1/4" x 12"	25	N/A
400-12	1 1/2" x 12"	25	N/A
400-13	2" x 12"	25	N/A



Hang It Faster!!!

*Nails are Included and Packaged In
Bags*

34 Canal Street-Westerly, RI 02891-Tel: 401-596-8062 Fax: 401-596-8063
www.WarwickHanger.com



Series IMP400 Import Milford Type Hangers

Size Range: 1/2" - 2"

Material: Carbon Steel

Finish: Copper Plating

Function: Used to suspend copper tubing from floor joists, used in horizontal applications.

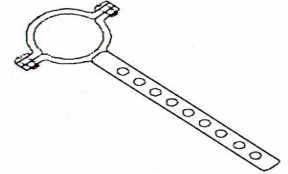

*Nails are Included and Packaged In
Bags*

Part #	Size	Packaged	Case Quantity
IMP400-2	1/2" x 6"	25	500
IMP400-3	3/4" x 6"	25	500
IMP400-4	1" x 6"	25	500
IMP400-5	1 1/4" x 6"	25	N/A
IMP400-6	1 1/2" x 6"	25	N/A
IMP400-7	2" x 6"	25	N/A

Part #	Size	Packaged	Case Quantity
IMP400-8	1/2" x 12"	25	300
IMP400-9	3/4" x 12"	25	300
IMP400-10	1" x 12"	25	300
IMP400-11	1 1/4" x 12"	25	N/A
IMP400-12	1 1/2" x 12"	25	N/A
IMP400-13	2" x 12"	25	N/A

Hang It Faster!!!

34 Canal Street-Westerly, RI 02891-Tel: 401-596-8062 Fax: 401-596-8063
www.WarwickHanger.com

Series 550 Copper Plated Wire Hooks

Size Range: 1/2" – 1 1/2"

Material: Carbon Steel

Finish: Copper Plating

Function: Used to hang copper tubing from floor joist.

Our copper plated wire hooks are manufactured out of 10 gage material. The hook has nail points on each end to allow hook to be driven into the floor joist.

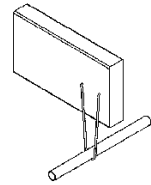

Manufactured At Our Rhode Island Facility

Part #	Copper Wire Hooks	Packaged
550-2	1/2" x 6"	50
550-3	1/2" x 8"	50
550-4	1/2" x 10"	50
550-7	3/4" x 6"	50
550-8	3/4" x 8"	50
550-9	3/4" x 10"	50
550-10	3/4" x 12"	50
550-12	1" x 6"	50
550-13	1" x 8"	50
550-14	1" x 10"	50
550-15	1" x 12"	50
550-16	1 1/4" x 6"	50
550-17	1 1/4" x 8"	50
550-18	1 1/4" x 10"	50
550-19	1 1/4" x 12"	50
550-20	1 1/2" x 6"	50

Series 575

Plastic Coated Copper Plated Wire Hooks

Size Range: 1/2" -1 1/4"

Material: Carbon Steel

Finish: Copper Plated With Plastic Coating

Function: Used to hang copper tubing from floor joist.

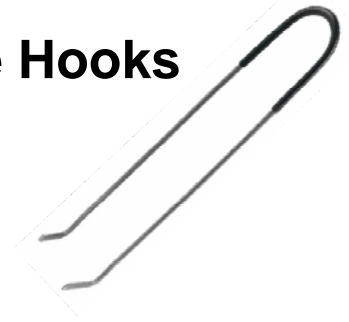

Our Plastic Coated Copper Plated Wire Hooks are manufactured out of 10 gage material. The hook has nail points on each end to allow hook to be driven into the wooden rafter.

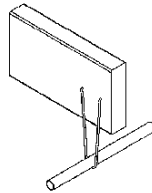

Part #	Copper Wire Hooks	Package
575-2	1/2" x 6"	50
575-3	1/2" x 8"	50
575-7	3/4" x 6"	50
575-8	3/4" x 8"	50
575-12	1" x 6"	50
575-13	1" x 8"	50
575-16	1 1/4" x 6"	50
575-17	1 1/4" x 8"	50

Manufactured At Our Rhode Island Facility

Hang It Faster!!!



Series 500 Plain Black Wire Hooks

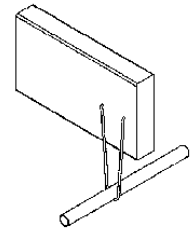

Size Range: 1/2" – 1 1/4"

Material: Carbon Steel

Finish: Plain

Function: Used to suspend black iron pipe from floor joists.

Our plain wire pipe hooks are manufactured out of 10 gage material. These hooks are made to hang black iron pipe from wooden rafters. The hook has nail points on each end to allow hook to be driven into the wooden joists.

Part #	Black Wire Hooks	Package
500-2	1/2" x 6"	50
500-3	1/2" x 8"	50
500-4	1/2" x 10"	50
500-5	1/2" x 12"	50
500-7	3/4" x 6"	50
500-8	3/4" x 8"	50
500-9	3/4" x 10"	50
500-10	3/4" x 12"	50
500-12	1" x 6"	50
500-13	1" x 8"	50
500-14	1" x 10"	50
500-15	1" x 12"	50
500-16	1 1/4" x 6"	50
500-17	1 1/4" x 8"	50
500-18	1 1/4" x 10"	50

Manufactured At Our Rhode Island Facility

Hang It Faster!!!

34 Canal Street-Westerly, RI 02891-Tel: 401-596-8062 Fax: 401-596-8063
www.WarwickHanger.com



Series 525
Plastic Coated Black Wire Hooks

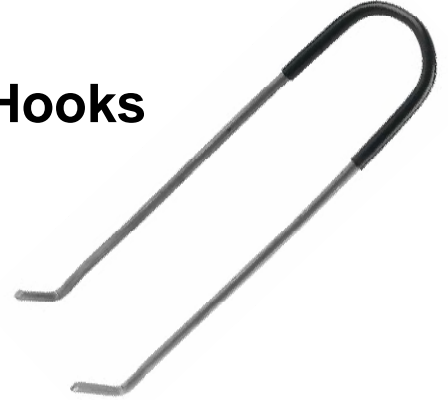

Size Range: 1/2" – 1 1/4"

Material: Carbon Steel

Finish: Plain With Plastic Coating

Function: Used to hang black iron pipe from floor joist.

Our Plastic Coated Black Wire Hooks are manufactured out of 10 gage material. The hook has nail points on each end to allow hook to be driven into the floor joist.

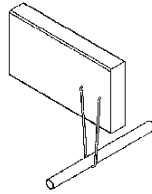

Part #	Black Wire Hooks	Package
525-2	1/2" x 6"	50
525-3	1/2" x 8"	50
525-7	3/4" x 6"	50
525-8	3/4" x 8"	50
525-12	1" x 6"	50
525-13	1" x 8"	50
525-16	1 1/4" x 6"	50
525-17	1 1/4" x 8"	50

Manufactured At Our Rhode Island Facility

Hang It Faster!!!

34 Canal Street-Westerly, RI 02891-Tel: 401-596-8062 Fax: 401-596-8063
www.WarwickHanger.com

Series 800 Tube Support Bracket



Size Range: 1/2", 3/4" and 1"

Material: Carbon Steel

Finish: Copper Plated

Function: Designed to position stub outs for all types of fixtures. Our keyhole slot adds alignment flexibility.

Part #	Size	Accepts	Width	Gauge	Weight	Packaged
800-50	Tube Bracket Narrow	1/2" Tubing	1 1/4"	16	.36 Lbs	50
800-51	Tube Bracket Wide	1/2", 3/4" & 1" Tubing	1 1/2"	16	.42 Lbs	50



*Standard packaging
50 PCs per box*

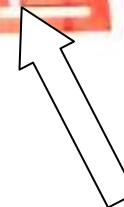

Keyhole slot adds alignment flexibility

Hang It Faster!!!

Series 250 & 275 Black Iron Pipe Hangers

Size Range: 1/2" – 1 1/4"

Material: Carbon Steel

Finish: Galvanized and Plastic Coated

Function: Used to support black iron pipes.

Our Black Iron Pipe Hanger is similar to our Natick Hanger. It is a great substitute for black wire pipe hooks and split ring hangers.



*Nails are Included and
Packaged In Bags*

Part #	Size	Finish	Weight	Packaged
250-1	1/2" x 8"	Galvanized	.090 Lbs	25
250-2	3/4" x 8"	Galvanized	.105 Lbs	25
250-3	1" x 8"	Galvanized	.127 Lbs	25
250-4	1 1/4" x 8"	Galvanized	.180 Lbs	25
275-1	1/2" x 8"	Plastic Coated	.090 Lbs	25
275-2	3/4" x 8"	Plastic Coated	.105 Lbs	25
275-3	1" x 8"	Plastic Coated	.127 Lbs	25
275-4	1 1/4" x 8"	Plastic Coated	.180 Lbs	25

Manufactured At Our Rhode Island Facility

Hang It Faster!!!

Series 3000-3100-3500-3700 Perforated Hanger Strapping

Size Range: 10', 50' and 100' Foot Coils

Material: 21 Gage Carbon Steel

Finish: Plain, Copper, Galvanized

Function: Used to hang insulated flexible duct, round pipe or rectangular duct. This helps prevent the duct system from sagging over long runs.



Fast Strap

Part #	Finish	Coil Size	Weight	Packaged
3000-10	Galvanized	10 Ft	.79 Lbs	20
3000-50	Galvanized	50 Ft	4.44 Lbs	1
3000-100	Galvanized	100 Ft	8.60 Lbs	1
3100-10	Copper Plated	10 Ft	.92 Lbs	20
3100-50	Copper Plated	50 Ft	4.90 Lbs	1
3100-100	Copper Plated	100 Ft	9.20 Lbs	1
3500-10	Plain Steel	10 Ft	.79 Lbs	20
3500-50	Plain Steel	50 Ft	4.44 Lbs	1
3500-100	Plain Steel	100 Ft	8.60 Lbs	1
<u>With</u>	<u>Fast Strap</u>		<u>With</u>	<u>Fast Strap</u>
	<u>Keyholes</u>			<u>Keyholes</u>
3000-10K	Galvanized	10 Ft	.79 Lbs	20
3000-50K	Galvanized	50 Ft	4.44 Lbs	1
3000-100K	Galvanized	100 Ft	8.60 Lbs	1
3100-10K	Copper Plated	10 Ft	.92 Lbs	20
3100-50K	Copper Plated	50 Ft	4.90 Lbs	1
3100-100K	Copper Plated	100 Ft	9.20 Lbs	1
3500-10K	Plain Steel	10 Ft	.79 Lbs	20
3500-50K	Plain Steel	50 Ft	4.44 Lbs	1
3500-100K	Plain Steel	100 Ft	8.60 Lbs	1
3700-10	Plastic	10 Ft	0.095 Lbs	1
3700-50	Plastic	50 Ft	0.63 Lbs	1
3700-100	Plastic	100 Ft	1.265 Lbs	1

Manufactured At Our Rhode Island Facility

Hang It Faster!!!



Series 1000 Galvanized DWV Hangers

Size Range: 1 1/2" – 4" Available in 3 lengths: 12", 24" and 36"

Material: Carbon Steel

Finish: Galvanized Plating

Function: Designed for rapid installation of both ABS and PVC plastic DWV piping systems.

Our Galvanized DWV Hangers have patented keyholes that allow for faster and easier installation which makes for a labor saving, more profitable job. Simply pre screw or nail the floor joists where the length of pipe is to be installed, slip the hangers over the pipe, do not open the hanger. Lift the pipe by the hangers and slide the hanger over the screws that have been mounted into the floor joists.



*Nails are Included and
Packaged In Bags*

Part #	Size	Finish	Weight	Packaged
1000-1	1 1/2" x 12"	Galvanized	.21 Lbs	25
1000-2	2" x 12"	Galvanized	.29 Lbs	25
1000-3	3" x 12"	Galvanized	.39 Lbs	25
1000-4	4" x 12"	Galvanized	.47 Lbs	25
1000-1-24	1 1/2" x 24"	Galvanized	.32 Lbs	25
1000-2-24	2" x 24"	Galvanized	.39 Lbs	25
1000-3-24	3" x 24"	Galvanized	.51 Lbs	25
1000-4-24	4" x 24"	Galvanized	.61 Lbs	25
1000-1-36	1 1/2" x 36"	Galvanized	.42 Lbs	25
1000-2-36	2" x 36"	Galvanized	.54 Lbs	25
1000-3-36	3" x 36"	Galvanized	.62 Lbs	25
1000-4-36	4" x 36"	Galvanized	.75 Lbs	25

Manufactured At Our Rhode Island Facility

Hang It Faster!!!

34 Canal Street-Westerly, RI 02891-Tel: 401-596-8062 Fax: 401-596-8063
www.WarwickHanger.com



Series 1300 Plastic Coated DWV Hangers

Size Range: 1 1/2" – 4" Available in 3 lengths 12", 24" and 36"

Material: Carbon Steel

Finish: Galvanized Plating

Function: Designed for rapid installation of both ABS and PVC plastic DWV piping systems.

Our Plastic Coated DWV Hangers have patented keyholes that allow for faster and easier installation which makes for a labor saving, more profitable job. Simply pre-screw or nail the floor joists where the length of pipe is to be installed, slip the hangers over the pipe, do not open the hanger. Lift the pipe by the hangers and slide the hanger over the screws that have been mounted into the floor joists.



*Nails are Included and
Packaged In Bags*

Part #	Size	Finish	Weight	Packaged
1300-1	1 1/2" x 12"	Plastic Coated	.25 Lbs	25
1300-2	2" x 12"	Plastic Coated	.35 Lbs	25
1300-3	3" x 12"	Plastic Coated	.45 Lbs	25
1300-4	4" x 12"	Plastic Coated	.53 Lbs	25
1300-1-24	1 1/2" x 24"	Plastic Coated	.34 Lbs.	25
1300-2-24	2" x 24"	Plastic Coated	.41 Lbs	25
1300-3-24	3" x 24"	Plastic Coated	.53 Lbs.	25
1300-4-24	4" x 24"	Plastic Coated	.63 Lbs	25
1300-1-36	1 1/2" x 36"	Plastic Coated	.44 Lbs.	25
1300-2-36	2" x 36"	Plastic Coated	.56 Lbs	25
1300-3-36	3" x 36"	Plastic Coated	.64 Lbs.	25
1300-4-36	4" x 36"	Plastic Coated	.77 Lbs	25

Manufactured At Our Rhode Island Facility

Hang It Faster!!!

34 Canal Street-Westerly, RI 02891-Tel: 401-596-8062 Fax: 401-596-8063
www.WarwickHanger.com



Series 1100 Copper Plated DWV Hangers

Size Range: 1 1/2" – 4"

Material: Carbon Steel

Finish: Copper Plating

Function: Designed for rapid installation of both ABS and PVC plastic DWV piping systems.

Our Copper Plated DWV Hangers have patented keyholes that allow for faster and easier installation which makes for a labor saving, more profitable job. Simply pre-screw or nail the floor joists where the length of pipe is to be installed, slip the hangers over the pipe, do not open the hanger. Lift the pipe by the hangers and slide the hanger over the screws that have been mounted into the floor joists.

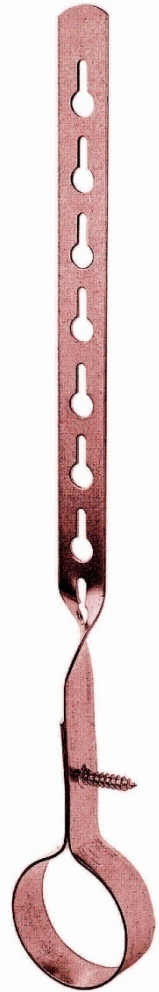

*Nails are Included and
Packaged In Bags*

Part #	Size	Finish	Weight	Packaged
1100-1	1 1/2" x 12"	Copper Plated	.25 Lbs	25
1100-2	2" x 12"	Copper Plated	.35 Lbs	25
1100-3	3" x 12"	Copper Plated	.47 Lbs	25
1100-4	4" x 12"	Copper Plated	.54 Lbs	25

Manufactured At Our Rhode Island Facility

Hang It Faster!!!

34 Canal Street-Westerly, RI 02891-Tel: 401-596-8062 Fax: 401-596-8063
www.WarwickHanger.com

Series 1050
Galvanized DWV Hangers Heavy
Material Width 1"

Size Range: 1 1/2" – 4"

Material: Carbon Steel

Finish: Galvanized Plating

Function: Designed for rapid installation of both ABS and PVC plastic DWV piping systems.

Part #	Size	Finish	Packaged
1050-1	1 1/2" x 12"	Galvanized	25
1050-2	2" x 12"	Galvanized	25
1050-3	3" x 12"	Galvanized	25
1050-4	4" x 12"	Galvanized	25

Series 1350
Plastic Coated DWV Hangers
Material Width 1"

Size Range: 1 1/2" – 4"

Material: Carbon Steel

Finish: Galvanized Plating

Function: Designed for rapid installation of both ABS and PVC plastic DWV piping systems.

Part #	Size	Finish	Packaged
1350-1	1 1/2" x 12"	Plastic Coated	25
1350-2	2" x 12"	Plastic Coated	25
1350-3	3" x 12"	Plastic Coated	25
1350-4	4" x 12"	Plastic Coated	25

Manufactured At Our Rhode Island Facility

Hang It Faster!!!





Series 1001 & 1002 Spiral Vent & Z-Vent Hanger

Size Range: 3" - 6" Available in 3 lengths 12", 24" and 36"

Material: Carbon Steel

Finish: Galvanized

Function: Designed for rapid installation of both ABS and PVC plastic Vent or Z Vent piping systems.

Our Spiral Vent and Z Vent Hangers have patented keyholes that allow for faster and easier installation which makes for a labor saving, more profitable job. Simply pre-screw or nail the floor joists where the length of pipe is to be installed, slip the hangers over the pipe, do not open the hanger. Lift the pipe by the hangers and slide the hanger over the screws that have been mounted into the floor joists.

Part #	Size	Finish	Weight	Packaged
1001-4	4" x 12" Spiral Vent	Galvanized	.49 Lbs	25
1001-5	5" x 12" Spiral Vent	Galvanized	.59 Lbs	25
1001-6	6" x 12" Spiral Vent	Galvanized	.73 Lbs	25
1002-3	3" x 12" Z Vent	Galvanized	.39 Lbs	25
1002-4	4" x 12" Z Vent	Galvanized	.285 Lbs	25

Manufactured At Our Rhode Island Facility

Hang It Faster!!!

34 Canal Street-Westerly, RI 02891-Tel: 401-596-8062 Fax: 401-596-8063
www.WarwickHanger.com

Series 1425 Glide Lock J Hook

Size Range: 1 1/2" – 4"

Function: The New Glide Lock J Hook allows pipe to glide back and forth to easily achieve your fit and gluing needs. Then simply apply pressure to the ratchet arm to lock pipe securely in place.

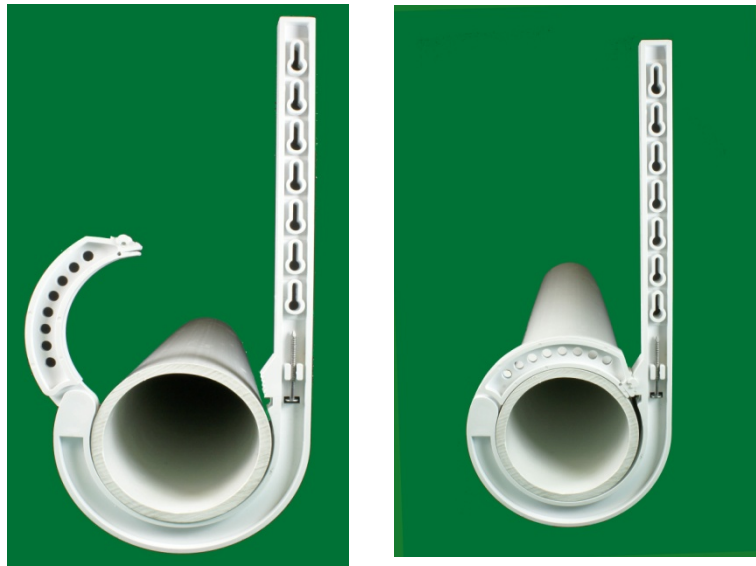

Part #	Size	Type	Packaged
1425-1	1 1/2" x 7"	DWV	25
1425-2	2" x 7"	DWV	25
1425-3	3" x 7"	DWV	25
1425-4	4" x 7"	DWV	25

Hang It Faster!!!



See video demo @ www.WarwickHanger.com

Series 1400 Plastic J Hook for DWV and CTS

Size Range: 1/2" – 4"

Function: The J-Hook is an exceptional hanger that saves time and money. Hugs pipes snug and secure at easily determined grades. Snap in lock feature holds pipe securely, glue able with same adhesive used for pipe fittings. 3" hook fits both Sch30 and Sch40.

Part #	Size	Type	Packaged
1400-1	1 1/2" x 8"	DWV	25
1400-2	2" x 8"	DWV	25
1400-3	3" x 8"	DWV	25
1400-4	4" x 8"	DWV	25
1400-5	1/2" x 4"	CTS	25
1400-6	3/4" x 4"	CTS	25
1400-7	1" x 4"	CTS	25
1400-8	1 1/4" x 4"	CTS	25
1400-9	1/2" x 7"	CTS	25
1400-10	3/4" x 7"	CTS	25
1400-11	1" x 7"	CTS	25
1400-12	1/2" x 1/2" x 4"	CTS	25
1400-13	3/4" x 3/4" x 4"	CTS	25

Hang It Faster!!!

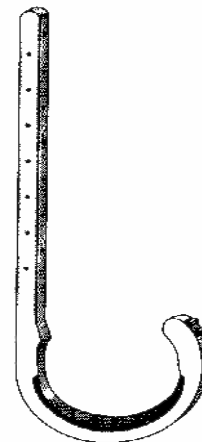



Series IMP1000 Imported Galvanized DWV Hangers

Size Range: 1 1/2" – 4"

Material: Carbon Steel

Finish: Galvanized Plating

Function: Designed for installation of both ABS and PVC plastic DWV piping systems.

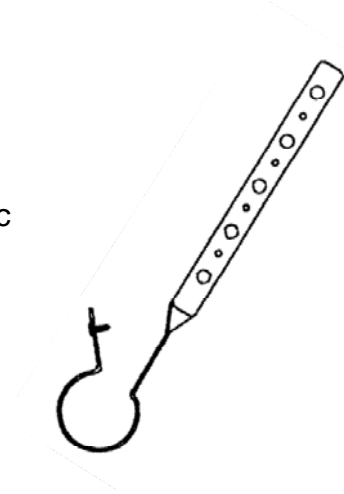

Part #	Size	Finish	Weight	Packaged
IMP1000-1	1 1/2" x 12"	Galvanized	.21 Lbs	25
IMP1000-2	2" x 12"	Galvanized	.29 Lbs	25
IMP1000-3	3" x 12"	Galvanized	.39 Lbs	25
IMP1000-4	4" x 12"	Galvanized	.47 Lbs	25

Hang It Faster!!!



Series IMP1300 Import Plastic Coated DWV Hangers

Size Range: 1 1/2" – 4"

Material: Carbon Steel

Finish: Galvanized Plating

Function: Designed for installation of both ABS and PVC plastic DWV piping systems.

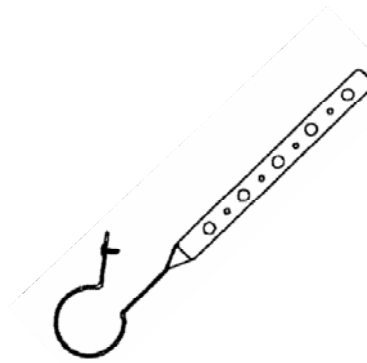

Part #	Size	Finish	Weight	Packaged
IMP1300-1	1 1/2" x 12"	Plastic Coated	.24 Lbs	25
IMP1300-2	2" x 12"	Plastic Coated	.35 Lbs	25
IMP1300-3	3" x 12"	Plastic Coated	.45 Lbs	25
IMP1300-4	4" x 12"	Plastic Coated	.53 Lbs	25

Hang It Faster!!!



Series 700 - - 725 - - 750 - - 900 - - 950 Nailing Plates

Gauge Range: 16 - 18

Material: Galvanized or plain hardened steel

Function: Used to protect pipes from nail punctures

700 + 750 -Self nailing points

715 + 725 - Nailing holes only

Part #	Size	Gauge	Weight	Packaged
700-3	1 1/2" x 3"	18	.05 Lbs	100
700-5	1 1/2" x 5"	18	.09 Lbs	100
700-6	1 1/2" x 6"	18	.11 Lbs	100
700-9	1 1/2" x 9"	18	.34 Lbs	25
700-18	1 1/2" X 18"	18	.68 Lbs	25
700-20	2 3/4" X 8 3/4"	16	.35 Lbs	25
700-22	1 1/2" X 22"	18	.74 Lbs	25
700-23	3 1/2" X 5 3/4"	16	.35 Lbs	25
700-28	1 1/2" X 28"	18	.83 Lbs	25
715-3	1 1/2" X 3"	16	.07 Lbs	100
715-5	1 1/2" X 5"	16	.12 Lbs	100
715-6	1 1/2" X 6"	16	.13 Lbs	100
725-3	1 1/2" X 3"	18	.05 Lbs	100
725-5	1 1/2" X 5"	18	.09 Lbs	100
725-6	1 1/2" X 6"	18	.11 Lbs	100
730-8	5" x 8"	16	.60 Lbs	25
750-3	1 1/2" X 3"	16	.07 Lbs	100
750-5	1 1/2" X 5"	16	.12 Lbs	100
750-6	1 1/2" X 6"	16	.13 Lbs	100
920-9	3" X 9"	18	.25 Lbs	25
920-18	3" X 18"	18	.35 Lbs	25
935-5	3 1/2" X 5"	16	.48 Lbs	25
935-6	3 1/2" X 6"	16	.51 Lbs	25
955-8	5" X 8"	16	.65 Lbs	25
955-16	5" X 16 5/16"	16	1.33 Lbs	25



Hang It Faster!!!

Manufactured At Our Rhode Island Facility

34 Canal Street-Westerly, RI 02891-Tel: 401-596-8062 Fax: 401-596-8063
www.WarwickHanger.com

Series 2100
Copper Plated Split Ring Hangers



2- Screw

Size Range: 3/8" – 4"

Material: Malleable Iron

Finish: Copper Plated

Function: For suspending non-insulated stationary pipe lines.

Our Copper Plated Split Ring Hangers are used to suspend copper tubing from joists, steel beams, wooden rafters or walls. They can be used in both horizontal and vertical applications.



Hinged

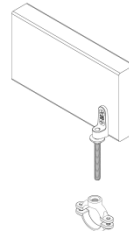

Part #	Size	Rod Size	Weight	Packaged
2100-1	3/8"	3/8"	.07 Lbs	25
2100-2	1/2"	3/8"	.07 Lbs	25
2100-3	3/4"	3/8"	.09 Lbs	25
2100-4	1"	3/8"	.11 Lbs	25
2100-5	1 1/4"	3/8"	.12 Lbs	25
2100-6	1 1/2"	3/8"	.17 Lbs	25
2100-7	2"	3/8"	.22 Lbs	25
2100-8	2 1/2"	1/2"	.42 Lbs	25
2100-9	3"	1/2"	.48 Lbs	25
2100-10	4"	1/2"	.60 Lbs	25

For hinged add the letter "H" to the part number:

Example: 2100-1 Copper Split Ring Hanger 2 Screw

2100-1-H Copper Split Ring Hanger Hinged

All Split Ring Hangers are available with an Epoxy coating.

For Epoxy Finish add the letters "EPX" to the part number:

Example: 2100-1-EPX

Hang It Faster!!!

Series 2000
Galvanized Split Ring Hangers

Size Range: 3/8"-4"

Material: Malleable Iron

Finish: Galvanized

Function: For suspending non-insulated stationary pipe lines.

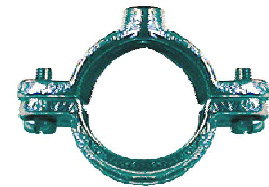

2- Screw

Our Galvanized Split Ring Hangers are used to suspend black iron pipe from joist, steel beams, wooden rafters or walls. They can be used in both horizontal and vertical applications.



Hinged

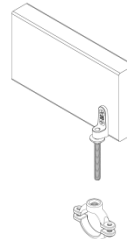

Part #	Size	Rod Size	Weight	Packaged
2000-1	3/8"	3/8"	.12 Lbs	25
2000-2	1/2"	3/8"	.12 Lbs	25
2000-3	3/4"	3/8"	.13 Lbs	25
2000-4	1"	3/8"	.14 Lbs	25
2000-5	1 1/4"	3/8"	.19 Lbs	25
2000-6	1 1/2"	3/8"	.20 Lbs	25
2000-7	2"	3/8"	.30 Lbs	25
2000-8	2 1/2"	1/2"	.40 Lbs	25
2000-9	3"	1/2"	.57 Lbs	25
2000-10	4"	1/2"	.67 Lbs	25

For hinged add the letter "H" to the part number:
Example: 2000-1 Galvanized Split Ring Hanger 2 Screw
2000-1-H Galvanized Split Ring Hanger Hinged

Hang It Faster!!!

Series 2200 Black Split Ring Hangers

Size Range: 3/8"– 4"

Material: Malleable Iron

Finish: Plain

Function: For suspending non-insulated stationary pipe lines.

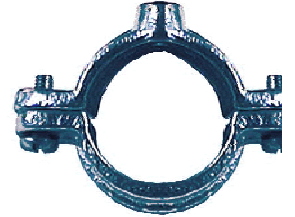

2- Screw

Our Black Split Ring Hangers are used to suspend black iron pipe from joists, steel beams, wooden rafters or walls. They can be used in both horizontal and vertical applications.



Hinged

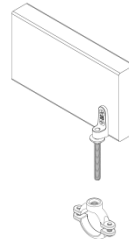

Part #	Size	Rod Size	Weight	Packaged
2200-1	3/8"	3/8"	.08 Lbs	25
2200-2	1/2"	3/8"	.10 Lbs	25
2200-3	3/4"	3/8"	.11 Lbs	25
2200-4	1"	3/8"	.19 Lbs	25
2200-5	1 1/4"	3/8"	.23 Lbs	25
2200-6	1 1/2"	3/8"	.25 Lbs	25
2200-7	2"	3/8"	.30 Lbs	25
2200-8	2 1/2"	1/2"	.45 Lbs	25
2200-9	3"	1/2"	.49 Lbs	25
2200-10	4"	1/2"	.61 Lbs	25

For hinged add the letter "H" to the part number:
Example: 2200-1 Plain Split Ring Hanger 2 Screw
2200-1-H Plain Split Ring Hanger Hinged

Hang It Faster!!!

Series 2600 Copper Plated Adjustable Band Hangers

Size Range: 1/2"-6"

Material: Carbon Steel

Finish: Copper Plating

Function: Used for the suspension of both non-insulated and insulated piping.



Our Copper Plated A-Band Tubing Hangers are made out of 17 gage material. They are used to suspend copper tubing from joists, wooden rafters, and steel beams. Use in conjunction with threaded rod to achieve various heights.

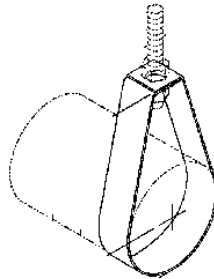

Part #	Size	Rod Size	Finish	Weight	Packaged
2600-1	1/2"	3/8"	Copper Plated	.10 Lbs	25
2600-2	3/4"	3/8"	Copper Plated	.10 Lbs	25
2600-3	1"	3/8"	Copper Plated	.10 Lbs	25
2600-4	1 1/4"	3/8"	Copper Plated	.11 Lbs	25
2600-5	1 1/2"	3/8"	Copper Plated	.12 Lbs	25
2600-6	2"	3/8"	Copper Plated	.13 Lbs	25
2600-7	2 1/2"	1/2"	Copper Plated	.19 Lbs	25
2600-8	3"	1/2"	Copper Plated	.27 Lbs	25
2600-10	4"	5/8"	Copper Plated	.44 Lbs	25
2600-11	5"	5/8"	Copper Plated	.66 Lbs	25
2600-12	6"	3/4"	Copper Plated	.69 Lbs	25

Hang It Faster!!!

Series 2500
Plain Adjustable Band Hangers

Size Range: 1/2" – 6"

Material: Carbon Steel

Finish: Plain

Function: Used for the suspension of both non-insulated and insulated pipe.



Our Plain Steel A-Band Black Iron Pipe Hangers are made out of 17 gage material. They are used to suspend Black Iron Pipe from joists, wooden rafters, and steel beams. Use in conjunction with threaded rod to achieve various heights.

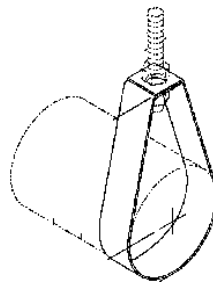

Part #	Size	Rod Size	Finish	Gauge	Weight	Packaged
2500-1	1/2"	3/8"	Plain	18	.09 Lbs	25
2500-2	3/4"	3/8"	Plain	18	.09 Lbs	25
2500-3	1"	3/8"	Plain	18	.11 Lbs	25
2500-4	1 1/4"	3/8"	Plain	18	.12 Lbs	25
2500-5	1 1/2"	3/8"	Plain	18	.13 Lbs	25
2500-6	2"	3/8"	Plain	18	.16 Lbs	25
2500-7	2 1/2"	1/2"	Plain	16	.25 Lbs	25
2500-8	3"	1/2"	Plain	16	.33 Lbs	25
2500-9	3 1/2"	1/2"	Plain	16	.45 Lbs	25
2500-10	4"	5/8"	Plain	16	.58 Lbs	25
2500-11	5"	5/8"	Plain	11	1.00 Lbs	10
2500-12	6"	3/4"	Plain	11	1.25 Lbs	10

Manufactured At Our Rhode Island Facility

Hang It Faster!!!

Series 2950 Copper Plated Swivel Hanger

Size Range: 1/2" – 4"

Material: Carbon Steel

Finish: Copper Plated

Function: Used for the suspension of non-insulated stationary copper tubing.



Our Copper Plated Swivel Hanger is used for general piping purposes. Knurled swivel nut design permits hanger adjustment after installation. Spring tension on swivel nut holds it securely in hanger before installation. Swivel nut easily removed.

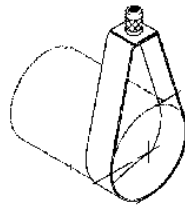

Part #	Size	Finish	Weight	Knurl Nut Size	Packaged
2950-1	1/2"	Copper Plated	.15 Lbs	3/8"	25
2950-2	3/4"	Copper Plated	.15 Lbs	3/8"	25
2950-3	1"	Copper Plated	.16 Lbs	3/8"	25
2950-4	1 1/4"	Copper Plated	.18 Lbs	3/8"	25
2950-5	1 1/2"	Copper Plated	.20 Lbs	3/8"	25
2950-6	2"	Copper Plated	.22 Lbs	3/8"	25
2950-7	2 1/2"	Copper Plated	.28 Lbs	3/8"	25
2950-8	3"	Copper Plated	.30 Lbs	3/8"	25
2950-10	4"	Copper Plated	.33 Lbs	5/8"	25

Manufactured At Our Rhode Island Facility

Hang It Faster!!!

Series 2900 Galvanized Swivel Hangers

Size Range: 1/2"-8"

Material: Carbon Steel

Finish: Galvanized

Function: Used for the suspension of both non-insulated and insulated piping.



Our Galvanized Swivel Hanger is used for general piping purposes. Knurled swivel nut design permits hanger adjustment after installation. Spring tension on swivel nut holds it securely in hanger before installation. Swivel nut easily removed.

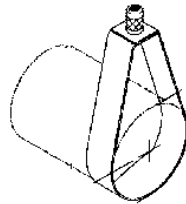

Part #	Size	Finish	Weight	Knurl Nut Size	Packaged
2900-1	1/2"	Galvanized	.15 Lbs	3/8"	25
2900-2	3/4"	Galvanized	.15 Lbs	3/8"	25
2900-3	1"	Galvanized	.16 Lbs	3/8"	25
2900-4	1 1/4"	Galvanized	.18 Lbs	3/8"	25
2900-5	1 1/2"	Galvanized	.20 Lbs	3/8"	25
2900-6	2"	Galvanized	.22 Lbs	3/8"	25
2900-7	2 1/2"	Galvanized	.37 Lbs	3/8"	25
2900-8	3"	Galvanized	.44 Lbs	3/8"	25
2900-9	3 1/2"	Galvanized	.51 Lbs	3/8"	25
2900-10	4"	Galvanized	.56 Lbs	3/8"	25
2900-11	5"	Galvanized	.97 Lbs	1/2"	25
2900-12	6"	Galvanized	1.10 Lbs	1/2"	25
2900-13	8"	Galvanized	1.38 Lbs	1/2"	25

Manufactured At Our Rhode Island Facility

Hang It Faster!!!

Series 650 Copper Plated Strut Clamps

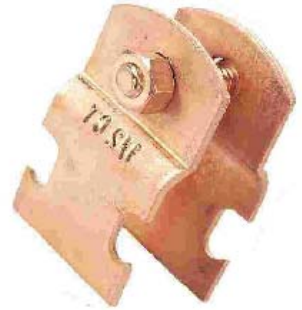

Size Range: 1/2" – 4"

Material: Carbon Steel

Finish: Copper Plating

Function: The copper pipe clamps are designed for copper tubing and used at any point along the slot side of the channel strut.

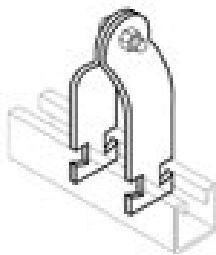

Part #	Size	Weight	Packaged
650-2	1/2"	.07 Lbs	25
650-3	3/4"	.09 Lbs	25
650-4	1"	.11 Lbs	25
650-5	1 1/4"	.12 Lbs	25
650-6	1 1/2"	.17 Lbs	25
650-7	2"	.22 Lbs	25
650-8	2 1/2"	.42 Lbs	25
650-9	3"	.48 Lbs	25
650-10	3 1/2"	.60 Lbs	25
650-11	4"	.72 Lbs	25

Hang It Faster!!!

Series 600 Galvanized Strut Clamps

Size Range: 1/2"-8"

Material: Carbon Steel

Finish: Galvanized

Function: Used at any point along the slot side of the channel strut and are inserted into the two channel returns.



The galvanized pipe clamps are designed for black iron pipe, PVC and ABS for fastening of the piping for any industry.



Part #	Size	Weight	Packaged
600-2	1/2"	.12 Lbs	25
600-3	3/4"	.13 Lbs	25
600-4	1"	.14 Lbs	25
600-5	1 1/4"	.19 Lbs	25
600-6	1 1/2"	.20 Lbs	25
600-7	2"	.30 Lbs	25
600-8	2 1/2"	.40 Lbs	25
600-9	3"	.57 Lbs	25
600-10	3 1/2"	.67 Lbs	25
600-11	4"	.79 Lbs	25
600-12	5"	.94 Lbs	25
600-13	6"	1.24 Lbs	25
600-14	8"	1.41 Lbs	25

Hang It Faster!!!



Series 675-690-691 Cushion Clamps

Size Range: 3/16" – 6"

Material: Carbon Steel

Finish: Galvanized

Function: Used to absorb shock and vibration. Reduces unwanted noise and prevents galvanic corrosion.

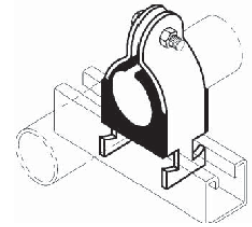

Cushion Clamps provide fast and simple installation. Reduced noise, shock and vibration caused by fluid surges.

Part #	Size	O.D. Size	Weight	Packaged
675-1	5/8"	3/4"	.13 Lbs	25
675-2	3/16"	1/4"	.10 Lbs	25
675-3	1/4"	3/8"	.10 Lbs	25
675-4	3/8"	1/2"	.13 Lbs	25
675-5	1/2"	5/8"	.14 Lbs	25
675-6	3/4"	7/8"	.15 Lbs	25
675-7	1"	1 1/8"	.15 Lbs	25
675-8	1 1/4"	1 3/8"	.17 Lbs	25
675-9	1 1/2"	1 5/8"	.18 Lbs	25
675-10	2"	2 1/8"	.20 Lbs	25
675-11	2 1/2"	2 5/8"	.33 Lbs	10
675-12	3"	3 1/8"	.60 Lbs	10
675-13	4"	4 1/8"	.90 Lbs	10
675-14	5"	5 1/8"	1.3 Lbs	10
675-15	6"	6 1/8"	1.4 Lbs	10



675-20	20' Roll	Cushion Strip	1
--------	----------	---------------	---

Strut

Part #	Description	Gauge	Packaged
690-10	Strut 1 5/8" X 13/16" X 5'	12	1
690-15	Strut 1 5/8" X 1 5/8" X 5'	12	1
691-10	Strut 1 5/8" X 13/16" X 10'	12	1
691-15	Strut 1 5/8" X 1 5/8" X 10'	12	1



Series 2750 Copper Plated Clevis Hangers

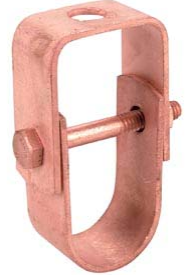

Size Range: 1/2" - 4"

Material: Carbon Steel

Finish: Copper Plating

Function: Used to suspend non-insulated stationary black iron pipe from steel beams.

Our Clevis Hanger is used in conjunction with threaded rod to achieve various heights. It allows the pipe to feed through the U portion of the hanger. Used in horizontal pipe runs.

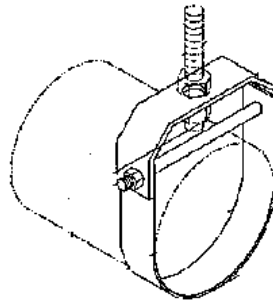

Part #	Size	Rod Size	Weight	Packaged
2750-1	1/2"	3/8"	.26 Lbs	25
2750-2	3/4"	3/8"	.28 Lbs	25
2750-3	1"	3/8"	.30 Lbs	25
2750-4	1 1/4"	3/8"	.33 Lbs	25
2750-5	1 1/2"	3/8"	.35 Lbs	25
2750-6	2"	3/8"	.41 Lbs	25
2750-7	2 1/2"	3/8"	.70 Lbs	10
2750-8	3"	3/8"	.91 Lbs	10
2750-10	4"	1/2"	1.05 Lbs	10

Hang It Faster!!!

Series 2700 Carbon Steel Clevis Hangers



Size Range: 1/2" – 12"

Material: Carbon steel

Finish: Plain

Function: Used to suspend non-insulated stationary black iron pipe from steel beams.

Our Clevis Hanger is used in conjunction with threaded rod to achieve various heights. It allows the pipe to feed through the U portion of the hanger. Used in horizontal pipe runs.

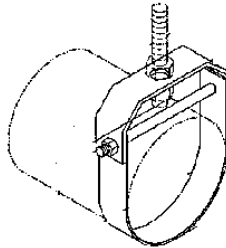

Part #	Size	Rod Size	Weight	Packaged
2700-1	1/2"	3/8"	.35 Lbs	25
2700-2	3/4"	3/8"	.36 Lbs	25
2700-3	1"	3/8"	.39 Lbs	25
2700-4	1 1/4"	3/8"	.41 Lbs	25
2700-5	1 1/2"	3/8"	.45 Lbs	25
2700-6	2"	3/8"	.52 Lbs	25
2700-7	2 1/2"	3/8"	1.10 Lbs	25
2700-8	3"	3/8"	1.50 Lbs	25
2700-9	3 1/2"	3/8"	1.59 Lbs	25
2700-10	4"	1/2"	1.90 Lbs	25
2700-11	5"	1/2"	2.40 Lbs	5
2700-12	6"	3/4"	3.10 Lbs	5
2700-13	8"	3/4"	4.37 Lbs	5
2700-14	10"	3/4"	7.82 Lbs	5
2700-15	12"	7/8"	10.38 Lbs	5

Hang It Faster!!!

Series 2850 Copper Riser Clamps

Size Range: 1/2"-4"

Material: Carbon Steel

Finish: Copper Plating

Function: Used for supporting black iron piping through floors.

Our Riser Clamp is used for the support of steel or cast iron pipe lines where extreme load conditions exist. The Riser Clamp utilizes the structure to support the legs on each end of clamp, normally rests on the floor through which the riser passes.

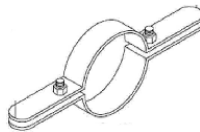

Part #	Size	Material	Weight	Packaged
2850-1	1/2"	Carbon Steel	1.44 Lbs	25
2850-2	3/4"	Carbon Steel	1.44 Lbs	25
2850-3	1"	Carbon Steel	1.47 Lbs	25
2850-4	1 1/4"	Carbon Steel	1.50 Lbs	25
2850-5	1 1/2"	Carbon Steel	1.55 Lbs	25
2850-6	2"	Carbon Steel	1.69 Lbs	10
2850-7	2 1/2"	Carbon Steel	2.20 Lbs	10
2850-8	3"	Carbon Steel	2.50 Lbs	10
2850-10	4"	Carbon Steel	3.49 Lbs	10

Hang It Faster!!!

Series 2800 Riser Clamps

Size Range: 1/2"-12"

Material: Carbon Steel

Finish: Plain

Function: Used for supporting black iron piping through floors.

Our Riser Clamp is used for the support of steel or cast iron pipe lines where extreme load conditions exist. The Riser Clamp utilizes the structure to support the legs on each end of clamp, normally rests on the floor through which the riser passes.

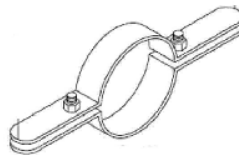

Part #	Size	Material	Weight	Packaged
2800-1	1/2"	Carbon Steel	1.44 Lbs	25
2800-2	3/4"	Carbon Steel	1.44 Lbs	25
2800-3	1"	Carbon Steel	1.47 Lbs	25
2800-4	1 1/4"	Carbon Steel	1.50 Lbs	25
2800-5	1 1/2"	Carbon Steel	1.55 Lbs	25
2800-6	2"	Carbon Steel	1.69 Lbs	10
2800-7	2 1/2"	Carbon Steel	2.20 Lbs	10
2800-8	3"	Carbon Steel	2.50 Lbs	10
2800-9	3 1/2"	Carbon Steel	2.63 Lbs	10
2800-10	4"	Carbon Steel	3.49 Lbs	10
2800-11	5"	Carbon Steel	3.90 Lbs	5
2800-12	6"	Carbon Steel	5.55 Lbs	5
2800-13	8"	Carbon Steel	7.80 Lbs	5
2800-14	10"	Carbon Steel	9.72 Lbs	5
2800-15	12"	Carbon Steel	12.60 Lbs	5

Hang It Faster!!!

Series 2825 & 2875 Short Arm Riser Clamps

Size Range: 1 1/2" – 4"

Material: Carbon Steel

Finish: Plain And Plastic Coated

Function: Used for supporting black iron piping through floors.



Our Riser Clamp is used for the support of PVC or ABS pipe lines where extreme load conditions exist. The Riser Clamp utilizes the structure to support the legs on each end of clamp, normally rests on the floor through which the riser passes.

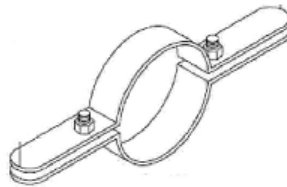

Part #	Size	Material	Weight	Packaged
2825-5	1 1/2" Black	Carbon Steel	.52 Lbs	25
2825-6	2" Black	Carbon Steel	.55 Lbs	10
2825-8	3" Black	Carbon Steel	.72 Lbs	10
2825-10	4" Black	Carbon Steel	.89 Lbs	10
2875-5	1 1/2" Plastic Coated	Carbon Steel	.58 Lbs	10
2875-6	2" Plastic Coated	Carbon Steel	.65 Lbs	10
2875-8	3" Plastic Coated	Carbon Steel	.85 Lbs	10
2875-10	4" Plastic Coated	Carbon Steel	1.01 Lbs	10

Hang It Faster!!!

Series 2840 Double Bolt Clamps

Size Range: 3" – 6"

Material: Carbon Steel

Finish: Plain

Function: Recommended for the suspension of heavy duty high temperature pipe runs. This design allows flexibility of clamp installation.

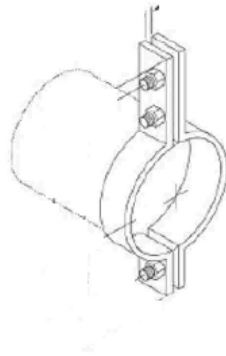

Part #	Size	Material	Packaged
2840-8	3"	Carbon Steel	10
2840-10	4"	Carbon Steel	10
2840-12	6"	Carbon Steel	5

Hang It Faster!!!

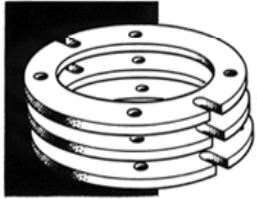
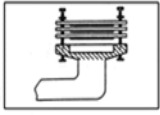

Closet Flange Extension Kit



Adjustable Closet Flange

Flanges

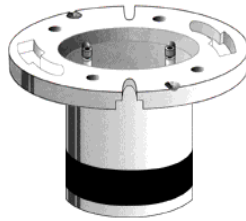

Street Compression Flange



Adjustable Street Closet Flange



Closet Flange Replacement

Part #	Size	Package
CF300A	1/4" Closet Flange Extension Kit (ABS)	12
CF300P	1/4" Closet Flange Extension Kit (PVC)	12
CF350P	1/4" Closet Flange Extension (PVC)	12
CF250P	Closet Flange Extension Kit Bulk (PVC)	10
GF340A	Adjustable 3" X 4" Closet Flange (ABS)	12
GF340P	Adjustable 3" X 4" Closet Flange (PVC)	12
GH950A	Street Compression 4" Closet Flange (ABS)	12
GH950P	Street Compression 4" Closet Flange (PVC)	12
IF333A	Adjustable 3" Street Closet Flange (ABS)	12
IF333P	Adjustable 3" Street Closet Flange (PVC)	12
MH350A	3" Closet Flange Replace. Comp. (ABS)	12
MH350P	3" Closet Flange Replace. Comp. (PVC)	12
MH450P	4" Closet Flange Replace. Comp. (PVC)	12

Hang It Faster!!!

Series 700 Stud Protectors



Size Range: Single and Double Stud Protection.

Material: Carbon Steel

Finish: White Enamel

Function: Stud shoes reinforce studs notched in construction.

Stud Shoes provide tension load capacity as well as increased compression loads. Flared flanges provides greater strength. Installs over pipe up to 2 3/8" outside diameter.

Part #	Size	Gauge	Weight	Packaged
700-50	Single Stud Protector	18	.45 Lbs	25
700-51	Double Stud Protector	18	.52 Lbs	25

Hang It Faster!!!

**Series 1550
 Pipe Shields**



Size Range: 1 1/2" – 10"

Material: Carbon Steel

Finish: Galvanized Plating

Function: To protect pipe insulation when used with hangers.

Designed for protection of foam, fiberglass or high density insulation when used with pipe hangers.

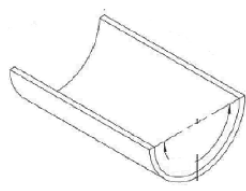

Part #	Size	Packaged
1550-1	1 1/2" x 10"	25
1550-2	2" x 10"	25
1550-3	2 1/2" x 10"	25
1550-4	3" x 10"	25
1550-5	4" x 10"	25
1550-6	5" x 10"	25
1550-7	6" x 10"	25
1550-8	8" x 10"	25
1550-9	10" x 10"	25

Hang It Faster!!!

Series 2004-2104-2024 Top Beams

Size Range: 3/8" – 1/2"

Material: Malleable Iron

Finish: Plain

Function: Used in conjunction with a wide variety of pipe hangers.



Our Top Beam Clamp is designed to clamp onto a steel I beam and is used in conjunction with threaded rod. The clamp has a threaded hole to accept a piece of threaded rod allowing various types of pipe hangers to be threaded on to the opposite end of the rod.

Part #	Junior Size	Rod Size	Weight	Packaged
2004-C-P	3/8"	3/8"	.30 Lbs	25
2004-D-P	1/2"	1/2"	.35 Lbs	25

Part #	Senior Size	Rod Size	Weight	Packaged
2104-C-P	3/8"	3/8"	.40 Lbs	25
2104-D-P	1/2"	1/2"	.49 Lbs	25

Beam Clamp/Retaining Strap

Size Range: 4" – 24"

Material: Galvanized

Function: Used to secure top beam and c-clamps to a metal beam, girder or similar structure. Simply slide keyhole in retaining strap over bolt on clamp, then bend retaining strap around metal beam or girder.

Part #	Size	Weight	Packaged
2024-1	4"	.060	25
2024-2	6"	.090	25
2024-3	8"	.120	25
2024-4	10"	.155	25
2024-5	12"	.190	25
2024-6	14"	.210	25
2024-7	16"	.270	25
2024-8	20"	.330	25
2024-9	24"	.385	25



Series 2002-2003 Side Beam Connectors

Size Range: 3/8" – 1/2"

Material: Malleable Iron

Finish: Plain

Function: Used to mount threaded rod.



Our Side Beam Connector is designed to mount onto a steel beam or joist and is used in conjunction with threaded rod. It has a threaded hole to accept threaded rod allowing various types of pipe hangers to be threaded on to the opposite end of the rod.

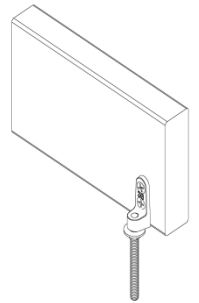

Part #	Size	Rod Size	Weight	Packaged
2003-C	3/8"	3/8"	.12 Lbs	25
2003-D	1/2"	1/2"	.17 Lbs	25

Ceiling Flange

Size Range: 3/8"–1/2" Threaded Rod

Material: Malleable Iron

Finish: Plain, Galvanized and Copper

Function: Used to mount threaded rod.



Our Ceiling Flanges are used in conjunction with threaded rod. The flanges can be mounted to most surfaces. The center hole accepts a piece of 3/8 threaded rod allowing various types of pipe hangers to be threaded on to the opposite end of the rod.

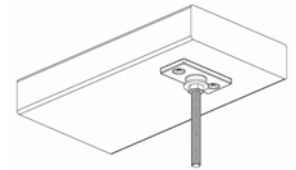

Part #	Finish	Rod Size	Weight	Packaged
2002-A-P	Plain	1/4"	.14 Lbs	25
2002-C-P	Plain	3/8"	.14 Lbs	25
2002-D-P	Plain	1/2"	.14 Lbs	25
2002-A-G	Galvanized	1/4"	.16 Lbs	25
2002-C-G	Galvanized	3/8"	.16 Lbs	25
2002-D-G	Galvanized	1/2"	.16 Lbs	25
2002-A-C	Copper Plated	1/4"	.16 Lbs	25
2002-C-C	Copper Plated	3/8"	.16 Lbs	25
2002-D-C	Copper Plated	1/2"	.16 Lbs	25

Warwick
 Hanger Company
Series 2005
Steel C-Clamp

Size Range: 3/8" - 5/8" Rod
Material: Carbon Steel
Finish: Plain and Galvanized
Function: Used to mount threaded rod.

Our Steel C-Clamp is designed to mount onto a steel beam or joist and is used in conjunction with threaded rod. It has a threaded hole to accept threaded rod allowing various types of pipe hangers to be threaded on to the opposite end of the rod.

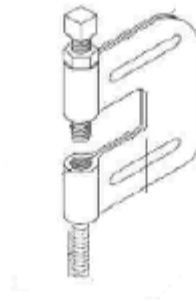

Part #	Size	Rod Size	Weight	Packaged
2005-C-P	3/8"	3/8"	.41	25
2005-D-P	1/2"	1/2"	.65	25
2005-E-P	5/8"	5/8"	.90	25
2005-F-P	3/4"	3/4"	.98	25



← See Page 53

Hang It Faster!!!

**Series 2110-2010-2111
Hardware**

Part #	Description	Finish	Size	Packaged
2110-A-G	Rod Couplings	Plated	1/4 - 20	50
2110-B-G	Rod Couplings	Plated	5/16 -18	50
2110-C-G	Rod Couplings	Plated	3/8 - 16	50
2110-D-G	Rod Couplings	Plated	1/2 - 13	50
2110-E-G	Rod Couplings	Plated	5/8 - 11	50
2110-F-G	Rod Couplings	Plated	3/4- 10	50
2110-G-G	Rod Couplings	Plated	7/8 - 9	50
2110-H-G	Rod Couplings	Plated	1 - 8	50
2010-A-G	Coupling Reducers	Plated	1/4" to 3/8"	50
2010-D-G	Coupling Reducers	Plated	3/8" to 1/2"	50



Part #	Description	Finish	Size	Packaged
2111-A-P	Lag Screws	Plain	3/8" x 4"	25
2111-B-P	Lag Screws	Plain	3/8" x 6"	25
2111-C-P	Lag Screws	Plain	3/8" x 8"	25
2111-D-P	Lag Screws	Plain	3/8" x 12"	25
2111-A-G	Lag Screws	Plated	3/8" x 4"	25
2111-B-G	Lag Screws	Plated	3/8" x 6"	25
2111-C-G	Lag Screws	Plated	3/8" x 8"	25
2111-D-G	Lag Screws	Plated	3/8" X 12"	25



Hang It Faster!!!



**Series 2006-2009
Hardware**

Part #	Description	Finish	6 Feet	Packaged
2006-A-P	Threaded Rod	Plain	1/4 - 20	50
2006-B-P	Threaded Rod	Plain	5/16-18	35
2006-C-P	Threaded Rod	Plain	3/8 - 16	25
2006-D-P	Threaded Rod	Plain	1/2 - 13	13
2006-E-P	Threaded Rod	Plain	5/8 - 11	8
2006-F-P	Threaded Rod	Plain	3/4 - 10	5
2006-G-P	Threaded Rod	Plain	7/8 - 9	4
2006-H-P	Threaded Rod	Plain	1 - 8	2
2006-A-G	Threaded Rod	Zinc Plated	1/4 - 20	50
2006-B-G	Threaded Rod	Zinc Plated	5/16-18	35
2006-C-G	Threaded Rod	Zinc Plated	3/8 - 16	25
2006-D-G	Threaded Rod	Zinc Plated	1/2 - 13	13
2006-E-G	Threaded Rod	Zinc Plated	5/8 - 11	8
2006-F-G	Threaded Rod	Zinc Plated	3/4 - 10	5
2006-G-G	Threaded Rod	Zinc Plated	7/8 - 9	4
2006-H-G	Threaded Rod	Zinc Plated	1 - 8	2



Part #	Description	Finish	Diam./Length	Packaged
2006-C-G-2 1/2"	Threaded Rod	Zinc Plated	3/8" X 2 1/2"	100
2006-C-P-1 1/2"	Threaded Rod	Plain	3/8" X 1 1/2"	100
2006-C-P-2"	Threaded Rod	Plain	3/8" X 2"	100
2006-C-P-2 1/2"	Threaded Rod	Plain	3/8" X 2 1/2"	100
2006-C-P-4"	Threaded Rod	Plain	3/8" X 4"	100
2006-C-P-6"	Threaded Rod	Plain	3/8" X 6"	100
2006-D-P-3/4"	Threaded Rod	Plain	1/2" X 3/4"	100
2006-D-P-2"	Threaded Rod	Plain	1/2" X 2"	100
2006-D-P-8"	Threaded Rod	Plain	1/2" X 8"	100



Hang It Faster!!!

34 Canal Street-Westerly, RI 02891-Tel: 401-596-8062 Fax: 401-596-8063
www.WarwickHanger.com

Series 2007 Hardware

Part #	Description	Finish	Size	Packaged
2009-A-P	Washer	Plain	1/4"	100
2009-B-P	Washer	Plain	5/16"	100
2009-C-P	Washer	Plain	3/8"	100
2009-D-P	Washer	Plain	1/2"	100
2009-E-P	Washer	Plain	5/8"	100
2009-F-P	Washer	Plain	3/4"	100
2009-G-P	Washer	Plain	7/8"	100
2009-H-P	Washer	Plain	1"	100
2009-A-G	Washer	Zinc Plated	1/4"	100
2009-B-G	Washer	Zinc Plated	5/16"	100
2009-C-G	Washer	Zinc Plated	3/8"	100
2009-D-G	Washer	Zinc Plated	1/2"	100
2009-E-G	Washer	Zinc Plated	5/8"	100
2009-F-G	Washer	Zinc Plated	3/4"	100
2009-G-G	Washer	Zinc Plated	7/8"	100
2009-H-G	Washer	Zinc Plated	1"	100



Part #	Description	Finish	Size	Packaged
2007-B-P	Heavy Hex Nut	Plain	5/16-18	100
2007-C-P	Heavy Hex Nut	Plain	3/8 - 16	100
2007-D-P	Heavy Hex Nut	Plain	1/2 - 13	100
2007-E-P	Heavy Hex Nut	Plain	5/8 - 11	100
2007-F-P	Heavy Hex Nut	Plain	3/4 - 10	100
2007-G-P	Heavy Hex Nut	Plain	7/8 - 9	100
2007-H-P	Heavy Hex Nut	Plain	1 - 8	100
2007-A-G	Heavy Hex Nut	Zinc Plated	1/4 - 20	100
2007-B-G	Heavy Hex Nut	Zinc Plated	5/16-18	100
2007-C-G	Heavy Hex Nut	Zinc Plated	3/8 - 16	100
2007-D-G	Heavy Hex Nut	Zinc Plated	1/2 - 13	100
2007-E-G	Heavy Hex Nut	Zinc Plated	5/8 - 11	100
2007-F-G	Heavy Hex Nut	Zinc Plated	3/4 - 10	100
2007-G-G	Heavy Hex Nut	Zinc Plated	7/8 - 9	100
2007-H-G	Heavy Hex Nut	Zinc Plated	1 - 8	100



Hang It Faster!!!

**Series 2128-2115-2116-2014-2300
Hardware**

Part #	Description	Finish	Packaged
2128-A-P	5/8" X 1" Heavy Hex Bolt	Plain	25
2128-B-P	5/8" X 1 1/4" Heavy Hex Bolt	Plain	25
2128-C-P	5/8" X 1 1/2" Heavy Hex Bolt	Plain	25
2128-D-P	5/8" X 2" Heavy Hex Bolt	Plain	25
2128-E-P	5/8" X 2 1/4" Heavy Hex Bolt	Plain	25
2128-F-P	5/8" X 2 1/2" Heavy Hex Bolt	Plain	25
2128-G-P	5/8" X 3" Heavy Hex Bolt	Plain	25
2128-A-G	5/8" X 1" Heavy Hex Bolt	Galvanized	25
2128-B-G	5/8" X 1 1/4" Heavy Hex Bolt	Galvanized	25
2128-C-G	5/8" X 1 1/2" Heavy Hex Bolt	Galvanized	25
2128-D-G	5/8" X 2" Heavy Hex Bolt	Galvanized	25
2128-E-G	5/8" X 2 1/4" Heavy Hex Bolt	Galvanized	25
2128-F-G	5/8" X 2 1/2" Heavy Hex Bolt	Galvanized	25
2128-G-G	5/8" X 3" Heavy Hex Bolt	Galvanized	25
2115-E	#12 X 1 1/2" Drive Screw	Plain	100
2115-F	#12 X 2" Drive Screw	Plain	100
2116-A	1/4" x 3/4" Mushroom Drive Pin	Zinc	100
2116-B	1/4" x 1" Mushroom Drive Pin	Zinc	100
2116-C	1/4" x 1 1/4" Mushroom Drive Pin	Zinc	100
2116-D	1/4" x 1 1/2" Mushroom Drive Pin	Zinc	100
2116-E	1/4" x 2" Mushroom Drive Pin	Zinc	100
2014-A	1/4" x 1 1/4 Fender Washers	Zinc	100
2014-B	5/16" x 1 1/4 Fender Washers	Zinc	100
2014-C	3/8" x 1 1/4 Fender Washers	Zinc	100
2300-C	3/8" Drop In Anchor (Uses 1/2" Drill)	Zinc	50
2300-D	1/2" Drop In Anchor	Zinc	50



Hang It Faster!!!

Series 2012-2013-2400
Strut Hardware



Part #	Description	Finish	Packaged
2012-A	1/4" Spring Nut	Plated	50
2012-C	3/8" Spring Nut	Plated	50
2012-D	1/2" Spring Nut	Plated	50
2012-E	5/8" Spring Nut	Plated	50
2012-F	3/4" Spring Nut	Plated	50
2013-A	1/4" Spring Less Nut	Plated	50
2013-C	3/8" Spring Less Nut	Plated	50
2013-D	1/2" Spring Less Nut	Plated	50
2013-E	5/8" Spring Less Nut	Plated	50
2013-F	3/4" Spring Less Nut	Plated	50
2400-8	4" X 3" Angle Bracket	Plain	25
2400-9	4 1/2" X 3 1/2" Angle Bracket	Plain	25

Hang It Faster!!!



Series 2117
Nylon Nailin

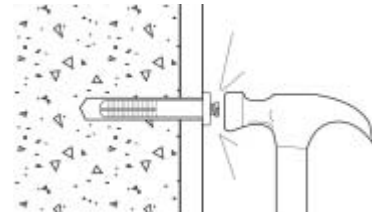

Size Range: 1" to 2"

Material: Carbon Steel

Finish: Carbon Steel

Function: The Nylon Nailin is a nail drive anchor with a body formed from engineered plastic and drive nails available in carbon and stainless steel. The anchor can be used in concrete, block, brick or stone. The anchor is pre-assembled with either a carbon steel or stainless steel nail. This anchor is not recommended for applications overhead. For overhead applications, please refer to the Zamac Hammer-Screw.

Part #	Size	Packaged	Case Quantity
2117-D	1/4" X 1"	25	1000
2117-F	1/4" X 1 1/2"	25	1000
2117-G	1/4" X 2"	25	1000

Series 2130 and 2131
Wall Dog



Size Range:

Material: Carbon Steel

Finish: Galvanized

Function: The Wall Dog is an all steel, one piece, threaded fastener, which is used to fasten various fixtures directly to drywall.

Part #	Size	Description	Packaged
2130-A	3/16" X 1 1/4"	Oval Head	100
2131-A	1/4" X 1 1/4"	Pan Head	100

Hang It Faster!!!



Series 2112 Mechanical Anchors

**WOOD
VERTICAL MOUNT**



**WOOD
SIDE MOUNT**



**STEEL
VERTICAL MOUNT**



**CONCRETE
VERTICAL MOUNT**



Part #	Mount	Size	Rod Size	Weight	Packaged
2109-L	Vertical	1 1/4" Concrete Vertical Mount	1/4"		25
2109-B	Vertical	2" Wood Vertical Mount	1/4"		25

Part #	Mount	Size	Rod Size	Weight	Packaged
2112-F	Side	1" Wood Side Mount	3/8"	.060	25
2112-E	Vertical	1" Wood Vertical Mount	3/8"	.065	25
2112-A	Side	2" Wood Side Mount	3/8"	.07	25
2112-B	Vertical	2" Wood Vertical Mount	3/8"	.07	25
2112-P	Vertical	2 1/2" Wood Vertical Mount	3/8"	.085	25
2112-G	Vertical	3" Wood Vertical Mount	3/8"	.080	25
2112-H	Vertical	1" Steel Vertical Mount w/Nut	3/8"	.065	25
2112-M	Vertical	1 1/2" Steel Side Mount	3/8"	.065	25
2112-I	Vertical	2" Steel Vertical Mount	3/8"	.075	25
2112-D	Vertical	1 3/4" Concrete Vertical Mount	3/8"	.045	25
2112-C	Side	1 3/4" Concrete Side Mount w/Bit	3/8"	.07	25
2112-U	Vertical	1 1/2" Steel Vertical Mount	3/8"	.07	25
2112-K	Vertical	2 3/4" Concrete Vertical Mount	1/2"	.155	25
2112-R	3/8"	Nut Driver for Cement	3/8"	.055	1
2112-T	1/2"	Nut Driver for Cement (For item #'s 2112-C & 2112-K)	1/2"	.135	1
2112-S		Universal Driver For Steel and Wood		.100	1

Hang It Faster!!!

34 Canal Street-Westerly, RI 02891-Tel: 401-596-8062 Fax: 401-596-8063
www.WarwickHanger.com

Hardware

Part #	Description	Finish	Size	Packaged
2001-A-P	Lag Ends	Plain	3/8" x 3 1/2"	25
2001-B-P	Lag Ends	Plain	3/8" x 4"	25
2001-C-P	Lag Ends	Plain	3/8" x 4 1/2"	25
2001-D-P	Lag Ends	Plain	3/8" x 6"	25
2001-E-P	Lag Ends	Plain	3/8" x 8"	25
2001-F-P	Lag Ends	Plain	3/8" x 12"	25
2011-A-P	Lag Ends	Plain	1/2" x 3 1/2"	25
2011-B-P	Lag Ends	Plain	1/2" x 4"	25
2011-C-P	Lag Ends	Plain	1/2" x 4 1/2"	25
2011-D-P	Lag Ends	Plain	1/2" X 6"	25
2011-E-P	Lag Ends	Plain	1/2" X 8"	25
2011-F-P	Lag Ends	Plain	1/2" x 12"	25
2001-A-G	Lag Ends	Plated	3/8" x 3 1/2"	25
2001-B-G	Lag Ends	Plated	3/8" x 4"	25
2001-C-G	Lag Ends	Plated	3/8" x 4 1/2"	25
2001-D-G	Lag Ends	Plated	3/8" x 6"	25
2001-E-G	Lag Ends	Plated	3/8" x 8"	25
2001-F-G	Lag Ends	Plated	3/8" x 12"	25
2011-A-G	Lag Ends	Plated	1/2" x 3 1/2"	25
2011-B-G	Lag Ends	Plated	1/2" X 4"	25
2011-C-G	Lag Ends	Plated	1/2" x 4 1/2"	25
2011-D-G	Lag Ends	Plated	1/2" X 6"	25
2011-E-G	Lag Ends	Plated	1/2" X 8"	25
2011-F-G	Lag Ends	Plated	1/2" x 12"	25
2001-H	Lag End Driver 3/8"	Plain	3/8"	1
2001-I	Lag End Driver 1/2"	Plain	1/2"	1



Lag End Driver

Hang It Faster!!!

Series 2122
Power Stud



Size Range: 2 1/4" and 3"

Material: Carbon Steel

Function: The Power-Stud anchor, formerly known as the Rawl-Stud, is a fully threaded, torque controlled, wedge expansion anchor which is designed for consistent performance. It is available in threaded, rod hanger and tie-wire versions suitable for applications in solid concrete and grout-filled concrete masonry. The threaded version is produced in carbon steel and stainless steel to offer various levels of corrosion resistance depending on use. The drill bit diameter necessary for proper installation is the same as the anchor diameter.

Part #	Size	Packaged	Case Quantity
2122-H	3/8" X 2 1/4"	50	N/A
2122-J	3/8" X 3"	50	N/A

Series 2121
Power Bolt



Size Range: 2 1/4" and 3"

Material: Carbon Steel

Function: The Power-Bolt anchor, formerly known as the Rawl-Stud, is a heavy duty sleeve style, self locking anchor which is vibration resistant and removable. It is available with a finished hex head or flat head with a hex key insert and can be used in concrete, block, brick or stone.

Part #	Description	Packaged	Weight
2121-H	3/8" X 2 1/4"	50	N/A
2121-J	3/8" X 3"	50	N/A

Hang It Faster!!!

Warwick
Hanger Company
Series 10
The Cap Light



Function: With the Plumbers Cap Light you can now have direct light where needed and keep your hands free to complete your task. Attached to any cap, the LED is for longer lasting light.

Part #	Description	Packaged
10-1-G	Green LED Color	10
10-1-R	Red LED Color	10
10-1-P	Purple LED Color	10
10-1-B	Replacement Batteries	2

Hang It Faster!!!

Series 4000 The SLED

Function: The Sled is an easy to use, labor saving tool that eliminates alignment issues and the need for return panels. It is a router guide system that enables the operator to cut return bends directly into grooved radiant flooring panels.



(Shown With Optional Sled Handle)



See video demo @ www.WarwickHanger.com

Part #	Description	Packaged	Weight
4000-1	The Sled	1	15.2 Lbs

Series 4010 The SLED Accessories

Part #	Description	Packaged
4010-1	Sled Vacuum Kit	1
4010-2	Sled Handle	1
4010-3	Sled Wall Kit	1
4010-4	Sled T-Slot Cutter	1
4010-5	Sled Replacement Points	4

Series 130 Plastic Coated 2-Hole Pipe Clips

Size Range: 1/2" - 6"

Material: Carbon Steel

Finish: Galvanized Plating

Function: Used to clamp black iron pipe or plastic coated pipe flush to the surface in both vertical and horizontal applications.

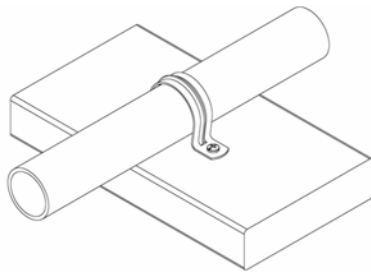

Part #	Size	Gage	Packaged	Case Quantity
130-50-PC	1/2"	18	100	500
130-75-PC	3/4"	18	100	500
130-10-PC	1"	18	50	500
130-12-PC	1 1/4"	18	50	N/A
130-15-PC	1 1/2"	18	50	N/A
130-20-PC	2"	18	50	N/A
130-30-PC	3"	16	25	N/A
130-35-PC	3" Heavy	12	25	N/A
130-40-PC	4"	16	25	N/A
130-45-PC	4" Heavy	12	25	N/A
130-60-PC	6"	12	25	N/A

Manufactured At Our Rhode Island Facility

Series 4200 Pro-Pitch Pipe Hanger

Size Range: Fits either 1 1/2" or 2" DWV Pipe

Finish: White

Function: Our patented Pro-Pitch Pipe Hanger has a simple and easy design. It's marked in 1/4" increments to allow easy adjustments. The strength and rigidity make it perfect for **Attic Vent Pipe** or any **DWV** pipe installation.



Part #	Size	Description	Packaged
4200-1	1 1/2" - 2"	Pro-Pitch Pipe Hanger	25

Hang It Faster!!!

Armacell CXT Pipe Insulation Nominal 3/8" Wall

Size Range: 1/4" - 3" By 6'

Material: Rubber - Solid

Function: Armacell engineered foam is a cost- efficient thermal insulation for domestic heating and plumbing lines. It is also dust free and it resists mold and mildew.

Available in **Tubular Form** which is easy to sleeve over new pipe work, or cut longitudinally to snap over any existing pipe

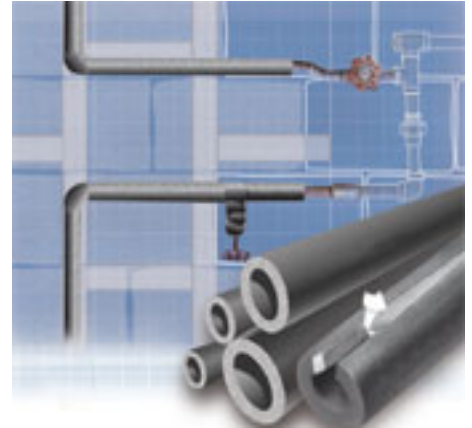

Part Number	Pipe Covering Size (6Ft.)	Nominal Size	Out. Diam.	Iron/ PVC	Linear Feet Per Carton	Tubes per Carton
CXT03838	3/8" ID	1/4"	3/8"	-	600	100
CXT01238	1/2" ID	3/8"	1/2"	1/4"	480	80
CXT05838	5/8" ID	1/2"	5/8"	3/8"	390	65
CXT03438	3/4" ID	5/8"	3/4"	-	330	55
CXT07838	7/8" ID	3/4"	7/8"	1/2"	270	45
CXT11838	1-1/8" ID	1"	1-1/8"	3/4"	210	35
CXT13838	1-3/8" ID	1-1/4"	1-3/8"	1"	180	30
CXT15838	1-5/8" ID	1-1/2"	1-5/8"	1-1/4"	120	20
CXT11038	1-1/2" IPS	-	-	1-1/2"	96	16
CXT21838	2-1/8" ID	2"	2-1/8"	-	96	16
CXT20038	2" IPS	-	-	2"	84	14
CXT25838	2-5/8" ID	2-1/2"	2-5/8"	-	72	12
CXT21038	2-1/2" IPS	-	-	2-1/2"	60	10
CXT31838	3-1/8" ID	3"	3-1/8"	-	54	9

Armacell CXT Pipe Insulation Nominal 1/2" Wall

Size Range: 1/4" - 3" By 6'

Material: Rubber - Solid

Function: Armacell engineered foam is a cost- efficient thermal insulation for domestic heating and plumbing lines.

It is also dust free and it resists mold and mildew.

Available in **Tubular Form** which is easy to sleeve over new pipe work, or cut longitudinally to snap over any existing pipe.

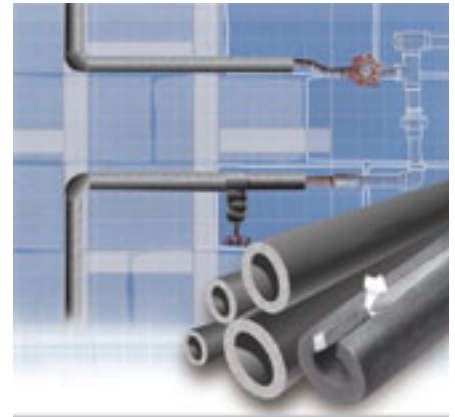

Part Number	Pipe Covering Size (6Ft.)	Nominal Size	Out. Diam.	Iron/ PVC	Linear Feet Per Carton	Tubes per Carton
CXT03812	3/8" ID	1/4"	3/8"	-	450	75
CXT01212	1/2" ID	3/8"	1/2"	1/4"	396	66
CXT05812	5/8" ID	1/2"	5/8"	3/8"	300	50
CXT03412	3/4" ID	5/8"	3/4"	-	240	40
CXT07812	7/8" ID	3/4"	7/8"	1/2"	210	35
CXT11812	1-1/8" ID	1"	1-1/8"	3/4"	150	25
CXT13812	1-3/8" ID	1-1/4"	1-3/8"	1"	120	20
CXT15812	1-5/8" ID	1-1/2"	1-5/8"	1-1/4"	90	15
CXT11012	1-1/2" IPS	-	-	1-1/2"	90	15
CXT21812	2-1/8" ID	2"	2-1/8"	-	60	10
CXT20012	2" IPS	-	-	2"	60	10
CXT25812	2-5/8" ID	2-1/2"	2-5/8"	-	60	10
CXT21012	2-1/2" IPS	-	-	2-1/2"	48	8
CXT31812	3-1/8" ID	3"	3-1/8"	-	42	7
CXT35812	3-5/8" ID	3-1/2"	3-5/8"	3"	36	6
CXT41812	4-1/8" ID	4"	4-1/8"	3-1/2"	24	4
CXT40012	4" IPS	-	-	4"	24	4
CXT50012	5" IPS	-	-	5"	12	2
CXT60012	6" IPS	-	-	6"	12	2

Armacell CXT Pipe Insulation Nominal 3/4" Wall

Size Range: 1/4" - 3" By 6'

Material: Rubber - Tubular

Function: Armacell engineered foam is a cost- efficient thermal insulation for domestic heating and plumbing lines.

It is also dust free and it resists mold and mildew.

Available in **Tubular Form** which is easy to sleeve over new pipe work, or cut longitudinally to snap over any existing pipe.

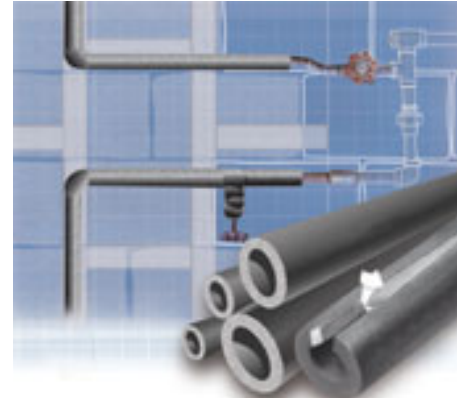

Part Number	Pipe Covering Size (6Ft.)	Nominal Size	Out. Diam.	Iron/PVC	Linear Feet Per Carton	Tubes per Carton
CXT03834	3/8" ID	1/4"	3/8"	-	240	40
CXT01234	1/2" ID	3/8"	1/2"	1/4"	210	35
CXT05834	5/8" ID	1/2"	5/8"	3/8"	144	24
CXT03434	3/4" ID	5/8"	3/4"	-	138	23
CXT07834	7/8" ID	3/4"	7/8"	1/2"	120	20
CXT11834	1-1/8" ID	1"	1-1/8"	3/4"	90	15
CXT13834	1-3/8" ID	1-1/4"	1-3/8"	1"	72	12
CXT15834	1-5/8" ID	1-1/2"	1-5/8"	1-1/4"	60	10
CXT11034	1-1/2" IPS	-	-	1-1/2"	60	10
CXT21834	2-1/8" ID	2"	2-1/8"	-	54	9
CXT20034	2" IPS	-	-	2"	48	8
CXT25834	2-5/8" ID	2-1/2"	2-5/8"	-	48	8
CXT21034	2-1/2" IPS	-	-	2-1/2"	42	7
CXT31834	3-1/8" ID	3"	3-1/8"	-	36	6
CXT35834	3-5/8" ID	3-1/2"	3-5/8"	3"	30	5
CXT41834	4-1/8" ID	4"	4-1/8"	3-1/2"	24	4
CXT40034	4" IPS	-	-	4"	24	4
CXT50034	5" IPS	-	-	5"	12	2
CXT60034	6" IPS	-	-	6"	12	2

Armacell CXT Pipe Insulation Nominal 1" Wall

Size Range: 1/4" - 3" By 6'

Material: Rubber - Tubular

Function: Armacell engineered foam is a cost- efficient thermal insulation for domestic heating and plumbing lines.

It is also dust free and it resists mold and mildew.

Available in **Tubular Form** which is easy to sleeve over new pipe work, or cut longitudinally to snap over any existing pipe.

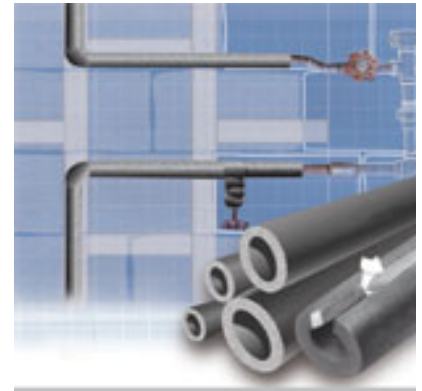

Part Number	Pipe Covering Size (6Ft.)	Nominal Size	Out. Diam.	Iron/PVC	Linear Feet Per Carton	Tubes per Carton
CXT05810	5/8" ID	1/2"	5/8"	3/8"	120	20
CXT03410	3/4" ID	5/8"	3/4"	-	90	15
CXT07810	7/8" ID	3/4"	7/8"	1/2"	90	15
CXT11810	1-1/8" ID	1"	1-1/8"	3/4"	72	12
CXT13810	1-3/8" ID	1-1/4"	1-3/8"	1"	60	10
CXT15810	1-5/8" ID	1-1/2"	1-5/8"	1-1/4"	48	8
CXT11010	1-1/2" IPS	-	-	1-1/2"	42	7
CXT21810	2-1/8" ID	2"	2-1/8"	-	36	6
CXT20010	2" IPS	-	-	2"	36	6
CXT25810	2-5/8" ID	2-1/2"	2-5/8"	-	36	6
CXT21010	2-1/2" IPS	-	-	2-1/2"	30	5
CXT31810	3-1/8" ID	3"	3-1/8"	-	30	5
CXT35810	3-5/8" ID	3-1/2"	3-5/8"	3"	24	4
CXT41810	4-1/8" ID	4"	4-1/8"	3-1/2"	18	3
CXT40010	4" IPS	-	-	4"	18	3
CXT50010	5" IPS	-	-	5"	12	2
CXT60010	6" IPS	-	-	6"	12	2

Armacell SST Pipe Insulation Nominal 3/8" Wall

Size Range: 1/2" - 2" By 6'

Material: Rubber – Self Seal

Function: Armacell engineered foam is a cost- efficient thermal insulation for domestic heating and plumbing lines.

It is also dust free and it resists mold and mildew.

Available in **Self-Seal** which comes split and snaps over new or any existing pipe work and then can be sealed with its self-sealing function.

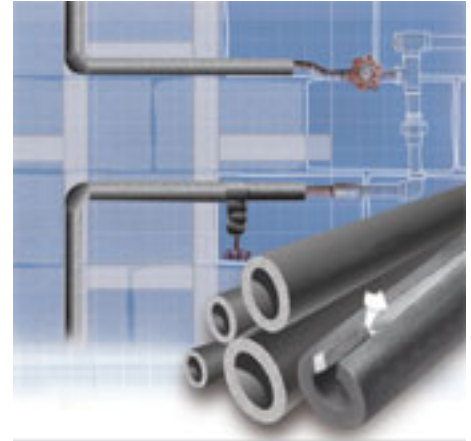

Part Number	Pipe Covering Size (6Ft.)	Nominal Size	Out. Diam.	Iron/ PVC	Linear Feet Per Carton	Tubes per Carton
SST05838	5/8" ID	1/2"	5/8"	3/8"	390	65
SST03438	3/4" ID	5/8"	3/4"	-	330	55
SST07838	7/8" ID	3/4"	7/8"	1/2"	270	45
SST11838	1-1/8" ID	1"	1-1/8"	3/4"	210	35
SST13838	1-3/8" ID	1-1/4"	1-3/8"	1"	180	30
SST15838	1-5/8" ID	1-1/2"	1-5/8"	1-1/4"	120	20
SST21838	2-1/8"	2"	2-1/8"	-	96	16

Armacell SST Pipe Insulation Nominal 1/2" Wall

Size Range: 1/2" - 4" By 6'

Material: Rubber – Self Seal

Function: Armacell engineered foam is a cost- efficient thermal insulation for domestic heating and plumbing lines. It is also dust free and it resists mold and mildew.

Available in **Self-Seal** which comes split and snaps over new or any existing pipe work and then can be sealed with its self-sealing function.

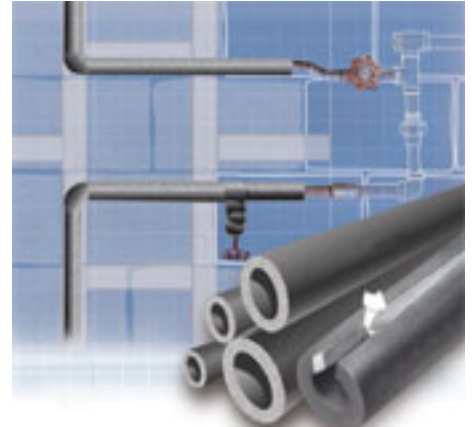

Part Number	Pipe Covering Size (6Ft.)	Nominal Size	Out. Diam.	Iron/ PVC	Linear Feet Per Carton	Tubes per Carton
SST05812	5/8" ID	1/2"	5/8"	3/8"	300	50
SST03412	3/4" ID	5/8"	3/4"	-	240	40
SST07812	7/8" ID	3/4"	7/8"	1/2"	210	35
SST11812	1-1/8" ID	1"	1-1/8"	3/4"	150	25
SST13812	1-3/8" ID	1-1/4"	1-3/8"	1"	120	20
SST15812	1-5/8" ID	1-1/2"	1-5/8"	1-1/4"	90	15
SST11012	1-1/2" IPS	-	-	1-1/2"	90	15
SST21812	2-1/8" ID	2"	2-1/8"	-	60	10
SST20012	2" IPS	-	-	2"	60	10
SST25812	2-5/8" ID	2-1/2"	2-5/8"	-	60	10
SST21012	2-1/2" IPS	-	-	2-1/2"	48	8
SST31812	3-1/8" ID	3"	3-1/8"	-	42	7
SST30012	3" IPS	-	-	3"	36	6
SST35812	3-5/8" ID	3-1/2"	3-5/8"	-	36	6
SST41812	4-1/8" ID	4"	4-1/8"	3-1/2"	24	4
SST40012	4" IPS	-	-	4"	24	4

Armacell SST Pipe Insulation Nominal 3/4" Wall

Size Range: 1/2" - 4" By 6'

Material: Rubber – Self Seal

Function: Armacell engineered foam is a cost- efficient thermal insulation for domestic heating and plumbing lines. It is also dust free and it resists mold and mildew.

Available in **Self-Seal** which comes split and snaps over new or any existing pipe work and then can be sealed with its self-sealing function.

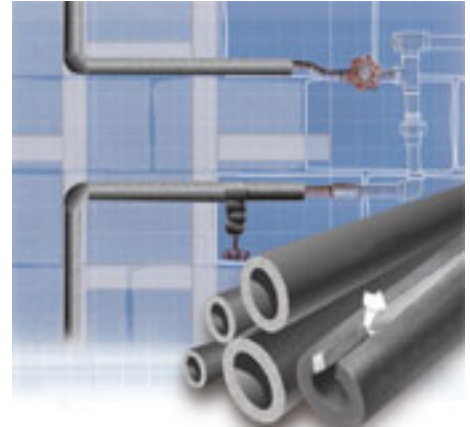

Part Number	Pipe Covering Size (6Ft.)	Nominal Size	Out. Diam.	Iron/ PVC	Linear Feet Per Carton	Tubes per Carton
SST05834	5/8" ID	1/2"	5/8"	3/8"	144	24
SST03434	3/4" ID	5/8"	3/4"	-	138	23
SST07834	7/8" ID	3/4"	7/8"	1/2"	120	20
SST11834	1-1/8" ID	1"	1-1/8"	3/4"	90	15
SST13834	1-3/8" ID	1-1/4"	1-3/8"	1"	72	12
SST15834	1-5/8" ID	1-1/2"	1-5/8"	1-1/4"	60	10
SST11034	1-1/2" IPS	-	-	1-1/2"	60	10
SST21834	2-1/8" ID	2"	2-1/8"	-	54	9
SST20034	2" IPS	-	-	2"	48	8
SST25834	2-5/8" ID	2-1/2"	2-5/8"	-	48	8
SST21034	2-1/2" IPS	-	-	2-1/2"	42	7
SST31834	3-1/8" ID	3"	3-1/8"	-	36	6
SST30034	3" IPS	-	-	3"	30	5
SST35834	3-5/8" ID	3-1/2"	3-5/8"	-	30	5
SST41834	4-1/8" ID	4"	4-1/8"	3-1/2"	24	4
SST40034	4" IPS	-	-	4"	24	4

Armacell SST Pipe Insulation Nominal 1" Wall

Size Range: 1/2" - 4" By 6'

Material: Rubber – Self Seal

Function: Armacell engineered foam is a cost- efficient thermal insulation for domestic heating and plumbing lines. It is also dust free and it resists mold and mildew.

Available in **Self-Seal** which comes split and snaps over new or any existing pipe work and then can be sealed with its self-sealing function.

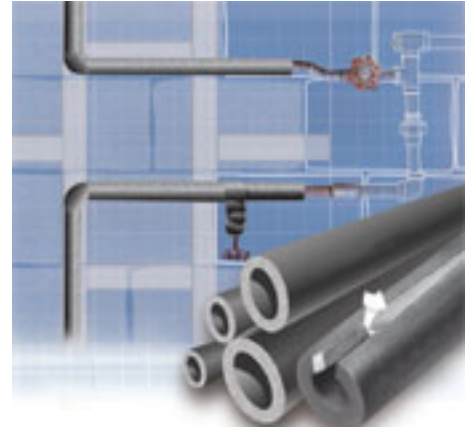

Part Number	Pipe Covering Size (6Ft.)	Nominal Size	Out. Diam.	Iron/ PVC	Linear Feet Per Carton	Tubes per Carton
SST05810	5/8" ID	1/2"	5/8"	3/8"	120	20
SST03410	3/4" ID	5/8"	3/4"	-	90	15
SST07810	7/8" ID	3/4"	7/8"	1/2"	90	15
SST11810	1-1/8" ID	1"	1-1/8"	3/4"	72	12
SST13810	1-3/8" ID	1-1/4"	1-3/8"	1"	60	10
SST15810	1-5/8" ID	1-1/2"	1-5/8"	1-1/4"	48	8
SST11010	1-1/2" IPS	-	-	1-1/2"	42	7
SST21810	2-1/8" ID	2"	2-1/8"	-	36	6
SST20010	2" IPS	-	-	2"	36	6
SST25810	2-5/8" ID	2-1/2"	2-5/8"	-	36	6
SST21010	2-1/2" IPS	-	-	2-1/2"	30	5
SST31810	3-1/8" ID	3"	3-1/8"	-	30	5
SST30010	3" IPS	-	-	3"	24	4
SST35810	3-5/8" ID	3-1/2"	3-5/8"	-	24	4
SST41810	4-1/8" ID	4"	4-1/8"	3-1/2"	18	3
SST40010	4" IPS	-	-	4"	18	3

Armacell DGS Pipe Insulation Plumblok SS Nominal 3/8" Wall

Size Range: 1/4" - 4" By 6'

Material: Polyethylene – Foam Split

Function: Armacell engineered foam is a cost- efficient thermal insulation for domestic heating and plumbing lines.

It is also dust free and it resists mold and mildew.

Available in **Self-Seal** which comes split and snaps over new or any existing pipe work and then can be sealed with its self-sealing function.

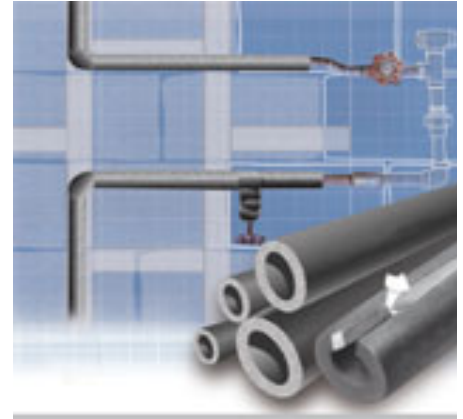

Part Number	Pipe Covering Size (6Ft.)	Nominal Size	Out. Diam.	Iron/ PVC	Linear Feet Per Carton	Tubes per Carton
DGS03838	3/8" ID	1/4"	3/8"	-	540	90
DGS01238	1/2" ID	3/8"	1/2"	1/4"	456	76
DGS05838	5/8" ID	1/2"	5/8"	3/8"	396	66
DGS03438	3/4" ID	5/8"	3/4"	-	300	50
DGS07838	7/8" ID	3/4"	7/8"	1/2"	276	46
DGS11838	1-1/8" ID	1"	1-1/8"	3/4"	222	37
DGS13838	1-3/8" ID	1-1/4"	1-3/8"	1"	180	30
DGS15838	1-5/8" ID	1-1/2"	1-5/8"	1-1/4"	138	23
DGS11038	1-1/2" IPS	-	-	1-1/2"	126	21
DGS21838	2-1/8" ID	2"	2-1/8"	-	96	16
DGS20038	2" IPS	-	-	2"	84	14
DGS25838	2-5/8" ID	2-1/2"	2-5/8"	-	72	12
DGS21038	2-1/2" IPS	-	-	2-1/2"	60	10
DGS31838	3-1/8" ID	3"	3-1/8"	-	54	9
DGS35838	3-5/8" ID	3-1/2"	3-5/8"	3"	48	8
DGS41838	4-1/8" ID	4"	4-1/8"	3-1/2"	36	6
DGS40038	4" IPS	-	-	4"	36	6

Armacell DGS Pipe Insulation Plumblok SS Nominal 1/2" Wall

Size Range: 1/4" - 4" By 6'

Material: Polyethylene – Foam Split

Function: Armacell engineered foam is a cost- efficient thermal insulation for domestic heating and plumbing lines.

It is also dust free and it resists mold and mildew.

Available in **Self-Seal** which comes split and snaps over new or any existing pipe work and then can be sealed with its self-sealing function.

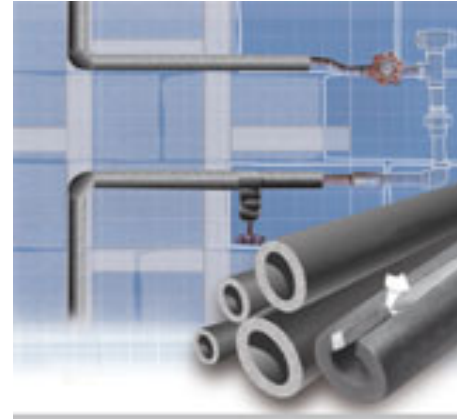

Part Number	Pipe Covering Size (6Ft.)	Nominal Size	Out. Diam.	Iron/PVC	Linear Feet Per Carton	Tubes per Carton
DGS03812	3/8" ID	1/4"	3/8"	-	414	69
DGS01212	1/2" ID	3/8"	1/2"	1/4"	336	56
DGS05812	5/8" ID	1/2"	5/8"	3/8"	300	50
DGS03412	3/4" ID	5/8"	3/4"	-	264	44
DGS07812	7/8" ID	3/4"	7/8"	1/2"	240	40
DGS11812	1-1/8" ID	1"	1-1/8"	3/4"	186	31
DGS13812	1-3/8" ID	1-1/4"	1-3/8"	1"	150	25
DGS15812	1-5/8" ID	1-1/2"	1-5/8"	1-1/4"	120	20
DGS11012	1-1/2" IPS	-	-	1-1/2"	96	16
DGS21812	2-1/8" ID	2"	2-1/8"	-	84	14
DGS20012	2" IPS	-	-	2"	72	12
DGS25812	2-5/8" ID	2-1/2"	2-5/8"	-	60	10
DGS21012	2-1/2" IPS	-	-	2-1/2"	54	9
DGS31812	3-1/8" ID	3"	3-1/8"	-	48	8
DGS35812	3-5/8" ID	3-1/2"	3-5/8"	3"	36	6
DGS41812	4-1/8" ID	4"	4-1/8"	3-1/2"	24	4
DGS40012	4" IPS	-	-	4"	24	4

Armacell DGS Pipe Insulation Plumblok SS Nominal 3/4" Wall

Size Range: 1/4" - 4" By 6'

Material: Polyethylene – Foam Split

Function: Armacell engineered foam is a cost- efficient thermal insulation for domestic heating and plumbing lines.

It is also dust free and it resists mold and mildew.

Available in **Self-Seal** which comes split and snaps over new or any existing pipe work and then can be sealed with its self-sealing function.

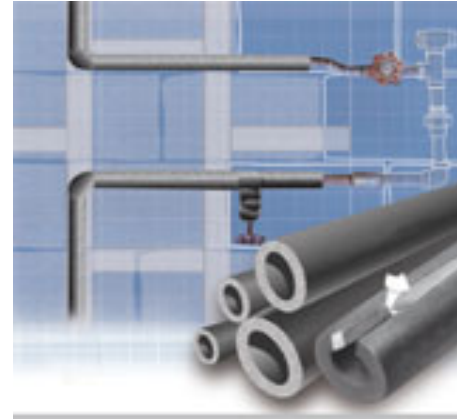

Part Number	Pipe Covering Size (6Ft.)	Nominal Size	Out. Diam.	Iron/ PVC	Linear Feet Per Carton	Tubes per Carton
DGS03834	3/8" ID	1/4"	3/8"	-	228	38
DGS01234	1/2" ID	3/8"	1/2"	1/4"	210	35
DGS05834	5/8" ID	1/2"	5/8"	3/8"	180	30
DGS03434	3/4" ID	5/8"	3/4"	-	162	27
DGS07834	7/8" ID	3/4"	7/8"	1/2"	150	25
DGS11834	1-1/8" ID	1"	1-1/8"	3/4"	120	20
DGS13834	1-3/8" ID	1-1/4"	1-3/8"	1"	96	16
DGS15834	1-5/8" ID	1-1/2"	1-5/8"	1-1/4"	84	14
DGS11034	1-1/2" IPS	-	-	1-1/2"	66	11
DGS21834	2-1/8" ID	2"	2-1/8"	-	54	9
DGS20034	2" IPS	-	-	2"	54	9
DGS25834	2-5/8" ID	2-1/2"	2-5/8"	-	48	8
DGS21034	2-1/2" IPS	-	-	2-1/2"	42	7
DGS31834	3-1/8" ID	3"	3-1/8"	-	36	6
DGS35834	3-5/8" ID	3-1/2"	3-5/8"	3"	30	5
DGS41834	4-1/8" ID	4"	4-1/8"	3-1/2"	24	4
DGS40034	4" IPS	-	-	4"	24	4

Armacell DGS Pipe Insulation Plumblok SS Nominal 1" Wall

Size Range: 1/4" - 4" By 6'

Material: Polyethylene – Foam Split

Function: Armacell engineered foam is a cost- efficient thermal insulation for domestic heating and plumbing lines.

It is also dust free and it resists mold and mildew.

Available in **Self-Seal** which comes split and snaps over new or any existing pipe work and then can be sealed with its self-sealing function.

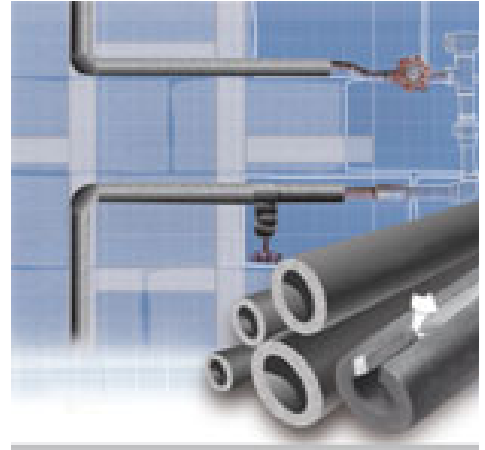

Part Number	Pipe Covering Size (6Ft.)	Nominal Size	Out. Diam.	Iron/ PVC	Linear Feet Per Carton	Tubes per Carton
DGS03810	3/8" ID	1/4"	3/8"	-	150	25
DGS01210	1/2" ID	3/8"	1/2"	1/4"	126	21
DGS05810	5/8" ID	1/2"	5/8"	3/8"	120	20
DGS03410	3/4" ID	5/8"	3/4"	-	120	20
DGS07810	7/8" ID	3/4"	7/8"	1/2"	96	16
DGS11810	1-1/8" ID	1"	1-1/8"	3/4"	84	14
DGS13810	1-3/8" ID	1-1/4"	1-3/8"	1"	72	12
DGS15810	1-5/8" ID	1-1/2"	1-5/8"	1-1/4"	54	9
DGS11010	1-1/2" IPS	-	-	1-1/2"	54	9
DGS21810	2-1/8" ID	2"	2-1/8"	-	48	8
DGS20010	2" IPS	-	-	2"	42	7
DGS25810	2-5/8" ID	2-1/2"	2-5/8"	-	36	6
DGS21010	2-1/2" IPS	-	-	2-1/2"	30	5
DGS31810	3-1/8" ID	3"	3-1/8"	-	24	4
DGS35810	3-5/8" ID	3-1/2"	3-5/8"	3"	24	4
DGS41810	4-1/8" ID	4"	4-1/8"	3-1/2"	18	3
DGS40010	4" IPS	-	-	4"	18	3

Armacell UTT Pipe Insulation UT Solaflex Nominal 1/2" Wall

Size Range: 1/2" – 2-1/2" By 6'

Material: EPDM Elastomeric Foam

Function: Armacell engineered foam is a cost- efficient thermal insulation for domestic heating and plumbing lines. It is also dust free and it resists mold and mildew.

This product is ideal for high temperature applications.

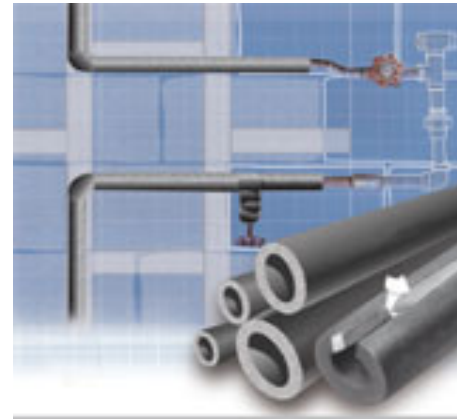

Part Number	Pipe Covering Size (6Ft.)	Copper Tubing	Iron/ PVC	Linear Feet Per Carton	Tubes per Carton
UTT01212	1/2" ID	-	-	396	66
UTT05812	5/8" ID	1/2"	3/8"	300	50
UTT03412	3/4" ID	5/8"	-	240	40
UTT07812	7/8" ID	3/4"	1/2"	210	35
UTT11812	1-1/8" ID	1"	3/4"	150	25
UTT13812	1-3/8" ID	1-1/4"	1"	120	20
UTT15812	1-5/8" ID	1-1/2"	1-1/4"	90	15
UTT11012	1-1/2" IPS	-	1-1/2"	90	15
UTT21812	2-1/8" ID	2"	-	60	10
UTT20012	2" IPS	-	2"	60	10
UTT21012	2-1/2" IPS	-	2-1/2"	48	8

Armacell UTT Pipe Insulation UT Solaflex Nominal 3/4" Wall

Size Range: 1/2" – 2-1/2" By 6'

Material: EPDM Elastomeric Foam

Function: Armacell engineered foam is a cost- efficient thermal insulation for domestic heating and plumbing lines. It is also dust free and it resists mold and mildew.

This product is ideal for high temperature applications.

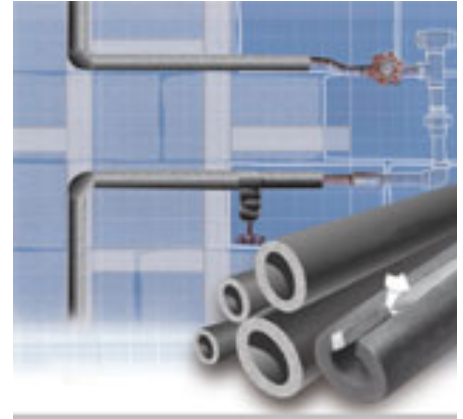

Part Number	Pipe Covering Size (6Ft.)	Copper Tubing	Iron/ PVC	Linear Feet Per Carton	Tubes per Carton
UTT01234	1/2" ID	-	-	210	35
UTT05834	5/8" ID	1/2"	3/8"	144	24
UTT03434	3/4" ID	5/8"	-	138	23
UTT07834	7/8" ID	3/4"	1/2"	120	20
UTT11834	1-1/8" ID	1"	3/4"	90	15
UTT13834	1-3/8" ID	1-1/4"	1"	72	12
UTT15834	1-5/8" ID	1-1/2"	1-1/4"	60	10
UTT11034	1-1/2" IPS	-	1-1/2"	60	10
UTT21834	2-1/8" ID	2"	-	54	9
UTT20034	2" IPS	-	2"	48	8
UTT21034	2-1/2" IPS	-	2-1/2"	42	7

Armacell UTT Pipe Insulation UT Solaflex Nominal 1" Wall

Size Range: 1/2" – 2-1/2" By 6'

Material: EPDM Elastomeric Foam

Function: Armacell engineered foam is a cost- efficient thermal insulation for domestic heating and plumbing lines. It is also dust free and it resists mold and mildew.

This product is ideal for high temperature applications.

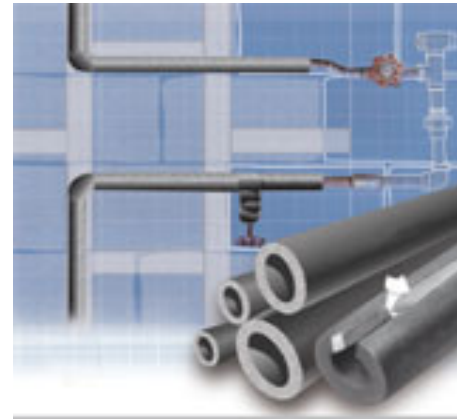

Part Number	Pipe Covering Size (6Ft.)	Copper Tubing	Iron/ PVC	Linear Feet Per Carton	Tubes per Carton
UTT01210	1/2" ID	-	-	144	24
UTT05810	5/8" ID	1/2"	3/8"	120	20
UTT03410	3/4" ID	5/8"	-	90	15
UTT07810	7/8" ID	3/4"	1/2"	90	15
UTT11810	1-1/8" ID	1"	3/4"	72	12
UTT13810	1-3/8" ID	1-1/4"	1"	60	10
UTT15810	1-5/8" ID	1-1/2"	1-1/4"	48	8
UTT11010	1-1/2" IPS	-	1-1/2"	42	7
UTT21810	2-1/8" ID	2"	-	36	6
UTT20010	2" IPS	-	2"	36	6
UTT21010	2-1/2" IPS	-	2-1/2"	30	5



Terms and Conditions of Sale:

3% 30 Days-Net 31

Please call for Prepaid Freight

INDEX

<u>ITEM</u>	<u>PAGE</u>
ARMACELL	
CXT – RUBBER SOLID.....	72-75
SST – RUBBER SELF SEAL.....	76-79
DGS – POLYETHYLENE SELF SEAL.....	80-83
UTT- UT/SOLAFLEX (HIGH TEMPERATURE).....	84-86
BAND HANGERS (ADJUSTABLE)	
COPPER PLATED.....	37
PLAIN.....	38
BELL (VAN) HANGERS	
COPPER PLATED.....	8
CORROSION RESISTENT.....	9
IMPORT COPPER.....	10
BEND SUPPORTS.....	3
CAP LIGHT.....	65
CLAMPS	
BEAM RETAINING STRAP.....	53
C-CLAMP (STEEL).....	55
CUSHION.....	43
DOUBLE BOLT.....	49
RISER CLAMPS.....	46-48
TOP BEAM.....	53
CLEVIS HANGERS	
CARBON STEEL.....	45
COPPER PLATED.....	44
CONE RISER.....	12
DWV HANGERS	
COPPER PLATED.....	26
GALVANIZED.....	24
GALVANIZED 1” WIDTH.....	27
PLASTIC COATED.....	25
PLASTIC COATED 1” WIDTH.....	27
SPIRAL VENT.....	28
Z-VENT.....	28
FLANGES.....	50
CEILING.....	54
FLASHLIGHT/LASER POINTER.....	66
HANGER STRAPPING (PERFORATED)	
GALVANIZED.....	23
PLASTIC.....	23
HARDWARE	
ANGLE BRACKETS.....	60
DRIVE SCREWS.....	59
DROP IN ANCHORS.....	59
HEAVY HEX BOLT.....	59
HEAVY HEX NUT.....	58

LAG ENDS.....	63
LAG SCREWS.....	56
MECHANICAL ANCHORS.....	62
MUSHROOM DRIVE PINS.....	59
NYLON NAILIN.....	61
POWER BOLT.....	64
POWER STUD.....	64
ROD COUPLINGS.....	56
SPRING NUTS.....	60
THREADED RODS.....	57
THREADED RODS.....	57
ROD COUPLINGS.....	56
SPRING NUTS.....	60
THREADED RODS.....	57
WALL DOG.....	61
WASHERS.....	57
FENDER.....	59
ISOLATION CLIP.....	4
J HOOKS	
DWV AND CTS.....	30
GLIDE LOCK.....	29
J CLIP WITH NAIL.....	2,3
MILFORD TYPE HANGERS.....	15
IMPORT.....	16
NAILING HOOKS.....	11
NAILING PLATES.....	33
NATICK TYPE HANGERS.....	13
IMPORT.....	14
PEX ORGANIZER.....	6
PIPE CLIPS	
COPPER (2 HOLED).....	1
DUAL PIPE CLIP.....	3
GALVANIZED (2 HOLED).....	7
GALVANIZED (PLASTIC COATED).....	69
GLIDE LOCK.....	4
MANIFOLD.....	5
SCREWS.....	5
SPACERS.....	5
PLASTIC.....	2
CLOSED CLAMP WITH NAIL.....	3
PIPE HANGERS (BLACK).....	22
PIPE SHIELDS.....	52
PRO-PITCH HANGER.....	70
RISER CLAMPS	
COPPER PLATED.....	46
PLAIN.....	47
SHORT ARM.....	48
SET-RITE.....	68
SIDE BEAM CONNECTOR.....	54



SLED	67
SLED ACCESSORIES	67
SPLIT RING HANGERS	
BLACK.....	36
COPPER PLATED.....	34
GALVANIZED.....	35
STRUT CLAMPS	
COPPER PLATED.....	41
GALVANIZED.....	42
STUD PROTECTORS	51
SWIVEL HANGERS	
COPPER PLATED.....	39
GALVANIZED.....	40
TRAP COVERS	11
TUBE SUPPORT BRACKET	21
WIRE HOOKS	
COPPER PLATED.....	17
PLAIN BLACK.....	19
PLASTIC COATED.....	18
PLASTIC COATED BLACK.....	