

CASH ACME
DUAL CHECK
BACKFLOW PREVENTER
TYPE:BF- 5
1" X 3/4" FLOW
1024 175psi 140°F
SA MD
WILLMAN ALABAMA

CASH ACME CATALOG





WATER CONTROL VALVES THAT STAND THE TEST OF TIME

In 1893, A.W. Cash designed a valve for U.S. Navy submarines. With the bottom of the sea as his testing ground, the valve became celebrated for its performance, reliability and dependability. Today, every water control valve we make is developed to these same standards.

With more than 100 million valves produced and counting, Cash Acme is the world's largest volume T&P valve producer—and is a trusted manufacturer of water control valves to safeguard water delivery in residential, commercial and industrial settings.

It's our commitment to quality that has driven a century of success with water control valves that stand the test of time. Proudly built in America for more than 100 years, Cash Acme's ISO 9001-certified quality assurance processes ensure that every valve that leaves our facility is 100% tested and meets all standards.



USA: www.cashacme.com | Canada: www.cashacme.ca

CONTENTS

PRESSURE REGULATING VALVES

EB45	3
EB45 SHARKBITE	4
EB25	5
EB25 SHARKBITE	8
EB25 MULTICARTRIDGE	11
E3	12
E41	13
E56	14
EB75	15
PRV REPAIR KITS	16

THERMOSTATIC MIXING VALVES

TANK BOOSTER	18
HG110 D	19
HG160	21
HG145	22
HG110-HX	23
HG115	24
TAFR	25
MASTERGUARD 800	26

TEMPERATURE & PRESSURE RELIEF VALVES

NCLX	27
FVX/FVMX	28
FWL	29
F-30	31
F-82	34
F-95	35
F, FW & FWC	36
VR-801	38
	39
	40



BACKFLOW PREVENTERS

V-3 VACUUM BREAKER

VB-222 VACUUM BREAKER

V-101 ANTI-SIPHON VACUUM BREAKER

BF DUAL CHECK VALVE

BFP DUAL CHECK VALVE

GENERAL PLUMBING & HEATING

WASHING MACHINE SHUT-OFF VALVE

A-41 AND AB-40

A-89

BFAC

CBL

CQ-M

CR

AIR SEPARATOR

AIR PURGER

AIR VENT

MADE IN THE USA

LIMITED WARRANTY

41

42

43

44

45

46

47

48

49

50

51

52

53

54

55

56

57

58

60



PRESSURE REGULATING VALVES

Cash Acme has been manufacturing pressure regulating valves (PRVs) to help regulate downstream pressure for more than 100 years. Each water pressure regulator is tested for quality and efficiency before leaving our factory.

Most Cash Acme PRV's come preset at 45psi but can be adjusted within a specific range depending on the model. As the downstream water pressure approaches the set pressure, the valve will close off, not allowing water to pass through. As the downstream water pressure drops, typically due to water usage, the pressure regulator will open back up, letting water through to recharge the system as long as the demand is needed.

With more than 150 PRV product sizes and configurations, our inventory of water pressure regulators is more than capable of handling your commercial, residential and even agricultural product needs.



PRESSURE REGULATING VALVES

EB45

COMMERCIAL, RESIDENTIAL

The EB45 Pressure Regulator features a half cartridge design that offers the performance of a high end, cartridge based valve and the price of a traditional regulator. The valve construction is similar to a traditional regulator in that it retains a separate spring chamber and adjusting screw, but offers the simplicity and maintenance benefits of a cartridge based valve. The EB45 comes factory set at 45 psi but may be adjusted between 10–70 psi.

FEATURES AND BENEFITS:

- Rugged bronze body
- Compact pressure reducing mechanism
- Back-pass check mechanism integral with the cartridge*
- Modular Cartridge Design reduces the number of parts requiring service
- Serviceable in line
- Every valve is tested for performance prior to shipping

PERFORMANCE:

Maximum pressure: 400 psi (1/2", 3/4" and 1")
 300 psi (1-1/4", 1-1/2" and 2")
 Maximum temperature: 180°F (82.2°C)
 Service: Water
 Outlet pressure range: 10–70 psi

APPLICATIONS:

Commercial and domestic water applications.

AVAILABLE CONNECTIONS:

All EB45 models¹ include both FIP and union connection threading on both ends.

Threaded (NPT)	1/2", 3/4", 1", 1-1/4", 1-1/2" and 2"
Threaded (NPT) Single Union	1/2", 3/4", 1", 1-1/4", 1-1/2" and 2"
Sweat Copper Single Union	1/2", 3/4", 1", 1-1/4", 1-1/2" and 2"
Threaded (NPT) Double Union	1/2", 3/4", 1", 1-1/4", 1-1/2" and 2"
Sweat Copper Double Union	1/2", 3/4", 1", 1-1/4", 1-1/2" and 2"
CPVC Double Union	3/4" and 1"
PEX Barb Double Union	3/4" and 1"

3/4" and 1" models are also available with a pressure gauge

¹Except for Direct SharkBite models.

APPROVALS AND LISTINGS:

ASSE 1003, CSA B356, NSF/ANSI 372 (Lead Free), NSF/ANSI 61. Listed by IAPMO, CSA and ASSE.



DIMENSIONS (inches)

Size	Connection Style	A			B	C				
		Direct	Single Union	Double Union						
1/2	NPT	3-1/4	4	4-3/4	4-3/8	3/4				
	Sweat	-	4	4-3/4						
3/4	NPT	3-7/16	4-3/16	4-15/16						
	Sweat	-	4-5/16	5-1/4						
	CPVC	-	-	5-3/8						
	Barb	-	-	5-11/16						
1	NPT	4-3/16	5-3/16	6-3/16	4-3/8	1				
	Sweat	-	5-5/16	6-7/16						
	CPVC	-	-	6-1/2						
	Barb	-	-	7						
1-1/4	NPT	4-13/16	5-11/16	6-9/16			7-11/16	1-3/8		
	Sweat	-	5-7/8	6-15/16						
1-1/2	NPT	4-13/16	5-15/16	7				7-11/16	1-5/8	
	Sweat	-	6	7-3/16						
2	NPT	4-13/16	6	7-3/16					7-11/16	1-7/8
	Sweat	-	6-1/4	7-11/16						

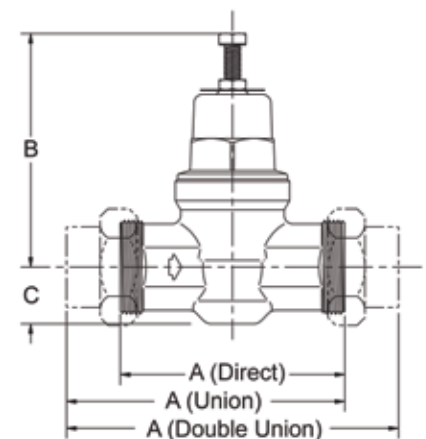

*The back-pass check feature allows for a reverse flow of water through the regulator in the event that outlet pressure increases to exceed supply pressure. Thermal expansion, created by a water heater for instance, can cause water pressure to increase. Without the back-pass check, water cannot flow in reverse.

PRESSURE REGULATING VALVES



EB45 SHARKBITE

COMMERCIAL, RESIDENTIAL

The EB45 Pressure Regulator with SharkBite push-fit connections features a half cartridge design that offers the performance of a high end, cartridge based valve and the price of a traditional regulator. The valve construction is similar to a traditional regulator in that it retains a separate spring chamber and adjusting screw, but offers the simplicity and maintenance benefits of a cartridge based valve. The EB45 comes factory set at 45 psi but may be adjusted between 10-70 psi. The EB45 is available with several different SharkBite connections for ease of installation, and a trustworthy watertight seal. EB45 SharkBite options include Double Union SharkBite, Direct SharkBite, or Direct SharkBite with Slip Feature.

FEATURES AND BENEFITS:

- Instant push-fit connections. No soldering, glue or tools required to make connection.
- Rugged bronze body
- Compact pressure reducing mechanism
- Back-pass check mechanism integral with the cartridge*
- Modular Cartridge Design reduces the number of parts requiring service
- Serviceable in line
- Every valve is tested for performance prior to shipping

The EB45 Direct SharkBite with slip feature allows for a quick and easy installation on existing copper and CTS CPVC pipe.

PERFORMANCE:

Maximum pressure: 200 psi
 Maximum temperature: 180°F (82.2°C)
 Service: Potable Water
 Outlet pressure range: 10-70 psi

APPLICATIONS:

Commercial and domestic water applications.

AVAILABLE CONNECTIONS:

Union SharkBite Inlet and Outlet 1/2", 3/4" and 1"
 Direct SharkBite Inlet and Outlet 1/2", 3/4", and 1"
 Direct SharkBite Inlet and Outlet with Slip Feature 1/2" and 3/4"

APPROVALS AND LISTINGS:

ASSE 1003, CSA B356, NSF/ANSI 372 (Lead Free), NSF/ANSI 61. Listed by IAPMO, CSA and ASSE.



EB45 DOUBLE UNION SHARKBITE

DIMENSIONS (inches)				
Size	Connection Style	A (Double Union)	B	C
1/2	Double Union SharkBite	5-7/8	4-3/8	3/4
3/4		7		
1		8-3/4		

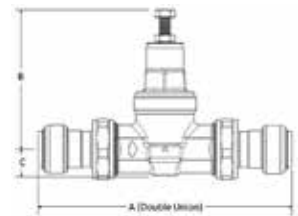

EB45 DIRECT SHARKBITE

DIMENSIONS (inches)			
Size	A	B	C
1/2	4-7/8	4-3/8	3/4
3/4	5-1/8		
1	8-3/4	4-3/8	15/16

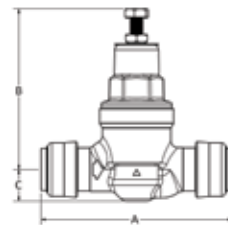

EB45 DIRECT SHARKBITE WITH SLIP FEATURE

DIMENSIONS (inches)			
Valve Size	A	B	C
1/2	6-13/16	4-3/8	3/4
3/4	7-5/8	4-3/8	3/4

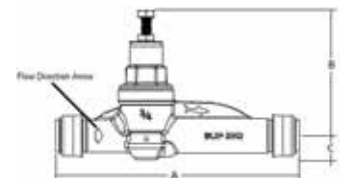

*The back-pass check feature allows for a reverse flow of water through the regulator in the event that outlet pressure increases to exceed supply pressure. Thermal expansion, created by a water heater for instance, can cause water pressure to increase. Without the back-pass check, water cannot flow in reverse.



PRESSURE REGULATING VALVES

EB45 CONT.



PRODUCT DESCRIPTION	PART NUMBER
EB45 LEAD FREE SHARKBITE CONNECTIONS	
1/2" EB45-DSB Direct SharkBite	23807-0045
1/2" EB45-DSB Direct SharkBite Metal Top	24472-0045
1/2" EB45-SDSB Slip Feature Direct SharkBite	24383-0045
1/2" EB45-SDSB Slip Feature Direct SharkBite Metal Top	24474-0045
1/2" EB45-DUSB Double Union SharkBite	23893-0045
1/2" EB45-DUSB Double Union SharkBite Metal Top	24476-0045
3/4" EB45-DSB Direct SharkBite	23808-0045
3/4" EB45-DSB Direct SharkBite Metal Top	24473-0045
3/4" EB45-SDSB Slip Feature Direct SharkBite	24384-0045
3/4" EB45-SDSB Slip Feature Direct SharkBite Metal Top	24475-0045
3/4" EB45-DUSB Double Union SharkBite	23894-0045
3/4" EB45-DUSB Double Union SharkBite Metal Top	24477-0045
3/4" EB-45 Double Union SharkBite (60 psi Setting)	23896-0060
3/4" EB45-DUSB Double Union SharkBite with gauge	24449-0045
1" EB45-DSB Direct SharkBite	22675-0045
1" EB45-DUSB Double Union SharkBite	23358-0045
1" EB45-DUSB Double Union SharkBite (60 psi Setting)	23945-0060
EB45 LEAD FREE THREADED NPT	
1/2" EB45 Threaded NPT	23880-0045
1/2" EB45 Threaded NPT Metal Top	24460-0045
3/4" EB45 Threaded NPT	23881-0045
3/4" EB45 Threaded NPT Metal Top	24461-0045
1" EB45 Threaded NPT	23164-0045
1-1/4" EB45 Threaded NPT	23166-0045
1-1/2" EB45 Threaded NPT	23167-0045
2" EB45 Threaded NPT	23160-0045
EB45-U LEAD FREE SINGLE UNION THREADED	
1/2" EB45-U Single Union Threaded	23882-0045
1/2" EB45-U Single Union Threaded Metal Top	24462-0045
3/4" EB45-U Single Union Threaded	23883-0045
3/4" EB45-U Single Union Threaded Metal Top	24463-0045
3/4" EB45-U Union Inlet with gauge	24446-0045
1" EB45-U Single Union Threaded	23155-0045
1" EB45-U Union Inlet with gauge	24450-0045
1-1/4" EB45-U Single Union Threaded	23158-0045
1-1/2" EB45-U Single Union Threaded	23168-0045
2" EB45-U Single Union Threaded	23161-0045
EB45-C LEAD FREE SINGLE UNION SWEAT	
1/2" EB45-C Single Union Sweat	23886-0045
1/2" EB45-C Single Union Sweat Metal Top	24466-0045
3/4" EB45-C Single Union Sweat	23887-0045

PRESSURE REGULATING VALVES



PRODUCT DESCRIPTION	PART NUMBER
3/4" EB45-C Single Union Sweat Metal Top	24467-0045
3/4" EB45-C Valve Assy with gauge	24447-0045
1" EB45-C Single Union Sweat	23165-0045
1" EB45-C Valve Assy with gauge	24451-0045
1-1/4" EB45-C Single Union Sweat	23908-0045
1-1/2" EB45-C Single Union Sweat	23909-0045
2" EB45-C Single Union Sweat	23910-0045
EB45-DU LEAD FREE DOUBLE UNION THREADED	
1/2" EB45-DU Double Union Threaded	23884-0045
1/2" EB45-DU Double Union Threaded Metal Top	24464-0045
3/4" EB45-DU Double Union Threaded	23885-0045
3/4" EB45-DU Double Union Threaded Metal Top	24465-0045
1" EB45-DU Double Union Threaded	23156-0045
1-1/4" EB45-DU Double Union Threaded	23905-0045
1-1/2" EB45-DU Double Union Threaded	23906-0045
2" EB45-DU Double Union Threaded	23907-0045
EB45-CC LEAD FREE DOUBLE UNION SWEAT	
1/2" EB45-CC Double Union Sweat	23888-0045
1/2" EB45-CC Double Union Sweat Metal Top	24468-0045
3/4" EB45-CC Double Union Sweat	23889-0045
3/4" EB45-CC Double Union Sweat Metal Top	24469-0045
1" EB45-CC Double Union Sweat	23157-0045
1-1/4" EB45-CC Double Union Sweat	23159-0045
1-1/2" EB45-CC Double Union Sweat	23898-0045
2" EB45-CC Double Union Sweat	23899-0045
EB45-DUPE LEAD FREE DOUBLE UNION PEX ENDS	
3/4" EB45-DUPE Double Union PEX Ends	23891-0045
3/4" EB45-DUPE Double Union PEX Ends Metal Top	24471-0045
1" EB45-DUPE Double Union PEX Ends	23942-0045
EB45-DUCPVC LEAD FREE DOUBLE UNION CPVC ENDS	
3/4" EB45-DUCPVC Double Union CPVC Ends	23890-0045
3/4" EB45-DUCPVC Double Union CPVC Ends Metal Top	24470-0045
1" EB45-DUCPVC Double Union CPVC Ends	23941-0045
EB45 DOUBLE UNION TEMPORARY BYPASS KITS	
1" EB45 Double Union Threaded NPT Temporary Bypass Kit	22937
1" EB45 Double Union SWT Temporary Bypass Kit	22938
1-1/4" EB45 Double Union Threaded NPT Temporary Bypass Kit	22942
1-1/4" EB45 Double Union SWT Temporary Bypass Kit	22943





PRESSURE REGULATING VALVES

EB25

COMMERCIAL, RESIDENTIAL

The EB25 brings state-of-the-art water control technology to pressure regulators. The biggest breakthrough is the simple numerical indicator that allows the exact desired pressure to be set even before the valve is installed, making pressure adjustment a quick, one-man job. The EB25 Stainless Steel also features a stainless steel, 100% lead free body.

With the most advanced design in the industry, the EB25 delivers rock steady flow even with extreme variations in supply pressure. Thanks to a patented single-cartridge design, the EB25 has fewer parts for increased reliability, and it can be serviced without having to remove the valve body. The innovative design also eliminates the water whistle or harmonic hum associated with most pressure regulating valves, thanks to innovative "micro-fingers" that dissipate noise as water flows across the seat.

The EB25 comes factory set at 45 psi but can be manually adjusted between 20-90 psi.

FEATURES AND BENEFITS:

- Convenient orange twist-cap eliminates need for wrench adjustment, numerical indicator shows the pressure without the need for a gauge
- Single piece cartridges can be removed with valve body remaining in place
- Integral back-pass check with the cartridge*
- Cutting edge design and production incorporates "micro-fingers" that dissipate noise due to water flow across the seat
- Available with a blanking cap for "rough-in" installations
- Optional closing cap for direct burial applications
- Serviceable in line
- Every valve is tested for performance prior to shipping

PERFORMANCE:

Maximum pressure:	300 psi
Maximum temperature:	180°F (82.2°C)
Service:	Water
Outlet pressure range:	20-90 psi

APPLICATIONS:

Commercial and domestic water applications.

AVAILABLE CONNECTIONS:

Threaded (NPT) Inlet and Outlet ¹	3/4" and 1"
Threaded (NPT) Union, Threaded (NPT)	1/2", 3/4", 1", 1-1/4", 1-1/2" and 2"
Sweat Copper Union, Threaded (NPT)	1/2", 3/4", 1", 1-1/4", 1-1/2" and 2"
Threaded (NPT) Union Inlet and Outlet ¹	3/4", 1", 1-1/4", 1-1/2" and 2"
Sweat Copper Union Inlet and Outlet ²	3/4", 1", 1-1/4", 1-1/2" and 2"
PEX Barb Inlet and Outlet ²	3/4" and 1"

¹The 3/4" and 1" models are stainless steel.

²The 3/4" and 1" models use a stainless steel body and lead free brass tailpieces.

APPROVALS AND LISTINGS:

ASSE 1003, CSA B356, NSF/ANSI 372 (Lead Free), NSF/ANSI 61. Listed by IAPMO, CSA and ASSE.



DIMENSIONS (inches)						
Size	Connection Style	A			B	C
		Direct	Single Union	Double Union		
1/2	NPT	-	5-3/4	-	4-15/16	1-1/16
	Sweat	-	5-5/8	-		
3/4	NPT	-	5-1/2	6-11/16		
	Sweat	-	5-11/16	6-11/16		
	Barb	-	-	7-1/16		
1	NPT	-	5-3/4	7-1/16		
	Sweat	-	5-7/8	7-1/16		
	Barb	-	-	7-5/8		
1-1/4	NPT	-	5-11/16	6-9/16	7-1/2	1-3/8
	Sweat	-	5-7/8	6-15/16		
1-1/2	NPT	-	5-15/16	7		
	Sweat	-	6	7-3/16		
2	NPT	-	6	7-3/16		
	Sweat	-	6-1/4	7-11/16		

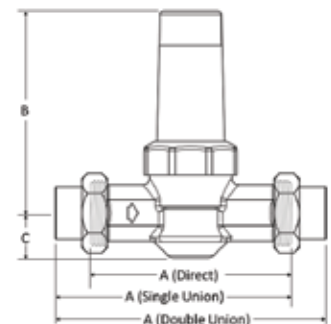

*The back-pass check feature allows for a reverse flow of water through the regulator in the event that outlet pressure increases to exceed supply pressure. Thermal expansion, created by a water heater for instance, can cause water pressure to increase. Without the back-pass check, water cannot flow in reverse.

PRESSURE REGULATING VALVES



EB25 STAINLESS STEEL

DIMENSIONS (inches)			
Size	Connection Style	A	B
3/4	NPT (Both ends)	4-7/8	2-7/16
3/4	Double Union NPT	6-11/16	3-3/8
1	NPT (Both ends)	4-7/8	2-7/16
1	Double Union NPT	6-13/16	3-7/16

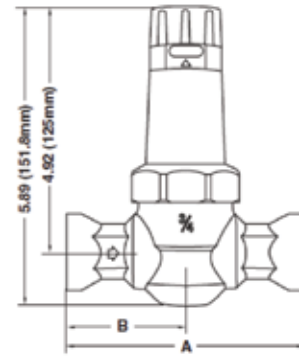

PRODUCT DESCRIPTION	PART NUMBER
EB25 LEAD FREE THREADED NPT	
3/4" EB25 Threaded NPT Stainless Steel Valve	22263-0045
1" EB25 Threaded NPT Stainless Steel Valve	22266-0045
EB25-U LEAD FREE SINGLE UNION THREADED	
1/2" EB25-U Single Union Threaded	23135-0045
3/4" EB25-U Single Union Threaded	23136-0045
1" EB25-U Single Union Threaded	23138-0045
1-1/4" EB25-U Single Union Threaded	23141-0045
1-1/2" EB25-U Single Union Threaded	23144-0045
2" EB25-U Single Union Threaded	23145-0045
EB25-U NON-POTABLE SINGLE UNION THREADED	
1-1/4" EB25-U Single Union Threaded	22249-0045
1-1/2" EB25-U Single Union Threaded	22321-0045
2" EB25-U Single Union Threaded	22323-0045
EB25-C LEAD FREE SINGLE UNION SWEAT	
1/2" EB25-C Single Union Sweat	23952-0045
3/4" EB25-C Single Union Sweat	23953-0045
1" EB25-C Single Union Sweat	23954-0045
1-1/4" EB25-C Single Union Sweat	23964-0045
1-1/2" EB25-C Single Union Sweat	23965-0045
2" EB25-C Single Union Sweat	23966-0045
EB25-C NON-POTABLE SINGLE UNION SWEAT	
1-1/4" EB25-C Single Union Sweat	22331-0045
1-1/2" EB25-C Single Union Sweat	22332-0045
2" EB25-C Single Union Sweat	22333-0045





PRESSURE REGULATING VALVES

EB25 CONT.



PRODUCT DESCRIPTION	PART NUMBER
EB25-DU LEAD FREE DOUBLE UNION THREADED	
3/4" EB25-DU Double Union Threaded Stainless Steel Valve	22264-0045
1" EB25-DU Double Union Threaded Stainless Steel Valve	22267-0045
1-1/4" EB25-DU Double Union Threaded	23142-0045
1-1/2" EB25-DU Double Union Threaded	23967-0045
2" EB25-DU Double Union Threaded	23968-0045
EB25-DU NON-POTABLE DOUBLE UNION THREADED	
1-1/4" EB25-DU Double Union Threaded	22250-0045
1-1/2" EB25-DU Double Union Threaded	22322-0045
2" EB25-DU Double Union Threaded	22324-0045
EB25-CC LEAD FREE DOUBLE UNION SWEAT	
3/4" EB25-CC Double Union Sweat	23137-0045
1" EB25-CC Double Union Sweat	23139-0045
1-1/4" EB25-CC Double Union Sweat	23143-0045
1-1/2" EB25-CC Double Union Sweat	23969-0045
2" EB25-CC Double Union Sweat	23970-0045
EB25-CC NON-POTABLE DOUBLE UNION SWEAT	
1-1/4" EB25-CC Double Union Sweat	22317-0045
1-1/2" EB25-CC Double Union Sweat	22427-0045
2" EB25-CC Double Union Sweat	22428-0045
EB25-DUPE LEAD FREE DOUBLE UNION PEX ENDS	
3/4" EB25-DUPE Double Union PEX Ends	23957-0045
1" EB25-DUPE Double Union PEX Ends	23140-0045
EB25 LEAD FREE STAINLESS STEEL THREADED NPT	
3/4" EB25 Threaded NPT	22263-0045
1" EB25 Threaded NPT	22266-0045
EB25-DU LEAD FREE STAINLESS STEEL DOUBLE UNION THREADED	
3/4" EB25-DU Double Union Threaded	22264-0045
1" EB25-DU Double Union Threaded	22267-0045
EB25 LEAD FREE CARTRIDGE KIT	
1/2"-1" EB25 Cartridge Kit	23148
1-1/4"-2" EB25 Cartridge Kit	23149
EB25 LEAD FREE INLET BLANKING CAP KIT	
1/2"-1" EB25 Inlet Blanking Cap Kit	22219
1-1/4"-2" EB25 Inlet Blanking Cap Kit	22248
EB25 LEAD FREE DIRECT BURIAL COVER KIT	
1/2"-1" EB25 Direct Burial Cover Kit	22224



EB25 SHARKBITE

COMMERCIAL, RESIDENTIAL

The EB25 Pressure Regulator with SharkBite push-fit connections brings state-of-the-art water control technology to pressure regulators. The biggest breakthrough is the simple numerical indicator that allows the exact desired pressure to be set even before the valve is installed, making pressure adjustment a quick, one-man job.

With the most advanced design in the industry, the EB25 delivers rock steady outflow even with extreme variations in supply pressure. Thanks to a patented single-cartridge design, the EB25 has fewer parts for increased reliability, and it can be serviced without having to remove the valve body. The innovative design also eliminates the water whistle or harmonic hum associated with most pressure regulating valves, thanks to innovative "micro-fingers" that dissipate noise as water flows across the seat.

The EB25 comes factory set at 45 psi but can be manually adjusted between 20-90 psi. Installed with Double Union SharkBite push-fit connections for quick, easy and watertight fit.

FEATURES AND BENEFITS:

- Instant push-fit connection for increased ease of use
- Convenient orange twist-cap eliminates need for wrench adjustment, numerical indicator shows the pressure without the need for a gauge
- Single piece cartridges can be removed with valve body remaining in place
- Integral back-pass check with the cartridge*
- Cutting edge design and production incorporates "micro-fingers" that dissipate noise due to water flow across the seat
- Available with a blanking cap for "rough-in" installations
- Optional closing cap for direct burial applications
- Serviceable in line
- Every valve is tested for performance prior to shipping

PERFORMANCE:

Maximum inlet pressure: 200 psi
 Maximum temperature: 180°F (82.2°C)
 Service: Water
 Outlet pressure range: 20-90 psi

APPLICATIONS:

Domestic water supply service.

AVAILABLE CONNECTIONS:

Union SharkBite Connection Inlet and Outlet¹ 3/4" and 1"

¹The 3/4" and 1" models use a stainless steel body and lead free brass tailpieces.

APPROVALS AND LISTINGS:

ASSE 1003, CSA B356, NSF/ANSI 372 (Lead Free), NSF/ANSI 61.
 Listed by IAPMO, CSA and ASSE.

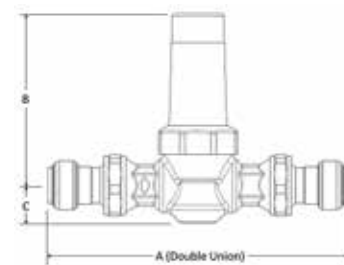

DIMENSIONS (inches)				
Size	Connection Style	A Double Union	B	C
3/4	SharkBite	8-3/8	4-15/16	1-1/16
1	SharkBite	9-1/4		

PRODUCT DESCRIPTION	PART NUMBER
EB25 LEAD FREE SHARKBITE CONNECTIONS	
3/4" EB25-DUSB Double Union SharkBite	23955-0045
1" EB25-DUSB Double Union SharkBite	23956-0045

*The back-pass check feature allows for a reverse flow of water through the regulator in the event that outlet pressure increases to exceed supply pressure. Thermal expansion, created by a water heater for instance, can cause water pressure to increase. Without the back-pass check, water cannot flow in reverse.



PRESSURE REGULATING VALVES

EB25 MULTICARTRIDGE

COMMERCIAL, INDUSTRIAL

The EB25 Multi-Cartridge pressure reducing valve eliminates the need for costly two-valve installation in applications subject to wide variation in water demand. Benefits include accurate flow control and pressure regulation, plus simple cartridge change-out for servicing. The Multi-Cartridge design has a convenient orange twist-cap and numerical indicator that allows for quick adjustment of water pressure. The state-of-the-art single piece cartridge design makes servicing the valve fast and easy. The valve is designed to service commercial and institutional water installations that experience wide variation in water demand.

Each cartridge has an adjustable range of 20–90 psi but come factory set at 55 psi, 50 psi, and 45 psi respectively.

FEATURES AND BENEFITS:

- US Patent 8,327,871
- Multi-Cartridge Design eliminates the need to install multiple PRVs in parallel
- Convenient orange twist-cap eliminates need for wrench adjustment, numerical indicator shows the pressure without the need for a gauge
- Single piece cartridges can be removed with valve body remaining in place
- Back-pass check feature integral with the cartridge*
- Cutting-edge design and production incorporates “micro-fingers” that dissipate noise due to water flow across the seat
- Regulates pressure at various levels of water demand for accurate flow control
- Serviceable in line
- Every valve is tested for performance prior to shipping

PERFORMANCE:

Maximum working pressure: 250 psi
 Maximum temperature: 180°F (82.2°C)
 Service: Water
 Outlet pressure range: 20–90 psi

APPLICATIONS:

Commercial and industrial water applications.

AVAILABLE CONNECTIONS:

Threaded (FIP) 2-1/2" and 3"
 ANSI CL 150 Flanged 2-1/2" and 3" and 4"

APPROVALS AND LISTINGS: N/A

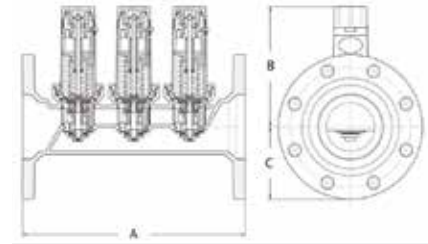

DIMENSIONS (inches)			
Dimensions	A	B	C
2-1/2 FIP	13-3/8	7-1/2	2-3/16
2-1/2 Flanged	13	7-1/2	3-1/2
3 FIP	15-3/8	7-1/2	2-9/16
3 Flanged	13-1/8	7-1/2	3-3/4
4 Flanged	13-7/8	7-1/2	4-1/2

PRODUCT DESCRIPTION	PART NUMBER
EB25 LEAD FREE MULTI-CARTRIDGE	
2-1/2" EB25 Multi-Cartridge Threaded NPT	23994-0055
2-1/2" EB25 Multi-Cartridge Flanged	23996-0055
3" EB25 Multi-Cartridge Threaded NPT	23995-0055
3" EB25 Multi-Cartridge Flanged	23997-0055
4" EB25 Multi-Cartridge Flanged	23998-0055
EB25 NON-POTABLE MULTI-CARTRIDGE	
2-1/2" EB25 Multi-Cartridge Threaded NPT	22391-0055
2-1/2" EB25 Multi-Cartridge Flanged	22624-0055
3" EB25 Multi-Cartridge Threaded NPT	22396-0055
3" EB25 Multi-Cartridge Flanged	22625-0055

*The back-pass check feature allows for a reverse flow of water through the regulator in the event that outlet pressure increases to exceed supply pressure. Thermal expansion, created by a water heater for instance, can cause water pressure to increase. Without the back-pass check, water cannot flow in reverse.

PRESSURE REGULATING VALVES



E3

COMMERCIAL, RESIDENTIAL

The Cash Acme E3 Pressure Reducing and Regulating Valve automatically reduces a high inlet pressure to a lower delivery pressure and maintains the lower pressure within acceptable limits. The valve provides substantially higher capacity and closer regulation for more demanding and higher quality installations. The Cash Acme E3 incorporates a yoke-type design, allowing the regulator to close against the inlet pressure and provide quieter operation under wide and varying flow conditions.

The E3 is designed for use where supply line inlet pressure does not exceed 300 psi and is suitable for either cold or hot [to 180°F (82.2°C)] water service for a variety of applications. The Cash Acme E3 is set at 45 psi and comes with an adjustable spring range of 20–70 psi. Low pressure (10–40 psi) and high pressure (71–150 psi) settings are also available.

FEATURES AND BENEFITS:

- Automatically reduces a high inlet pressure to a lower delivery pressure
- Solves problems of water hammer, pipe noise and rapid wearing of fixtures, faucets and valves
- Rugged bronze body
- Every valve is tested for performance prior to shipping

PERFORMANCE:

Maximum initial pressure: 250 psi
 Maximum temperature: 180°F (82.2°C)
 Service: Water
 Outlet pressure range: 20–70 psi*

*Low (10–40 psi) and High (71–150 psi) pressure ranges are also available upon request. Contact Customer Service for available part numbers.

APPLICATIONS:

Commercial and domestic water applications.

AVAILABLE CONNECTIONS:

Threaded (NPT) 1/2", 3/4", 1", 1-1/4", 1-1/2" and 2"

APPROVALS AND LISTINGS:

ASSE 1003, NSF 372. Listed by ASSE and IAPMO.

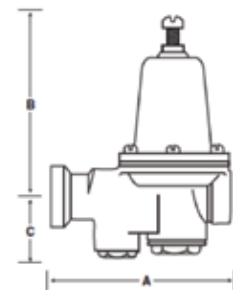

DIMENSIONS (inches)			
DIMENSIONS	A	B	C
1/2	5	5-1/4	1-3/4
3/4	5-1/2	5-15/16	1-7/8
1	6-7/16	7	2-11/16
1-1/4	7-5/8	7-1/2	3
1-1/2	8-7/8	8-1/2	3-1/4
2	10-7/16	10-1/4	3-3/16

PRODUCT DESCRIPTION	PART NUMBER
E3 LEAD FREE THREADED NPT	
1/2" E3 Threaded NPT	24700-0045
3/4" E3 Threaded NPT	24703-0045
1" E3 Threaded NPT	24706-0045
1-1/4" E3 Threaded NPT	24709-0045
1-1/2" E3 Threaded NPT	24712-0045
2" E3 Threaded NPT	24715-0045



PRESSURE REGULATING VALVES

E41

COMMERCIAL, RESIDENTIAL AND INDUSTRIAL

The Cash Acme E41 Pressure Reducing and Regulating Valve automatically reduces a high inlet pressure to a lower delivery pressure and maintains the lower pressure within acceptable limits. The valve provides high capacity and close regulation for more demanding and higher quality installations. The E41 is similar in internal design to the E3 regulator with the exception that it is not fitted with an inbuilt strainer for systems which do not require the feature, or where separate individual strainers are preferred.

The E41 is suitable for installation in domestic water supply lines (after the meter) in systems where inlet pressures do not exceed 300 psi and where system temperatures do not exceed 180°F (82.2°C). The E41 is set at 45 psi and comes with an adjustable spring range of 20–70 psi. Low pressure (10–40 psi) and high pressure (71–150 psi) settings are also available.

FEATURES AND BENEFITS:

- Automatically reduces a high inlet pressure to a lower delivery pressure
- High capacities for higher quality installations
- Rugged bronze body
- Every valve is tested for performance prior to shipping

PERFORMANCE:

Maximum initial pressure:	300 psi
Maximum temperature:	180°F (82.2°C)
Service:	Air and water
Outlet pressure range:	20–70 psi*

*Low (10–40 psi) and High (71–150 psi) pressure ranges are also available upon request. Contact Customer Service for available part numbers.

APPLICATIONS:

Commercial and domestic water applications.

AVAILABLE CONNECTIONS:

Threaded (NPT) 1/2", 3/4", 1", 1-1/4", 1-1/2" and 2"

APPROVALS AND LISTINGS:

ASSE 1003, NSF 372. Listed by ASSE.

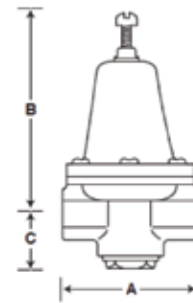

DIMENSIONS (inches)			
DIMENSIONS	A	B	C
1/2	3-3/8	5-1/4	1-1/2
3/4	4-1/16	5-15/16	1-7/8
1	4-9/16	7	2-5/16
1-1/4	5-3/16	8	2-3/8
1-1/2	5-13/16	8-1/2	2-5/8
2	6-1/2	10-1/4	2-3/4

PRODUCT DESCRIPTION	PART NUMBER
E41 LEAD FREE THREADED NPT	
1/2" E41 Threaded NPT	24478-0045
3/4" E41 Threaded NPT	24480-0045
1" E41 Threaded NPT	24482-0045
1-1/4" E41 Threaded NPT	24484-0045
1-1/2" E41 Threaded NPT	24486-0045
2" E41 Threaded NPT	24487-0045

PRESSURE REGULATING VALVES



E56

COMMERCIAL, INDUSTRIAL

The E56 Piston Type Pressure Regulating Valve automatically reduces a high inlet pressure to a lower delivery pressure and maintains the lower pressure within acceptable limits. The valve is designed for water, air, light oil, gases (except steam) and other fluids not corrosive to brass. The E56 is exceptionally simple in construction and does not have a diaphragm. Instead it incorporates a chrome plated spring-opposed, balanced piston design. The balanced piston allows for extreme fluctuations in inlet pressures to act uniformly on the piston, producing more sensitive operation while providing for closer regulation and quiet performance.

The E56 is available with threaded or flanged connections in 2", 2-1/2", and 3" sizes. The E56 is available with a variety of factory set pressures ranging from 15-125 psi. The available spring ranges depend on the spring installed: 15-50 psi, 40-60 psi, 50-110 psi, or 80-125 psi.

FEATURES AND BENEFITS:

- Automatically reduces a high inlet pressure to a lower delivery pressure
- Large commercial and industrial water or air service installations
- Balanced piston design provides for closer regulation and quiet performance
- Simple, dependable construction
- Available with threaded or flanged ends
- Every valve is tested for performance prior to shipping

PERFORMANCE:

Maximum initial pressure: 400 psi (threaded), 225 psi (150 lb ANSI flanged)
 Maximum temperature: 180°F (82.2°C)
 Service: Air, water, light oils and gasses (except steam)
 Outlet pressure range: 15-50 psi, 40-60 psi, 50-110 psi and 80-125 psi*

*Additional pressure settings available. Contact Customer Service for available ranges and part numbers.

APPLICATIONS:

Large commercial and industrial water, air, light oil and gas (except steam) service installations.

AVAILABLE CONNECTIONS:

Threaded (NPT) 2", 2-1/2" and 3"
 ANSI CL 150 Flanged 2", 2-1/2" and 3"

APPROVALS AND LISTINGS: N/A

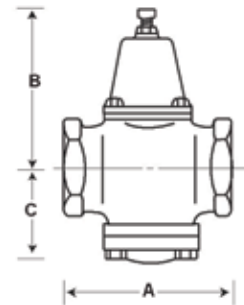

DIMENSIONS (inches)				
Size	CONNECTION STYLE	A	B	C
2	Threaded	7-1/2	7	3-1/2
2-1/2	Threaded	7-1/2	7	3-1/2
3	Threaded	9-1/4	7	3-1/2
2	150 lb MSS Flanges	8-1/4	7	3-1/2
2-1/2	150 lb MSS Flanges	8-1/4	7	3-1/2
3	150 lb MSS Flanges	8-1/4	7	3-3/4

PRODUCT DESCRIPTION	PART NUMBER
E56 LEAD FREE HIGH CAPACITY REGULATOR	
2" E56 Threaded NPT	24454-0045
2" E56 Flanged	24457-0045
2-1/2" E56 Threaded NPT	24455-0045
2-1/2" E56 Flanged	24458-0045
3" E56 Threaded NPT	24456-0045
3" E56 Flanged	24459-0045
E56 NON-POTABLE HIGH CAPACITY REGULATOR	
2" E56 Flanged	07294-0045
2-1/2" E56 Threaded	07293-0045
2-1/2" E56 Flanged	07295-0045



PRESSURE REGULATING VALVES

EB75

INDUSTRIAL

The EB75 is a compact, iron-body pressure reducing and regulating valve designed for installations where small size and economy are important. Because of the iron body, this valve is not recommended for use in potable water applications. The EB75 comes factory set at 45 psi but has an adjustment range of 10–70 psi. The valve also comes in a low pressure range of 0–20 psi.

FEATURES AND BENEFITS:

- Inbuilt back-pass check allows water to flow back through the regulator in cases of thermal expansion caused by hot water heating devices*
- Fully pressure-balanced piston automatically reduces and regulates high inlet pressures from a maximum of 300 psi down to 45 psi at standard factory setting
- Every valve is tested for performance prior to shipping

PERFORMANCE:

Maximum initial pressure: 300 psi
 Maximum temperature: 180°F (82.2°C)
 Service: Water
 Outlet pressure range: 10–70 psi¹

¹0–20 psi is also available upon request

APPLICATIONS:

Non-potable industrial water system applications.

AVAILABLE CONNECTIONS:

Threaded (NPT) 1/2" and 3/4"

APPROVALS AND LISTINGS: N/A



PRODUCT DESCRIPTION	PART NUMBER
EB75 NON-POTABLE PRESSURE REGULATORS FOR WATER & AIR	
1/2" EB75 FPT X FPT (Valve is not a cartridge based design; 0–20 psi range)	20658-0005
3/4" EB75 FPT X FPT (Valve is not a cartridge based design; 0–20 psi range)	20662-0005
1/2" EB75 FPT X FPT (Cartridge based design; 10–70 psi range)	22999-0045
3/4" EB75 FPT X FPT (Cartridge based design; 10–70 psi range)	23000-0045
E75P NON-POTABLE PRESSURE REGULATORS FOR PROPANE	
1/2" Threaded Inlet	20657-0008
1/2" Threaded Inlet with Clean-Out Plug	20664-0010

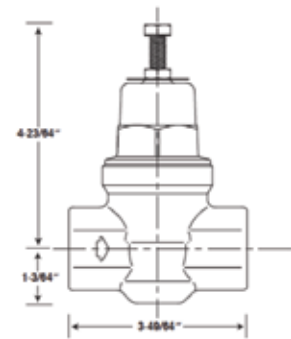

*The back-pass check feature allows for a reverse flow of water through the regulator in the event that outlet pressure increases to exceed supply pressure. Thermal expansion, created by a water heater for instance, can cause water pressure to increase. Without the back-pass check, water cannot flow in reverse.



PRV REPAIR KITS

RESIDENTIAL

Pressure Regulator Repair Kits contain internal components to repair Cash Acme PRV products. The applicable kit configuration(s) matches up with existing Cash Acme PRV model numbers and sizes.

APPLICATIONS:

Used for the maintenance and repair of the internal components of existing PRV devices.

AVAILABLE CONNECTIONS:

- EB45 Cartridge Kits
- EB25 Cartridge Kits
- E3 Repair Kits
- E41 Repair Kits
- E56 Repair Kits

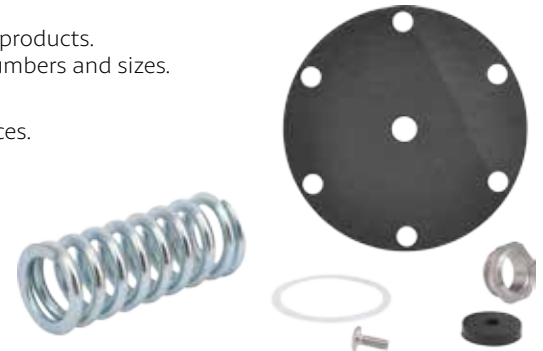

PRODUCT DESCRIPTION	PART NUMBER
EB45 REPAIR KITS	
EB45 Cartridge Kit-Compact Model (1/2"-3/4" Compact Models)	23870
EB45 Cartridge Kit-Classic Model (1/2"-1" Classic Models)	22595
EB45 Cartridge Kit-(1-1/4"-2" Models)	23871
EB25 REPAIR KITS	
EB25 Cartridge Kit-(1/2"-1" Models)	23148
EB25 Cartridge Kit-(1-1/4"-2" Models and Multi-Cartridge)	23149
E3 REPAIR KITS	
1/2" Repair Kit	11488
3/4" Repair Kit	11489
1" Repair Kit	11490
1-1/4" Repair Kit	11491
1-1/2" Repair Kit	11492
2" Repair Kit	11493
E41 REPAIR KITS	
1/2" Repair Kit	11259
3/4" Repair Kit	11260
1" Repair Kit	11261
1-1/4" Repair Kit	11262
1-1/2" Repair Kit	11263
2" Repair Kit	11264
E56 REPAIR KIT	
All Repair Kit	20778

THERMOSTATIC MIXING VALVES

Cash Acme is an experienced supplier of thermostatic mixing valves (TMVs), providing an extensive range of devices for residential, commercial, industrial and even hydronic heating applications. Available with a wide range of connections, our TMVs accurately control the temperature of hot water at the source of heat (water heater) or at the point-of-use to individual or multiple fixtures (sinks, lavatories, bath tubs, etc.) to deliver water at a safe temperature, regulate water distribution and flow and provide sanitary anti-scald protection.

Cash Acme TMVs can also be used to blend the flow and return in underfloor hydronic heating systems. They provide a safe, energy efficient and stable temperature in the heating system, preventing heat damage to the building and creating safer underfloor surfaces.

Cash Acme thermostatic mixing valves are manufactured in our state-of-art ISO 9001 compliant Brisbane, Australia facility and certified to various plumbing standards such as ASSE 1017, ASSE 1069, ASSE 1070, CSAB125, NSF 372, NSF61 and listed with ASSE, CSA & IAPMO for use in accordance with U.S. and Canadian plumbing codes. Every valve is 100% tested for function, safety, and performance before it is shipped from the factory.

CASH ACME HEATG

C



ASSE 1017

THERMOSTATIC MIXING VALVES



TANK BOOSTER

COMMERCIAL, RESIDENTIAL

The Cash Acme Tank Booster combines a Thermostatic Mixing Valve (TMV), a Flexible Connector and a Water Heater Tee in one package, and when combined with elevated storage temperatures, can effectively double a household's hot water heater capacity while delivering hot water at safe temperatures in residential/commercial applications. Available in regular and "PRO" models, both versions of the TMV are factory set at 120°F (48.9°C), but may be easily adjusted, and can be used with SharkBite Flexible Water Heater Connectors and Ball Valves for easy installation in systems using copper, CPVC or PEX tubing—no need for additional transition fittings.

Tank Booster model features a knob adjustment with tamper-evident sticker, lockable adjustment, with a temperature range of 90°F (32.2°C)–130°F (54.4°C), non–return check valves at both inlets, and filters at both inlets.

Tank Booster PRO model features a lockable adjustment with a temperature range of 90°F (32.2°C)–130°F (54.4°C), recirculation port, non–return check valves and filters at both inlets. It is dual listed for water distribution and for sanitary applications.

FEATURES AND BENEFITS:

- Precise temperature control means safer hot water from all outlets
- Allows the water heater to be set at 140°F (60°C) or higher, yielding greater effective hot water volume and reducing the chance of growth of Legionella bacteria
- Every valve is tested for performance on an automated testing station during the assembly process
- Robust, low complexity construction for superior reliability.
- Mixed outlet flow of water reduces to a trickle in case of cold water supply failure, providing greater end user safety
- Adjustable and lockable mechanism minimizes unauthorized tampering with valve setting
- Factory set, locked to maximum 120°F (48.9°C)
- Recirculation port with plug decreases potential heat loss

PERFORMANCE:

Outlet temperature range	90–130°F (32.2–54.4°C)
Factory set temperature range	115–120°F (46.1–48.9°C)
Temp. hot supply	120–180°F (48.9–82.2°C)
Temp. cold supply	39–80°F (3.9–26.7°C)
Maximum pressure	230 psi (1600 kPa)
Flow rate, minimum	1 gpm (3.8 l/min)
Flow rate, maximum	11 gpm (42 l/min) at 45 psi

APPLICATIONS:

Domestic and commercial hot water distribution. To control water temperature at the source of heat (hot water tank) or point-of-use* (sinks, lavatories, or bath tubs).

AVAILABLE CONNECTIONS:

3/4" MNPT mix outlet x 3/4" FNPT union fitting x 3/4" NPSH cold inlet.

APPROVALS AND LISTINGS:

ASSE 1017, ASSE 1070*, CSA B125.3, NSF/ANSI 372 (Lead Free), NSF/ANSI 61. Listed by ASSE and IAPMO.

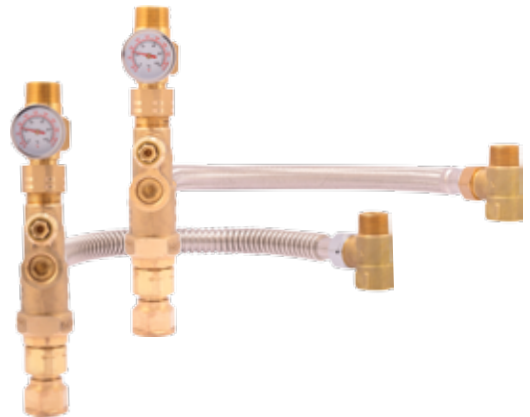

PRODUCT DESCRIPTION	PART NUMBER
TANK BOOSTER PRO – US	
3/4" Heatguard Tank Booster Pro with Corrugated Hose, Integral Checks, and Temperature Gauge	24643
3/4" Heatguard Tank Booster Pro with Braided Hose, Integral Checks, and Temperature Gauge	24644

PRODUCT DESCRIPTION	PART NUMBER
TANK BOOSTER PRO – CANADA	
3/4" Heatguard Tank Booster Pro with Corrugated Hose and Integral Checks	24639
3/4" Heatguard Tank Booster Pro with Braided Hose and Integral Checks	24832



THERMOSTATIC MIXING VALVES

TANK BOOSTER CONT.

TANK BOOSTER CONNECTIONS

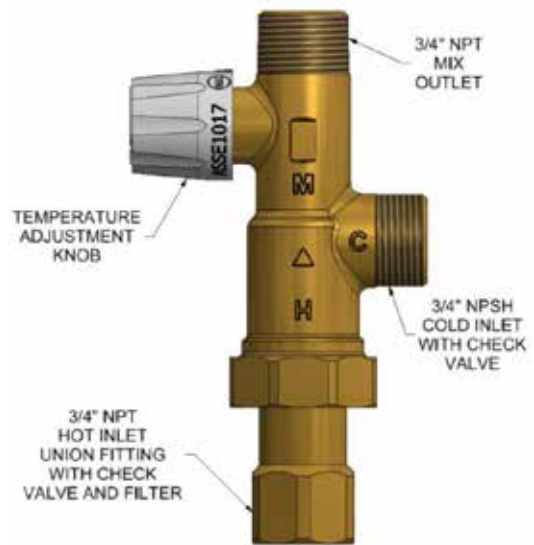
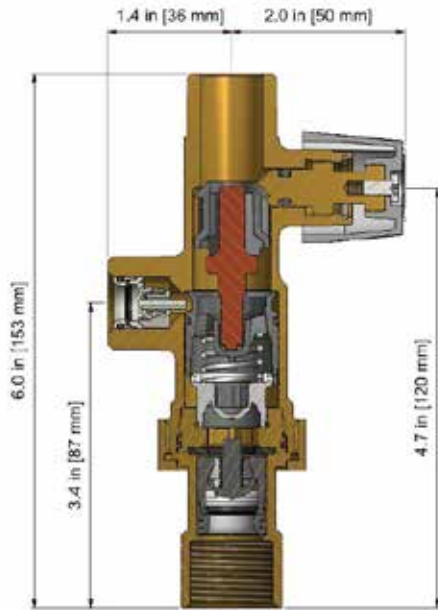

TANK BOOSTER PRO CONNECTIONS

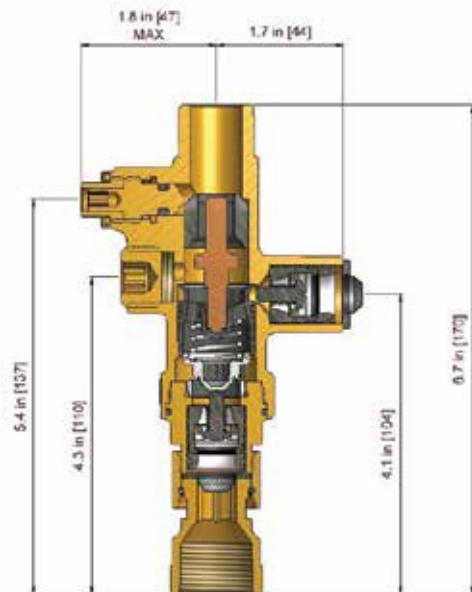
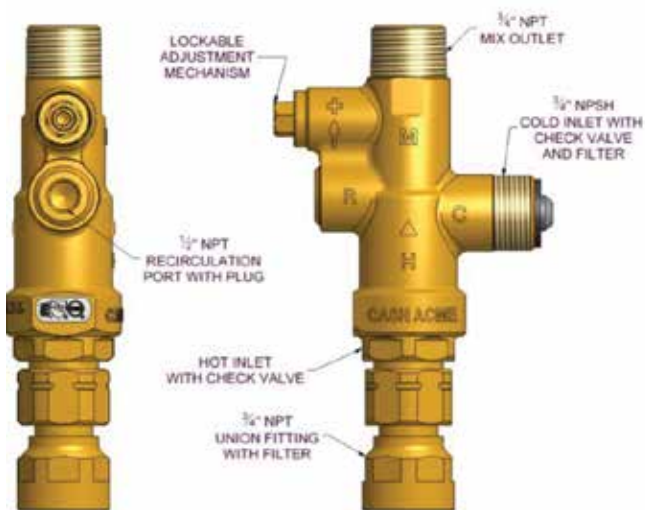

INCHES (MM)

THERMOSTATIC MIXING VALVES



HG110 D

COMMERCIAL, RESIDENTIAL

The HG110 D LF, a triple-listed thermostatic mixing valve, delivers water at a safe 120°F (48.9°C) or lower from all outlets, while allowing the water heater to be set at a germ-killing 140°F (60°C) or higher which aids in preventing the growth of Legionella bacteria in the water heater. The higher tank temperature means that hot water demands can be satisfied longer. Every valve is tested for performance prior to shipping. Adjustable and lockable mechanism minimizes unauthorized tampering with valve setting. Each valve is factory set and locked to a maximum 120°F (48.9°C). Adj. outlet temperature range: 85–130°F (29.4–54.4°C).

FEATURES AND BENEFITS:

- Certified for distribution and individual/multiple point-of-use applications for safer hot water from all outlets
- Allows the water heater to be set at 140°F (60°C) or higher, yielding greater effective hot water volume and reducing the chance of growth of Legionella bacteria
- Every valve is tested for performance on an automated testing station during the assembly process
- Robust, low complexity construction for superior reliability
- Mixed outlet flow of water reduces to a trickle in case of cold water supply failure, providing greater end user safety
- Adjustable and lockable mechanism minimizes unauthorized tampering with valve setting
- Factory set, locked to maximum 120°F (48.9°C)

PERFORMANCE:

Outlet temperature range	85–130°F (29.4–54.4°C)	Factory set and locked 120°F (48.9°C)
Factory set and locked	120°F (48.9°C)	
Temp. hot supply	120–180°F (48.9–82.2°C)	
Temp. cold supply	39–80°F (3.9–26.7°C)	
Maximum pressure	230 psi (1600 kPa)	
Flow rate, minimum	1 gpm (3.8 l/min)	
Flow rate, maximum	20 gpm (76 l/min)	

APPLICATIONS:

Domestic and Commercial hot water distribution. To control water temperature at the source of heat (hot water tank), point-of-use (sinks, lavatories, or bath tubs) or multiple fixtures (multiple sinks or gang shower applications where bather has no access to temperature control).

AVAILABLE CONNECTIONS:

Sweat	1/2", 3/4" and 1"
Barb (PEX)	1/2" and 3/4"
Threaded (NPT)	1/2" and 3/4"
CPVC	1/2" and 3/4"
SharkBite Union	1/2" and 3/4"
Direct SharkBite	1/2" and 3/4"

APPROVALS AND LISTINGS:

ASSE 1017, 1069 & 1070, CSA B125.3, NSF/ANSI 372 (Lead Free), NSF/ANSI 61. Listed by ASSE, CSA and IAPMO.



PRODUCT DESCRIPTION	PART NUMBER
HG110-D LEAD FREE	
1/2" HG110-D with Integrated SharkBite Connections and Integral Checks	24548
3/4" HG110-D with Integrated SharkBite Connections and Integral Checks	24549
1/2" HG110-D with SharkBite Union Connections and Integral Checks	24504
3/4" HG110-D with SharkBite Union Connections and Integral Checks	24505
1/2" HG110-D with Threaded FNPT Connections and Integral Checks	24510
3/4" HG110-D with Threaded MNPT Connections and Integral Checks	24511
1/2" HG110-D with Sweat Connections and Integral Checks	24501
3/4" HG110-D with Sweat Connections and Integral Checks	24502
1" HG110-D with Sweat Connections and Integral Checks	24503
1/2" HG110-D with CPVC Connections and Integral Checks	24508
3/4" HG110-D with CPVC Connections and Integral Checks	24509
1/2" HG110-D with Barb Connections and Integral Checks	24506
3/4" HG110-D with Barb Connections and Integral Checks	24507

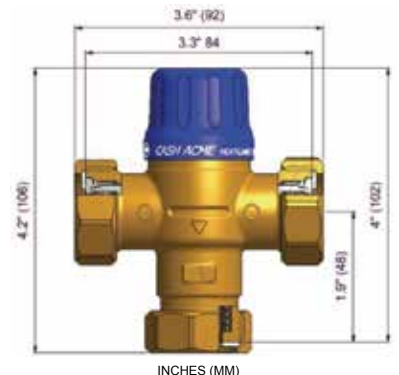



THERMOSTATIC MIXING VALVES

HG160

COMMERCIAL, RESIDENTIAL

The HG160 LF is a next generation Temperature Actuated Mixing Valve that mixes hot water with cold to deliver tempered water at a controlled temperature, at flow rates as low as 0.34 gpm (1.3 l/min) or as high as 11 gpm (42 l/m). The Heatguard® 160 is designed to assist in prevention of scalding and thermal shock. The Heatguard 160 LF is a compact, robust, simple product incorporating the latest in thermostatic technology. Every valve is tested for performance prior to shipping. Adjustable and lockable mechanism minimizes unauthorized tampering with valve setting. Each valve is factory set and locked to a maximum 120°F (48.9°C). Adj. outlet temperature range: 95–120°F (35–48.9°C).

FEATURES AND BENEFITS:

- Accurate temperature control, even under varying supply conditions
- Robust, low complexity construction for superior reliability
- Mixed outlet flow of water reduces to a trickle in case of cold water supply failure, providing greater end user safety
- Unique, purpose designed adjuster tool minimizes unauthorized tampering with valve setting
- Every valve is tested for performance on an automated testing station during the assembly process

PERFORMANCE:

Adj. outlet temperature range	95–120°F (35–48.9°C)
Factory set temperature range	115–120°F (46.1–48.9°C)
Temp. hot supply	120–180°F (48.9–82.2°C)
Temp. cold supply	39–80°F (3.9–26.7°C)
Maximum pressure	145 psi (1000 kPa)
Flow rate, minimum	0.34 gpm (1.3 l/min)
Flow rate, maximum	11 gpm (42 l/min)

APPLICATIONS:

Domestic and Commercial point-of-use. The Heatguard 160 is intended to control the water temperature to individual or multiple fixtures such as sinks, lavatories, or bath tubs to reduce the risk of scalding and thermal shock, where more flow is required than the HG 145. It can also be installed in gang shower applications where the bather has no access to the temperature adjustment means.

AVAILABLE CONNECTIONS:

Sweat	1/2"
Barb (PEX)	1/2" and 3/4"
Threaded (NPT)	1/2" and 3/4"
CPVC	1/2" and 3/4"
SharkBite	1/2" and 3/4"

APPROVALS AND LISTINGS:

ASSE 1069 & 1070, CSA B125.3, NSF/ANSI 372 (Lead Free), NSF/ANSI 61. Listed by ASSE, CSA and IAPMO



PRODUCT DESCRIPTION	PART NUMBER
HG160 LEAD FREE	
1/2" HG160 with SharkBite Connections and Integral Checks	24529
3/4" HG160 with SharkBite Connections and Integral Checks	24530
1/2" HG160 with Threaded NPT Connections and Integral Checks	24536
1/2" HG160 with Sweat Connections and Integral Checks	24528
1/2" HG160 with CPVC Connections and Integral Checks	24533
3/4" HG160 with CPVC Connections and Integral Checks	24534
1/2" HG160 with Barb Connections and Integral Checks	24531
3/4" HG160 with Barb Connections and Integral Checks	24532

THERMOSTATIC MIXING VALVES



HG145

COMMERCIAL, RESIDENTIAL

The HG145 LF is a point-of-use thermostatic mixing valve designed to assist in the prevention of scalding. Superior, fast acting thermostatic element provides stable operation at flow rates as low as 0.34 gpm (1.3 l/min) or as high as 5.8 gpm (22 l/min). The Heatguard valve also reduces the outlet flow to a trickle in the event of cold water supply failure. Inlet connections are typical supply line 3/8" compression for 3/8" OD tube. The valve is supplied standard with check valves at hot and cold water inlets. Compact design easily fits under or behind a single basin. Adj. outlet temperature range: 95-118°F (35-47.8°C).

FEATURES AND BENEFITS:

- Compact design easily fits under or behind a single basin
- Accurate temperature control with flows as low as 0.34 gpm (1.3 l/min) for increased user comfort and convenience, (especially with sensor faucets)
- Robust, low complexity construction for superior reliability
- Mixed outlet flow of water reduces to a trickle in case of cold water supply failure, providing greater end user safety
- Every valve is tested for performance on an automated testing station during the assembly process

PERFORMANCE:

Adj. outlet temperature range	95-118°F (35-47.8°C)
Factory set temperature range	104-110°F (40-43.3°C)
Temp. hot supply	120-194°F (48.9-90°C)
Temp. cold supply	39-85°F (3.9-29.4°C)
Maximum pressure	230 psi (1600 kPa)
Flow rate, minimum	0.34 gpm (1.3 l/min)
Flow rate, maximum	@ 45 psi 5.8 gpm (22 l/min)

APPLICATIONS:

Intended for under sink installations to provide safe outlet water temperature; ideal for individual faucets and electronic faucets.

AVAILABLE CONNECTIONS:

Compression suitable for 3/8" OD tube. Also available with cold water bypass and elbow insert fittings.

APPROVALS AND LISTINGS:

ASSE 1070, CSA B125.3, NSF/ANSI 372 (Lead Free), NSF/ANSI 61. Listed by ASSE, CSA and IAPMO.



PRODUCT DESCRIPTION	PART NUMBER
HG145 LEAD FREE	
3/8" HG145 with Compression Connections and Integral Checks	24524
3/8" HG145 with Compression Connections, Tee & Elbow and Integral Checks	24525

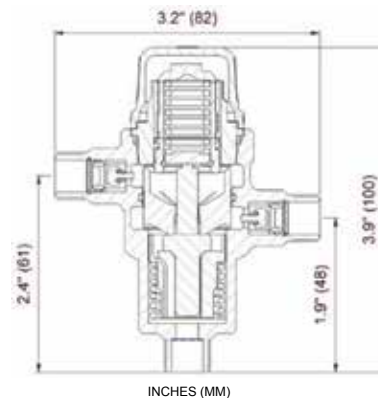
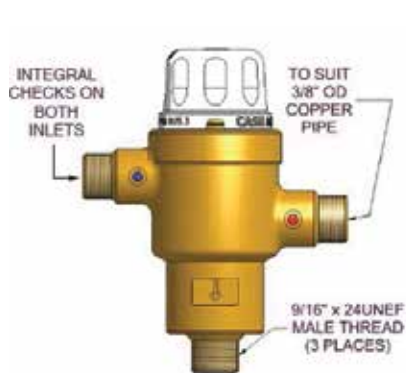



THERMOSTATIC MIXING VALVES

HG110-HX

COMMERCIAL, RESIDENTIAL

The HG110-HX LF temperature actuated thermostatic mixing valve mixes hot and cold water to deliver reduced temperature hot water. This Heatguard valve offers a high flow rate which reduces system pressure losses, and robust, low complexity construction. An adjustable and lockable handle prevents tampering. The extended outlet temperature range—up to 176°F (80°C)—makes the 110-HX LF ideal for heating system applications. Adj. outlet temperature range: 85–176°F (29.4–80°C).

FEATURES AND BENEFITS:

- High flow rate design for lower pressure losses within the system providing efficient system performance for lower running costs
- Robust, low complexity construction for superior reliability
- Integral union connections on all three ports for Easy and quick install and service
- Unique, purpose designed adjuster tool integrated with cap minimizes unauthorized tampering with valve setting
- Every valve is tested for performance on an automated testing station during the assembly process

PERFORMANCE:

Adj. outlet temperature range	85–176°F (29.4–80°C)
Factory set outlet temperature range	115–120°F (46.1–48.9°C)
Temp. hot supply	120–180°F (48.9–82.2°C)
Temp. cold supply	39–80°F (3.9–26.7°C)
Maximum pressure	230 psi (1600 kPa)
Flow rate, minimum	1 gpm (3.8 l/min)
Flow rate, maximum	20 gpm (76 l/min)

APPLICATIONS:

Hydronic and radiant heating systems.

AVAILABLE CONNECTIONS:

Sweat	1/2", 3/4" and 1"
Threaded (NPT)	1/2" and 3/4"

APPROVALS AND LISTINGS:

ASSE 1017, CSA B125.3, NSF/ANSI 372 (Lead Free), NSF/ANSI 61. Listed by ASSE and IAPMO.



PRODUCT DESCRIPTION	PART NUMBER
HG110-HX LEAD FREE	
1/2" HG110-HX with Threaded NPT Connections and Integral Checks	24517
3/4" HG110-HX with Threaded NPT Connections and Integral Checks	24518
1/2" HG110-HX with Sweat Connections and Integral Checks	24513
3/4" HG110-HX with Sweat Connections and Integral Checks	24514
1" HG110-HX with Sweat Connections and Integral Checks	24515

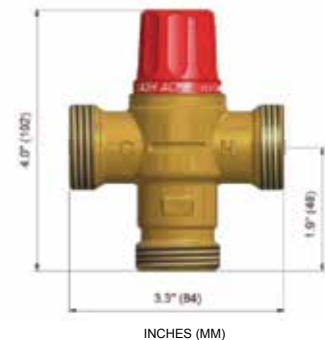

THERMOSTATIC MIXING VALVES



HG115

COMMERCIAL, RESIDENTIAL

The HG115 LF thermostatic mixing valve offers the same reliable protection of the 110-D, but on a larger scale. A fast acting, high quality thermostatic element senses the outlet water temperature and reacts to maintain a stable delivery temperature, even under changing flows or variations in supply temperatures. This Heatguard valve also greatly reduces the outlet flow in the event of a cold water supply failure. The adjusting handle can be locked at a desired temperature or function in an adjusting mode. It is clearly marked to indicate the direction to turn to achieve hotter or colder water temperatures. The valve delivers water at a maximum of 120°F (48.9°C), allowing the heater to be set at 140°F (60°C) or higher, thus providing a greater effective volume of hot water and reducing the chances of Legionella bacteria growth in the water. The maximum outlet water flow rate is 27.2 gpm, making it suitable for larger residential and commercial installations. Adjustable outlet temperature range: 85–176°F (29.4–80°C).

FEATURES AND BENEFITS:

- Delivers water at a maximum of 120°F (48.9°C) throughout the system for safer hot water from all outlets
- Allows the water heater to be set at 140°F (60°C) or higher, yielding greater effective hot water volume and reducing the chance of growth of Legionella bacteria
- Large sized valve with high flow rates can supply controlled water to a large installation
- Robust, low complexity construction for superior reliability
- Mixed outlet flow of water reduces to a trickle in case of cold water supply failure, providing greater end user safety
- Integral union connections on all three ports for easy and quick install and service

PERFORMANCE:

Adj. outlet temperature range	85–176°F (29.4–80°C)
Temp. hot supply	120–180°F (48.9–82.2°C)
Temp. cold supply	39–80°F (3.9–26.7°C)
Maximum pressure	230 psi (1600 kPa)
Flow rate, minimum	2.5 gpm (9.5 l/min)
Flow rate, maximum	27.2 gpm (100 l/min)

APPLICATIONS:

Widely used in large domestic and standard commercial water distribution systems. Ideal for installation in: a) hydronic radiant heating systems in conjunction with the water heating source to distribute tempered water to the system; and b) a hot water system at the water heater to distribute controlled temperature water.

AVAILABLE CONNECTIONS:

Sweat	3/4", 1" and 1-1/4"
Threaded (NPT)	3/4" and 1"

APPROVALS AND LISTINGS:

ASSE 1017, CSA B125.3, NSF/ANSI 372 (Lead Free), NSF/ANSI 61. Listed by ASSE and IAPMO.



PRODUCT DESCRIPTION	PART NUMBER
HG115 LEAD FREE HIGH CAPACITY	
3/4" HG115 with Threaded NPT Connections and Integral Checks	24522
3/4" HG115 with Sweat Connections and Integral Checks	24519
1" HG115 with Sweat Connections and Integral Checks	24520
1-1/4" HG115 with Sweat Connections and Integral Checks	24521





THERMOSTATIC MIXING VALVES

TAFR

COMMERCIAL, RESIDENTIAL

The Temperature Actuated Flow Reducer (TAFR) is designed to help protect against scalding. Automatically reduces water flow through fixture to 0.25 gpm if water temperature exceeds set temperature of 117°F (47.2°C). Thermal element senses high temperature water and shuts off flow to protect user. Device will only reset when water temperature drops to a safe level.

Available to suit shower heads and faucets (male and female thread).

FEATURES AND BENEFITS:

- Conforms to international safety standards
- Simple and effective scald prevention
- Quick installation and fits most showers and taps
- Strong lead free brass construction with a sleek chrome finish design
- Perfect for remodeling applications
- Ease of installation provides cost effective scald protection

PERFORMANCE:

Heatguard ShowerSafe Device Performance:

Hot water supply temperature	185°F (85°C) max.
Max. flow rate	4.0 gpm
Shut-down	less than 0.25 gpm
Nominal set temperature	117°F (47.2°C) ± 2°F
Max. operating pressure	145 psi
Min. operating pressure	less than 1.5 psi
Threads	1/2" NPT (inlet/outlet)

Heatguard TapSafe Device Performance:

Hot water supply temperature	185°F (85°C) max.
Max. flow rate	2.5 gpm
Shut-down	less than 0.25 gpm
Nominal set temperature	117°F (47.2°C) ± 2°F
Max. operating pressure	145 psi
Min. operating pressure	less than 1.5 psi
Threads	Adaptor for standard male or female laundry faucets



APPLICATIONS:

For shower or faucet spouts in private and public housing, child care centers, hospitals, hotels/motels, nursing homes and more.

APPROVALS AND LISTINGS:

ASSE 1062, CSA B125.3, NSF/ANSI 372 (Lead Free), NSF/ANSI 61. Listed by ASSE and IAPMO.

PRODUCT DESCRIPTION	PART NUMBER
HEATGUARD TAFR LEAD FREE SHUT-OFF DEVICES	
1/2" Shower Device	24718
1/2" Tap Device (For Faucet Spout)	24719

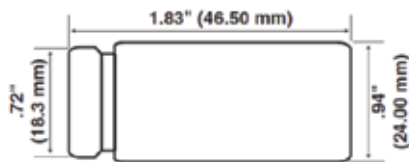

ShowerSafe 24718

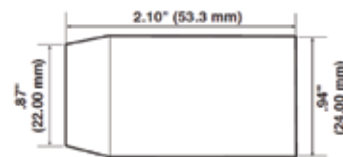

TapSafe 24719

THERMOSTATIC MIXING VALVES



MASTERGUARD® 800

COMMERCIAL, INDUSTRIAL

The Masterguard® 800 Series features a range of high flow rate valves that mix hot water with cold water to deliver water at a safe controlled temperature, typically 120°F (48.9°C). It features, state of art, fast acting, high quality thermostatic mixing valve elements that sense the outlet temperature and react to maintain a stable delivery temperature even under varying and extremely low flows. The adjusting handle can be locked at a desired temperature. Each valve has integral mounting feet to allow it to be securely fixed to a wall or frame. Complete with 4-in-1 service fittings on each inlet. Every valve is factory tested.

Adj. outlet temperature range: 95–150°F (35–65.6°C) The Masterguard 800 Series features a range of high flow rate valves that mix hot water with cold water to deliver water at a safe controlled temperature, typically 120°F (48.9°C). It features, state of art, fast acting, high quality thermostatic elements that sense the outlet temperature and react to maintain a stable delivery temperature even under varying and extremely low flows. The adjusting handle can be locked at a desired temperature. Each valve has integral mounting feet to allow it to be securely fixed to a wall or frame. Complete with 4-in-1 service fittings on each inlet. Every valve is factory tested.

FEATURES AND BENEFITS:

- Accurate temperature control, even at very low flows
- Integral mounting feet on valve body, meaning no extra brackets to buy, lower cost and more secure installation
- Fast reaction to changes in flow rate or supply temperature results in constant outlet temperature
- Robust, low complexity construction for superior reliability

PERFORMANCE:

Outlet temperature range	95–150°F (35–65.6°C)
Factory set temp. range	117.5°F ± 35.6°F (47.5°C ± 2°C)
Temp. hot supply	120–180°F (48.9–82.2°C)
Temp. cold supply	39–80°F (3.9–26.7°C)
Maximum pressure	145 psi (1000 kPa)



APPLICATIONS:

Commercial and industrial facilities to distribute controlled temperature water to the domestic hot water system of the entire building or a section of the building.

APPROVALS AND LISTINGS:

ASSE 1017, CSA B125.3. Listed by IAPMO.

MEASUREMENT (inches)												
Product	Inlet (NPT)	Outlet (NPT)	Flow @ 45 psi	Min flow rate	A	B	C	D	E	F	G	H
830	3/4	1	51 gpm	4 gpm	10.6	3.2	10.3	13.8	1.7	6.5	3.5	2.7
840	1	1-1/4	75 gpm	8 gpm	11.0	3.6	10.3	13.8	1.7	6.5	3.5	2.8
850	1-1/4	1-1/2	105 gpm	13 gpm	13.2	4.2	14.6	19.8	2.5	9.3	5.1	2.7
860	1-1/2	2	149 gpm	18.5 gpm	13.7	4.7	14.6	19.8	2.5	9.3	5.1	1.9

PRODUCT DESCRIPTION	PART NUMBER
MASTERGUARD 800 SERIES HIGH CAPACITY NON-POTABLE	
Masterguard 810- 1/2" Inlet X 3/4" Outlet with 4-in-1 Fittings	MIX81001
Masterguard 830- 3/4" Inlet X 1" Outlet with 4-in-1 Fittings	MIX83001
MASTERGUARD 800 SERIES HIGH CAPACITY LEAD FREE	
Masterguard 830 3/4" X 1" LF	24539
Masterguard 840 1" X 1-1/4" LF	24540
Masterguard 850 1-1/4" X 1-1/2" LF	24541
Masterguard 860 1-1/2" X 2" LF	24542

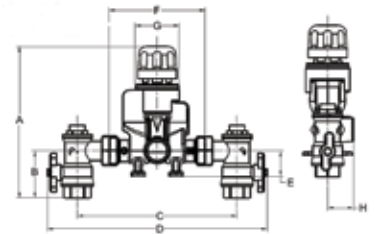



TEMPERATURE & PRESSURE RELIEF VALVES

Cash Acme is an industry leader in producing Temperature & Pressure (T&P) Relief Valves for water heaters and hot water storage tanks. Cash Acme offers an extensive line of temperature and pressure relief valve products, including robust high capacity commercial products, compact residential models, and agricultural products.

Each pressure relief valve is tested for performance, quality and efficiency before it leaves our factory.

Our products include models that are ASME, ANSI and CSA (AGA) approved to protect water heaters from excess pressures and temperatures by discharging water. Relief valves are completely automatic and reset after the pressure has been relieved.

TEMPERATURE & PRESSURE RELIEF VALVES



NCLX

RESIDENTIAL

The NCLX features include a cast bronze body, brass and stainless steel internal parts, silicone seat disc and stainless steel spring. The NCLX incorporates an inert thermal element coating that provides effective isolation from mineral deposits (liming). The NCLX comes standard with a test lever. The valve is completely automatic and reseats after either temperature or pressure relief. The NCLX is available in male inlets and female outlets with several options in shank and element lengths.

FEATURES AND BENEFITS:

- Incorporates an inert thermal element coating to provide effective isolation from mineral deposits (liming) and galvanic corrosion
- Completely automatic and reseats after temperature or pressure relief
- Ideal for all domestic water heater applications
- Every valve is tested for performance prior to shipping

PERFORMANCE:

Available Set Pressures 150 psi standard*
(75, 100, 125, and 175 psi available for select models; see Rating Table)

*Other pressure settings may be available. Contact Customer Service.

Temperature Relief 210°F (98.9°C) standard
[180°F (82.2°C) available for select models; see Rating Table]

Service Hot Water

APPLICATIONS:

Provides temperature and pressure protection for domestic water heater and storage tanks.

AVAILABLE CONNECTIONS:

Threaded (NPT) Male inlet and female outlet

APPROVALS AND LISTINGS:

CSA Listed to ANSI Z21.22/CSA 4.4; NB listed to ASME Boiler Code Section IV (1/2" sizes are CSA Listed Only).



CSA (ANSI Z21.22/CSA 4.4) & ASME (BOILER CODE SECTION IV) RATINGS

Type	Size (NPS)	CSA Rating (BTU/hr)	ASME Rating at Pressure Setting Indicated				
			75 psig (BTU/hr)	100 psig (BTU/hr)	125 psig (BTU/hr)	150 psig (BTU/hr)	175 psig (BTU/hr)
NCLX-1	1/2"	15,000	-	-	N/R	N/R	-
NCLX-1	3/4"	95,000	300,000	-	500,000	500,000	N/R
NCLX-5	1/2"	15,000	-	-	N/R	N/R	-
NCLX-5	3/4"	105,000(1)	300,000	N/R(2)	500,000	500,000	N/R(2)
NCLX-5L	3/4"	105,000	-	-	-	500,000	-
NCLX-5LX	3/4"	105,000	-	N/R(2)	500,000	500,000	-
NCLX-5S	3/4"	105,000	-	-	-	500,000	-
NCLX-LS	3/4"	105,000	-	-	-	500,000	-
NCLX-A	3/4"	105,000	-	N/R(2)	-	500,000	-
NCLX-8	3/4"	105,000	-	-	500,000	500,000	-

(1) For 3/4" NCLX-5 at 175 psig CSA Rating is 95,000 BTU/hr.

(2) The 100 psig pressure set is only offered with the 180°F temperature relief.

(3) N/R indicates Type is available but Not ASME Rated at the indicated pressure set.

DIMENSIONS (inches)

Type	Size (NPS)	A	B	C	D	E
NCLX-1	1/2	1-3/32	1-9/16	3-3/16	1-3/16	1-7/16
NCLX-1	3/4	1-5/32	1-9/16	3-3/16	1-3/16	1-5/16
NCLX-5	1/2	1-3/32	1-9/16	4-7/8	1-3/16	3-1/8
NCLX-5	3/4	1-5/32	1-9/16	4-7/8	1-3/16	3-1/16
NCLX-5L	3/4	1-5/32	1-9/16	4-7/8	2-3/32	2-1/8
NCLX-5LX	3/4	1-5/32	1-9/16	4-7/8	2-5/16	1-7/8
NCLX-5S	3/4	1-5/32	1-9/16	4-7/8	1-1/2	2-11/16
NCLX-LS	3/4	1-5/32	1-9/16	4-7/8	2-5/8	1-9/16
NCLX-A	3/4	1-5/32	1-9/16	4-7/8	3-5/16	7/8
NCLX-8	3/4	1-5/32	1-9/16	9-3/4	1-3/16	7-7/8

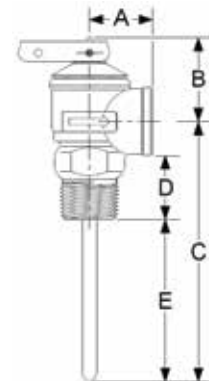



TEMPERATURE & PRESSURE RELIEF VALVES

NCLX CONT.



PRODUCT DESCRIPTION	PART NUMBER
NCLX RESIDENTIAL TEMPERATURE & PRESSURE RELIEF VALVES	
1/2" NCLX-1	16483-0150
3/4" NCLX-1	16487-0150
1/2" NCLX-5, AGA only	15912-0150
3/4" NCLX-5	15836-0150
3/4" NCLX-5L	18821-0150
3/4" NCLX-5LX	19783-0150
3/4" NCLX-5S	21343-0150
3/4" NCLX-LS	19084-0150
3/4" NCLX-8	16372-0150
3/4" NCLX-8 with Extended Shank	24971-0150
3/4" NCLX-A	21714-0150
3/4" NCLX-5 for Water Heaters using PEX Pipe ASME, 180 F Element	22830-0100
3/4" NCLX-5LX for Water Heaters using PEX Pipe ASME, 180 F Element	22831
3/4" NCLX-A for Water Heaters using PEX Pipe ASME, 180 F Element	22832
LEAD FREE NCLX RESIDENTIAL TEMPERATURE & PRESSURE RELIEF VALVES CLAM SHELL PACKAGED	
3/4" NCLX-5	23576-0150
3/4" NCLX-LX	23577-0150
LEAD FREE NCLX RESIDENTIAL TEMPERATURE & PRESSURE RELIEF VALVES	
1/2" NCLX-1	23277-0150
3/4" NCLX-1	23279-0150
1/2" NCLX-5, AGA only	23278-0150
3/4" NCLX-5	23261-0150
3/4" NCLX-5L	23354-0150
3/4" NCLX-5LX	23266-0150
3/4" NCLX-5S	23263-0045
3/4" NCLX-LS	23268-0150
3/4" NCLX-8	23272-0150
3/4" NCLX-A	23270-0150

TEMPERATURE & PRESSURE RELIEF VALVES



FVX/FVMX

COMMERCIAL, RESIDENTIAL

The FVX Series combination temperature and pressure relief valves are designed to offer high capacity protection for domestic and commercial water heating devices. The FVX Series Valves are fully automatic with the valves resetting after either temperature or pressure relief.

The larger FVX Series Valves are well suited for such commercial applications as restaurants, hospitals and laundries.

All FVX Series valves through 1-1/4" have coated thermal elements that protect against mineral build-up. The 1-1/2" and 2" valves have stainless steel elements. The FVX Series Valves are available with male (FVMX) or female (FVX) inlet connections and female only outlet connections.

FEATURES AND BENEFITS:

- Offers high capacity protection for domestic and commercial hot water heating devices
- The valves reseal automatically after either temperature or pressure relief
- The larger series valves are well suited for commercial applications
- Every valve is tested for performance prior to shipping

PERFORMANCE:

Available Set Pressures 75-150 psi
 Temperature Relief 210°F (98.9°C)
 Service Hot water

APPLICATIONS:

Commercial and domestic hot water heating applications.

AVAILABLE CONNECTIONS:

Threaded (NPT) Male or female inlet and female outlet

APPROVALS AND LISTINGS:

CSA Listed to ANSI Z21.22/CSA 4.4; NB Listed to ASME Boiler Code Section IV.



FVX SERIES (FEMALE INLET)						
CSA (ANSI Z21.22/CSA 4.4) & ASME (BOILER CODE SECTION IV) RATINGS						
Type	Inlet Size (NPS)	CSA Rating (BTU/hr)	ASME Rating at Pressure Setting Indicated			
			75 psig (BTU/hr)	100 psig (BTU/hr)	125 psig (BTU/hr)	150 psig (BTU/hr)
FVX-3C	3/4"	185,000	1,034,000	1,327,000	1,619,000	1,912,000
FVX-5C	3/4"	205,000	1,034,000	1,327,000	1,619,000	1,912,000
FVX-8C	3/4"	205,000	1,034,000	1,327,000	1,619,000	1,912,000
FVX-3C	1"	500,000	1,165,000	1,495,000	1,825,000	2,155,000
FVX-5C	1"	500,000	1,165,000	1,495,000	1,825,000	2,155,000
FVX-5L	1"	750,000	1,960,000	2,515,000	3,070,000	3,625,000
FVX-8L	1"	750,000	1,960,000	2,515,000	3,070,000	3,625,000
FVX-4	1-1/2"	1,200,000	3,273,000	4,199,000	5,125,000	6,050,000



TEMPERATURE & PRESSURE RELIEF VALVES

FVX/FVMX CONT.

FVMX SERIES (MALE INLET)						
CSA (ANSI Z21.22/CSA 4.4) & ASME (BOILER CODE SECTION IV) RATINGS						
Type	Inlet Size (NPS)	CSA Rating (BTU/hr)	ASME Rating at Pressure Setting Indicated			
			75 psig (BTU/hr)	100 psig (BTU/hr)	125 psig (BTU/hr)	150 psig (BTU/hr)
FVMX-3C	3/4"	185,000	1,034,000	1,327,000	1,619,000	1,912,000
FVMX-5C	3/4"	205,000	1,034,000	1,327,000	1,619,000	1,912,000
FVMX-8C	3/4"	205,000	1,034,000	1,327,000	1,619,000	1,912,000
FVMX-1LS	3/4"	185,000	1,034,000	1,327,000	1,619,000	1,912,000
FVMX-5LS	3/4"	205,000	1,034,000	1,327,000	1,619,000	1,912,000
FVMX-3C	1"	500,000	1,165,000	1,495,000	1,825,000	2,155,000
FVMX-5C	1"	500,000	1,165,000	1,495,000	1,825,000	2,155,000
FVMX-3LS	1"	500,000	1,165,000	1,495,000	1,825,000	2,155,000
FVMX-4LS	1"	500,000	1,165,000	1,495,000	1,825,000	2,155,000
FVMX-6LS	1"	500,000	1,165,000	1,495,000	1,825,000	2,155,000
FVMX-4L	1-1/4"	750,000	1,960,000	2,515,000	3,070,000	3,625,000
FVMX-3	2"	1,200,000	3,273,000	4,199,000	5,125,000	6,050,000

FVX SERIES (FEMALE INLET)						
Type	Inlet Size (NPS) Female	Outlet Size (NPS) Female	Dimensions (inches)			
			A	B	C	D
FVX-3C	3/4	3/4	1-1/2	3-15/32	5-7/32	3
FVX-5C	3/4	3/4	1-1/2	3-15/32	6-7/8	4-5/8
FVX-8C	3/4	3/4	1-1/2	3-15/32	10-1/8	7-7/8
FVX-3C	1	1	1-9/16	3-15/32	5-7/32	3-3/32
FVX-5C	1	1	1-9/16	3-15/32	6-7/8	4-3/4
FVX-5L	1	1	1-3/4	4-3/8	5-7/8	4-3/4
FVX-8L	1	1	1-3/4	4-3/8	9-1/4	8-5/32
FVX-4	1-1/2	1-1/2	2-1/2	5-7/8	5-7/8	4-3/16

FVMX SERIES (MALE INLET)						
Type	Inlet Size (NPS) Male	Outlet Size (NPS) Female	Dimensions (inches)			
			A	B	C	D
FVMX-3C	3/4	3/4	1-1/2	3-15/32	5-7/32	2-25/32
FVMX-5C	3/4	3/4	1-1/2	3-15/32	6-7/8	4-7/16
FVMX-8C	3/4	3/4	1-1/2	3-15/32	10-1/8	7-11/16
FVMX-1LS	3/4	3/4	1-17/32	3-15/32	5-7/32	1-15/32
FVMX-5LS	3/4	3/4	1-17/32	3-15/32	9-3/32	5-3/8
FVMX-3C	1	1	1-9/16	3-15/32	5-7/32	3-1/8
FVMX-5C	1	1	1-9/16	3-15/32	6-7/8	4-25/32
FVMX-3LS	1	1	1-19/32	3-15/32	6-7/8	3
FVMX-4LS	1	1	1-19/32	3-15/32	6-7/8	4-1/16
FVMX-6LS	1	1	1-19/32	3-15/32	10-1/8	6-1/4
FVMX-4L	1-1/4	1	1-3/4	4-11/32	5-7/8	3-29/32
FVMX-3	2	1-1/2	2-15/32	5-27/32	5-27/32	3-5/16

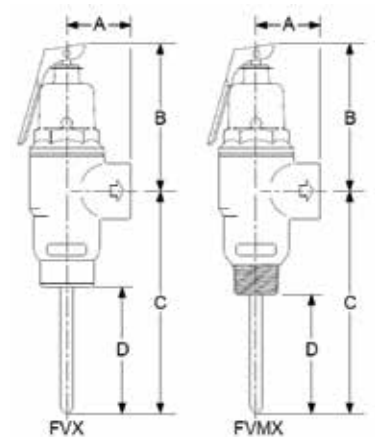

TEMPERATURE & PRESSURE RELIEF VALVES



FVX/FVMX CONT.

PRODUCT DESCRIPTION	PART NUMBER
FVX & FVMX COMMERCIAL TEMPERATURE AND PRESSURE RELIEF VALVES	
3/4" FVX-3C Female Inlet	16930-0150
3/4" FVX-5C Female Inlet	16931-0150
3/4" FVX-8C Female Inlet	16932-0150
3/4" FVMX-3C Male Inlet	16933-0150
3/4" FVMX-5C Male Inlet	16934-0150
3/4" FVMX-5LS Male Inlet	20682-0150
3/4" FVMX-8C Male Inlet	16935-0150
3/4" FVMX-1LS Male Inlet, Long Shank	20113-0150
1" FVX-3C Female Inlet	16936-0150
1" FVX-5C Female Inlet	16937-0150
1" FVX-5L Female Inlet	15638-0150
1" FVX-8L Female Inlet	17354-0150
1" FVMX-3C Male Inlet	16938-0150
1" FVMX-5C Male Inlet	16939-0150
1" FVMX-3LS Male Inlet, Long Shank	19784-0150
1" FVMX-4LS Male Inlet, Long Shank	22894-0150
1-1/4" X 1" FVMX-4L Male Inlet, Long Shank	15672-0150
1-1/2" FVX-4 Female Inlet, Long Shank	16221-0150
2" X 1-1/2" FVMX-3 Male Inlet	16225-0150
LEAD FREE FVX & FVMX COMMERCIAL TEMPERATURE AND PRESSURE RELIEF VALVES	
3/4" FVX-3C Female Inlet	23258-0150
3/4" FVX-5C Female Inlet	23256-0150
3/4" FVX-8C Female Inlet	23355-0150
3/4" FVMX-3C Male Inlet	23274-0150
3/4" FVMX-5C Male Inlet	23255-0150
3/4" FVMX-8C Male Inlet	23275-0150
3/4" FVMX-1LS Male Inlet, Long Shank	23260-0150
1" FVX-3C Female Inlet	23259-0150
1" FVX-5C Female Inlet	23931-0150
1" FVX-5L Female Inlet	23257-0150
1" FVX-8L Female Inlet	23273-0150
1" FVMX-3C Male Inlet	23253-0150
1" FVMX-5C Male Inlet	23276-0150
1-1/4" X 1" FVMX-4L Male Inlet, Long Shank	23934-0150
1-1/2" FVX-4 Female Inlet, Long Shank	23935-0150
2" X 1-1/2" FVMX-3 Male Inlet	23936-0150
2" X 1-1/2" FVMX-3 Male Inlet	23936-0150





TEMPERATURE & PRESSURE RELIEF VALVES

FWL

COMMERCIAL, RESIDENTIAL

The FWL-2 is a pressure only relief valve designed specifically for the protection of hot water supply systems where over-pressure conditions are likely to occur as a result of thermal expansion.

Completely automatic, the FWL-2 reseats after pressure relief. The valve may be installed directly on the tank or in a tee and is appropriate for either side (hot or cold) of the water heater.

The FWL-2 is fitted with a bronze body, brass and stainless steel internal parts, a silicone seat disc and a stainless steel pressure spring. The FWL-2 is compact and economical. The factory relief settings for 1/2" and 3/4" sizes are 75, 125 or 150 psi.

FEATURES AND BENEFITS:

- Specifically for the protection of hot water supply systems
- Offers protection from over-pressure conditions that are likely to occur as a result of thermal expansion
- Compact and economical
- Every valve is tested for performance prior to shipping

PERFORMANCE:

Available Set pressures 150 psi (75 and 125 psi available)
Service Water

APPLICATIONS:

Commercial and domestic hot water heating applications.

AVAILABLE CONNECTIONS:

Threaded (NPT) Male inlet and female outlet

APPROVALS AND LISTINGS:

CSA Listed to ANSI Z21.22/CSA 4.4; NB listed to ASME Boiler Code Section IV (FWOL are not Listed; 1/2" sizes are CSA Listed only).



CSA (ANSI Z21.22/CSA 4.4) & ASME (BOILER CODE SECTION IV) RATINGS

Type	Size (NPS)	ASME Rating at Pressure Setting Indicated			
		CSA Rating (BTU/hr)	75 psig (BTU/hr)	125 psig (BTU/hr)	150 psig (BTU/hr)
FWL-2	1/2"	15,000 (1)	N/R (1)	N/R	N/R
FWL-2	3/4"	200,000 (1)	N/R (1)	500,000	500,000

(1) The 1/2" and 3/4" FWL-2 at 75 psig are not CSA or ASME rated.

(2) N/R indicates Type is available but Not ASME Rated at the indicated pressure set.

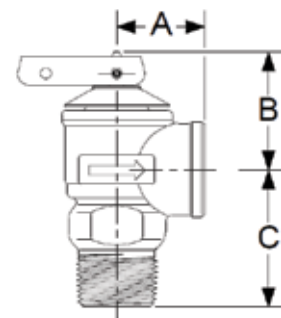

Type	Size (NPS)	DIMENSIONS (inches)		
		A	B	C
FWL-2	1/2"	1-3/32	1-9/16	1-25/32
FWL-2	3/4"	1-5/32	1-9/16	1-25/32

PRODUCT DESCRIPTION	PART NUMBER
FWL-2 PRESSURE RELIEF VALVES	
1/2" FWL-2 Pressure only	14721-0150
3/4" FWL-2 Pressure only, AGA & ASME	14737-0150
LEAD FREE FWL-2 PRESSURE RELIEF VALVES	
3/4" FWL-2 Pressure only, AGA & ASME Lead Free	23343-0150
FWOL PRESSURE ONLY RELIEF VALVES WITHOUT LIFT LEVER	
3/4" Pressure only, Male Inlet / Female Outlet without Lift Lever	22834-0125
3/4" Pressure only, Male Inlet / Female Outlet without Lift Lever	22835-0100
3/4" Pressure only, Male Inlet / Female Outlet without Lift Lever	22836-0075
1/2" Pressure only, Male Inlet / Female Outlet without Lift Lever	22862-0125
1/2" Pressure only, Male Inlet / Female Outlet without Lift Lever	22863-0100
1/2" Pressure only, Male Inlet / Female Outlet without Lift Lever	22864-0075

TEMPERATURE & PRESSURE RELIEF VALVES



F-30

COMMERCIAL

The F-30 is a compact and economical ASME Safety Relief Valve for use on hot water space heating boilers, water supply heaters, and storage tanks. It features an all brass body, brass internal parts, a silicone seat disc and a stainless steel pressure spring.

The F-30 Relief Valve is designed for use on hot water service only and is not to be used on steam.

The F-30 is available in 3/4" size only. The standard factory pressure relief setting is 30 psi.

FEATURES AND BENEFITS:

- Compact and economical
- Every valve is tested for performance prior to shipping

PERFORMANCE:

Set pressure 30 psi
Service Water

APPLICATIONS:

Commercial hot water space heating boilers, water supply heaters, and storage tanks.

AVAILABLE CONNECTIONS:

Threaded 3/4" male or female inlet and female outlet

APPROVALS AND LISTINGS:

NB Listed to ASME Boiler Code Section IV with a relief capacity of 510,000 BTU/hr.



Type	Size (NPS)	DIMENSIONS (inches)		
		A	B	C
F-30	3/4	1-5/32	1-9/16	1-25/32
F-30 FIP X FIP	3/4	1-5/32	1-9/16	1-25/32

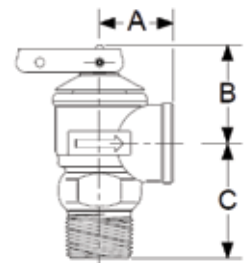

PRODUCT DESCRIPTION	PART NUMBER
F-30 ASME PRESSURE RELIEF VALVES	
3/4" F-30 set at 30 psi	20166-0030
3/4" F-30 FIP X FIP set at 30 psi	22887-0030
LEAD FREE F-30 ASME PRESSURE RELIEF VALVES	
3/4" F-30 set at 30 psi	23344-0030

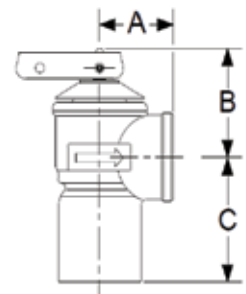



TEMPERATURE & PRESSURE RELIEF VALVES

F-82

COMMERCIAL

The F-82 is a pressure-only ASME relief valve designed for use on hot water space heating boilers, water supply heaters and storage tanks.

The F-82 Safety Relief Valves are designed for use on hot water service only and are not to be used on steam.

The F-82 has a female inlet and outlet. The F-82 ASME Safety Relief Valve has a factory pressure relief setting from 30 to 150 psi. These high capacity pressure-only relief valves feature bronze bodies, silicone seat discs and stainless steel pressure springs.

FEATURES AND BENEFITS:

- Compact and economical
- The valves reseal automatically after pressure relief
- Ideal for most domestic water heater applications
- Rated for emergency steam discharge by the National Board of Boiler and Pressure Vessel Inspectors
- Every valve is tested for performance prior to shipping

PERFORMANCE:

Available Set pressures 30-150 psi
Service Water

APPLICATIONS:

Commercial hot water space heating boilers, water supply heaters, and storage tanks.

AVAILABLE CONNECTIONS:

Threaded (NPT) Female inlet and female outlet*

*Male inlet also available on 3/4" size

APPROVALS AND LISTINGS:

NB Listed to ASME Boiler Code Section IV.



ASME RELIEF CAPACITIES AT STANDARD SETTINGS - BTU/HR STEAM RELIEF

RELIEF SETTING	F-82 3/4" x 3/4"	F-82 1" x 1"	F-82 1-1/4" x 1-1/4"	F-82 1-1/2" x 1-1/2"	F-82 2" x 2"
30 psi	717,000	1,025,000	1,704,000	2,085,000	3,902,000
50 psi	1,048,000	1,498,000	2,490,000	3,047,000	5,701,000
75 psi	1,462,000	2,090,000	3,472,000	4,249,000	7,951,000
100 psi	1,875,000	2,680,000	4,454,000	5,451,000	10,200,000
125 psi	2,289,000	3,271,000	5,437,000	6,653,000	12,450,000
150 psi	2,703,000	3,862,000	6,419,000	7,855,000	14,699,000

Inlet Size (NPS) Female	Outlet Size (NPS) Female	DIMENSIONS (inches)		
		A	B	C
3/4	3/4	1-1/2	3-1/2	1-11/16
1	1	1-3/4	4-11/32	1-7/64
1-1/4	1-1/4	2-1/16	5-9/16	1-1/2
1-1/2	1-1/2	2-15/32	5-7/8	1-21/32
2	2	3	7-1/2	2-5/32

Inlet Size (NPS) Male	Outlet Size (NPS) Female	DIMENSIONS (inches)		
		A	B	C
3/4	3/4	1-1/2	3-1/2	1-17/32

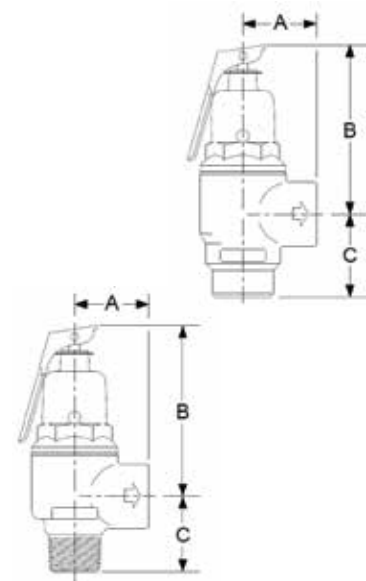

TEMPERATURE & PRESSURE RELIEF VALVES



PRODUCT DESCRIPTION	PART NUMBER
F-82 ASME PRESSURE RELIEF VALVES	
3/4" F-82 Bronze body with lever set at 30 psi	13570-0030
3/4" F-82 Bronze body with lever set at 50 psi	13570-0050
3/4" F-82 Bronze body with lever set at 75 psi	13570-0075
3/4" F-82 Bronze body with lever set at 100 psi	13570-0100
3/4" F-82 Bronze body with lever set at 125 psi	13570-0125
3/4" F-82 Bronze body with lever set at 150 psi	13570-0150
1" F-82 Bronze body with lever set at 30 psi	15673-0030
1" F-82 Bronze body with lever set at 50 psi	15673-0050
1" F-82 Bronze body with lever set at 75 psi	15673-0075
1" F-82 Bronze body with lever set at 100 psi	15673-0100
1" F-82 Bronze body with lever set at 125 psi	15673-0125
1" F-82 Bronze body with lever set at 150 psi	15673-0150
1-1/4" F-82 Bronze body with lever set at 50 psi	16174-0050
1-1/4" F-82 Bronze body with lever set at 100 psi	16174-0100
1-1/4" F-82 Bronze body with lever set at 150 psi	16174-0150
1-1/2" F-82 Bronze body with lever set at 50 psi	16189-0050
1-1/2" F-82 Bronze body with lever set at 100 psi	16189-0100
1-1/2" F-82 Bronze body with lever set at 150 psi	16189-0150
2" F-82 Bronze body with lever set at 50 psi	16204-0050
2" F-82 Bronze body with lever set at 100 psi	16204-0100
2" F-82 Bronze body with lever set at 150 psi	16204-0150
LEAD FREE F-82 ASME PRESSURE RELIEF VALVES	
3/4" F-82 Bronze body with lever set at 30 psi	23341-0030
3/4" F-82 Bronze body with lever set at 50 psi	23341-0050
3/4" F-82 Bronze body with lever set at 75 psi	23341-0075
3/4" F-82 Bronze body with lever set at 100 psi	23341-0100
3/4" F-82 Bronze body with lever set at 125 psi	23341-0125
3/4" F-82 Bronze body with lever set at 150 psi	23341-0150
1" F-82 Bronze body with lever set at 30 psi	23356-0030
1" F-82 Bronze body with lever set at 50 psi	23356-0050
1" F-82 Bronze body with lever set at 75 psi	23356-0075
1" F-82 Bronze body with lever set at 100 psi	23356-0100
1" F-82 Bronze body with lever set at 125 psi	23356-0125
1" F-82 Bronze body with lever set at 150 psi	23356-0150
1-1/4" F-82 Bronze body with lever set at 50 psi	23937-0050
1-1/4" F-82 Bronze body with lever set at 100 psi	23937-0100
1-1/4" F-82 Bronze body with lever set at 150 psi	23937-0150
1-1/2" F-82 Bronze body with lever set at 50 psi	23938-0050
1-1/2" F-82 Bronze body with lever set at 100 psi	23938-0100
1-1/2" F-82 Bronze body with lever set at 150 psi	23938-0150
2" F-82 Bronze body with lever set at 50 psi	23939-0050
2" F-82 Bronze body with lever set at 100 psi	23939-0100
2" F-82 Bronze body with lever set at 150 psi	23939-0150





TEMPERATURE & PRESSURE RELIEF VALVES

F-95

COMMERCIAL

The F-95 Expanded Outlet Pressure Relief Valve offers a complete package of expanded boiler ASME safety relief valves in sizes ranging from 3/4" x 1" through 2" x 2-1/2". The F-95 features an iron body construction, brass seat, silicone seat disc and EP diaphragms for high temperature applications. It also incorporates a pop-type action. The F-95 Valves are available with relief settings from 30 to 75 psi.

FEATURES AND BENEFITS:

- Offers a complete package of expanded boiler safety relief valves in a range of sizes
- Provides pressure protection for nearly all commercial/industrial OEM boilers and hot water heating system applications
- Higher Capacity: Handles more volume with just one relief valve
- Every valve is tested for performance prior to shipping

PERFORMANCE:

Available Set pressures 30-75 psi
Service Water

APPLICATIONS:

Provides pressure protection for nearly all types of commercial and industrial OEM boilers and water heating system applications.

AVAILABLE CONNECTIONS:

Threaded (NPT) Female inlet and female outlet

APPROVALS AND LISTINGS:

NB Listed to ASME Boiler Code Section IV.



ASME RATED HOT WATER SAFETY RELIEF VALVE (BTU/HR)					
Set Pressure (psi)	3/4" x 1"	1" x 1-1/4"	1-1/4" x 1-1/2"	1-1/2" x 2"	2" x 2-1/2"
30	952,000	1,337,000	2,090,000	3,010,000	5,351,000
45	1,281,000	1,800,000	2,813,000	4,051,000	7,202,000
60	1,611,000	2,262,000	3,536,000	5,092,000	9,053,000
75	1,940,000	2,725,000	4,259,000	6,133,000	10,904,000

Inlet Size (NPS) Female	Outlet Size (NPS) Female	DIMENSIONS (inches)		
		A	B	C
3/4	1	1-13/16	2-13/32	5-1/2
1	1-1/4	2-1/16	2-3/8	6-13/32
1-1/4	1-1/2	2-3/8	3-3/32	9-9/16
1-1/2	2	2-5/8	3-7/8	10-3/32
2	2-1/2	3-7/16	3-1/2	12-13/16

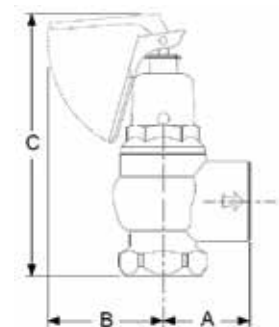

PRODUCT DESCRIPTION	PART NUMBER
F-95 ASME PRESSURE RELIEF VALVES	
3/4" X 1" F-95 Iron body with lever set at 30 psi	19497-0030
3/4" X 1" F-95 Iron body with lever set at 50 psi	19497-0050
3/4" X 1" F-95 Iron body with lever set at 75 psi	19497-0075
1" X 1-1/4" F-95 Iron body with lever set at 30 psi	19499-0030
1" X 1-1/4" F-95 Iron body with lever set at 50 psi	19499-0050
1" X 1-1/4" F-95 Iron body with lever set at 75 psi	19499-0075
1-1/4" X 1-1/2" F-95 Iron body with lever set at 30 psi	19501-0030
1-1/4" X 1-1/2" F-95 Iron body with lever set at 50 psi	19501-0050
1-1/4" X 1-1/2" F-95 Iron body with lever set at 75 psi	19501-0075
1-1/2" X 2" F-95 Iron body with lever set at 30 psi	19503-0030
1-1/2" X 2" F-95 Iron body with lever set at 50 psi	19503-0050
1-1/2" X 2" F-95 Iron body with lever set at 75 psi	19503-0075
2" X 2-1/2" F-95 Iron body with lever set at 30 psi	19505-0030
2" X 2-1/2" F-95 Iron body with lever set at 50 psi	19505-0050
2" X 2-1/2" F-95 Iron body with lever set at 75 psi	19505-0075

TEMPERATURE & PRESSURE RELIEF VALVES



F, FW & FWC

COMMERCIAL, INDUSTRIAL

The FW and FWC Valves are small, low-cost relief valves suitable for static over-pressure protection. Type FWC incorporates a calibrated adjusting screw for occasional changes in pressure setting without the use of a pressure gauge. Bronze bodies with male inlet and female outlet, silicone seats and stainless steel spring.

FEATURES AND BENEFITS:

- Offers protection against problematic and over-pressure conditions:
 - thermal expansion protection
 - static pressure and over-pressure relief
 - very low capacity pump relief
 - other uses of similar nature where tight shut-off is required
- Designed to meet the needs of a wide variety of water systems in commercial and industrial applications
- Every valve is tested for performance prior to shipping

PERFORMANCE:

Set pressure range 15–200 psi (Type FW) and
 25–175 psi (Type FWC) factory set at 125 psi

Maximum temperature 210°F (98.9°C)

Service Water

APPLICATIONS:

For commercial and industrial applications including thermal expansion protection, static pressure and over-pressure relief, low capacity pump relief and other uses of similar nature where tight shut-off is required. Valves are non-code.

AVAILABLE CONNECTIONS:

Threaded (NPT) Male inlet and female outlet



DIMENSIONS (inches)	A	B	C
FW - 1/2	1-3/16	1-11/32	1-1/2
FW - 3/4	1-3/16	1-11/32	1-1/2
FWC - 1/2	1-3/16	2-5/8	1-1/2
FWC - 3/4	1-1/4	2-5/8	1-1/2

PRODUCT DESCRIPTION	PART NUMBER
F & FW SERIES RELIEF VALVES	
1/2" F Pressure only, Male Inlet / Female Outlet (25–200 psi)	07420–0150
1/2" X 3/8" FP Pressure only, Male Inlet / 3/8" Female Outlet (25–200 psi)	07410–0150
1/2" FW Pressure only (15–200 psi)	09553–0125
3/4" FW Pressure only (15–200 psi)	09554–0125
LEAD FREE FWC ADJUSTABLE PRESSURE RELIEF VALVES	
1/2" Pressure only	09563–0125LF
3/4" Pressure only	09564–0125LF

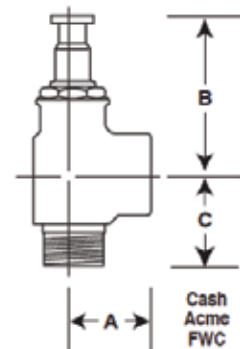
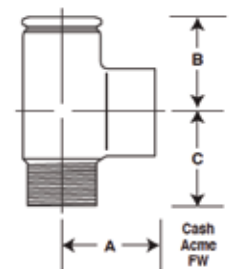



TEMPERATURE & PRESSURE RELIEF VALVES

VR-801

COMMERCIAL

The VR-801 Vacuum Relief Valve is designed to protect hot water supply systems and pressure vessels against negative pressure. It is especially well suited for many domestic and commercial systems.

It works by preventing internal vacuum conditions that could result in burned out heaters and/or collapsed storage tanks. Installed on the cold water supply line, the Cash Acme VR-801 closes tightly under pressure and opens at a 1" mercury vacuum. Atmosphere admitted to the system breaks the vacuum, preventing collapse of the storage tank.

FEATURES AND BENEFITS:

- Prevents internal vacuum conditions
- Guards against siphonage, burnt-out heaters and collapsing of storage tanks and negative pressure
- Opens quickly in emergency situations on a one inch mercury vacuum
- Every valve is tested for performance prior to shipping

PERFORMANCE:

Relief pressure (open)	1" Hg vacuum
Capacity	13 SCFM (@ 2" Hg)
Maximum temperature	210°F (98.9°C)
Maximum inlet pressure	200 psi
Service	Water

APPLICATIONS:

For protection of commercial hot water supply systems and pressure vessels against negative pressure.

AVAILABLE CONNECTIONS:

Threaded (NPT) 1/2" and 3/4"

APPROVALS AND LISTINGS:

ANSI Z21.22/CSA 4.4. Listed by CSA.

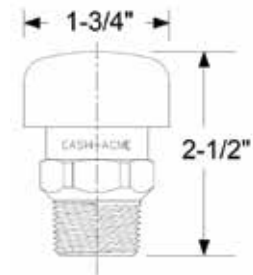

PRODUCT DESCRIPTION	PART NUMBER
LEAD FREE VR-801 VACUUM RELIEF VALVES	
1/2" Drilled vent, w/dust cover	22397-0000LF
3/4" Drilled vent, w/dust cover	22398-0000LF



BACKFLOW PREVENTERS

Cash Acme Backflow Preventers provide the protection you need to ensure your water supply is safe in case of negative or decreased water pressure. In the event of backpressure or backsiphonage, our backflow prevention devices help halt the reversal of water and decrease the chances of contamination.

Our backflow preventer selection includes hose bibb vacuum breakers, atmospheric vacuum breakers, dual check valves and vented dual check valves. Each backflow preventer is tested for efficiency and performance before leaving our Cullman, Alabama factory. This commitment to quality has made us one of the most trusted names in the industry.

Local or state government typically enforces backflow prevention. Consult your local jurisdiction on backflow prevention requirements and approved devices.



BACKFLOW PREVENTERS

V-3 VACUUM BREAKER

COMMERCIAL, RESIDENTIAL

The V-3 Vacuum Breaker prevents dangerous back-siphonage and backflow into a potable water supply. The V-3 features all-brass construction with threaded connections, a neoprene seat disc, rubber washer, and steel set screw. The V-3 is equipped with a protruding tip device for manual draining of a faucet (after hose removal), which prevents freezing. Maximum pressure is 125 psi; maximum temperature is 180°F (82.2°C). The V-3 is also available in a chrome-plated version (V-3C).

Note: These units are not intended for use where water contamination could occur as a result of draining or for permanent continuous pressure installation. For continuous pressure systems, install the BFP Backflow Preventer Valve.

FEATURES AND BENEFITS:

- Designed for any place involving moveable hoses attached to threaded faucets
- The V-3 is equipped with a protruding "tip" device for manual draining of a faucet (after hose removal), which prevents freezing
- Polished chrome plating designs are also available

PERFORMANCE:

Maximum temperature	180°F (82.2°C)
Maximum pressure	125 psi
Service	Water

APPLICATIONS:

For use around homes, schools, commercial buildings, laboratories, or any place involving removable hoses attached to threaded faucets, indoors or out.

AVAILABLE CONNECTIONS:

Threaded (NH) 3/4"

APPROVALS AND LISTINGS:

ASSE 1011 and CSA B64.2. Listed by ASSE, CSA and IAPMO.

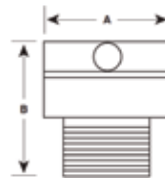

DIMENSIONS (inches)	A	B
3/4	1-6/16	1-6/16

PRODUCT DESCRIPTION	PART NUMBER
V-3 VACUUM BREAKERS HOSE BIBB TYPE	
3/4" V-3 Vacuum Breaker, Hose Bibb type with Locking Screw	17148-0000
3/4" V-3C, Vacuum Breaker, Hose Bibb Type, Chrome Plated	17195-0000
V-3 LEAD FREE VACUUM BREAKERS HOSE BIBB TYPE	
3/4" V-3, Vacuum Breaker, Hose Bibb type with Locking Screw	17148-0000LF
3/4" V-3C, Vacuum Breaker, Hose Bibb type, Chrome Plated	17195-0000LF

Product not available in Canada.



VB-222 VACUUM BREAKER

COMMERCIAL, RESIDENTIAL

The VB-222 vacuum breaker valve is designed to prevent dangerous back-siphonage and backflow into a potable water supply system. It automatically self-drains when all attachments are removed completely from the valve's outlet which protects the valve and faucet from freezing and rupturing in cold weather. The valve is constructed with a brass body and adapter, Buna O-ring and seats, steel set screw, stainless steel springs, and the highest quality molded parts.

Note: These units are not intended for use where water contamination could occur as a result of draining or for permanent continuous pressure installation. For continuous pressure systems, install the BFP Backflow Preventer Valve.

FEATURES AND BENEFITS:

- Prevents dangerous back-siphonage
- Automatically drains when attachments are removed from the valve's outlet
- Freeze proof self-draining hose protects the valve and faucet from freezing and rupturing in cold weather

PERFORMANCE:

Maximum temperature 180°F (82.2°C)
 Maximum pressure 125 psi
 Service Water

APPLICATIONS:

For use around homes, schools, commercial buildings, laboratories or any application involving a removable hose attached to threaded faucets.

AVAILABLE CONNECTIONS:

Threaded (NH) 3/4"

APPROVALS AND LISTINGS:

ASSE 1011 and CSA B64.2. Listed by ASSE, CSA and IAPMO.

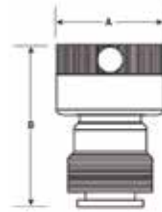

DIMENSIONS (inches)	A	B
3/4	1-5/16	2

PRODUCT DESCRIPTION	PART NUMBER
VB-222 VACUUM BREAKERS	
3/4" VB-222, Vacuum Breaker, Self Draining with Locking Screw	19600-0000
3/4" VB-222C, Chrome Plated Vacuum Breaker, Self Draining with Locking Screw	21896-0000
VB-222 LEAD FREE VACUUM BREAKERS	
3/4" VB-222, Vacuum Breaker, Self Draining with Locking Screw	19600-0000LF
3/4" VB-222C, Chrome Plated Vacuum Breaker, Self Draining with Locking Screw	21896-0000LF

Product not available in Canada.



BACKFLOW PREVENTERS

V-101 ANTI-SIPHON VACUUM BREAKER

COMMERCIAL, RESIDENTIAL

The V-101 anti-siphon vacuum breaker is constructed with female connections, a bronze body, and a silicone seat. It is designed for a maximum intermittent water pressure of 125 psi, and is suitable for temperatures up to 212°F (100°C). A polished chrome model is also available.

Note: Not for continuous pressure use.

FEATURES AND BENEFITS:

- Prevents polluted water from being siphoned into the potable water supply
- Required for open tanks, basins, sprinkler systems and dishwashers
- Equipped with a lighter than water poppet assembly that applies maximum buoyancy, prevents sticking and keeps spillage to an absolute minimum
- Available in lead free and non-potable applications

PERFORMANCE:

Maximum temperature	212°F (100°C)
Maximum inlet pressure	125 psi (Intermittent)
Service	Potable water

APPLICATIONS:

Recommended applications include: open tanks or basins filled by a hose below the water line, in appliances where water enters below the overflow rim, in lawn sprinkling systems, or medical, surgical and therapeutic facilities.

AVAILABLE CONNECTIONS:

Threaded (NPT) 1/2", 3/4" and 1"

APPROVALS AND LISTINGS:

ASSE 1001. Listed by ASSE and IAPMO.

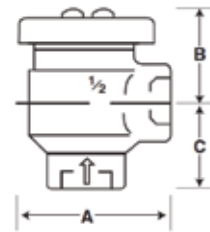

DIMENSIONS (inches)	A	B	C
V-101 & V-101C - 1/2	2-1/8	1-5/16	1-5/16
V-101 & V-101C - 3/4	2-9/16	1-1/2	1-1/2
V-101 & V-101C - 1	2-15/16	1-11/16	1-11/16

PRODUCT DESCRIPTION	PART NUMBER
V-101 NON-POTABLE ANTI-SIPHON VACUUM BREAKERS	
1/2" V-101, Anti-Siphon, Brass	17383-0000
3/4" V-101, Anti-siphon, Brass	17384-0000
V-101 LEAD FREE ANTI-SIPHON VACUUM BREAKERS	
1/2" V-101, Anti-Siphon, Brass	17383-0000LF
3/4" V-101, Anti-siphon, Brass	17384-0000LF
1" V-101, Anti-Siphon, Brass	17385-0000LF
1/2" V-101C, Anti-Siphon, Chrome	17389-0000LF
3/4" V-101C, Anti-Siphon, Chrome	17390-0000LF

Product not available in Canada.



BF DUAL CHECK VALVE

COMMERCIAL, RESIDENTIAL

The Cash Acme BF series dual check valve prevents polluted water from entering the potable water supply system by preventing the reverse flow of water into supply lines, and is constructed of a cast bronze body and brass union inlet connection. The Cash Acme BF-1 is available in 3/4" and 1" sizes and incorporates a female threaded union inlet and a female threaded outlet. The Cash Acme BF-5 is available as a 1" meter threaded (swivel) inlet and 3/4" FNPT (union).

FEATURES AND BENEFITS:

- Prevents polluted water from entering the potable water supply system
- Prevents the reverse flow of water into supply lines
- Straight through design to minimize pressure drop
- May be installed horizontally or vertically
- Available in lead free applications

PERFORMANCE:

Maximum temperature	140°F (60°C)
Maximum pressure	175 psi
Service	Water

APPLICATIONS:

Intended for use with continuous or intermittent applications on water supply lines.

AVAILABLE CONNECTIONS:

Brass union inlet connection	3/4" and 1" FNPT
Swivel connections	1" meter NPSH

APPROVALS AND LISTINGS:

ASSE 1024 and CSA B64.6. Listed by ASSE and CSA.



BF SERIES TYPICAL FLOW LOSS		
Size	Flow (gpm)	Pressure Loss (psi)
All Sizes	3	4.3
	6	5.0
	9	5.8
	12	6.7
	18	8.0

BF-1	
DIMENSIONS (inches)	A
3/4 FNPT	4-3/8
1 FNPT	4-3/8

BF-5	
DIMENSIONS (inches)	A
1" Meter x 3/4" FNPT Union	5-3/16

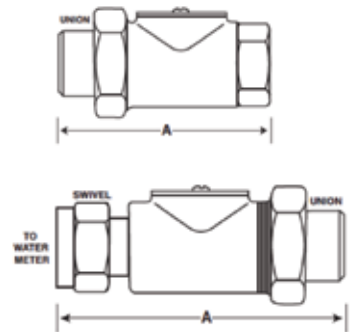

PRODUCT DESCRIPTION	PART NUMBER
BF SERIES - LEAD FREE DUAL CHECK BACKFLOW PREVENTER	
3/4" BF1, Dual Check, Threaded Union Inlet	17217-0000LF
1" BF1, Dual Check, Threaded Union Inlet	17218-0000LF
1" X 3/4" BF5, Dual Check, Meter Swivel Nut Union Inlet	22343-0000LF
BF SERIES - NON-POTABLE DUAL CHECK BACKFLOW PREVENTER	
3/4" BF1, Dual Check, Threaded Union Inlet	17217-0000
1" BF1, Dual Check, Threaded Union Inlet	17218-0000

Product not available in Canada.



BACKFLOW PREVENTERS

BFP DUAL CHECK VALVE

RESIDENTIAL, COMMERCIAL

The BFP series dual check valve prevents backflow of contaminated water into potable water supply lines. It is constructed of a brass body with two spring loaded poppet-type valve modules, an internal strainer screen, stainless steel springs and features threaded female union inlet and outlet connections. Suitable for hot [up to 180°F (82.2°C)] or cold water under continuous pressure.

FEATURES AND BENEFITS:

- Prevents polluted water from entering the potable water supply system
- Prevents the reverse flow of water into supply lines
- Internal plastic parts and high temperature elastomer seals resist corrosion
- Designed for use at cross-connections
- Perfect for boiler feed lines, dairy processing, chlorinators, livestock drinking fountains and numerous other similar applications
- Lead free for domestic water supply

PERFORMANCE:

Maximum temperature	180° F (82.2°C)
Maximum inlet pressure	170 psi
Service	Water

APPLICATIONS:

Intended for use with boiler feed lines, dairy processing systems, livestock water sources, chlorinators, trap primers and similar installations.

AVAILABLE CONNECTIONS:

Threaded (NPT) 1/2" and 3/4"

APPROVALS AND LISTINGS:

ASSE 1012. Listed by ASSE.

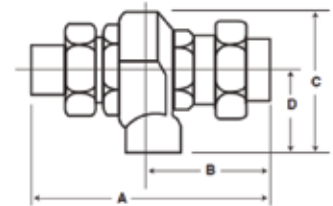

DIMENSIONS (inches)	A	B	C	D
1/2	5-3/32	2-7/16	1-25/32	2-63/64
3/4	5-5/32	2-17/32	1-25/32	2-63/64

PRODUCT DESCRIPTION	PART NUMBER
BFP SERIES - LEAD FREE CONTINUOUS TYPE BACKFLOW PREVENTER WITH ATMOSPHERIC VENT	
1/2" BFP, Continuous Type, Female Union Inlet & Outlet	21574-0000LF
3/4" BFP, Continuous Type, Female Union Inlet & Outlet	21575-0000LF
1/2" BFP, Continuous Type, Copper Sweat Union Inlet & Outlet	22760-0000LF
3/4" BFP, Continuous Type, Copper Sweat Union Inlet & Outlet Lead Free	22762-0000LF

Product not available in Canada.

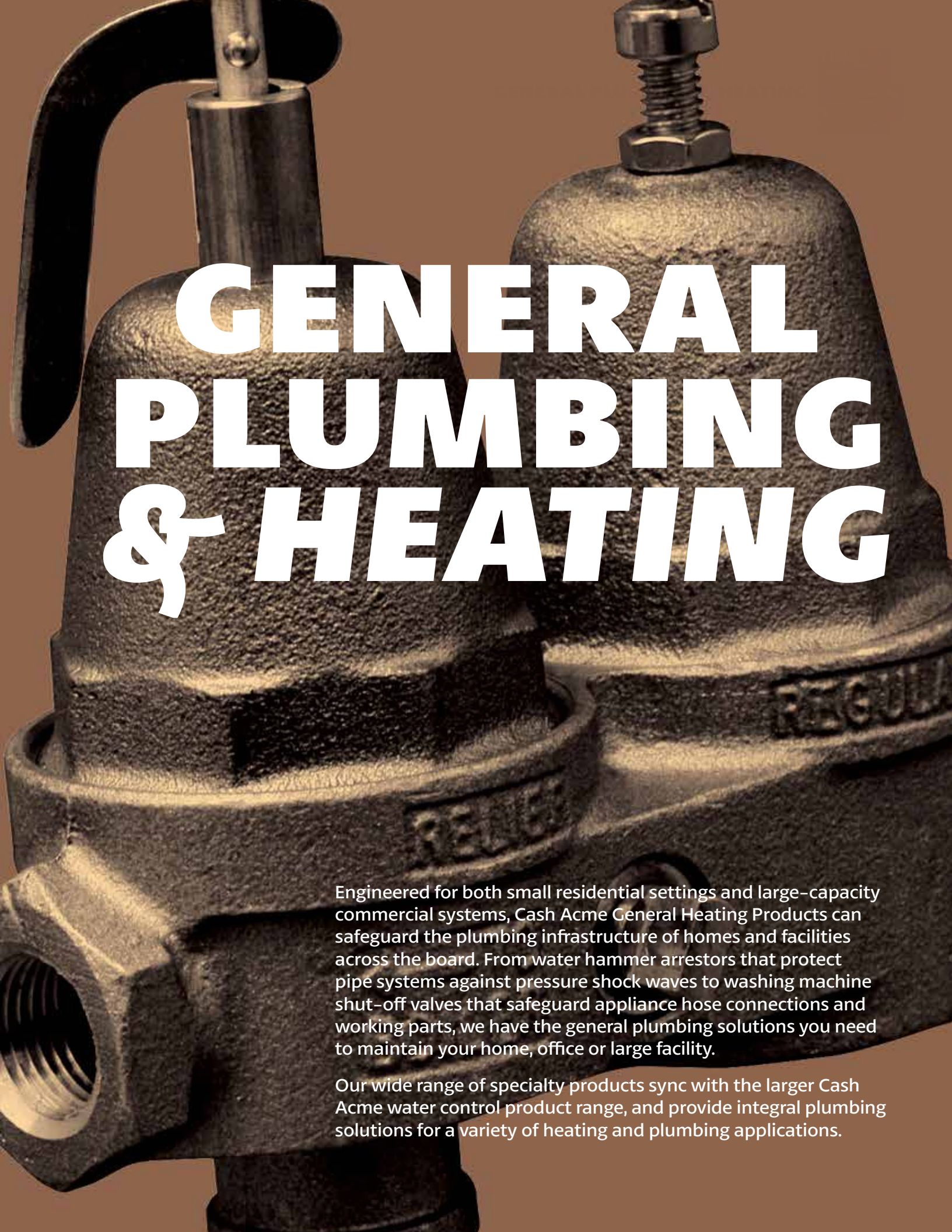

GENERAL PLUMBING & HEATING

Engineered for both small residential settings and large-capacity commercial systems, Cash Acme General Heating Products can safeguard the plumbing infrastructure of homes and facilities across the board. From water hammer arrestors that protect pipe systems against pressure shock waves to washing machine shut-off valves that safeguard appliance hose connections and working parts, we have the general plumbing solutions you need to maintain your home, office or large facility.

Our wide range of specialty products sync with the larger Cash Acme water control product range, and provide integral plumbing solutions for a variety of heating and plumbing applications.



GENERAL PLUMBING & HEATING

WASHING MACHINE SHUT-OFF VALVE

COMMERCIAL, RESIDENTIAL

Single-lever control of both hot and cold water to protect a washing machine's hose and inner working parts. E-Z on/off ball-type design can also be used to throttle water flow and ease the water hammer shock caused by solenoid valves. Bronze construction. Equipped with fluoropolymer seats against brass thru-hole balls that provide quiet rotating action. The WM-1 is supplied with male adapters. The WM-2 is furnished with sweat copper elbow adapters (2-3/8" on centers), which may be installed either up or down.

FEATURES AND BENEFITS:

- Convenient single lever control makes it easy to use and encourages shut-off of the water supply
- Economical and easy to install

PERFORMANCE:

Maximum temperature 180°F (82.2°C)
 Maximum pressure 80 psi
 Service Water

APPLICATIONS:

Designed for control of both hot and cold water supply to a washing machine.

AVAILABLE CONNECTIONS:

Threaded (NPT) 1/2" NPT and 3/4" Hose

APPROVALS AND LISTINGS:

ASSE 1012 and CSA B.64. Listed by ASSE and CSA.

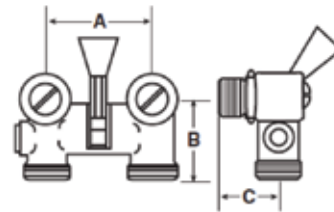

DIMENSIONS (inches)	A	B	C
WM-1	2-3/8	1-7/8	1-3/8
WM-2			1-1/8

PRODUCT DESCRIPTION	PART NUMBER
WASHING MACHINE SHUT-OFF VALVES	
1/2" WM-1 Male Threaded (Non-Potable)	16962-0000
1/2" WM-2 Copper Sweat (Non-Potable)	17087-0000



A-41 AND AB-40

COMMERCIAL

The A-41 series pressure reducing boiler feed valve provides increased capacity for larger boilers. It has threaded female connections and an iron body with a polymer seat. The AB-40 series pressure reducing boiler feed valve features a brass body and a combo connection which allows either a threaded or sweat copper connection with the same union tail piece. The AB-40 also includes a check valve and provides an inbuilt bypass for rapid filling, high pressure testing and system purging. Both the AB-40 and A-41 have a heat resistant diaphragm and seat disc, and an inbuilt strainer screen. The reduced pressure setting is 14 psi. The maximum inlet working pressure is 200 psi.

Note: For backflow prevention of boiler water into the potable water supply line, install a BFP dual check valve.

FEATURES AND BENEFITS:

- Economical and easy to install
- Every valve is tested for performance prior to shipping
- Tri-purpose inbuilt by-pass for rapid filling of the boiler
- "Combo-Connection" union inlet provides convenience to the installer by permitting threaded or sweat copper connection with the same union tailpiece

A-41 PERFORMANCE:

Outlet Pressure Range 10-20 psi (factory set 14 psi)
 Maximum inlet pressure 200 psi
 Service Water

AB-40 PERFORMANCE:

Outlet Pressure Range 2-30 psi (factory set 14 psi)
 Maximum Inlet Pressure 200 psi
 Service Cold water

APPLICATIONS:

Larger hot water space heating boilers that require faster filling.

AVAILABLE CONNECTIONS:

Threaded (NPT) A-41 3/4" Female threaded
 Threaded (NPT) AB-40 1/2" Female

APPROVALS AND LISTINGS:

ASSE 1012 and CSA B.64. Listed by ASSE and CSA.



PRODUCT DESCRIPTION	PART NUMBER
NON-POTABLE A SERIES BOILER FEED VALVES	
3/4" A-41 Boiler Feed Valves	23099-0012
1/2" AB-40 Combo Union, In-Built Bypass	12214-0014

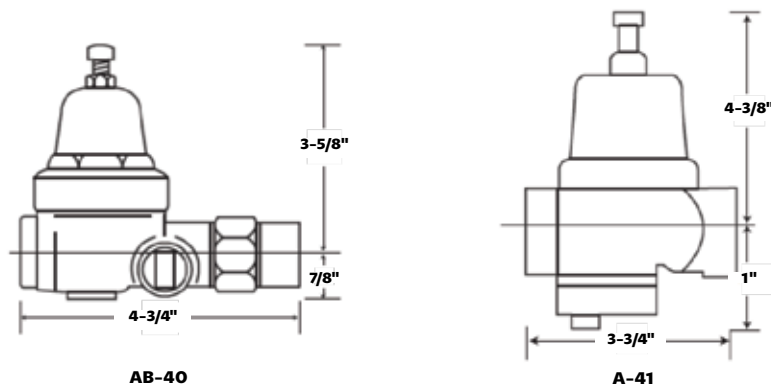



GENERAL PLUMBING & HEATING

A-89

RESIDENTIAL, COMMERCIAL

The A-89 series pressure reducing boiler feed valve is the only anti-scaling boiler feed valve in the industry and features rapid fill capability and also includes a balanced piston for closer outlet control regardless of variations in inlet pressure. Standard reduced pressure setting is 14 psi with an adjustment range to 30 psi. Maximum inlet working pressure is 200 psi. Available with threaded connection or sweat copper union inlet.

FEATURES AND BENEFITS:

- Contains a polymer seat to prevent scaling
- Economical and easy to install
- Every valve is tested for performance prior to shipping
- Modular cartridge design reduces the number of parts requiring service or quick and easy service/repair

PERFORMANCE:

Outlet pressure range	10-30 psi (Factory set 14 psi)
Maximum inlet pressure	200 psi
Service	Water

APPLICATIONS:

Larger hot water space heating boilers that require faster filling.

AVAILABLE CONNECTIONS:

Threaded (NPT)	1/2"
Threaded (NPT) Union	1/2"
Sweat Copper Union	1/2"
Threaded (NPT) Double Union	1/2"

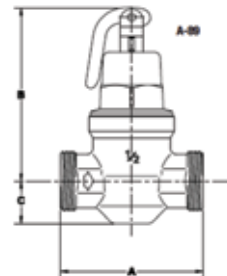

DIMENSIONS (inches)	A	B	C
A-89	3-9/16	4-3/8	1-1/16
A-89 Union	4-5/16	4-3/8	1-1/16
A-89 Double Union	5-1/16	4-3/8	1-1/16
A-89C	4-5/16	4-3/8	1-1/16
A-43CRF	3-5/8	3-5/8	3/4

PRODUCT DESCRIPTION	PART NUMBER
NON-POTABLE A SERIES BOILER FEED VALVES	
1/2" A-89 NPT	25082-0014
1/2" A-89C, Sweat	25083-0014
1/2" A-89U, Single for Water	25084-0014
1/2" A-89DU, Double for Water	25085-0014



BFAC

RESIDENTIAL, COMMERCIAL

The BFAC pressure reducing backflow preventer combines the quality pressure reduction of the A-89 Pressure Reducing Boiler Feed Valve with the effective backflow prevention of the BFP Double-Check Backflow Preventer. The BFAC accurately reduces system pressure down to 14 psi while preventing the back-siphonage of contaminated water into the potable water supply. The BFAC features threaded (NPT) inlet and outlet connections.

FEATURES AND BENEFITS:

- Pressure reduction and prevention of water backflow in one compact valve
- A-89 contains a polymer seat to prevent scaling
- Economical and easy to install
- Features a double-check vacuum breaker backflow system preventing the reverse flow of polluted water
- Rapid fill and balanced piston allows for closer outlet control

PERFORMANCE:

Outlet pressure A-89 factory set at 14 psi
 Maximum temperature 180°F (82.2°C)
 Maximum inlet pressure 170 psi
 Service Water

APPLICATIONS:

Designed specifically for smaller boiler feed lines.

AVAILABLE CONNECTIONS:

Sweat 1/2" Inlet
 Threaded (NPT female) 1/2" Outlet



PRODUCT DESCRIPTION	PART NUMBER
NON-POTABLE BFAC	
1/2" BFA Single Union Sweat Combination Backflow Preventer/PRV	23029-0014

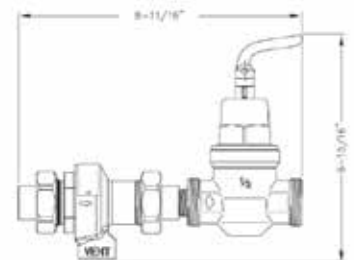



GENERAL PLUMBING & HEATING

CBL

COMMERCIAL

The CBL series hot water boiler dual control valve features an all bronze construction, inbuilt stainless steel strainer screen, neoprene and bronze diaphragms, brass and stainless steel seat, and renewable relief seat disc. Includes an inbuilt check valve to retard reverse flow and an inbuilt bypass for rapid filling, high pressure tests and system purging. Reduced pressure setting of 14 psi and relief setting of 30 psi for two-story buildings; slightly higher setting for 3-, 4- or 5-story buildings. Maximum inlet working pressure is 100 psi. Combines a pressure reducing and regulating valve, positive relief valve and bypass valve into one compact unit.

Note: For backflow prevention of boiler water into the potable water supply line, install a BFP dual check valve. The relief section of all Cash Acme Dual Controls is for thermal expansion ONLY. For proper pressure relief protection, the boiler must also be provided with a properly sized ASME rated relief valve.

FEATURES AND BENEFITS:

- Allows rapid filling of system
- Permits use of wide opening but small seated regulator eliminates noise, prevents "wire drawing" and premature seat wear
- Passes first-filling dirty water around the seat assuring a clean, good seating surface
- Every valve is tested for performance prior to shipping

PERFORMANCE:

Outlet pressure range	2 to 30 psi
	Relief valve: 30 to 40 psi
Maximum temperature	180°F (82.2°C)
Maximum inlet pressure	100 psi
Service	Water

APPLICATIONS:

Boiler water supply line. To assure automatic filling, maintain boiler pressure between 14 and 30 psi.

AVAILABLE CONNECTIONS:

Threaded (NPT) 1/2" Inlet, Outlet

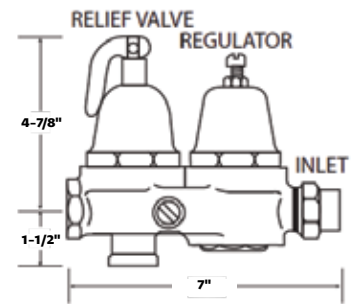

PRODUCT DESCRIPTION	PART NUMBER
NON-POTABLE CBL DUAL CONTROL FOR HOT WATER BOILERS (DELUXE MODEL)	
1/2" CBL Bronze Body (2 story)	02323-0002
1/2" CBL Bronze Body (5 story)	02323-0005



CQ-M

COMMERCIAL

The CQ-M series Hot Water Boiler Dual Control valve is constructed of a bronze body and features large unrestricted waterways, special heat resistant composition diaphragms, silicone relief seat and an easy to clean inbuilt stainless steel strainer. All units have a test lever and an inbuilt check valve to prevent backflow. Provides pressure control and protection from thermal expansion.

Note: The relief section of all Cash Acme Dual Controls is for thermal expansion ONLY. For proper pressure relief protection, the boiler must also be provided with a properly sized ASME rated relief valve.

FEATURES AND BENEFITS:

- Poppet relief design provides over-pressure protection
- Every valve is tested for performance prior to shipping
- Economical and exclusive design features

PERFORMANCE:

Outlet pressure range 2 to 30 psi
 Maximum temperature 180°F (82.2°C)
 Maximum inlet pressure 100 psi
 Service Water

APPLICATIONS:

Designed for hot water space heating installations.

AVAILABLE CONNECTIONS:

Threaded (NPT) 1/2"
 Sweat 1/2"



PRODUCT DESCRIPTION	PART NUMBER
NON-POTABLE CQ DUAL CONTROL FOR HOT WATER BOILERS (ECONOMY MODEL)	
1/2" CQ-M Bronze Body, Union Inlet (specify story)	07045-0002

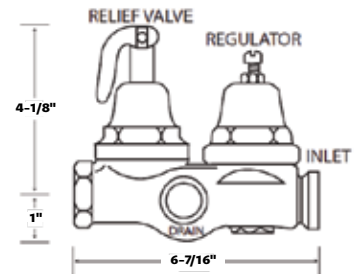



GENERAL PLUMBING & HEATING

CR

COMMERCIAL

The CR series dual control valve for hot water space heating boilers features a balanced piston for closer outlet pressure control regardless of variations in inlet pressure and a rapid fill feature with an improved larger seat for higher capacities and quicker fill. It has an iron body, brass internal parts on the regulator, special heat resistant composition diaphragm and O-rings, brass strainer screen, and stainless steel springs. Relief valve has bronze body, silicone seat disc and stainless steel spring.

Note: The relief section of all Cash Acme Dual Controls is for thermal expansion only. For proper pressure relief protection, the boiler must also be provided with a properly sized ASME rated relief valve.

FEATURES AND BENEFITS:

- Poppet relief design provides over-pressure protection
- Every valve is tested for performance prior to shipping
- Economical and exclusive design features

PERFORMANCE:

Outlet pressure	Factory set at 14 psi
Maximum temperature	180°F (82.2°C)
Maximum inlet pressure	100 psi
Service	Water

APPLICATIONS:

Designed for hot water space heating installations, the CR Series valve is suitable for 1-, 2- or 3-story buildings without adjustment.

AVAILABLE CONNECTIONS:

Threaded (NPT)	1/2" Inlet, Outlet
Sweat	1/2" Inlet



PRODUCT DESCRIPTION	PART NUMBER
NON-POTABLE CR DUAL CONTROL FOR HOT WATER BOILERS (ECONOMY MODEL)	
1/2" CR Iron Body, Threaded, Rapid Fill	18394-0002
1/2" CRC Iron Body, Copper Sweat, Rapid Fill	18398-0002

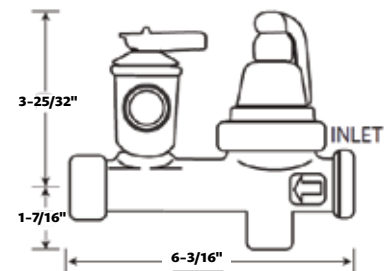



AIR SEPARATOR*

COMMERCIAL

Air Separators are intended for use in non-potable, hydronic heating systems to remove entrapped air from the circulating water. The Cash Acme Air Separators incorporate a "Separating Cartridge" that traps air and allows it to be vented via the integral air vent at the top of the unit.

FEATURES AND BENEFITS:

- High quality brass body with a nickel plated finish for durable construction and long lasting service
- Economical and easy to install
- Wide range of sizes to fit a variety of heating systems

PERFORMANCE:

Maximum temperature 240°F (115.6°C)
 Maximum pressure 125 psi
 Finish Nickel plated

APPLICATIONS:

Intended for use in non-potable, hydronic heating systems to remove entrapped air from the circulating water.

AVAILABLE CONNECTIONS:

Threaded (NPT) 1/2", 3/4", 1", 1-1/4", 1-1/2" and 2"

Note: Each Air Separator comes complete with an alternate bottom plug with 1/2" NPT tapping.

**While supplies last*



DIMENSIONS (inches)						
ITEM – SIZE	A	B	C	D	E	F
24077 – 1/2"	2-5/8	1-7/8	1	4-1/2	6-1/2	1-1/2
24078 – 3/4"	2-15/16	1-7/8	1	4-9/16	6-3/4	1-5/8
24079 – 1"	3-1/2	1-7/8	1	4-5/8	7	1-7/8
24080 – 1-1/4"	4	1-7/8	1	4-1/2	7-7/32	2-7/64
24081 – 1-1/2"	4-3/8	1-7/8	1	4-1/2	7-3/4	2-11/32
24082 – 2"	5-1/4	1-7/8	1	4-5/8	8-3/8	2-7/8

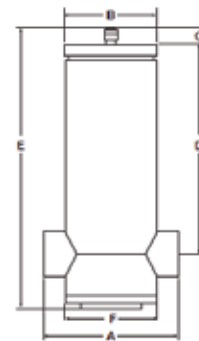

PRODUCT DESCRIPTION	PART NUMBER
NON-POTABLE AIR SEPARATORS	
1/2" Air Separator	24077
3/4" Air Separator	24078
1" Air Separator	24079
1-1/4" Air Separator	24080
1-1/2" Air Separator	24081
2" Air Separator	24082



GENERAL PLUMBING & HEATING

AIR PURGER*

COMMERCIAL

Air Purgers are specially designed to eliminate potential air from systems by entraining air to the top of the unit and venting through an air vent. Constructed of a one-piece cast iron design with internal baffles, the Cash Acme Air Purger is economical, easy to install, and requires no maintenance once installed within a system. Available in a variety of sizes ranging from 1" through 4".

FEATURES AND BENEFITS:

- One piece cast iron construction for durable construction and long lasting service
- Economical and easy to install
- Wide range of sizes to fit a variety of heating systems

APPLICATIONS:

For use in heating systems to trap entrained air from the circulating water.

AVAILABLE CONNECTIONS:

Threaded (NPT) 1", 1-1/4", 1-1/2", 2", 2-1/2", 3" and 4"

Note: Each Air Separator comes complete with an alternate bottom plug with 1/2" NPT tapping.

*While supplies last



Item	A	DIMENSIONS (inches)		TAPPING – NPT (inches)		
		B	C	A	F	E
24083	1	6	3-3/4	1	1/8	1/2
24084	1-1/4	6	3-3/4	1-1/4	1/8	1/2

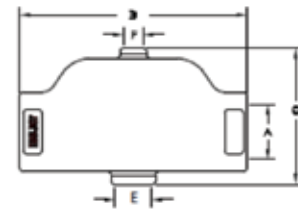

Item	A	DIMENSIONS (inches)		TAPPING – NPT (inches)		
		B	C	A	F	E
24085	1-1/2	8	5	1-1/2	1/8	1/2
24086	2	8	5	2	1/2	1/2
24087	2-1/2	10	6	2-1/2	3/4	1/2
24088	3	10	6	3	3/4	1/2

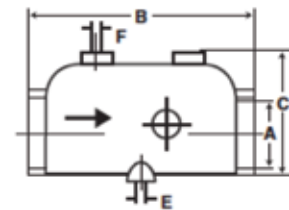

Item	A	DIMENSIONS (inches)		TAPPING – NPT (inches)		
		B	C	A	F	E
24089	4	10-1/2	9-1/4	4	3/4	1/2

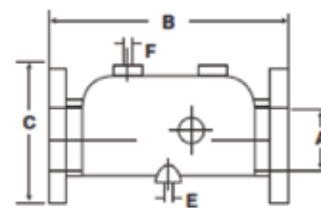

PRODUCT DESCRIPTION	PART NUMBER
NON-POTABLE AP SERIES AIR PURGERS	
1" Air Purger	24083
1-1/4" Air Purger	24084
1-1/2" Air Purger	24085
2-1/2" Air Purger	24087



AIR VENT

COMMERCIAL

Air vents are used in commercial heating systems to vent potential air that is trapped within the system's circulating water. Constructed of all brass material, the Cash Acme Air Vent is economical, easy to install, and requires no maintenance once installed within a system.

FEATURES AND BENEFITS:

- High quality brass body with a nickel plated finish for durable construction and long lasting service
- Economical and easy to install

PERFORMANCE:

Working Pressure 90-150 psi (or refer to chart)
Service Water

APPLICATIONS:

For use in heating systems to vent air trapped within the circulating water.

AVAILABLE CONNECTIONS:

Threaded (NPT) 1/8" and 1/4"



DIMENSIONS (inches)				
ITEM	A	B	C	D
24090	1-15/16	1-21/32	1-7/8	1/8 NPT
24091	1-15/16	1-21/32	1-7/8	1/4 NPT

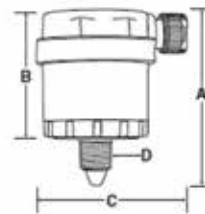

PRODUCT DESCRIPTION	PART NUMBER
NON-POTABLE AP SERIES AIR VENTS	
1/8" Air Vent, Brass	24090
1/4" Air Vent, Brass	24091

MADE IN THE USA

It's our commitment to quality that has driven a century of success with water control valves that stand the test of time. Proudly built in America for more than 100 years, Cash Acme's ISO 9001-certified quality assurance processes ensure that every valve that leaves our facility is 100% tested and meets all standards.

From our 550,000 square feet. manufacturing and distribution campus in Cullman, Alabama, Cash Acme's 200+ employees streamline operational excellence with proprietary programs to drive continuous improvement through key metrics, spanning production targets, delivery performance, inventory and safety. We proudly own our manufacturing process from start to finish, so every Cash Acme valve that's installed is guaranteed from concept to delivery.

Cash Acme valves are an important part of the North American operations of Reliance Worldwide Corporation(RWC) and our expertise in water valves around the world forms a core part of RWC's total package of global water control solutions. RWC succeeds on a world platform utilising an integrated global operations strategy and regional centres of excellence across our international company portfolio.

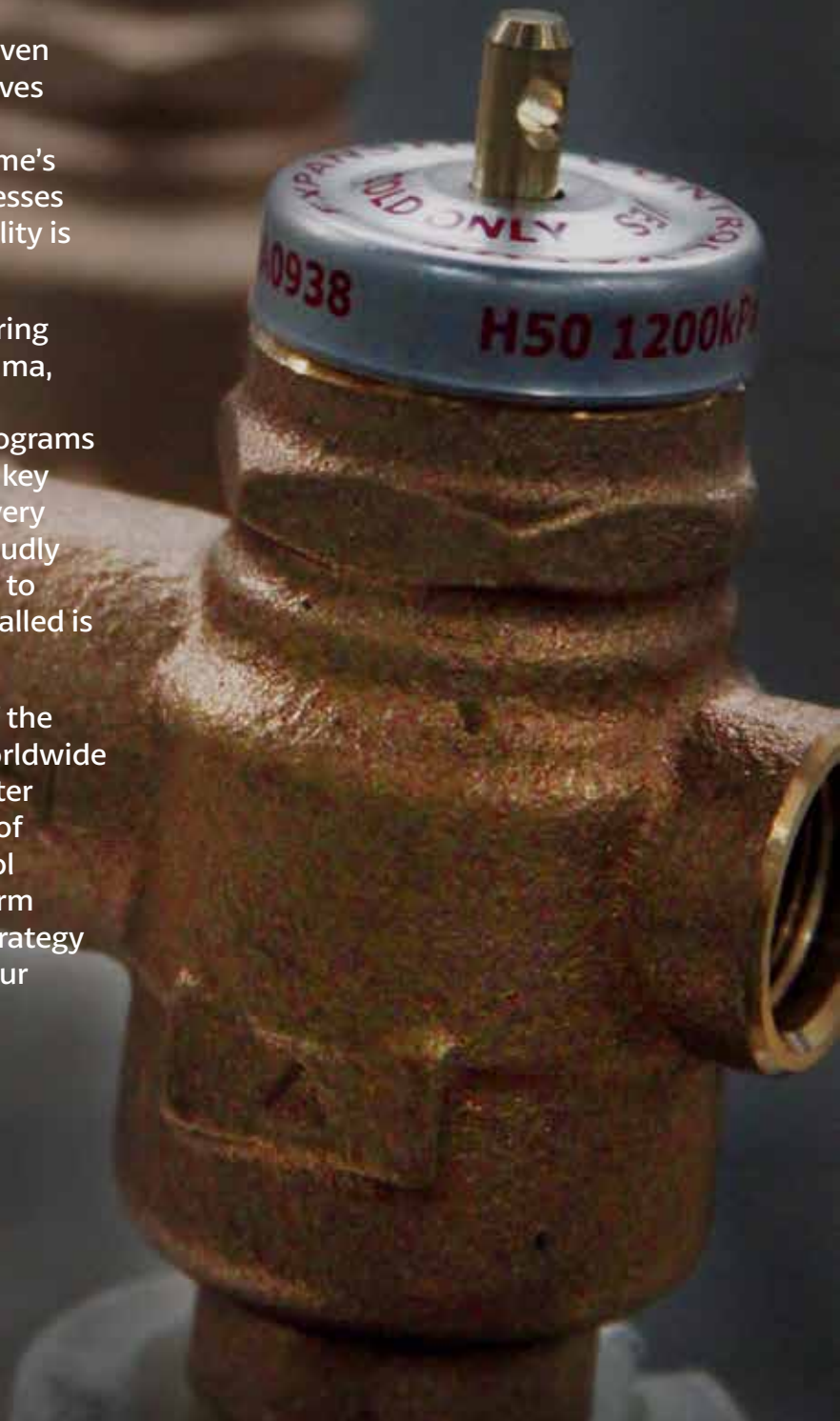

LIMITED WARRANTY

SHARKBITE® AND CASH ACME® PRODUCTS

WHAT DOES THIS WARRANTY COVER?

Subject to conditions outlined in this statement, RWC (in the USA, Reliance Worldwide Corporation and in Canada, Reliance Worldwide Corporation (Canada) Inc.) warrants to owners of real property in the United States and Canada that SharkBite and Cash Acme products, when used and installed in accordance with the requirements set forth, shall be free from defects in material and workmanship for the applicable Warranty Period. This Limited Warranty is in effect for installations made after January 1, 2016 and is applicable to products installed in the country in which they were purchased.

Proof of purchase is required to validate the Warranty Period. If proof of purchase is not available, the Warranty Period commencement shall default to the date of manufacture for each product. If the product suspected of a defect does not have a clear date of manufacture on it, a proof of purchase will be required.

WHAT ARE THE CONDITIONS OF THIS WARRANTY?

1. All products must be installed in accordance with all then applicable codes, good plumbing practice, in accordance with any local, state, provincial or federal requirements, and installed in a potable water or radiant heating application unless a non-potable water service is specifically allowed for in the pertinent product literature.
2. The installer must use construction techniques compliant with then applicable codes to install the product and use the product within the design parameters specified in any installation guidelines and technical notes for the applicable system. This shall include field pressure testing prior to concealing with concrete or by other means and wrapping any brass fitting when buried. Failure to install RWC products according to manufacturer's installation instruction will void all applicable warranties and may result in severe water damage.
3. Products must at all times be used in a manner consistent with their intended use and be used in installations and environments acceptable to their material and design specifications, including not being installed in a system that may operate at temperatures or at pressures that exceed the approved ratings which can be found on the product, packaging or installation instructions.
4. Additional product specific conditions of this Limited Warranty and the Warranty Period are documented in the section entitled "HOW LONG DOES THE LIMITED WARRANTY COVERAGE LAST AND WHAT OTHER SPECIFIC CONDITIONS EXIST FOR EACH PRODUCT?". A condition for SharkBite Connection Systems is that the product must be installed by a licensed professional plumbing contractor.
5. Without limiting the foregoing, this Limited Warranty does not apply and you do not have a right of reimbursement if the product failure or resulting damage is caused by: (a) evidence of tampering, mishandling, neglect, abuse, accidental damage, freeze damage (it is expressly understood that failure as a result of any freezing fluids within the pipes does not constitute a defect in material or workmanship and shall not be covered by this warranty) or unauthorized modifications or repairs that cause damage to warranted products; (b) exposure to harmful, unauthorized, or unanticipated chemicals or substances or corrosive water conditions; (c) exposure to ultraviolet light; (d) faulty installation including failure to follow proper burial instructions; (e) damage from abnormal operating conditions including exposure pressures and temperatures beyond the specified operating range; (f) failure to properly test and pass common testing methods (including pressure testing) after the installation and before the product or system is put in service; (g) components not manufactured or sold by RWC; or (h) acts of nature such as earthquakes, fire, flood or lightning.
6. Although RWC provides a plumbing system to facilitate a complete installation, other manufacturers pipe and/or fittings may be installed in any given installation provided manufacturing of the pipe and/or fittings demonstrates compliance with the applicable ASTM/CSA standards, and the product has been certified by a recognized third-party testing agency. The RWC product in the given installation will continue to be covered under this Limited Warranty although limits on Warranty Period may apply. RWC will be responsible only for proven defects in material or workmanship in RWC products. Problems in products manufactured by another company should be reported to that manufacturer.

HOW DO YOU GET SERVICE?

In order to be eligible for service under this Limited Warranty you must return the defective product to RWC for inspection and testing within thirty (30) days after detection of alleged failure or defect occurring within applicable Warranty Period (with shipping charges prepaid) to the original place of purchase. If the alleged defect involves a connection or joint with a RWC product, the fitting must be

returned with a section of the pipe still inserted. You must include the model number of the product (if available), the original date of purchase, proof of purchase and the nature of the alleged product failure or defect. Products returned without shipping charges prepaid will be refused. For questions or inquiries, in the U.S. call 1(877)700-4242 and in Canada 1(888)820-0120.

WHAT WILL RWC DO?

If, after inspection, we find that a product covered by this Limited Warranty has failed due to a defect in material or workmanship during the specified Warranty Period, we will repair or replace, at our sole option, free of charge, the defective product during normal working hours and through a place of business as determined by RWC.

Notwithstanding anything to the contrary in this Limited Warranty, if RWC determines that any damages to the real property in which a defective product was installed were the direct result of a leak or failure caused by a defect in material or workmanship in any RWC product covered by this Limited Warranty and occurring within the first ten years after date of purchase or during the applicable Warranty Period, whichever is shorter, and if reasonable steps were taken to promptly limit or stop the effects of such leak or failure as soon as it was discovered, then RWC will reimburse the property owner for the reasonable costs of repairing or replacing such damaged real property to include flooring, drywall and painting and other real property damaged by the leak directly caused by the allegedly defective RWC product. Except as specified above or otherwise specifically authorized in writing by RWC, RWC shall not pay for any costs or expenses for transportation, relocation, labor, repairs or any other work associated with removing and/or returning failed or defective products or installing replacement products.

This shall constitute the sole and exclusive remedy for any defective product.

WHAT DOES THIS LIMITED WARRANTY NOT COVER?

RWC shall not be responsible for any other incidental, indirect, contingent, special or consequential damages, including without limitation, economic loss, lost profits or the cost of repairing or replacing other property which is damaged if these warranted products do not work properly, other costs resulting from labor charges, delays, vandalism, negligence, fouling caused by foreign material, damage from adverse water conditions, adverse chemical environments, or any other circumstances over which RWC has no control. This limitation applies even if RWC could have foreseen or has been advised of the possibility of these damages. This Limited Warranty shall be invalidated by any abuse, misuse, misapplication or improper installation of the product. Any remaining warranty coverage may not be assigned or transferred after the period ending ten years following the installation. RWC does not guarantee or in any way warrant the integrity or workmanship of the contractor/installer.

MISCELLANEOUS

Some States/Provinces do not allow limitations on how long an implied warranty lasts, and some States/Provinces do not allow the exclusion or limitation of incidental or consequential damages. Therefore, the above limitations may not apply to you. This Limited Warranty gives you specific legal rights, and you may have other rights that vary from State/Province to State/Province. You should consult applicable State/Provincial laws to determine your rights.

SO FAR AS IS CONSISTENT WITH APPLICABLE STATE/ PROVINCIAL/ FEDERAL LAW, THE EXPRESS WARRANTY SET FORTH HEREIN IS THE ONLY WARRANTY GIVEN BY RWC WITH RESPECT TO THE SHARKBITE® AND CASH ACME® PRODUCTS AND RWC MAKES NO OTHER WARRANTIES, EXPRESSED OR IMPLIED, AND HEREBY SPECIFICALLY DISCLAIMS ALL OTHER WARRANTIES, EXPRESSED OR IMPLIED, INCLUDING BUT NOT LIMITED TO THE IMPLIED WARRANTIES OF MERCHANTABILITY AND FITNESS FOR A PARTICULAR PURPOSE.

This Limited Warranty and any claims arising from breach of contract, breach of warranty, tort, or any other claim arising from sale or use of RWC's products shall be governed and construed under the laws of the State of Georgia. No action on the part of RWC under this Limited Warranty shall be construed as an admission of liability of that the product is not fit for its intended use.

HOW LONG DOES THE LIMITED WARRANTY COVERAGE LAST AND WHAT OTHER SPECIFIC CONDITIONS EXIST FOR EACH PRODUCT?

CLASSIFICATION	PRODUCT CATEGORY	LIMITED WARRANTY PERIOD	CONDITIONS
SharkBite Connection Systems	SharkBite Brass and Poly PEX Barb Fittings in conjunction with SharkBite PEX Pipe and SharkBite Rings/Clamps	Twenty-Five (25) Years	System must be installed by a licensed professional plumbing contractor and include: <ul style="list-style-type: none"> • SharkBite PEX Pipe Only – ASTM F876/CSA B137.5 • SharkBite Copper Crimp Rings – ASTM F1807 or F2159 • Stainless Steel Clamp Rings – ASTM F2098
SharkBite and Cash Acme Products	SharkBite Universal Push-to-Connect Fittings and SharkBite 2XL Large Diameter Push-to-Connect Fittings in Application with Copper, PEX, CPVC and/or PE-RT	Twenty-Five (25) Years	Must be used with: <ul style="list-style-type: none"> • Copper—ASTM B 88 hard drawn copper tube K, L, and M • PEX—ASTM F876/CSA B137.5 • CPVC—ASTM D2846 or CSA B137.6 • PE-RT—ASTM F2769
	SharkBite Universal Push-to-Connect Fittings and SharkBite 2XL Large Diameter Push-to-Connect Fittings in Application with HDPE	Five (5) Years	Must be used with: <ul style="list-style-type: none"> • HDPE SDR-9 ASTM D2737
	SharkBite PEX Pipe	Twenty-Five (25) Years	Must be used with: <ul style="list-style-type: none"> • ASSE 1061, ASTM F1807, ASTM F2098, and/or ASTM F2159 fittings
	SharkBite Brass PEX Barb Fittings/ Copper Manifold	Five (5) Years	Must be used with Non-SharkBite PEX Pipe and Clamps/Rings that conform to: <ul style="list-style-type: none"> • PEX – ASTM F876/CSA B137.5 • Copper Crimp Rings – ASTM F1807 • Stainless Steel Clamp Rings – ASTM F2098
	SharkBite Poly PEX Barb Fittings	Five (5) Years	Must be used with Non-SharkBite PEX Pipe and Clamps/Rings that conform to: <ul style="list-style-type: none"> • PEX – ASTM F876/CSA B137.5 • Copper Crimp Rings – ASTM F2159 • Stainless Steel Clamp Rings – ASTM F2098
	SharkBite Tools	One (1) Year	From date of purchase; used in accordance with instructions
	SharkBite and Cash Acme Thermostatic Mixing Valves	Five (5) Years	Must be installed per installation instructions
	Other SharkBite and Cash Acme Valves	Two (2) Years	Must be installed per installation instructions
	SharkBite Accessories (Ball Valves, Supply Hoses, Supply Stops, Supply Valve Box Systems, Kits, Manifolds, etc.)	Two (2) Years	Must be installed per installation instructions



Reliance Worldwide Corporation

2727 Paces Ferry Road SE
Building 2, Suite 1800
Atlanta, GA 30339
Phone: 1-877-700-4242 • Fax: 1-877-700-4280
E-mail: sales@cashacme.com

Reliance Worldwide Corporation (Canada) Inc.

74 Alex Avenue
Vaughan, Ontario
L4L 5X1, Canada
Phone: 1-888-820-0120 • Fax: 1-905-265-2775
E-mail: canadasales@rwc.com

www.rwc.com



USA: www.cashacme.com | Canada: www.cashacme.ca

Manufactured and Distributed by Reliance Worldwide Corporation