

Residential Registers, Grilles & Diffusers

No one satisfies the demands for air distribution solutions better than Hart & Cooley. Our wide selection of registers, grilles, diffusers, and accessories includes a variety of shapes and sizes to meet any application and budget requirement.

Products are offered in steel, aluminum or plastic construction, and are designed for installation ease. They are made with an attention to detail that contributes to unmatched performance.

For example: an electro-deposition paint finish creates a flawless appearance; stamped face margins eliminate mitered corners and rough edges; each product is identified with a unique bar code label; and shrink-wrap packaging makes sure products are delivered in perfect condition. The wide variety of fin spacings, air patterns, and damper controls assures an appropriate solution for each application.

A nationwide distribution network provides for consistent product availability and timely delivery.



210 Floor Register

- All-steel construction
- Provides firm, smooth surface
- Extremely rigid
- Free area averages over 75%
- Toe-operated valve control
- Golden Sand enamel finish

210 Standard Sizes (in.)						
HT	WIDTH					
	6	8	10	12	14	16
4		X	X	X	X	
6	X	X	X	X	X	X
8		X	X	X	X	
9				X		
10			X	X	X	
12				X	X	

Contact factory for sizes not listed.

End View Showing Depth with Valve Open:

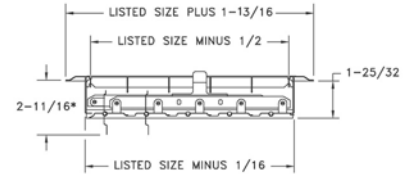

*3-9/16 FOR SIZES OVER 14 x 20



265 Floor Return Air Grille

- All-steel construction
- Provides firm, smooth surface
- Extremely rigid
- Free area averages over 75%
- Golden Sand enamel finish

265 Standard Sizes (in.)											
HT	WIDTH										
	8	10	12	14	16	18	20	24	25	30	36
4	X	X	X	X		X		X		X	
6		X	X	X	X	X	X	X		X	X
8	X	X	X	X	X	X	X	X		X	
9			X								
10		X	X	X	X	X	X	X		X	
12			X	X	X	X	X	X		X	
14				X	X		X	X		X	
16					X		X	X		X	
18						X		X		X	
20							X	X	X	X	
24								X		X	X

Contact factory for sizes not listed.

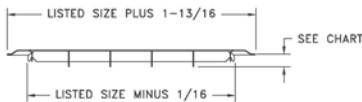

HEIGHT	WIDTH	MAXIMUM DEPTH
4 THRU 14	6 THRU 30	$2\frac{1}{32}$
14 THRU 14	32 THRU 36	$2\frac{5}{32}$
16 THRU 18	16 THRU 36	$1\frac{13}{32}$
20 THRU 24	20 THRU 36	$1\frac{13}{32}$



411 Deluxe Floor Diffuser

- All-steel construction
- Heavy-gauge individually welded diffusion vanes
- Multi-angle fin setting
- Foot-operated dial control
- Can be used in high traffic areas
- Golden Sand or Bright White enamel finish

411 Available Sizes (in.)	
Size	Free Area Sq. In.
2 x 10	15
2 x 12	19
2 x 14	22
4 x 10	29
4 x 12	35
4 x 14	40
6 x 10	44
6 x 12	53
6 x 14	60

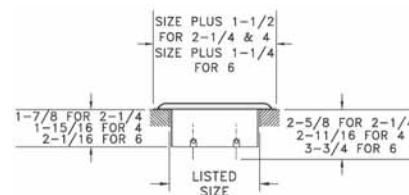
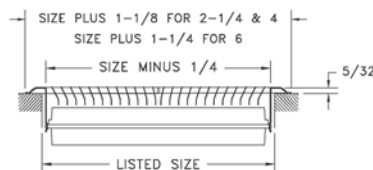



420 Toe-Space Grille

- All-steel construction
- Heavy-gauge stamped face
- Multi-angle fins
- Golden Sand or Bright White enamel finish

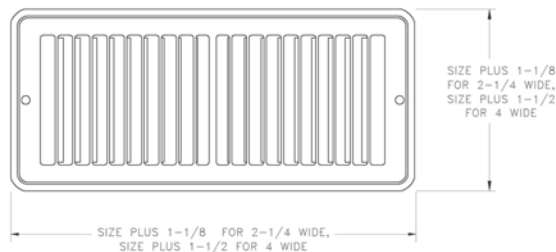
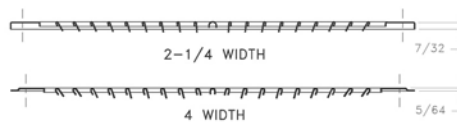

420 Available Sizes (in.)	
Size	Free Area Sq. In.
10 x 2	15
12 x 2	17
14 x 2	20
10 x 4	27
12 x 4	32
14 x 4	37



421 Floor Diffuser

- All-steel construction
- Multi-angle fin setting
- Rolled fin for strength and safety
- Welded construction
- Foot-operated dial control
- Heavy-gauge stamped face
- Golden Sand or Bright White enamel finish

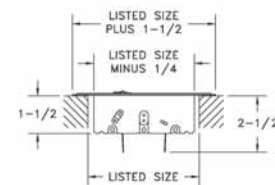
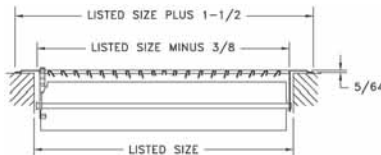

421 Available Sizes (in.)	
Size	Free Area Sq. In.
2 x 10	15
2 x 12	17
2 x 14	20
4 x 8	22
4 x 10	27
4 x 12	32
4 x 14	37
6 x 10	39
6 x 12	48
6 x 14	56



531 Royale® Floor Diffuser

- Extruded aluminum construction
- Corrosion-resistant, high strength
- Heavy cross-bracing at strategic intervals
- Dual multi-shutter valves for adjustable air pattern
- Nylon slide valve operators
- Satin-anodized finish

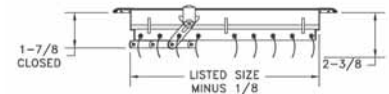
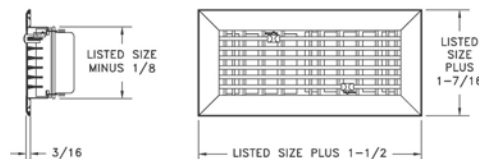

531 Available Sizes (in.)	
Size	Free Area Sq. In.
2 x 10	10
2 x 12	12
2 x 14	14
4 x 10	19
4 x 12	23
4 x 14	27
6 x 10	31
6 x 12	37
6 x 14	44

Baseboard Registers & Grilles

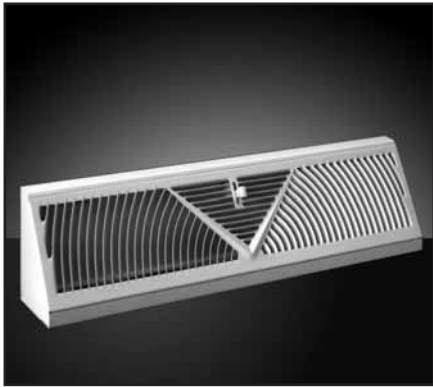

405/406 Baseboard Diffuser

- All-steel construction
- Blankets wall or window area
- Golden Sand or Bright White enamel finish

Model Number	Size	Free Area Sq. In.	Overall Length	Height	Base Projection	Opening Width
405	18"	38	18	5 ¹ / ₄	2 ¹³ / ₁₆	12
406	15"	32	15	4 ¹ / ₂	2 ³ / ₄	12
406	18"	38	18	4 ¹ / ₂	2 ¹³ / ₁₆	12
407	18"	38	18	4 ¹ / ₂	2 ¹³ / ₁₆	12

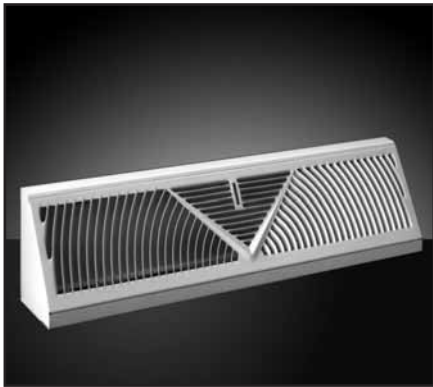
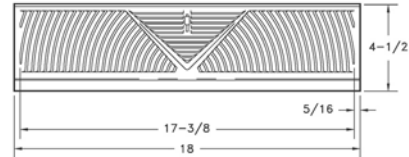

407 Matching Return Air Grille

- All-steel construction
- Complementary return air grille for Model 405 or Model 406 supply
- Golden Sand or Bright White enamel finish

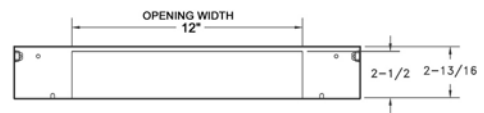

BOTTOM VIEW

406 18" Shown

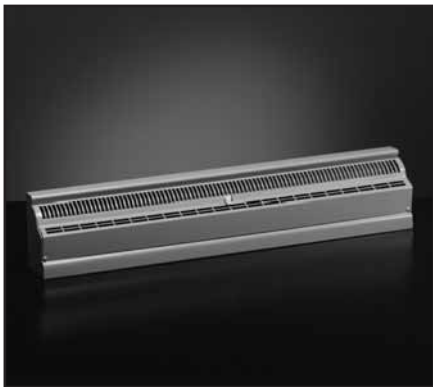

462 Baseboard Diffuser

- All-steel construction
- Two-foot length
- Airfoil valves reduce resistance
- Equal air distribution over the length of the diffuser
- Face can be easily removed
- Golden Sand or Bright White enamel finish

Model Number	Size	Free Area Sq. In.	Overall Length	Height	Base Projection	Bottom Opening
462	2'	27	24	4 ¹ / ₂	2 ²³ / ₃₂	2 ⁵ / ₁₆ x 16
472	2'	42	24	4 ¹ / ₂	2 ²³ / ₃₂	2 ⁵ / ₁₆ x 16

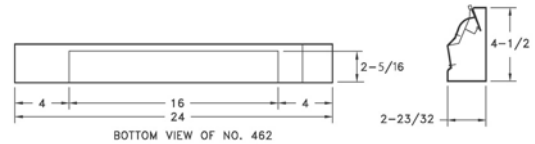

BOTTOM VIEW OF NO. 462



472 Matching Return Air Grille

- All-steel construction
- Two-foot length
- Complementary return air grille for Model 462 supply
- Golden Sand or Bright White enamel finish

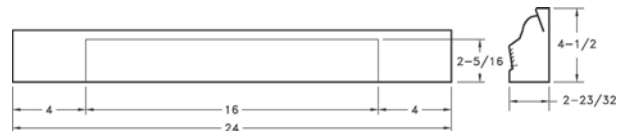

BOTTOM VIEW OF NO. 472

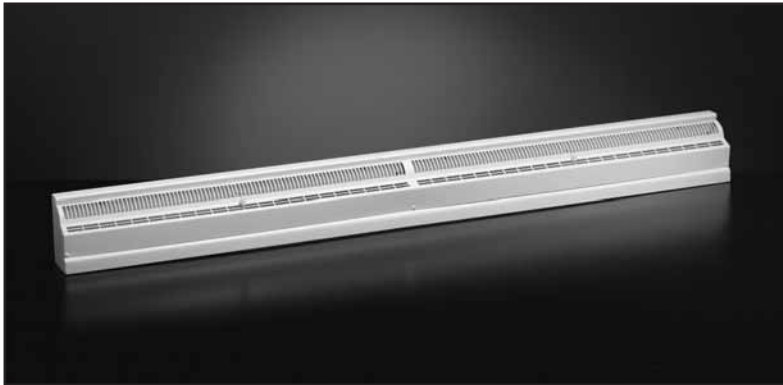

464 Baseboard Diffuser

- All-steel construction
- Four-foot length
- Airfoil valves reduce resistance
- Equal air distribution over the length of the diffuser
- Dual valves
- Face can be easily removed
- Golden Sand or Bright White enamel finish

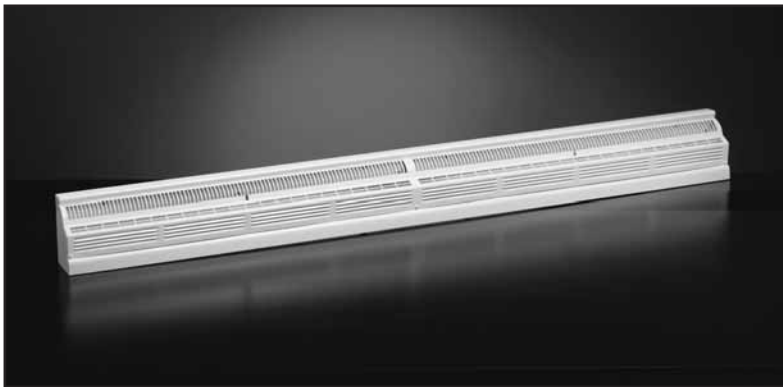

474 Matching Return Air Grille

- All-steel construction
- Four-foot length
- Complementary return air grille for Model 464 supply
- Golden Sand or Bright White enamel finish

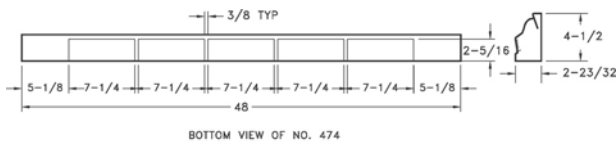
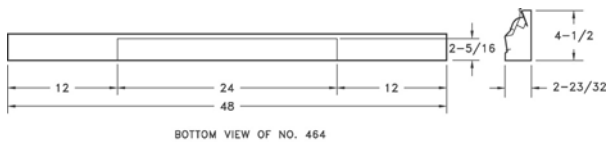

Model Number	Size	Free Area Sq. In.	Overall Length	Height	Base Projection	Bottom Opening
464	4'	54	48	4 1/2	2 ²³ / ₃₂	2 ⁵ / ₁₆ X 24
474	4'	84	48	4 1/2	2 ²³ / ₃₂	2 ⁵ / ₁₆ X 36 ¹ / ₄



654 Baseboard Register with Damper

- One-piece steel construction
- 1/3" spaced fins set at 20 degrees
- 7/8" margin turnback
- Exceptional free area
- Positive volume-control damper
- Bright White enamel finish

654 Available Sizes (in.)			
HT	WIDTH		
	10	12	14
6	X	X	X

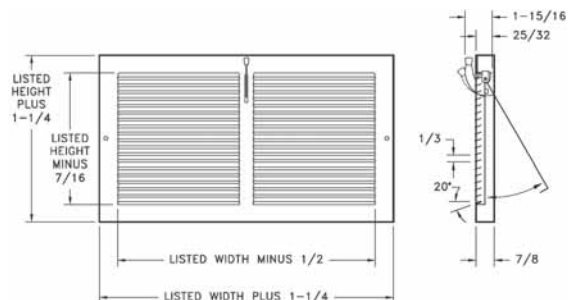



655 Baseboard Register with Damper

- All-steel construction
- 1/3" spaced fins set at 20 degrees
- Positive volume-control damper
- Bright White enamel finish

655 Available Sizes (in.)				
HT	WIDTH			
	6	X	X	X

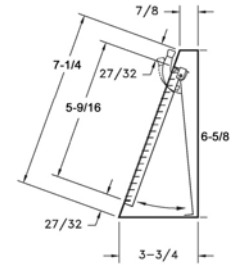
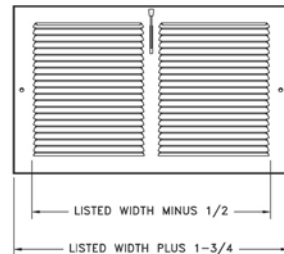

657 Baseboard Return Air Grille

- One-piece steel construction
- 1/3" spaced fins set at 20 degrees
- 7/8" margin turnback
- Exceptional free area
- Install with fins upward or downward for best duct concealment
- Complementary return air grille for Model 654 or 664 supply
- Golden Sand or Bright White enamel finish

657 Standard Sizes (in.)							
HT	WIDTH						
	4			X			
6	X	X	X	X	X	X	X
8	X	X	X	X	X	X	X
10			X		X	X	
12			X			X	X

Contact factory for sizes not listed.

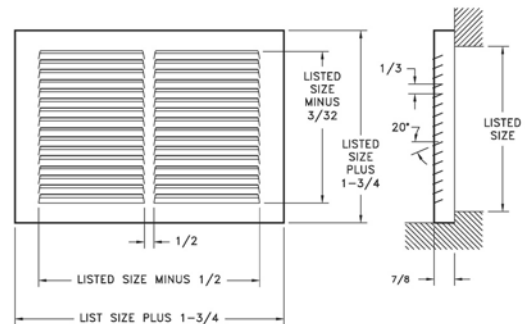

658 Baseboard Return Air Grille

- All-steel construction
- 1/3" spaced fins set at 20 degrees
- Complementary return air grille for Model 655 supply
- Bright White enamel finish

658 Available Sizes (in.)					
HT	WIDTH				
	6	X	X	X	X
8			X	X	X

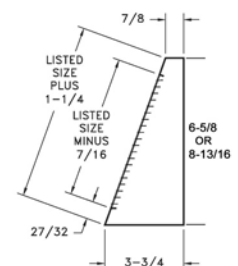
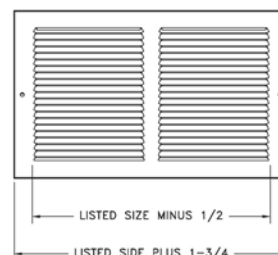

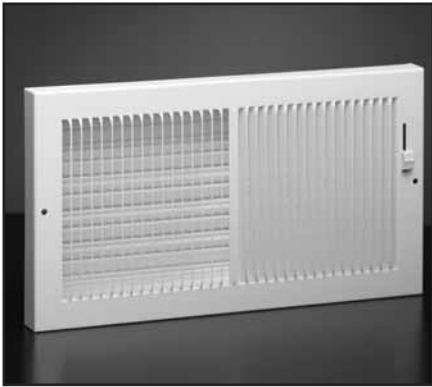

664 Baseboard Register

- All-steel construction
- 1/3"-spaced fins set at 20 degrees
- 7/8" margin turnback
- 1-5/8" depth when fully opened
- Exceptional free area
- Ideal for shallow duct installations
- Multi-shutter valve
- Bright White enamel finish

664 Available Sizes (in.)				
HT	WIDTH			
		8	10	12
6	X	X	X	X
8			X	

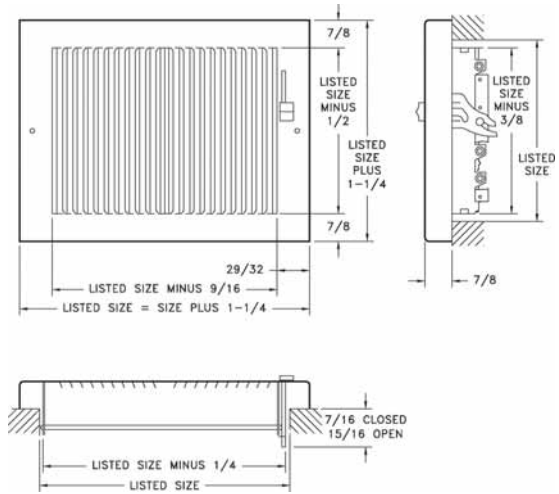

674 Return Air Grille

- One-piece steel construction
- 1/2"-spaced fins set at 40 degrees
- 7/8" margin turnback
- Complementary return air grille for 1/2"-spaced products
- Bright White enamel finish

674 Available Sizes (in.)			
HT	WIDTH		
		14	24
6	X	X	X
8	X	X	X

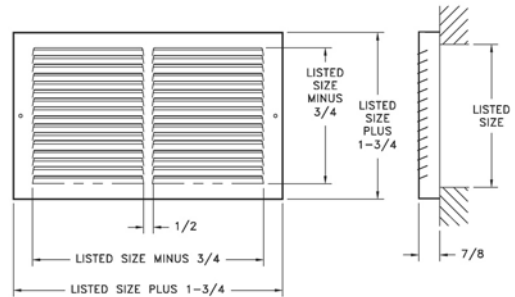

Sidewall Registers & Grilles

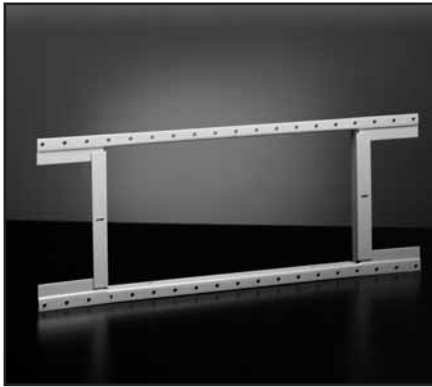

Model 3 Sidewall Stud Frame

- All-steel construction
- Extension arms fasten directly to studs
- Provides solid foundation for register and stackhead
- Permits good plaster base right up to frame

Model 3 Available Sizes (in.)					
HT	WIDTH				
		10	12	14	24
4		X			
6	X	X	X	X	X



301 Register

- All-steel one-piece stamped-face curved-blade construction
- One-way deflection
- One-way air pattern
- For sidewall or ceiling application
- Multi-shutter valve
- Listed heights 10" and larger require double valves
- Bright White enamel finish

301 Available Sizes (in.)					
HT	WIDTH				
		6	8	10	12
4		X	X	X	X
6	X	X	X	X	X
8		X	X	X	X
10			X		
12				X	

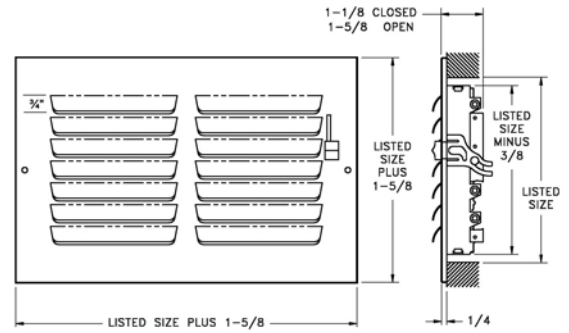

A301 Register

- Aluminum one-piece stamped-face curved-blade construction
- For sidewall or ceiling application
- One-way deflection
- One-way air pattern
- Galvanized multi-shutter valve
- Listed heights 10" and larger require double valves
- Bright White enamel finish

A301 Available Sizes (in.)					
HT	WIDTH				
		6	8	10	12
4		X	X	X	
6	X	X	X	X	X
8		X	X	X	X
10			X		

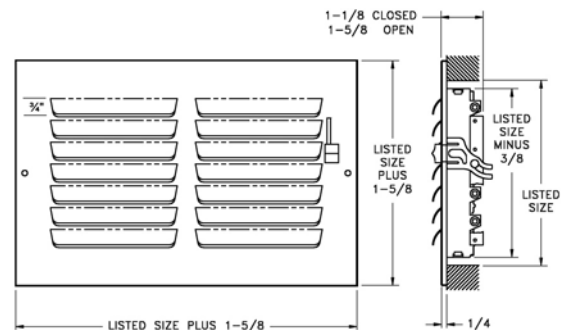

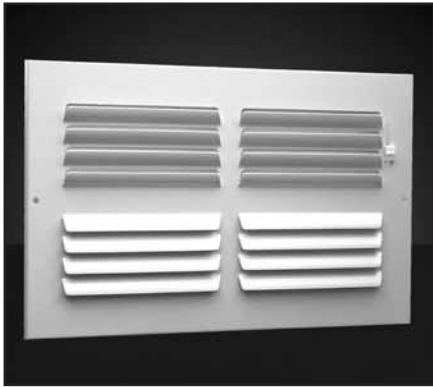

302 Register

- All-steel one-piece stamped-face curved-blade construction
- Two-way deflection
- Two-way air pattern
- For sidewall or ceiling application
- Multi-shutter valve
- Listed heights 10" and larger require double valves
- Bright White enamel finish

302 Available Sizes (in.)				
HT	WIDTH			
		8	10	12
4	X			
6	X	X	X	X
8	X	X	X	X

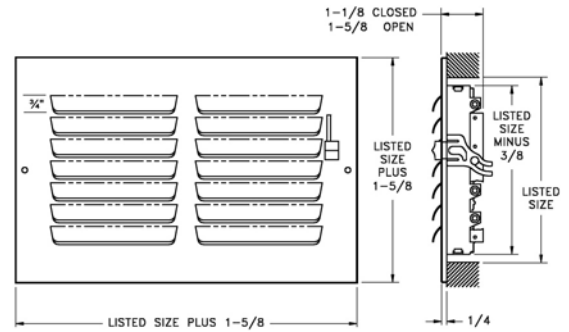

A302 Register

- Aluminum one-piece stamped-face curved-blade construction
- For sidewall or ceiling application
- Two-way deflection
- Two-way air pattern
- Galvanized multi-shutter valve
- Listed heights 10" and larger require double valves
- Bright White enamel finish

A302 Available Sizes (in.)		
HT	WIDTH	
		10
6	X	X
8		X
10	X	

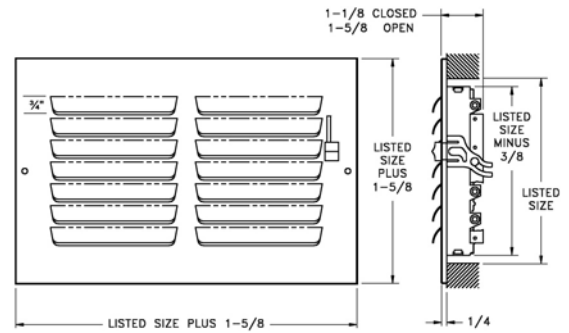

303 Register

- All-steel one-piece stamped-face curved-blade construction
- Three-way deflection
- Three-way air pattern
- For sidewall or ceiling application
- Multi-shutter valve
- Listed heights 10" and larger require double valves
- Bright White enamel finish

303 Available Sizes (in.)						
HT	WIDTH					
		6	8	10	12	14
4		X	X		X	
6	X	X	X	X	X	X
8		X	X	X	X	
10			X			
12				X		

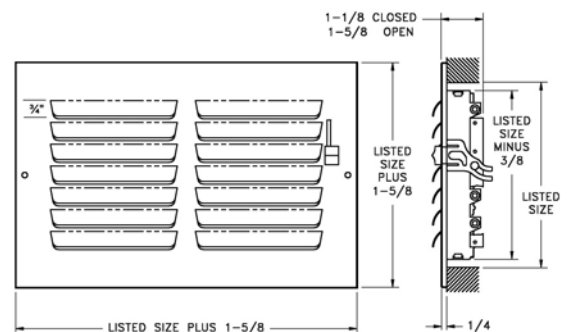

Sidewall Registers & Grilles



A303 Register

- Aluminum one-piece stamped-face curved-blade construction
- For sidewall or ceiling application
- Three-way deflection
- Three-way air pattern
- Galvanized multi-shutter valve
- Listed heights 10" and larger require double valves
- Bright White enamel finish

A303 Available Sizes (in.)					
HT	WIDTH				
		6	8	10	12
4		X			
6	X		X	X	X
8		X	X	X	
10			X		
12				X	

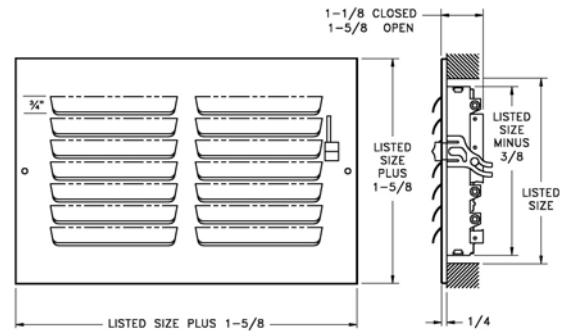

304 Register

- All-steel one-piece stamped-face curved-blade construction
- Four-way deflection
- Four-way air pattern
- For sidewall or ceiling application
- Multi-shutter valve
- Listed heights 10" and larger require double valves
- Bright White enamel finish

304 Available Sizes (in.)					
HT	WIDTH				
		6	8	10	12
6	X				
8		X			
10			X		
12				X	
14					X

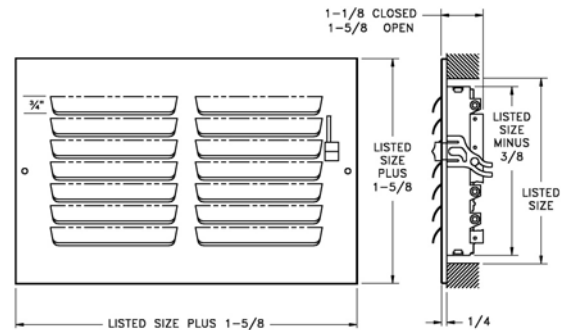

A304 Register

- Aluminum one-piece stamped-face curved-blade construction
- For sidewall or ceiling application
- Four-way deflection
- Four-way air pattern
- Galvanized multi-shutter valve
- Listed heights 10" and larger require double valves
- Bright White enamel finish

A304 Available Sizes (in.)				
HT	WIDTH			
		6	8	10
6	X			
8		X		
10			X	
12				X

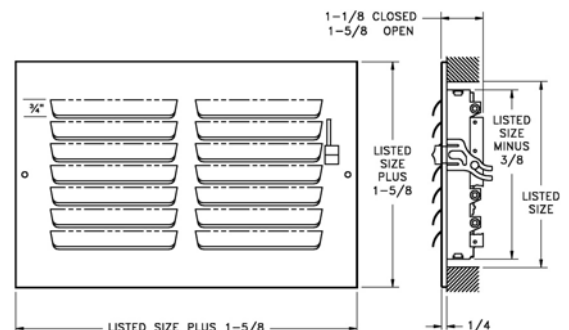

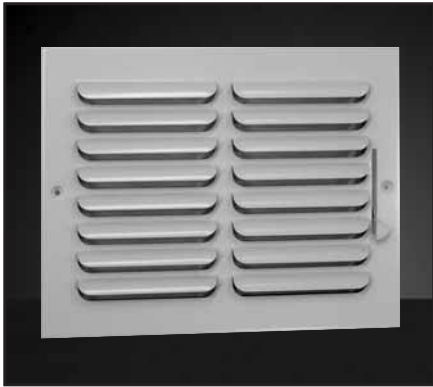

300M Series Register

- All-steel construction with metal handle
- Stamped curved-blade supply register with multi-louver damper for ceiling or sidewall installation
- Stamped, one-piece face with multi-louver damper for volume control
- Available in 1-way, 2-way, 3-way and 4-way airflow patterns
- Bright White finish

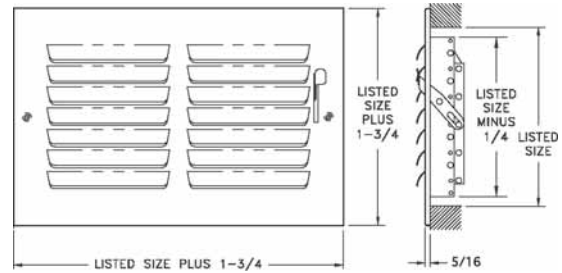

301M Available Sizes (in.)					
HT	WIDTH				
	6	8	10	12	14
4		X		X	
6	X	X	X	X	X
8		X	X	X	X
10			X		X
12				X	



302M Available Sizes (in.)		
HT	WIDTH	
	10	12
6	X	X
8	X	X
10	X	
12		X



303M Available Sizes (in.)					
HT	WIDTH				
	6	8	10	12	14
4		X			
6	X	X	X	X	X
8		X	X	X	X
10			X		X
12				X	



304M Available Sizes (in.)					
HT	WIDTH				
	6	8	10	12	14
6	X				
8		X			
10			X		
12				X	
14					X

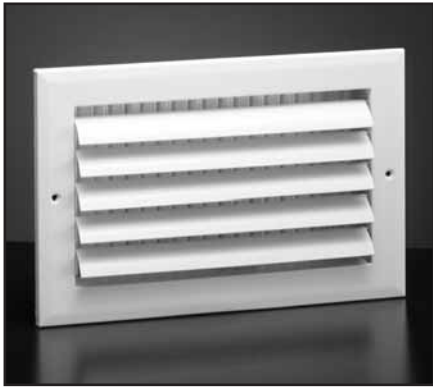

A611MS/A611OB Register

- Aluminum face/fin construction
- For sidewall or ceiling application
- One-way deflection
- One-way air pattern
- Adjustable curved blades increase deflection control
- Galvanized multi-shutter valve or opposed-blade damper
- Bright White finish

A611 Available Sizes (in.)					
HT	WIDTH				
		6	8	10	12
4		X	X	X	
6	X		X	X	X
8		X	X	X	X
10			X		
12				X	

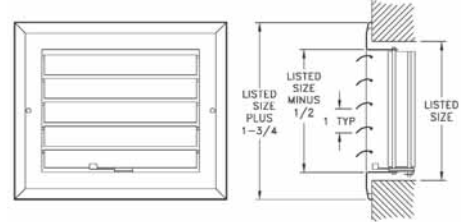
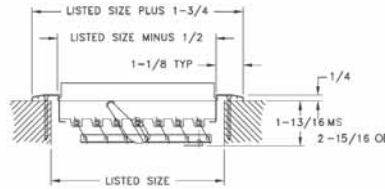

A612MS/A612OB Register

- Aluminum face/fin construction
- For sidewall or ceiling application
- Two-way deflection
- Two-way air pattern
- Adjustable curved blades increase deflection control
- Galvanized multi-shutter valve or opposed-blade damper
- Bright White finish

A612 Available Sizes (in.)				
HT	WIDTH			
		8	10	12
6		X	X	X
8	X		X	X
10		X		
12			X	

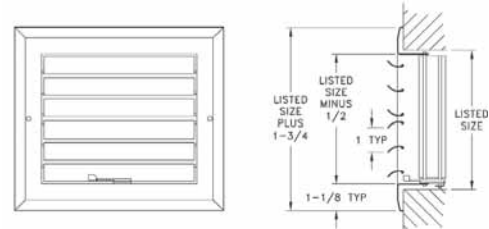
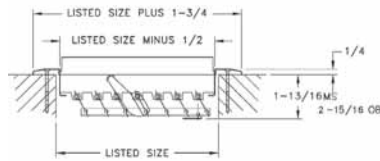

A613MS/A613OB Register

- Aluminum face/fin construction
- For sidewall or ceiling application
- Three-way deflection
- Three-way air pattern
- Adjustable curved blades increase deflection control
- Galvanized multi-shutter valve or opposed-blade damper
- Bright White finish

A613 Available Sizes (in.)					
HT	WIDTH				
		6	8	10	12
4		X	X		
6	X		X	X	X
8		X		X	X
10			X		
12				X	
14					X

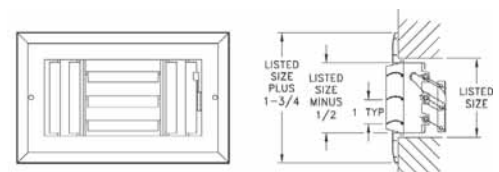
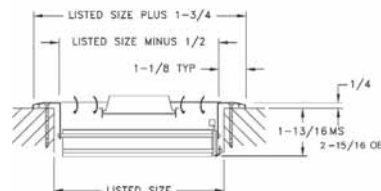



A614MS/A614OB Register

- Aluminum face/fin construction
- For sidewall or ceiling application
- Four-way deflection
- Four-way air pattern
- Adjustable curved blades increase deflection control
- Galvanized multi-shutter valve or opposed-blade damper
- Bright White finish

A614 Available Sizes (in.)					
HT	WIDTH				
		6	8	10	12
6	X				
8		X			
10			X		
12				X	
14					X

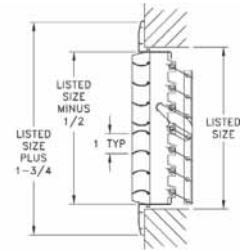
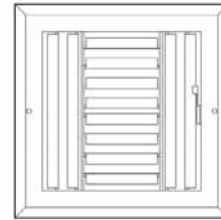
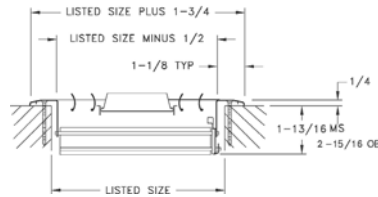

A618MS/A618OB Register

- Aluminum face/fin construction
- Adjustable straight fins provides individual deflection control
- Stamped face margins eliminate mitered corners and rough edges
- Galvanized multi-shutter valve or opposed-blade damper
- Bright White finish

A618 Available Sizes (in.)					
HT	WIDTH				
		6	8	10	12
4		X	X	X	X
6	X	X	X	X	X
8		X	X	X	X
10			X		
12				X	
14					X

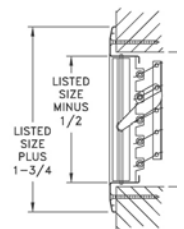
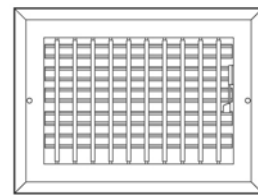
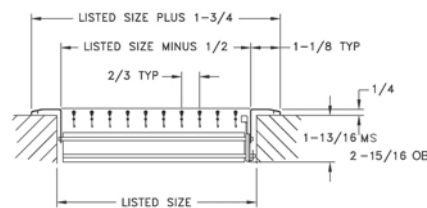

Sidewall Registers & Grilles



621 Register

- All-steel construction
- For heating or cooling
- Ideal for shallow duct installations
- Used for ceiling or sidewall installations
- Four-way deflection
- 1/3" spaced fins set at 20 degrees
- Multi-shutter valve
- 1-5/8" depth when fully opened
- Interlocking valve louvers for positive shut-off
- Bright White finish

621 Available Sizes (in.)						
HT	WIDTH					
	6	8	10	12	14	16
6	X					
8		X				
10			X			
12				X		
14					X	
16						X

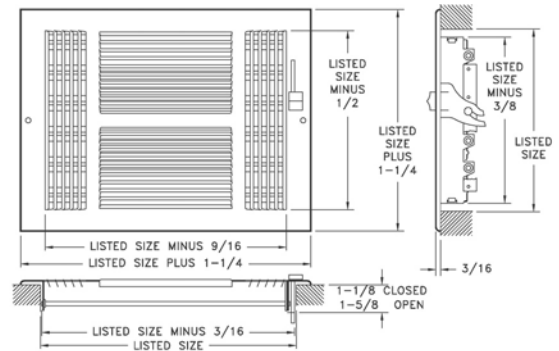

631 Register

- All-steel construction
- Ideal for shallow duct installations
- Used for ceiling or sidewall installations
- For heating or cooling
- Three-way deflection
- 1/3" spaced fins set at 20 degrees
- Multi-shutter valve
- 1-5/8" depth when fully opened
- Interlocking valve louvers for positive shut-off
- Bright White finish

631 Available Sizes (in.)					
HT	WIDTH				
	8	10	12	14	16
4	X	X	X	X	
6	X	X	X	X	X
8		X	X	X	

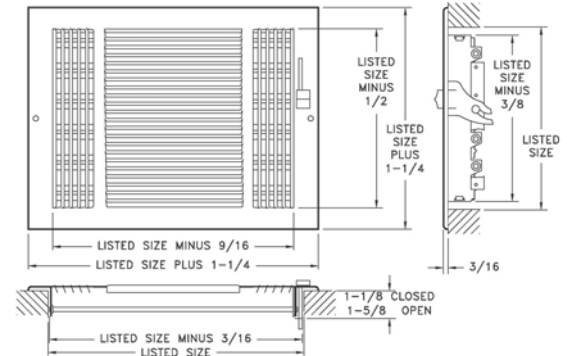

650 Return Air Grille

- All-steel construction
- 1/3" spaced fins set at 20 degrees
- Exceptional free area
- 5/16" Margin Turnback
- Bright White finish

650 Available Sizes (in.)											
HT	WIDTH										
	6	8	10	12	14	16	18	20	24	30	36
4	X	X	X	X	X	X		X	X	X	
6	X	X	X	X	X	X	X	X	X	X	X
8		X	X	X	X	X	X	X	X	X	X
10	X		X	X	X	X	X	X	X	X	X
12			X	X	X	X	X	X	X	X	X
14	X	X	X	X	X	X	X	X	X	X	
16			X	X	X	X	X	X	X	X	
18				X	X		X	X	X	X	
20			X	X	X	X		X	X	X	
24	X		X	X	X	X	X	X	X	X	
25								X			
30					X			X	X	X	

Contact factory for sizes not listed.

Note: When ordering, specify horizontal dimension first.

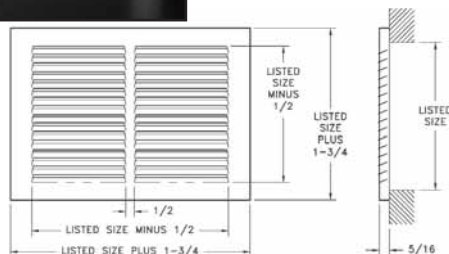



A650 Return Air Grille

- Aluminum construction
- 1/3" spaced fins set at 20 degrees
- Exceptional free area
- 5/16" Margin Turnback
- Bright White finish

A650 Available Sizes (in.)					
HT	WIDTH				
		6	10	12	14
6	X		X		
8				X	
10		X			
12			X		X
14				X	

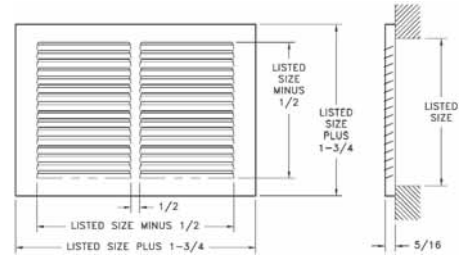

651 Register

- All-steel construction
- 1/3" spaced fins set at 20 degrees
- Positive volume-control damper
- Bright White finish

651 Available Sizes (in.)				
HT	WIDTH			
		8	10	12
4	X	X	X	
6	X	X	X	X

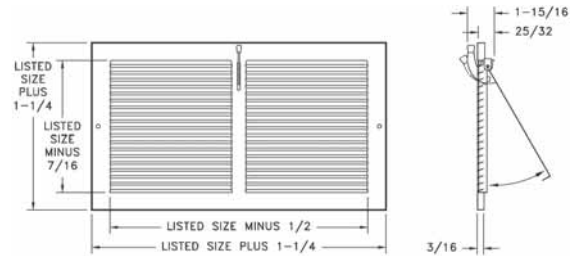

659 Return Air Filter Grille

- All-steel construction
- 1/3" spaced fins set at 20 degrees
- Effectively conceals filter
- Use standard 1" thick disposable filters (not included)
- Removable face for easy installation and cleaning
- Equipped with adjustable filter retainers
- Bright White finish

659 Standard Sizes (in.)										
HT	WIDTH									
		10	12	14	16	18	20	24	25	30
6		X	X				X		X	
8							X		X	
10	X					X	X		X	
12		X			X	X	X		X	
14			X			X	X	X	X	X
16				X		X	X	X	X	
18					X		X		X	
20	X	X	X	X		X	X	X	X	
24		X	X		X	X	X		X	
25			X	X		X		X		
30			X	X		X	X		X	
36							X			

Contact factory for sizes not listed.

Average face velocity = 390 FPM, based on filter capacity rating of 2 CFM per square inch of gross filter area. Free area averages 75% of grille core. For quick calculation free area (sq. in.) = listed width x height x .75.

Note: When ordering, specify horizontal dimension first.

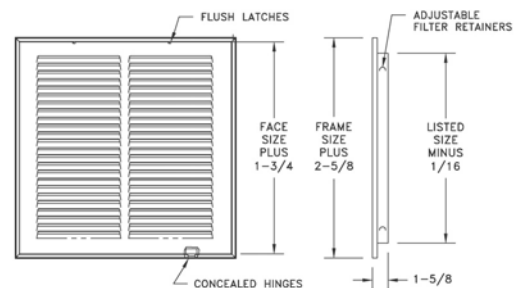

Sidewall Registers & Grilles

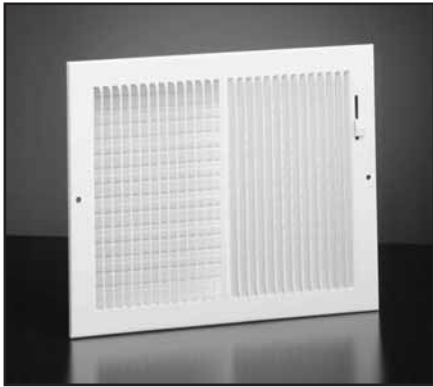

Available with fusible link option, limited sizes (not UL-listed or fire-rated)

661 Register

- All-steel construction
- Used for ceiling or sidewall installations
- For heating or cooling
- Ideal for shallow duct installations
- Two-way deflection
- 1/3" spaced fins set at 20 degrees
- Galvanized multi-shutter valve
- 1-5/8" depth when fully opened
- Interlocking valve louvers for positive shut-off
- Bright White finish

661 Standard Sizes (in.)										
HT	WIDTH									
	6	8	10	12	14	16	18	20	24	30
4	X	X	X	X	X	X			X	
5		X	X	X	X					
6	X	X	X	X	X	X	X	X	X	X
8		X	X	X	X	X	X	X	X	X
10			X	X						
12				X						

Note: When ordering sidewall products, specify horizontal (width) dimension first.

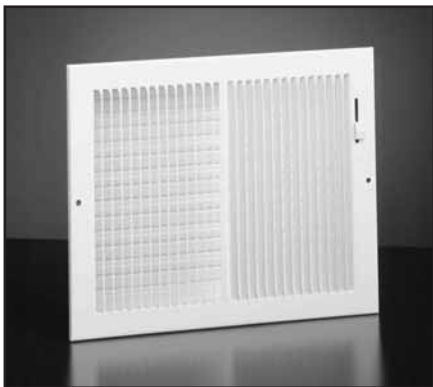
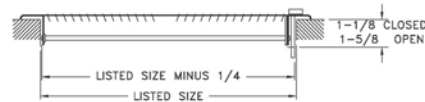
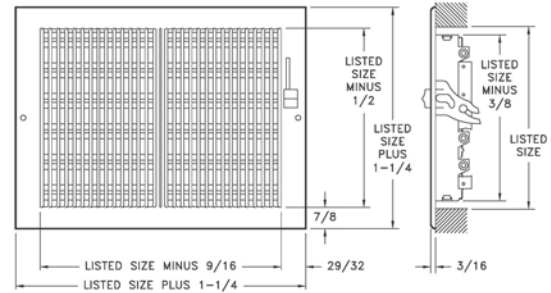

A661 Register

- Stamped aluminum construction
- Used for ceiling or sidewall installations
- For heating or cooling
- Ideal for shallow duct installations
- Two-way deflection
- 1/3" spaced fins set at 20 degrees
- Galvanized multi-shutter valve
- 1-5/8" depth when fully opened
- Interlocking valve louvers for positive shut-off
- Bright White finish

A661 Available Sizes (in.)				
HT	WIDTH			
	8	10	12	14
4	X	X	X	
6		X	X	X

Contact factory for sizes not listed.

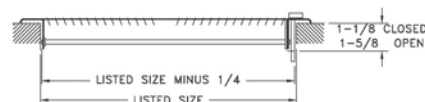
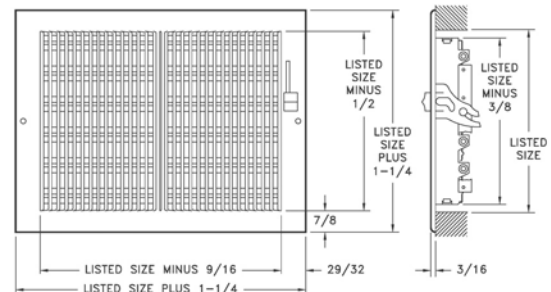



672 Return Air Grille

- All-steel construction
- 1/2" spaced fins set at 40 degrees
- Exceptional free area
- 5/16" Margin Turnback
- Bright White finish

672 Available Sizes (in.)												
HT	WIDTH											
	6	8	10	12	14	16	18	20	24	25	30	36
4	X	X	X	X	X		X		X		X	
6	X	X	X	X	X	X	X	X	X		X	
8		X	X	X	X	X	X	X	X		X	X
10			X	X	X	X	X	X	X		X	X
12	X		X	X	X	X	X	X	X		X	X
14		X	X	X	X	X	X	X	X		X	X
16				X	X	X	X	X	X	X	X	
18				X	X		X	X	X		X	
20			X	X	X	X		X	X	X	X	
24			X	X	X	X	X	X	X		X	
25						X	X		X	X		
30						X	X		X	X	X	

Contact factory for sizes not listed.

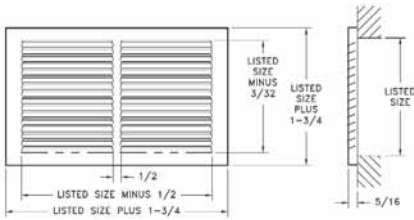

673 Return Air Filter Grille

- All-steel construction
- 1/2" spaced fins set at 40 degrees
- Effectively conceals filter
- Use standard 1" thick disposable filters (not included)
- Removable face for easy installation and cleaning
- Equipped with adjustable filter retainers
- Bright White finish

673 Standard Sizes (in.)												
HT	WIDTH											
	10	12	14	16	18	20	24	25	30	32	36	40
6	X		X				X		X			
8			X				X		X			
10	X					X	X		X			
12		X			X	X			X		X	
14			X			X	X	X	X		X	
16			X	X		X	X	X	X		X	
18		X			X	X	X		X			
20	X	X	X	X	X	X	X	X	X			X
24		X	X	X	X	X	X		X		X	
25			X	X		X		X		X		
30		X	X	X		X	X	X	X			
32				X		X		X				
36		X		X		X	X					
40						X						

Contact factory for sizes not listed.

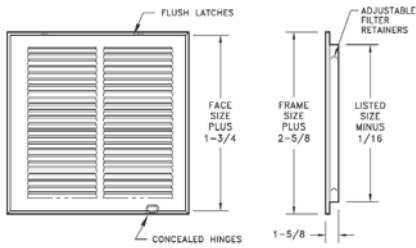

681 Register

- All-steel construction
- Used for ceiling or sidewall installations
- Ideal for shallow duct installations
- One-way deflection
- 1/2" spaced fins set at 40 degrees
- Multi-shutter valve
- 1-5/8" depth when fully opened
- Interlocking valve louvers for positive shut-off
- Bright White finish

681 Available Sizes (in.)							
HT	WIDTH						
	8	10	12	14	16	18	20
4	X						
6	X	X	X	X	X	X	X

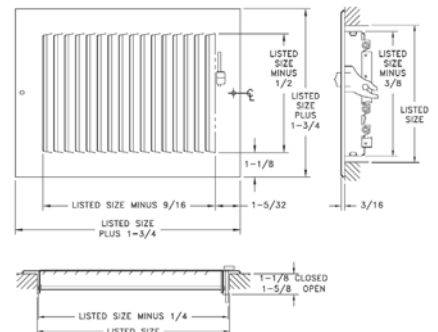



Available with fusible link option, limited sizes (not UL-listed or fire-rated)

682 Register

- All-steel construction
- Used for ceiling or sidewall installations
- Ideal for shallow duct installations
- Two-way deflection
- 1/2" spaced fins set at 40 degrees
- Multi-shutter valve
- 1-5/8" depth when fully opened
- Interlocking valve louvers for positive shut-off
- Bright White finish

682 Available Sizes (in.)									
HT	WIDTH								
	6	8	10	12	14	16	18	20	24
4	X	X	X	X	X				
5			X	X					
6	X	X	X	X	X	X	X	X	X
8		X	X	X	X	X	X	X	X
10			X						
12				X					

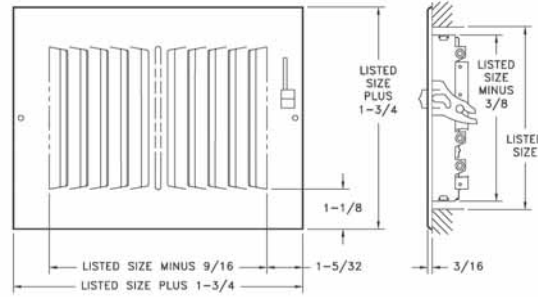

683 Register

- All-steel construction
- Used for ceiling or sidewall installations
- Ideal for shallow duct installations
- Three-way deflection
- 1/2" spaced fins set at 40 degrees
- Multi-shutter valve
- 1-5/8" depth when fully opened
- Interlocking valve louvers for positive shut-off
- Bright White finish

683 Available Sizes (in.)						
HT	WIDTH					
	6	8	10	12	14	16
4		X	X	X	X	
6	X	X	X	X	X	X
8		X	X	X	X	X
10			X			
12				X		
14					X	
16						X

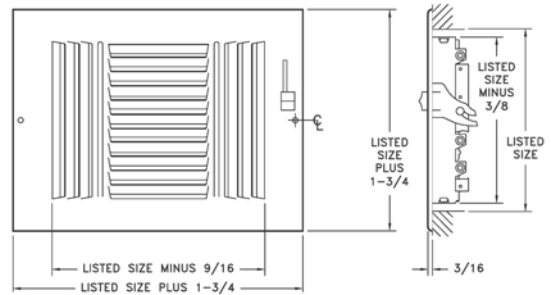

684 Register

- All-steel construction
- Used for ceiling or sidewall installations
- Ideal for shallow duct installations
- Four-way deflection
- 1/2" spaced fins set at 40 degrees
- Multi-shutter valve
- 1-5/8" depth when fully opened
- Interlocking valve louvers for positive shut-off
- Listed heights 10" and larger require double valves
- Bright White finish

684 Available Sizes (in.)						
HT	WIDTH					
	6	8	10	12	14	16
6	X					
8		X				
10			X			
12				X		
14					X	
16						X

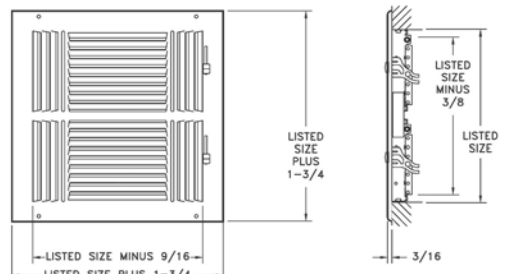



680M Series Register

- All-steel construction with metal handle
- Stamped, straight-blade supply register with multi-louver damper for ceiling or sidewall installation
- Stamped, one-piece face with multi-louver damper for volume control
- Fins spaced on 1/2" centers at 40 degrees
- Available in 1-way, 2-way, 3-way and 4-way airflow patterns
- Bright White finish

681M Available Sizes (in.)							
HT	WIDTH						
	8	10	12	14	16	18	20
4	X						
6		X	X	X	X		X
8			X				

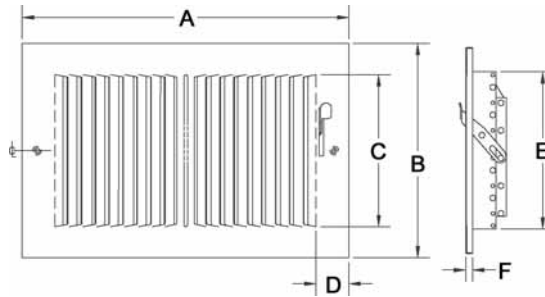

A	B	C	D	E	F
LISTED SIZE PLUS 1-3/4"	LISTED SIZE PLUS 1-3/4"	LISTED SIZE MINUS 5/8"	1-3/16"	LISTED SIZE MINUS 1/4"	5/16"



682M Available Sizes (in.)						
HT	WIDTH					
	6	8	10	12	14	16
4	X	X	X	X	X	
6	X	X	X	X	X	X
8		X	X	X	X	X
10			X		X	



683M Available Sizes (in.)						
HT	WIDTH					
	6	8	10	12	14	16
4		X	X	X	X	
6	X	X	X	X	X	X
8		X	X	X	X	X
10			X		X	
12				X		



684M Available Sizes (in.)					
HT	WIDTH				
	6	8	10	12	14
6	X				
8		X			
10			X		
12				X	
14					X



RZ682 Plastic Sidewall/ Ceiling Register

- Engineered polymer construction
- Two-way deflection
- Traditional styling
- Integral multi-shutter damper with easy-to-use damper handle
- For heating or cooling applications
- Bright White finish

RZ682 Available Sizes (in.)				
HT	WIDTH			
		8	10	12
4	X	X		
6		X	X	X
8		X		X

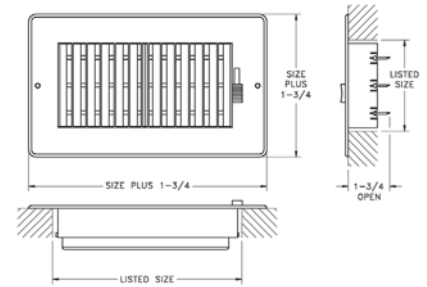

RZ683 Plastic Sidewall/Ceiling Register

- Engineered polymer construction
- Three-way deflection
- Traditional styling
- Integral multi-shutter damper with easy-to-use damper handle
- For heating or cooling applications
- Bright White finish

RZ683 Available Sizes (in.)				
HT	WIDTH			
		8	10	12
4	X			
6		X	X	X
8		X		X

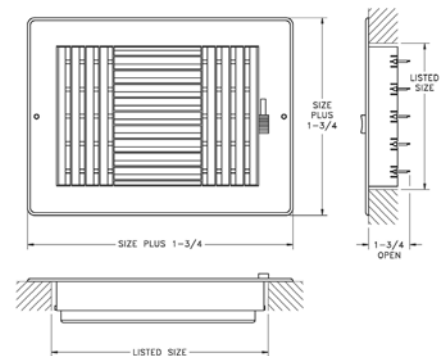

RZ684 Plastic Sidewall/Ceiling Register

- Engineered polymer construction
- Four-way deflection
- Traditional styling
- Integral multi-shutter damper with easy-to-use damper handle
- For heating or cooling applications
- Bright White finish

RZ684 Available Sizes (in.)				
HT	WIDTH			
		6	8	10
6	X			
8		X		
10			X	
12				X

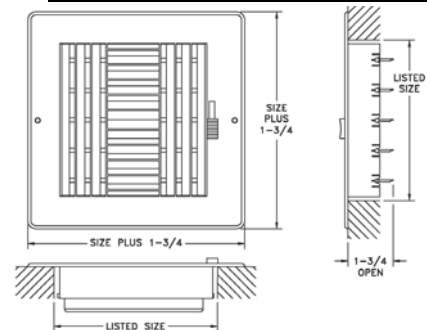

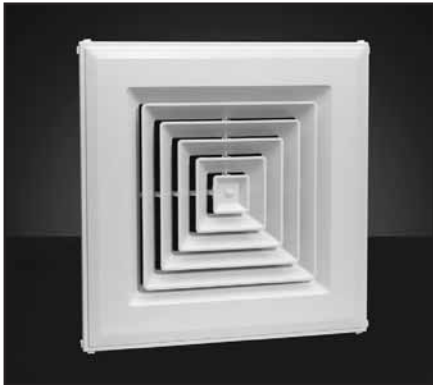

RZSRT Plastic T-Bar Directional Diffuser

- Engineered polymer construction
- Four-way deflection
- Available with RZSR square-to-round, ordered separately
- Bright White finish
- Contains metal screws

RZSRT Available Size (in.)
24 x 24

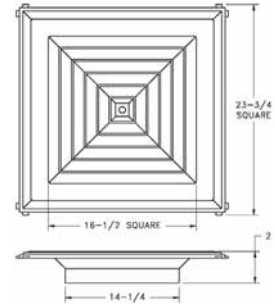

RZMCDST Plastic T-Bar Modular Core Diffuser

- Engineered polymer construction
- Modular cores provide 1-, 2-, 3- or 4-way horizontal air patterns
- Removable modules provide easy access to accessories
- Available with RZBP back panel, ordered separately
- Bright White finish

RZMCDST Available Size (in.)
24 x 24

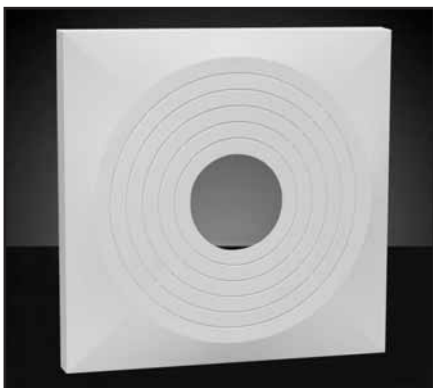
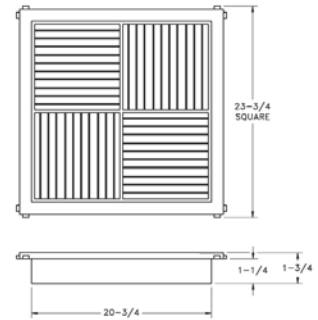

RZBP Plastic Back Panel

- Engineered polymer construction
- Use 6400 Series Tab Collar
- Bright White finish

RZBP Available Size (in.)
24 x 24

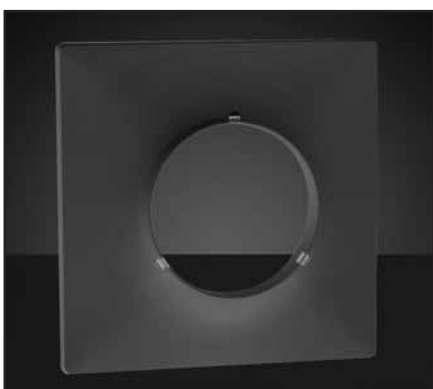
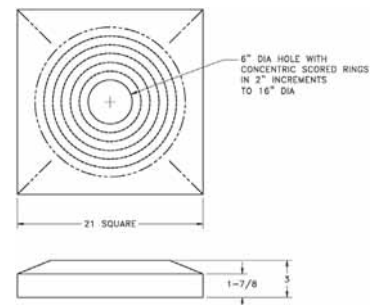

RZSR Plastic Square-to-Round Transition

- Engineered polymer construction
- Allows flex duct installation with square neck diffusers
- Black finish
- Contains metal screws/clips
- Can use RD damper

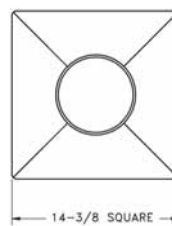

RZSR Available Sizes (in.)	
Square Size	Round Neck
24 x 24	6
24 x 24	8
24 x 24	10
24 x 24	12
24 x 24	14

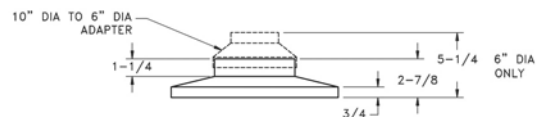

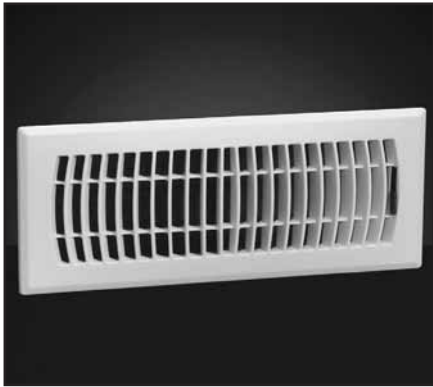

RZ421 Plastic Floor Diffuser

- Solid ABS construction for floor use
- Multi-angled fins for fan pattern of air distribution
- Foot-operated, opposed-blade damper
- Bright White or Golden Sand finish

RZ421 Available Sizes (in.)		
HT	WIDTH	
		10
2		X
4	X	X

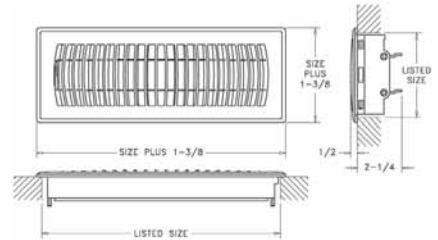

RZ500 Plastic Square Ceiling Diffuser

- Engineered polymer construction
- 12"x12" face
- 6", 7" and 8" collars included
- Ratcheting cam lock—install without screws
- Removable core and integral damper
- Available in 4-way, 3-way and 2-way corner
- Bright White finish
- Contains metal parts

RZ500 Available Size (in.)
12 x 12

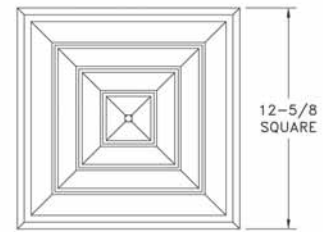
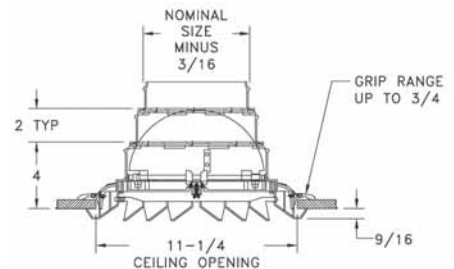

RZ503



RZ504



RZ505



RZ16 Plastic Round Ceiling Diffuser

- Engineered polymer construction
- 12" round face
- 6", 7" and 8" collars included
- Ratcheting cam lock—install without screws
- Removable core and integral damper
- Bright White finish
- Contains metal parts

RZ16 Available Size (in.)
12

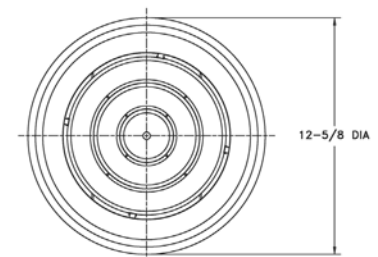
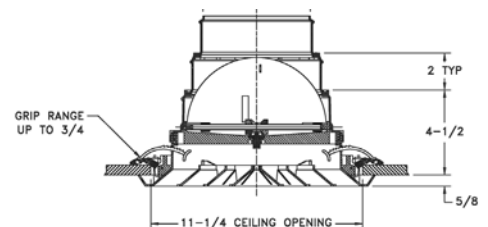

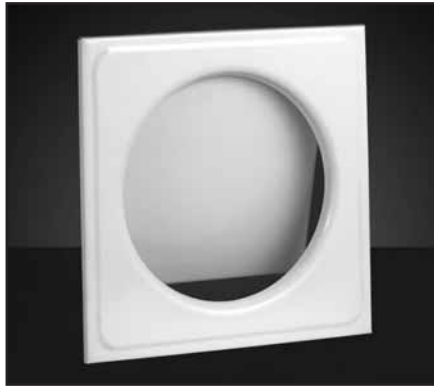

Laundry Chute Door (LCD)

- Steel construction
- Spring-hinged, push-in door
- Quiet closing, inner rubber guards
- White, baked enamel finish
- Two sizes available, 10" and 12"
- Not fire-rated

Laundry Chute Door Sizes (in.)
10, 12

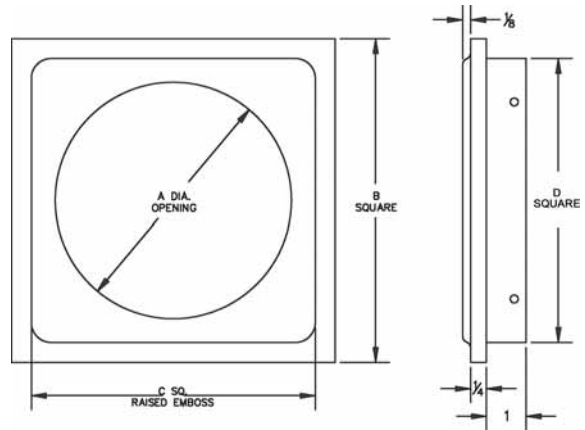

Model	A Diameter	B Square	C Square	D Square
LCD10	8½	12	11	9¾
LCD12	10	13¼	12¼	11¼

Ceiling Diffusers



11 Duct Ring

- All-steel construction
- For installation of #16 diffuser when not using a damper
- Golden Sand enamel finish

11 Available Sizes (in.)	
6, 8, 10, 12, 14, 18	

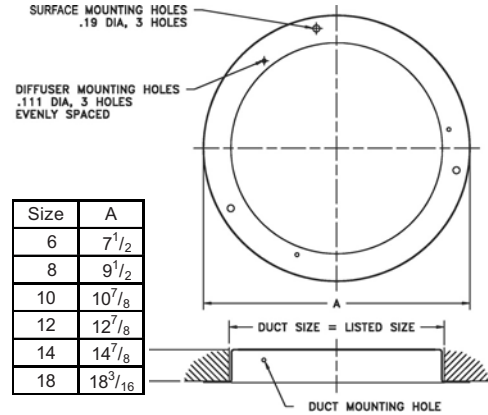

12 Butterfly Damper

- All-steel construction
- Controls air volume evenly over entire #16 diffuser
- Removable knob operator for adjustment from closed to fully open
- Golden Sand enamel finish

12 Available Sizes (in.)		
Size	A	B
6	7 ¹ / ₂	3 ¹¹ / ₁₆
8	9 ¹ / ₂	4 ¹¹ / ₁₆
10	10 ⁷ / ₈	5 ¹¹ / ₁₆
12	12 ⁷ / ₈	6 ¹¹ / ₁₆
14	14 ⁷ / ₈	7 ¹¹ / ₁₆
18	18 ³ / ₁₆	9 ¹¹ / ₁₆

Note: Knob permits diffuser to be held in position while attaching face screws.

Only available in sizes shown

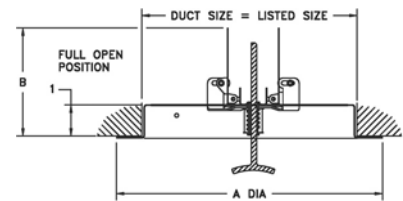

16 Ceiling Diffuser

- All-steel construction
- Step-down diffuser rings deflect air stream 360 degrees
- Bright White finish

16 Available Sizes (in.)	
6, 8, 10, 12, 14, 18	

Only available in sizes shown

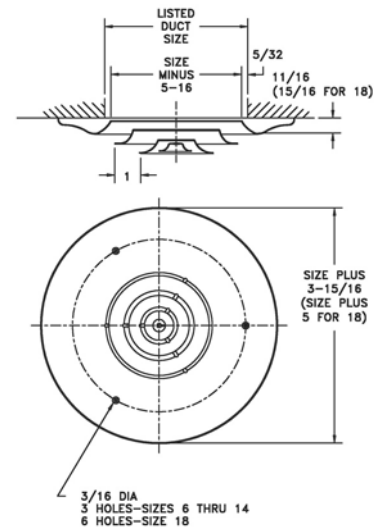

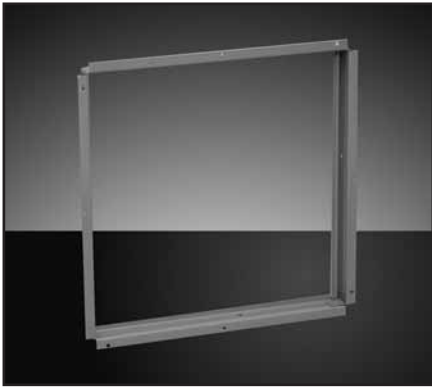

21 Installation Frame

- All-steel construction
- Golden Sand enamel finish

Note: Not furnished with #24 diffuser.

Not required when using 22 Butterfly Damper or 23 Opposed Blade Damper.

Cannot be used with SD and SDD.

21 Available Sizes (in.)	
6, 8, 10, 12, 14, 16, 18, 20, 22, 24	

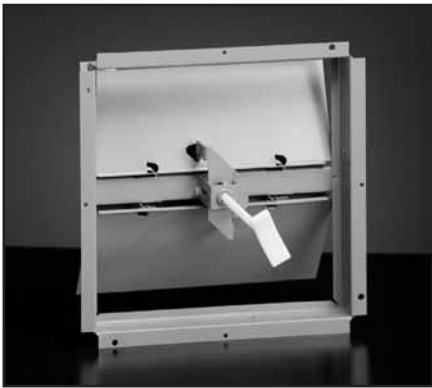
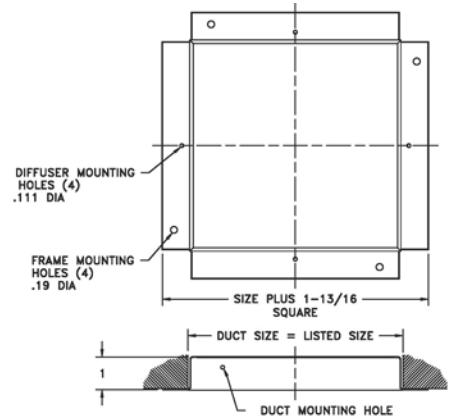

22 Butterfly Damper

- All-steel construction
- Used with #24 Ceiling Diffuser
- Knob control for quick adjustment (removable)
- Installation flange included
- Golden Sand enamel finish

Only available in sizes shown.

22 Available Sizes (in.)		
Size	A	B
6	6 ³ / ₁₆	3 ¹¹ / ₁₆
8	8 ³ / ₁₆	4 ¹¹ / ₁₆
10	10 ³ / ₁₆	5 ¹¹ / ₁₆
12	12 ³ / ₁₆	6 ¹¹ / ₁₆
14	14 ³ / ₁₆	7 ¹¹ / ₁₆

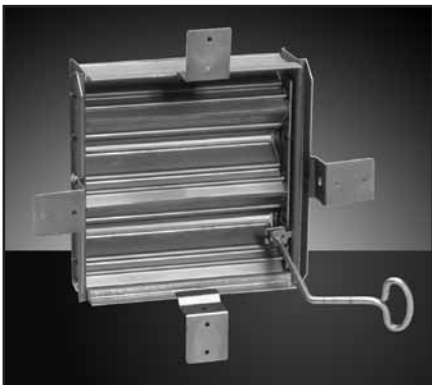
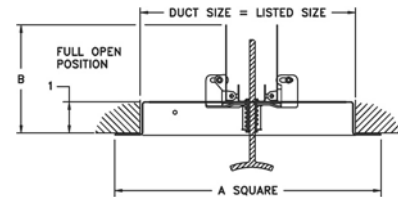

23 Opposed-Blade Damper

- All-steel construction
- Used with #24 Ceiling Diffuser
- Controls air volume over entire diffuser
- Key operated
- Mill finish

23 Available Sizes (in.)	
6, 8, 10, 12, 14, 16, 18, 20, 22, 24	

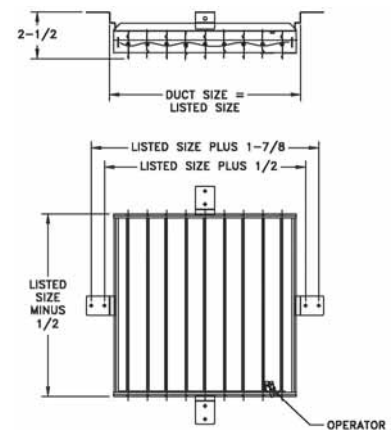



24 Square Ceiling Diffuser

- All-steel construction
- Step-down face deflects air stream 360 degrees
- Bright White finish

Only available in sizes shown.

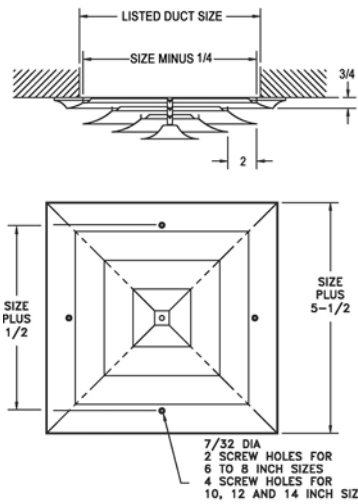

24 Ceiling Diffuser (in.)		
Size	Free Area Sq. Inches	No. of Cones
6	41	3
8	65	3
10	84	3
12	123	4
14	152	4
16	199	5
18	236	5
20	293	6
22	338	6
24	404	7



T-Bar Panel available (see page 34)

A501MS/A501OB Square Ceiling Diffuser

- Extruded aluminum construction
- Cores flush with margin
- One-way air diffusion
- Face mount for easy installation
- For sidewall or ceiling application
- Multi-shutter or opposed-blade dampers - aluminum
- Inconspicuous fingertip lever for air volume control
- Bright White finish

A501MS/A501OB (in.)					
HT	WIDTH				
	6	8	10	12	14
6	X				
8		X			
10			X		
12				X	
14					X

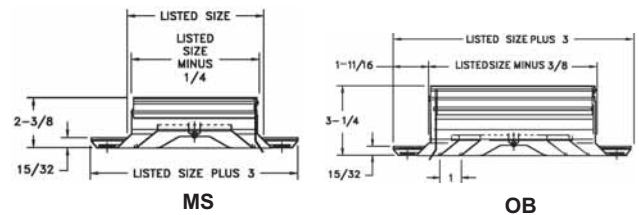

T-Bar Panel available (see page 34)

A502MS/A502OB Square Ceiling Diffuser

- Extruded aluminum construction
- Cores flush with margin
- Two-way air diffusion
- Face mount for easy installation
- For sidewall or ceiling application
- Multi-shutter or opposed-blade dampers - aluminum
- Inconspicuous fingertip lever for air volume control
- Bright White

A502MS/A502OB (in.)					
HT	WIDTH				
	6	8	10	12	14
6	X				
8		X			
10			X		
12				X	
14					X

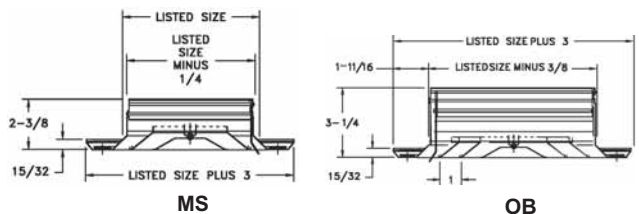



T-Bar Panel available (see page 34)

A503MS/A503OB Square Ceiling Diffuser

- Extruded aluminum construction
- Cores flush with margin
- Three-way air diffusion
- Face mount for easy installation
- For sidewall or ceiling application
- Multi-shutter or opposed-blade dampers - aluminum
- Inconspicuous fingertip lever for air volume control
- Bright White finish

A503MS/A503OB (in.)					
HT	WIDTH				
	6	8	10	12	14
6	X				
8		X			
10			X		
12				X	
14					X

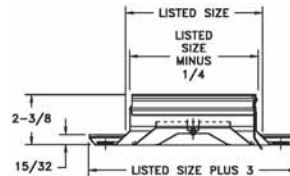

MS

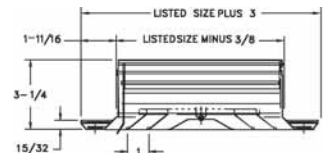

OB



T-Bar Panel available (see page 34)

A504MS/A504OB Square Ceiling Diffuser

- Extruded aluminum construction
- Cores flush with margin
- Four-way air diffusion
- Face mount for easy installation
- For sidewall or ceiling application
- Multi-shutter or opposed-blade dampers - aluminum
- Inconspicuous fingertip lever for air volume control
- Bright White finish

A504MS/A504OB (in.)					
HT	WIDTH				
	6	8	10	12	14
6	X				
8		X			
10			X		
12				X	
14					X

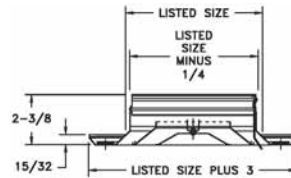

MS

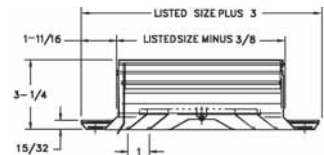

OB



T-Bar Panel available (see page 34)

A505MS/A505OB Square Ceiling Diffuser

- Extruded aluminum construction
- Cores flush with margin
- Two-way corner air diffusion
- Face mount for easy installation
- For sidewall or ceiling application
- Multi-shutter or opposed-blade dampers - aluminum
- Inconspicuous fingertip lever for air volume control
- Bright White finish

A505MS/A505OB (in.)					
HT	WIDTH				
	6	8	10	12	14
6	X				
8		X			
10			X		
12				X	
14					X

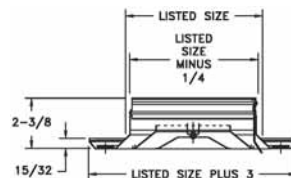

MS

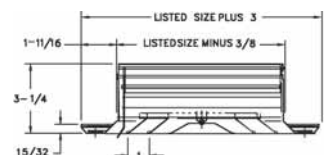

OB

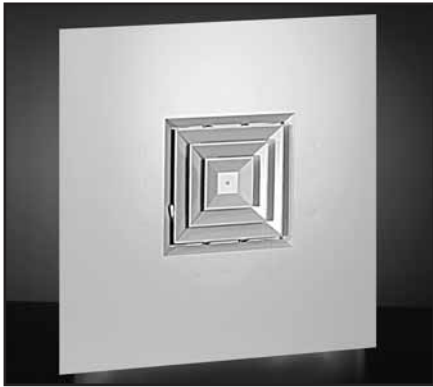

Shown: A504MS/A504OB
four-way deflection

A500P T-Bar Panel for A500 Series Diffusers

- Steel construction
- Adapts A500 diffuser to T-Bar installation
- Diffuser snaps in behind panel for clean appearance
- Diffuser must be ordered separately
- Bright White finish

A500P T-Bar Panel Available Sizes (in.)

Opening 6 to 14
Overall 23³/₄ x 23³/₄

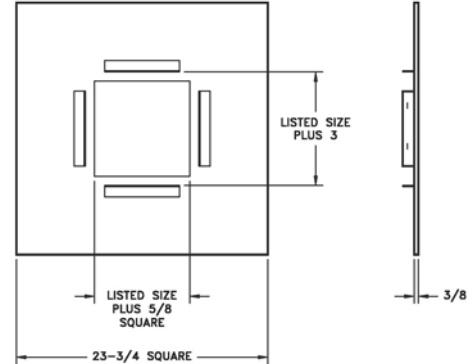

SD/SDD Diffuser

- Extruded aluminum construction
- Annular rings to provide minimum resistance
- Face only on SD
- Opposed-blade aluminum damper available with SDD
- Bright White finish

SD/SDD Available Sizes (in.)

HT	WIDTH							
	6	8	10	12	14	16	18	20
6	X							
8		X						
10			X					
12				X				
14					X			
16						X		
18							X	
20								X

Only available in sizes shown

Note: SDD in size 20" x 20" is furnished with two separate dampers and operators.

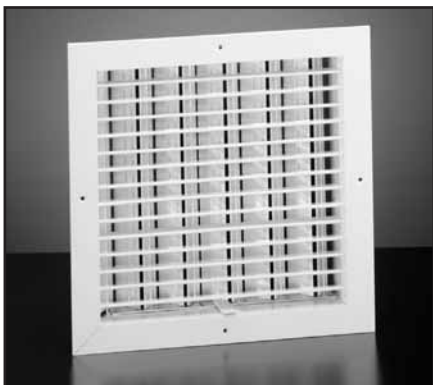
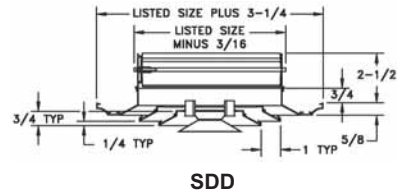

ECFM Aluminum Diffuser

- Integral opposed-blade damper with lever for face operation
- Center mullions provided on sizes over 18" x 18"
- All extruded aluminum construction
- Furnished with mounting screws and gasket
- Bright White finish

ECFM Available Sizes (in.)

12x12, 14x14, 16x16, 18x18, 20x20, 22x22, 24x24

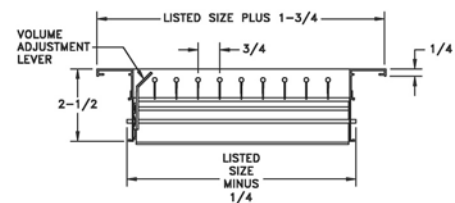



ECBX 4-way Ceiling Diffuser Box

ECBX Available Sizes (in.)
14x14, 18x18, 20x20, 22x22, 24x24, 30x30, 36x36

- Adjustable dampers provide directional airflow or closure capabilities
- Mounting holes provided for easy installation
- Heavy-duty steel construction
- For 24x24 T-Bar installation, order ECBX-T
- Bright White finish
- Available in T-Bar version, see page 102

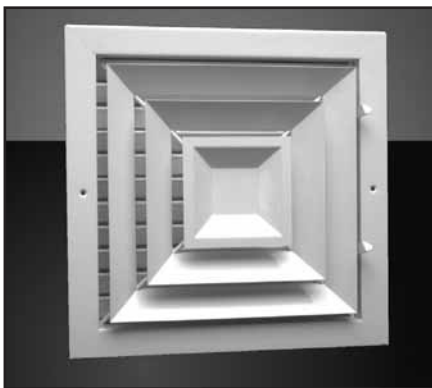
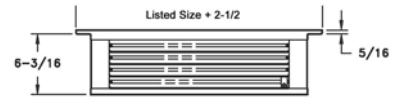

ECSD/ECSDD Diffuser

ECSD/ECSDD Available Sizes (in.)
14x14, 16x16, 18x18, 20x20

- Heavy-duty steel construction
- For evaporative coolers or central blower systems
- Step-down design louvers provide four-way air delivery
- Face only ECSD with slide in plate for off-season closure
- Multi-shutter damper on ECSDD
- Countersunk mounting holes for flush appearance with screws provided
- Bright White finish

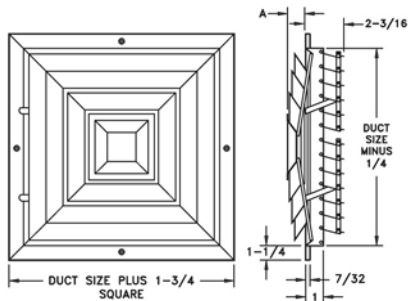
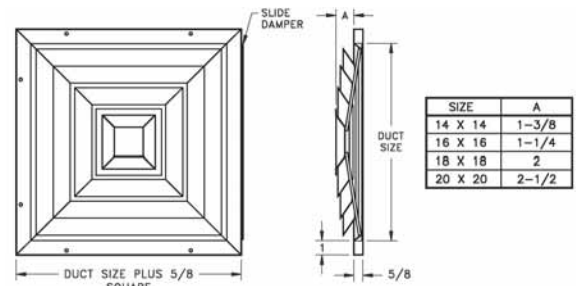

ECHVD Evaporative Cooler Diffuser

ECHVD Available Sizes (in.)
6x6, 8x8, 10x10, 12x12, 14x14, 16x16, 18x18, 20x20, 22x22, 24x24

- Heavy-duty steel construction
- Durable finish for high quality appearance and corrosion resistance
- Two-way deflection
- Bright White finish

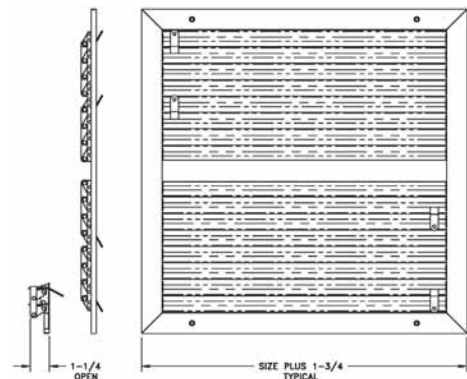

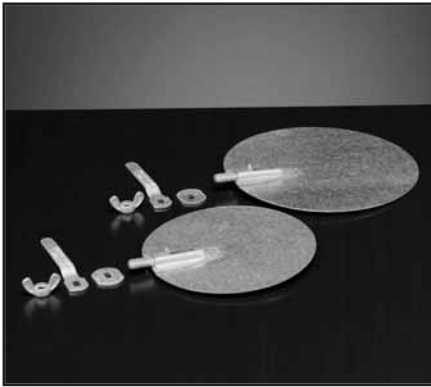

65 & 66 Damper

- For use in 5" (65) to 6" (66) round pipe
- Furnished with handle, washer and wing nut
- Has one bearing

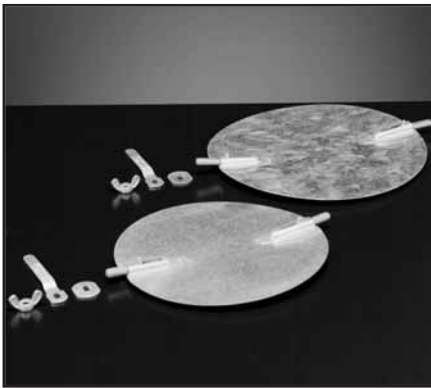

607/608 Damper

- Two bearings
- For use in 7" (607) to 8" (608) round pipe
- Furnished with handle, washer and wing nut

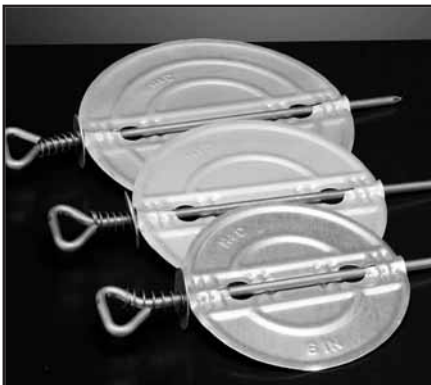

506/507/508 Damper

- Steel warm-air damper
- 6" (506), 7" (507) and 8" (508) sizes
- Spindle is reversible and may be inserted from either end
- The heavy spring holds damper securely under most conditions



69 Regulator Set

- 704 Washer
- 705 Handle
- 706 Wing Nut
- 708 (one) 5/16" Bearing
- For small dampers

69 and 70 regulator sets are furnished with retractable bolt bearing for fast, easy assembly. Merely slip bearing over edge of damper at the bearing line, lay the bearing on any firm surface, and drive the prong through the damper. The prong firmly clinches the bearing to the damper. 5/16" bearings are ample for most damper installations. Maximum damper thickness: .022, 22 gauge galv.



70 Regulator Set

- 704 Washer
- 705 Handle
- 706 Wing Nut
- 708 (two) 5/16" Bearings
- For large dampers

69 and 70 regulator sets are furnished with retractable bolt bearing for fast, easy assembly. Merely slip bearing over edge of damper at the bearing line, lay the bearing on any firm surface, and drive the prong through the damper. The prong firmly clinches the bearing to the damper. 5/16" bearings are ample for most damper installations. Maximum damper thickness: .022, 22 gauge galv.



80-3/8 Regulator Set

- 60 - 3/8" Regulator
- 56 - 3/8" Square Shank Bearing
- 80 - 3/8" Dial Regulator set
- For large dampers

80-3/8 regular sets are furnished with two solid bearings, six rivets and three sheet metal screws. Dial regulator, inner disc, handle, bolt and wing nut assembled and packaged individually. Inner disc prevents air leakage.



102 Damper Tip

- Fixed bearing
- Has same fastening features as No. 708 retractable bolt bearing

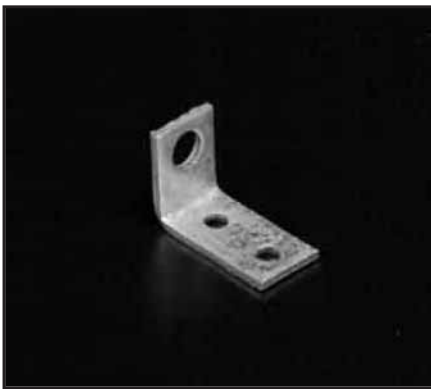

2 Casing Clip

- For fastening casings and drawbands
- 14-gauge steel

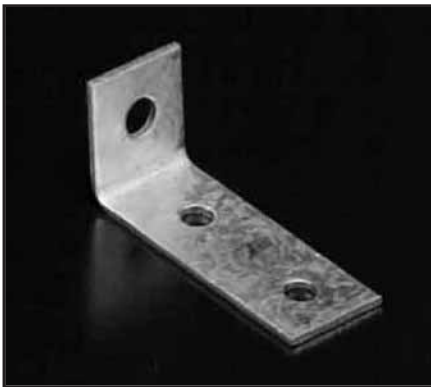

27 Casing Clip

- For fastening casings and drawbands
- 16-gauge steel

Accessories

- 704 Washer
- 705 Handle
- 706 Wing Nut
- 708 - 5/16" Bearing only
- 60 - 3/8" Regulator only (square shank) - Same as furnished with 80-3/8 Regulator Set. Required separately when 3/8" square rod is used instead of bearings. Use No. 65 - 3/8" damper rod clips with both 1/4" and 3/8" square rod to fasten damper to rod.
- 65 - 3/8" Rod Clip ("U" Bolt) - Used with both 1/4" and 3/8" square rod to fasten damper to rod.