



Governale®



Cast Iron Radiation

The Comfort and Style of Hydronic Heat

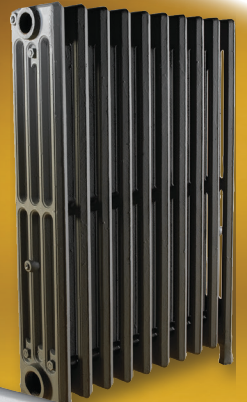

COMFORT & STYLE... of Hydronic Heat!

Governale's wide range of heat distribution products, from radiators to cabinets and elements to a full line of accessories, is your answer to heating when combining comfort and style. By offering this full line, Governale is able to provide homeowners, like you, all the resources of a recognized industry leader with a reputation for quality and dependability that dates back to 1856. Governale also supports your local contractor with individual, attentive and prompt service which means better service for you.



And it doesn't stop there—since the Governale team is equipped with the technical and practical knowledge that only comes from years of experience, we truly understand the importance of quality heating systems. Quality is our primary concern.

Combining a full product line with a rich history and committed staff makes Governale the recognized leader in high quality heating units for steam and hot water systems.

VICTORIA™ The Stylish Cast Iron Radiator



The design of the Victoria radiator is exceptionally functional, as well as beautiful. Providing efficient heat transfer and the timeless styling of a bygone era, these elegant radiators are in a class by themselves. For the ultimate in replacement radiators, especially in period-home renovation projects, look no further than the Victoria.

- Durable cast iron construction with ornate surface detail
- Pre-painted and ready to install
- Cast iron provides very quiet operation
- Stylish brass valves available

Dimensions

- All steam vent tappings 1/8" NPT
- All pipe tappings 1" NPT
- Maximum working pressure: 15 psi steam, 30 psi water
- Water content - .61 gal/section
- Output based on room temperature of 70°F
- Special tool required for disassembly/assembly
- Rating square ft./section = 3.05

VALVES & ACCESSORIES

8054005	Brass Isolation Valve
8054006	Brass Balancing Valve
104531-01	3/4" Bushing Kit (left)
104527-01	3/4" Bushing Kit (right)
104532-01	1" Bushing Kit (left)
104528-01	1" Bushing Kit (right)
8054003	Assembling Kit
6054001	Assembling Tool
104530-01	1-1/4" Plug Kit (left)
104526-01	1-1/4" Plug Kit (right)

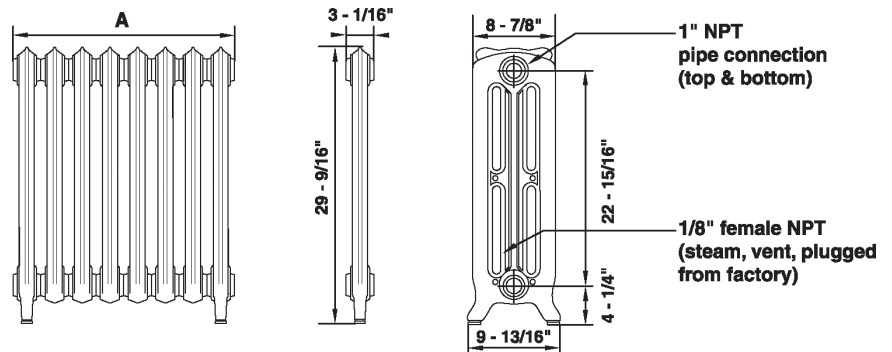

NOTE: Sections use British straight pipe threads and will not adapt to NPT threads without the use of 3/4" or 1" bushing kits

Ratings

MODEL NO.	CR3CF	CR5CF	CR7CF	CR9CF	CR5AF	8074011
Number of Sections	3	5	7	9	5 Interm.	End Sect. w/vent
Width 'A' (inches)	9.2	15.4	21.5	27.6	15.4	3.1
Sq. Ft.-EDR	9.2	15.3	21.4	27.5	15.3	3.1
Water Output BTUH/Hr. (180°F Avg. Temp.)	1564	2618	3655	4692	2618	524
Steam Output BTUH/Hr. (215°F Avg. Temp.)	2208	3672	5136	6600	3672	734
Shipping Weight	77	129	177	226	129	26

GOV-RAY™ Recessed Cast Iron Radiator



Gov-Ray radiators can be used as replacement recessed radiators for cabinets and other interior structures, or as standalone heat distributors. The radiant heat combines with convected heat to shield outer walls and windows, thus stopping cold air infiltration into living spaces.

- Low profile design enhances space efficiency
- Snap-on grilles are recessed for attractive, unobtrusive installation
- Cast iron provides very quiet operation
- Designed to draw cool air in through the bottom and warm air out through the top ports

Dimensions

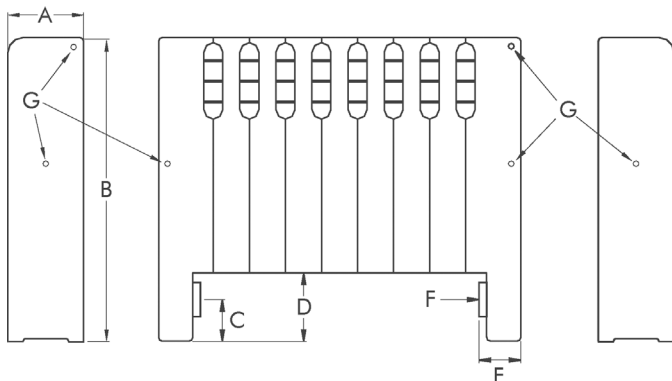

A	5"
B	20"
C	2-3/4"
D	4-1/2"
E	1-7/8"
F	*1-1/4" NPT
G	*1/8" NPT

- All steam vent tappings 1/8" NPT
- All bottom tappings 1-1/4" NPT
- Recess should be 1/2" longer & 1/4" higher than radiator
- Maximum working pressure: 15 psi steam, 30 psi water
- Length is 2-1/4" per section
- Water content 0.15 gal./section

Ratings per Section

STEAM	540 BTUH
WATER TEMP at °F	
220	562 BTU
215	540 BTU
210	517 BTU
200	472 BTU
190	427 BTU
180	382 BTU
170	337 BTU
160	292 BTU
150	247 BTU

Ratings

Size No. of Sections	4	6	8	10	12	14	16	18	20	22	24	26	28	30	32	34
Overall Length	9	13-1/2	18	22-1/2	27	31-1/2	36	40-1/2	45	49-1/2	54	58-1/2	63	67-1/2	72	76-1/2
Free Standing Rating Sq/Ft	9.0	13.5V	18	22.5	27	31.5	36	40.5	45	49.5	54	58.5	63	67.5	72	76.5

IMPORTANT: When recessed add 10% to room requirements before selecting radiator size.





Recognized by most people as a “traditional” radiator, the Gov-Free provides heat in a low profile package. Radiant heat combines with convected heat to shield outer walls and windows, thus stopping cold air infiltration into living spaces.

- Free-standing
- Lower and slimmer than most conventional radiators
- Cast iron provides very quiet operation
- Offered in 3 sizes and up to 56 sections, which easily enables the installation of multiple units
- Efficient radiator replacement option
- Suitable for water or steam applications

Optional Pedestals for Gov-Free are also available



Ratings

Dimensions/Specifications

Section	Size (inches)		
	4 x 19	4 x 25	6 x 25
A	15-7/16	21-7/16	21-7/16
B/C	4-7/16	4-7/16	6-15/16
D	2-1/2	2-1/2	2-1/2
E	1-1/16	1-1/16	1-1/16
F	19	25	25
H	17-13/16	23-13/16	23-13/16
Water Content (gal./sect)	0.08	0.12	0.17

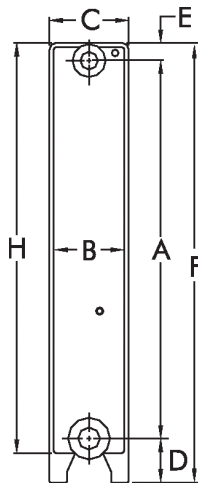

- Top tapings 1" NPT
- Bottom tapings 1-1/4" NPT
- All air vent tapings 1/8" NPT
- Maximum working pressure 15 psi steam, 30 psi water

Ratings per Section

STEAM	4 x 19	4 x 25	6 x 25
		384 BTU	480 BTU

WATER TEMP at °F	4 x 19	4 x 25	6 x 25
220	400 BTU	500 BTU	750 BTU
215	384 BTU	480 BTU	720 BTU
210	368 BTU	460 BTU	690 BTU
200	336 BTU	420 BTU	630 BTU
190	304 BTU	380 BTU	570 BTU
180	272 BTU	340 BTU	510 BTU
170	240 BTU	300 BTU	450 BTU
160	208 BTU	260 BTU	390 BTU
150	176 BTU	220 BTU	330 BTU

Number of Sections	Length 1-3/4" per Section (inches)	Square Feet - EDR		
		4-Tube		6-Tube
		19" High	25" High	25" High
4	7	6.4	8	12
6	10-1/2	9.6	12	18
8	14	12.8	16	24
10	17-1/2	16.0	20	30
12	21	19.2	24	36
14	24-1/2	22.4	28	42
16	28	25.6	32	48
18	31-1/2	28.8	36	54
20	35	32.0	40	60
22	38-1/2	35.2	44	66
24	42	38.4	48	72
26	45-1/2	41.6	52	78
28	49	44.8	56	84
30	52-1/2	48.0	60	90
32	56	51.2	64	96
34	59-1/2	54.4	68	102
36	63	57.6	72	108
38	66-1/2	60.8	76	114
40	70	64.0	80	120
42	73-1/2	67.2	84	126
44	77	70.4	88	132
46	80-1/2	73.6	92	138
48	84	76.8	96	144
50	87-1/2	80.0	100	150
52	91	83.2	104	156
54	94-1/2	86.4	108	162
56	98	89.6	112	168

GOV-BOARD™ Unique Integral Cast Iron Radiator

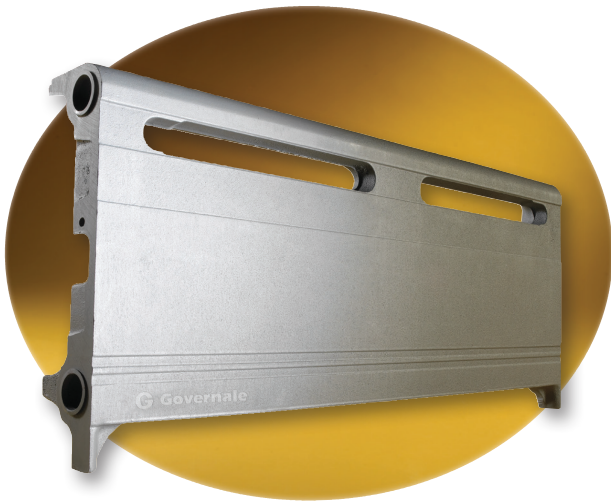

Gov-Board cast iron baseboard style radiation offers an “almost invisible” installation. Durable cast iron will allow years of worry-free comfort and provides more than five times the amount of radiant heat than conventional thin metal baseboards. This is due to the fact that the combined cast iron surface area is much larger than that found on thin metal baseboards. Gov-Board baseboards also offer the advantage of being able to distribute heat in both horizontal and vertical directions.

- Assemblies up to, and including, 6 lineal feet are shipped in one piece
- Narrow trim lines allow unit to blend with any décor – replacing base molding
- Cast iron provides very quiet operation
- Gov-Board baseboards can be painted, providing a seamless match to its surroundings
- Less than a 2-degree difference between floor and ceiling heat distribution
- Suitable for water or steam applications

Dimensions

A	B	C	D	E	F	G
1"	7/8"	2-1/2"	9-7/8"	1-3/4"	1-3/4"	3/4"

- 3/4" NPT Tappings Top and Bottom of end section
- Maximum Working Pressure 30 psi Water, 15 psi Steam
- Water content 0.3 gal./lineal foot

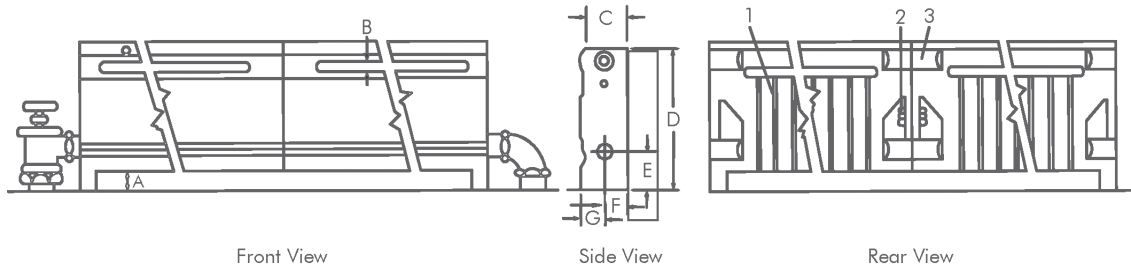

1 = Fins 2 = Tie Bolt 3 = Push Nipple

Ratings

FLOW RATE	NET AHRI STEAM RATE	*WATER RATINGS							
		BTUH per Linear Foot at Average Water Temp. Indicated							
Lbs./Hr.	Sq. Ft.	BTUH per Hr. at 215°F	170°F	180°F	190°F	200°F	210°F	220°F	230°F
500	3.40	860	430	480	530	580	630	680	730
2000	3.40	860	450	510	560	610	670	720	770

NOTES:

- The hot water ratings at 2000 lb. flow rate are limited to installations where the water flow rate through the Gov-Board is equal to or greater than 2000 lbs. per hour (4 GPM).
- Where the water flow rate through the Gov-Board is not known, the rating at the standard flow rate of 500 lbs. (1 GPM) per hour must be used.
- Net AHRI Ratings are determined from tests made in accordance with the AHRI Testing and Rating Code for baseboard-type radiation, including an allowance of 15% for heating effect permitted by the Code.
- Maximum allowable working pressure - 30 PSI, water; 15 PSI steam. Water content - 0.3 gal./lineal foot. For pressure drop information, see installation manual.
- Ratings are based on active length. Active length equals total length.

CONVECTORS

Durable & Versatile Cast Iron Heater

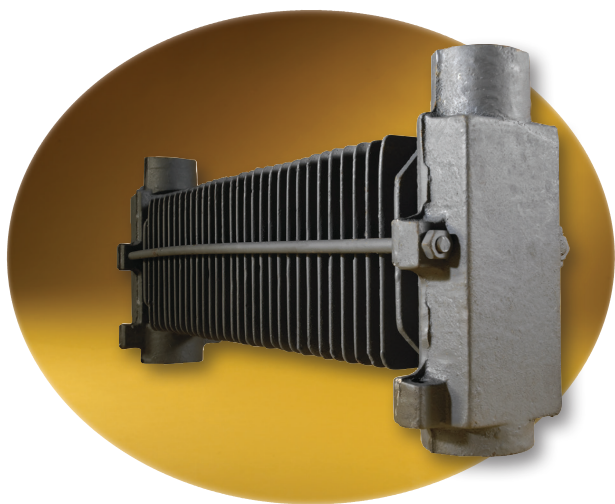

Need heat in a room where a radiator or baseboard heat distributor won't work? Consider a cast iron convector unit. These compact, yet powerful, cast iron units can be built into a window seat, a cabinet, or be included into a bookshelf design.

- Quiet efficiency and performance
- Constructed to withstand rigorous job site handling and, therefore, suffers no loss of efficiency caused by damaged and distorted fins
- Combined advantages of slow cool-down and high output of convectors
- Can be used in the same system as cast iron radiators and baseboards
- Suitable for water or steam applications

Dimensions

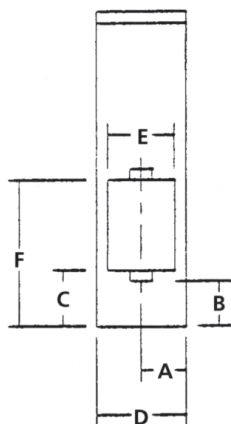

A	B	C	D	E	F
2-1/4"	5-3/4"	7"	4-1/2"	4"	13-1/2"
3-1/4"	5-3/4"	7"	6-1/2"	6"	13-1/2"

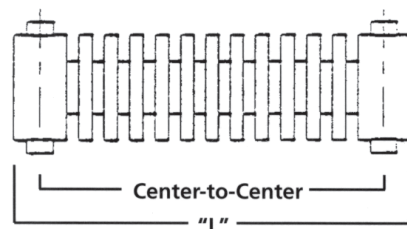

- Top Tappings 3/4" NPT
- Bottom Tappings 1-1/4" NPT

All dimensions subject to +/- 1.5"

Element #	419	423	427	431	435	439	443	447	455	463
'L' Dim.	18-1/2"	22-1/2"	26-1/2"	30-1/2"	34-1/2"	38-1/2"	42-1/2"	46-1/2"	54-1/2"	62-1/2"
'C-C' Dim.	16-1/4"	20-1/4"	24-1/4"	28-1/4"	32-1/4"	36-1/4"	40-1/4"	44-1/4"	52-1/4"	60-1/4"

Element #	619	623	627	631	635	639	643	647	655	663
'L' Dim.	19"	23"	27"	31"	35"	39"	43"	47"	55"	63"
'C-C' Dim.	16-3/4"	20-3/4"	24-3/4"	28-3/4"	32-3/4"	36-3/4"	40-3/4"	44-3/4"	52-3/4"	60-3/4"

GOV-BOARD™ ACCESSORIES

Offering a full line of accessories to ensure your heating system will stand the test of time and provide the needed comfort and style your home deserves.

- Valve enclosures
- Adjustable end caps 6" and 9"
- Inside corners 4 5/8" and 10 5/8"
- Outside corner 10 5/8"
- 12" filler piece
- Assembly tool
- Flexible corner/connectors
- Dummy cover 6'
- Hangers for dummy covers
- Left end cap for dummy cover
- Right end cap for dummy cover
- Top support
- Bottom support over 6'
- Support legs

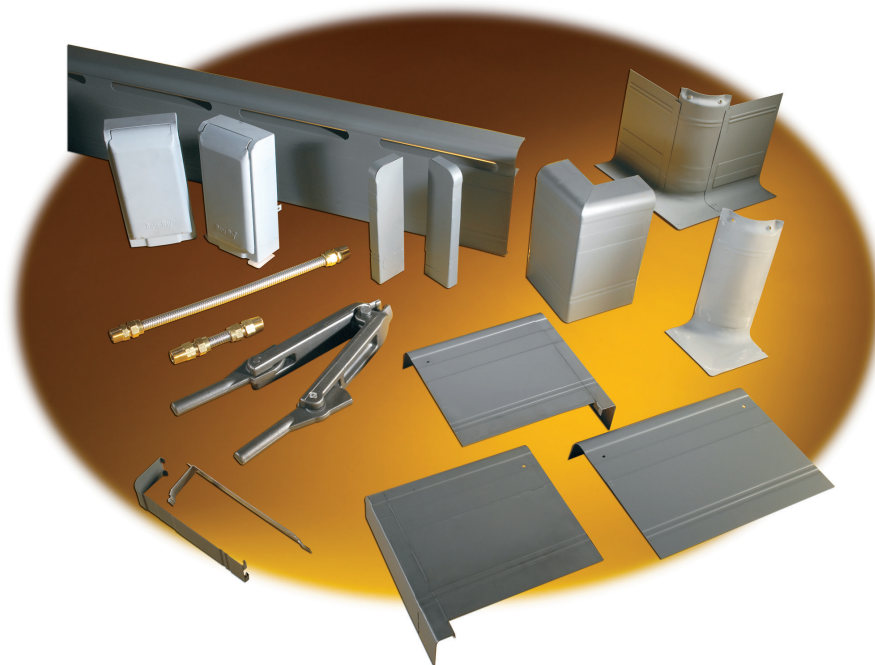

Governale®

©2017 Governale Company, Inc.
788 Williams Ave., Brooklyn, NY 11207
Phone: 718-272-2300
Fax: 718-272-3776
www.governaleindustries.com