



TRU-AIRE's **SmoothGlide™**

REGISTER

COMPLETELY
RE-ENGINEERED

HIGH QUALITY
STEEL COMPONENTS

RIVETS INSTALLED
AFTER ASSEMBLY
FOR SMOOTHEST OPERATION

BLADE & LINKAGE COMPONENTS INDIVIDUALLY
POWDER COATED **BEFORE** ASSEMBLY

Tired of Register Problems?

Dampers that stick?

Products that rust or won't open?

Paint that flakes?

Dampers too loose?

Tru-Aire's new SmoothGlide™ multi-shutter registers are made from the highest quality steel and are now completely re-engineered. Our secret is that every register is powder coated **BEFORE** it is assembled. This ensures optimal performance you can count on. The results are the smoothest working registers, every time. Tru-Aire continues to provide the highest quality registers on the market...and we keep getting better! Don't settle for anything less.

Shhhhh!

TOP SECRET

(562) 466-1000 • www.truaire.com

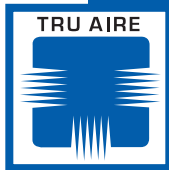

What's New...

New Product Lineup

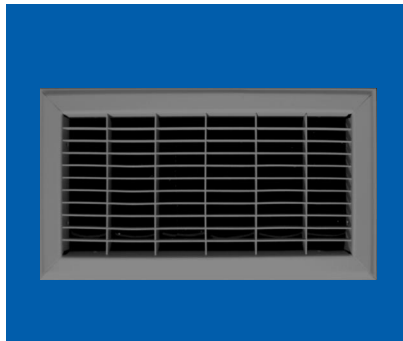

Model 154R
Floor Return Grille
Page 02

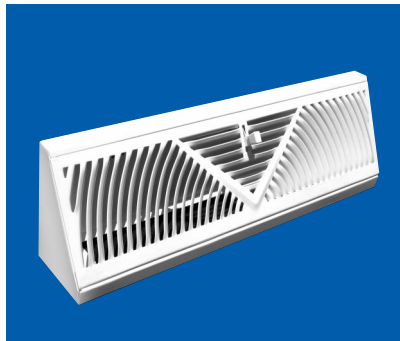

Model 115/118
Baseboard Supply & Return
Page 03

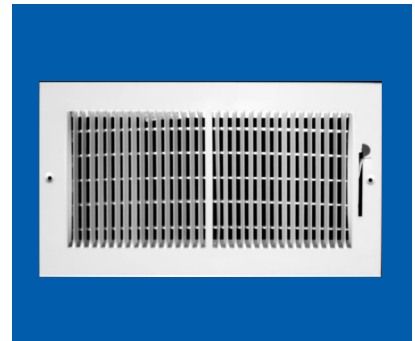

Model 124
Baseboard 1/3" Supply
Page 03

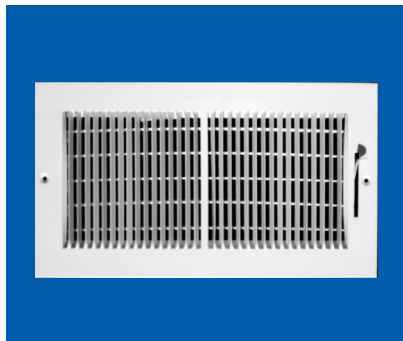

Model 132
Stamped 1/3" Spacing
Sidewall Supply
Page 06



Model 800
Round Ceiling Diffuser
Page 16

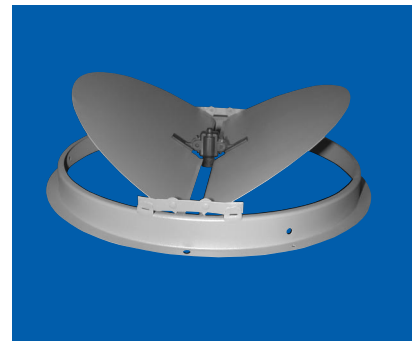

Model 801
Round Ceiling Diffuser
Page 16

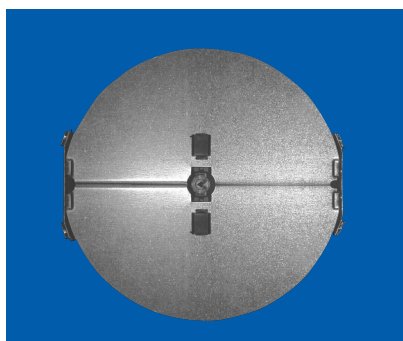

Model 802
Round Ceiling Diffuser
Page 16

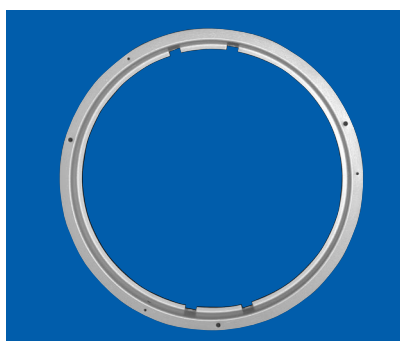

Model 803
Duct Ring
Page 16



Model ACD2440
Ceiling Access Panels
Page 24



PAGE

Floor Registers & Grilles

- 1 150MB Floor Diffuser-Stamped Face-Brown
- 1 150MW Floor Diffuser-Stamped Face-White
- 1 150TSB Toe Space Grille-Brown
- 1 150TSW Toe Space Grille-White

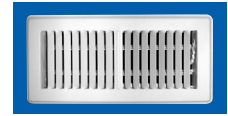

- 2 154R Floor Return Grille-Heavy Gage

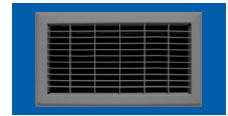

Baseboard Registers & Grilles

- 3 115SB Baseboard Diffuser-Brown-15"
- 3 115SW Baseboard Diffuser-White-15"
- 3 115RB Baseboard Diffuser-Brown-15"
- 3 115RW Baseboard Diffuser-White-15"
- 3 118SB Baseboard Diffuser-Brown-18"
- 3 118SW Baseboard Diffuser-White-18"
- 3 118RB Baseboard Return-Brown-18"
- 3 118RW Baseboard Return-White-18"
- 3 124M Baseboard Supply Register-1/3" spacing w/ 3/4" Turnback-No Bottom
- 4 122R Baseboard Return-Stamped 1/2" Fin Spacing 3/4" Turnback
- 4 123R Baseboard Return-Stamped 1/3" Fin Spacing 3/4" Turnback

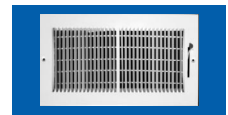

Sidewall Registers & Ceiling Diffusers - Stamped

- 5 101MD Stamped Register - Down Side Air Pattern
- 5 101MR Stamped Register - Right Side Air Pattern
- 5 101ML Stamped Register - Left Side Air Pattern
- 5 102M Stamped Register - 2 Way Air Pattern
- 5 103M Stamped Register - 3 Way Air Pattern
- 6 104M Stamped Register - 4 Way Air Pattern
- 6 132M Stamped Register 1/3" Fin- 2 Way Air Pattern

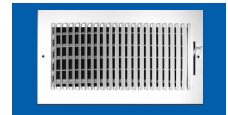

Sidewall Registers & Ceiling Diffusers - Bar Type

- 7 210VM Bar Type Supply Register-Adjustable-Multi Shutter Damper
- 7 220H Bar Type Supply Register-Face Bar Horiz./2nd Bar Vert.
- 7 220V Bar Type Supply Register-Face Bar Vert./2nd Bar Horiz.
- 7 220HM Bar Type Supply Register-Face Bar Horiz./2nd Bar Vert. w/Multi Shutter Damper
- 7 220VM Bar Type Supply Register-Face Bar Vert./2nd Bar Horiz. w/Multi Shutter Damper
- 7 230M Bar Type Supply Register-Adjustable-Multi Shutter Damper
- 8 210VO Bar Type Supply Register-OBDD
- 8 220HO Bar Type Supply Register-Face Bar Horiz./2nd Bar Vert. w/OBD
- 8 220VO Bar Type Supply Register-Face Bar Vert./2nd Bar Horiz. w/OBD

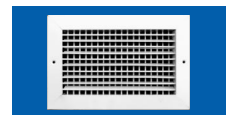



Adjustable Curved Blade

PAGE

| | | |
|-------|---|---|
| 301M | Curved Blade-Adjustable-Multi Shutter Damper-1 Way | 9 |
| 302HM | Curved Blade-Adjustable-Multi Shutter Damper-Horiz. Blade-2 Way | 9 |
| 302VM | Curved Blade-Adjustable-Multi Shutter Damper-Vert. Blade-2 Way | 9 |
| 303M | Curved Blade-Adjustable-Multi Shutter Damper-3 Way | 9 |
| 304M | Curved Blade-Adjustable-Multi Shutter Damper-4 Way | 9 |



| | | |
|-------|--|----|
| 301O | Curved Blade-Adjustable-OBD-1 Way | 10 |
| 302HO | Curved Blade-Adjustable-OBD-Horiz. Blade-2 Way | 10 |
| 302VO | Curved Blade-Adjustable-OBD-Vert. Blade-2 Way | 10 |
| 303O | Curved Blade-Adjustable-OBD-3 Way | 10 |
| 304O | Curved Blade-Adjustable-OBD-4 Way | 10 |

Stamped Curved Blade



| | | |
|-------|--|----|
| 401M | Curved Blade-Stamped-Multi Shutter Damper-1 Way | 11 |
| 402HM | Curved Blade-Stamped-Multi Shutter Damper-Horiz. Blade-2 Way | 11 |
| 402VM | Curved Blade-Stamped-Multi Shutter Damper-Vert. Blade-2 Way | 11 |



| | | |
|------|---|----|
| 403M | Curved Blade-Stamped-Multi Shutter Damper-3 Way | 12 |
| 404M | Curved Blade-Stamped-Multi Shutter Damper-4 Way | 12 |



| | | |
|------|--|----|
| 560M | Step-down Square Ceiling Diffuser-Multi Shutter Damper | 13 |
|------|--|----|

| | | |
|-----|-----------------------------|----|
| 600 | Evaporative Cooler Diffuser | 14 |
|-----|-----------------------------|----|

| | | |
|-----|--|----|
| 700 | High Velocity Cooler Diffuser-Multi Shutter Damper | 15 |
|-----|--|----|



| | | |
|-----|----------------|----|
| 800 | Round Diffuser | 16 |
|-----|----------------|----|

| | | |
|-----|------------------------------------|----|
| 801 | Round Duct Ring w/Butterfly Damper | 16 |
|-----|------------------------------------|----|

| | | |
|-----|------------------------|----|
| 802 | Round Butterfly Damper | 16 |
|-----|------------------------|----|

| | | |
|-----|-----------------|----|
| 803 | Round Duct Ring | 16 |
|-----|-----------------|----|

Return Air Grille - Stamped



| | | |
|-----|--|----|
| 170 | Stamped Face Return Air Grille 1/2" Fin Spaced | 17 |
|-----|--|----|

| | | |
|-----|--|----|
| 173 | Stamped Face Return Air Grille 1/3" Fin Spaced | 18 |
|-----|--|----|

Return Air Grille - Fixed Bar

| | | |
|-----|---|----|
| 270 | Fixed Bar Return Air Grille 1/2" Fin Spaced | 19 |
|-----|---|----|

Return Air Filter Grille - Stamped



| | | |
|-----|--|----|
| 190 | Stamped Face Return Air Grille 1/2" Fin Spaced | 20 |
|-----|--|----|

| | | |
|------|------------------------------------|----|
| 190F | 190 Filter Grille - Removable Face | 21 |
|------|------------------------------------|----|

Return Air Filter Grille - Fixed Bar



| | | |
|-----|---|----|
| 290 | Fixed Bar Return Air Grille 1/2" Fin Spaced | 22 |
|-----|---|----|

Access Door

| | | |
|--------|--------------------|----|
| ACD690 | Single Access Door | 23 |
|--------|--------------------|----|

Ceiling Access Panels







| | | |
|----------|---|----|
| ACD2440L | 3 Sectional Door w/Filter Grille(20"x20") Opening 24"x40" | 24 |
|----------|---|----|

| | | |
|----------|--|----|
| ACD2440S | 3 Sectional Solid Door Opening 24"x40" | 24 |
|----------|--|----|

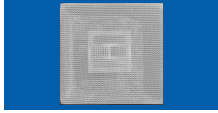
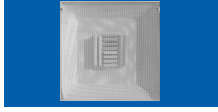
PAGE

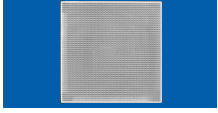
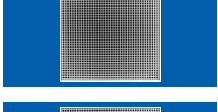
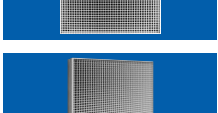
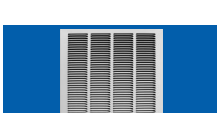
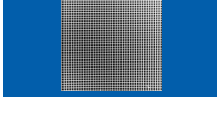
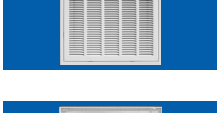
Supply & Return

| | | | | | | | |
|--------------------------|--------------|-------|---------------|-----------------|--------------|-------------------------|---|
| 25 | 1010MAS | 2'X2' | Supply | 4 Way Deflector | Perforated | Fiberglass Molded |  |
| 25 | 1010MAS | 2'X2' | Return | | Perforated | Fiberglass Molded | |
| 25 | 1020MAS | 2'X2' | Supply | 4 Way Deflector | Perforated | Steel |  |
| 25 | 1020MAS | 2'X2' | Return | | Perforated | Steel | |
| 25 | 1020MAS -INS | 2'X2' | Supply | 4 Way Deflector | Perforated | Steel w/R6-Insulated |  |
| 25 | 1020MAS -INS | 2'X2' | Return | | Perforated | Steel w/Insulated | |
| 26 | 1400CB | 2'X2' | Supply | Curved Blade | Step Down | Steel |  |
| 26 | 1444RB | 2'X2' | Return | | Step Down | Steel | |
| 27 | 2002CD | 2'X2' | Supply | | Step Down | Steel |  |
| 27 | 2003CD | 2'X2' | Supply | 2 Cone | Step Down | Steel | |
| 27 | 2004CD | 2'X2' | Supply | 3 Cone | Step Down | Steel | |
| 28 | 2002CDIN | 2'X2' | Supply | | Step Down | Steel w/Insulated | |
| 28 | 2003CDIN | 2'X2' | Supply | 2 Cone | Step Down | Steel w/Insulated |  |
| 28 | 2004CDIN | 2'X2' | Supply | 3 Cone | Step Down | Steel w/Insuated | |
| 29 | 1120S | 2'X2' | Supply | 4 way deflector | Perforated | Metal Frame-No Back |  |
| 29 | 1120R | 2'X2' | Return | | Perforated | Metal Frame-No Back | |
| 29 | 1120DBS | 2'X2' | Supply | 4 way deflector | Perforated | 1" Fiberglass Ductboard | |
| 29 | 1120DBR | 2'X2' | Return | | Perforated | 1" Fiberglass Ductboard | |
| 29 | 1130R-1 | 1'X2' | Return | Acrylic | Egg Crate | Metal Frame-No Back |  |
| 29 | 1130R-2 | 2'X2' | Return | Acrylic | Egg Crate | Metal Frame-No Back | |
| 29 | 1130R-4 | 4'X2' | Return | Acrylic | Egg Crate | Metal Frame-No Back | |
| 29 | 1130DBR-1 | 1'X2' | Return | Acrylic | Egg Crate | 1" Fiberglass Ductboard | |
| 29 | 1130DBR-2 | 2'X2' | Return | Acrylic | Egg Crate | 1" Fiberglass Ductboard |  |
| 29 | 1130DBR-4 | 4'X2' | Return | Acrylic | Egg Crate | 1" Fiberglass Ductboard | |
| 29 | 1140R-1 | 1'X2' | Return | Aluminum | Egg Crate | Metal Frame-No Back |  |
| 29 | 140R-2 | 2'X2' | Return | Aluminum | Egg Crate | Metal Frame-No Back | |
| 29 | 1140R-4 | 4'X2' | Return | Aluminum | Egg Crate | Metal Frame-No Back | |
| 29 | 1140DBR-1 | 1'X2' | Return | Aluminum | Egg Crate | 1" Fiberglass Ductboard | |
| 29 | 1140DBR-2 | 2'X2' | Return | Aluminum | Egg Crate | 1" Fiberglass Ductboard |  |
| 29 | 1140DBR-4 | 4'X2' | Return | Aluminum | Egg Crate | 1" Fiberglass Ductboard | |
| Face Panel-Return | | | | | | | |
| 30 | 1110RG | 2'X2' | Return | Steel | Stamped | Face Panel Only | |
| 30 | 1210RG | 2'X2' | Return | Steel | Fixed Bar | Face Panel Only | |
| 30 | 1920RG | 2'X2' | Return | Steel | Perforated | Face Panel Only | |
| 31 | 1930RG | 2'X2' | Return | Acrylic | Egg Crate | Face Panel Only | |
| 31 | 1934RG | 2'X2' | Return | Acrylic | Egg Crate | Face Panel w/Frame | |
| 31 | 1940RG | 2'X2' | Return | Aluminum | Egg Crate | Face Panel Only | |
| 31 | 1944RG | 2'X2' | Return | Aluminum | Egg Crate | Face Panel w/Frame | |
| Filter Grille | | | | | | | |
| 32 | 4010FG | 2'X2' | Filter-Return | Steel | Stamped 1/2" | Metal Frame-No Back | |
| 32 | 4010FG-DB | 2'X2' | Filter-Return | Steel | Stamped 1/2" | 1" Fiberglass Ductboard | |
| 32 | 4020FG | 2'X2' | Filter-Return | Steel | Fixed Bar | Metal Frame-No Back | |
| 32 | 4020FG-DB | 2'X2' | Filter-Return | Steel | Fixed Bar | 1" Fiberglass Ductboard | |
| 32 | 4030FG | 2'X2' | Filter-Return | Steel | Perforated | Metal Frame-No Back | |
| 32 | 4030FG-DB | 2'X2' | Filter-Return | Steel | Perforated | 1" Fiberglass Ductboard | |

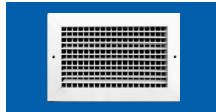

Sidewall Registers & Ceiling Diffusers - Bar Type

| | | |
|--------|---|----|
| A210H | Bar Type Supply Register - Face Bar-Horizontal | 33 |
| A210V | Bar Type Supply Register - Face Bar-Vertical | 33 |
| A210VM | Bar Type Supply Register - Adjustable-Multi Shutter Damper | 33 |
| A230M | Bar Type Supply Register - Adjustable-Multi Shutter Damper | 33 |
| A220H | Bar Type Supply Register - Face Bar Horizontal - 2nd Bar Vertical | 34 |
| A220V | Bar Type Supply Register - Face Bar Vertical - 2nd Bar Horizontal | 34 |
| A220HO | Bar Type Supply Register - Face Bar Horizontal - 2nd Bar Vertical w/OBD | 34 |
| A220VO | Bar Type Supply Register-Face Bar Vert./2nd Bar Horiz. w/OBD | 34 |
| A230M | Bar Type Supply Register-Adjustable-Multi Shutter Damper | 34 |

Adjustable Curved Blade

| | | |
|--------|---|----|
| A301M | Curved Blade-Adjustable-Multi Shutter Damper-1 Way | 35 |
| A301O | Curved Blade-Adjustable-OBD-1 Way | 35 |
| A302HM | Curved Blade-Adjustable-Multi Shutter Damper-Horiz. Blade-2 Way | 35 |
| A302HO | Curved Blade-Adjustable-OBD-Horiz. Blade-2 Way | 35 |
| A302VM | Curved Blade-Adjustable-Multi Shutter Damper-Vert. Blade-2 Way | 35 |
| A302VO | Curved Blade-Adjustable-OBD-Vert. Blade-2 Way | 35 |
| A303M | Curved Blade-Adjustable-Multi Shutter Damper-3 Way | 36 |
| A303O | Curved Blade-Adjustable-OBD-3 Way | 36 |
| A304M | Curved Blade-Adjustable-Multi Shutter Damper-4 Way | 36 |
| A304O | Curved Blade-Adjustable-OBD-4 Way | 36 |

Square

| | | |
|-------|--------------------------------------|----|
| A501M | Square Ceiling Diffuser-1 Way | 37 |
| A502M | Square Ceiling Diffuser-2 Way | 37 |
| A503M | Square Ceiling Diffuser-3 Way | 37 |
| A504M | Square Ceiling Diffuser-4 Way | 37 |
| A505M | Square Ceiling Diffuser-Corner-2 Way | 37 |

Return Air Grille

| | | |
|------|---|----|
| A270 | Fixed Bar Return Air Grille 3/4" Fin Spaced | 38 |
|------|---|----|

Return Air Filter Grille

| | | |
|------|--|----|
| A290 | Fixed Bar Return Air Filter Grille 3/4" Fin Spaced | 39 |
|------|--|----|

PAGE





STAMPED FACE: Floor Grille

Model 150MB/MW

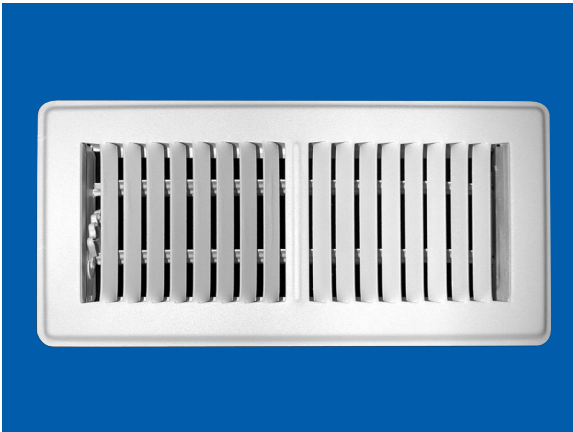

- ❖ Sturdy, all-steel construction
- ❖ Multi-shutter damper
- ❖ Widespread air diffusion
- ❖ Durable white gloss powder coated finish
- ❖ "No-Scuff" finish - Brown or White

Face Frame: Listed Size (+1.50")

Except: 02 x 10 (3.750" x 11.50")
 02 x 12 (3.750" x 13.50")
 02 x 14 (3.750" x 15.50")

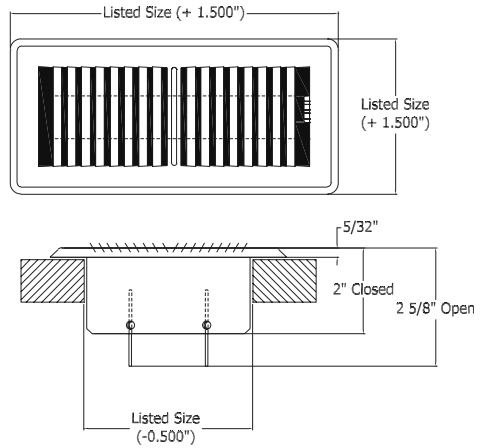

| 150MB/MW - Available Sizes (in inches) | | | | | | | | |
|--|-------|---|---|---|----|----|----|----|
| HEIGHT | WIDTH | | | | | | | |
| | 2 | 4 | 6 | 8 | 10 | 12 | 14 | 18 |
| 6 | | | | | | | | |
| 8 | ❖ | ❖ | ❖ | | | | | |
| 10 | ❖ | ❖ | ❖ | | | | | |
| 12 | ❖ | ❖ | ❖ | | | | | |
| 14 | ❖ | ❖ | ❖ | | | | | |

* PLEASE CONTACT US FOR ALL SIZES NOT LISTED

Damper: Listed Size (- 0.50")

Except: 02 x 10 (2.00" x 9.50")
 02 x 12 (2.00" x 11.50")
 02 x 14 (2.00" x 13.50")

Model 150TSB/TSW

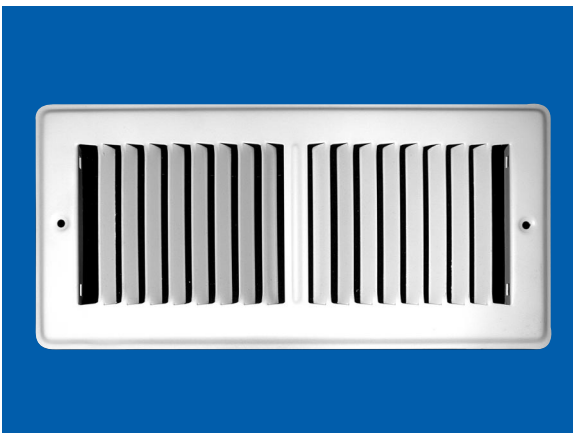

- ❖ Sturdy, all-steel construction
- ❖ Widespread air diffusion
- ❖ Durable white gloss powder coated finish
- ❖ Available in "No-Scuff" finish - Brown or White

Face Frame: Listed Size (+1.50")

Except: 02 x 10 (3.750" x 11.50")
 02 x 12 (3.750" x 13.50")
 02 x 14 (3.750" x 15.50")

STAMPED FACE: Toe Space Grille

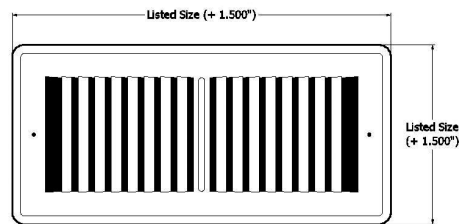

| 150TSB/TSW - Available Sizes (in inches) | | | | | | | | |
|--|-------|---|---|---|----|----|----|----|
| HEIGHT | WIDTH | | | | | | | |
| | 2 | 4 | 6 | 8 | 10 | 12 | 14 | 18 |
| 6 | | | | | | | | |
| 8 | | ❖ | | | | | | |
| 10 | ❖ | ❖ | ❖ | | | | | |
| 12 | ❖ | ❖ | ❖ | | | | | |
| 14 | ❖ | ❖ | ❖ | | | | | |

* PLEASE CONTACT US FOR ALL SIZES NOT LISTED

Model 154R

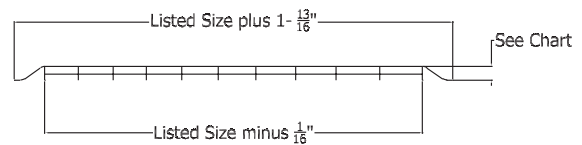
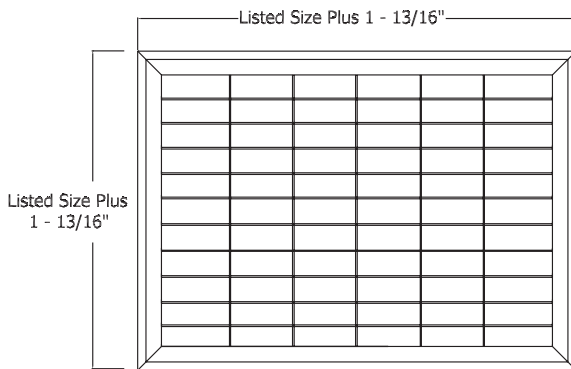
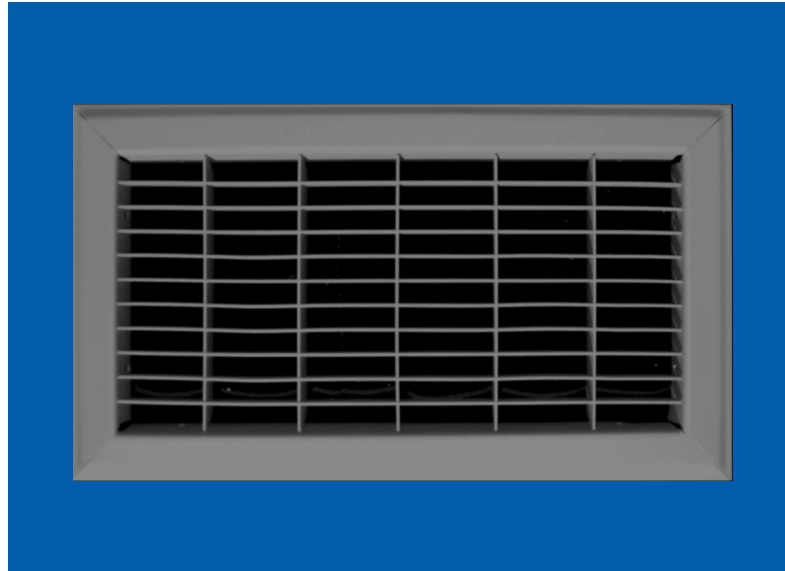

Model 154R

- ❖ Heavy gauge steel construction
- ❖ 75% average Free Area
- ❖ Brown powder coat finish

| WIDTH | LENGTH | MAX DEPTH |
|------------|------------|-----------|
| 4 thru 12 | 6 thru 30 | 21/32 |
| 14 thru 16 | 32 thru 36 | 25/32 |
| 16 thru 18 | 16 thru 36 | 25/32 |
| 20 thru 30 | 20 thru 36 | |

| 154R - Available Sizes (in inches) | | | | | | | | | | | | |
|------------------------------------|-------|---|---|----|----|----|----|----|----|----|----|----|
| HEIGHT | WIDTH | | | | | | | | | | | |
| | 4 | 6 | 8 | 10 | 12 | 14 | 16 | 18 | 20 | 24 | 30 | 36 |
| 4 | | | ❖ | ❖ | ❖ | ❖ | ❖ | ❖ | ❖ | ❖ | ❖ | ❖ |
| 6 | | | ❖ | ❖ | ❖ | ❖ | ❖ | ❖ | ❖ | ❖ | ❖ | ❖ |
| 8 | | ❖ | ❖ | ❖ | ❖ | ❖ | ❖ | ❖ | ❖ | ❖ | ❖ | ❖ |
| 10 | | | | ❖ | ❖ | ❖ | ❖ | ❖ | ❖ | ❖ | ❖ | ❖ |
| 12 | | | | | ❖ | ❖ | ❖ | ❖ | ❖ | ❖ | ❖ | ❖ |
| 14 | | | | | | ❖ | ❖ | ❖ | ❖ | ❖ | ❖ | ❖ |
| 16 | | | | | | | ❖ | ❖ | ❖ | ❖ | ❖ | ❖ |
| 18 | | | | | | | | ❖ | ❖ | ❖ | ❖ | ❖ |
| 20 | | | | | | | | | ❖ | ❖ | ❖ | ❖ |
| 24 | | | | | | | | | | ❖ | ❖ | ❖ |
| 30 | | | | | | | | | | | ❖ | ❖ |

* PLEASE CONTACT US FOR ALL SIZES NOT LISTED



BASEBOARD SUPPLY/RETURN AIR GRILLES

Model 115S/118S Supply

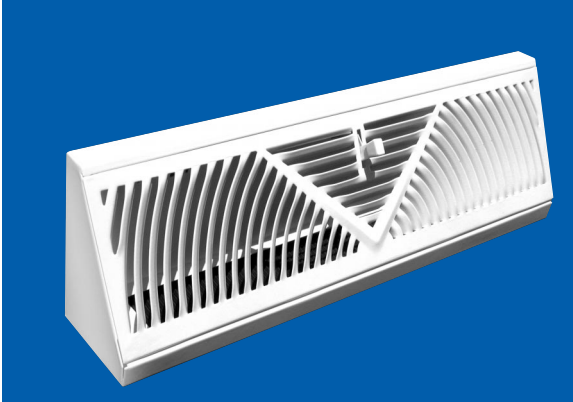

Model 115R/118R Return

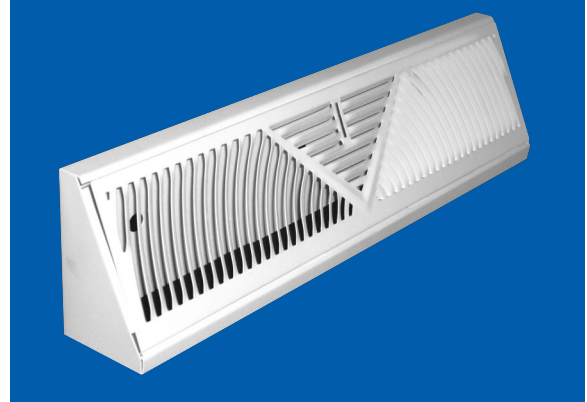

Model 115/118

- ❖ 15" and 18" Supply and Return Baseboard Diffuser
- ❖ All steel construction
- ❖ Durable white gloss powder coated finish
- ❖ "No-Scuff" finish - Brown or White
- ❖ Each grille is individually shrink wrapped

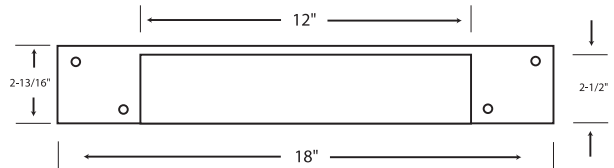

Bottom View of Model 118

| | LENGTH | HEIGHT | FREE AREA |
|-----|--------|--------|-----------|
| 115 | 15" | 4-1/2" | 32sq.in. |
| 118 | 18" | 4-1/2" | 32sq.in. |

Model 124M

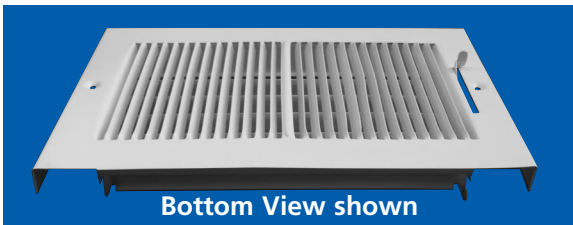
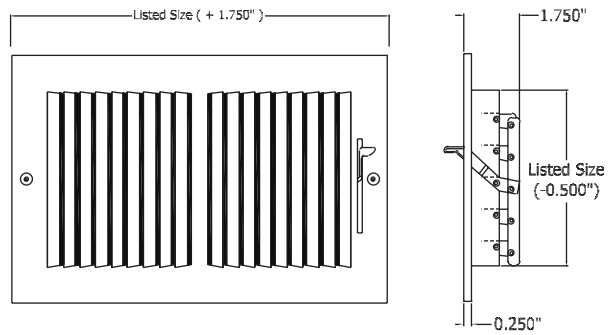
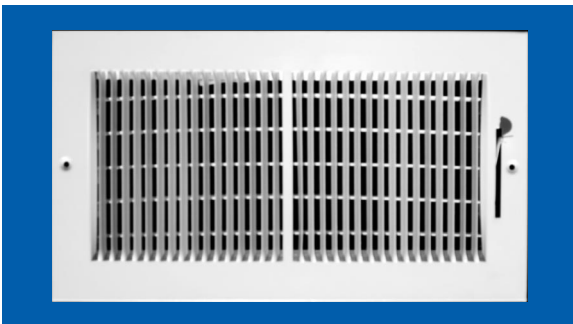

| HEIGHT | WIDTH | | | | | | | | |
|--------|-------|---|----|----|----|----|----|----|----|
| | 6 | 8 | 10 | 12 | 14 | 16 | 18 | 20 | 24 |
| 4 | | ❖ | ❖ | ❖ | ❖ | | | | |
| 6 | | ❖ | ❖ | ❖ | ❖ | | ❖ | | ❖ |
| 8 | | ❖ | | ❖ | | | | | |
| 10 | | | | ❖ | ❖ | ❖ | | | |

* PLEASE CONTACT US FOR ALL SIZES NOT LISTED

- ❖ Stamped louver in 2-way air pattern
- ❖ 1/3" spacing available only with this two-way model
- ❖ Single lever operated multi-louver shutter
- ❖ Counter-sunk screw holes with 2" screws (provided)

- ❖ Finished with white powder coating
- ❖ Each grille is individually shrink wrapped
- ❖ 3/4" margin turnback

Model 122R

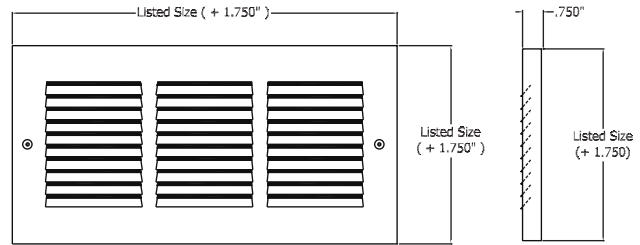
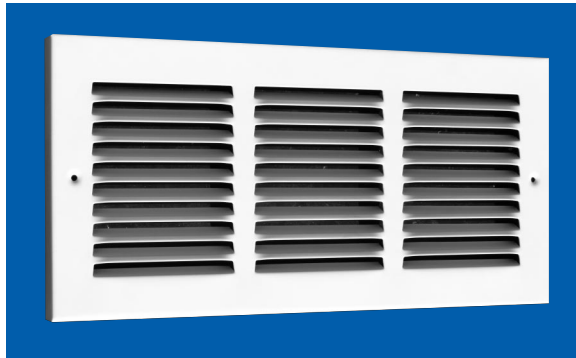

Model 123R

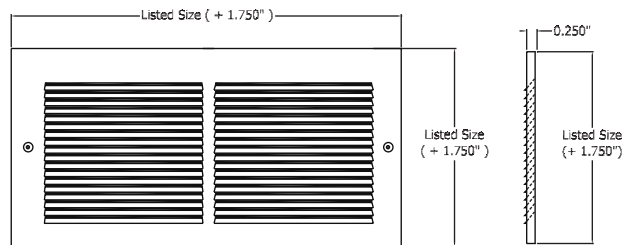
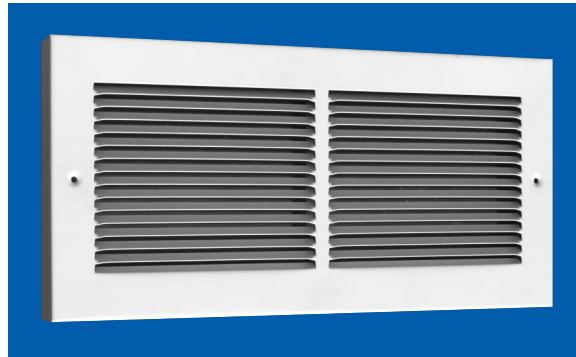

Models 122R & 123R

- ❖ Model 122R features 1/2" spaced with 45° blade angle
- ❖ Model 123R features 1/3" spaced with 45° blade angle
- ❖ Counter-sunk screw holes with 2" screws (*provided*)
- ❖ Finished with white powder coating
- ❖ Each grille is individually shrink wrapped
- ❖ 3/4" margin turnback

| Model 122/123 - Available Sizes (in inches) | | | | | | | |
|---|-------|----|----|----|----|----|----|
| HEIGHT | WIDTH | | | | | | |
| | 8 | 10 | 12 | 14 | 20 | 24 | 30 |
| 4 | ❖ | | | | | | |
| 6 | ❖ | ❖ | ❖ | ❖ | ❖ | ❖ | ❖ |
| 8 | | ❖ | ❖ | ❖ | ❖ | ❖ | ❖ |
| 10 | | | | ❖ | ❖ | ❖ | ❖ |
| 12 | | | | ❖ | | ❖ | ❖ |

* PLEASE CONTACT US FOR ALL SIZES NOT LISTED



STAMPED FACE: Side Wall/Ceiling Registers

Model 101MD Down-Side

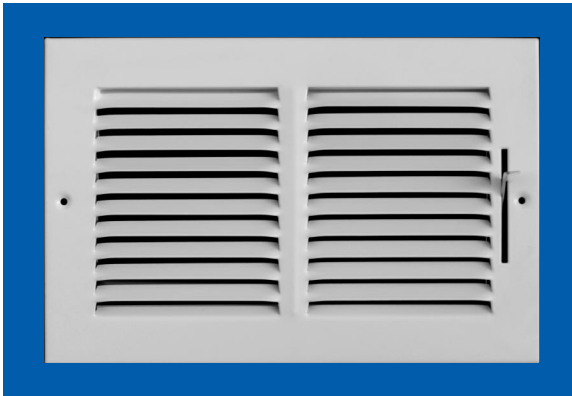

| 101M - Available Sizes (in inches) | | | | | | | | | |
|------------------------------------|-------|---|---|----|----|----|----|----|----|
| HEIGHT | WIDTH | | | | | | | | |
| | 4 | 6 | 8 | 10 | 12 | 14 | 16 | 18 | 20 |
| 2 | | | | | | | | | |
| 4 | | | ❖ | ❖ | | | | | |
| 6 | | | ❖ | ❖ | ❖ | ❖ | ❖ | | |
| 8 | | | | ❖ | ❖ | ❖ | | | |
| 10 | | | | | | | | | |
| 12 | | | | | | | | | |
| 14 | | | | | | | | | |
| 16 | | | | | | | | | |

* PLEASE CONTACT US FOR ALL SIZES NOT LISTED

Model 101MR One Way to Right

Model 101ML One Way to Left

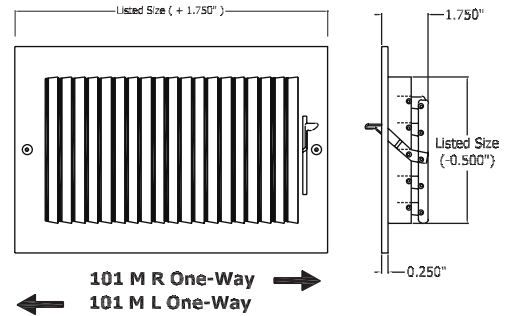
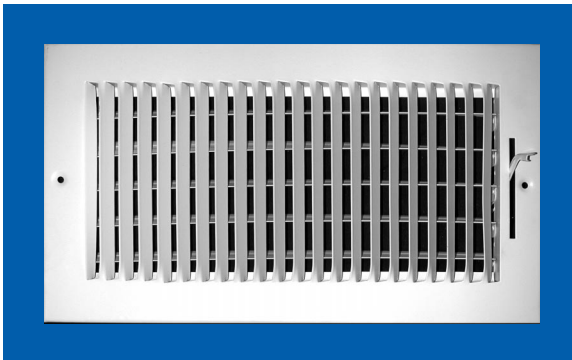

Model 102M Two Way

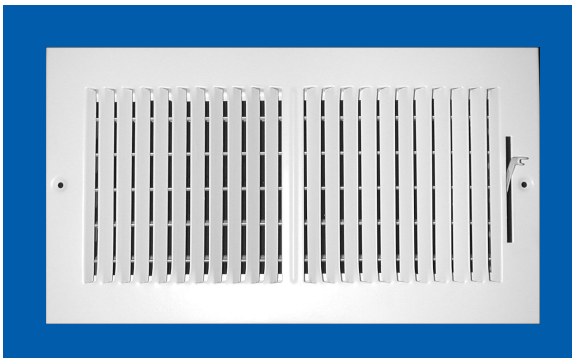

| 102M - Available Sizes (in inches) | | | | | | | | | |
|------------------------------------|-------|---|----|----|----|----|----|----|----|
| HEIGHT | WIDTH | | | | | | | | |
| | 6 | 8 | 10 | 12 | 14 | 16 | 18 | 20 | 24 |
| 4 | ❖ | ❖ | ❖ | ❖ | ❖ | ❖ | ❖ | ❖ | ❖ |
| 6 | ❖ | ❖ | ❖ | ❖ | ❖ | ❖ | ❖ | ❖ | ❖ |
| 8 | | ❖ | ❖ | ❖ | ❖ | ❖ | ❖ | ❖ | ❖ |
| 10 | | | ❖ | ❖ | ❖ | ❖ | ❖ | ❖ | ❖ |
| 12 | | | | ❖ | ❖ | | ❖ | ❖ | ❖ |
| 14 | | | | | ❖ | | | | ❖ |
| 16 | | | | | | | | | |
| 18 | | | | | | | ❖ | ❖ | |

100 Series Registers

- ❖ Stamped louver in 1-way (right, left or down-side airflow) 2-way patterns
- ❖ 1/2" spaced with 45° blade angle
- ❖ Single lever operated multi-louver shutter

- ❖ Counter-sunk screw holes with 2" screws (*provided*)
- ❖ Finished with white powder coating
- ❖ Each grille is individually shrink wrapped

STAMPED FACE: Side Wall/Ceiling Registers



Model 103M Three Way

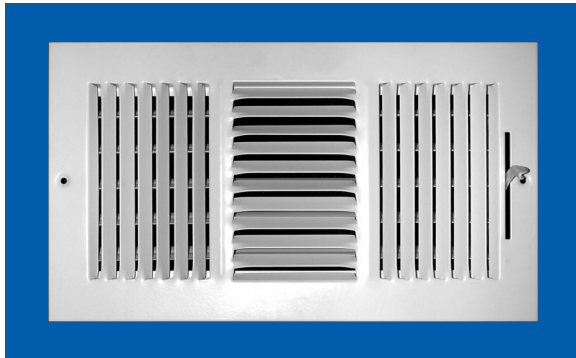

| 103M - Available Sizes (in inches) | | | | | | | | | |
|------------------------------------|-------|---|----|----|----|----|----|----|----|
| HEIGHT | WIDTH | | | | | | | | |
| | 6 | 8 | 10 | 12 | 14 | 16 | 18 | 20 | 24 |
| 4 | ❖ | ❖ | ❖ | ❖ | ❖ | | | ❖ | |
| 6 | ❖ | ❖ | ❖ | ❖ | ❖ | ❖ | ❖ | ❖ | ❖ |
| 8 | | ❖ | ❖ | ❖ | ❖ | ❖ | ❖ | ❖ | ❖ |
| 10 | | | ❖ | ❖ | ❖ | ❖ | ❖ | | |
| 12 | | | | ❖ | ❖ | | ❖ | | |
| 14 | | | | | ❖ | | | | |
| 16 | | | | | | | | | |
| 18 | | | | | | | | | |

Model 104M Four Way



| 104M - Available Sizes (in inches) | | | | | | | | | |
|------------------------------------|-------|---|----|----|----|----|----|----|----|
| HEIGHT | WIDTH | | | | | | | | |
| | 6 | 8 | 10 | 12 | 14 | 16 | 18 | 20 | 24 |
| 6 | ❖ | | ❖ | | | | | | |
| 8 | | ❖ | ❖ | | | | | | |
| 10 | | | ❖ | | | | | | |
| 12 | | | | ❖ | | | | | |
| 14 | | | | | ❖ | | | | |
| 16 | | | | | | ❖ | | | |
| 18 | | | | | | | ❖ | | |
| 20 | | | | | | | | ❖ | |

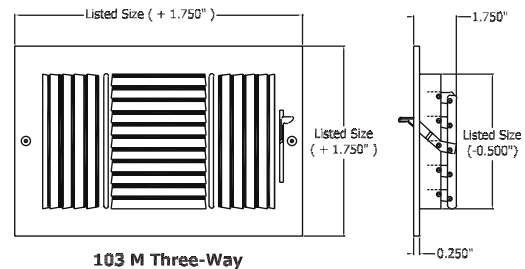

Model 132M Two Way

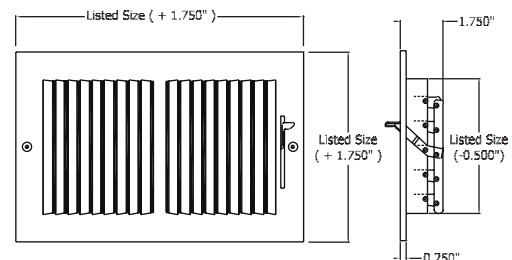
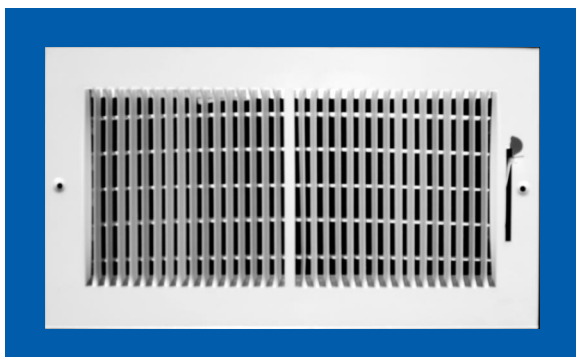

| 132M - Available Sizes (in inches) | | | | | | | | | |
|------------------------------------|-------|---|----|----|----|----|----|----|----|
| HEIGHT | WIDTH | | | | | | | | |
| | 6 | 8 | 10 | 12 | 14 | 16 | 18 | 20 | 24 |
| 4 | | ❖ | ❖ | ❖ | ❖ | | | | |
| 6 | | ❖ | ❖ | ❖ | ❖ | ❖ | ❖ | | ❖ |
| 8 | | ❖ | ❖ | ❖ | ❖ | | | | |
| 10 | | | | | | | | | |

- ❖ Stamped louver in 2-way air pattern
- ❖ 1/3" spacing available only with this two-way model
- ❖ Single lever operated multi-louver shutter
- ❖ Counter-sunk screw holes with 2" screws (provided)

* PLEASE CONTACT US FOR ALL SIZES NOT LISTED



BAR TYPE SUPPLY: Side Wall/Ceiling Registers

Bar Type Supply Register

Model 210VM Single Deflection



Model 230M Three-Way Deflection

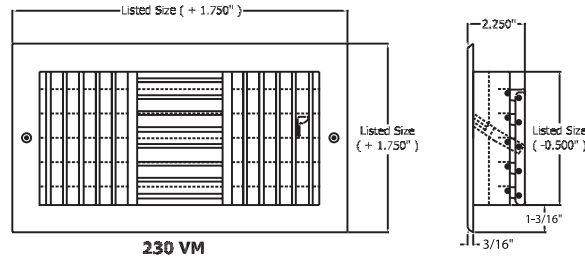
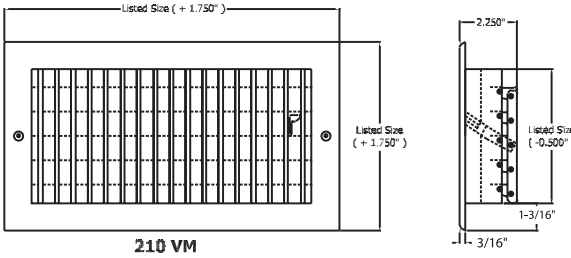
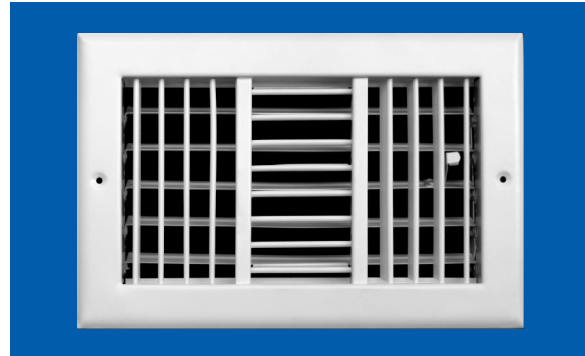

210VM, 220VM, 230M

- ❖ Single lever operated multi-louver rear damper
- ❖ One piece frame (up to 14" x 10")
- ❖ Counter-sunk screw holes with 1/4" hexagon-head screws (provided)
- ❖ Finished with white powder coating
- ❖ Each grille is individually shrink wrapped
- ❖ Adjustable fins provide individual deflection control

Also Available *Not Shown

- 220H - Face Bar - Horizontal • 2nd Bar Vertical**
- 220V - Face Bar - Vertical • 2nd Bar Horizontal**
- 220HM - Multi Louver Damper**
- 220VM - Multi Louver Damper**

| 210 and 220 Series - Available Sizes (in inches) | | | | | | | | | | | |
|--|-------|---|----|----|----|----|----|----|----|----|----|
| HEIGHT | WIDTH | | | | | | | | | | |
| | 6 | 8 | 10 | 12 | 14 | 16 | 18 | 20 | 24 | 26 | 30 |
| 4 | ❖ | ❖ | ❖ | ❖ | ❖ | ❖ | ❖ | ❖ | ❖ | | ❖ |
| 6 | ❖ | ❖ | ❖ | ❖ | ❖ | ❖ | ❖ | ❖ | ❖ | | ❖ |
| 8 | | ❖ | ❖ | ❖ | ❖ | ❖ | ❖ | ❖ | ❖ | | ❖ |
| 10 | | | ❖ | ❖ | ❖ | ❖ | ❖ | ❖ | ❖ | | ❖ |
| 12 | | | | ❖ | ❖ | ❖ | ❖ | ❖ | ❖ | | ❖ |
| 14 | | | | | ❖ | ❖ | ❖ | ❖ | ❖ | | ❖ |
| 16 | | | | | | ❖ | ❖ | ❖ | ❖ | | ❖ |
| 18 | | | | | | | ❖ | ❖ | ❖ | ❖ | ❖ |
| 20 | | | | | | | | ❖ | ❖ | | ❖ |
| 24 | | | | | | | | | ❖ | | ❖ |

| 230M - Available Sizes (in inches) | | | | | | |
|------------------------------------|-------|----|----|----|----|--|
| HEIGHT | WIDTH | | | | | |
| | 8 | 10 | 12 | 14 | 16 | |
| 4 | ❖ | ❖ | | | | |
| 6 | ❖ | ❖ | ❖ | ❖ | | |
| 8 | | ❖ | ❖ | ❖ | | |
| 10 | | | ❖ | ❖ | | |
| 12 | | | | ❖ | | |
| 14 | | | | | ❖ | |

* PLEASE CONTACT US FOR ALL SIZES NOT LISTED

Model 210VO Vertical with Single Deflection

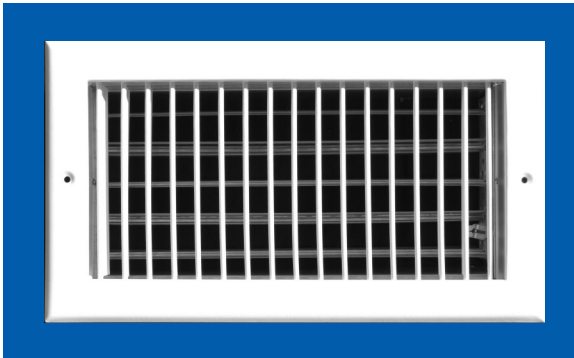

Model 220VO Vertical with Double Deflection



Model 220VO Reverse Side Shown

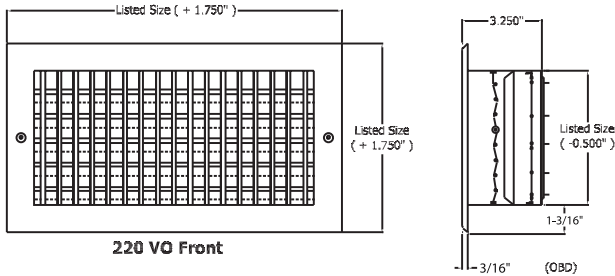

210VO & 220VO

- ❖ Opposite blade damper
- ❖ One piece frame (up to 14" x 10")
- ❖ Counter-sunk screw holes with 1/4" hexagon-head screws (*provided*)
- ❖ Finished with white powder coating
- ❖ Each diffuser is individually shrink wrapped
- ❖ Adjustable fins provide individual deflection control

Also Available *Not Shown

- 210HO - Face Bar - Horizontal
- 220HO - Face Bar - Horizontal • 2nd Bar Vertical

| 210 and 220 Series - Available Sizes (in inches) | | | | | | | | | | | |
|--|-------|---|----|----|----|----|----|----|----|----|----|
| HEIGHT | WIDTH | | | | | | | | | | |
| | 6 | 8 | 10 | 12 | 14 | 16 | 18 | 20 | 24 | 26 | 30 |
| 4 | ❖ | ❖ | ❖ | ❖ | ❖ | ❖ | ❖ | ❖ | ❖ | | ❖ |
| 6 | ❖ | ❖ | ❖ | ❖ | ❖ | ❖ | ❖ | ❖ | ❖ | | ❖ |
| 8 | | ❖ | ❖ | ❖ | ❖ | ❖ | ❖ | ❖ | ❖ | | ❖ |
| 10 | | | ❖ | ❖ | ❖ | ❖ | ❖ | ❖ | ❖ | | ❖ |
| 12 | | | | ❖ | ❖ | ❖ | ❖ | ❖ | ❖ | | ❖ |
| 14 | | | | | ❖ | ❖ | ❖ | ❖ | ❖ | | ❖ |
| 16 | | | | | | ❖ | ❖ | ❖ | ❖ | | ❖ |
| 18 | | | | | | | ❖ | ❖ | ❖ | ❖ | ❖ |
| 20 | | | | | | | | ❖ | ❖ | | ❖ |
| 24 | | | | | | | | | ❖ | | ❖ |

* PLEASE CONTACT US FOR ALL SIZES NOT LISTED



ADJUSTABLE CURVED BLADE SUPPLY: Side Wall/Ceiling

Model 301M / 301O One Way

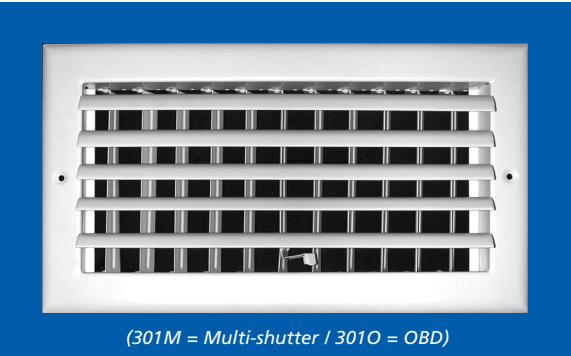

| 301M - Available Sizes (in inches) | | | | | | | | | |
|------------------------------------|-------|---|----|----|----|----|----|----|----|
| HEIGHT | WIDTH | | | | | | | | |
| | 6 | 8 | 10 | 12 | 14 | 16 | 18 | 20 | 24 |
| 4 | | ❖ | ❖ | ❖ | ❖ | | | | |
| 6 | ❖ | ❖ | ❖ | ❖ | ❖ | ❖ | ❖ | | |
| 8 | | ❖ | | ❖ | ❖ | | | | |
| 10 | | | ❖ | ❖ | ❖ | | | | |
| 12 | | | | ❖ | | | | | |
| 14 | | | | | ❖ | | | | |
| 16 | | | | | | ❖ | | | |
| 18 | | | | | | | ❖ | | |

Model 302M / 302O Two Way Horizontal



| 302M - Available Sizes (in inches) | | | | | | | | | |
|------------------------------------|-------|---|----|----|----|----|----|----|----|
| HEIGHT | WIDTH | | | | | | | | |
| | 6 | 8 | 10 | 12 | 14 | 16 | 18 | 20 | 24 |
| 4 | | ❖ | ❖ | ❖ | ❖ | | | | |
| 6 | ❖ | ❖ | ❖ | ❖ | ❖ | | | | |
| 8 | | ❖ | | ❖ | ❖ | | | | |
| 10 | | | ❖ | ❖ | ❖ | | | | |
| 12 | | | | ❖ | | | | | |
| 14 | | | | | ❖ | | | | |
| 16 | | | | | | ❖ | | | |
| 18 | | | | | | | ❖ | | |

Model 302VM / 302VO Two Way Vertical



| 302VM - Available Sizes (in inches) | | | | | | | | | |
|-------------------------------------|-------|---|----|----|----|----|----|----|----|
| HEIGHT | WIDTH | | | | | | | | |
| | 6 | 8 | 10 | 12 | 14 | 16 | 18 | 20 | 24 |
| 4 | | ❖ | ❖ | ❖ | ❖ | | | | |
| 6 | ❖ | ❖ | ❖ | ❖ | ❖ | | | | |
| 8 | | ❖ | | ❖ | ❖ | | | | |
| 10 | | | ❖ | ❖ | ❖ | | | | |
| 12 | | | | ❖ | | | | | |
| 14 | | | | | ❖ | | | | |
| 16 | | | | | | ❖ | | | |
| 18 | | | | | | | ❖ | | |

300 Series Registers

- ❖ 1, 2, 3, and 4-way air patterns
- ❖ Available with or without OBD
- ❖ Corner block directional air way control fin is encased in roll formed 22 guage steel
- ❖ Single lever operated multi-louver shutter
- ❖ Counter-sunk screw holes with 1/4" hexagonal screws (provided)
- ❖ Finished with white powder coating

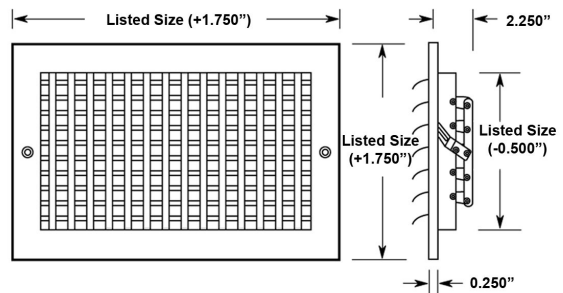

ADJUSTABLE CURVED BLADE SUPPLY: Side Wall/Ceiling



Adjustable Curved Blade Supply

Model 303M / 303O Three Way

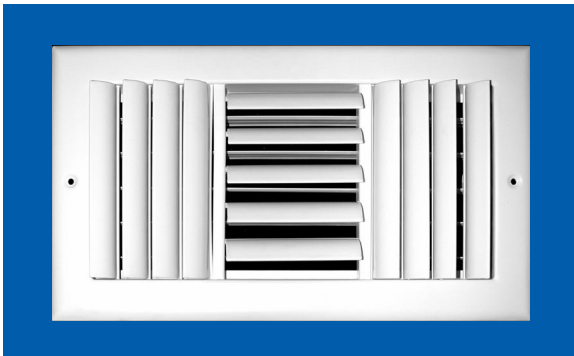

| 303M - Available Sizes (in inches) | | | | | | | | | |
|------------------------------------|-------|---|----|----|----|----|----|----|----|
| HEIGHT | WIDTH | | | | | | | | |
| | 6 | 8 | 10 | 12 | 14 | 16 | 18 | 20 | 24 |
| 4 | | ❖ | ❖ | ❖ | ❖ | | | | |
| 6 | ❖ | ❖ | ❖ | ❖ | ❖ | | | ❖ | |
| 8 | | ❖ | ❖ | ❖ | ❖ | ❖ | | ❖ | |
| 10 | | | ❖ | ❖ | ❖ | ❖ | | | |
| 12 | | | | ❖ | | | | | |
| 14 | | | | | ❖ | | | | |
| 16 | | | | | | ❖ | | | |
| 18 | | | | | | | ❖ | | |

Model 304M / 304O Four Way



| 304M - Available Sizes (in inches) | | | | | | | | | | |
|------------------------------------|-------|---|----|----|----|----|----|----|----|----|
| HEIGHT | WIDTH | | | | | | | | | |
| | 6 | 8 | 10 | 12 | 14 | 16 | 18 | 20 | 24 | 30 |
| 4 | | ❖ | | | ❖ | | | | | |
| 6 | ❖ | ❖ | ❖ | ❖ | ❖ | | | | | ❖ |
| 8 | | ❖ | | | ❖ | | | | | |
| 10 | | | ❖ | | ❖ | | | | | |
| 12 | | | | ❖ | | | | | | |
| 14 | | | | | ❖ | | | | | |
| 16 | | | | | | ❖ | | | | |
| 18 | | | | | | | ❖ | | | |
| 20 | | | | | | | | ❖ | | |
| 24 | | | | | | | | | ❖ | |

* PLEASE CONTACT US FOR ALL SIZES NOT LISTED

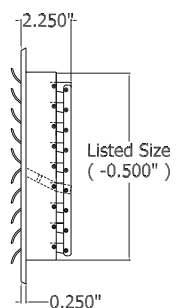
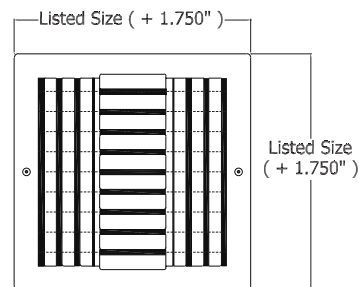
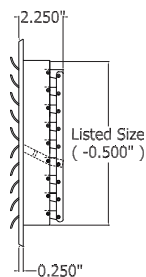
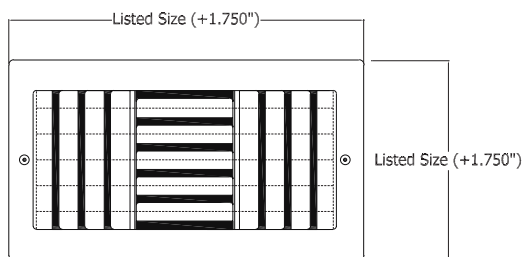



STAMPED CURVED BLADE SUPPLY: Side Wall/Ceiling

Stamped Curved Blade Supply

Model 401M One Way



| 401M - Available Sizes (in inches) | | | | | | | | | |
|------------------------------------|-------|---|----|----|----|----|----|----|----|
| HEIGHT | WIDTH | | | | | | | | |
| | 6 | 8 | 10 | 12 | 14 | 16 | 18 | 20 | 24 |
| 4 | | ❖ | ❖ | ❖ | ❖ | | | | |
| 6 | ❖ | ❖ | ❖ | ❖ | ❖ | ❖ | | | |
| 8 | | ❖ | ❖ | ❖ | ❖ | | | | |
| 10 | | | ❖ | ❖ | ❖ | | | | |
| 12 | | | | ❖ | ❖ | | | | |
| 14 | | | | | ❖ | | | | |
| 16 | | | | | | | | | |
| 18 | | | | | | | | | |

Model 402HM Two Way Horizontal

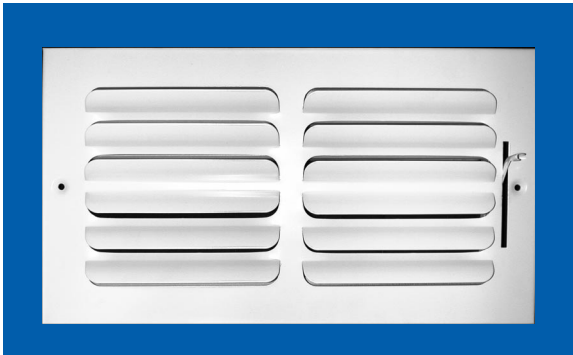

| 402M - Available Sizes (in inches) | | | | | | | | | |
|------------------------------------|-------|---|---|----|----|----|----|----|----|
| HEIGHT | WIDTH | | | | | | | | |
| | 4 | 6 | 8 | 10 | 12 | 14 | 16 | 18 | 20 |
| 2 | | | | | | | | | |
| 4 | | | ❖ | ❖ | ❖ | ❖ | | | |
| 6 | | | ❖ | ❖ | ❖ | ❖ | | | ❖ |
| 8 | | | ❖ | ❖ | ❖ | ❖ | | | |
| 10 | | | | ❖ | ❖ | ❖ | | | |
| 12 | | | | | ❖ | ❖ | | | |
| 14 | | | | | | ❖ | | | |
| 16 | | | | | | | | | |

Model 402VM Two Way Vertical

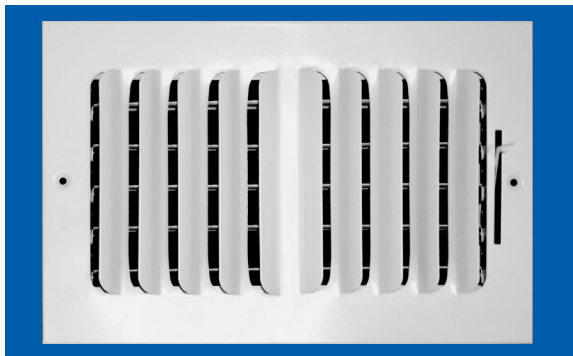

| 402VM - Available Sizes (in inches) | | | | | | | | | |
|-------------------------------------|-------|---|---|----|----|----|----|----|----|
| HEIGHT | WIDTH | | | | | | | | |
| | 4 | 6 | 8 | 10 | 12 | 14 | 16 | 18 | 20 |
| 2 | | | | | | | | | |
| 4 | | | ❖ | ❖ | | ❖ | | | |
| 6 | | | | ❖ | ❖ | ❖ | | | ❖ |
| 8 | | | | | ❖ | ❖ | | | |
| 10 | | | | | | | | | |
| 12 | | | | | | | | | |
| 14 | | | | | | | | | |
| 16 | | | | | | | | | |

400 Series Registers

- ❖ 1, 2, 3, and 4-way air patterns on face with multi-louver shutter damper in rear
- ❖ Single lever operated multi-louver shutter
- ❖ Counter-sunk screw holes with 1/4" hexagonal screws (provided)
- ❖ Finished with white powder coating
- ❖ Each grille is individually shrink wrapped

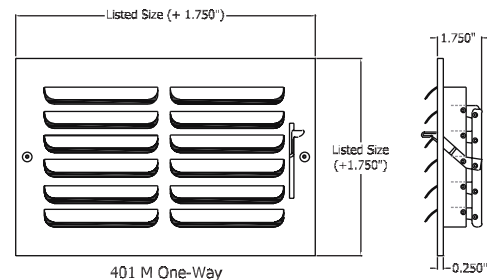

Model 403M Three Way



403M - Available Sizes (in inches)

| HEIGHT | WIDTH | | | | | | | | | |
|--------|-------|---|---|----|----|----|----|----|----|--|
| | 4 | 6 | 8 | 10 | 12 | 14 | 16 | 18 | 20 | |
| 2 | | | | | | | | | | |
| 4 | | | ✦ | ✦ | ✦ | ✦ | | | | |
| 6 | | ✦ | ✦ | ✦ | ✦ | ✦ | ✦ | | | |
| 8 | | | ✦ | ✦ | ✦ | ✦ | | | | |
| 10 | | | | ✦ | ✦ | ✦ | | | | |
| 12 | | | | | ✦ | ✦ | | | | |
| 14 | | | | | | ✦ | | | | |
| 16 | | | | | | | ✦ | | | |

Model 404M Four Way



404M - Available Sizes (in inches)

| HEIGHT | WIDTH | | | | | | | | | |
|--------|-------|---|---|----|----|----|----|----|----|--|
| | 4 | 6 | 8 | 10 | 12 | 14 | 16 | 18 | 20 | |
| 2 | | | | | | | | | | |
| 4 | | | | | | | | | | |
| 6 | | ✦ | | | | | | | | |
| 8 | | | ✦ | | | | | | | |
| 10 | | | | ✦ | | | | | | |
| 12 | | | | | ✦ | | | | | |
| 14 | | | | | | ✦ | | | | |
| 16 | | | | | | | ✦ | | | |

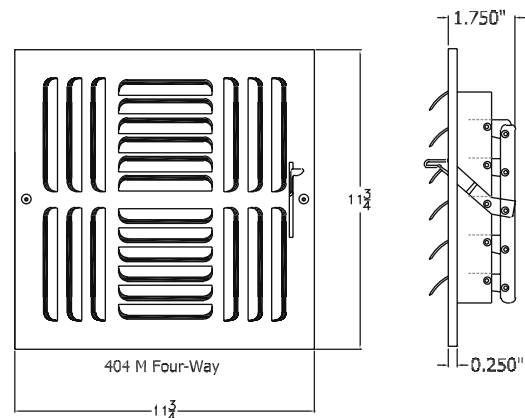
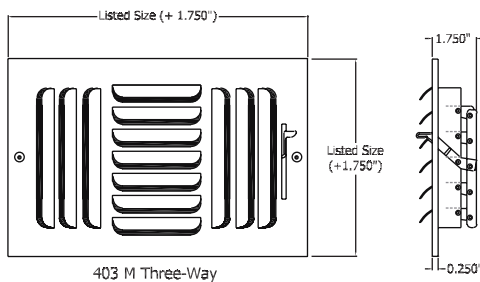



SQUARE CEILING DIRECTIONAL DIFFUSERS

Square Ceiling Diffuser

Model 560M Square Ceiling Diffuser

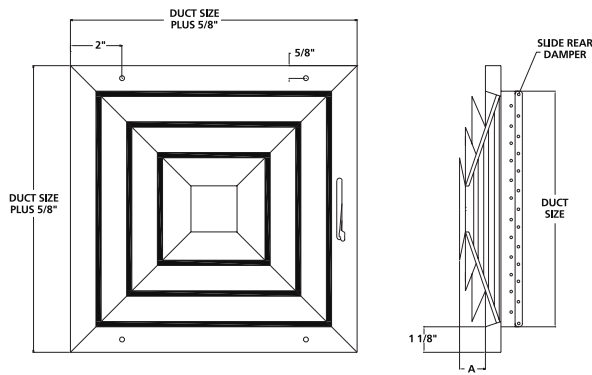
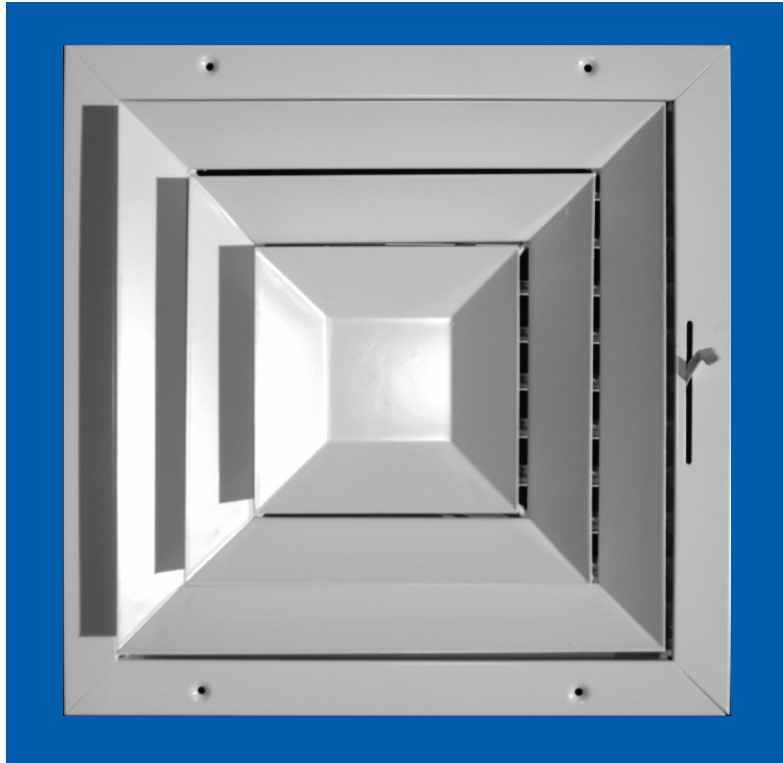

Model 560M

- ❖ Square ceiling directional diffuser
- ❖ 4-way air diffusion
- ❖ Single lever operated multi-louver shutter
- ❖ Finished with white powder coating
- ❖ Each grille is individually shrink wrapped

| 560M - Available Sizes (in inches) | | | | | | | | | |
|------------------------------------|-------|---|----|----|----|----|----|----|----|
| HEIGHT | WIDTH | | | | | | | | |
| | 6 | 8 | 10 | 12 | 14 | 16 | 18 | 20 | 22 |
| 6 | ❖ | | | | | | | | |
| 8 | | ❖ | | | | | | | |
| 10 | | | ❖ | | | | | | |
| 12 | | | | ❖ | | | | | |
| 14 | | | | | ❖ | | | | |
| 16 | | | | | | ❖ | | | |
| 18 | | | | | | | ❖ | | |
| 20 | | | | | | | | ❖ | |



Model 600M 4 Way Cooler Diffuser



| SIZE | A | B |
|---------|-----|--------|
| 10 X 10 | 13" | 10.25" |
| 10 X 10 | 13" | 10.25" |
| 12 X 12 | 15" | 12.25" |
| 14 X 14 | 17" | 14.25" |
| 16 X 16 | 19" | 16.25" |
| 18 X 18 | 21" | 18.25" |
| 20 X 20 | 23" | 20.25" |
| 22 X 22 | 25" | 22.25" |
| 24 X 24 | 27" | 24.25" |
| 26 X 26 | 29" | 26.25" |
| 30 X 30 | 33" | 30.25" |
| 32 X 32 | 35" | 32.25" |

* PLEASE CONTACT US FOR ALL SIZES NOT LISTED

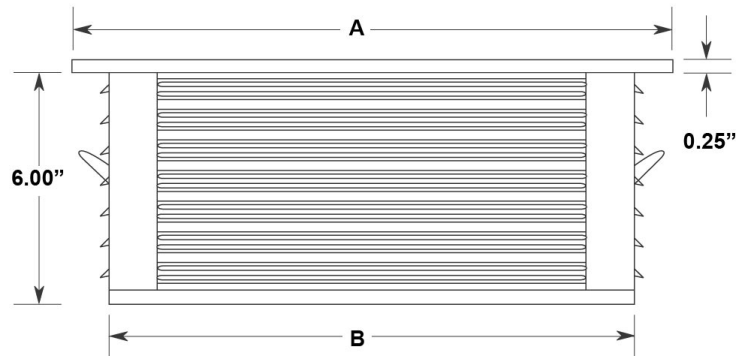

Model 600M

- ❖ Suitable for large air volume delivery from control blower system for evaporative cooling, heating and ventilation systems
- ❖ Adjustable louver shutter dampers on all four sides
- ❖ 22 gauge steel is used for longer lasting product life
- ❖ Finished with white powder coating

| 600M - Available Sizes (in inches) | | | | | | | | | | | | |
|------------------------------------|-------|----|----|----|----|----|----|----|----|----|----|----|
| HEIGHT | WIDTH | | | | | | | | | | | |
| | 10 | 12 | 14 | 16 | 18 | 20 | 22 | 24 | 26 | 28 | 30 | 32 |
| 10 | ❖ | | | | | | | | | | | |
| 12 | | ❖ | | | | | | | | | | |
| 14 | | | ❖ | | | | | | | | | |
| 16 | | | | ❖ | | | | | | | | |
| 18 | | | | | ❖ | | | | | | | |
| 20 | | | | | | ❖ | | | | | | |
| 22 | | | | | | | ❖ | | | | | |
| 24 | | | | | | | | ❖ | | | | |
| 26 | | | | | | | | | ❖ | | | |
| 28 | | | | | | | | | | ❖ | | |
| 30 | | | | | | | | | | | ❖ | |
| 32 | | | | | | | | | | | | ❖ |

* PLEASE CONTACT US FOR ALL SIZES NOT LISTED



FLUSH DIFFUSER: High Velocity Multi-Louver

High Velocity Flush Diffuser

Model 700M Flush Diffuser

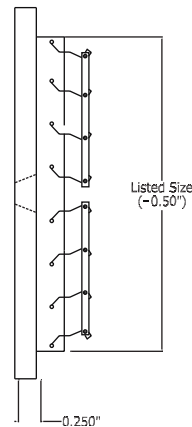
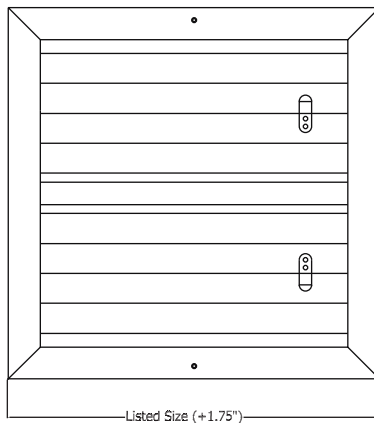

Model 700M

- ❖ Designed for evaporative air supply or high velocity air exhaust applications
- ❖ Center divided multi-louver with slit-in-handle on the frame
- ❖ Counter sunk screw holes with 2" screws (*provided*)
- ❖ Finished with white powder coating
- ❖ Each grille is individually shrink wrapped

| 700M - Available Sizes (in inches) | | | | | | | | | | |
|------------------------------------|-------|---|----|----|----|----|----|----|----|----|
| HEIGHT | WIDTH | | | | | | | | | |
| | 6 | 8 | 10 | 12 | 14 | 16 | 18 | 20 | 22 | 24 |
| 6 | ❖ | | | | | | | | | |
| 8 | | ❖ | | | | | | | | |
| 10 | | | ❖ | | | | | | | |
| 12 | | | | ❖ | | | | | | |
| 14 | | | | | ❖ | | | | | |
| 16 | | | | | | ❖ | | | | |
| 18 | | | | | | | ❖ | | | |
| 20 | | | | | | | | ❖ | | |
| 22 | | | | | | | | | ❖ | |
| 24 | | | | | | | | | | ❖ |

* PLEASE CONTACT US FOR ALL SIZES NOT LISTED

Model 800



- ❖ Round ceiling diffuser
- ❖ Step-down diffuser rings deflect air stream 360°
- ❖ All steel construction
- ❖ Finished with white powder coating

| MODEL | SIZES AVAILABLE |
|-------|---------------------------------|
| 800 | 6" • 8" • 10" • 12" • 14" • 18" |

Model 801

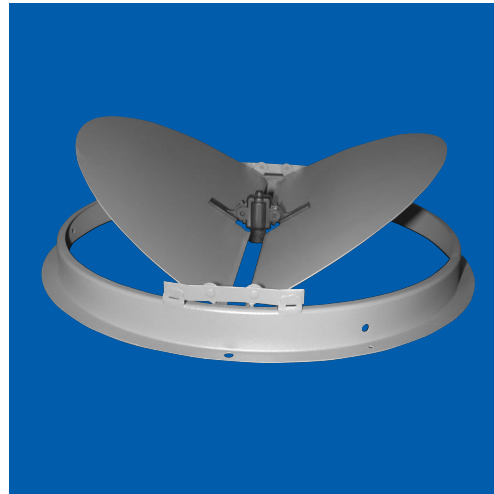

- ❖ Round duct ring with butterfly damper (assembled)
- ❖ Removable knob control
- ❖ Brown powder coat finish

| MODEL | SIZES AVAILABLE |
|-------|---------------------------------|
| 801 | 6" • 8" • 10" • 12" • 14" • 18" |

Model 802

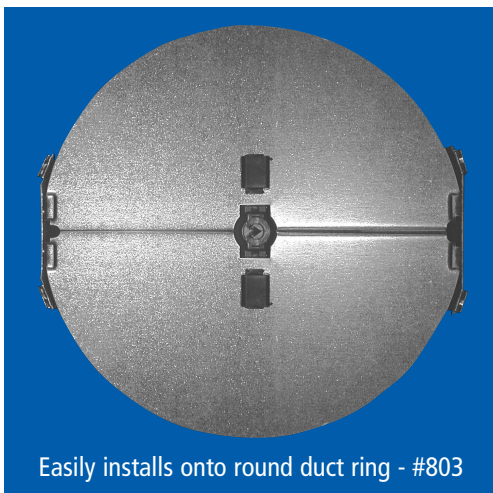

- ❖ Round butterfly damper
- ❖ Removable knob control
- ❖ All steel construction
- ❖ Brown powder coat finish

| MODEL | SIZES AVAILABLE |
|-------|---------------------------------|
| 802 | 6" • 8" • 10" • 12" • 14" • 18" |

Model 803

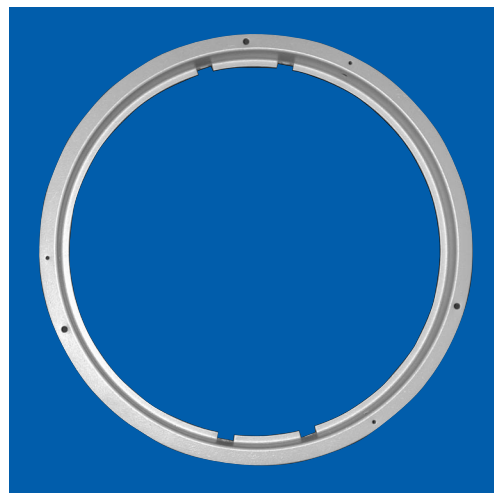

- ❖ Duct ring - to install onto a round diffuser when not using a damper
- ❖ All steel construction
- ❖ Brown powder coat finish

| MODEL | SIZES AVAILABLE |
|-------|---------------------------------|
| 803 | 6" • 8" • 10" • 12" • 14" • 18" |



STAMPED FACE: Return Air Grille - 1/2" Spaced Fin

Return Air Grille - 1/2" Spaced Fin

Model 170

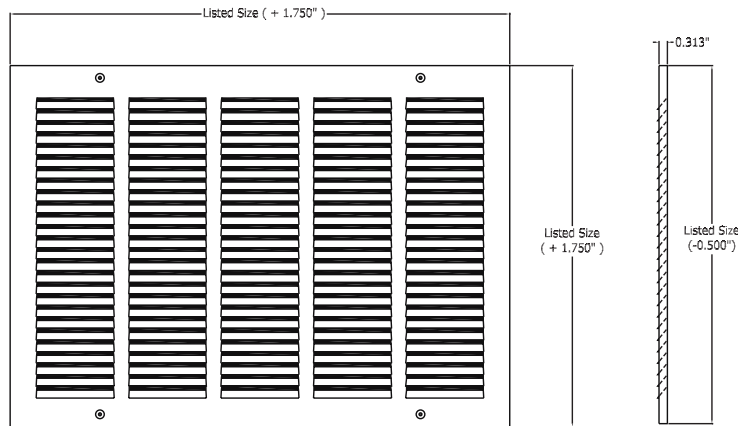
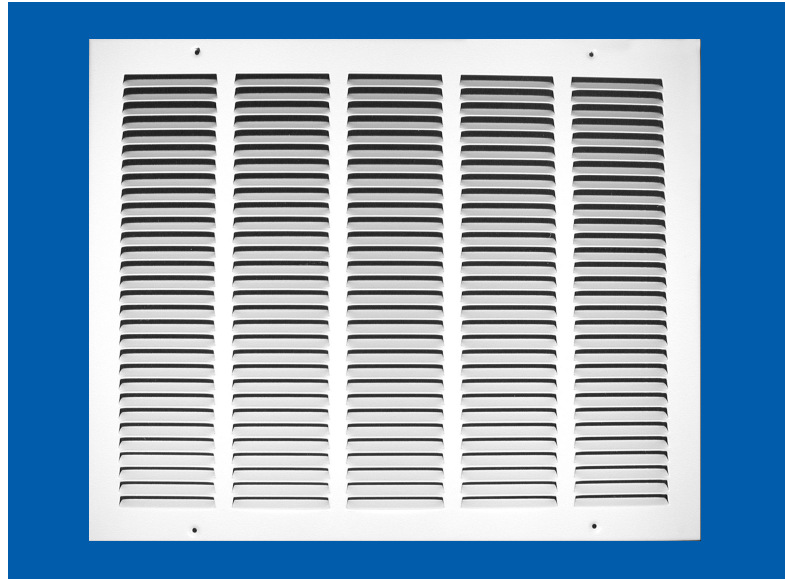

Model 170

- ❖ 1/2" louver spaced in dual angular formation for greater strength and maximum area
- ❖ Counter-sunk screw holes with 2" screws *(provided)*
- ❖ Finished with white powder coating
- ❖ Each grille is individually shrink wrapped

| 170 - Available Sizes (in inches) | | | | | | | | | | | | | | |
|-----------------------------------|-------|---|----|----|----|----|----|----|----|----|----|----|----|----|
| HEIGHT | WIDTH | | | | | | | | | | | | | |
| | 6 | 8 | 10 | 12 | 14 | 16 | 18 | 20 | 24 | 25 | 26 | 30 | 36 | 40 |
| 2 | | | | | | | | | ❖ | | | ❖ | | |
| 4 | ❖ | ❖ | ❖ | ❖ | ❖ | ❖ | ❖ | ❖ | ❖ | | | ❖ | | |
| 6 | ❖ | ❖ | ❖ | ❖ | ❖ | ❖ | ❖ | ❖ | ❖ | | | ❖ | ❖ | ❖ |
| 8 | | ❖ | ❖ | ❖ | ❖ | ❖ | ❖ | ❖ | ❖ | | | ❖ | ❖ | |
| 10 | | | ❖ | ❖ | ❖ | ❖ | ❖ | ❖ | ❖ | | | ❖ | ❖ | |
| 12 | | | ❖ | ❖ | ❖ | ❖ | ❖ | ❖ | ❖ | | ❖ | ❖ | ❖ | |
| 14 | | ❖ | ❖ | ❖ | ❖ | ❖ | ❖ | ❖ | ❖ | ❖ | ❖ | ❖ | ❖ | |
| 16 | | | ❖ | ❖ | ❖ | ❖ | ❖ | ❖ | ❖ | ❖ | ❖ | ❖ | ❖ | |
| 18 | | | | ❖ | ❖ | ❖ | ❖ | ❖ | ❖ | | | ❖ | ❖ | |
| 20 | | | ❖ | ❖ | ❖ | ❖ | ❖ | ❖ | ❖ | ❖ | | ❖ | ❖ | ❖ |
| 24 | | | | ❖ | ❖ | ❖ | ❖ | ❖ | ❖ | | | ❖ | ❖ | |
| 25 | | | | | ❖ | ❖ | ❖ | ❖ | ❖ | | | ❖ | ❖ | |
| 30 | | | ❖ | ❖ | ❖ | | ❖ | ❖ | ❖ | | | ❖ | ❖ | |
| 32 | | | | | | | | ❖ | ❖ | | | | | |
| 36 | | | | | ❖ | | ❖ | ❖ | | | | | ❖ | |

Model 173

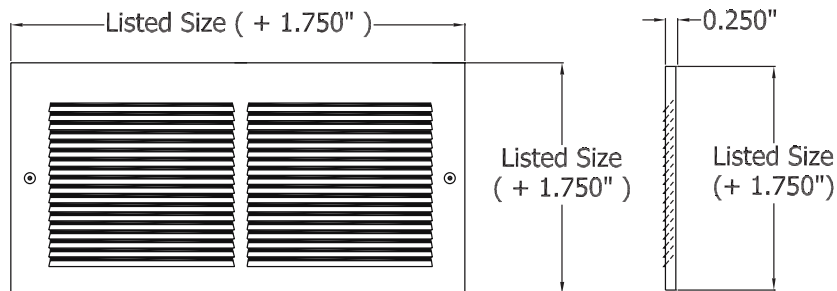
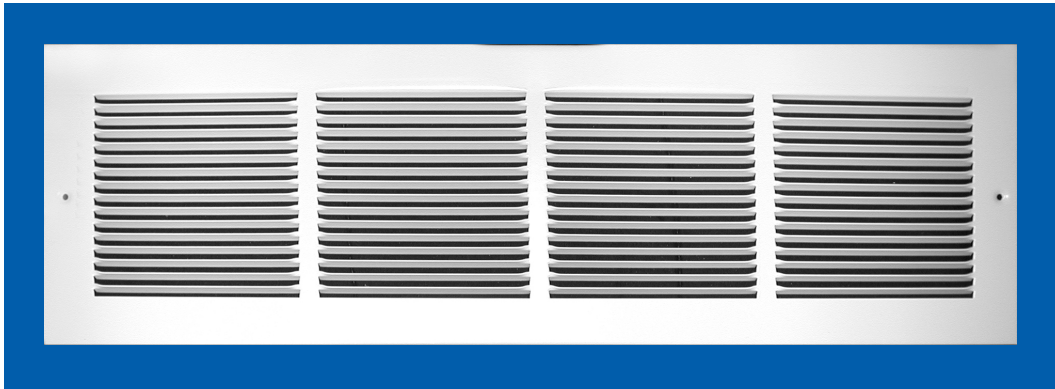

Model 173

- ❖ 1/3" louver spaced in dual angular formation for greater strength and maximum area
- ❖ Counter-sunk screw holes with 2" screws (provided)
- ❖ Finished with white powder coating
- ❖ Each grille is individually shrink wrapped

| HEIGHT | WIDTH | | | | | | |
|--------|-------|----|----|----|----|----|----|
| | 8 | 10 | 12 | 14 | 20 | 24 | 30 |
| 4 | ❖ | | | | | | |
| 6 | ❖ | ❖ | ❖ | ❖ | ❖ | ❖ | |
| 8 | | ❖ | ❖ | ❖ | ❖ | ❖ | |
| 10 | | | | ❖ | ❖ | ❖ | ❖ |
| 12 | | | | ❖ | | ❖ | ❖ |

* PLEASE CONTACT US FOR ALL SIZES NOT LISTED



BAR TYPE STEEL: Return Air Grilles

Model 270 Shown Closed



270 Series Registers

- ❖ Fixed horizontal blade return air grille
- ❖ Front fin angle is fixed at 45° in 1/2" spacing
- ❖ Counter-sunk screw holes with 1/4" hexagon-head screws (provided)
- ❖ Finished with white powder coating
- ❖ Each grille is individually shrink wrapped

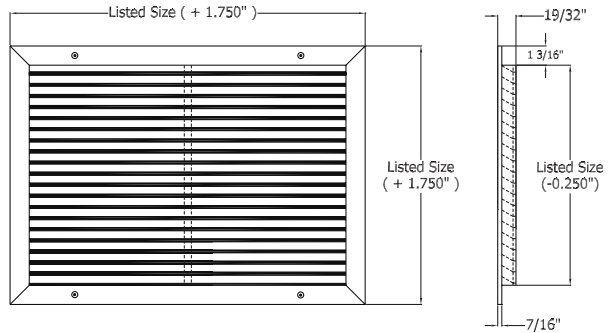

| 270 - Available Sizes (in inches) | | | | | | | | | | | | | | | | |
|-----------------------------------|-------|---|----|----|----|----|----|----|----|----|----|----|----|----|----|----|
| HEIGHT | WIDTH | | | | | | | | | | | | | | | |
| | 6 | 8 | 10 | 12 | 14 | 16 | 18 | 20 | 24 | 25 | 26 | 28 | 30 | 36 | 38 | 40 |
| 4 | | ❖ | ❖ | ❖ | ❖ | | | | ❖ | | | | ❖ | | | |
| 6 | ❖ | ❖ | ❖ | ❖ | ❖ | ❖ | ❖ | ❖ | ❖ | | | | ❖ | ❖ | | |
| 8 | | ❖ | ❖ | ❖ | ❖ | ❖ | ❖ | ❖ | ❖ | | | | ❖ | ❖ | | |
| 10 | | | ❖ | ❖ | ❖ | ❖ | ❖ | ❖ | ❖ | | | | ❖ | ❖ | | |
| 12 | | | | ❖ | ❖ | ❖ | ❖ | ❖ | ❖ | | ❖ | | ❖ | ❖ | | |
| 14 | | | | | ❖ | ❖ | ❖ | ❖ | ❖ | ❖ | | ❖ | ❖ | ❖ | ❖ | |
| 16 | | | | | | ❖ | | ❖ | ❖ | ❖ | ❖ | | ❖ | ❖ | ❖ | ❖ |
| 18 | | | ❖ | | | | ❖ | ❖ | ❖ | | | ❖ | ❖ | ❖ | | |
| 20 | | | ❖ | | ❖ | | | ❖ | ❖ | ❖ | | | ❖ | ❖ | | ❖ |
| 24 | | | | ❖ | ❖ | ❖ | | ❖ | ❖ | | | | ❖ | ❖ | | |
| 26 | | | | | | | | | | | | | ❖ | | | |
| 30 | | | | | ❖ | | | ❖ | ❖ | | | | ❖ | | | |
| 36 | | | | ❖ | | | ❖ | | | | | | | | | |
| 40 | | | | | | | | | | | | | ❖ | | | |

* PLEASE CONTACT US FOR ALL SIZES NOT LISTED

STAMPED FACE: Return Air Filter Grilles



Model 190 Shown Closed



Model 190 Shown Open - Hinged



- ❖ 1/2" louver spaced in dual angular formation for greater strength and maximum area
- ❖ Sturdy steel case is en-framed for a 1" air filter (not included)
- ❖ Counter-sunk screw holes with 1/4" hexagon-head screws (provided)
- ❖ Top latch and bottom hinge
- ❖ Finished with white powder coating
- ❖ Each grille is individually shrink wrapped

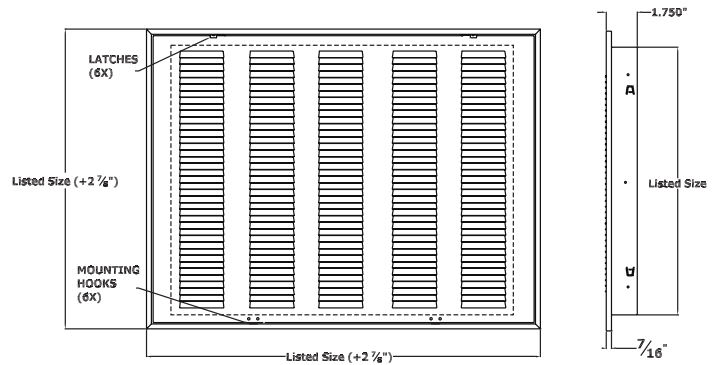

| 190 - Available Sizes (in inches) | | | | | | | | | | | | | | | | | |
|-----------------------------------|-------|----|----|----|----|----|----|----|----|----|----|----|----|----|----|----|----|
| HEIGHT | WIDTH | | | | | | | | | | | | | | | | |
| | 8 | 10 | 12 | 14 | 16 | 18 | 20 | 22 | 24 | 25 | 26 | 29 | 30 | 32 | 36 | 40 | 50 |
| 6 | | | | | | | ❖ | | ❖ | | | | ❖ | | | | |
| 8 | ❖ | | | ❖ | | | ❖ | | ❖ | | | | ❖ | | | | |
| 10 | | ❖ | | ❖ | ❖ | ❖ | ❖ | ❖ | ❖ | | | | ❖ | ❖ | ❖ | ❖ | |
| 12 | | | ❖ | | | ❖ | ❖ | ❖ | ❖ | ❖ | | | ❖ | | ❖ | | |
| 14 | | | | ❖ | ❖ | ❖ | ❖ | ❖ | ❖ | ❖ | ❖ | | ❖ | | ❖ | | |
| 16 | | | | | ❖ | | ❖ | ❖ | ❖ | ❖ | ❖ | ❖ | | ❖ | | ❖ | |
| 18 | | | ❖ | | | ❖ | ❖ | ❖ | ❖ | ❖ | | | ❖ | | ❖ | | |
| 20 | | ❖ | ❖ | ❖ | ❖ | ❖ | ❖ | ❖ | ❖ | ❖ | | | ❖ | | ❖ | ❖ | ❖ |
| 22 | | | | | | | | ❖ | | | | ❖ | ❖ | | | | |
| 24 | | ❖ | ❖ | ❖ | ❖ | ❖ | ❖ | | ❖ | | | | ❖ | | ❖ | | |
| 25 | | | | ❖ | ❖ | | ❖ | | | ❖ | | | | | | | |
| 26 | | | | ❖ | | | | | | | | | | | | | |
| 29 | | | | | | | | ❖ | | | | | | | | | |
| 30 | | | ❖ | ❖ | ❖ | ❖ | ❖ | | ❖ | | | | ❖ | | ❖ | | |
| 32 | | | | | | | | | | ❖ | | | | | | | |
| 36 | | | ❖ | ❖ | ❖ | ❖ | ❖ | | ❖ | | | | | | ❖ | | |
| 40 | | | | | | | | | ❖ | | | | | | | | |
| 50 | | | | | | | | | ❖ | | | | | | | | |

* PLEASE CONTACT US FOR ALL SIZES NOT LISTED



STAMPED FACE: Return Air Filter Grilles

Model 190RF Shown Closed

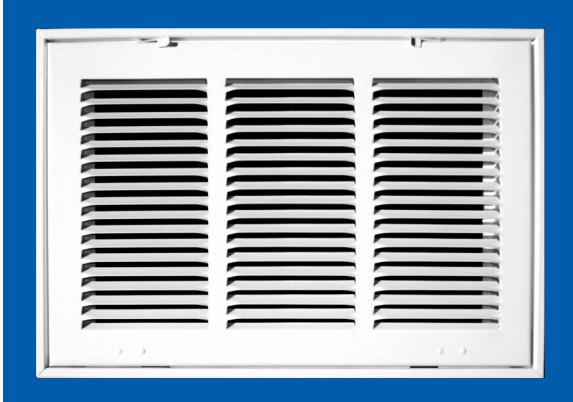

Model 190RF Shown Open - Removable Face

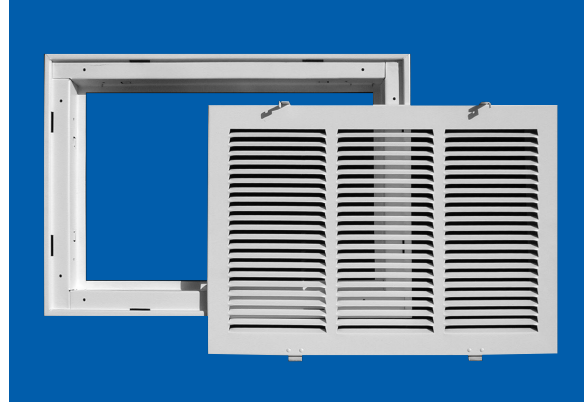

- ❖ 1/2" louver spaced in dual angular formation for greater strength and maximum area
- ❖ Sturdy steel case is en-framed for a 1" air filter (not included)
- ❖ Counter-sunk screw holes with 1/4" hexagon-head screws (provided)
- ❖ Top latch and bottom hinge
- ❖ Finished with white powder coating
- ❖ Each grille is individually shrink wrapped

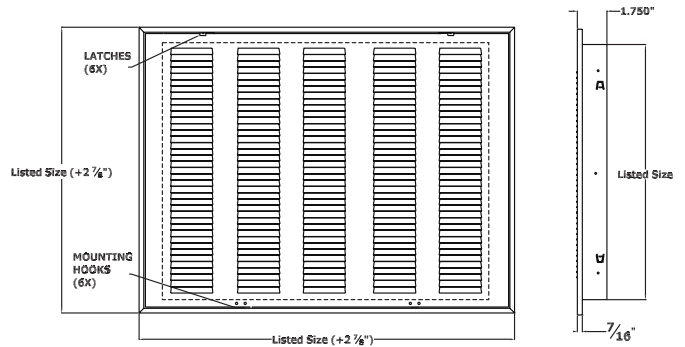

NOTE: Model 190RF features a completely removable front panel for easy-to-use access.

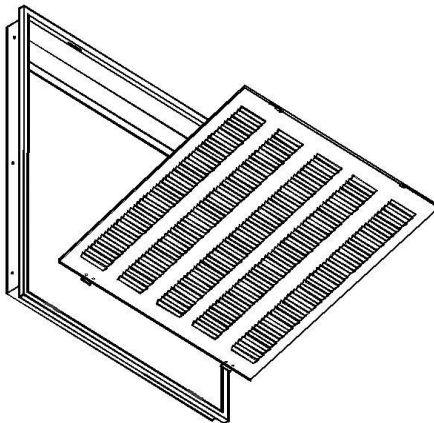

| 190RF - Available Sizes (in inches) | | | | | | | | | | |
|-------------------------------------|-------|----|----|----|----|----|----|----|----|----|
| HEIGHT | WIDTH | | | | | | | | | |
| | 10 | 12 | 14 | 16 | 18 | 20 | 24 | 25 | 30 | 36 |
| 6 | | | | | | | ❖ | | | |
| 8 | | | | | | | | | ❖ | |
| 10 | ❖ | | ❖ | ❖ | | ❖ | | | ❖ | ❖ |
| 12 | | ❖ | | | ❖ | ❖ | ❖ | | ❖ | |
| 14 | | | ❖ | | | ❖ | ❖ | ❖ | ❖ | |
| 16 | | | | ❖ | | ❖ | | ❖ | ❖ | |
| 18 | | ❖ | | | ❖ | | ❖ | | ❖ | |
| 20 | ❖ | ❖ | ❖ | ❖ | | | ❖ | ❖ | ❖ | |
| 24 | | ❖ | ❖ | ❖ | | | ❖ | ❖ | ❖ | |
| 25 | | | ❖ | ❖ | | | ❖ | | | |
| 30 | | ❖ | ❖ | ❖ | | | ❖ | | | |

* PLEASE CONTACT US FOR ALL SIZES NOT LISTED



Model 290 Shown Closed



Model 290 Shown Open

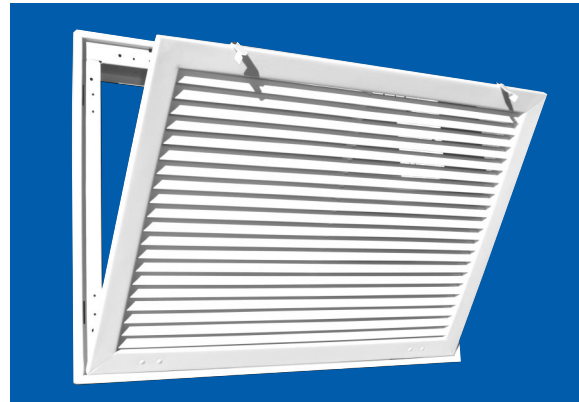

290 Series Registers

- ❖ Fixed horizontal blade return air filter grille
- ❖ Sturdy steel case is enframed for 1" air filter (*not included*)
- ❖ Front fin angle is fixed at 45° in 1/2" spacing
- ❖ Counter-sunk screw holes with 1/4" hexagon-head screws (*provided*)
- ❖ Finished with white powder coating
- ❖ Each grille is individually shrink wrapped

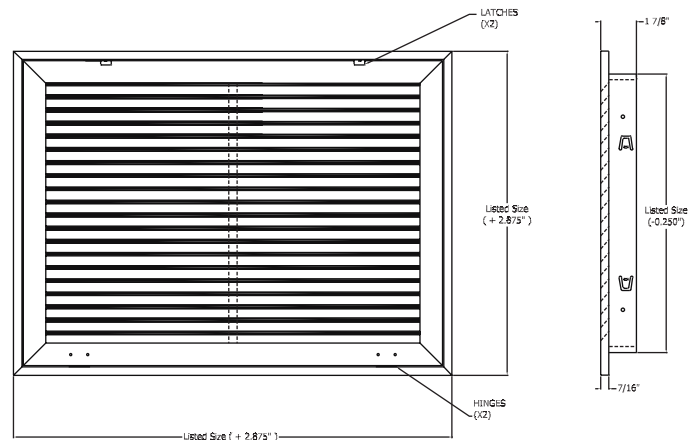

| 290 - Available Sizes (in inches) | | | | | | | | | | | | |
|-----------------------------------|-------|----|----|----|----|----|----|----|----|----|----|----|
| HEIGHT | WIDTH | | | | | | | | | | | |
| | 10 | 12 | 14 | 16 | 18 | 20 | 24 | 25 | 30 | 36 | 40 | 50 |
| 6 | | | | | | ❖ | | | | | | |
| 8 | | | ❖ | | | | | | ❖ | | | |
| 10 | ❖ | ❖ | | ❖ | | ❖ | ❖ | | ❖ | | | |
| 12 | | ❖ | | | ❖ | ❖ | ❖ | ❖ | ❖ | ❖ | | |
| 14 | | | ❖ | | | ❖ | ❖ | ❖ | ❖ | ❖ | | |
| 16 | | | | ❖ | | ❖ | ❖ | ❖ | ❖ | ❖ | | |
| 18 | | | | | ❖ | ❖ | ❖ | | ❖ | | | |
| 20 | | ❖ | ❖ | | | ❖ | ❖ | ❖ | ❖ | ❖ | ❖ | ❖ |
| 24 | | ❖ | ❖ | | | ❖ | ❖ | | ❖ | ❖ | | |
| 25 | | | | | | ❖ | | ❖ | | | | |
| 30 | | | ❖ | ❖ | ❖ | ❖ | | | | | | |
| 40 | | | | | | ❖ | | | | | | |
| 50 | | | | | | ❖ | | | | | | |

* PLEASE CONTACT US FOR ALL SIZES NOT LISTED



ACCESS DOOR: Single Panel

Access Door

Model ACD690 Access Door - Shown Closed

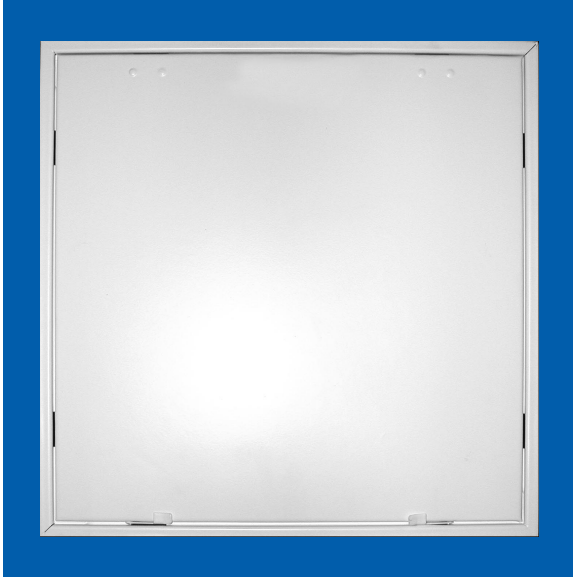

Model ACD690 Access Door - Shown Open



| Model ACD690 | |
|-----------------|---------|
| SIZES AVAILABLE | PACKAGE |
| 10 x 10 | 10 |
| 12 x 12 | 10 |
| 14 x 14 | 10 |
| 16 x 16 | 5 |
| 18 x 18 | 5 |
| 20 x 20 | 1 |

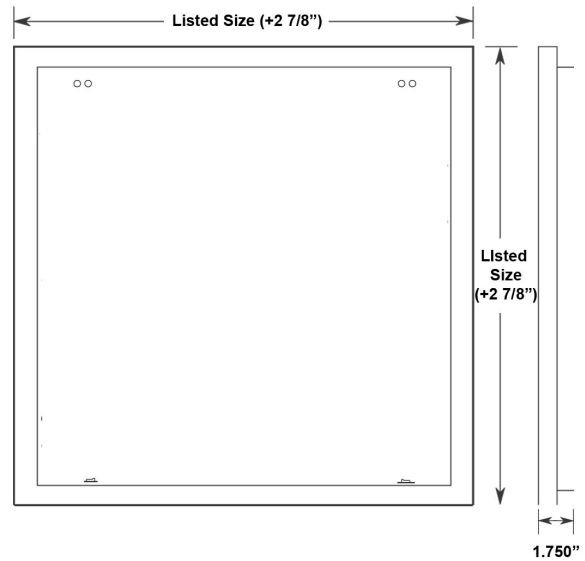

Model ACD690

- ❖ 22 gauge steel frame
- ❖ 22/24 gauge steel door panel
- ❖ Finished with white powder coating
- ❖ Hinged at top and bottom latched
- ❖ Each door panel individually shrink wrapped

Model ACD2440 Shown Closed

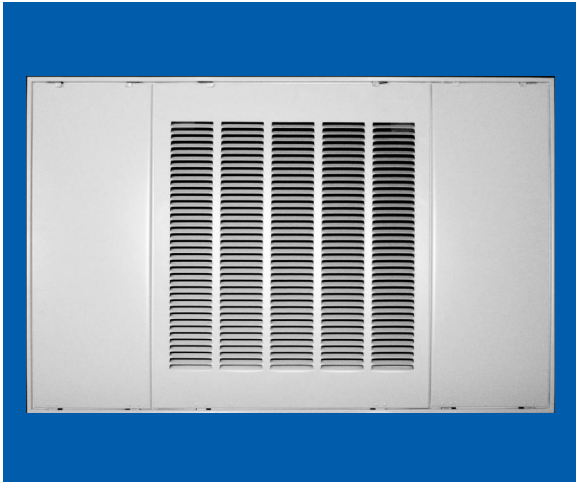

Model ACD2440 Shown Open

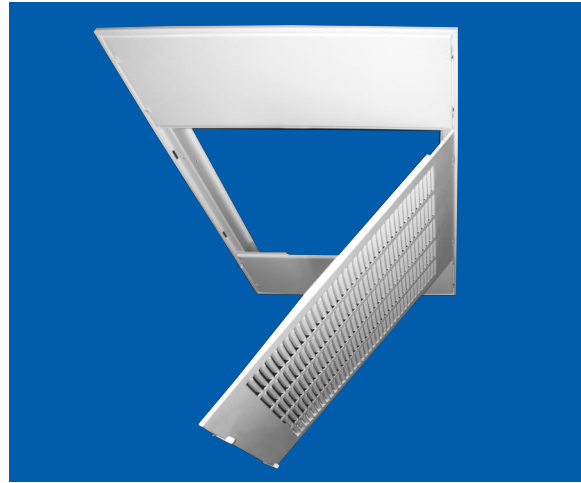

| MODEL | DESCRIPTION | PACKAGE |
|----------|-------------|---------|
| ACD2440L | 24 x 40 | 1 |
| ACD2446L | 24 x 46 | 1 |
| ACD2452L | 24 x 52 | 1 |
| ACD2460L | 24 x 60 | 1 |

| MODEL | DESCRIPTION | PACKAGE |
|----------|-------------|---------|
| ACD2440S | 24 x 40 | 1 |
| ACD2446S | 24 x 46 | 1 |
| ACD2452S | 24 x 52 | 1 |
| ACD2460S | 24 x 60 | 1 |

ACD2440 Series

- ❖ Designed for ceiling or sidewall access panel application
- ❖ Access only (solid) - Service/Return air (louvered)
- ❖ Heavy gauge steel and sturdy steel case is enframed to accept standard 20" x 20" x 1" filter (not included)
- ❖ Top mounted with hooks and bottom latched face
- ❖ 1/2" louvered spaced in dual angular formation for higher strength and maximum free area
- ❖ Easy install and maintenance
- ❖ White powder coat finish

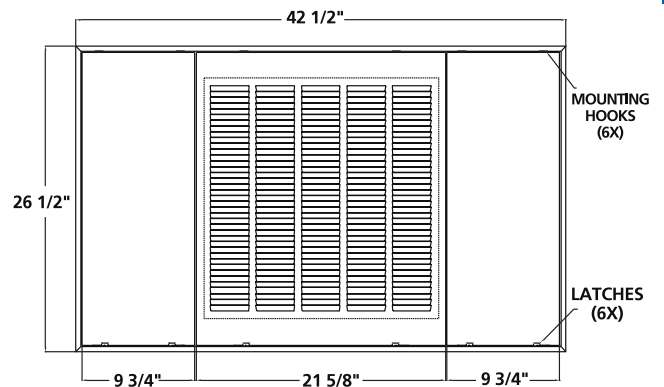

MODEL ACD2440L Shown

| MODEL | DESCRIPTION | Drywall Opening | Frame Dimensions | Access Clearance | Outside Frame Dimensions |
|----------|-------------|-----------------|-------------------|-------------------|--------------------------|
| ACD2440L | Louvered | 24" x 40" | 23 5/8" x 39 5/8" | 22 5/8" x 38 5/8" | 26 1/2" x 42 1/2" |
| ACD2440S | Solid | 24" x 40" | 23 5/8" x 39 5/8" | 22 5/8" x 38 5/8" | 26 1/2" x 42 1/2" |
| ACD2446L | Louvered | 24" x 46" | 23 5/8" x 45 5/8" | 22 5/8" x 44 5/8" | 26 1/2" x 48 1/2" |
| ACD2446S | Solid | 24" x 46" | 23 5/8" x 45 5/8" | 22 5/8" x 44 5/8" | 26 1/2" x 48 1/2" |
| ACD2452L | Louvered | 24" x 52" | 23 5/8" x 51 5/8" | 22 5/8" x 50 5/8" | 26 1/2" x 54 1/2" |
| ACD2452S | Solid | 24" x 52" | 23 5/8" x 51 5/8" | 22 5/8" x 50 5/8" | 26 1/2" x 54 1/2" |
| ACD2460L | Louvered | 24" x 60" | 23 5/8" x 59 5/8" | 22 5/8" x 58 5/8" | 26 1/2" x 62 1/2" |
| ACD2460S | Solid | 24" x 60" | 23 5/8" x 59 5/8" | 22 5/8" x 58 5/8" | 26 1/2" x 62 1/2" |

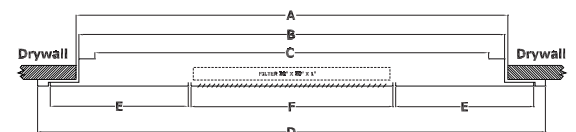



■ ■ ■ T-BAR LAY-IN: Perforated-Fiberglass Return/Supply

Model 1010MAS / MAR Front

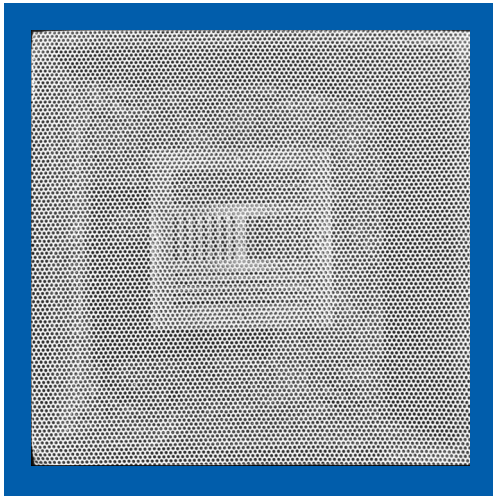

Model 1010MAS / MAR Back

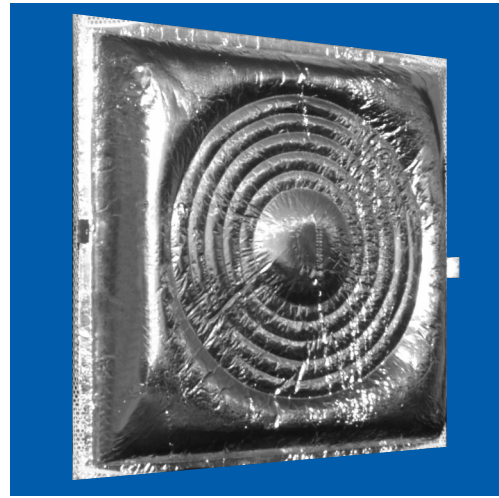

1010MAS / MAR

- ❖ Face: Perforated steel with a white powder finish
- ❖ Back: Fiberglass molded plenum / Seismic support tab
- ❖ MAS Model: 4 way directional air control blade

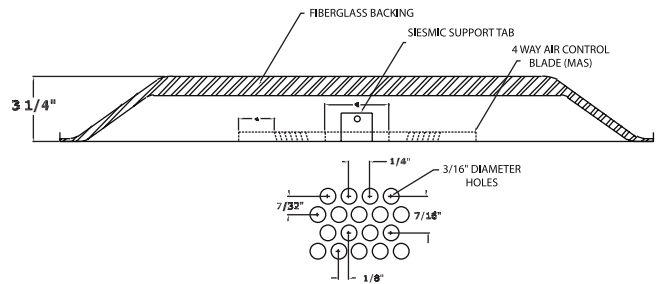

| MODEL | DESCRIPTION | PACKAGE |
|---------|------------------------|---------|
| 1010MAR | Fiberglass Back/Return | 4 |
| 1010MAS | Fiberglass Back/Supply | 4 |

Model 1020MAS / MAR Front

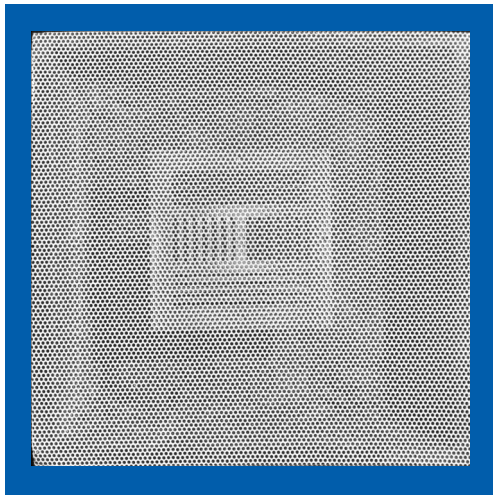

Model 1020MAS / MAR Back

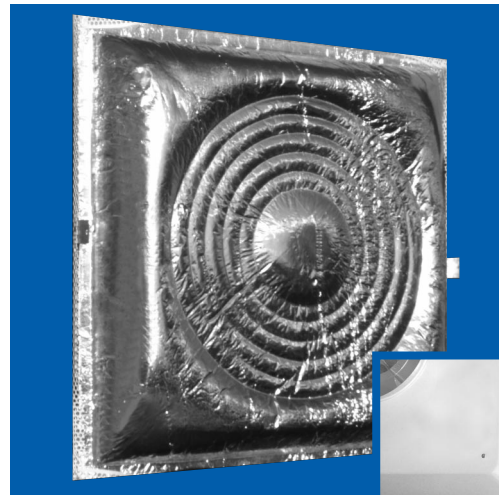

Detail

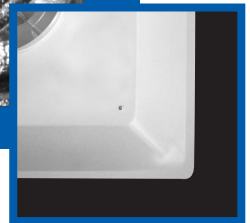

1020MAS / MAR

- ❖ Face: Perforated steel with a white powder finish
- ❖ Back: Steel / Seismic support tab
- ❖ MAS Model: 4 way directional air control blade
- ❖ Insulation Available

| MODEL | DESCRIPTION | PACKAGE |
|---------|-------------------|---------|
| 1020MAS | Steel Back/Return | 4 |
| 1020MAR | Steel Back/Supply | 4 |

T-BAR LAY-IN: Perforated T-Bar Supply/Return



T-Bar Lay-In - Perforated Return/Supply

Model 1400CB

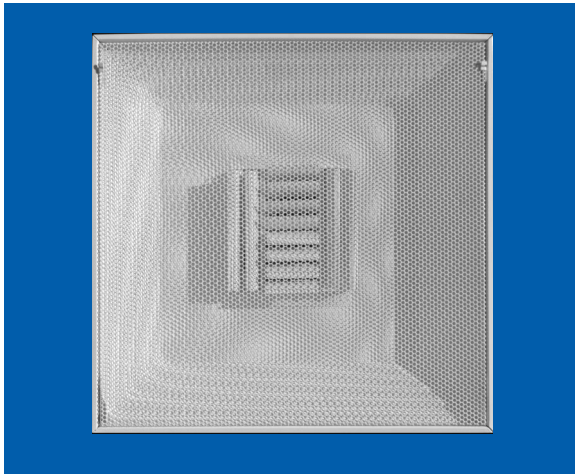

Model 1444RG

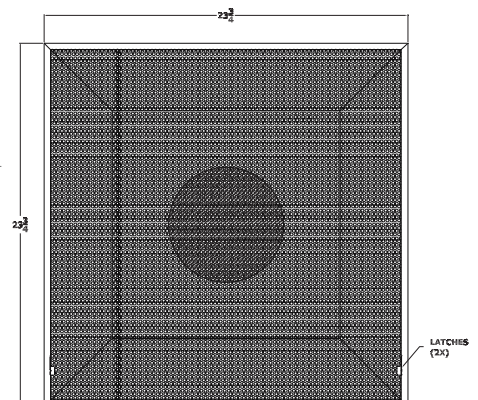
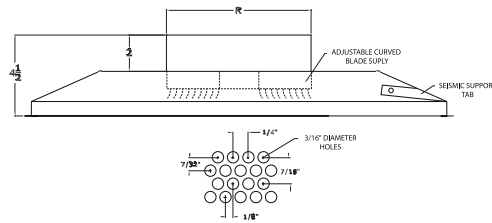
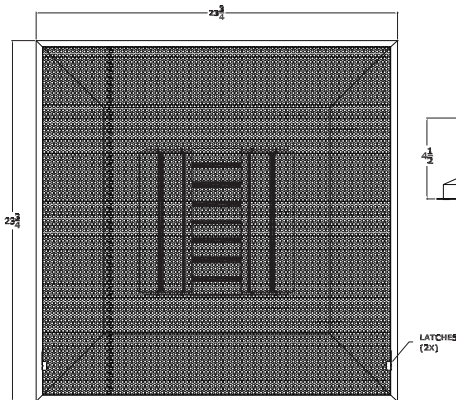
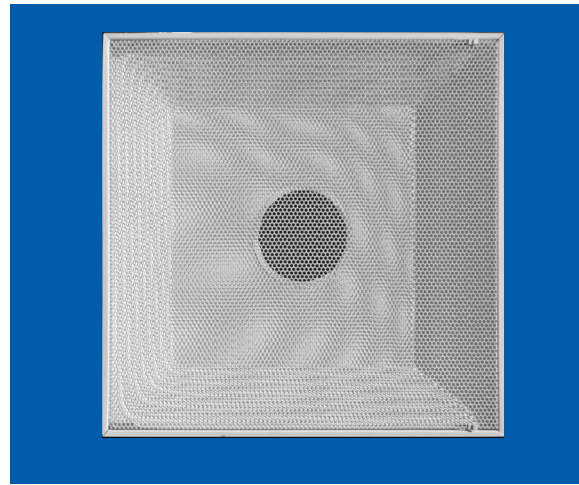

1400CB

- ❖ Perforated T-bar supply
- ❖ Adjustable curved blade supply
- ❖ Removable perforated panel
- ❖ Seismic support tab

1444RG

- ❖ Perforated T-bar return
- ❖ Removable perforated panel
- ❖ Seismic support tab

| MODEL | DESCRIPTION | PACKAGE |
|-----------|-----------------|---------|
| 1400CB-6 | 6" Round Neck | 2 |
| 1400CB-8 | 8" Round Neck | 2 |
| 1400CB-10 | 10" Round Neck | 2 |
| 1400CB-12 | 12" Round Neck | 2 |
| 1400CB-14 | 14" Round Neck | 2 |
| 1400CB-16 | 16" Round Neck | 2 |
| 1400CB-18 | 18" Round Neck | 2 |
| 1400CB-20 | 20" Round Neck | 2 |
| 1410CB-14 | 14" Square Neck | 2 |

| MODEL | DESCRIPTION | PACKAGE |
|-----------|-----------------|---------|
| 1444RG-6 | 6" Round Neck | 2 |
| 1444RG-8 | 8" Round Neck | 2 |
| 1444RG-10 | 10" Round Neck | 2 |
| 1444RG-12 | 12" Round Neck | 2 |
| 1444RG-14 | 14" Round Neck | 2 |
| 1444RG-16 | 16" Round Neck | 2 |
| 1444RG-18 | 18" Round Neck | 2 |
| 1444RG-20 | 20" Round Neck | 2 |
| 1455RG-14 | 14" Square Neck | 2 |

Model 2002CD

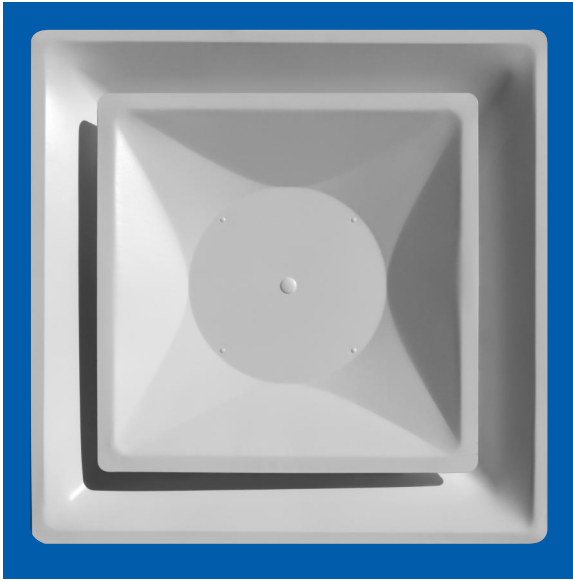

Model 2003CD

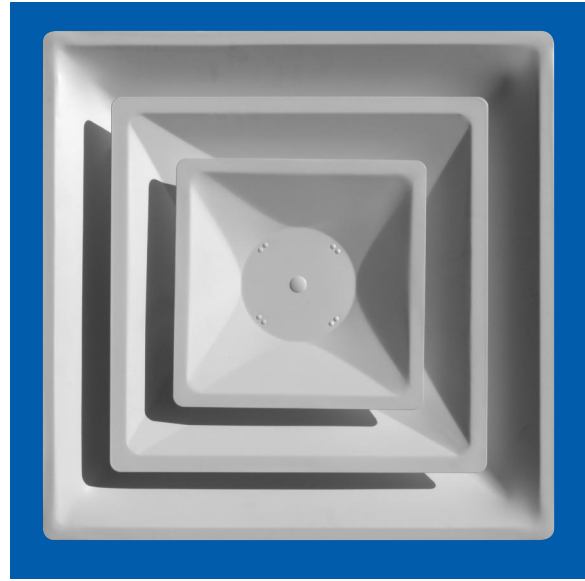

Model 2004CD

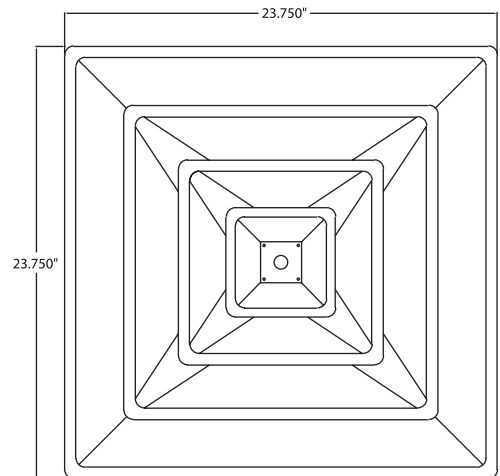
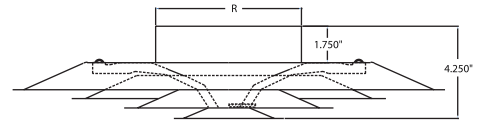

- ❖ 2 and 3 cone step-down diffusers
- ❖ Heavy Electro-Galvanized steel construction
- ❖ Finished with white powder coating
- ❖ Seismic support tab
- ❖ Also available with insulation & butterfly dampers

Model 2002CD

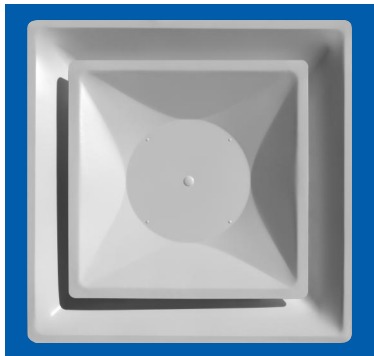

Steel Construction

| Standard | | |
|-----------|-----------------|---------|
| MODEL | DESCRIPTION | PACKAGE |
| 2002CD-6 | 6" Round Neck | 2 |
| 2002CD-8 | 8" Round Neck | 2 |
| 2002CD-10 | 10" Round Neck | 2 |
| 2002CD-12 | 12" Round Neck | 2 |
| 2002CD-14 | 14" Round Neck | 2 |
| 2010CD-14 | 14" Square Neck | 2 |

Steel Construction

| with R-6 Insulation | | |
|---------------------|-----------------|---------|
| MODEL | DESCRIPTION | PACKAGE |
| 2002CD-6IN | 6" Round Neck | 2 |
| 2002CD-8IN | 8" Round Neck | 2 |
| 2002CD-10IN | 10" Round Neck | 2 |
| 2002CD-12IN | 12" Round Neck | 2 |
| 2002CD-14IN | 14" Round Neck | 2 |
| 2010CD-14IN | 14" Square Neck | 2 |

Steel Construction

| with R-6 Insulation & Butterfly Damper | | |
|--|-----------------|---------|
| MODEL | DESCRIPTION | PACKAGE |
| 2002CD-6INBD | 6" Round Neck | 2 |
| 2002CD-8INBD | 8" Round Neck | 2 |
| 2002CD-10INBD | 10" Round Neck | 2 |
| 2002CD-12INBD | 12" Round Neck | 2 |
| 2002CD-14INBD | 14" Round Neck | 2 |
| 2010CD-14INBD | 14" Square Neck | 2 |

Model 2003CD Two Cone



Steel Construction

| Standard | | |
|-----------|-----------------|---------|
| MODEL | DESCRIPTION | PACKAGE |
| 2003CD-6 | 6" Round Neck | 2 |
| 2003CD-8 | 8" Round Neck | 2 |
| 2003CD-10 | 10" Round Neck | 2 |
| 2003CD-12 | 12" Round Neck | 2 |
| 2003CD-14 | 14" Round Neck | 2 |
| 2013CD-14 | 14" Square Neck | 2 |

Steel Construction

| with R-6 Insulation | | |
|---------------------|-----------------|---------|
| MODEL | DESCRIPTION | PACKAGE |
| 2003CD-6IN | 6" Round Neck | 2 |
| 2003CD-8IN | 8" Round Neck | 2 |
| 2003CD-10IN | 10" Round Neck | 2 |
| 2003CD-12IN | 12" Round Neck | 2 |
| 2003CD-14IN | 14" Round Neck | 2 |
| 2013CD-14IN | 14" Square Neck | 2 |

Steel Construction

| with R-6 Insulation & Butterfly Damper | | |
|--|-----------------|---------|
| MODEL | DESCRIPTION | PACKAGE |
| 2003CD-6INBD | 6" Round Neck | 2 |
| 2003CD-8INBD | 8" Round Neck | 2 |
| 2003CD-10INBD | 10" Round Neck | 2 |
| 2003CD-12INBD | 12" Round Neck | 2 |
| 2003CD-14INBD | 14" Round Neck | 2 |
| 2013CD-14INBD | 14" Square Neck | 2 |

Model 2004CD Three Cone



Steel Construction

| Standard | | |
|-----------|-----------------|---------|
| MODEL | DESCRIPTION | PACKAGE |
| 2004CD-6 | 6" Round Neck | 2 |
| 2004CD-8 | 8" Round Neck | 2 |
| 2004CD-10 | 10" Round Neck | 2 |
| 2004CD-12 | 12" Round Neck | 2 |
| 2004CD-14 | 14" Round Neck | 2 |
| 2014CD-14 | 14" Square Neck | 2 |

Steel Construction

| with R-6 Insulation | | |
|---------------------|-----------------|---------|
| MODEL | DESCRIPTION | PACKAGE |
| 2004CD-6IN | 6" Round Neck | 2 |
| 2004CD-8IN | 8" Round Neck | 2 |
| 2004CD-10IN | 10" Round Neck | 2 |
| 2004CD-12IN | 12" Round Neck | 2 |
| 2004CD-14IN | 14" Round Neck | 2 |
| 2014CD-14IN | 14" Square Neck | 2 |

Steel Construction

| with R-6 Insulation & Butterfly Damper | | |
|--|-----------------|---------|
| MODEL | DESCRIPTION | PACKAGE |
| 2004CD-6INBD | 6" Round Neck | 2 |
| 2004CD-8INBD | 8" Round Neck | 2 |
| 2004CD-10INBD | 10" Round Neck | 2 |
| 2004CD-12INBD | 12" Round Neck | 2 |
| 2004CD-14INBD | 14" Round Neck | 2 |
| 2014CD-14INBD | 14" Square Neck | 2 |

T-BAR LAY-IN: Perforated-Fiberglass Return/Supply

Model 1120 Front

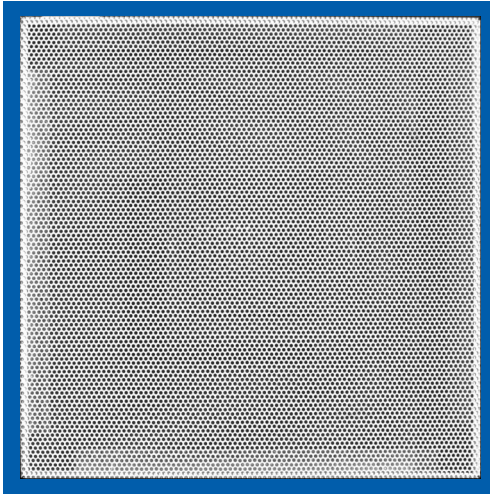

Model 1120 Back

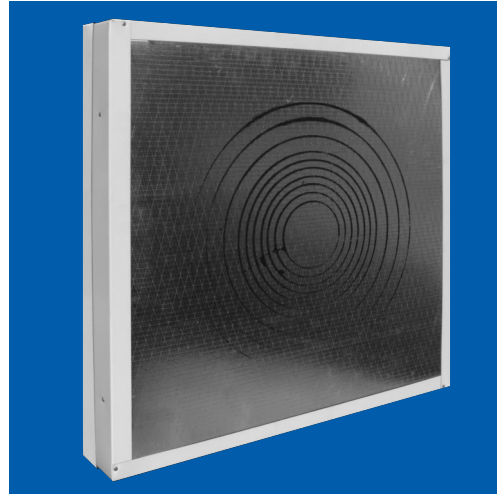

1120

- ❖ Face: Perforated steel with a white powder finish
- ❖ Supply: 4 way directional air control blade
- ❖ Available with or without 1" thick fiberglass ductboard with premarked radius and support tab

| MODEL | DESCRIPTION | PACKAGE |
|---------|-----------------------|---------|
| 1120R | Return NO ductboard | 4 |
| 1120S | Supply NO ductboard | 4 |
| 1120DBR | Return with ductboard | 4 |
| 1120DBS | Supply with ductboard | 4 |

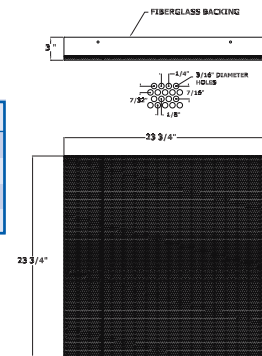

Model 1130/1140 Front

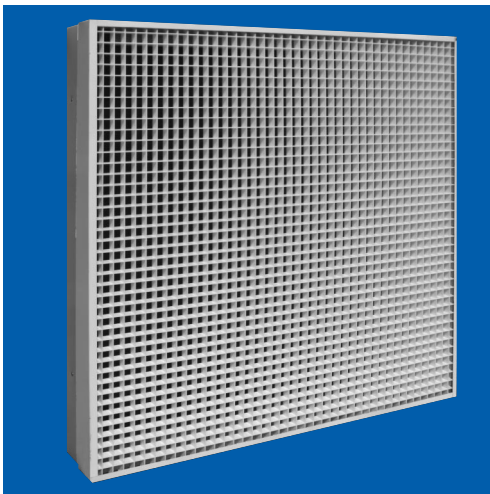

Model 1130/1140 Back

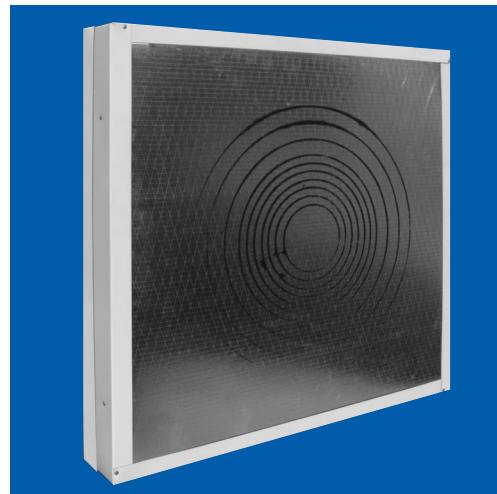

1130/1140

- ❖ Egg crate T-Bar return air grille
- ❖ 1130 - Acrylic • 1140 - Aluminum
- ❖ Available with or without 1" thick fiberglass ductboard with premarked radius and support tab

| MODEL | DESCRIPTION | SIZE | PACKAGE |
|-----------|------------------------|---------|---------|
| 1130R-1 | Acrylic/No Ductboard | 1' x 2' | 2 |
| 1130R-2 | Acrylic/No Ductboard | 2' x 2' | 2 |
| 1130R-4 | Acrylic/No Ductboard | 4' x 2' | 2 |
| 1130DBR-1 | Acrylic with Ductboard | 1' x 2' | 2 |
| 1130DBR-2 | Acrylic with Ductboard | 2' x 2' | 2 |
| 1130DBR-4 | Acrylic with Ductboard | 4' x 2' | 2 |

| MODEL | DESCRIPTION | SIZE | PACKAGE |
|-----------|-------------------------|---------|---------|
| 1140R-1 | Aluminum/No Ductboard | 1' x 2' | 2 |
| 1140R-2 | Aluminum/No Ductboard | 2' x 2' | 2 |
| 1140R-4 | Aluminum/No Ductboard | 4' x 2' | 2 |
| 1140DBR-1 | Aluminum with Ductboard | 1' x 2' | 2 |
| 1140DBR-2 | Aluminum with Ductboard | 2' x 2' | 2 |
| 1140DBR-4 | Aluminum with Ductboard | 4' x 2' | 2 |

Model 1110RG Stamped Face

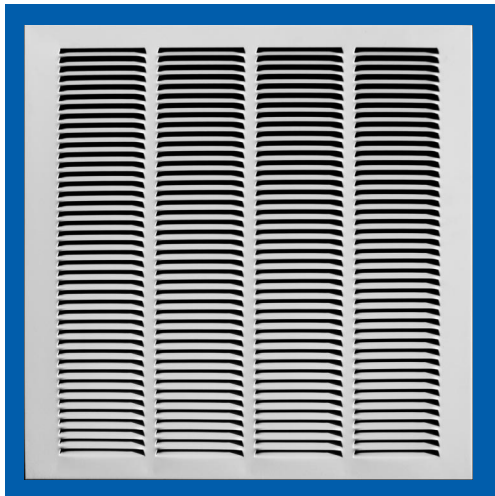

| MODEL | DESCRIPTION | PACKAGE |
|--------|--------------|---------|
| 1110RG | Stamped Face | 5 |

- ❖ Stamped 1/2" Spaced
- ❖ Steel construction
- ❖ Mount flush with T-Bar ceiling
- ❖ White powder coated

Model 1210RG Fixed Bar Type

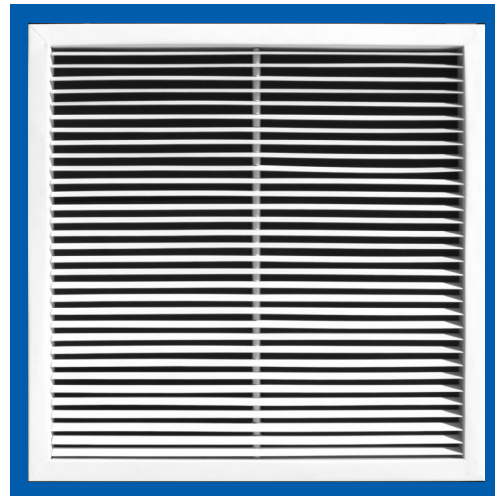

| MODEL | DESCRIPTION | PACKAGE |
|--------|----------------|---------|
| 1120RG | Fixed Bar Type | 5 |

- ❖ Fixed Bar 1/2" Spaced
- ❖ Steel construction
- ❖ Mount flush with T-Bar ceiling
- ❖ White powder coated

1920RG

- ❖ Steel construction
- ❖ Mount flush with T-Bar ceiling
- ❖ White powder coated
- ❖ Perforated Face

Model 1920RG Peforated Screen

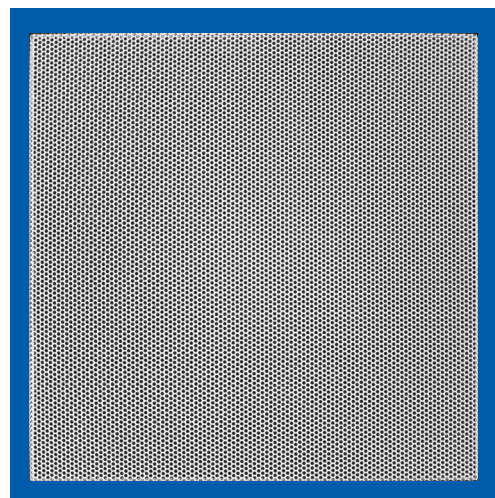

| MODEL | SIZE | PACKAGE |
|---------|---------|---------|
| 1920G/1 | 1' x 2' | 20 |
| 1920G/2 | 2' x 2' | 20 |
| 1920G/4 | 2' x 4' | 5 |



T-BAR LAY-IN: Egg Crate Return Grille

T-Bar Egg Crate Return Grille

Model 1930RG Acrylic

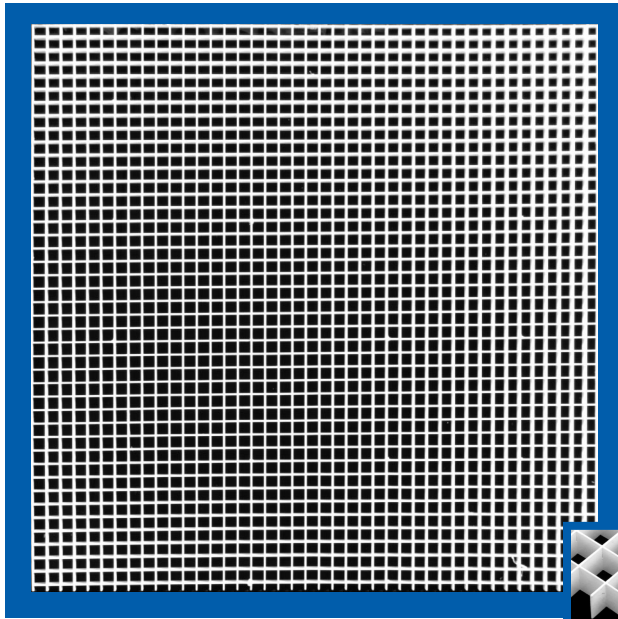

| MODEL | DESC. | SIZE | PACKAGE |
|---------|---------|---------|---------|
| 1930G/1 | Acrylic | 1' x 2' | 20 |
| 1930G/2 | Acrylic | 2' x 2' | 10 |
| 1930G/4 | Acrylic | 2' x 4' | 10 |

Acrylic



1/2" x 1/2" Acrylic Cell

Model 1940RG Aluminum

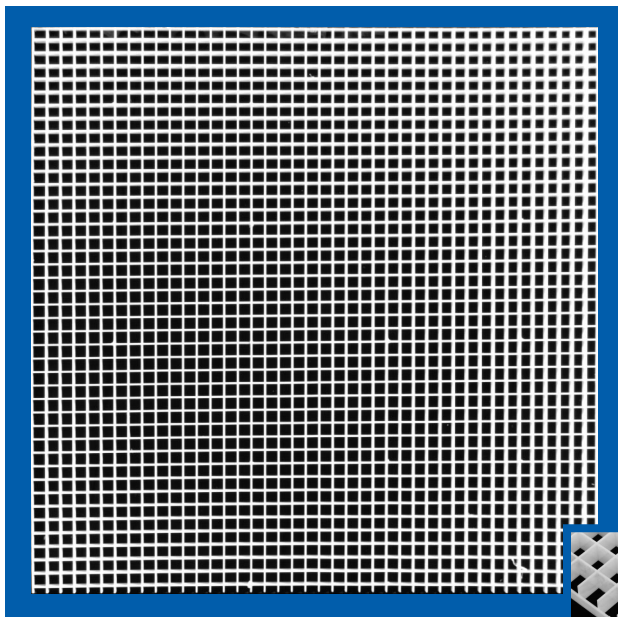

| MODEL | DESC. | SIZE | PACKAGE |
|---------|----------|---------|---------|
| 1940G/1 | Aluminum | 1' x 2' | 20 |
| 1940G/2 | Aluminum | 2' x 2' | 10 |
| 1940G/4 | Aluminum | 2' x 4' | 10 |

Aluminum

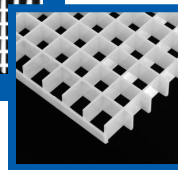

1/2" x 1/2" Aluminum Cell

Model 4010 Stamped Face

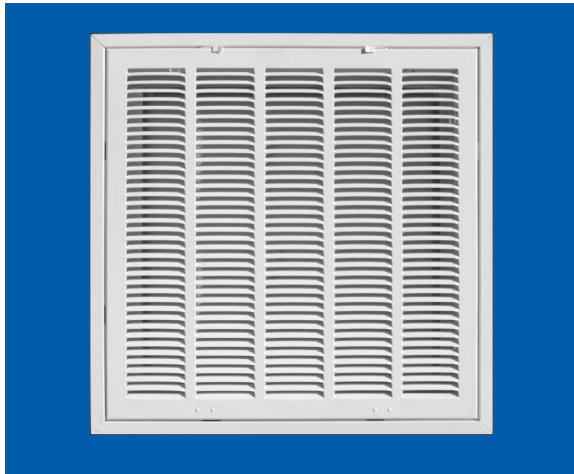

Model 4020 Fixed Blade



Model 4030 Perforated Face

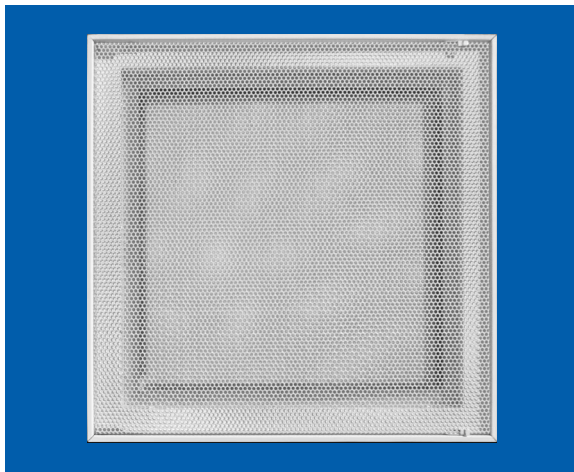

Fiberglass Backing

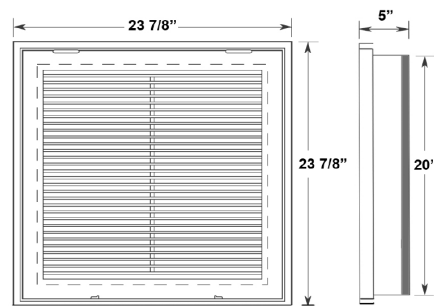
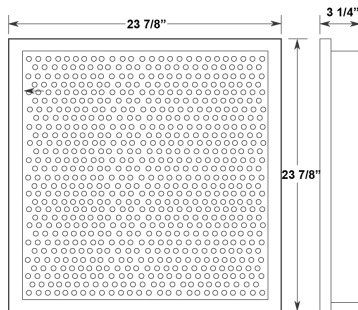
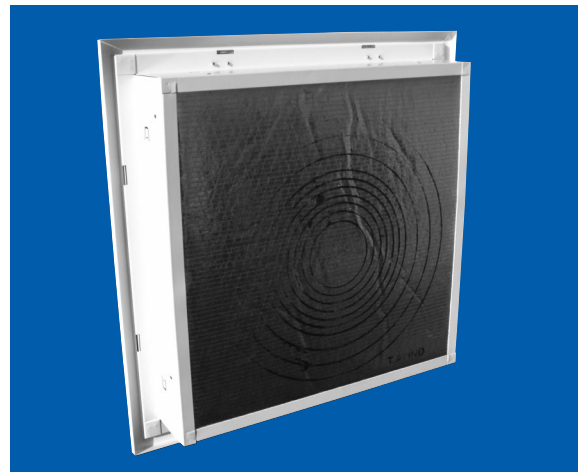

4010, 4020, 4030

- ❖ All models accept a standard 20" x 20" x 1" filter (Not included)
- ❖ Top latched and bottom hinged face for quick filter changes
- ❖ Finished with softder coating
- ❖ Available with or without fiberglass ductboard with pre-marked radius

| MODEL | DESCRIPTION | SIZE | PACKAGE |
|-----------|----------------------------------|---------|---------|
| 4010FG | Stamped Face - NO Ductboard | 2' x 2' | 2 |
| 4010FG-DB | Stamped Face - WITH Ductboard | 2' x 2' | 2 |
| 4020FG | Fixed Bar - NO Ductboard | 2' x 2' | 2 |
| 4020FG-DB | Fixed Bar - WITH Ductboard | 2' x 2' | 2 |
| 4030FG | Perforated Face - NO Ductboard | 2' x 2' | 2 |
| 4030FG-DB | Perforated Face - WITH Ductboard | 4' x 2' | 2 |



ALUMINUM BAR TYPE SUPPLY: Side Wall/Ceiling

Model A210VM Single Deflection

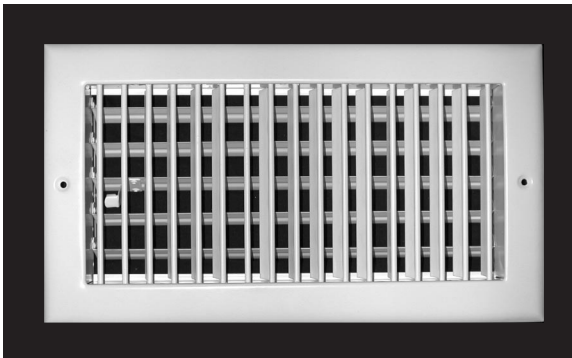

Model A230M Three-Way Deflection

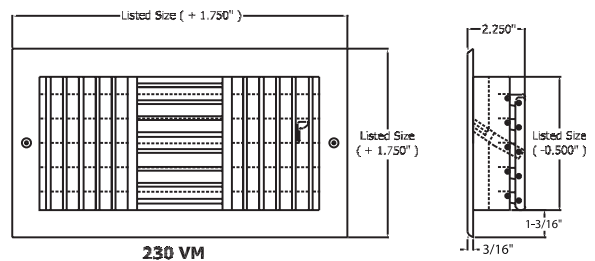
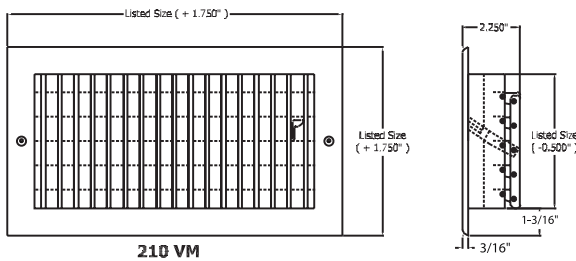
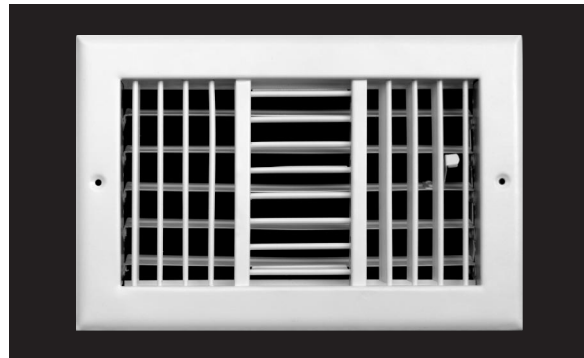

A200 Series Registers

- ❖ Aluminum single lever operated multi-louver rear damper (in steel)
- ❖ Aluminum face / Steel louver & damper
- ❖ Aluminum adjustable fins provide individual deflection control
- ❖ Counter-sunk screw holes with 1/4" hexagon-head screws (provided)
- ❖ Finished with white powder coating

Also Available *Not Shown

- A220H - Face Bar - Horizontal • 2nd Bar Vertical**
- A220V - Face Bar - Vertical • 2nd Bar Horizontal**

| A210 and A220 Series - Available Sizes (in inches) | | | | | | | | | | | |
|--|-------|---|----|----|----|----|----|----|----|----|----|
| HEIGHT | WIDTH | | | | | | | | | | |
| | 6 | 8 | 10 | 12 | 14 | 16 | 18 | 20 | 24 | 26 | 30 |
| 4 | ❖ | ❖ | ❖ | ❖ | ❖ | ❖ | ❖ | ❖ | ❖ | | ❖ |
| 6 | ❖ | ❖ | ❖ | ❖ | ❖ | ❖ | ❖ | ❖ | ❖ | | ❖ |
| 8 | | ❖ | ❖ | ❖ | ❖ | ❖ | ❖ | ❖ | ❖ | | ❖ |
| 10 | | | ❖ | ❖ | ❖ | ❖ | ❖ | ❖ | ❖ | | ❖ |
| 12 | | | | ❖ | ❖ | ❖ | ❖ | ❖ | ❖ | | ❖ |
| 14 | | | | | ❖ | ❖ | ❖ | ❖ | ❖ | | ❖ |
| 16 | | | | | | ❖ | ❖ | ❖ | ❖ | | ❖ |
| 18 | | | | | | | ❖ | ❖ | ❖ | ❖ | ❖ |
| 20 | | | | | | | | ❖ | ❖ | | ❖ |
| 24 | | | | | | | | | ❖ | | ❖ |

| A230M - Available Sizes (in inches) | | | | | | |
|-------------------------------------|-------|----|----|----|----|--|
| HEIGHT | WIDTH | | | | | |
| | 8 | 10 | 12 | 14 | 16 | |
| 4 | ❖ | ❖ | | | | |
| 6 | ❖ | ❖ | ❖ | ❖ | | |
| 8 | | ❖ | ❖ | ❖ | | |
| 10 | | | ❖ | ❖ | | |
| 12 | | | | ❖ | | |
| 14 | | | | | ❖ | |

* PLEASE CONTACT US FOR ALL SIZES NOT LISTED

ALUMINUM BAR TYPE SUPPLY: Side Wall/Ceiling



Aluminum Bar Type Register

Model A210VO Vertical with Single Deflection

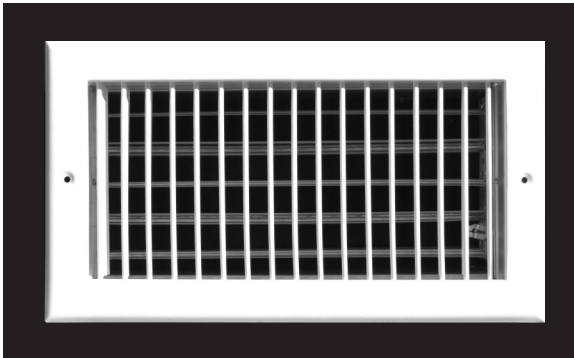

Model A220VO Vertical with Double Deflection

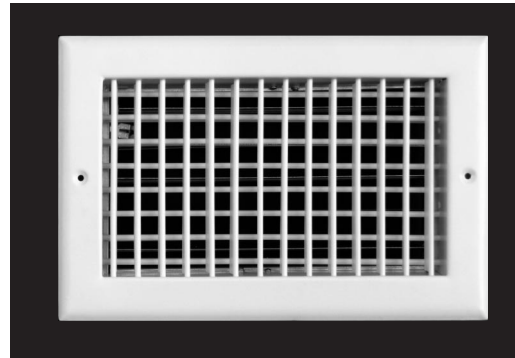

Model A220VO Reverse Side Shown

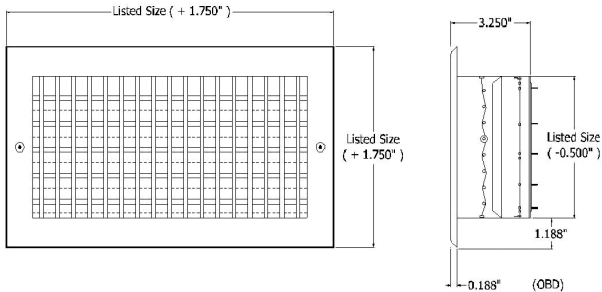
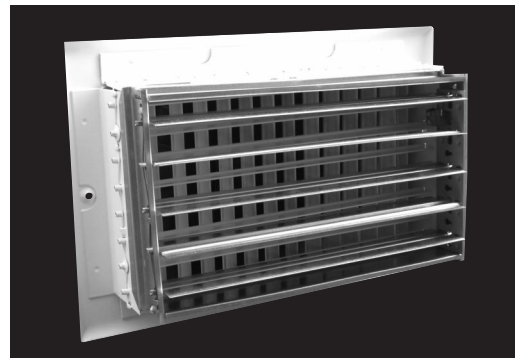

- ❖ Aluminum OBD rear damper (in steel)
- ❖ Aluminum face / Steel damper
- ❖ Aluminum adjustable fins provide individual deflection control
- ❖ Counter-sunk screw holes with 1/4" hexagon-head screws (*provided*)
- ❖ Finished with white powder coating
- ❖ Each diffuser is individually shrink wrapped

Also Available *Not Shown

A210HO - Horizontal

A220HO - Horizontal

| A210 and A220 Series - Available Sizes (in inches) | | | | | | | | | | | |
|--|-------|---|----|----|----|----|----|----|----|----|----|
| HEIGHT | WIDTH | | | | | | | | | | |
| | 6 | 8 | 10 | 12 | 14 | 16 | 18 | 20 | 24 | 26 | 30 |
| 4 | ❖ | ❖ | ❖ | ❖ | ❖ | ❖ | ❖ | ❖ | ❖ | | ❖ |
| 6 | ❖ | ❖ | ❖ | ❖ | ❖ | ❖ | ❖ | ❖ | ❖ | | ❖ |
| 8 | | ❖ | ❖ | ❖ | ❖ | ❖ | ❖ | ❖ | ❖ | | ❖ |
| 10 | | | ❖ | ❖ | ❖ | ❖ | ❖ | ❖ | ❖ | | ❖ |
| 12 | | | | ❖ | ❖ | ❖ | ❖ | ❖ | ❖ | | ❖ |
| 14 | | | | | ❖ | ❖ | ❖ | ❖ | ❖ | | ❖ |
| 16 | | | | | | ❖ | ❖ | ❖ | ❖ | | ❖ |
| 18 | | | | | | | ❖ | ❖ | ❖ | ❖ | ❖ |
| 20 | | | | | | | | ❖ | ❖ | | ❖ |
| 24 | | | | | | | | | ❖ | | ❖ |

* PLEASE CONTACT US FOR ALL SIZES NOT LISTED



■ ■ ■ ALUMINUM ADJUSTABLE CURVED BLADE SUPPLY

Model A301M / A301O One Way

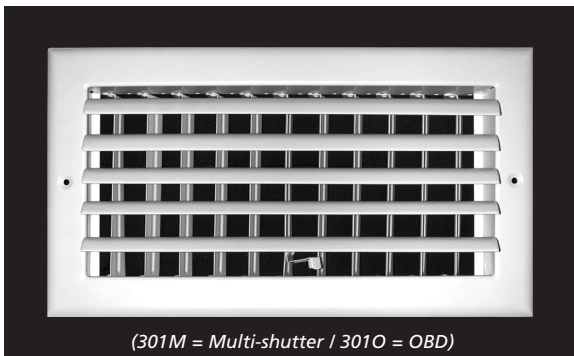

| A301 - Available Sizes (in inches) | | | | | | | | | |
|------------------------------------|-------|---|----|----|----|----|----|----|----|
| HEIGHT | WIDTH | | | | | | | | |
| | 6 | 8 | 10 | 12 | 14 | 16 | 18 | 20 | 24 |
| 4 | | ❖ | ❖ | ❖ | ❖ | ❖ | | | |
| 6 | ❖ | ❖ | ❖ | ❖ | ❖ | ❖ | ❖ | | |
| 8 | | ❖ | ❖ | ❖ | ❖ | ❖ | | ❖ | |
| 10 | | | ❖ | ❖ | ❖ | | | ❖ | |
| 12 | | | | ❖ | ❖ | | | | |
| 14 | | | | | ❖ | | | | |
| 16 | | | | | | ❖ | | | |
| 18 | | | | | | | ❖ | | |

Model A302HM / A302HO Two Way Horizontal

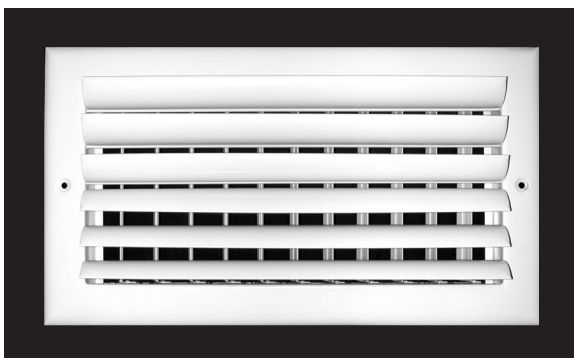

| A302M - Available Sizes (in inches) | | | | | | | | | |
|-------------------------------------|-------|---|----|----|----|----|----|----|----|
| HEIGHT | WIDTH | | | | | | | | |
| | 6 | 8 | 10 | 12 | 14 | 16 | 18 | 20 | 24 |
| 4 | | ❖ | ❖ | ❖ | ❖ | | | | |
| 6 | ❖ | ❖ | ❖ | ❖ | ❖ | | | | |
| 8 | | ❖ | ❖ | ❖ | ❖ | | | | |
| 10 | | | ❖ | ❖ | ❖ | | | | |
| 12 | | | | ❖ | | | | | |
| 14 | | | | | ❖ | | | | |
| 16 | | | | | | ❖ | | | |
| 18 | | | | | | | ❖ | | |

Model A302VM / A302VO Two Way Vertical

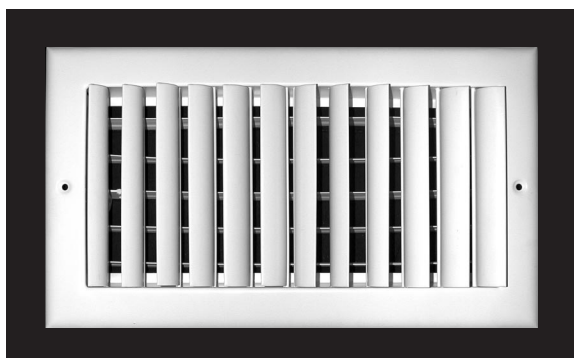

| A302VM - Available Sizes (in inches) | | | | | | | | | |
|--------------------------------------|-------|---|----|----|----|----|----|----|----|
| HEIGHT | WIDTH | | | | | | | | |
| | 6 | 8 | 10 | 12 | 14 | 16 | 18 | 20 | 24 |
| 4 | | ❖ | ❖ | ❖ | ❖ | | | | |
| 6 | ❖ | ❖ | ❖ | ❖ | ❖ | | | | |
| 8 | | ❖ | | ❖ | ❖ | | | | |
| 10 | | | ❖ | | ❖ | | | | |
| 12 | | | | ❖ | | | | | |
| 14 | | | | | ❖ | | | | |
| 16 | | | | | | ❖ | | | |
| 18 | | | | | | | ❖ | | |

A300 Series Registers

- ❖ Aluminum 1,2, 3, and 4-way air patterns
- ❖ Available with or without steel OBD
- ❖ Corner block directional air way control fin is encased in roll formed aluminum
- ❖ Aluminum face and steel louver
- ❖ Counter-sunk screw holes

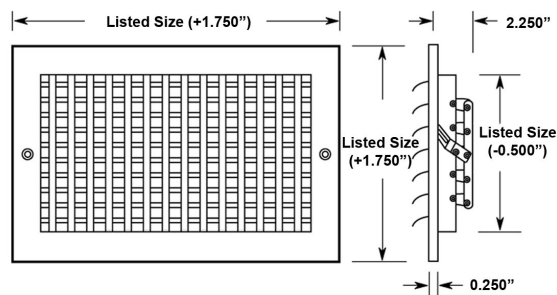

ALUMINUM ADJUSTABLE CURVED BLADE SUPPLY



Aluminum Adjustable Curved Blade Supply

Model A303M / A303O Three Way

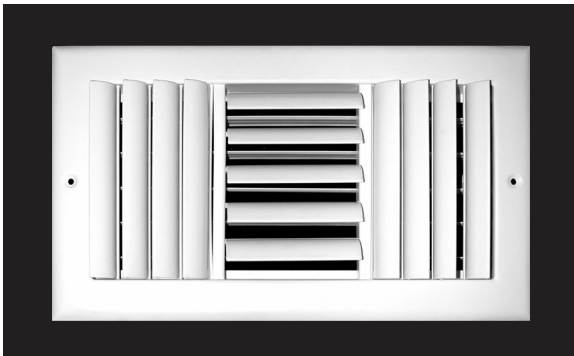

| 303M - Available Sizes (in inches) | | | | | | | | | |
|------------------------------------|-------|---|----|----|----|----|----|----|----|
| HEIGHT | WIDTH | | | | | | | | |
| | 6 | 8 | 10 | 12 | 14 | 16 | 18 | 20 | 24 |
| 4 | | ❖ | ❖ | ❖ | ❖ | | | | |
| 6 | ❖ | ❖ | ❖ | ❖ | ❖ | | | ❖ | |
| 8 | | ❖ | | ❖ | ❖ | ❖ | | ❖ | |
| 10 | | | ❖ | ❖ | ❖ | ❖ | | | |
| 12 | | | | ❖ | | | | | |
| 14 | | | | | ❖ | | | | |
| 16 | | | | | | ❖ | | | |
| 18 | | | | | | | | | |

Model A304M / A304O Four Way



| 304M - Available Sizes (in inches) | | | | | | | | | | |
|------------------------------------|-------|---|----|----|----|----|----|----|----|----|
| HEIGHT | WIDTH | | | | | | | | | |
| | 6 | 8 | 10 | 12 | 14 | 16 | 18 | 20 | 24 | 30 |
| 4 | | ❖ | | | ❖ | | | | | |
| 6 | ❖ | ❖ | ❖ | ❖ | ❖ | | | | | ❖ |
| 8 | | ❖ | | | ❖ | | | | | |
| 10 | | | ❖ | | ❖ | | | | | |
| 12 | | | | ❖ | | | | | | |
| 14 | | | | | ❖ | | | | | |
| 16 | | | | | | ❖ | | | | |
| 18 | | | | | | | ❖ | | | |
| 20 | | | | | | | | ❖ | | |
| 24 | | | | | | | | | ❖ | |

* PLEASE CONTACT US FOR ALL SIZES NOT LISTED

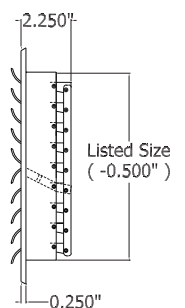
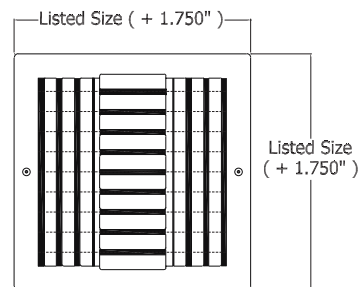
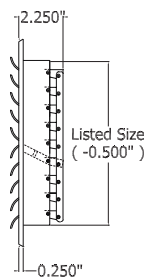
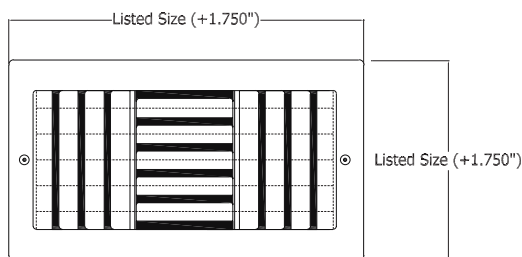



■ ■ ■ ALUMINUM SQUARE CEILING DIFFUSERS

Aluminum Square Ceiling Diffusers

A501M / A501O One-Way

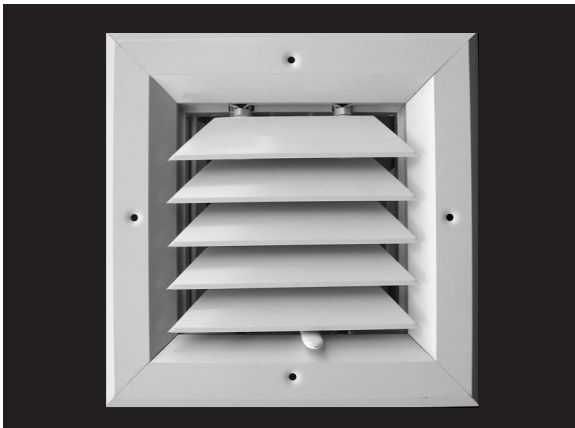

A502M / A502O Two-Way

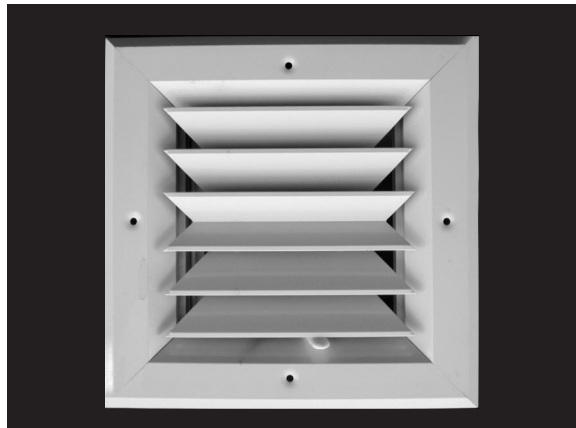

A503M / A503O Three-Way

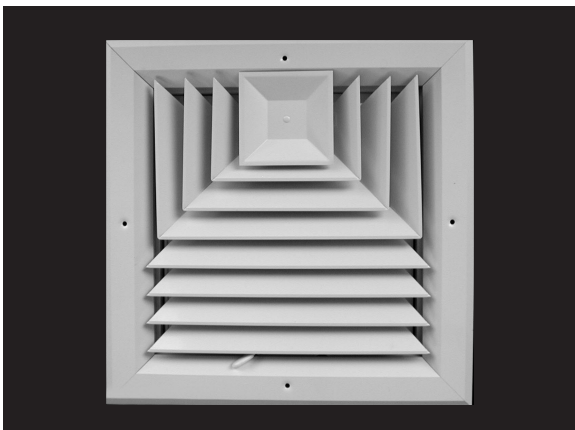

A504M / A504O Four-Way

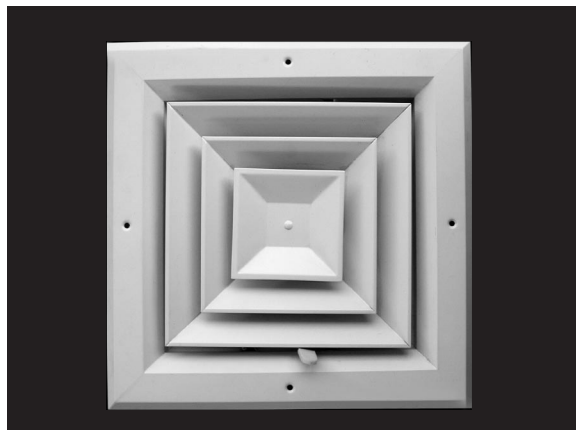

A505M / A505O

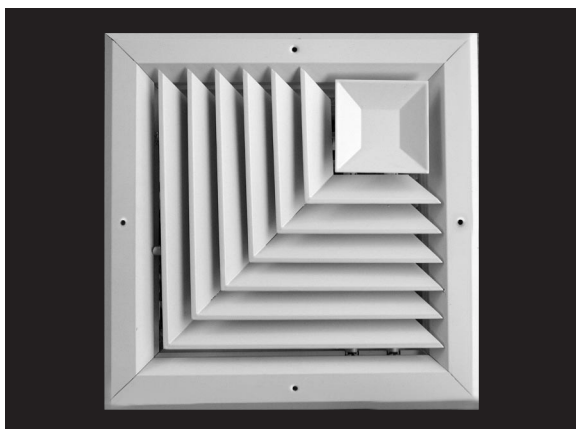

A500 Series Diffusers

- ❖ Square ceiling diffusers with multi-damper or OBD damper
- ❖ Extruded aluminum frame construction
- ❖ Counter-sunk screw holes with 2" screws (*provided*)
- ❖ Finished with white powder coating or aluminum finish
- ❖ Each grille is individually shrink wrapped

| A500 Series - Available Sizes (in inches) | | | | | | | | | |
|---|-------|---|----|----|----|----|----|----|----|
| HEIGHT | WIDTH | | | | | | | | |
| | 6 | 8 | 10 | 12 | 14 | 16 | 18 | 20 | 24 |
| 6 | ❖ | | | | | | | | |
| 8 | | ❖ | | | | | | | |
| 10 | | | ❖ | | | | | | |
| 12 | | | | ❖ | | | | | |
| 14 | | | | | ❖ | | | | |

* PLEASE CONTACT US FOR ALL SIZES NOT LISTED

Model A270 Shown Closed



A270 Series Registers

- ❖ Aluminum fixed horizontal blade return air grille
- ❖ Extruded aluminum frame for extra strength
- ❖ Large free area designed for maximum air flow
- ❖ Front fin angle is fixed at 45° in 1/2" spacing
- ❖ Counter-sunk screw holes

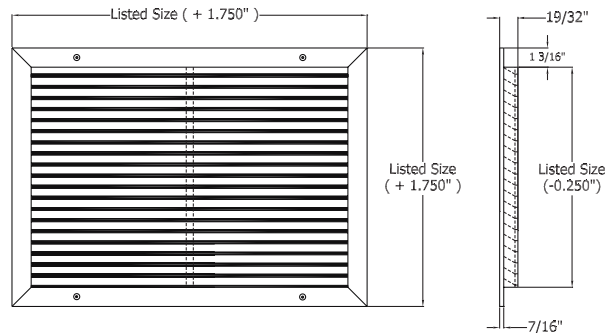

| A270 - Available Sizes (in inches) | | | | | | | | | | | | | | | | |
|------------------------------------|-------|---|----|----|----|----|----|----|----|----|----|----|----|----|----|----|
| HEIGHT | WIDTH | | | | | | | | | | | | | | | |
| | 6 | 8 | 10 | 12 | 14 | 16 | 18 | 20 | 24 | 25 | 26 | 28 | 30 | 36 | 38 | 40 |
| 4 | | ❖ | ❖ | ❖ | ❖ | | | | ❖ | | | | | | | |
| 6 | ❖ | ❖ | ❖ | ❖ | ❖ | ❖ | ❖ | ❖ | ❖ | | | | | ❖ | ❖ | |
| 8 | | ❖ | ❖ | ❖ | ❖ | ❖ | ❖ | ❖ | ❖ | | | | | ❖ | ❖ | |
| 10 | | | ❖ | ❖ | ❖ | ❖ | ❖ | ❖ | ❖ | | | | | ❖ | ❖ | |
| 12 | | | | ❖ | ❖ | ❖ | ❖ | ❖ | ❖ | | ❖ | | | ❖ | ❖ | |
| 14 | | | | | ❖ | ❖ | ❖ | ❖ | ❖ | ❖ | | | | ❖ | ❖ | ❖ |
| 16 | | | | | | ❖ | | ❖ | ❖ | ❖ | | | ❖ | ❖ | ❖ | ❖ |
| 18 | | | ❖ | | | | ❖ | ❖ | ❖ | | | | ❖ | ❖ | ❖ | |
| 20 | | | ❖ | | ❖ | | | ❖ | ❖ | ❖ | | | | ❖ | ❖ | ❖ |
| 24 | | | | ❖ | ❖ | ❖ | | | ❖ | ❖ | | | | ❖ | ❖ | |
| 26 | | | | | | | | | | | | | | ❖ | | |
| 30 | | | | | ❖ | | | | ❖ | ❖ | | | | ❖ | | |
| 36 | | | | ❖ | | | ❖ | | | | | | | | | |
| 40 | | | | | | | | ❖ | | | | | | ❖ | | |

* PLEASE CONTACT US FOR ALL SIZES NOT LISTED



ALUMINUM BAR TYPE: Return Air Filter Grilles

Model A290 Shown Closed



Model A290 Shown Open

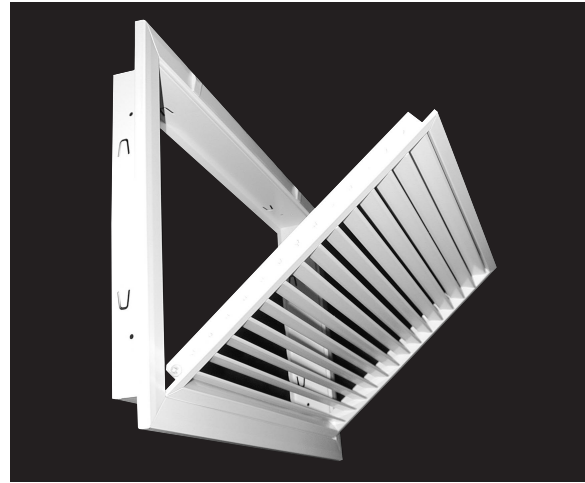

A290 Series Registers

- ❖ Fixed horizontal blade return air filter grille
- ❖ Extruded aluminum frame for extra strength
- ❖ Case is enframed for 1" air filter (*not included*)
- ❖ Large free area designed for maximum air flow
- ❖ Front fin angle is fixed at 45° in 1/2" spacing
- ❖ Counter-sunk screw holes with 1/4" hexagon-head

screws (*provided*)

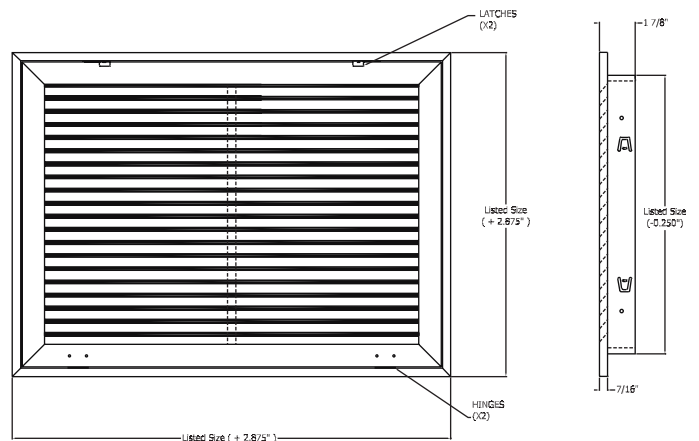

| A290 - Available Sizes (in inches) | | | | | | | | | | | | |
|------------------------------------|-------|----|----|----|----|----|----|----|----|----|----|----|
| HEIGHT | WIDTH | | | | | | | | | | | |
| | 10 | 12 | 14 | 16 | 18 | 20 | 24 | 25 | 30 | 36 | 40 | 50 |
| 6 | | | | | | ❖ | | | | | | |
| 8 | | | ❖ | | | | | | | ❖ | | |
| 10 | ❖ | ❖ | | ❖ | | ❖ | ❖ | | ❖ | | | |
| 12 | | ❖ | | | ❖ | ❖ | ❖ | | ❖ | ❖ | | |
| 14 | | | ❖ | | | ❖ | ❖ | ❖ | ❖ | ❖ | | |
| 16 | | | | ❖ | | ❖ | ❖ | ❖ | ❖ | ❖ | | |
| 18 | | | | | ❖ | ❖ | ❖ | | ❖ | ❖ | | |
| 20 | | | ❖ | | ❖ | ❖ | ❖ | ❖ | ❖ | ❖ | ❖ | |
| 24 | | ❖ | ❖ | | | ❖ | ❖ | | ❖ | ❖ | | |
| 25 | | | | | | ❖ | | ❖ | | | | |
| 30 | | | ❖ | ❖ | ❖ | ❖ | | | | | | |
| 40 | | | | | | ❖ | | | | | | |
| 50 | | | | | | ❖ | | | | | | |

* PLEASE CONTACT US FOR ALL SIZES NOT LISTED