

Copeland™ compressor – Parts and accessories

# Copeland™ compressor Parts and accessories



# Table of Contents

|   |           |
|---|-----------|
| <b>A - Hermetic Compressors.....</b>                  | <b>3</b>  |
| AF Compressors Parts.....                             | 4         |
| AR Compressors Parts .....                            | 5         |
| AS Compressors Parts.....                             | 7         |
| <b>C - Hermetic Compressors.....</b>                  | <b>8</b>  |
| CF Compressors Parts.....                             | 10        |
| CR Compressors Parts .....                            | 10        |
| CS Compressors Parts .....                            | 13        |
| CT Compressors Parts.....                             | 13        |
| <b>R - Hermetic Compressors .....</b>                 | <b>14</b> |
| RE Compressors Parts .....                            | 16        |
| RF Compressors Parts.....                             | 16        |
| RR Compressors Parts .....                            | 17        |
| RS Compressors Parts .....                            | 18        |
| <b>E - Semi-Hermetic Compressors.....</b>             | <b>21</b> |
| EA Compressors Parts.....                             | 22        |
| ER Compressors Parts .....                            | 24        |
| <b>H - Semi-Hermetic Compressors .....</b>            | <b>25</b> |
| HA Compressors Parts.....                             | 26        |
| <b>K - Semi-Hermetic Compressors .....</b>            | <b>27</b> |
| KA Compressors Parts.....                             | 28        |
| <b>L - Semi-Hermetic Compressors.....</b>             | <b>32</b> |
| LA Compressors Parts .....                            | 33        |
| <b>M - Semi-Hermetic Compressors .....</b>            | <b>34</b> |
| MR Compressors Parts.....                             | 35        |
| <b>N - Semi-Hermetic Compressors .....</b>            | <b>36</b> |
| NR Compressors Parts .....                            | 37        |
| <b>2D - Semi-Hermetic Compressors .....</b>           | <b>38</b> |
| 2D Compressors Parts.....                             | 41        |
| <b>3A/R - Semi-Hermetic Compressors.....</b>          | <b>43</b> |
| 3A Compressors Parts .....                            | 44        |
| 3R Compressors Parts.....                             | 44        |
| <b>3D - Semi-Hermetic Compressors .....</b>           | <b>45</b> |
| 3D Floating Reed Models.....                          | 49        |
| 3D Delta Reed Models .....                            | 53        |
| 3D Digital Models.....                                | 57        |
| 3D Capacity Control Kits .....                        | 58        |
| <b>4D/R - Semi-Hermetic Compressors.....</b>          | <b>59</b> |
| 4D Floating Reed Models.....                          | 63        |
| 4D Delta Reed Models .....                            | 68        |
| 4D Capacity Control Kits .....                        | 73        |
| 4R Compressors Parts.....                             | 74        |
| 4R Capacity Control Kits .....                        | 75        |
| <b>4D - Discus III Semi-Hermetic Compressors.....</b> | <b>76</b> |
| 4D Discus III to Discus II Matrix .....               | 77        |
| 4D Discus III Delta Reed Model .....                  | 80        |
| 4D Discus III Capacity Control Kits.....              | 82        |

|   |            |
|---|------------|
| <b>4M - CO<sub>2</sub> Semi-Hermetic Compressors.....</b> | <b>83</b>  |
| 4M CO <sub>2</sub> Compressor Parts.....                  | 84         |
| <b>6D/R/T - Semi-Hermetic Compressors.....</b>            | <b>85</b>  |
| 6D Floating Reed Models.....                              | 89         |
| 6D Delta Reed Models .....                                | 95         |
| 6D Capacity Control Kits .....                            | 98         |
| 6R Compressor Parts.....                                  | 101        |
| 6R Capacity Control Kits .....                            | 103        |
| 6T Compressor Parts .....                                 | 103        |
| <b>6D Discus III Semi-Hermetic .....</b>                  | <b>104</b> |
| 6D Discus III to Discus II Matrix .....                   | 106        |
| 6D Discus III Delta Reed Models .....                     | 107        |
| 6D Discus III Capacity Control Kits .....                 | 110        |
| <b>9R - Semi-Hermetic Compressors .....</b>               | <b>111</b> |
| 9R - Compressor Parts .....                               | 113        |
| <b>ZB - Scroll Compressors .....</b>                      | <b>115</b> |
| ZB Compressor Parts.....                                  | 117        |
| <b>ZF - Scroll Compressors.....</b>                       | <b>119</b> |
| ZF Compressor Parts.....                                  | 122        |
| <b>ZO - Scroll Compressors .....</b>                      | <b>123</b> |
| ZO Compressor Parts .....                                 | 125        |
| <b>ZP - Scroll Compressors.....</b>                       | <b>126</b> |
| ZP Compressor Parts.....                                  | 128        |
| ZPS Compressor Parts .....                                | 132        |
| ZPT Compressor Parts .....                                | 132        |
| ZPU Compressor Parts .....                                | 133        |
| <b>ZR - Scroll Compressors .....</b>                      | <b>134</b> |
| ZR Compressor Parts .....                                 | 136        |
| ZRS Compressor Parts .....                                | 140        |
| ZRU Compressor Parts.....                                 | 140        |
| ZRT Compressor Parts .....                                | 141        |
| <b>ZS - Scroll Compressors.....</b>                       | <b>142</b> |
| ZS Compressor Parts.....                                  | 144        |

|   |            |
|---|------------|
| <b>Quick Reference Guide .....</b>      | <b>145</b> |
| Semi-Hermetic Mounting Parts/Kits ..... | 145        |
| Reed Compressor Service Valves .....    | 146        |
| Discus Compressor Service Valves .....  | 147        |
| Sweat Connection Sizes .....            | 149        |
| Rotalock Valve Kits .....               | 154        |
| Adapter Kits.....                       | 155        |
| Semi-Hermetic Oil Charges .....         | 156        |
| 3D Moduload.....                        | 157        |
| Digital Models.....                     | 161        |
| Emerson Approved Contactors .....       | 162        |
| Parts Warranty Information .....        | 164        |



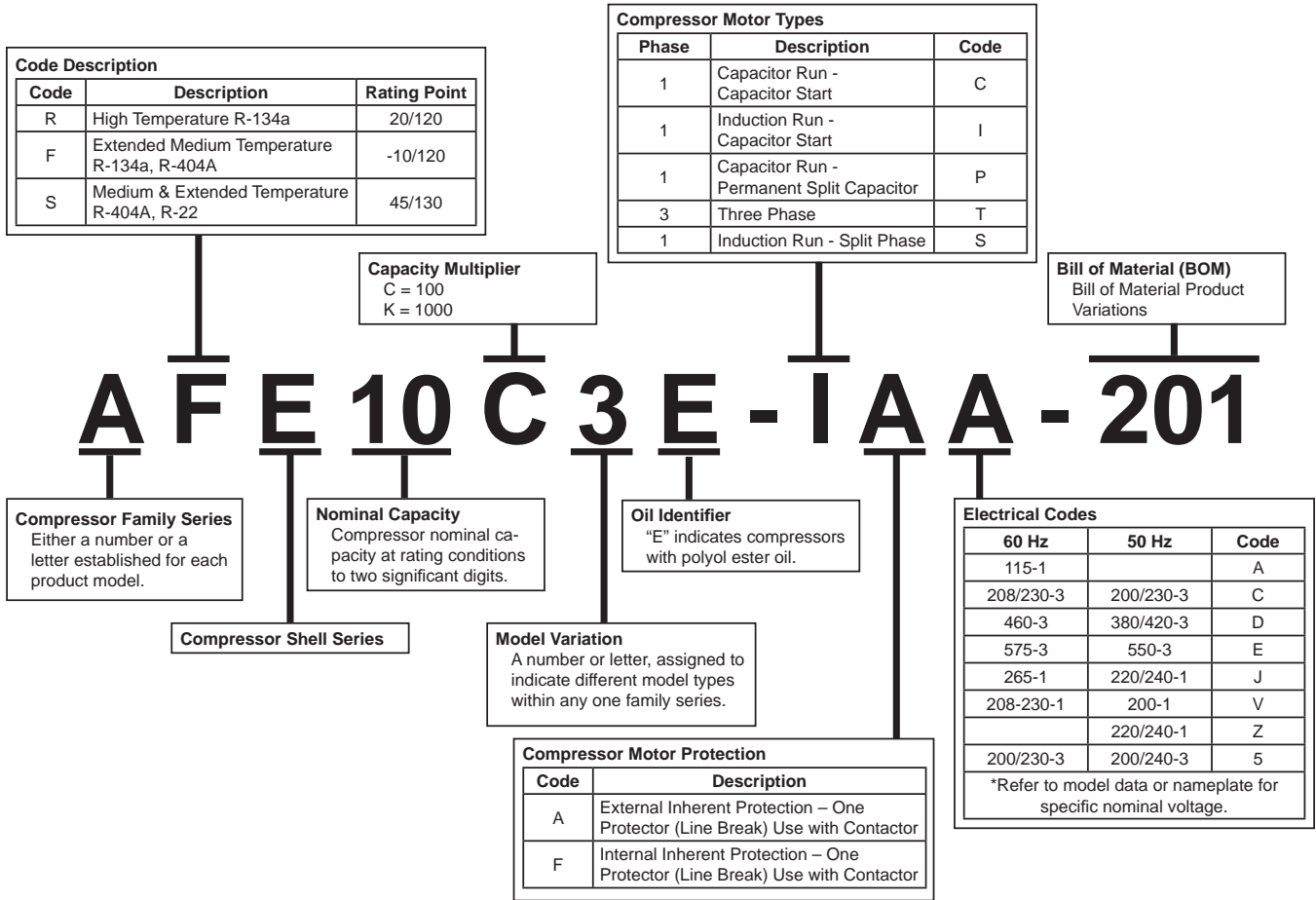

## Crankcase Heaters

| Models    | OEM     | Service | Voltage | Watts | Lead Length (in) |
|-----------|---------|---------|---------|-------|------------------|
|           | (018-)  | (918-)  |         |       |                  |
| A*B / A*E | 0048-02 | 0048-00 | 120V    | 35    | 30               |
| A*B / A*E | 0048-03 | 0048-01 | 240V    | 35    | 30               |
| A*T       | 0090-00 | 0049-00 | 120V    | 48    | 30               |
| A*T       | 0090-01 | 0049-01 | 240V    | 48    | 30               |





# A – Hermetic Compressors

## AF - Compressor Parts

| Model           | Start Capacitor |         | Run Capacitor |         | Current Relay |         | Potential Relay |         | Overload |         | MTG Parts |
|-----------------|-----------------|---------|---------------|---------|---------------|---------|-----------------|---------|----------|---------|-----------|
|                 | OEM             | Service | OEM           | Service | OEM           | Service | OEM             | Service | OEM      | Service |           |
|                 | (014-)          | (914-)  | (014-)        | (914-)  | (040-)        | (940-)  | (040-)          | (940-)  | (071-)   | (971-)  |           |
| AF07C1(E)-IAA*  | 0053-18         | 0053-00 |               |         | 0163-10       | C411-82 |                 |         | N/A      | C100-35 | C001-02   |
| AF22C1(E)-IAA*  | 0053-18         | 0053-00 |               |         | 0172-00       | C016-00 |                 |         | 0605-00  | C100-41 | C001-00   |
| AFB04C3(E)-SAA* |                 |         |               |         | 0162-13       | C401-40 |                 |         | 0561-13  | 0554-00 | C001-02   |
| AFB05C3(E)-IAA* | 0053-35         | 0038-04 |               |         | 0163-00       | C411-58 |                 |         | 0561-08  | 0554-01 | C001-02   |
| AFB05C3(E)-SAA* |                 |         |               |         | 0163-00       | C411-58 |                 |         | 0561-08  | 0554-01 | C001-02   |
| AFB06C3(E)-IAA* | 0053-26         | 0053-10 |               |         | 0163-01       | C411-66 |                 |         | 0561-11  | 0554-43 | C001-02   |
| AFB09C3(E)-IAA* | 0053-26         | 0053-10 |               |         | 0163-14       | C411-71 |                 |         | 0561-15  | 0554-44 | C001-02   |
| AFE05C4(E)-IAA* | 0053-26         | 0053-10 |               |         | 0163-11       | C411-63 |                 |         | 0561-28  | 0554-42 | C001-02   |
| AFE06C4(E)-IAA* | 0053-18         | 0053-00 |               |         | 0163-13       | C411-72 |                 |         | 0561-29  | 0554-40 | C001-02   |
| AFE07C3(E)-IAA* | 0053-26         | 0053-10 |               |         | 0163-10       | C411-82 |                 |         | 0561-02  | 0554-15 | C001-02   |
| AFE08C4(E)-IAA* | 0053-18         | 0053-00 |               |         | 0163-15       | 0150-31 |                 |         | 0561-23  | 0554-19 | C001-02   |
| AFE10C3(E)-IAA* | 0053-26         | 0053-10 |               |         | 0163-05       | C411-89 |                 |         | 0561-24  | 0554-17 | C001-02   |
| AFE11C3(E)-IAA* | 0053-18         | 0053-00 |               |         | 0163-10       | C411-82 |                 |         | 0561-16  | 0554-22 | C001-02   |
| AFE11C4(E)-IAA* | 0053-18         | 0053-00 |               |         | 0163-13       | C411-72 |                 |         | 0561-21  | 0554-28 | C001-02   |
| AFE12C3(E)-IAA* | 0053-35         | 0038-04 |               |         | 0163-06       | C411-83 |                 |         | 0561-28  | 0554-42 | C001-02   |
| AFE12C4(E)-IAA* | 0053-25         | 0053-09 |               |         | 0163-06       | C411-83 |                 |         | 0561-28  | 0554-42 | C001-02   |
| AFE13C3(E)-IAA* | 0053-35         | 0038-04 |               |         | 0163-06       | C411-83 |                 |         | 0561-03  | 0554-27 | C001-02   |
| AFE13C3(E)-IAV* | 0053-37         | 0038-15 |               |         | 0150-14       | C411-47 | 0166-38         | 0001-80 | 0561-04  | 0554-45 | C001-02   |
| AFE13C4(E)-IAA* | 0053-35         | 0053-04 |               |         | 0163-06       | C411-83 |                 |         | 0561-47  | N/A     | C001-02   |
| AFE17C4(E)-CAA* | 0072-02         | 0036-15 | 0064-12       | 0037-16 |               |         | 0166-21         | 0001-62 | 0568-48  | 0561-48 | C001-02   |
| AFE17C4(E)-IAA* | 0053-35         | 0053-04 |               |         | 0163-05       | C411-89 |                 |         | 0568-48  | 0561-48 | C001-02   |
| AFE17C4(E)-IAV* | 0053-27         | 0053-11 |               |         | 0150-14       | C411-47 |                 |         | 0561-62  | 0561-62 | C001-02   |
| AFT12C1(E)-IAA* | 0053-35         | 0038-04 |               |         | 0163-08       | 0163-08 |                 |         | 0063-08  | C100-69 | C001-00   |
| AFT12C1(E)-IAV* | 0053-27         | 0053-11 |               |         | 0163-01       | C411-66 |                 |         | 0603-01  | C603-01 | C001-00   |
| AFT12C1-IAA*    | 0053-35         | 0038-04 |               |         | 0163-10       | 0163-06 |                 |         | 0603-08  | C100-25 | C001-00   |
| AFT18C1(E)-IAA* | 0053-26         | 0053-10 |               |         | 0163-07       | 0163-07 |                 |         | 0603-11  | 0603-11 | C001-00   |
| AFT18C1(E)-IAV* | 0053-30         | 0053-14 |               |         | 0163-02       | C411-79 |                 |         | 0603-03  | 0603-03 | C001-00   |
| AFT22C1(E)-CFV* | 0061-27         | 0036-03 | 0064-09       | 0037-13 |               |         | 0166-39         | 0001-82 |          |         | C001-00   |
| AFT22C1(E)-IAA* | 0053-18         | 0053-00 |               |         | 0172-00       | C016-00 |                 |         | 0605-00  | C100-41 | C001-00   |
| AFT26C1(E)-CFA* | 0061-28         | 0036-04 | 0064-11       | 0037-15 |               |         | 0166-37         | 0001-79 |          |         | C001-00   |
| AFT26C1(E)-CFV* | 0061-27         | 0036-03 | 0064-09       | 0037-13 |               |         | 0166-13         | 0001-53 |          |         | C001-00   |
| AFT29C1(E)-CFA* | 0061-33         | 0036-12 | 0064-11       | 0037-15 |               |         | 0166-37         | 0001-79 |          |         | C001-00   |
| AFT29C1(E)-CFV* | 0061-27         | 0036-03 | 0064-09       | 0037-13 |               |         | 0166-13         | 0001-53 |          |         | C001-00   |
| AFJ23C1-IAA*    | 0061-32         | 0036-09 |               |         |               |         | 0166-38         | 0001-80 | 0605-03  | C100-09 | C001-00   |
| AFJ23C2-IAA*    | 0061-32         | 0036-09 |               |         |               |         | 0166-38         | 0001-80 | 0605-03  | C100-09 | C001-00   |
| AFJ31C1(E)-CFV* | 0061-27         | 0036-03 | 0064-10       | 0037-14 |               |         | 0166-29         | 0001-70 |          |         | C001-00   |
| AFJ31C2(E)-CFV* | 0061-27         | 0036-03 | 0064-10       | 0037-14 |               |         | 0166-29         | 0001-70 |          |         | C001-00   |
| AFJ37C1(E)-CFV* | 0061-27         | 0036-03 | 0064-10       | 0037-14 |               |         | 0166-29         | 0001-70 |          |         | C001-00   |
| AFJ37C2(E)-CFV* | 0061-27         | 0036-03 | 0064-10       | 0037-14 |               |         | 0166-29         | 0001-70 |          |         | C001-00   |

## AR - Compressor Parts

| Model           | Start Capacitor |         | Run Capacitor |         | Current Relay |         | Potential Relay |         | Overload |         | MTG Parts |
|-----------------|-----------------|---------|---------------|---------|---------------|---------|-----------------|---------|----------|---------|-----------|
|                 | OEM             | Service | OEM           | Service | OEM           | Service | OEM             | Service | OEM      | Service |           |
|                 | (014-)          | (914-)  | (014-)        | (914-)  | (040-)        | (940-)  | (040-)          | (940-)  | (071-)   | (971-)  |           |
| ARB09C3-SAA*    |                 |         |               |         | 0162-00       | C401-25 |                 |         | 0554-35  | 0554-35 | C001-02   |
| ARB10C3-SAA*    |                 |         |               |         | 0170-08       | C401-40 |                 |         | 0561-18  | 0554-04 | C001-02   |
| ARB13C3(E)-IAA* | 0053-18         | 0053-00 |               |         | 0167-16       | C411-52 |                 |         | 0561-25  | 0554-04 | C001-02   |
| ARB13C3(E)-SAA* |                 |         |               |         | 0170-08       | C401-40 |                 |         | 0561-25  | 0554-05 | C001-02   |
| ARB17C3(E)-IAA* | 0053-18         | 0053-00 |               |         | 0167-15       | C411-61 |                 |         | 0561-09  | 0561-09 | C001-02   |
| ARB17C3(E)-SAA* |                 |         |               |         | 0170-11       | 0152-00 |                 |         | 0561-09  | 0561-09 | C001-02   |
| ARB21C3-IAA*    | 0053-18         | 0053-00 |               |         | 0163-13       | C411-72 |                 |         | 0561-01  | 0561-01 | C001-02   |
| ARE13C4E -IAA*  | 0053-26         | 0053-10 |               |         | 0163-01       | C411-66 |                 |         | 0561-28  | 0554-42 | C001-02   |
| ARE17C4E -IAA*  | 0053-26         | 0053-10 |               |         | 0163-01       | C411-66 |                 |         | 0561-28  | 0554-42 | C001-02   |
| ARE25C3(E)-IAA* | 0053-18         | 0053-00 |               |         | 0163-11       | C411-63 |                 |         | 0561-23  | 0554-19 | C001-02   |
| ARE25C3(E)-SAA* |                 |         |               |         | 0162-01       | C411-72 |                 |         | 0561-23  | 0554-19 | C001-02   |
| ARE25C4(E)-IAA* | 0053-18         | 0053-00 |               |         | 0163-13       | C411-72 |                 |         | 0561-28  | 0554-42 | C001-02   |
| ARE27C3(E)-IAA* | 0053-18         | 0053-00 |               |         | 0167-02       | C411-66 |                 |         | 0561-23  | 0554-19 | C001-02   |
| ARE27C3(E)-SAA* |                 |         |               |         | 0170-07       | C401-66 |                 |         | 0561-23  | 0554-19 | C001-02   |
| ARE29C4(E)-IAA* | 0053-18         | 0053-00 |               |         | 0163-13       | C411-72 |                 |         | 0561-21  | 0554-28 | C001-02   |
| ARE34C4(E)-IAA* | 0053-35         | 0053-04 |               |         | 0163-06       | C411-83 |                 |         | 0561-50  | 0561-50 | C001-02   |
| ARE35C3-IAA*    | 0053-18         | 0053-00 |               |         | 0163-14       | C411-71 |                 |         | 0561-03  | 0554-27 | C001-02   |
| ARE35C3-IAV*    | 0053-37         | 0053-15 |               |         | 0150-25       | C411-55 |                 |         | 0561-01  | 0561-01 | C001-02   |
| ARE36C3-IAA*    | 0053-19         | 0038-01 |               |         | 0163-10       | C411-82 |                 |         | 0561-16  | 0554-22 | C001-02   |
| ARE36C3-SAA*    |                 |         |               |         | 0170-03       | C401-82 |                 |         | 0561-16  | 0554-22 | C001-02   |
| ARE37C3(E)-IAA* | 0053-35         | 0038-04 |               |         | 0163-10       | C411-82 |                 |         | 0561-16  | 0554-22 | C001-02   |
| ARE37C3(E)-IAV* | 0053-30         | 0053-14 |               |         | 0150-04       | C411-45 |                 |         | 0561-00  | 0561-00 | C001-02   |
| ARE37C3(E)-SAA* |                 |         |               |         | 0170-03       | C401-82 |                 |         | 0561-16  | 0554-22 | C001-02   |
| ARE40C4(E)-IAA* | 0053-25         | 0053-09 |               |         | 0163-06       | 0150-33 |                 |         | 0561-03  | 0554-27 | C001-02   |
| ARE41C3(E)-IAA* | 0053-35         | 0038-04 |               |         | 0163-06       | C411-83 |                 |         | 0561-32  | 0554-25 | C001-02   |
| ARE41C3(E)-IAV* | 0053-27         | 0038-13 |               |         | 0140-18       | C411-73 |                 |         | 0561-00  | 0561-00 | C001-02   |
| ARE41C3-SAA*    |                 |         |               |         | 0162-01       | C401-72 |                 |         | 0561-17  | 0561-17 | C001-02   |
| ARE43C3-IAA*    | 0053-18         | 0053-00 |               |         | 0163-10       | C411-82 |                 |         | 0561-17  | 0561-17 | C001-02   |
| ARE46C4(E)-IAA* | 0053-25         | 0053-09 |               |         | 0163-05       | C411-89 |                 |         | 0561-51  | 0561-51 | C001-02   |
| ARE47C3-IAA*    | 0053-26         | 0053-10 |               |         | 0163-10       | C411-82 |                 |         | 0561-17  | 0561-17 | C001-02   |
| ARE47C3-IAV*    | 0053-27         | 0038-13 |               |         | 0167-13       | C411-78 |                 |         | 0561-00  | 0554-48 | C001-02   |
| ARE51C4(E)-CAA* | 0061-34         | 0058-43 |               |         |               |         | 0166-21         | 0001-62 | 0561-73  | 0561-73 | C001-02   |
| ARE51C4(E)-IAV* | 0053-29         | 0053-13 |               |         | 0163-04       | C411-80 |                 |         | 0561-28  | 0554-42 | C001-02   |
| ARE59C3-CAA*    | 0072-00         | 0036-11 | 0064-10       | 0037-14 |               |         | 0166-45         | 0001-88 | 0561-07  | 0554-30 | C001-02   |
| ARE59C3-CAV*    | 0061-20         | 0008-74 | 0064-09       | 0037-13 |               |         | 0166-30         | 0001-71 | 0561-10  | 0561-10 | C001-02   |
| ARJ10K1-CAV*    | 0061-27         | 0036-03 | 0064-10       | 0037-14 |               |         | 0166-27         | 0001-68 | 0563-00  | N/A     | C001-00   |
| ARJ11K1-CAV*    | 0061-20         | 0008-74 | 0064-03       | 0037-07 |               |         | 0166-22         | 0001-63 | 0604-05  | 0604-05 | C001-00   |
| ARJ11K2(E)-CAV* | 0061-20         | 0008-74 | 0064-33       | 0037-50 |               |         | 0166-24         | 0001-65 | 0604-05  | 0604-05 | C001-00   |
| ARJ13K1-CAB*    | 0061-27         | 0036-03 | 0064-10       | 0037-14 | 0166-05       | 0140-06 |                 |         | 0604-07  | C100-10 | C001-00   |
| ARJ84C1(E)-IAV* | 0061-27         | 0036-03 |               |         | 0172-02       | C016-02 |                 |         | 0604-03  | C100-52 | C001-00   |

# A – Hermetic Compressors

## AR - Compressor Parts

| Model           | Start Capacitor |         | Run Capacitor |         | Current Relay |         | Potential Relay |         | Overload |         | MTG Parts |
|-----------------|-----------------|---------|---------------|---------|---------------|---------|-----------------|---------|----------|---------|-----------|
|                 | OEM             | Service | OEM           | Service | OEM           | Service | OEM             | Service | OEM      | Service |           |
|                 | (014-)          | (914-)  | (014-)        | (914-)  | (040-)        | (940-)  | (040-)          | (940-)  | (071-)   | (971-)  |           |
| ARJ84C1-IAA*    | 0058-35         | 0036-08 |               |         |               |         | 0166-38         | 0001-80 | 0605-01  | C100-06 | C001-00   |
| ARJ84C2(E)-IAA* | 0058-35         | 0036-08 |               |         |               |         | 0166-38         | 0001-80 | 0605-01  | C100-06 | C001-00   |
| ARJ84C2(E)-IAV* | 0061-27         | 0036-03 |               |         | 0172-02       | 0102-04 |                 |         | 0604-11  | 0604-11 | C001-00   |
| ART51C1(E)-IAA* | 0053-35         | 0038-04 |               |         | 0171-04       | C411-80 |                 |         | 0603-02  | C100-19 | C001-00   |
| ART51C1(E)-IAG* | 0053-36         | 0038-05 |               |         | 0171-00       | C411-58 |                 |         | 0603-06  | N/A     | C001-00   |
| ART51C1(E)-IAV* | 0061-13         | 0008-65 |               |         | 0171-02       | C411-79 |                 |         | 0603-02  | C100-19 | C001-00   |
| ART62C1(E)-IAA* | 0053-25         | 0038-09 |               |         | 0163-05       | 0163-05 |                 |         | 0603-05  | C100-24 | C001-00   |
| ART62C1(E)-IAV* | 0061-13         | 0008-65 |               |         | 0171-02       | C411-79 |                 |         | 0603-07  | C100-58 | C001-00   |
| ART64C1(E)-IAA* | 0053-25         | 0038-09 |               |         | 0163-07       | 0163-07 |                 |         | 0603-10  | C100-53 | C001-00   |
| ART64C1(E)-IAV* | 0061-27         | 0036-03 |               |         | 0171-02       | C411-79 |                 |         | 0603-15  | C100-54 | C001-00   |
| ART69C1-IAA*    | 0061-28         | 0036-04 |               |         | 0172-03       | C016-03 |                 |         | 0605-05  | C100-71 | C001-00   |
| ART69C1-IAV*    | 0053-30         | 0053-14 |               |         | 0171-02       | C411-79 |                 |         | 0603-13  | C100-72 | C001-00   |
| ART82C1-CAA*    | 0058-30         | 0036-04 | 0064-13       | 0037-17 |               |         | 0166-37         | 0001-79 | 0605-03  | C100-09 | C001-00   |
| ART82C1-CAV*    | 0061-16         | 0008-70 | 0064-09       | 0037-13 |               |         | 0166-27         | 0001-68 | 0604-01  | C103-01 | C001-00   |
| ART82C1-CFB*    | 0061-27         | 0036-03 | 0064-09       | 0037-13 |               |         | 0166-04         | 0140-05 | IP       | N/A     | C001-00   |
| ART97C1-CAA*    | 0061-33         | 0036-12 | 0064-11       | 0037-15 |               |         | 0166-03         | 0140-04 | 0605-02  | C102-00 | C001-00   |
| ART97C1-CAV*    | 0061-16         | 0008-70 | 0064-09       | 0037-13 |               |         | 0166-27         | 0001-68 | 0604-08  | 0604-08 | C001-00   |
| ART97C1-PAV*    | 0036-13         | 0036-13 | 0064-10       | 0037-14 |               |         | 0166-27         | 0001-68 | 0604-06  | C103-01 | C001-00   |



## AS - Compressor Parts

| Model           | Start Capacitor |         | Run Capacitor |         | Current Relay |         | Potential Relay |         | Overload |         | MTG Parts<br>(527-) |
|-----------------|-----------------|---------|---------------|---------|---------------|---------|-----------------|---------|----------|---------|---------------------|
|                 | OEM             | Service | OEM           | Service | OEM           | Service | OEM             | Service | OEM      | Service |                     |
|                 | (014-)          | (914-)  | (014-)        | (914-)  | (040-)        | (940-)  | (040-)          | (940-)  | (071-)   | (971-)  |                     |
| ASB12C3(E)-IAA* | 0053-26         | 0053-10 |               |         | 0163-13       | C411-72 |                 |         | 0561-01  | 0561-01 | C001-02             |
| ASB14C3(E)-IAA* | 0053-18         | 0053-00 |               |         | 0163-10       | C411-82 |                 |         | 0561-26  | 0554-12 | C001-02             |
| ASE12C4(E)-IAA* | 0053-26         | 0053-10 |               |         | 0163-01       | C411-66 |                 |         | 0561-23  | 0554-19 | C001-02             |
| ASE14C4(E)-IAA* | 0053-26         | 0053-10 |               |         | 0163-13       | C411-72 |                 |         | 0561-23  | 0554-19 | C001-02             |
| ASE19C3(E)-IAA* | 0053-18         | 0053-00 |               |         | 0163-14       | C411-71 |                 |         | 0561-21  | 0554-28 | C001-02             |
| ASE19C4(E)-IAA* | 0053-18         | 0053-00 |               |         | 0163-03       | 0150-32 |                 |         | 0561-21  | 0554-28 | C001-02             |
| ASE20C4-IAA*    | 0053-26         | 0053-10 |               |         | 0163-13       | C411-72 |                 |         | 0561-21  | 0554-28 | C001-02             |
| ASE20C4E-CAA*   | 0061-28         | 0036-04 | 0064-10       | 0037-14 |               |         | 0166-21         | 0001-62 | 0561-21  | 0554-28 | C001-02             |
| ASE24C3(E)-IAA* | 0053-26         | 0053-10 |               |         | 0163-10       | C411-82 |                 |         | 0561-07  | 0554-30 | C001-02             |
| ASE24C3(E)-IAV* | 0053-27         | 0038-11 |               |         | 0150-04       | C411-45 |                 |         | 0561-29  | 0554-40 | C001-02             |
| ASE26C4(E)-CAA* | 0072-02         | 0036-15 | 0064-11       | 0037-15 |               |         | 0166-21         | 0001-62 | 0561-03  | 0554-27 | C001-02             |
| ASE26C4(E)-IAA* | 0053-35         | 0053-04 |               |         | 0163-04       | C411-80 |                 |         | 0561-03  | 0554-27 | C001-02             |
| ASE32C3(E)-CAA* | 0061-20         | 0008-74 | 0064-10       | 0037-14 |               |         | 0166-45         | 0001-88 | 0561-07  | 0554-30 | C001-02             |
| ASE32C3(E)-CAV* | 0061-27         | 0036-03 | 0064-09       | 0037-13 |               |         | 0166-13         | 0001-53 | 0561-12  | 0561-12 | C001-02             |
| ASE35C4(E)-CAA* | 0072-02         | 0036-15 | 0064-12       | 0037-16 |               |         | 0166-37         | 0001-79 | 0561-49  | 0561-49 | C001-02             |
| ASE35C4(E)-IAA* | 0053-35         | 0053-04 |               |         | 0163-05       | C411-89 |                 |         | 0561-49  | 0561-49 | C001-02             |
| ASE35C4-IAV*    | 0053-29         | 0053-13 |               |         | 0163-04       | C411-80 |                 |         | 0561-28  | 0554-42 | C001-02             |
| AST40C1(E)-IAA* | 0061-28         | 0036-04 |               |         | 0172-03       | C016-03 |                 |         | 0605-05  | C100-71 | C001-02             |
| AST40C1(E)-IAV* | 0061-27         | 0036-03 |               |         | 0163-02       | C411-79 |                 |         | 0603-13  | C100-72 | C001-02             |
| AST45C1(E)-CAV* | 0061-16         | 0008-70 | 0064-09       | 0037-13 |               |         | 0166-03         | 0001-68 | 0604-01  | C100-74 | C001-00             |
| AST45C1(E)-IAA* | 0061-28         | 0036-04 |               |         | 0163-02       | C016-03 |                 |         | 0605-03  | C100-09 | C001-00             |
| AST54C1(E)-CAA* | 0061-33         | 0036-12 | 0064-11       | 0037-15 |               |         | 0166-03         | 0140-04 | 0605-04  | C100-79 | C001-00             |
| AST54C1(E)-CAV* | 0061-16         | 0008-70 | 0064-09       | 0037-13 |               |         | 0166-03         | 0001-68 | 0604-07  | C100-10 | C001-00             |





# C – Hermetic Compressors

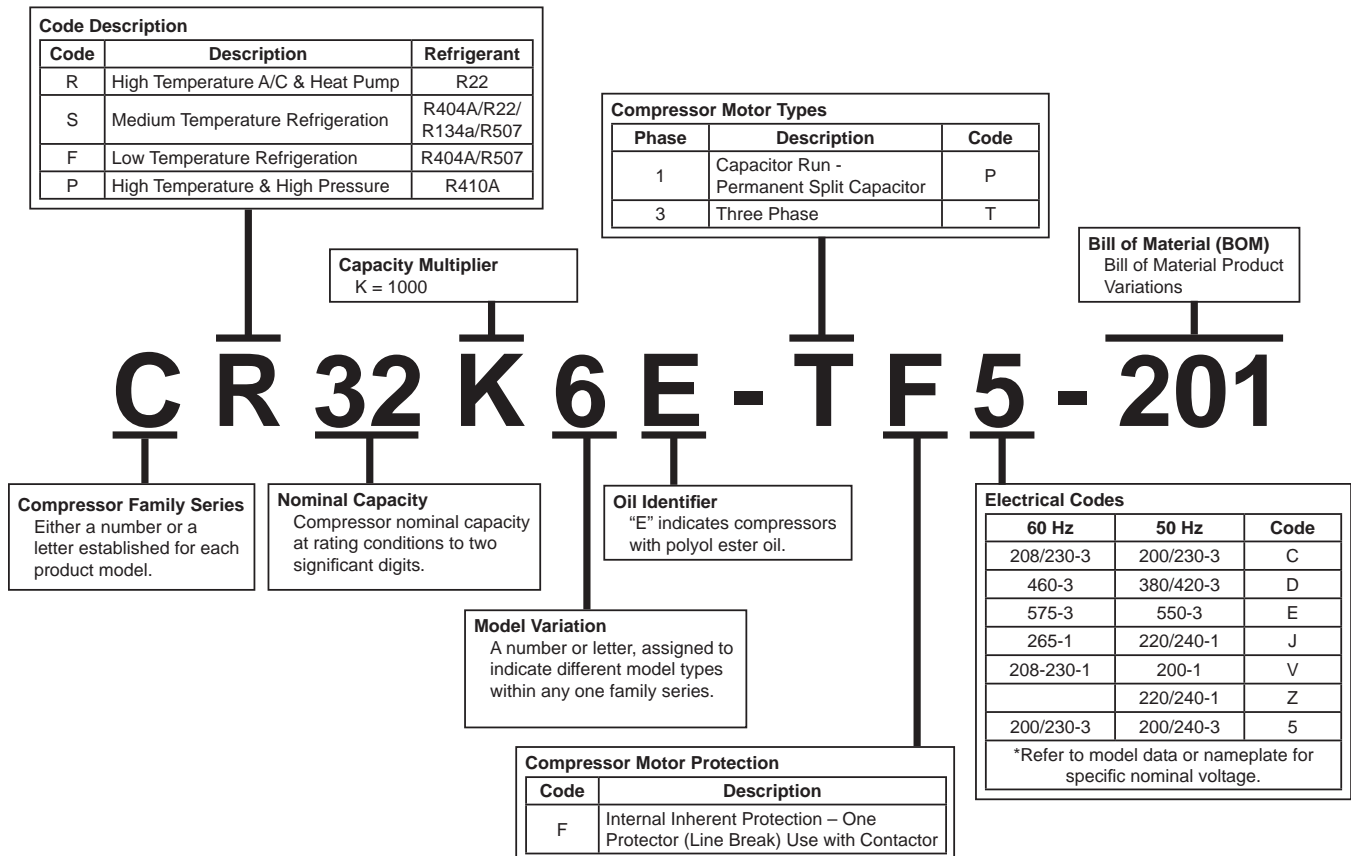
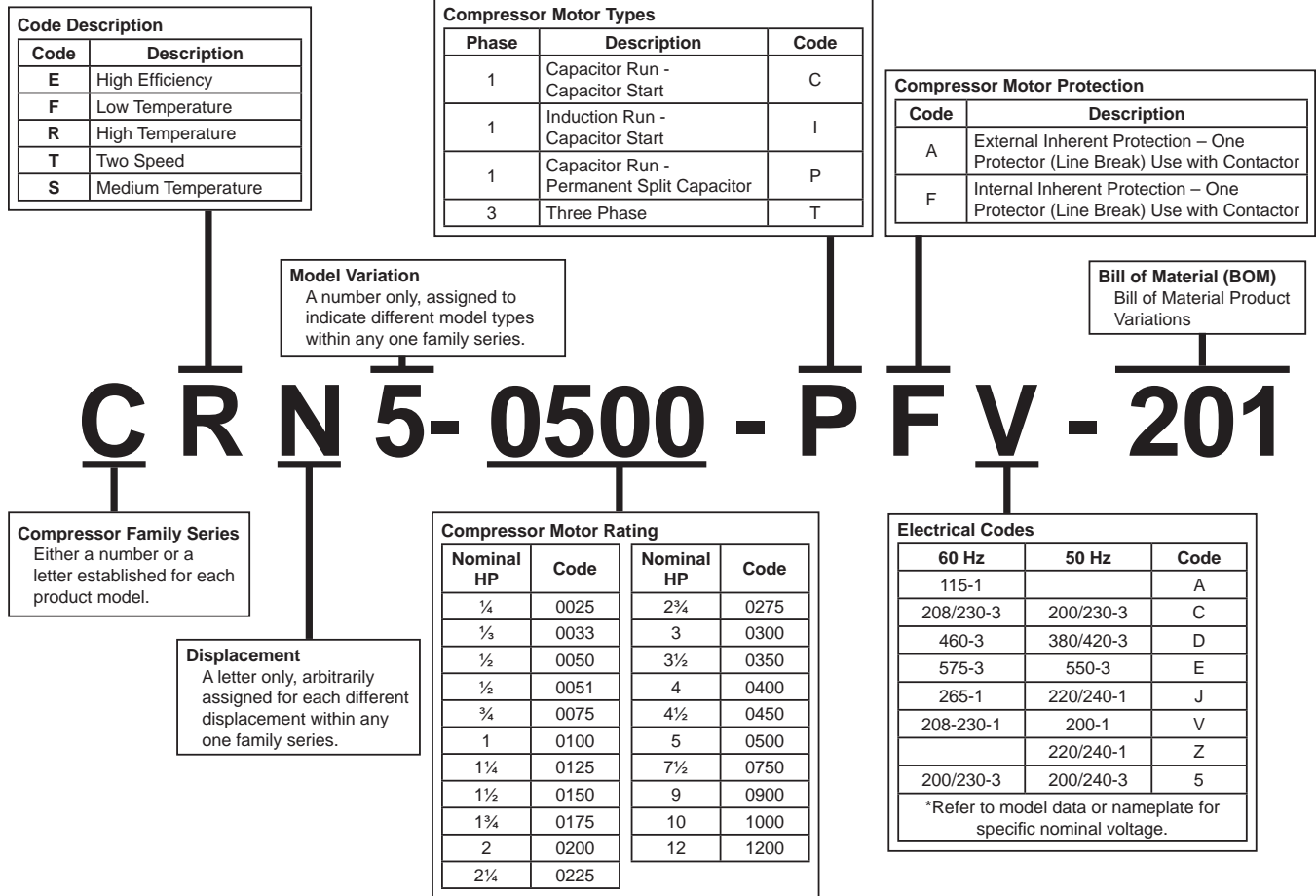

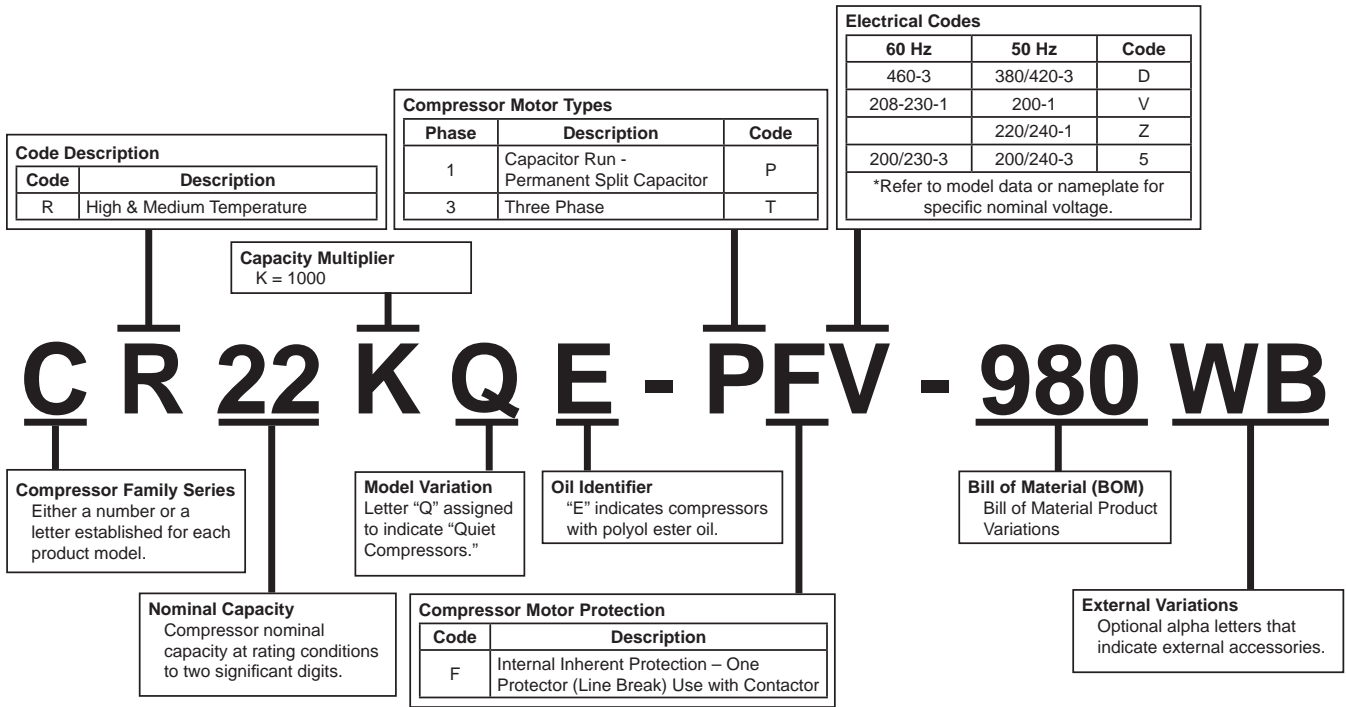

## Crankcase Heaters

| Application Code | Wrap Around Style |             | Voltage  | Watts | Type        |
|------------------|-------------------|-------------|----------|-------|-------------|
|                  | OEM               | Service     |          |       |             |
|                  | (018-)            | (918-)      |          |       |             |
| 1                | 018-0088-00       | 918-0088-00 | 240/265V | 40/49 | Wrap Around |
| 1                | 018-0088-01       | 918-0088-01 | 480/575V | 40/57 |             |
| 2                | 018-0088-04       | 918-0088-04 | 240/265V | 40/49 |             |
| 2                | 018-0088-05       | 918-0088-05 | 480/575V | 40/57 |             |
| 3                | 018-0075-00       | 918-0037-02 | 240V     | 58    |             |
| 3                | 018-0075-01       | 918-0037-03 | 480V     | 50    |             |

\* NOTE: 018-0031-05/918-0031-05 Crankcase Heaters used on previous models are no longer available.

## Molded Plugs

| Wire Gauge | Part Number |
|------------|-------------|
| 10         | 529-0060-04 |
| 14         | 529-0060-06 |

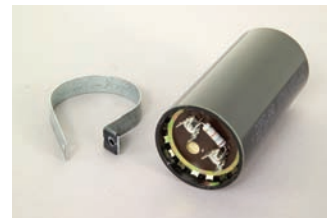

# C – Hermetic Compressors

## CF - Compressor Parts

| Model        | Start Capacitor |                   | Run Capacitor |                   | Relay         |                   | Crankcase Heater |                   |             | MTG Parts<br>(527-) |
|--------------|-----------------|-------------------|---------------|-------------------|---------------|-------------------|------------------|-------------------|-------------|---------------------|
|              | OEM<br>(014-)   | Service<br>(914-) | OEM<br>(014-) | Service<br>(914-) | OEM<br>(040-) | Service<br>(940-) | Insertion Style  |                   | Wrap Around |                     |
|              |                 |                   |               |                   |               |                   | OEM<br>(018-)    | Service<br>(918-) |             |                     |
| CF04K6E-PFV* | 0061-04         | 0008-51           | 0064-06       | 0037-10           | 0166-15       | 0001-55           | 0088-00          | 0088-00           | 1           | 0044-08             |
| CF04K6E-TF*  |                 |                   |               |                   |               |                   | 0088-00          | 0088-00           | 1           | 0044-08             |
| CF06K6E-PFV* | 0061-04         | 0008-51           | 0064-06       | 0037-10           | 0166-15       | 0001-55           | 0088-00          | 0088-00           | 1           | 0044-08             |
| CF06K6E-TF*  |                 |                   |               |                   |               |                   | 0088-00          | 0088-00           | 1           | 0044-08             |
| CF09K6E-PFV* | 0061-28         | 0036-04           | 0064-08       | 0037-12           | 0166-15       | 0001-55           | 0088-00          | 0088-00           | 1           | 0044-08             |
| CF09K6E-TF*  |                 |                   |               |                   |               |                   | 0088-00          | 0088-00           | 1           | 0044-08             |
| CF12K6E-PFV* | 0006-13         | 0006-03           | 0064-14       | 0037-18           | 0166-19       | 0001-60           | 0088-00          | 0088-00           | 1           | 0044-00             |
| CF12K6E-TF*  |                 |                   |               |                   |               |                   | 0088-00          | 0088-00           | 1           | 0044-00             |

## CR - Compressor Parts

| Model          | Start Capacitor |                   | Run Capacitor |                   | Relay         |                   | Crankcase Heater |                   |             | MTG Parts<br>(527-) |
|----------------|-----------------|-------------------|---------------|-------------------|---------------|-------------------|------------------|-------------------|-------------|---------------------|
|                | OEM<br>(014-)   | Service<br>(914-) | OEM<br>(014-) | Service<br>(914-) | OEM<br>(040-) | Service<br>(940-) | Insertion Style  |                   | Wrap Around |                     |
|                |                 |                   |               |                   |               |                   | OEM<br>(018-)    | Service<br>(918-) |             |                     |
| CR14K6(E)-PFV* | 0061-28         | 0036-04           | 0064-07       | 0037-11           | 0166-15       | 0001-55           | N/A              | N/A               | 1           | 0044-08             |
| CR16K6(E)-PFJ* | 0061-27         | 0036-03           | 0064-05       | 0037-09           | 0166-15       | 0001-55           | 0088-00          | 0088-00           | 1           | 0044-08             |
| CR16K6(E)-PFV* | 0061-28         | 0036-04           | 0064-05       | 0037-09           | 0166-15       | 0001-55           | 0088-00          | 0088-00           | 1           | 0044-08             |
| CR16KQ-PFV*    | 0006-16         | 0006-11           | 0064-11       | 0037-15           | 0166-15       | 0001-55           | N/A              | N/A               | 3           | 0044-08             |
| CR18K6(E)-PFV* | 0061-28         | 0036-04           | 0064-05       | 0037-09           | 0166-15       | 0001-55           | 0088-00          | 0088-00           | 1           | 0044-08             |
| CR18KQ(E)-PFV* | 0006-16         | 0006-11           | 0064-12       | 0037-16           | 0166-15       | 0001-55           | N/A              | N/A               | 3           | 0044-08             |
| CR18KQ(E)-PFZ* | 0006-16         | 0006-11           | 0064-11       | 0037-15           | 0166-15       | 0001-55           | N/A              | N/A               | 3           | 0044-08             |
| CR18KQ(E)-TF*  |                 |                   |               |                   |               |                   | N/A              | N/A               | 3           | 0044-08             |
| CR20K6(E)-PFV* | 0061-04         | 0008-51           | 0064-06       | 0037-16           | 0166-19       | 0001-60           | 0088-00          | 0088-00           | 1           | 0044-08             |
| CR20KQ(E)-PFV* | 0061-28         | 0006-11           | 0064-06       | 0037-16           | 0166-15       | 0001-55           | N/A              | N/A               | 3           | 0044-08             |
| CR22K6(E)-PFV* | 0061-04         | 0008-51           | 0064-06       | 0037-10           | 0166-19       | 0001-60           | N/A              | N/A               | 1           | 0044-08             |
| CR22K6(E)-TF*  |                 |                   |               |                   |               |                   | 0088-00          | 0088-00           | 1           | 0044-08             |
| CR22KQ(E)-PFV* | 0061-13         | 0006-11           | 0064-13       | 0037-17           | 0166-15       | 0001-87           | N/A              | N/A               | 3           | 0044-08             |
| CR22KQ(E)-TF*  |                 |                   |               |                   |               |                   | N/A              | N/A               | 3           | 0044-08             |
| CR24K6(E)-PFV* | 0061-28         | 0006-11           | 0064-07       | 0037-11           | 0166-15       | 0001-55           | 0088-00          | 0088-00           | 1           | 0044-08             |
| CR24K6(E)-TF*  |                 |                   |               |                   |               |                   | N/A              | N/A               | 1           | 0044-08             |
| CR24KQ(E)-PFV* | 0006-16         | 0006-11           | 0064-13       | 0037-17           | 0166-15       | 0001-55           | N/A              | N/A               | 3           | 0044-08             |
| CR32KQ(E)-PFV* | 0061-28         | 0036-04           | 0064-13       | 0037-17           | 0166-15       | 0001-55           | N/A              | N/A               | 3           | 0044-08             |
| CR32KQ(E)-TF*  |                 |                   |               |                   |               |                   | N/A              | N/A               | 3           | 0044-08             |
| CR33KQ(E)-PFV* | 0006-13         | 0006-03           | 0064-14       | 0037-18           | 0166-14       | 0001-54           | 0088-00          | 0088-00           | N/A         | 0044-08             |
| CR33KQ(E)-TF*  |                 |                   |               |                   |               |                   | 0088-00          | 0088-00           | N/A         | 0044-08             |
| CR34K6(E)-PFV* | 0006-13         | 0006-03           | 0064-29       | 0037-18           | 0166-15       | 0001-55           | 0088-00          | 0088-00           |             | 0044-08             |
| CR34KQ(E)-PFV* | 0006-13         | 0006-03           | 0064-29       | 0037-18           | 0166-14       | 0001-54           | 0088-00          | 0088-00           | N/A         | 0044-08             |
| CR34KQ(E)-TF*  |                 |                   |               |                   |               |                   | 0088-00          | 0088-00           | N/A         | 0044-08             |
| CR35K6(E)-PFV* | 0006-13         | 0006-03           | 0064-08       | 0037-12           | 0166-15       | 0001-55           | 0088-00          | 0088-00           | 1           | 0044-08             |
| CR35K6(E)-TF*  |                 |                   |               |                   |               |                   | 0088-00          | 0088-00           | 1           | 0044-08             |

## CR - Compressor Parts

| Model          | Start Capacitor |                   | Run Capacitor |                   | Relay         |                   | Crankcase Heater |                   |             | MTG Parts<br>(527-) |
|----------------|-----------------|-------------------|---------------|-------------------|---------------|-------------------|------------------|-------------------|-------------|---------------------|
|                | OEM<br>(014-)   | Service<br>(914-) | OEM<br>(014-) | Service<br>(914-) | OEM<br>(040-) | Service<br>(940-) | Insertion Style  |                   | Wrap Around |                     |
|                |                 |                   |               |                   |               |                   | OEM<br>(018-)    | Service<br>(918-) |             |                     |
| CR36KQ(E)-PFV* | 0006-13         | 0006-03           | 0064-14       | 0037-18           | 0166-14       | 0001-54           | 0088-00          | 0088-00           | N/A         | 0044-08             |
| CR36KQ(E)-TF*  |                 |                   |               |                   |               |                   | 0088-00          | 0088-00           | N/A         | 0044-08             |
| CR37KQ(E)-PFV* | 0006-13         | 0006-03           | 0064-08       | 0037-12           | 0166-19       | 0001-60           | 0088-00          | 0088-00           | N/A         | 0044-08             |
| CR37KQ(E)-TF*  |                 |                   |               |                   |               |                   | 0088-00          | 0088-00           | N/A         | 0044-08             |
| CR38K6(E)-PFV* | 0006-13         | 0006-03           | 0064-14       | 0037-18           | 0166-19       | 0001-60           | 0088-00          | 0088-00           | 1           | 0044-08             |
| CR38K6(E)-TF*  |                 |                   |               |                   |               |                   | 0088-00          | 0088-00           | 1           | 0044-08             |
| CR41KQ(E)-PFV* | 0006-13         | 0006-03           | 0064-16       | 0037-20           | 0166-27       | 0001-68           | 0088-00          | 0088-00           | N/A         | 0044-08             |
| CR41KQ(E)-TF*  |                 |                   |               |                   |               |                   | 0088-00          | 0088-00           | N/A         | 0044-08             |
| CR24KQ(E)-PFZ* | 0006-16         | 0006-11           | 0064-13       | 0037-17           | 0166-15       | 0001-55           | N/A              | N/A               | 3           | 0044-08             |
| CR24KQ(E)-TF*  |                 |                   |               |                   |               |                   | N/A              | N/A               | 3           | 0044-08             |
| CR28K6(E)-PFJ* | 0061-26         | 0036-02           | 0064-07       | 0037-11           | 0166-15       | 0001-54           | 0088-00          | 0088-00           | 1           | 0044-08             |
| CR28K6(E)-PFV* | 0061-04         | 0008-51           | 0064-07       | 0037-11           | 0166-19       | 0001-60           | 0088-00          | 0088-00           | 1           | 0044-08             |
| CR28K6(E)-PFJ* | 0061-26         | 0036-02           | 0064-13       | 0037-17           | 0166-15       | 0001-55           | 0088-00          | 0088-00           | 1           | 0044-08             |
| CR28K6(E)-TF*  |                 |                   |               |                   |               |                   | 0088-00          | 0088-00           | 1           | 0044-08             |
| CR28KQ(E)-PFV* | 0006-16         | 0006-11           | 0064-13       | 0037-11           | 0166-15       | 0001-55           | N/A              | N/A               | 3           | 0044-08             |
| CR28KQ(E)-PFZ* | 0006-16         | 0006-11           | 0064-14       | 0037-18           | 0166-15       | 0001-54           | N/A              | N/A               | 3           | 0044-08             |
| CR28KQ(E)-TF*  |                 |                   |               |                   |               |                   | N/A              | N/A               | 3           | 0044-08             |
| CR30K6(E)-PFJ* | 0061-28         | 0036-04           | 0064-14       | 0037-18           | 0166-15       | 0001-55           | 0088-00          | 0088-00           | 1           | 0044-08             |
| CR30K6(E)-PFV* | 0061-28         | 0036-04           | 0064-07       | 0037-11           | 0166-15       | 0001-54           | 0088-00          | 0088-00           | 1           | 0044-08             |
| CR30KQ(E)-PFV* | 0006-16         | 0006-11           | 0064-13       | 0037-17           | 0166-15       | 0001-55           | N/A              | N/A               | 3           | 0044-08             |
| CR30KQ(E)-TF*  |                 |                   |               |                   |               |                   | N/A              | N/A               | 3           | 0044-08             |
| CR32K6(E)-PFJ* | 0061-28         | 0036-04           | 0064-08       | 0037-12           | 0166-14       | 0001-54           | 0088-00          | 0088-00           | 1           | 0044-08             |
| CR32K6(E)-PFV* | 0061-28         | 0036-04           | 0064-13       | 0037-17           | 0166-14       | 0001-54           | 0088-00          | 0088-00           | 1           | 0044-08             |
| CR32K6(E)-TF*  |                 |                   |               |                   |               |                   | 0088-00          | 0088-00           | 1           | 0044-08             |
| CR42K6(E)-PFV* | 0006-13         | 0006-03           | 0064-14       | 0037-18           | 0166-27       | 0001-68           | 0088-00          | 0088-00           | 1           | 0044-08             |
| CR42K6(E)-TF*  |                 |                   |               |                   |               |                   | 0088-00          | 0088-00           | 1           | 0044-08             |
| CR47KQ(E)-PFV* | 0006-13         | 0006-03           | 0064-15       | 0037-19           | 0166-18       | 0001-59           | 0088-00          | 0088-00           | N/A         | 0044-00             |
| CR47KQ(E)-TF*  |                 |                   |               |                   |               |                   | 0088-00          | 0088-00           | N/A         | 0044-00             |
| CR53KQ(E)-PFV* | 0006-13         | 0006-03           | 0064-18       | 0037-22           | 0166-18       | 0001-59           | 0088-00          | 0088-00           | N/A         | 0044-00             |
| CR53KQ(E)-TF*  |                 |                   |               |                   |               |                   | 0088-00          | 0088-00           | N/A         | 0044-00             |
| CR60KQ-PFV*    | 0006-13         | 0006-03           | 0064-15       | 0037-19           | 0166-27       | 0001-68           | 0088-00          | 0088-00           | 2           | 0044-00             |
| CR60KQ-TF*     |                 |                   |               |                   |               |                   | 0088-00          | 0088-00           | 2           | 0044-00             |
| CR60K5-PFV*    | 0006-13         | 0006-03           | 0064-15       | 0037-19           | 0166-27       | 0001-68           | 0088-00          | 0088-00           | 2           | 0044-00             |
| CR60K5-TF*     |                 |                   |               |                   |               |                   | 0088-00          | 0088-00           | 2           | 0044-00             |
| CRA1-0150-PFV* | 0061-28         | 0036-04           | 0064-05       | 0037-09           | 0166-15       | 0001-55           | 0088-00          | 0088-00           | N/A         | 0044-08             |
| CRA1-0150-TF*  |                 |                   |               |                   |               |                   | 0088-00          | 0088-00           | N/A         | 0044-08             |
| CRB1-0175-PFV* | 0061-28         | 0036-04           | 0064-05       | 0037-09           | 0166-15       | 0001-55           | 0088-00          | 0088-00           | N/A         | 0044-08             |
| CRC1-0175-PFV* | 0061-28         | 0008-51           | 0064-06       | 0037-10           | 0166-15       | 0001-56           | 0088-00          | 0088-00           | N/A         | 0044-08             |
| CRC1-0175-TF*  |                 |                   |               |                   |               |                   | 0088-00          | 0088-00           | N/A         | 0044-08             |
| CRD1-0200-PFV* | 0061-28         | 0036-04           | 0064-07       | 0037-11           | 0166-15       | 0001-55           | 0088-00          | 0088-00           | N/A         | 0044-08             |
| CRD1-0200-TF*  |                 |                   |               |                   |               |                   | 0088-00          | 0088-00           | N/A         | 0044-08             |
| CRE1-0225-TF*  |                 |                   |               |                   |               |                   | 0088-00          | 0088-00           | N/A         | 0044-08             |

# C – Hermetic Compressors

## CR - Compressor Parts

| Model            | Start Capacitor |                   | Run Capacitor |                   | Relay         |                   | Crankcase Heater |                   |                | MTG Parts<br>(527-) |
|------------------|-----------------|-------------------|---------------|-------------------|---------------|-------------------|------------------|-------------------|----------------|---------------------|
|                  | OEM<br>(014-)   | Service<br>(914-) | OEM<br>(014-) | Service<br>(914-) | OEM<br>(040-) | Service<br>(940-) | Insertion Style  |                   | Wrap<br>Around |                     |
|                  |                 |                   |               |                   |               |                   | OEM<br>(018-)    | Service<br>(918-) |                |                     |
| CRE2-0225-PFV*   | 0061-28         | 0036-04           | 0064-07       | 0037-11           | 0166-15       | 0001-55           | 0088-00          | 0088-00           | N/A            | 0044-08             |
| CRF2-0250-PFV*   | 0035-20         | 0036-04           | 0064-07       | 0037-11           | 0166-15       | 0001-55           | 0088-00          | 0088-00           | N/A            | 0044-08             |
| CRG3-0250-PFV*   | 0061-28         | 0036-04           | 0064-08       | 0037-12           | 0166-15       | 0001-55           | 0088-00          | 0088-00           | N/A            | 0044-08             |
| CRG3-0250-TF*    |                 |                   |               |                   |               |                   | 0088-00          | 0088-00           | N/A            | 0044-08             |
| CRH3-0275-PFV*   | 0006-13         | 0006-03           | 0064-08       | 0037-12           | 0166-15       | 0001-55           | 0088-00          | 0088-00           | N/A            | 0044-08             |
| CRH3-0275-TF*    |                 |                   |               |                   |               |                   | 0088-00          | 0088-00           | N/A            | 0044-08             |
| CRJ3-0300-PFV*   | 0006-13         | 0006-03           | 0064-13       | 0037-17           | 0166-14       | 0001-54           | 0088-00          | 0088-00           | N/A            | 0044-08             |
| CRJ3-0300-TF*    |                 |                   |               |                   |               |                   | 0088-00          | 0088-00           | N/A            | 0044-08             |
| CRK3-0325-PFV*   | 0006-13         | 0006-03           | 0064-14       | 0037-18           | 0166-23       | 0001-64           | 0088-00          | 0088-00           | N/A            | 0044-08             |
| CRK3-0325-TF*    |                 |                   |               |                   |               |                   | 0088-00          | 0088-00           | N/A            | 0044-08             |
| CRL3-0350-PFV*   | 0006-13         | 0006-03           | 0064-14       | 0037-18           | 0166-23       | 0001-64           | 0088-00          | 0088-00           | N/A            | 0044-08             |
| CRL3-0350-TF*    |                 |                   |               |                   |               |                   | 0088-00          | 0088-00           | N/A            | 0044-08             |
| CRM3-0400-PFV*   | 0006-13         | 0006-03           | 0064-16       | 0037-20           | 0166-22       | 0001-68           | 0088-00          | 0088-00           | N/A            | 0044-08             |
| CRM3-0400-TF*    |                 |                   |               |                   |               |                   | 0088-00          | 0088-00           | N/A            | 0044-08             |
| CRN5-0500-PFV*   | 0006-15         | 0006-10           | 0064-17       | 0037-21           | 0166-27       | 0001-68           | 0088-00          | 0088-00           | 2              | 0116-00             |
| CRN5-0500-T*     |                 |                   |               |                   |               |                   | 0088-00          | 0088-00           | 2              | 0116-00             |
| CRNQ-050(E)-PFV* | 0006-15         | 0006-10           | 0064-17       | 0037-21           | 0166-27       | 0001-68           | 0088-00          | 0088-00           | 2              | 0116-00             |
| CRNQ-050(E)-TF*  |                 |                   |               |                   |               |                   | 0088-00          | 0088-00           | 2              | 0116-00             |
| CRP5-0450-PFV*   | 0006-13         | 0006-03           | 0064-15       | 0037-19           | 0166-27       | 0001-68           | 0088-00          | 0088-00           | 2              | 0116-00             |
| CRP5-0450-TF*    |                 |                   |               |                   |               |                   | 0088-00          | 0088-00           | 2              | 0116-00             |
| CRPQ-0450-PFV*   | 0006-13         | 0006-03           | 0064-15       | 0037-19           | 0166-27       | 0001-68           | 0088-00          | 0088-00           | 2              | 0116-00             |
| CRPQ-0450-TF*    |                 |                   |               |                   |               |                   | 0088-00          | 0088-00           | 2              | 0116-00             |
| CRT5-0450-PFV*   | 0006-13         | 0006-03           | 0064-15       | 0037-19           | 0166-27       | 0001-68           | 0088-00          | 0088-00           | 2              | 0116-00             |
| CRT5-0450-TF*    |                 |                   |               |                   |               |                   | 0088-00          | 0088-00           | 2              | 0116-00             |
| CRTQ-0450-PFV*   | 0006-13         | 0006-03           | 0064-15       | 0037-19           | 0166-27       | 0001-68           | 0088-00          | 0088-00           | 2              | 0116-00             |
| CRTQ-0450-TF*    |                 |                   |               |                   |               |                   | 0088-00          | 0088-00           | 2              | 0116-00             |



**CR**



**CS**



**CT**



## CS - Compressor Parts

| Model        | Start Capacitor |                   | Run Capacitor |                   | Relay         |                   | Crankcase Heater |                   |             | MTG Parts<br>(527-) |
|--------------|-----------------|-------------------|---------------|-------------------|---------------|-------------------|------------------|-------------------|-------------|---------------------|
|              | OEM<br>(014-)   | Service<br>(914-) | OEM<br>(014-) | Service<br>(914-) | OEM<br>(040-) | Service<br>(940-) | Insertion Style  |                   | Wrap Around |                     |
|              |                 |                   |               |                   |               |                   | OEM<br>(018-)    | Service<br>(918-) |             |                     |
| CS07KQE-PFV* | 0061-28         | 0036-04           | 0064-06       | 0037-10           | 0166-15       | 0001-55           | 0088-00          | 0088-00           | 1           | 0044-08             |
| CS07KQE-TF*  |                 |                   |               |                   |               |                   | 0088-00          | 0088-00           | 1           | 0044-08             |
| CS08KQE-PFV* | 0061-28         | 0036-04           | 0064-06       | 0037-10           | 0166-15       | 0001-55           | 0088-00          | 0088-00           | 1           | 0044-08             |
| CS08KQE-TF*  |                 |                   |               |                   |               |                   | 0088-00          | 0088-00           | 1           | 0044-08             |
| CS10K6E-PFV* | 0061-04         | 0008-51           | 0064-06       | 0037-10           | 0166-19       | 0001-60           | 0088-00          | 0088-00           | 1           | 0044-08             |
| CS10K6E-TF*  |                 |                   |               |                   |               |                   | 0088-00          | 0088-00           | 1           | 0044-08             |
| CS12K6E-PFJ* | 0061-26         | 0036-02           | 0064-12       | 0037-16           | 0166-15       | 0001-55           | 0088-00          | 0088-00           | 1           | 0044-08             |
| CS12K6E-PFV* | 0061-04         | 0008-51           | 0064-06       | 0037-10           | 0166-19       | 0001-60           | 0088-00          | 0088-00           | 1           | 0044-08             |
| CS12K6E-TF*  |                 |                   |               |                   |               |                   | 0088-00          | 0088-00           | 1           | 0044-08             |
| CS13K6E-PFV* | 0006-13         | 0006-03           | 0064-13       | 0037-17           | 0166-15       | 0001-55           | 0088-00          | 0088-00           | 1           | 0044-08             |
| CS13K6E-TF*  |                 |                   |               |                   |               |                   | 0088-00          | 0088-00           | 1           | 0044-08             |
| CS14K6E-PFV* | 0061-28         | 0036-04           | 0064-07       | 0037-11           | 0166-15       | 0001-55           | 0088-00          | 0088-00           | 1           | 0044-08             |
| CS14K6E-TF*  |                 |                   |               |                   |               |                   | 0088-00          | 0088-00           | 1           | 0044-08             |
| CS16K6E-PFV* | 0006-13         | 0006-03           | 0064-13       | 0037-17           | 0166-15       | 0001-55           | 0088-00          | 0088-00           | 1           | 0044-08             |
| CS16K6E-TF*  |                 |                   |               |                   |               |                   | 0088-00          | 0088-00           | 1           | 0044-08             |
| CS17K6E-PFV* | 0061-27         | 0036-03           | 0064-13       | 0037-17           | 0166-14       | 0001-54           | 0088-00          | 0088-00           | 1           | 0044-08             |
| CS18K6E-PFV* | 0061-28         | 0036-04           | 0064-07       | 0037-11           | 0166-15       | 0001-55           | 0088-00          | 0088-00           | 1           | 0044-08             |
| CS18K6E-TF*  |                 |                   |               |                   |               |                   | 0088-00          | 0088-00           | 1           | 0044-08             |
| CS20K6E-PFV* | 0006-13         | 0006-03           | 0064-08       | 0037-12           | 0166-15       | 0001-55           | 0088-00          | 0088-00           | 1           | 0044-08             |
| CS20K6E-TF*  |                 |                   |               |                   |               |                   | 0088-00          | 0088-00           | 1           | 0044-08             |
| CS24K6E-PFV* | 0006-13         | 0006-03           | 0064-14       | 0037-18           | 0166-23       | 0001-64           | 0088-00          | 0088-00           | 1           | 0044-08             |
| CS24K6E-TF*  |                 |                   |               |                   |               |                   | 0088-00          | 0088-00           | 1           | 0044-08             |
| CS27K3E-PFV* | 0006-13         | 0006-03           | 0064-14       | 0037-18           | 0166-23       | 0001-55           | 0088-00          | 0088-00           | 1           | 0044-08             |
| CS27K3E-TF*  |                 |                   |               |                   |               |                   | 0088-00          | 0088-00           | 1           | 0044-08             |
| CS27K6E-PFV* | 0006-13         | 0006-03           | 0064-14       | 0037-18           | 0166-23       | 0001-55           | 0088-00          | 0088-00           | 1           | 0044-08             |
| CS27K6E-TF*  |                 |                   |               |                   |               |                   | 0088-00          | 0088-00           | 1           | 0044-08             |
| CS33K3E-PFV* | 0006-13         | 0006-03           | 0064-16       | 0037-20           | 0166-27       | 0001-68           | 0088-00          | 0088-00           | 1           | 0044-08             |
| CS33K3E-TF*  |                 |                   |               |                   |               |                   | 0088-00          | 0088-00           | 1           | 0044-08             |
| CS33K6E-PFV* | 0006-13         | 0006-03           | 0064-16       | 0037-20           | 0166-27       | 0001-68           | 0088-00          | 0088-00           | 1           | 0044-08             |
| CS33K6E-TF*  |                 |                   |               |                   |               |                   | 0088-00          | 0088-00           | 1           | 0044-08             |

## CT - Compressor Parts

| Model          | Start Capacitor |                   | Run Capacitor |                   | Relay         |                   | Crankcase Heater |                   |             | MTG Parts<br>(527-) |
|----------------|-----------------|-------------------|---------------|-------------------|---------------|-------------------|------------------|-------------------|-------------|---------------------|
|                | OEM<br>(014-)   | Service<br>(914-) | OEM<br>(014-) | Service<br>(914-) | OEM<br>(040-) | Service<br>(940-) | Insertion Style  |                   | Wrap Around |                     |
|                |                 |                   |               |                   |               |                   | OEM<br>(018-)    | Service<br>(918-) |             |                     |
| CTH1-0275-CSV* | 0006-16         | 0006-11           | 0064-13       | 0037-17           | 0166-41       | 0001-84           | 0088-00          | 0088-00           | 0044-08     |                     |
| CTL1-0350-CSV* | 0006-16         | 0006-11           | 0064-15       | 0037-19           | 0166-43       | 0001-86           | 0088-00          | 0088-00           | 0044-08     |                     |
| CTL1-0350-TS*  |                 |                   |               |                   |               |                   | 0088-00          | 0088-00           | 0044-08     |                     |
| CTN1-0500-TS*  |                 |                   |               |                   |               |                   | 0088-00          | 0088-00           | 0044-08     |                     |
| CTN1-0501-CSV* | 0006-17         | 0006-12           | 0064-17       | 0037-21           | 0166-42       | 0001-85           | 0088-00          | 0088-00           | 0044-08     |                     |

**Note:** 2 speed CT compressors are obsolete and replacement compressors are no longer available.

# R – Hermetic Compressors

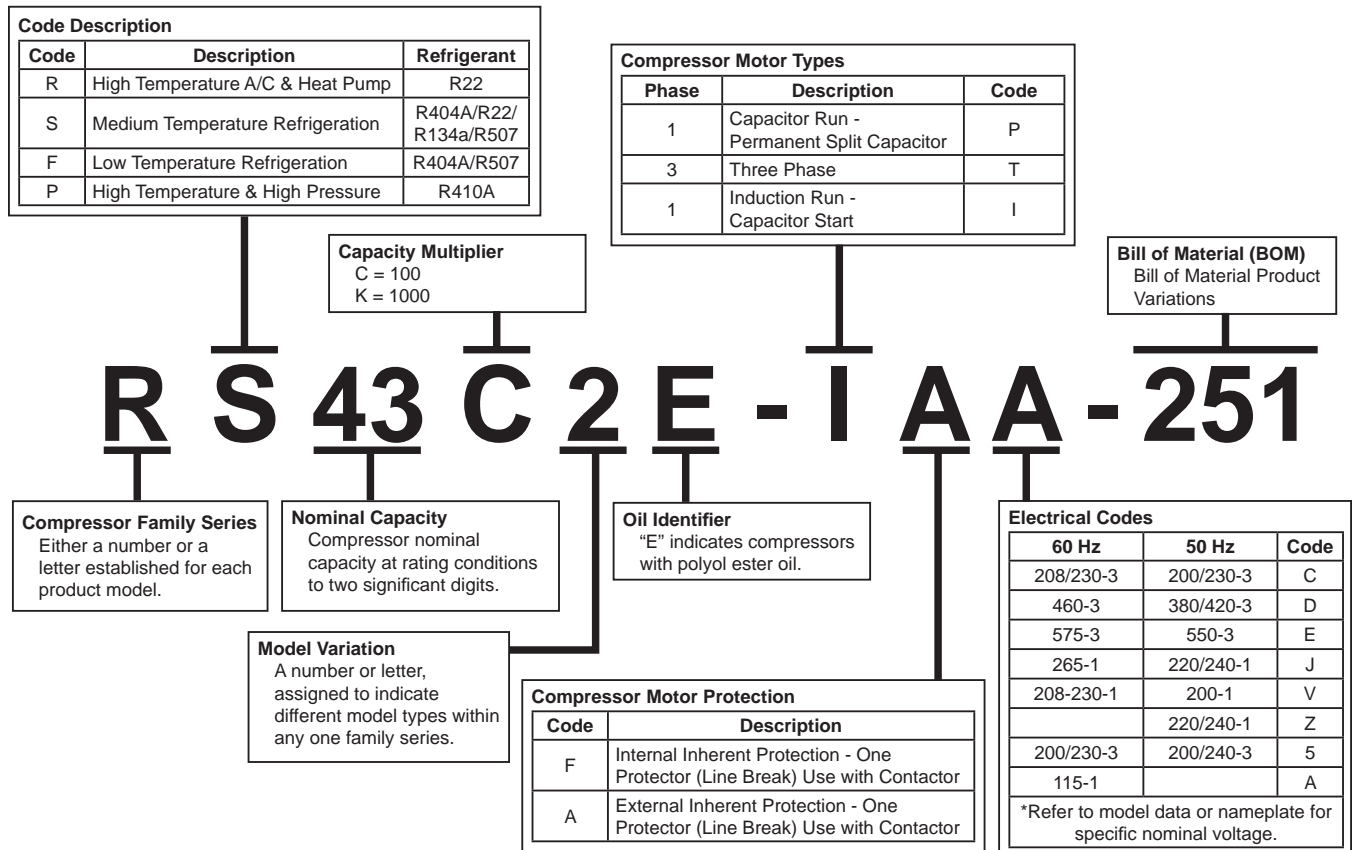
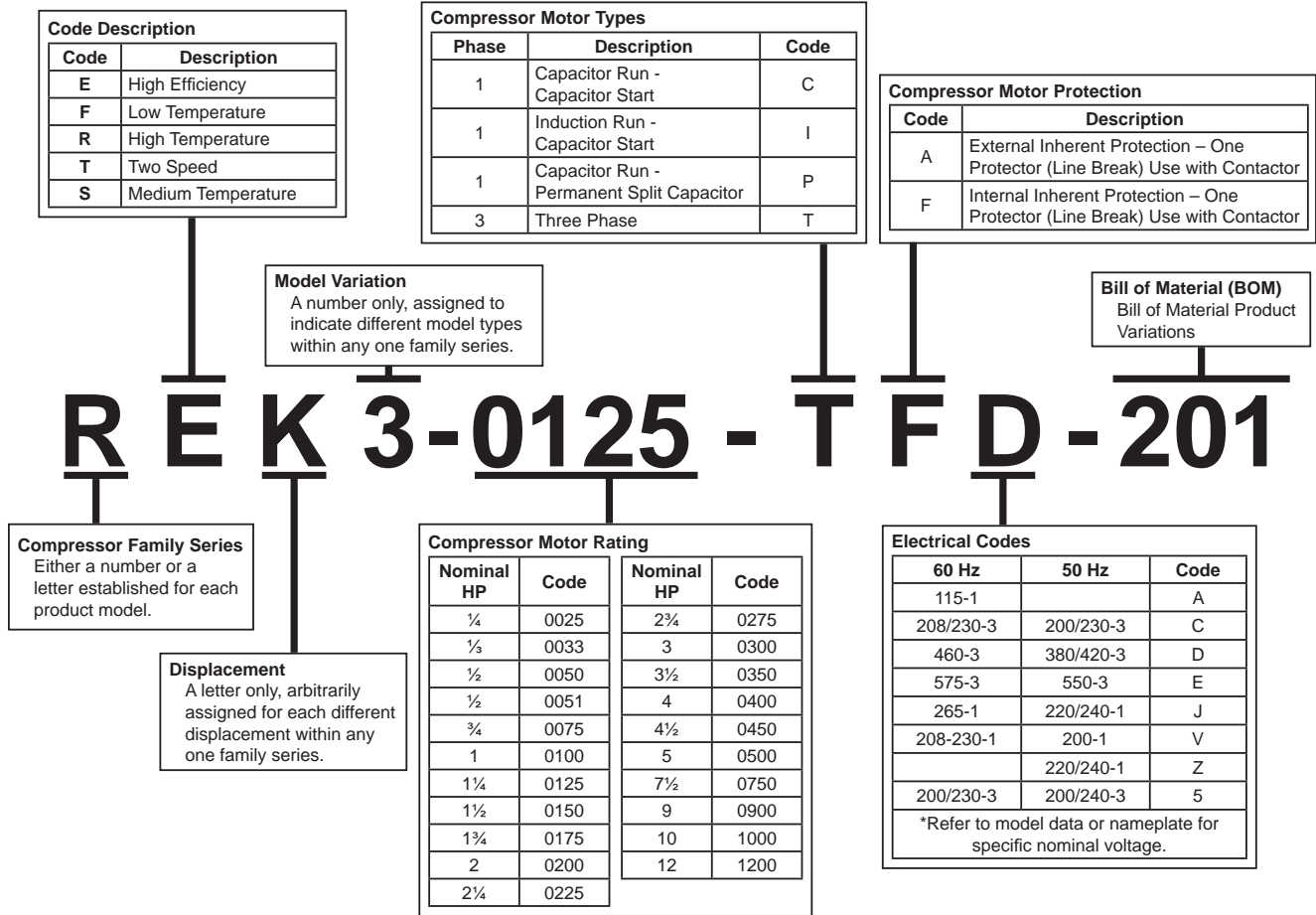

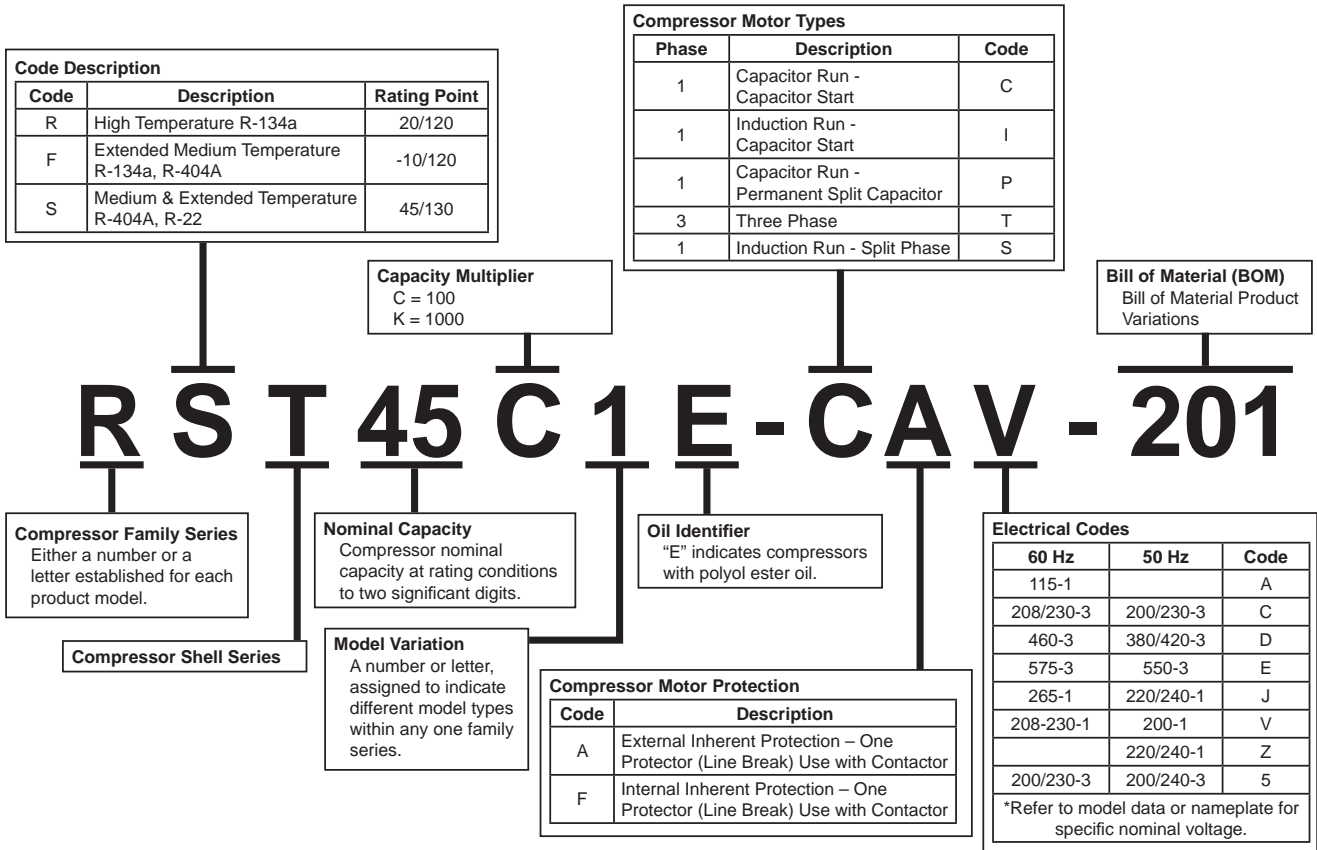

## Crankcase Heaters

| Application Code | OEM     | Service | Voltage | Watts   | Lead Length |
|------------------|---------|---------|---------|---------|-------------|
|                  | (018-)  | (918-)  |         |         |             |
| #1               | 0089-00 | 0038-00 | 120V    | 48 WATT | 49" Lead    |
| #1               | 0089-02 | 0038-01 | 240V    | 48 WATT | 49" Lead    |
| #2               | 0097-00 | 0097-00 | 120V    | 20 WATT | 49" Lead    |
| #2               | 0097-01 | 0097-01 | 240V    | 20 WATT | 49" Lead    |



RR



# R – Hermetic Compressors

## RE - Compressor Parts

| Model          | Start Capacitor |         | Run Capacitor |         | Relay   |         | Protector | Crankcase Heater | MTG Parts |
|----------------|-----------------|---------|---------------|---------|---------|---------|-----------|------------------|-----------|
|                | OEM             | Service | OEM           | Service | OEM     | Service |           |                  |           |
|                | (014-)          | (914-)  | (014-)        | (914-)  | (040-)  | (940-)  |           |                  |           |
| REB3-0150-PFV* | 0061-14         | 0008-66 | 0064-05       | 0037-09 | 0166-19 | 0001-60 | IP        | 1                | 0039-04   |
| REK3-0125-PFV* | 0061-14         | 0008-66 | 0064-05       | 0037-09 | 0166-19 | 0001-60 | IP        | 1                | 0039-04   |
| REK3-0125-TFC* |                 |         |               |         |         |         | IP        | 1                | 0039-04   |
| REL3-0200-PFV* | 0061-18         | 0008-72 | 0064-05       | 0037-09 | 0166-19 | 0001-60 | IP        | 1                | 0039-04   |
| RES3-0175-PFV* | 0061-20         | 0008-74 | 0064-05       | 0037-09 | 0166-19 | 0001-60 | IP        | 1                | 0039-04   |
| REY3-0175-PFV* | 0061-20         | 0008-74 | 0064-06       | 0037-10 | 0166-19 | 0001-60 | IP        | 1                | 0039-04   |
| REY3-0175-TFC* |                 |         |               |         |         |         | IP        | 1                | 0039-04   |
| REZ3-0125-PFV* | 0061-14         | 0008-66 | 0064-04       | 0037-08 | 0166-19 | 0001-60 | IP        | 1                | 0039-04   |

## RF - Compressor Parts

| Model          | Start Capacitor |         | Run Capacitor |         | Relay   |         | Protector |         | Crankcase Heater | MTG Parts |
|----------------|-----------------|---------|---------------|---------|---------|---------|-----------|---------|------------------|-----------|
|                | OEM             | Service | OEM           | Service | OEM     | Service | OEM       | Service |                  |           |
|                | (014-)          | (914-)  | (014-)        | (914-)  | (040-)  | (940-)  | (071-)    | (971-)  |                  |           |
| RF18C1(E)-IAA* | 0061-22         | 0008-79 |               |         | 0166-21 | 0088-04 | 0127-06   | 0127-06 | 1                | 0039-04   |
| RF18C1(E)-IAV* | 0061-18         | 0008-72 |               |         | 0166-22 | 0088-07 | 0329-26   | 0329-26 | 1                | 0039-04   |
| RF18C2(E)-IAA* | 0061-22         | 0008-79 |               |         | 0166-21 | 0088-04 | 0127-06   | 0127-06 | 1                | 0039-04   |
| RF18C2(E)-IAV* | 0061-88         | 0008-72 |               |         | 0166-22 | 0088-07 | 0329-26   | 0329-26 | 1                | 0039-04   |
| RF40C1E-CAA*   | 0061-27         | 0036-03 | 0064-08       | 0037-12 | 0166-14 | 0001-54 | 0518-03   |         | 1                | 0039-04   |
| RF40C1E-CAV*   | 0061-12         | 0008-64 | 0064-00       | 0037-04 | 0166-14 | 0001-54 | 0527-07   |         | 1                | 0039-04   |
| RF41C1-CAA*    | 0061-17         | 0008-71 | 0064-07       | 0037-11 | 0166-15 | 0001-55 | 0518-09   |         | 1                | 0039-04   |
| RF41C1-CAV*    | 0061-14         | 0008-66 | 0064-10       | 0037-06 | 0166-14 | 0001-54 | 0518-10   |         | 1                | 0039-04   |
| RF41C5E-CAA*   | 0061-27         | 0036-03 | 0064-08       | 0037-12 | 0166-14 | 0001-54 | 0518-03   |         | 1                | 0039-04   |
| RF41C5E-CAV*   | 0061-14         | 0008-66 | 0064-02       | 0037-06 | 0166-14 | 0001-54 | 0518-10   |         | 1                | 0039-04   |
| RF42C1E-CAA*   | 0061-27         | 0036-03 | 0064-05       | 0037-09 | 0166-19 | 0001-60 | 0127-46   | 0127-46 | 1                | 0039-04   |
| RF42C1E-CAV*   | 0006-13         | 0006-03 | 0064-10       | 0037-14 | 0166-14 | 0001-54 | 0127-37   | 0127-37 | 1                | 0039-04   |
| RFT18C1E-PFA*  | 0006-08         | 0036-16 | 0064-08       | 0037-12 | 0166-38 | 0001-80 | IP        |         | 2                | C001-00   |
| RFT22C1E-CAA*  | 0061-32         | 0036-09 | 0064-13       | 0037-17 | 0166-21 | 0001-62 | 0604-13   | 0604-13 | 2                | C001-00   |
| RFT22C1E-CAV*  | 0061-20         | 0008-74 | 0064-36       | 0037-55 | 0166-39 | 0001-82 | 0561-01   | 0561-01 | 2                | C001-00   |
| RFT22C1E-IAA*  | 0061-32         | 0036-09 |               |         | 0172-03 | C016-03 | 0645-00   | N/A     | 2                | C001-00   |
| RFT22C1E-IAV*  | 0053-27         | 0053-11 |               |         | 0150-46 | N/A     | 0561-28   | 0554-02 | 2                | C001-00   |
| RFT26C1E-CAA*  | 0061-32         | 0036-09 | 0064-13       | 0037-17 | 0166-21 | 0001-62 | 0604-18   | 0604-18 | 2                | C001-00   |
| RFT26C1E-CAV*  | 0061-20         | 0008-74 | 0064-09       | 0037-13 | 0166-13 | 0001-53 | 0561-71   | 0561-71 | 2                | C001-00   |
| RFT26C1E-IAA*  | 0061-32         | 0036-09 |               |         | 0172-03 | C016-03 | 0605-10   | 0605-10 | 2                | C001-00   |
| RFT26C1E-IAV*  | 0053-27         | 0053-11 |               |         | 0150-43 | N/A     | 0561-24   | 0554-17 | 2                | C001-00   |
| RFT29C1E-CAA*  | 0061-32         | 0036-09 | 0064-13       | 0037-17 | 0166-21 | 0001-62 | 0604-16   | 0604-16 | 2                | C001-00   |
| RFT29C1E-CAV*  | 0061-30         | 0036-07 | 0064-36       | 0037-55 | 0166-29 | 0001-70 | 0561-28   | 0554-42 | 2                | C001-00   |
| RFT29C1E-IAA*  | 0061-32         | 0036-09 |               |         | 0172-03 | C016-03 | 0605-05   | C100-71 | 2                | C001-00   |
| RFT29C1E-IAZ*  | 0053-26         | 0053-10 |               |         | 0163-15 | 0150-31 | 0561-24   | 0554-17 | 2                | C001-00   |
| RFT32C1E-CAA*  | 0061-32         | 0036-09 | 0064-13       | 0037-17 | 0166-37 | 0001-79 | 0605-09   | 0605-09 | 2                | C001-00   |
| RFT32C1E-CAV*  | 0061-27         | 0036-03 | 0064-09       | 0037-13 | 0166-30 | 0001-71 | 0561-28   | 0554-42 | 2                | C001-00   |
| RFT32C1E-IAA*  | 0061-32         | 0036-09 |               |         | 0166-37 | 0001-79 | 0605-08   |         | 2                | C001-00   |
| RFT32C1E-IAZ*  | 0061-26         | 0036-02 | 0064-09       | 0037-13 | 0166-26 | 0166-26 | 0561-62   | 0561-62 | 2                | C001-00   |
| RFT42C1E-PFA*  | 0006-18         | 0036-16 | 0064-38       | 0037-54 | 0046-26 | 0046-26 | IP        |         | 2                | C001-00   |
| RFT42C1E-PFV*  | 0061-30         | 0036-07 | 0064-11       | 0037-15 | 0166-13 | 0166-13 | IP        |         | 2                | C001-00   |
| RFT42C1E-PFZ*  | 0061-27         | 0036-03 | 0064-10       | 0037-14 | 0166-46 | 0001-89 | IP        |         | 2                | C001-00   |

## RR - Compressor Parts

| Model          | Start Capacitor |         | Run Capacitor |         | Relay   |         | Protector |         | Crankcase Heater | MTG Parts<br>(527-) |
|----------------|-----------------|---------|---------------|---------|---------|---------|-----------|---------|------------------|---------------------|
|                | OEM             | Service | OEM           | Service | OEM     | Service | OEM       | Service |                  |                     |
|                | (014-)          | (914-)  | (014-)        | (914-)  | (040-)  | (940-)  | (071-)    | (971-)  |                  |                     |
| RR10K1(E)-CAA* | 0061-16         | 0008-78 | 0064-06       | 0037-10 | 0166-14 | 0001-54 | 0127-30   | 0127-30 | 1                | 0039-04             |
| RR10K1(E)-CAV* | 0061-14         | 0008-66 | 0064-02       | 0037-06 | 0166-14 | 0001-54 | 0127-05   | 0127-05 | 1                | 0039-04             |
| RR10K2(E)-CAA* | 0061-21         | 0008-78 | 0064-06       | 0037-10 | 0166-14 | 0001-54 | 0127-30   | 0127-30 | 1                | 0039-04             |
| RR10K2(E)-CAV* | 0061-14         | 0008-66 | 0064-02       | 0037-06 | 0166-14 | 0001-54 | 0127-05   | 0127-05 | 1                | 0039-04             |
| RR12K1-PFV*    | 0061-14         | 0008-66 | 0064-04       | 0037-08 | 0166-19 | 0001-60 | IP        |         | 1                | 0039-04             |
| RR14K1-PFJ*    | 0061-27         | 0006-02 | 0064-05       | 0037-09 | 0166-14 | 0001-54 | IP        |         | 1                | 0039-04             |
| RR14K1-PFV*    | 0061-14         | 0008-66 | 0064-06       | 0037-10 | 0166-19 | 0001-60 | IP        |         | 1                | 0039-04             |
| RR16K1-PFJ*    | 0061-16         | 0008-78 | 0064-11       | 0037-15 | 0166-15 | 0001-55 | IP        |         | 1                | 0039-04             |
| RR16K1-PFV*    | 0061-20         | 0008-74 | 0064-11       | 0037-15 | 0166-19 | 0001-60 | IP        |         | 1                | 0039-04             |
| RR17K1-PFJ*    | 0061-20         | 0008-74 | 0064-12       | 0037-16 | 0166-14 | 0001-54 | IP        |         | 1                | 0039-04             |
| RR17K1-PFV*    | 0061-16         | 0008-78 | 0064-06       | 0037-10 | 0166-37 | 0001-79 | IP        |         | 1                | 0039-04             |
| RR17K1-TFC*    |                 |         |               |         |         |         | IP        |         | 1                | 0039-04             |
| RR20K1-PFV*    | 0061-12         | 0008-72 | 0064-11       | 0037-15 | 0166-19 | 0001-60 | IP        |         | 1                | 0039-04             |
| RR81C1(E)-IAA* | 0061-17         | 0008-71 |               |         | 0166-38 | 0088-04 | 0127-18   | 0127-18 | 1                | 0039-04             |
| RR81C1(E)-IAV* | 0061-18         | 0008-72 |               |         | 0166-19 | 0001-60 | 0329-07   | 0329-07 | 1                | 0039-04             |
| RR81C2(E)-IAA* | 0062-17         | 0008-71 |               |         | 0166-38 | 0088-04 | 0127-18   | 0127-18 | 1                | 0039-04             |
| RR81C2(E)-IAV* | 0061-18         | 0008-72 |               |         | 0166-19 | 0001-60 | 0329-07   | 0329-07 | 1                | 0039-04             |
| RRG4-0100-PAA* | 0061-01         | 0008-48 | 0064-11       | 0037-15 | 0166-19 | 0001-60 | 0127-40   | 0127-40 | 1                | 0039-04             |
| RRG4-0100-PAV* | 0061-18         | 0008-72 | 0064-02       | 0037-06 | 0166-14 | 0001-54 | 0329-00   | 0329-00 | 1                | 0039-04             |
| RRK4-0126-PAA* | 0061-13         | 0008-65 | 0064-06       | 0037-10 | 0166-19 | 0001-60 | 0127-18   | 0127-18 | 1                | 0039-04             |
| RRL4-0100-CAA* | 0061-25         | 0008-74 | 0064-02       | 0037-06 | 0166-15 | 0001-55 | 0127-38   | N/A     | 1                | 0039-04             |
| RRL4-0100-CAV* | 0061-14         | 0008-66 | 0064-02       | 0037-06 | 0166-32 | 0001-54 | 0127-05   | 0127-05 | 1                | 0039-04             |
| RRS4-0075-IAA* | 0061-17         | 0008-71 |               |         | 0168-13 | 0088-04 | 0127-18   | 0127-18 | 1                | 0039-04             |
| RRS4-0075-IAV* | 0061-18         | 0008-72 |               |         | 0166-19 | 0001-60 | 0329-07   | 0329-07 | 1                | 0039-04             |
| RRT10K1E-PFA*  | 0006-18         | 0036-16 | 0064-08       | 0037-12 | 0046-26 | 0046-26 | IP        |         | 2                | C001-00             |
| RRT10K1E-PFV*  | 0061-29         | 0036-05 | 0064-11       | 0037-15 | 0166-27 | 0001-68 | IP        |         | 2                | C001-00             |
| RRT10K1E-PFZ*  | 0061-27         | 0036-03 | 0064-10       | 0037-14 | 0166-45 | 0001-88 | IP        |         | 2                | C001-00             |
| RRT62C1E-IAA   | 0053-18         | 0053-00 |               |         | 0163-05 | C411-89 | 0561-61   | N/A     | 2                | C001-00             |
| RRT62C1E-IAV   | 0053-29         | 0053-13 |               |         | 0163-11 | C411-63 | 0561-62   | 0561-62 | 2                | C001-00             |
| RRT64C1E-CAA   | 0058-43         |         | 0064-13       | 0037-17 | 0166-03 | 0140-04 | 0561-60   | 0561-60 | 2                | C001-00             |
| RRT64C1E-CAV   | 0061-13         | 0008-65 |               |         |         |         |           |         | 2                | C001-00             |
| RRT64C1E-IAA   | 0058-43         | N/A     |               |         | 0172-04 | N/A     | 0561-59   | N/A     | 2                | C001-00             |
| RRT64C1E-IAV   | 0053-29         | 0053-13 |               |         | 0163-15 | 0150-31 | 0561-74   | 0561-74 | 2                | C001-00             |
| RRT73C1E-CAA   | 0061-32         | 0036-09 | 0064-13       | 0037-17 | 0166-21 | 0001-62 | 0645-04   | N/A     | 2                | C001-00             |
| RRT73C1E-CAV   | 0061-20         | 0008-74 | 0064-09       | 0037-13 | 0166-13 | 0001-53 | 0561-28   | 0554-42 | 2                | C001-00             |
| RRT73C1E-IAA   | 0061-32         | 0036-09 |               |         | 0172-03 | C016-03 | 0644-03   | N/A     | 2                | C001-00             |
| RRT73C1E-IAV   | 0053-30         | 0053-14 |               |         | 0163-01 | 0150-34 | 0561-68   | 0561-68 | 2                | C001-00             |
| RRT81C1E-PFA   | 0006-18         | 0036-16 | 0064-08       | 0037-12 | 0166-38 | 0001-80 | IP        |         | 2                | C001-00             |
| RRT81C1E-PFV   | 0061-27         | 0036-03 | 0064-10       | 0037-14 | 0166-45 | 0001-88 | IP        |         | 2                | C001-00             |
| RRT81C1E-PFZ   | 0061-27         | 0036-03 | 0064-11       | 0037-15 | 0166-36 | 0001-78 | IP        |         | 2                | C001-00             |



# R – Hermetic Compressors

## RS - Compressor Parts

| Model           | Start Capacitor |         | Run Capacitor |         | Current Relay |         | Potential Relay |         | Protector |         | Crankcase Heater | MTG Parts<br>(527-) |
|-----------------|-----------------|---------|---------------|---------|---------------|---------|-----------------|---------|-----------|---------|------------------|---------------------|
|                 | OEM             | Service | OEM           | Service | OEM           | Service | OEM             | Service | OEM       | Service |                  |                     |
|                 | (014-)          | (914-)  | (014-)        | (914-)  | (040-)        | (940-)  | (040-)          | (940-)  | (071-)    | (971-)  |                  |                     |
| RS40C1(E)-IAA*  | 0061-17         | 0008-71 |               |         | 0168-10       | 0088-00 | 0166-21         | 0001-62 | 0127-21   | 0127-41 | 1                | 0039-04             |
| RS40C1(E)-IAV*  | 0061-12         | 0008-64 |               |         | 0168-02       | 0088-03 |                 |         | 0329-11   | 0329-11 | 1                | 0039-04             |
| RS40C2(E)-IAA*  | 0061-17         | 0008-71 |               |         | 0168-10       | 0088-00 | 0166-21         | 0001-62 | 0127-41   | 0127-41 | 1                | 0039-04             |
| RS40C2(E)-IAV*  | 0061-12         | 0008-64 |               |         | 0168-02       | 0088-03 |                 |         | 0329-11   | 0329-11 | 1                | 0039-04             |
| RS40C2-IAA*     | 0061-17         | 0008-71 |               |         |               |         | 0166-21         | 0001-62 | 0127-41   | 0127-41 | 1                | 0039-04             |
| RS40C2-IAV*     | 0061-12         | 0008-64 |               |         | 0168-02       | 0088-03 |                 |         | 0329-11   | 0329-11 | 1                | 0039-04             |
| RS43C1(E)-CAA*  | 0061-06         | 0008-57 | 0064-02       | 0037-06 |               |         | 0166-21         | 0001-62 | 0329-15   | 0329-15 | 1                | 0039-04             |
| RS43C1(E)-CAV*  | 0061-12         | 0008-64 | 0064-00       | 0037-04 |               |         | 0166-14         | 0001-54 | 0329-10   | 0329-10 | 1                | 0039-04             |
| RS43C1(E)-IAA*  | 0061-06         | 0008-57 |               |         |               |         | 0166-21         | 0001-62 | 0329-15   | 0329-15 | 1                | 0039-04             |
| RS43C2(E)-CAA*  | 0061-06         | 0008-57 | 0064-02       | 0037-06 |               |         | 0166-21         | 0001-62 | 0329-15   | 0329-15 | 1                | 0039-04             |
| RS43C2(E)-CAV*  | 0061-12         | 0008-64 | 0064-00       | 0037-04 |               |         | 0166-14         | 0001-54 | 0329-10   | 0329-10 | 1                | 0039-04             |
| RS43C2(E)-IAA*  | 0061-06         | 0008-57 |               |         |               |         | 0166-21         | 0001-62 | 0329-15   | 0329-15 | 1                | 0039-04             |
| RS43C2(E)-IAV*  | 0061-12         | 0008-64 |               |         | 0168-02       | 0088-03 |                 |         | 0329-11   | 0329-11 | 1                | 0039-04             |
| RS43CC1(E)-IAV* | 0061-12         | 0008-64 |               |         | 0168-02       | 0088-03 |                 |         | 0329-11   | 0329-11 | 1                | 0039-04             |
| RS47C2-IAA*     | 0061-22         | 0008-79 |               |         | 0168-13       | 0088-04 |                 |         | 0127-30   | 0127-30 | 1                | 0039-04             |
| RS47C2-IAV*     | 0061-14         | 0008-66 |               |         | 0168-01       | 0088-02 | 0166-14         | 0001-54 | 0370-29   | 0127-29 | 1                | 0039-04             |
| RS54C1(E)-IAA*  | 0061-22         | 0008-79 |               |         | 0168-03       | 0088-04 | 0166-21         | 0001-62 | 0166-06   | 0127-06 | 1                | 0039-04             |
| RS54C1(E)-IAV*  | 0061-13         | 0008-72 |               |         | 0168-01       | 0088-02 | 0166-19         | 0001-60 | 0329-04   | 0127-04 | 1                | 0039-04             |
| RS54C2(E)-IAA*  | 0061-22         | 0008-79 |               |         | 0168-03       | 0088-04 | 0166-21         | 0001-62 | 0127-06   | 0127-06 | 1                | 0039-04             |
| RS54C2(E)-IAV*  | 0061-13         | 0008-72 |               |         | 0168-01       | 0088-02 | 0166-19         | 0001-60 | 0329-04   | 0127-04 | 1                | 0039-04             |
| RS55C1(E)-PAA*  | 0058-06         | 0008-48 | 0064-05       | 0037-09 |               |         | 0166-19         | 0001-60 | 0127-40   | 0127-40 | 1                | 0039-04             |
| RS55C1(E)-PAV*  | 0061-18         | 0008-72 | 0064-02       | 0037-06 |               |         | 0166-14         | 0001-54 | 0329-30   | 0127-30 | 1                | 0039-04             |
| RS55C2(E)-CAA*  | 0006-13         | 0008-72 | 0064-05       | 0037-09 |               |         | 0166-19         | 0001-60 | 0518-02   | 0127-02 | 1                | 0039-04             |
| RS55C2(E)-CAV*  | 0006-17         | 0008-71 | 0064-05       | 0037-09 |               |         | 0166-14         | 0001-54 | 0527-08   | 0127-08 | 1                | 0039-04             |
| RS64C1(E)-CAA*  | 0061-20         | 0008-74 | 0064-12       | 0037-16 |               |         | 0166-02         | 0140-03 | 0127-43   | 0127-43 | 1                | 0039-04             |
| RS64C1(E)-CAV*  | 0061-09         | 0008-61 | 0064-02       | 0037-06 |               |         | 0166-14         | 0001-54 | 0329-16   | 0127-16 | 1                | 0039-04             |
| RS64C1(E)-IAA*  | 0061-14         | 0008-66 | 0064-12       | 0037-16 |               |         | 0166-19         | 0001-60 | 0127-44   | 0127-44 | 1                | 0039-04             |
| RS64C1(E)-IAV*  | 0061-14         | 0008-66 |               |         | 0168-00       | 0088-00 | 0166-22         | N/A     | 0127-37   | 0127-37 | 1                | 0039-04             |
| RS64C1(E)-PAA*  | 0061-20         | 0008-74 | 0064-12       | 0037-16 |               |         | 0166-02         | 0140-03 | 0127-43   | 0127-43 | 1                | 0039-04             |
| RS64C2(E)-CAA*  | 0061-20         | 0008-74 | 0064-12       | 0037-16 |               |         | 0166-02         | 0140-03 | 0127-43   | 0127-43 | 1                | 0039-04             |
| RS64C2(E)-CAV*  | 0061-09         | 0008-61 | 0064-02       | 0037-06 |               |         | 0166-14         | 0001-54 | 0527-01   | 0127-01 | 1                | 0039-04             |
| RS64C2(E)-IAA*  | 0061-14         | 0008-66 | 0064-12       | 0037-16 |               |         | 0166-19         | 0001-60 | 0127-44   | 0127-44 | 1                | 0039-04             |
| RS64C2(E)-IAV*  | 0061-14         | 0008-66 | 0064-12       | 0037-16 | 0168-00       | 0088-00 | 0166-02         | 0140-03 | 0127-37   | 0127-37 | 1                | 0039-04             |
| RS64C2(E)-PAA*  | 0061-20         | 0008-74 | 0064-12       | 0037-16 |               |         | 0166-02         | 0140-03 | 0127-43   | 0127-43 | 1                | 0039-04             |
| RS64C2-CAV*     | 0061-09         | 0008-61 | 0064-02       | 0037-06 |               |         | 0166-14         | 0001-54 | 0329-16   | 0329-16 | 1                | 0039-04             |
| RS70C1(E)-PFV*  | 0061-14         | 0008-66 | 0064-05       | 0037-09 |               |         | 0166-19         | 0001-60 | IP        |         | 1                | 0039-04             |
| RS70C1(E)-TFC*  |                 |         |               |         |               |         |                 |         | IP        |         | 1                | 0039-04             |
| RS70C1-PAA*     | 0061-13         | 0008-72 | 0064-06       | 0037-10 |               |         | 0166-19         | 0001-60 | 0127-18   | 0127-18 | 1                | 0039-04             |
| RS70C1-PFJ*     | 0061-13         | 0008-72 | 0064-05       | 0037-09 |               |         | 0166-19         | 0001-60 | IP        |         | 1                | 0039-04             |
| RS70C1-PFV*     | 0061-14         | 0008-66 | 0064-05       | 0037-09 |               |         | 0166-19         | 0001-60 | IP        |         | 1                | 0039-04             |

## RS - Compressor Parts

| Model          | Start Capacitor |         | Run Capacitor |         | Current Relay |         | Potential Relay |         | Protector |         | Crankcase Heater | MTG Parts<br>(527-) |
|----------------|-----------------|---------|---------------|---------|---------------|---------|-----------------|---------|-----------|---------|------------------|---------------------|
|                | OEM             | Service | OEM           | Service | OEM           | Service | OEM             | Service | OEM       | Service |                  |                     |
|                | (014-)          | (914-)  | (014-)        | (914-)  | (040-)        | (940-)  | (040-)          | (940-)  | (071-)    | (971-)  |                  |                     |
| RS70C1-TFC*    |                 |         |               |         |               |         |                 |         | IP        |         | 1                | 0039-04             |
| RS70C1-TFD*    |                 |         |               |         |               |         |                 |         | IP        |         | 1                | 0039-04             |
| RS80C1(E)-CAV* | 0006-13         | 0008-72 | 0064-10       | 0037-14 |               |         | 0166-14         | 0001-54 | 0127-37   | 0127-37 | 1                | 0039-04             |
| RS80C1(E)-TF5* |                 |         |               |         |               |         |                 |         | IP        |         | 1                | 0039-04             |
| RS80C2(E)-CAA* | 0061-27         | 0036-03 | 0064-05       | 0037-09 |               |         | 0166-19         | 0001-60 | 0127-37   | 0127-37 | 1                | 0039-04             |
| RS80C2(E)-CAV* | 0006-13         | 0008-72 | 0064-10       | 0037-14 |               |         | 0166-14         | 0001-54 | 0127-37   | 0127-37 | 1                | 0039-04             |
| RS80C2(E)-TF5* |                 |         |               |         |               |         |                 |         | IP        |         | 1                | 0039-04             |
| RS86C2(E)-PFV* | 0061-20         | 0008-74 | 0064-06       | 0037-10 |               |         | 0166-19         | 0001-60 | IP        |         | 1                | 0039-04             |
| RS97C1(E)-CAA* | 0061-04         | 0008-51 | 0064-07       | 0037-11 |               |         | 0166-18         | 0001-59 | 0127-45   | 0127-45 | 1                | 0039-04             |
| RS97C1(E)-CAV* | 0061-25         | 0008-74 | 0064-11       | 0037-15 |               |         | 0166-14         | 0001-54 | 0127-24   | 0127-24 | 1                | 0039-04             |
| RS97C1(E)-TFC* |                 |         |               |         |               |         |                 |         | IP        |         | 1                | 0039-04             |
| RS97C2(E)-CAA* | 0061-04         | 0008-51 | 0064-07       | 0037-11 |               |         | 0166-18         | 0001-59 | 0127-45   | 0127-45 | 1                | 0039-04             |
| RS97C2(E)-CAV* | 0061-25         | 0008-74 | 0064-11       | 0037-15 |               |         | 0166-14         | 0001-54 | 0127-24   | 0127-24 | 1                | 0039-04             |
| RS97C2(E)-TFC* |                 |         |               |         |               |         |                 |         | IP        |         | 1                | 0039-04             |
| RSE4-0075-IAA* | 0061-22         | 0008-79 |               |         | 0168-03       | 0088-04 | 0166-38         | 0001-80 | 0127-30   | 0127-30 | 1                | 0039-04             |
| RSE4-0075-IAV* | 0061-14         | 0008-66 |               |         | 0168-01       | 0088-02 | 0166-14         | 0001-54 | 0370-29   | 0127-29 | 1                | 0039-04             |
| RSE4-0075-IAZ* | 0061-18         | 0008-72 |               |         | 0168-02       | 0088-03 |                 |         | 0370-33   | 0127-33 | 1                | 0039-04             |
| RSE4-0076-IAA* | 0061-22         | 0008-79 |               |         | 0168-03       | 0088-04 | 0166-38         | 0001-80 | 0127-30   | 0127-30 | 1                | 0039-04             |
| RSE4-0076-IAV* | 0061-14         | 0008-66 |               |         | 0168-01       | 0088-02 | 0166-14         | 0001-54 | 0370-29   | 0127-29 | 1                | 0039-04             |
| RSE4-0076-IAZ* | 0061-18         | 0008-72 |               |         | 0168-02       | 0088-03 |                 |         | 0370-33   | 0127-33 | 1                | 0039-04             |
| RSF2-0050-IAA* | 0061-17         | 0008-71 |               |         |               |         | 0166-21         | 0001-62 | 0127-34   | 0127-34 | 1                | 0039-04             |
| RSF2-0050-IAV* | 0058-21         | 0008-70 |               |         | 0168-02       | 0088-03 | N/A             | N/A     | 0329-10   | 0329-10 | 1                | 0039-04             |
| RSL2-0075-IAA* | 0061-22         | 0008-79 |               |         | 0168-03       | 0088-04 | 0166-21         | 0001-62 | 0127-06   | 0329-06 | 1                | 0039-04             |
| RSL2-0075-IAV* | 0061-18         | 0008-72 |               |         | 0168-01       | 0088-02 | 0166-19         | 0001-60 | 0329-04   | 0329-04 | 1                | 0039-04             |
| RSL2-0100-CAA* | 0061-21         | 0008-70 | 0064-06       | 0037-10 |               |         | 0166-14         | 0001-54 | 0127-30   | 0127-30 | 1                | 0039-04             |
| RSL2-0100-CAV* | 0061-25         | 0008-74 | 0064-11       | 0037-15 |               |         | 0166-14         | 0001-54 | 0127-24   | 0127-24 | 1                | 0039-04             |
| RSL2-0101-CAA* | 0061-21         | 0008-70 | 0064-06       | 0037-10 |               |         | 0166-14         | 0001-54 | 0127-30   | 0127-30 | 1                | 0039-04             |
| RSL2-0101-CAV* | 0061-25         | 0008-74 | 0064-11       | 0037-15 |               |         | 0166-14         | 0001-54 | 0127-24   | 0127-24 | 1                | 0039-04             |
| RSL5-0101-TFC* |                 |         |               |         |               |         |                 |         | IP        |         | 1                | 0039-04             |
| RSN4-0050-IAA* | 0061-17         | 0008-71 |               |         |               |         | 0166-21         | 0001-62 | 0127-34   | 0127-34 | 1                | 0039-04             |
| RSN4-0050-IAV* | 0061-12         | 0008-64 |               |         | 0168-02       | 0088-03 |                 |         | 0329-11   | 0329-11 | 1                | 0039-04             |
| RSN4-0075-IAA* | 0061-22         | 0008-79 |               |         | 0168-03       | 0088-04 | 0166-38         |         | 0127-30   | 0127-30 | 1                | 0039-04             |
| RSN4-0075-IAV* | 0061-09         | 0008-61 |               |         | 0168-04       | 0088-05 | 0166-13         |         | 0127-05   | 0127-05 | 1                | 0039-04             |
| RSN4-0075-PAA* | 0061-01         | 0008-48 | 0064-05       | 0037-09 |               |         | 0166-19         | 0001-60 | 0127-19   | 0127-19 | 1                | 0039-04             |
| RSN4-0100-CAV* | 0061-09         | 0008-61 | 0064-02       | 0037-06 |               |         | 0166-14         | 0001-54 | 0329-16   | 0329-16 | 1                | 0039-04             |
| RSN5-0075-IAA* | 0061-22         | 0008-79 |               |         |               |         | 0166-38         |         | 0127-30   | 0127-30 | 1                | 0039-04             |
| RSN5-0075-IAV* | 0061-09         | 0008-61 |               |         |               |         | 0166-13         |         | 0127-05   | 0329-05 | 1                | 0039-04             |
| RSN6-0075-IAA* | 0061-22         | 0008-79 |               |         | 0168-03       | 0088-04 | 0166-38         |         | 0127-30   | 0127-30 | 1                | 0039-04             |
| RSN6-0075-IAV* | 0061-09         | 0008-61 |               |         | 0168-04       | 0088-05 | 0166-13         |         | 0127-05   | 0329-05 | 1                | 0039-04             |
| RST10K1E-PFV*  | 0061-29         | 0036-05 | 0064-12       | 0037-16 |               |         | 0166-14         | 0001-54 | IP        |         | 2                | C001-00             |

# R – Hermetic Compressors

## RS - Compressor Parts

| Model           | Start Capacitor |         | Run Capacitor |         | Current Relay |         | Potential Relay |         | Protector |         | Crankcase Heater | MTG Parts<br>(527-) |
|-----------------|-----------------|---------|---------------|---------|---------------|---------|-----------------|---------|-----------|---------|------------------|---------------------|
|                 | OEM             | Service | OEM           | Service | OEM           | Service | OEM             | Service | OEM       | Service |                  |                     |
|                 | (014-)          | (914-)  | (014-)        | (914-)  | (040-)        | (940-)  | (040-)          | (940-)  | (071-)    | (971-)  |                  |                     |
| RST10K1E-TA5*   |                 |         |               |         |               |         |                 |         |           |         | 2                | C001-00             |
| RST40C1(E)-IAA* | 0059-20         | N/A     |               |         | 0150-37       | N/A     |                 |         | 0561-56   | 0561-56 | 2                | C001-00             |
| RST40C1(E)-IAV* | 0053-30         | 0053-14 |               |         | 0163-15       | 0150-31 |                 |         | 0561-65   | 0561-65 | 2                | C001-00             |
| RST40C1E-CAA*   | 0061-32         | 0036-09 | 0064-13       | 0037-17 |               |         | 0166-03         | 0140-04 | 0561-48   | 0561-48 | 2                | C001-00             |
| RST40C1E-CAV*   | 0061-27         | 0036-03 | 0064-33       | 0037-50 |               |         | 0166-18         | 0001-59 | 0561-23   | 0554-19 | 2                | C001-00             |
| RST45C1(E)-CAA* | 0061-32         | 0036-09 | 0064-13       | 0037-17 |               |         | 0166-21         | 0001-62 | 0604-10   | 0604-10 | 2                | C001-00             |
| RST45C1(E)-CAV* | 0061-20         | 0008-74 | 0064-09       | 0037-13 |               |         | 0166-27         | 0001-68 | 0561-28   | 0554-42 | 2                | C001-00             |
| RST45C1(E)-IAA* | 0061-32         | 0036-09 |               |         | 0172-03       | C016-03 |                 |         | 0605-09   | 0605-09 | 2                | C001-00             |
| RST45C1(E)-IAV* | 0053-27         | 0053-11 |               |         | 0150-36       | 0150-36 |                 |         | 0561-16   | 0554-22 | 2                | C001-00             |
| RST55C1(E)-CAA* | 0061-32         | 0036-09 | 0064-13       | 0037-17 |               |         | 0166-21         | 0001-62 | 0605-05   | C100-71 | 2                | C001-00             |
| RST55C1(E)-CAV* | 0061-27         | 0036-03 | 0064-09       | 0037-13 |               |         | 0166-27         | 0001-68 | 0561-02   | 0554-15 | 2                | C001-00             |
| RST55C1(E)-IAA* | 0061-23         | 0058-41 |               |         | 0172-03       | C016-03 |                 |         | 0605-08   | 0605-08 | 2                | C001-00             |
| RST55C1(E)-IAV* | 0053-30         | 0053-14 |               |         | 0150-45       | N/A     |                 |         | 0561-72   | 0561-72 | 2                | C001-00             |
| RST61C1E-CAV*   | 0061-20         | 0008-74 | 0064-33       | 0037-50 |               |         | 0166-13         | 0001-53 | 0561-75   | N/A     | 2                | C001-00             |
| RST61C1E-CFA*   | 0061-34         | 0058-43 | 0064-14       | 0037-18 |               |         | 0166-37         | 0001-79 | IP        |         | 2                | C001-00             |
| RST64C1E-CAV*   | 0061-20         | 0008-74 | 0064-10       | 0037-14 |               |         | 0166-30         | 0001-71 | 0604-13   | 0604-13 | 2                | C001-00             |
| RST64C1E-CFA*   | 0058-43         | N/A     | 0064-14       | 0037-18 |               |         | 0166-37         | 0001-79 | IP        |         | 2                | C001-00             |
| RST64C1E-IAV*   | 0061-27         | 0036-03 |               |         | 0168-04       | 0172-05 |                 |         | 0604-14   | 0604-14 | 2                | C001-00             |
| RST64C1E-IAZ*   | 0061-26         | 0036-02 |               |         | 0168-04       | 0172-05 |                 |         | 0604-12   |         | 2                | C001-00             |
| RST70C1(E)-PFV* | 0061-29         | 0036-05 | 0064-11       | 0037-15 |               |         | 0166-27         | 0001-68 | IP        |         | 2                | C001-00             |
| RST70C1(E)-TA*  |                 |         |               |         |               |         |                 |         | 0604-19   | 0604-19 | 2                | C001-00             |
| RST80C1(E)-PFV* | 0061-29         | 0036-05 | 0064-12       | 0037-16 |               |         | 0166-27         | 0001-68 | IP        |         | 2                | C001-00             |
| RST80C1E-PFA*   | 0006-18         | 0036-16 | 0064-38       | 0037-54 |               |         | 0046-26         | 0046-26 | IP        |         | 2                | C001-00             |
| RST80C1E-PFZ*   | 0061-27         | 0036-03 | 0064-12       | 0037-16 |               |         | 0166-36         | 0001-78 | IP        |         | 2                | C001-00             |
| RST80C1E-TA5    |                 |         |               |         |               |         |                 |         | 0604-19   | 0604-19 | 2                | C001-00             |
| RST97C1(E)-PFV* | 0061-29         | 0036-05 | 0064-12       | 0037-16 |               |         | 0166-27         | 0001-68 | IP        |         | 2                | C001-00             |
| RST97C1E-PFZ*   | 0061-27         | 0036-03 | 0064-12       | 0037-16 |               |         | 0166-36         | 0001-78 | IP        |         | 2                | C001-00             |
| RST97C1E-TA5    |                 |         |               |         |               |         |                 |         | 0604-19   | 0604-19 | 2                | C001-00             |
| RSU4-0050-IAA*  | 0061-15         | 0008-69 |               |         | 0168-03       | 0088-04 | 0166-11         | N/A     | 0329-15   | 0329-15 | 1                | 0039-04             |
| RSU5-0050-IAA*  | 0061-05         | 0008-69 |               |         | 0168-03       | 0088-04 | 0166-11         | N/A     | 0329-15   | 0329-15 | 1                | 0039-04             |
| RSU5-0050-IAV*  | 0061-12         | 0008-64 |               |         | 0168-02       | 0088-03 |                 |         | 0329-11   | 0329-11 | 1                | 0039-04             |



**RST**

# Semi-Hermetic Compressors – E

| Code Description |  |
|------------------|--|
| Code             | Description                                |
| A                | (Air-cooled) - Std. air cooled             |
| R                | (Refrigerant-cooled) - Std. refrig. cooled |
| W                | (Water-cooled) - Std. water cooled         |

| Compressor Motor Types |  |      |
|------------------------|--|------|
| Phase                  | Description  | Code |
| 1                      | Capacitor run - Capacitor start                      | C    |
| 1                      | Induction run - Capacitor start                      | I    |
| 3                      | Three phase  | T    |
| 3                      | Wye (star) delta                                     | E    |
| 3                      | 6 lead part winding or across the line - except 575V | F    |

**Product Variations**  
 Number will be assigned as follows:  
 1. Number - 100 is standard compressor used in Copeland brand Condensing units.  
 2. Number - 200 indicates a STANDARD Compressor Parts B/M and Model No.  
 3. Number - 201 and larger will be assigned for all other variations of a given model.  
 4. Number - 800 indicates a standard replacement Compressor and Component Parts B/M and Model No. - 240 volt control.  
 5. Number - 801 Indicates a standard replacement Compressor and Component Parts B/M and Model No. - 120 volt control.

**Model Variation**  
 A number or letter, assigned to indicate different model types within any one family series.

# E A V B - 0210 - C A V - 201

**Compressor Family Series**  
 Either a number or a letter established for each product model.

**Displacement**  
 A letter only, arbitrarily assigned for each different displacement within any one family series.

| Compressor Motor Rating |      |              |      |              |      |
|-------------------------|------|--------------|------|--------------|------|
| Nominal (HP)            | Code | Nominal (HP) | Code | Nominal (HP) | Code |
| 1/8                     | 0033 | 2            | 0200 | 5            | 0500 |
| 1/4                     | 0050 | 2            | 0210 | 20           | 2000 |
| 1/2                     | 0051 | 3            | 0300 | 25           | 2500 |
| 3/4                     | 0075 | 3            | 0310 | 30           | 3000 |
| 1                       | 0100 | 3            | 0311 | 35           | 3500 |
| 1 1/2                   | 0150 | 4            | 0400 | 40           | 4000 |

| Electrical Code |                   |      |
|-----------------|-------------------|------|
| 60 Hz           | 50 Hz             | Code |
| 115-1           | -                 | A    |
| 230-1           | -                 | B    |
| 208/230-3       | 200/220-3         | C    |
| 460-3           | 380/420-3         | D    |
| 575-3           | 550-3             | E    |
| 208/230/460-3   | 200/380/400-3     | K    |
| -               | 210/240/380/420-3 | L    |
| -               | 380/420-3         | M    |
| 230/460-3       | 200/400-3         | N    |
| 200-3           | -                 | U    |
| 208/230-1       | 200/220-1         | V    |
| -               | 220/240-1         | Z    |
| 200/220/380-3   | 200/380-3         | 8    |

| Compressor Motor Protection   |      |
|---|------|
| Description   | Code |
| External Inherent Protection - One Protector (Line Break) Use with Contactor                    | A    |
| Internal Inherent Protection - One Protector (Line Break) Use with Contactor                    | F    |
| Internal Thermal Protection - Electronic Sensors and Control Module External Use with Contactor | S    |

## Common Replacement Parts

| Common Parts                | Part Number |
|-----------------------------|-------------|
| Terminal Insulator Assembly | 521-0067-01 |
| Terminal Fusite for 3 Phase | 521-0017-00 |
| Terminal Fusite Seal        | 020-0844-02 |
| Discharge Valve Kit         | 998-0510-22 |
| Discharge Valve Gasket      | 020-0012-10 |
| Suction Valve Kit           | 998-0510-12 |
| Suction Valve Gasket        | 020-0012-11 |
| Sight Glass Kit             | 998-0002-04 |
| Suction Strainer Screen     | 013-0010-00 |
| Spacer Mounting Assembly    | 527-0006-00 |
| Gaskets                     | Part Number |
| Cylinder Head               | 020-0122-00 |
| Housing Cover               | 020-1221-00 |
| Bottom Plate                | 020-0124-00 |
| Stator Cover                | 020-0054-00 |
| Crankcase Heater            | Part Number |
| Bolt On 120 Volt 65 Watt    | 918-0009-00 |
| Bolt On 240 Volt 65 Watt    | 918-0009-01 |

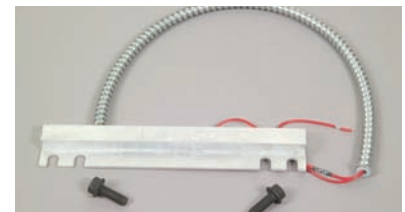

# E – Semi-Hermetic Compressors

## EA - Compressor Parts (air cooled)

| Model         | Valve Plate Kit | Complete Gasket Kit | Valve Plate Gasket | Start Capacitor |         | Run Capacitor |         | Relay   |         | Protector | Terminal Board Assembly |
|---------------|-----------------|---------------------|--------------------|-----------------|---------|---------------|---------|---------|---------|-----------|-------------------------|
|               | (998-)          | (998-)              | (020-)             | OEM             | Service | OEM           | Service | OEM     | Service |           |                         |
|               | (998-)          | (998-)              | (020-)             | (014-)          | (914-)  | (014-)        | (914-)  | (040-)  | (940-)  |           |                         |
| EAA1-0150-TAC | 0661-14         | 0669-31             | 0123-03            |                 |         |               |         |         |         | 0090-03   | 0052-02                 |
| EAA1-0150-TAD | 0661-14         | 0669-31             | 0123-03            |                 |         |               |         |         |         | 0090-12   | 0052-00                 |
| EAA2-0150-CAB | 0661-14         | 0669-31             | 0123-03            | 0061-29         | 0036-05 | 0064-10       | 0037-14 | 0166-20 | 0001-61 | 0092-18   | 0051-00                 |
| EAA2-0150-CAH | 0661-14         | 0669-31             | 0123-03            | 0061-29         | 0036-05 | 0064-10       | 0037-14 | 0166-30 | 0001-71 | 0092-18   | 0051-00                 |
| EAB1-0150-TAC | 0661-06         | 0669-30             | 0123-02            |                 |         |               |         |         |         | 0090-03   | 0052-02                 |
| EAB1-0150-TAD | 0661-06         | 0669-30             | 0123-02            |                 |         |               |         |         |         | 0090-12   | 0052-00                 |
| EAB1-0200-TAC | 0661-06         | 0669-30             | 0123-02            |                 |         |               |         |         |         | 0090-00   | 0052-02                 |
| EAB1-0200-TAD | 0661-06         | 0669-30             | 0123-02            |                 |         |               |         |         |         | 0090-08   | 0052-02                 |
| EAB2-0150-CAB | 0661-06         | 0669-30             | 0123-02            | 0061-29         | 0036-05 | 0064-10       | 0037-14 | 0166-20 | 0001-61 | 0092-16   | 0051-00                 |
| EAB2-0150-CAH | 0661-06         | 0669-30             | 0123-02            | 0061-29         | 0036-05 | 0064-10       | 0037-14 | 0166-30 | 0001-71 | 0092-16   | 0051-00                 |
| EAB2-0200-CAB | 0661-06         | 0669-30             | 0123-02            | 0061-30         | 0006-01 | 0064-11       | 0037-15 | 0166-20 | 0001-61 | 0092-18   | 0052-02                 |
| EABA-0200-TAC | 0661-06         | 0669-30             | 0123-02            |                 |         |               |         |         |         | 0090-00   | 0052-02                 |
| EABA-0200-TAD | 0661-06         | 0669-30             | 0123-02            |                 |         |               |         |         |         | 0090-08   | 0052-02                 |
| EABB-0200-CAB | 0661-06         | 0669-30             | 0123-02            | 0061-30         | 0006-01 | 0064-11       | 0037-15 | 0166-20 | 0001-61 | 0092-18   | 0051-00                 |
| EAC1-0150-TAC | 0661-06         | 0669-31             | 0123-03            |                 |         |               |         |         |         | 0090-03   | 0052-02                 |
| EAC1-0150-TAD | 0661-06         | 0669-31             | 0123-03            |                 |         |               |         |         |         | 0090-12   | 0052-00                 |
| EAC1-0200-TAC | 0661-06         | 0669-31             | 0123-03            |                 |         |               |         |         |         | 0090-00   | 0052-02                 |
| EAC1-0200-TAD | 0661-06         | 0669-31             | 0123-03            |                 |         |               |         |         |         | 0090-08   | 0052-02                 |
| EAC2-0150-CAB | 0661-06         | 0669-31             | 0123-03            | 0061-29         | 0036-05 | 0064-10       | 0037-14 | 0166-20 | 0001-61 | 0092-16   | 0051-00                 |
| EAC2-0150-CAH | 0661-06         | 0669-31             | 0123-03            | 0061-29         | 0036-05 | 0064-10       | 0037-14 | 0166-30 | 0001-71 | 0092-16   | 0051-00                 |
| EAC2-0200-CAB | 0661-06         | 0669-31             | 0123-03            | 0061-30         | 0006-01 | 0064-11       | 0037-15 | 0166-20 | 0001-61 | 0092-18   | 0051-00                 |
| EAC2-0200-CAH | 0661-06         | 0669-31             | 0123-03            | 0061-30         | 0006-01 | 0064-11       | 0037-15 | 0166-20 | 0001-61 | 0092-18   | 0051-00                 |
| EAC1-0200-TAC | 0661-06         | 0669-31             | 0123-03            |                 |         |               |         |         |         | 0090-00   | 0052-02                 |
| EACA-0200-TAD | 0661-06         | 0669-31             | 0123-03            |                 |         |               |         |         |         | 0090-08   | 0052-02                 |
| EACB-0200-CAB | 0661-06         | 0669-31             | 0123-03            | 0061-30         | 0006-01 | 0064-11       | 0037-15 | 0166-20 | 0001-61 | 0092-18   | 0051-00                 |
| EACB-0200-CAH | 0661-06         | 0669-31             | 0123-03            | 0061-30         | 0006-01 | 0064-11       | 0037-15 | 0166-20 | 0001-61 | 0092-18   | 0051-00                 |
| EAD1-0200-TAC | 0661-14         | 0669-30             | 0123-02            |                 |         |               |         |         |         | 0090-00   | 0052-02                 |
| EAD1-0200-TAD | 0661-14         | 0669-30             | 0123-02            |                 |         |               |         |         |         | 0090-08   | 0052-02                 |
| EAD1-0320-TAC | 0661-14         | 0669-30             | 0123-02            |                 |         |               |         |         |         | 0090-38   | 0052-02                 |
| EAD1-0320-TAD | 0661-14         | 0669-30             | 0123-02            |                 |         |               |         |         |         | 0090-03   | 0052-02                 |
| EAD2-0200-CAB | 0661-14         | 0669-30             | 0123-02            | 0061-30         | 0006-01 | 0064-11       | 0037-15 | 0166-20 | 0001-61 | 0092-18   | 0051-00                 |
| EAD2-0200-CAH | 0661-14         | 0669-30             | 0123-02            | 0061-30         | 0006-01 | 0064-11       | 0037-15 | 0166-20 | 0001-61 | 0092-18   | 0051-00                 |
| EAD2-0320-CAB | 0661-14         | 0669-30             | 0123-02            | 0006-13         | 0006-03 | 0064-14       | 0037-18 | 0166-28 | 0001-69 | 0119-06   | 0050-00                 |
| EADA-0200-TAC | 0661-14         | 0669-30             | 0123-02            |                 |         |               |         |         |         | 0090-00   | 0052-02                 |
| EADA-0200-TAD | 0661-14         | 0669-30             | 0123-02            |                 |         |               |         |         |         | 0090-15   | 0052-00                 |
| EADA-020E-TAC | 0661-14         | 0669-30             | 0123-02            |                 |         |               |         |         |         | 0090-00   | 0052-02                 |
| EADB-0200-CAB | 0661-14         | 0669-30             | 0123-20            | 0061-30         | 0006-01 | 0064-11       | 0037-15 | 0166-20 | 0001-61 | 0092-18   | 0051-00                 |
| EADB-021E-CAB | 0661-14         | 0669-30             | 0123-02            | 0061-30         | 0006-01 | 0064-11       | 0037-15 | 0166-20 | 0001-61 | 0099-03   | 0051-00                 |
| EAJ2-0150-CAB | 0661-14         | 0669-28             | 0123-06            | 0061-29         | 0036-05 | 0064-10       | 0037-14 | 0166-20 | 0001-61 | 0092-16   | 0051-00                 |
| EAJ2-0150-CAH | 0661-14         | 0669-28             | 0123-06            | 0061-29         | 0036-05 | 0064-10       | 0037-14 | 0166-30 | 0001-71 | 0092-16   | 0051-00                 |

**Note:** EW water cooled compressors are the same as the EA model having body fin casting except for a factory installed water jacket.



## EA - Compressor Parts (air cooled)

| Model         | Valve Plate Kit | Complete Gasket Kit | Valve Plate Gasket | Start Capacitor |         | Run Capacitor |         | Relay   |         | Protector | Terminal Board Assembly |
|---------------|-----------------|---------------------|--------------------|-----------------|---------|---------------|---------|---------|---------|-----------|-------------------------|
|               | (998-)          | (998-)              | (020-)             | OEM             | Service | OEM           | Service | OEM     | Service |           |                         |
|               | (014-)          | (914-)              | (014-)             | (914-)          | (040-)  | (940-)        | (071-)  | (580-)  |         |           |                         |
| EAJA-0150-TAC | 0661-14         | 0669-28             | 0123-06            |                 |         |               |         |         |         | 0090-03   | 0052-02                 |
| EAJA-0150-TAD | 0661-14         | 0669-28             | 0123-06            |                 |         |               |         |         |         | 0090-12   | 0052-00                 |
| EAL1-0200-TAC | 0661-06         | 0669-28             | 0123-00            |                 |         |               |         |         |         | 0090-00   | 0052-02                 |
| EAL1-0200-TAD | 0661-06         | 0669-28             | 0123-00            |                 |         |               |         |         |         | 0090-08   | 0052-02                 |
| EAL2-0200-CAB | 0661-06         | 0669-28             | 0123-00            | 0061-30         | 0006-01 | 0064-11       | 0037-15 | 0166-20 | 0001-61 | 0092-18   | 0051-00                 |
| EAL2-0200-CAH | 0661-06         | 0669-28             | 0123-00            | 0061-30         | 0006-01 | 0064-11       | 0037-15 | 0166-20 | 0001-61 | 0098-18   | 0051-00                 |
| EAV1-0150-TAC | 0661-06         | 0669-28             | 0123-00            |                 |         |               |         |         |         | 0090-03   | 0052-02                 |
| EAV1-0150-TAD | 0661-06         | 0669-28             | 0123-00            |                 |         |               |         |         |         | 0090-12   | 0052-00                 |
| EAV1-0200-TAC | 0661-06         | 0669-28             | 0123-00            |                 |         |               |         |         |         | 0090-00   | 0052-02                 |
| EAV1-0200-TAD | 0661-06         | 0669-28             | 0123-00            |                 |         |               |         |         |         | 0090-08   | 0052-02                 |
| EAV2-0150-CAB | 0661-06         | 0669-28             | 0123-00            | 0061-29         | 0036-05 | 0064-10       | 0037-14 | 0166-20 | 0001-61 | 0092-16   | 0051-00                 |
| EAV2-0150-CAH | 0661-06         | 0669-28             | 0123-00            | 0061-29         | 0036-05 | 0064-10       | 0037-14 | 0166-30 | 0001-71 | 0092-16   | 0051-00                 |
| EAV2-0200-CAB | 0661-06         | 0669-28             | 0123-00            | 0061-30         | 0006-01 | 0064-11       | 0037-15 | 0166-20 | 0001-61 | 0099-01   | 0051-00                 |
| EAV2-0200-CAH | 0661-06         | 0669-28             | 0123-00            | 0061-30         | 0006-01 | 0064-11       | 0037-15 | 0166-20 | 0001-61 | 0099-02   | 0051-00                 |
| EAVA-0210-TAC | 0661-06         | 0669-28             | 0123-00            |                 |         |               |         |         |         | 0090-35   | 0052-02                 |
| EAVA-0210-TAD | 0661-06         | 0669-28             | 0123-00            |                 |         |               |         |         |         | 0090-13   | 0052-02                 |
| EAVA-021E-TAC | 0661-06         | 0669-28             | 0123-00            |                 |         |               |         |         |         | 0090-35   | 0052-02                 |
| EAVA-021E-TAD | 0661-06         | 0669-28             | 0123-00            |                 |         |               |         |         |         | 0090-13   | 0052-02                 |
| EAVB-0210-CAV | 0661-06         | 0669-28             | 0123-00            | 0006-13         | 0006-03 | 0064-14       | 0037-18 | 0166-28 | 0001-69 | 0119-05   | 0050-00                 |
| EAVB-021E-CAV | 0661-06         | 0669-28             | 0123-00            | 0006-13         | 0006-03 | 0064-14       | 0037-18 | 0166-28 | 0001-69 | 0119-05   | 0050-00                 |

**Note:** EW water cooled compressors are the same as the EA model having body fin casting except for a factory installed water jacket.

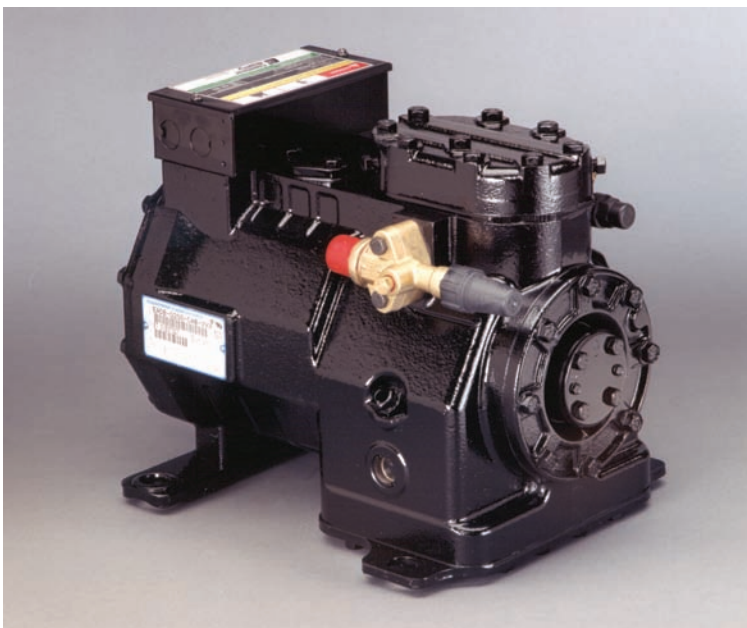

# E – Semi-Hermetic Compressors

## ER - Compressor Parts (air cooled)

| Model         | Valve Plate Kit | Complete Gasket Kit | Valve Plate Gasket | Start Capacitor |         | Run Capacitor |         | Relay   |         | Protector | Terminal Board Assembly |
|---------------|-----------------|---------------------|--------------------|-----------------|---------|---------------|---------|---------|---------|-----------|-------------------------|
|               | (998-)          | (998-)              | (020-)             | OEM             | Service | OEM           | Service | OEM     | Service |           |                         |
|               | (998-)          | (998-)              | (020-)             | (014-)          | (914-)  | (014-)        | (914-)  | (040-)  | (940-)  |           |                         |
| ERA1-0200-TAC | 0661-06         | 0669-31             | 0123-03            |                 |         |               |         |         |         | 0090-00   | 0052-02                 |
| ERA1-0200-TAD | 0661-06         | 0669-31             | 0123-03            |                 |         |               |         |         |         | 0090-08   | 0052-02                 |
| ERA2-0200-CAB | 0661-06         | 0669-31             | 0123-03            | 0061-30         | 0036-07 | 0064-11       | 0037-15 | 0166-20 | 0001-61 | 0103-02   | 0051-00                 |
| ERC1-0200-TAC | 0661-06         | 0669-31             | 0123-03            |                 |         |               |         |         |         | 0090-00   | 0052-02                 |
| ERC1-0200-TAD | 0661-06         | 0669-31             | 0123-03            |                 |         |               |         |         |         | 0090-08   | 0052-02                 |
| ERC2-0200-CAB | 0661-06         | 0669-31             | 0123-03            | 0061-30         | 0036-07 | 0064-11       | 0037-15 | 0166-20 | 0001-61 | 0099-01   | 0051-00                 |
| ERCA-020E-TAD | 0661-06         | 0669-31             | 0123-03            |                 |         |               |         |         |         | 0090-08   | 0052-02                 |
| ERCA-021E-TAC | 0661-06         | 0669-31             | 0123-03            |                 |         |               |         |         |         | 0090-49   | 0052-02                 |
| ERF1-0310-TAC | 0661-06         | 0669-30             | 0123-02            |                 |         |               |         |         |         | 0090-02   | 0052-01                 |
| ERF1-0310-TAD | 0661-06         | 0669-30             | 0123-02            |                 |         |               |         |         |         | 0090-10   | 0052-02                 |
| ERF1-0311-TAC | 0661-06         | 0669-30             | 0123-02            |                 |         |               |         |         |         | 0090-36   | 0052-01                 |
| ERF1-0311-TAD | 0661-06         | 0669-30             | 0123-02            |                 |         |               |         |         |         | 0090-10   | 0052-02                 |
| ERF2-0310-CAB | 0661-06         | 0669-30             | 0123-02            | 0061-30         | 0036-07 | 0064-14       | 0037-18 | 0166-28 | 0001-69 | 0119-00   | 0050-00                 |
| ERFA-0311-TAD | 0661-06         | 0669-30             | 0123-02            |                 |         |               |         |         |         | 0090-10   | 0052-02                 |
| ERFA-031E-TAC | 0661-06         | 0669-30             | 0123-02            |                 |         |               |         |         |         | 0090-36   | 0052-01                 |
| ERFA-031E-TAD | 0661-06         | 0669-30             | 0123-02            |                 |         |               |         |         |         | 0090-10   | 0052-02                 |
| ERFB-031E-CAB | 0661-06         | 0669-30             | 0123-02            | 0061-30         | 0036-07 | 0064-14       | 0037-18 | 0166-28 | 0001-69 | 0119-00   | 0050-00                 |
| ERJ1-0200-TAC | 0661-18         | 0669-28             | 0123-04            |                 |         |               |         |         |         | 0090-00   | 0052-02                 |
| ERJ1-0200-TAD | 0661-18         | 0669-27             | 0123-04            |                 |         |               |         |         |         | 0090-08   | 0052-02                 |
| ERJ2-0200-CAB | 0661-18         | 0669-27             | 0123-04            | 0061-30         | 0036-07 | 0064-11       | 0037-15 | 0166-20 | 0001-61 | 0103-02   | 0051-00                 |
| ERJ2-0200-CAH | 0661-18         | 0669-27             | 0123-04            | 0061-30         | 0036-07 | 0064-11       | 0037-15 | 0166-20 | 0001-61 | 0099-02   | 0051-00                 |

**Note:** EW water cooled compressors are the same as the EA model having body fin casting except for a factory installed water jacket.



# Semi-Hermetic Compressors – H

| Code Description |  |
|------------------|--|
| Code             | Description                                |
| A                | (Air-cooled) - Std. air cooled             |
| R                | (Refrigerant-cooled) - Std. refrig. cooled |
| W                | (Water-cooled) - Std. water cooled         |

| Compressor Motor Types |  |      |
|------------------------|--|------|
| Phase                  | Description  | Code |
| 1                      | Capacitor run - Capacitor start                      | C    |
| 1                      | Induction run - Capacitor start                      | I    |
| 3                      | Three phase  | T    |
| 3                      | Wye (star) delta                                     | E    |
| 3                      | 6 lead part winding or across the line - except 575V | F    |

**Product Variations**  
 Number will be assigned as follows:  
 1. Number - 100 is standard compressor used in Copeland brand Condensing units.  
 2. Number - 200 indicates a STANDARD Compressor Parts B/M and Model No.  
 3. Number - 201 and larger will be assigned for all other variations of a given model.  
 4. Number - 800 indicates a standard replacement Compressor and Component Parts B/M and Model No. - 240 volt control.  
 5. Number - 801 Indicates a standard replacement Compressor and Component Parts B/M and Model No. - 120 volt control.

**Model Variation**  
 A number or letter, assigned to indicate different model types within any one family series.

# H A T B - 0051 - C A V - 201

**Compressor Family Series**  
 Either a number or a letter established for each product model.

**Displacement**  
 A letter only, arbitrarily assigned for each different displacement within any one family series.

| Compressor Motor Rating |      |              |      |              |      |
|-------------------------|------|--------------|------|--------------|------|
| Nominal (HP)            | Code | Nominal (HP) | Code | Nominal (HP) | Code |
| 1/3                     | 0033 | 2            | 0200 | 5            | 0500 |
| 1/2                     | 0050 | 2            | 0210 | 20           | 2000 |
| 1/2                     | 0051 | 3            | 0300 | 25           | 2500 |
| 3/4                     | 0075 | 3            | 0310 | 30           | 3000 |
| 1                       | 0100 | 3            | 0311 | 35           | 3500 |
| 1 1/2                   | 0150 | 4            | 0400 | 40           | 4000 |

| Electrical Code |                   |      |
|-----------------|-------------------|------|
| 60 Hz           | 50 Hz             | Code |
| 115-1           | -                 | A    |
| 230-1           | -                 | B    |
| 208/230-3       | 200/220-3         | C    |
| 460-3           | 380/420-3         | D    |
| 575-3           | 550-3             | E    |
| 208/230/460-3   | 200/380/400-3     | K    |
| -               | 210/240/380/420-3 | L    |
| -               | 380/420-3         | M    |
| 230/460-3       | 200/400-3         | N    |
| 200-3           | -                 | U    |
| 208/230-1       | 200/220-1         | V    |
| -               | 220/240-1         | Z    |
| 200/220/380-3   | 200/380-3         | 8    |

| Compressor Motor Protection   |      |
|---|------|
| Description   | Code |
| External Inherent Protection - One Protector (Line Break) Use with Contactor                    | A    |
| Internal Inherent Protection - One Protector (Line Break) Use with Contactor                    | F    |
| Internal Thermal Protection - Electronic Sensors and Control Module External Use with Contactor | S    |

## Common Replacement Parts

| Common Parts             | Part Number |
|--------------------------|-------------|
| Suction Screen           | 013-0146-00 |
| Mounting Assembly        | 527-0005-01 |
| Terminal Board           | 580-0070-00 |
| Gaskets                  | Part Number |
| Cylinder Head            | 020-0071-00 |
| Stator Cover             | 020-0096-02 |
| Housing Cover            | 020-0107-02 |
| Bottom Plate             | 020-0003-09 |
| Crankcase Heater         | Part Number |
| Bolt On 120 Volt 50 Watt | 918-0118-05 |
| Bolt On 240 Volt 50 Watt | 918-0118-06 |



# H – Semi-Hermetic Compressors

## HA - Compressor Parts (refrigerant cooled)

| Model         | Valve Plate Kit | Complete Gasket Kit | Valve Plate Gasket | Start Capacitor |         | Run Capacitor |         | Relay   |         | Protector | Terminal Board Assembly |
|---------------|-----------------|---------------------|--------------------|-----------------|---------|---------------|---------|---------|---------|-----------|-------------------------|
|               |                 |                     |                    | OEM             | Service | OEM           | Service | OEM     | Service |           |                         |
|               | (998-)          | (998-)              | (020-)             | (014-)          | (914-)  | (014-)        | (914-)  | (040-)  | (940-)  |           |                         |
| HAF2-0025-IAA | 0661-12         | 0669-05             | 0095-03            | 0061-06         | 0008-57 |               |         | 0115-00 | 0115-00 | 0092-37   | 0003-00                 |
| HAF2-0025-IAB | 0661-12         | 0669-05             | 0095-03            | 0061-13         | 0008-65 |               |         | 0115-01 | 0115-01 | 0092-32   | 0003-00                 |
| HAF2-0025-SAA | 0661-12         | 0669-05             | 0095-03            |                 |         |               |         | 0115-00 | 0115-00 | 0092-37   | 0003-00                 |
| HAF2-0033-IAA | 0661-12         | 0669-05             | 0095-03            | 0061-07         | 0008-58 |               |         | 0166-08 | 0001-48 | 0092-04   | 0003-00                 |
| HAF2-0033-IAB | 0661-12         | 0669-05             | 0095-03            | 0061-12         | 0008-64 |               |         | 0166-19 | 0001-60 | 0092-31   | 0003-00                 |
| HAFB-0033-IAA | 0661-12         | 0669-05             | 0095-03            | 0061-07         | 0008-58 |               |         | 0166-08 | 0001-48 | 0092-04   | 0003-00                 |
| HAFB-003E-IAA | 0661-12         | 0669-05             | 0095-03            | 0061-07         | 0008-58 |               |         | 0166-08 | 0001-48 | 0092-04   | 0003-00                 |
| HAG1-0050-TAC | 0661-12         | 0669-05             | 0095-03            |                 |         |               |         |         |         | 0090-42   | 0003-00                 |
| HAG2-0050-CAA | 0661-12         | 0669-05             | 0095-03            | 0061-02         | 0008-49 | 0064-00       | 0037-04 | 0166-33 | 0001-75 | 0099-03   | 0003-00                 |
| HAG2-0050-CAV | 0661-12         | 0669-05             | 0095-03            | 0061-29         | 0036-05 | 0064-00       | 0037-04 | 0166-09 | 0001-49 | 0092-27   | 0003-00                 |
| HAJ1-0050-TAC | 0661-12         | 0669-06             | 0095-02            |                 |         |               |         |         |         | 0090-42   | 0003-00                 |
| HAJ2-0025-IAA | 0661-12         | 0669-06             | 0095-02            | 0061-06         | 0008-57 |               |         | 0115-00 | 0115-00 | 0092-37   | 0003-00                 |
| HAJ2-0025-IAB | 0661-12         | 0669-06             | 0095-02            | 0061-13         | 0008-65 |               |         | 0115-01 | 0115-01 | 0092-32   | 0003-00                 |
| HAJ2-0025-SAA | 0661-12         | 0669-06             | 0095-02            |                 |         |               |         | 0115-00 | 0115-00 | 0092-37   | 0003-00                 |
| HAJ2-0033-IAA | 0661-12         | 0669-06             | 0095-02            | 0061-07         | 0008-58 |               |         | 0166-08 | 0001-48 | 0092-04   | 0003-00                 |
| HAJ2-0033-IAB | 0661-12         | 0669-06             | 0095-02            | 0061-12         | 0008-64 |               |         | 0166-19 | 0001-60 | 0092-31   | 0003-00                 |
| HAJ2-0050-CAA | 0661-12         | 0669-06             | 0095-02            | 0061-02         | 0008-49 | 0064-00       | 0037-04 | 0166-33 | 0001-75 | 0099-03   | 0003-00                 |
| HAJ2-0050-CAV | 0661-12         | 0669-06             | 0095-02            | 0061-29         | 0036-05 | 0064-00       | 0037-04 | 0166-09 | 0001-49 | 0092-27   | 0003-00                 |
| HAJ2-0050-IAA | 0661-12         | 0669-06             | 0095-02            | 0061-02         | 0008-49 |               |         | 0166-08 | 0001-48 | 0092-35   | 0003-00                 |
| HAJB-003E-IAA | 0661-12         | 0669-06             | 0095-02            | 0061-07         | 0008-58 |               |         | 0166-08 | 0001-48 | 0092-04   | 0003-00                 |
| HAJB-005E-CAV | 0661-12         | 0669-06             | 0095-02            | 0061-29         | 0036-05 | 0064-00       | 0037-04 | 0166-25 | 0001-49 | 0092-27   | 0003-00                 |
| HAK2-0033-IAA | 0661-12         | 0669-07             | 0097-00            | 0061-07         | 0008-58 |               |         | 0166-08 | 0001-48 | 0092-04   | 0003-00                 |
| HAK2-0033-IAB | 0661-12         | 0669-07             | 0097-00            | 0061-12         | 0008-64 |               |         | 0166-19 | 0001-60 | 0092-31   | 0003-00                 |
| HAK2-0050-IAA | 0661-12         | 0669-07             | 0097-00            | 0061-02         | 0008-49 |               |         | 0166-08 | 0001-48 | 0092-35   | 0003-00                 |
| HAK2-0050-IAB | 0661-12         | 0669-07             | 0097-00            | 0061-09         | 0008-61 |               |         | 0166-09 | 0001-49 | 0092-05   | 0003-00                 |
| HAT2-0033-IAA | 0661-12         | 0669-07             | 0097-00            | 0061-07         | 0008-58 |               |         | 0166-08 | 0001-48 | 0092-04   | 0003-00                 |
| HAT2-0033-IAB | 0661-12         | 0669-07             | 0097-00            | 0061-12         | 0008-64 |               |         | 0166-19 | 0001-60 | 0092-31   | 0003-00                 |
| HAT2-0050-IAA | 0661-12         | 0669-07             | 0097-00            | 0061-02         | 0008-49 |               |         | 0166-08 | 0001-48 | 0092-35   | 0003-00                 |
| HAT2-0050-IAB | 0661-12         | 0669-07             | 0097-00            | 0061-09         | 0008-61 |               |         | 0166-09 | 0001-49 | 0092-05   | 0003-00                 |
| HATB-0051-CAA | 0661-12         | 0669-07             | 0097-00            | 0061-02         | 0008-49 | 0064-04       | 0037-08 | 0166-11 | 0001-51 | 0099-03   | 0003-00                 |
| HATB-005E-CAA | 0661-12         | 0669-07             | 0097-00            | 0061-02         | 0008-49 | 0064-04       | 0037-08 | 0166-11 | 0001-51 | 0099-03   | 0003-00                 |

**Note:** HW water cooled compressors are the same as the HA model having body fin casting except for a factory installed water jacket.

| Code Description |  |
|------------------|--|
| Code             | Description                                |
| A                | (Air-cooled) - Std. air cooled             |
| R                | (Refrigerant-cooled) - Std. refrig. cooled |
| W                | (Water-cooled) - Std. water cooled         |

| Compressor Motor Types |  |      |
|------------------------|--|------|
| Phase                  | Description  | Code |
| 1                      | Capacitor run - Capacitor start                      | C    |
| 1                      | Induction run - Capacitor start                      | I    |
| 3                      | Three phase  | T    |
| 3                      | Wye (star) delta                                     | E    |
| 3                      | 6 lead part winding or across the line - except 575V | F    |

**Product Variations**  
 Number will be assigned as follows:  
 1. Number - 100 is standard compressor used in Copeland brand Condensing units.  
 2. Number - 200 indicates a STANDARD Compressor Parts B/M and Model No.  
 3. Number - 201 and larger will be assigned for all other variations of a given model.  
 4. Number - 800 indicates a standard replacement Compressor and Component Parts B/M and Model No. - 240 volt control.  
 5. Number - 801 Indicates a standard replacement Compressor and Component Parts B/M and Model No. - 120 volt control.

**Model Variation**  
 A number or letter, assigned to indicate different model types within any one family series.

## K A T A - 0100 - C A V - 201

**Compressor Family Series**  
 Either a number or a letter established for each product model.

**Displacement**  
 A letter only, arbitrarily assigned for each different displacement within any one family series.

| Compressor Motor Rating |      |              |      |              |      |
|-------------------------|------|--------------|------|--------------|------|
| Nominal (HP)            | Code | Nominal (HP) | Code | Nominal (HP) | Code |
| 1/8                     | 0033 | 2            | 0200 | 5            | 0500 |
| 1/4                     | 0050 | 2            | 0210 | 20           | 2000 |
| 1/2                     | 0051 | 3            | 0300 | 25           | 2500 |
| 3/4                     | 0075 | 3            | 0310 | 30           | 3000 |
| 1                       | 0100 | 3            | 0311 | 35           | 3500 |
| 1 1/2                   | 0150 | 4            | 0400 | 40           | 4000 |

| Electrical Code |                   |      |
|-----------------|-------------------|------|
| 60 Hz           | 50 Hz             | Code |
| 115-1           | -                 | A    |
| 230-1           | -                 | B    |
| 208/230-3       | 200/220-3         | C    |
| 460-3           | 380/420-3         | D    |
| 575-3           | 550-3             | E    |
| 208/230/460-3   | 200/380/400-3     | K    |
| -               | 210/240/380/420-3 | L    |
| -               | 380/420-3         | M    |
| 230/460-3       | 200/400-3         | N    |
| 200-3           | -                 | U    |
| 208/230-1       | 200/220-1         | V    |
| -               | 220/240-1         | Z    |
| 200/220/380-3   | 200/380-3         | 8    |

| Compressor Motor Protection   |      |  |
|---|------|--|
| Description   | Code |  |
| External Inherent Protection - One Protector (Line Break) Use with Contactor                    | A    |  |
| Internal Inherent Protection - One Protector (Line Break) Use with Contactor                    | F    |  |
| Internal Thermal Protection - Electronic Sensors and Control Module External Use with Contactor | S    |  |

### Common Replacement Parts

| Common Parts  | Part Number |
|---|-------------|
| Sight Glass Kit   | 998-0002-04 |
| Suction Strainer Screen                                 | 013-0146-00 |
| Terminal Board - All K models                           | 580-0070-00 |
| Three Phase Only  |             |
| Terminal Fused Cluster (Fusite)                         | 521-0016-00 |
| Terminal Fused Seal (Fusite)                            | 020-0844-02 |
| Without Oil Pump  |             |
| Spring Mounting Parts Kit - All 1/2 hp to 1 hp models   | 527-0005-02 |
| Spring Mounting Parts Kit - All 1 1/2 hp to 2 hp models | 527-0005-03 |
| Gaskets   | Part Number |
| Cylinder Head Gasket                                    | 020-0920-01 |
| Stator Cover Gasket                                     | 020-0096-02 |
| Housing Cover Gasket                                    | 020-0107-02 |
| Bottom Plate Gasket - O-ring                            | 020-0003-09 |
| Crankcase Heater  | Part Number |
| Bolt On 120 Volt 50 Watt                                | 918-0118-05 |
| Bolt On 240 Volt 50 Watt                                | 918-0118-06 |
| Bolt On 480 Volt 50 Watt                                | 918-0118-03 |

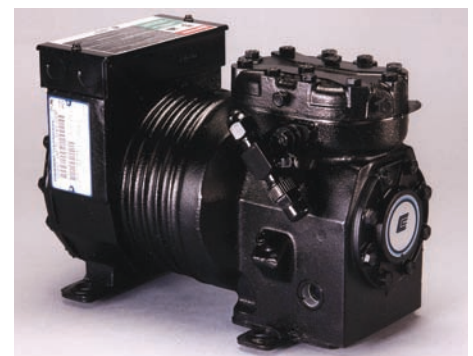



# K – Semi-Hermetic Compressors

## KA - Compressor Parts (air cooled)

| Model         | Valve Plate Kit | Complete Gasket Kit | Valve Plate Gasket | Start Capacitor |         | Run Capacitor |         | Relay   |         | Protector | Terminal Insulator Assembly |
|---------------|-----------------|---------------------|--------------------|-----------------|---------|---------------|---------|---------|---------|-----------|-----------------------------|
|               | (998-)          | (998-)              | (020-)             | OEM             | Service | OEM           | Service | OEM     | Service |           |                             |
|               | (014-)          | (914-)              | (014-)             | (914-)          | (040-)  | (940-)        | (071-)  | (580-)  |         |           |                             |
| KAA1-0075-TAC | 0661-16         | 0669-14             | 0958-03            |                 |         |               |         |         |         | 0090-05   | 0003-00                     |
| KAA2-0075-CAA | 0661-16         | 0669-14             | 0958-03            | 0061-14         | 0008-66 | 0064-02       | 0037-06 | 0166-11 | 0001-51 | 0092-20   | 0003-00                     |
| KAA2-0075-CAV | 0661-16         | 0669-14             | 0958-03            | 0061-04         | 0008-51 | 0064-00       | 0037-04 | 0166-09 | 0001-49 | 0092-29   | 0003-00                     |
| KAA2-0075-IAA | 0661-16         | 0669-14             | 0958-03            | 0061-11         | 0008-63 |               |         | 0166-08 | 0001-48 | 0099-00   | 0003-00                     |
| KAA2-0075-IAB | 0661-16         | 0669-14             | 0958-03            | 0061-04         | 0008-51 |               |         | 0166-09 | 0001-49 | 0092-27   | 0003-00                     |
| KAA2-0075-IAH | 0661-16         | 0669-14             | 0958-03            | 0061-04         | 0008-51 |               |         | 0166-09 | 0001-49 | 0092-27   | 0003-00                     |
| KAA2-0076-CAA | 0661-16         | 0669-14             | 0958-03            | 0061-11         | 0008-63 | 0064-06       | 0037-10 | 0166-33 | 0001-75 | 0092-38   | 0003-00                     |
| KAAB-0075-IAA | 0661-16         | 0669-14             | 0958-03            | 0061-11         | 0008-63 |               |         | 0166-08 | 0001-48 | 0099-00   | 0003-00                     |
| KAAB-007E-CAA | 0661-16         | 0669-14             | 0958-03            | 0061-11         | 0008-63 | 0064-11       | 0037-15 | 0166-08 | 0001-48 | 0099-00   | 0003-00                     |
| KAD1-0075-TAC | 0661-16         | 0669-11             | 0958-01            |                 |         |               |         |         |         | 0090-05   | 0003-00                     |
| KAD2-0075-CAA | 0661-16         | 0669-11             | 0958-01            | 0061-11         | 0008-63 | 0064-06       | 0037-10 | 0166-33 | 0001-75 | 0099-07   | 0003-00                     |
| KAD2-0075-CAV | 0661-16         | 0669-11             | 0958-01            | 0061-04         | 0008-51 | 0064-00       | 0037-04 | 0166-09 | 0001-49 | 0092-29   | 0003-00                     |
| KAE1-0050-TAC | 0661-42         | 0669-12             | 0958-02            |                 |         |               |         |         |         | 0090-06   | 0003-00                     |
| KAE1-0075-TAC | 0661-42         | 0669-12             | 0958-02            |                 |         |               |         |         |         | 0090-41   | 0003-00                     |
| KAE2-0050-CAV | 0661-42         | 0669-12             | 0958-02            | 0061-29         | 0036-05 | 0064-00       | 0037-04 | 0166-09 | 0001-49 | 0092-37   | 0003-00                     |
| KAE2-0050-IAA | 0661-42         | 0669-12             | 0958-02            | 0061-02         | 0008-49 |               |         | 0166-08 | 0001-48 | 0092-06   | 0003-00                     |
| KAE2-0050-IAB | 0661-42         | 0669-12             | 0958-02            | 0061-09         | 0008-61 |               |         | 0166-09 | 0001-49 | 0092-05   | 0003-00                     |
| KAE2-0050-IAH | 0661-42         | 0669-12             | 0958-02            | 0061-09         | 0008-61 |               |         | 0166-09 | 0001-49 | 0092-05   | 0003-00                     |
| KAE2-0075-CAA | 0661-42         | 0669-12             | 0958-02            | 0061-11         | 0008-63 | 0064-06       | 0037-10 | 0166-33 | 0001-75 | 0099-06   | 0003-00                     |
| KAE2-0075-CAV | 0661-42         | 0669-12             | 0958-02            | 0061-04         | 0008-51 | 0064-00       | 0037-04 | 0166-09 | 0001-49 | 0092-29   | 0003-00                     |
| KAEA-007E-TAC | 0661-42         | 0669-12             | 0958-02            |                 |         |               |         |         |         | 0090-41   | 0003-00                     |
| KAEB-007E-CAA | 0661-42         | 0669-12             | 0958-02            | 0061-11         | 0008-63 | 0064-06       | 0037-10 | 0166-33 | 0001-75 | 0099-06   | 0003-00                     |
| KAEB-007E-CAV | 0661-42         | 0669-12             | 0958-02            | 0061-04         | 0008-51 | 0064-00       | 0037-04 | 0166-09 | 0001-49 | 0092-29   | 0003-00                     |
| KAG1-0050-TAC | 0661-16         | 0669-11             | 0958-01            |                 |         |               |         |         |         | 0090-06   | 0003-00                     |
| KAG1-0075-TAC | 0661-16         | 0669-11             | 0958-01            |                 |         |               |         |         |         | 0090-05   | 0003-00                     |
| KAG1-0100-TAC | 0661-16         | 0669-11             | 0958-01            |                 |         |               |         |         |         | 0090-16   | 0003-00                     |
| KAG1-0100-TAD | 0661-16         | 0669-11             | 0958-01            |                 |         |               |         |         |         | 0090-07   | 0003-00                     |
| KAG2-0050-CAV | 0661-16         | 0669-11             | 0958-01            | 0061-29         | 0036-05 | 0064-00       | 0037-04 | 0166-09 | 0001-49 | 0092-37   | 0003-00                     |
| KAG2-0050-IAA | 0661-16         | 0669-11             | 0958-01            | 0061-02         | 0008-49 |               |         | 0166-08 | 0001-48 | 0092-06   | 0003-00                     |
| KAG2-0050-IAB | 0661-16         | 0669-11             | 0958-01            | 0061-09         | 0008-61 |               |         | 0166-09 | 0001-49 | 0092-05   | 0003-00                     |
| KAG2-0050-IAH | 0661-16         | 0669-11             | 0958-01            | 0061-09         | 0008-61 |               |         | 0166-09 | 0001-49 | 0092-05   | 0003-00                     |
| KAG2-0075-CAA | 0661-16         | 0669-11             | 0958-01            | 0061-14         | 0008-66 | 0064-04       | 0037-06 | 0166-11 | 0001-51 | 0092-20   | 0003-00                     |
| KAG2-0075-CAV | 0661-16         | 0669-11             | 0958-01            | 0061-04         | 0008-51 | 0064-00       | 0037-04 | 0166-09 | 0001-50 | 0092-29   | 0003-00                     |
| KAG2-0075-IAA | 0661-16         | 0669-11             | 0958-01            | 0061-11         | 0008-63 |               |         | 0166-08 | 0001-48 | 0099-00   | 0003-00                     |
| KAG2-0075-IAB | 0661-16         | 0669-11             | 0958-01            | 0061-04         | 0008-51 |               |         | 0166-09 | 0001-49 | 0092-27   | 0003-00                     |
| KAG2-0075-IAH | 0661-16         | 0669-11             | 0958-01            | 0061-04         | 0008-51 |               |         | 0166-09 | 0001-49 | 0092-27   | 0003-00                     |
| KAG2-0100-CAA | 0661-16         | 0669-11             | 0958-01            | 0061-05         | 0008-52 | 0064-08       | 0037-12 | 0166-11 | 0001-51 | 0092-40   | 0176-00                     |
| KAG2-0100-CAV | 0661-16         | 0669-11             | 0958-01            | 0061-04         | 0008-51 | 0064-00       | 0037-04 | 0166-09 | 0001-49 | 0092-39   | 0176-00                     |
| KAGA-0150-TAC | 0661-16         | 0669-11             | 0958-01            |                 |         |               |         |         |         | 0090-39   | 0176-00                     |
| KAGA-0150-TAD | 0661-16         | 0669-11             | 0958-01            |                 |         |               |         |         |         | 0090-27   | 0176-00                     |
| KAGB-0050-IAA | 0661-16         | 0669-11             | 0958-01            | 0061-02         | 0008-49 |               |         | 0166-08 | 0001-48 | 0092-06   | 0003-00                     |
| KAGB-005E-IAA | 0661-16         | 0669-11             | 0958-01            | 0061-02         | 0008-49 |               |         | 0166-08 | 0001-48 | 0092-06   | 0003-00                     |

**Note:** KW water cooled compressors are the same as the KA model having body fin casting except for a factory installed water jacket.

## KA - Compressor Parts (air cooled)

| Model         | Valve Plate Kit | Complete Gasket Kit | Valve Plate Gasket | Start Capacitor |         | Run Capacitor |         | Relay   |         | Protector | Terminal Insulator Assembly |
|---------------|-----------------|---------------------|--------------------|-----------------|---------|---------------|---------|---------|---------|-----------|-----------------------------|
|               | (998-)          | (998-)              | (020-)             | OEM             | Service | OEM           | Service | OEM     | Service |           |                             |
|               | (014-)          | (914-)              | (014-)             | (914-)          | (040-)  | (940-)        | (071-)  | (580-)  |         |           |                             |
| KAGB-0150-CAV | 0661-16         | 0669-11             | 0958-01            | 0061-30         | 0006-01 | 0064-19       | 0037-23 | 0166-20 | 0001-61 | 0099-04   | 0176-00                     |
| KAJ1-0075-TAC | 0661-16         | 0669-13             | 0958-00            |                 |         |               |         |         |         | 0090-05   | 0003-00                     |
| KAJ1-0100-TAC | 0661-16         | 0669-13             | 0958-00            |                 |         |               |         |         |         | 0090-04   | 0003-00                     |
| KAJ1-0100-TAD | 0661-16         | 0669-13             | 0958-00            |                 |         |               |         |         |         | 0090-07   | 0003-00                     |
| KAJ3-0075-CAV | 0661-16         | 0669-13             | 0958-00            | 0061-04         | 0008-51 | 0064-00       | 0037-04 | 0166-09 | 0001-49 | 0092-29   | 0003-00                     |
| KAJ3-0075-IAA | 0661-16         | 0669-13             | 0958-00            | 0061-11         | 0008-63 |               |         | 0166-08 | 0001-48 | 0099-00   | 0003-00                     |
| KAJ3-0075-IAB | 0661-16         | 0669-13             | 0958-00            | 0061-04         | 0008-51 |               |         | 0166-09 | 0001-49 | 0092-27   | 0003-00                     |
| KAJ3-0075-IAH | 0661-16         | 0669-13             | 0958-00            | 0061-04         | 0008-51 |               |         | 0166-09 | 0001-49 | 0092-27   | 0003-00                     |
| KAJ3-0100-CAA | 0661-16         | 0669-13             | 0958-00            | 0061-05         | 0008-52 | 0064-08       | 0037-12 | 0166-11 | 0001-51 | 0092-23   | 0176-00                     |
| KAJ3-0100-CAB | 0661-16         | 0669-13             | 0958-00            | 0061-04         | 0008-51 | 0064-00       | 0037-04 | 0166-10 | 0001-50 | 0092-25   | 0003-00                     |
| KAJ3-0100-CAH | 0661-16         | 0669-13             | 0958-00            | 0061-04         | 0008-51 | 0064-00       | 0037-04 | 0166-25 | 0001-66 | 0092-14   | 0003-00                     |
| KAJ3-0100-CAV | 0661-16         | 0669-13             | 0958-00            | 0061-04         | 0008-51 | 0064-10       | 0037-14 | 0166-10 | 0001-50 | 0092-39   | 0176-00                     |
| KAJA-0100-TAC | 0661-16         | 0669-13             | 0958-00            |                 |         |               |         |         |         | 0090-04   | 0003-00                     |
| KAJA-0101-TAC | 0661-16         | 0669-13             | 0958-00            |                 |         |               |         |         |         | 0090-16   | 0003-00                     |
| KAJA-010E-TAC | 0661-16         | 0669-13             | 0958-00            |                 |         |               |         |         |         | 0090-04   | 0003-00                     |
| KAJA-011E-TAC | 0661-16         | 0669-13             | 0958-00            |                 |         |               |         |         |         | 0090-50   | 0003-00                     |
| KAJA-011E-TAD | 0661-16         | 0669-13             | 0958-00            |                 |         |               |         |         |         | 0090-21   | 0003-00                     |
| KAJB-007E-IAA | 0661-16         | 0669-13             | 0958-00            | 0061-11         | 0008-63 |               |         | 0166-08 | 0001-48 | 0099-00   | 0003-00                     |
| KAJB-0100-CAA | 0661-16         | 0669-13             | 0958-00            | 0061-05         | 0008-52 | 0064-08       | 0037-12 | 0166-11 | 0001-51 | 0092-23   | 0176-00                     |
| KAJB-0100-CAV | 0661-16         | 0669-13             | 0958-00            | 0061-04         | 0008-51 | 0064-10       | 0037-14 | 0166-10 | 0001-50 | 0092-39   | 0176-00                     |
| KAJB-010E-CAV | 0661-16         | 0669-13             | 0958-00            | 0061-04         | 0008-51 | 0064-10       | 0037-14 | 0166-10 | 0001-50 | 0092-39   | 0176-00                     |
| KAJC-0100-TAC | 0661-16         | 0669-13             | 0958-00            |                 |         |               |         |         |         | 0090-04   | 0003-00                     |
| KAJC-0101-TAC | 0661-16         | 0669-13             | 0958-00            |                 |         |               |         |         |         | 0090-16   | 0003-00                     |
| KAK1-0100-TAC | 0661-16         | 0669-14             | 0958-03            |                 |         |               |         |         |         | 0090-04   | 0003-00                     |
| KAK1-0100-TAD | 0661-16         | 0669-14             | 0958-03            |                 |         |               |         |         |         | 0090-07   | 0003-00                     |
| KAK2-0100-CAA | 0661-16         | 0669-14             | 0958-03            | 0061-05         | 0008-52 | 0064-08       | 0037-12 | 0166-11 | 0001-51 | 0092-23   | 0176-00                     |
| KAK2-0100-CAB | 0661-16         | 0669-14             | 0958-03            | 0061-04         | 0008-51 | 0064-00       | 0037-04 | 0166-10 | 0001-50 | 0092-25   | 0003-00                     |
| KAK2-0100-CAH | 0661-16         | 0669-14             | 0958-03            | 0061-04         | 0008-51 | 0064-00       | 0037-04 | 0166-25 | 0001-66 | 0092-14   | 0003-00                     |
| KAK2-0100-CAV | 0661-16         | 0669-14             | 0958-03            | 0061-04         | 0008-51 | 0064-10       | 0037-14 | 0166-10 | 0001-50 | 0092-39   | 0176-00                     |
| KAKA-0100-TAC | 0661-16         | 0669-14             | 0958-03            |                 |         |               |         |         |         | 0090-04   | 0003-00                     |
| KAKA-0200-TAC | 0661-16         | 0669-14             | 0958-03            |                 |         |               |         |         |         | 0090-35   | 0176-00                     |
| KAKA-0200-TAD | 0661-16         | 0669-14             | 0958-03            |                 |         |               |         |         |         | 0090-16   | 0176-00                     |
| KAKB-011E-CAV | 0661-16         | 0669-14             | 0958-03            | 0061-04         | 0008-51 | 0064-14       | 0037-18 | 0166-10 | 0001-50 | 0092-42   | 0176-00                     |
| KAKB-0150-CAB | 0661-16         | 0669-14             | 0958-03            | 0061-29         | 0036-05 | 0064-11       | 0037-15 | 0166-20 | 0001-61 | 0092-29   | 0176-00                     |
| KAKB-0151-CAB | 0661-16         | 0669-14             | 0958-03            | 0061-29         | 0036-05 | 0064-19       | 0037-23 | 0166-20 | 0001-61 | 0099-03   | 0176-00                     |
| KAKB-0200-CAV | 0661-16         | 0669-14             | 0958-03            | 0061-30         | 0006-01 | 0064-19       | 0037-23 | 0166-20 | 0001-61 | 0099-04   | 0176-00                     |
| KAKC-0200-TAC | 0661-16         | 0669-14             | 0958-03            |                 |         |               |         |         |         | 0090-35   | 0176-00                     |
| KAL1-0100-TAC | 0661-16         | 0669-15             | 0958-04            |                 |         |               |         |         |         | 0090-04   | 0003-00                     |
| KAL1-0100-TAD | 0661-16         | 0669-15             | 0958-04            |                 |         |               |         |         |         | 0090-07   | 0003-00                     |
| KAL2-0100-CAA | 0661-16         | 0669-15             | 0958-04            | 0061-05         | 0008-52 | 0064-08       | 0037-12 | 0166-11 | 0001-51 | 0092-23   | 0176-00                     |
| KAL2-0100-CAB | 0661-16         | 0669-15             | 0958-04            | 0061-04         | 0008-51 | 0064-00       | 0037-04 | 0166-10 | 0001-50 | 0092-25   | 0003-00                     |
| KAL2-0100-CAH | 0661-16         | 0669-15             | 0958-04            | 0061-04         | 0008-51 | 0064-00       | 0037-04 | 0166-25 | 0001-66 | 0092-14   | 0003-00                     |

**Note:** KW water cooled compressors are the same as the KA model having body fin casting except for a factory installed water jacket.

# K – Semi-Hermetic Compressors

## KA - Compressor Parts (air cooled)

| Model         | Valve Plate Kit | Complete Gasket Kit | Valve Plate Gasket | Start Capacitor |         | Run Capacitor |         | Relay   |         | Protector | Terminal Insulator Assembly |
|---------------|-----------------|---------------------|--------------------|-----------------|---------|---------------|---------|---------|---------|-----------|-----------------------------|
|               | (998-)          | (998-)              | (020-)             | OEM             | Service | OEM           | Service | OEM     | Service |           |                             |
|               | (014-)          | (914-)              | (014-)             | (914-)          | (040-)  | (940-)        | (071-)  | (580-)  |         |           |                             |
| KAL2-0100-CAV | 0661-16         | 0669-15             | 0958-04            | 0061-04         | 0008-51 | 0064-10       | 0037-14 | 0166-10 | 0001-50 | 0092-39   | 0176-00                     |
| KALA-0100-TAC | 0661-16         | 0669-15             | 0958-04            |                 |         |               |         |         |         | 0090-04   | 0003-00                     |
| KALA-0100-TAD | 0661-16         | 0669-15             | 0958-04            |                 |         |               |         |         |         | 0090-07   | 0003-00                     |
| KALA-0150-TAC | 0661-16         | 0669-15             | 0958-04            |                 |         |               |         |         |         | 0090-03   | 0176-00                     |
| KALA-0150-TAD | 0661-16         | 0669-15             | 0958-04            |                 |         |               |         |         |         | 0090-27   | 0176-00                     |
| KALA-016E-TAC | 0661-16         | 0669-15             | 0958-04            |                 |         |               |         |         |         | 0090-35   | 0176-00                     |
| KALA-016E-TAD | 0661-16         | 0669-15             | 0958-04            |                 |         |               |         |         |         | 0090-16   | 0176-00                     |
| KALB-0100-CAA | 0661-16         | 0669-15             | 0958-06            | 0061-05         | 0008-52 | 0064-08       | 0037-12 | 0166-11 | 0001-51 | 0092-23   | 0176-00                     |
| KALB-0100-CAB | 0661-16         | 0669-15             | 0958-06            | 0061-04         | 0008-51 | 0064-00       | 0037-04 | 0166-10 | 0001-50 | 0092-25   | 0003-00                     |
| KALB-0100-CAH | 0661-16         | 0669-15             | 0958-06            | 0061-04         | 0008-51 | 0064-00       | 0037-04 | 0166-25 | 0001-66 | 0092-14   | 0003-00                     |
| KALB-0100-CAV | 0661-16         | 0669-15             | 0958-06            | 0061-04         | 0008-51 | 0064-10       | 0037-14 | 0166-10 | 0001-50 | 0092-39   | 0176-00                     |
| KALB-010E-CAV | 0661-16         | 0669-15             | 0958-06            | 0061-04         | 0008-51 | 0064-10       | 0037-14 | 0166-10 | 0001-50 | 0092-39   | 0176-00                     |
| KALB-0150-CAB | 0661-16         | 0669-15             | 0958-06            | 0061-29         | 0036-05 | 0064-10       | 0037-14 | 0166-20 | 0001-61 | 0092-16   | 0176-00                     |
| KALB-0150-CAH | 0661-16         | 0669-15             | 0958-06            | 0061-29         | 0036-05 | 0064-10       | 0037-14 | 0166-30 | 0001-71 | 0092-18   | 0176-00                     |
| KALB-0150-CAV | 0661-16         | 0669-15             | 0958-06            | 0061-30         | 0006-01 | 0064-19       | 0037-23 | 0166-20 | 0001-61 | 0099-04   | 0176-00                     |
| KALB-0151-CAB | 0661-16         | 0669-15             | 0958-06            | 0061-29         | 0036-05 | 0064-19       | 0037-23 | 0166-20 | 0001-61 | 0099-03   | 0176-00                     |
| KALB-015E-CAV | 0661-16         | 0669-15             | 0958-06            | 0061-30         | 0006-01 | 0064-19       | 0037-23 | 0166-20 | 0001-61 | 0099-04   | 0176-00                     |
| KAM1-0050-TAC | 0661-16         | 0669-50             | 0958-05            |                 |         |               |         |         |         | 0090-06   | 0003-00                     |
| KAM1-0075-TAC | 0661-16         | 0669-50             | 0958-05            |                 |         |               |         |         |         | 0090-05   | 0003-00                     |
| KAM1-0100-TAC | 0661-16         | 0669-50             | 0958-05            |                 |         |               |         |         |         | 0090-40   | 0003-00                     |
| KAM1-0100-TAD | 0661-16         | 0669-50             | 0958-05            |                 |         |               |         |         |         | 0090-43   | 0003-00                     |
| KAM2-0050-CAV | 0661-16         | 0669-50             | 0958-05            | 0061-29         | 0036-05 | 0064-00       | 0037-04 | 0166-09 | 0001-49 | 0092-37   | 0003-00                     |
| KAM2-0050-IAA | 0661-16         | 0669-50             | 0958-05            | 0061-02         | 0008-49 |               |         | 0166-08 | 0001-48 | 0092-06   | 0003-00                     |
| KAM2-0050-IAB | 0661-16         | 0669-50             | 0958-05            | 0061-09         | 0008-61 |               |         | 0166-09 | 0001-49 | 0092-05   | 0003-00                     |
| KAM2-0050-IAH | 0661-16         | 0669-50             | 0958-05            | 0061-09         | 0008-61 |               |         | 0166-09 | 0001-49 | 0092-05   | 0003-00                     |
| KAM2-0075-CAV | 0661-16         | 0669-50             | 0958-05            | 0061-04         | 0008-51 | 0064-00       | 0037-04 | 0166-09 | 0001-49 | 0092-29   | 0003-00                     |
| KAM2-0075-IAA | 0661-16         | 0669-50             | 0958-05            | 0061-11         | 0008-63 |               |         | 0166-08 | 0001-48 | 0099-00   | 0003-00                     |
| KAM2-0075-IAB | 0661-16         | 0669-50             | 0958-05            | 0061-04         | 0008-51 |               |         | 0166-09 | 0001-49 | 0092-27   | 0003-00                     |
| KAM2-0075-IAH | 0661-16         | 0669-50             | 0958-05            | 0061-04         | 0008-51 |               |         | 0166-09 | 0001-49 | 0092-27   | 0003-00                     |
| KAM2-0100-CAA | 0661-16         | 0669-50             | 0958-05            | 0061-05         | 0008-52 | 0064-08       | 0037-12 | 0166-11 | 0001-51 | 0099-05   | 0176-00                     |
| KAM2-0100-CAV | 0661-16         | 0669-50             | 0958-05            | 0061-04         | 0008-51 | 0064-10       | 0037-14 | 0166-10 | 0001-50 | 0092-39   | 0176-00                     |
| KAMA-0050-TAC | 0661-16         | 0669-50             | 0958-05            |                 |         |               |         |         |         | 0090-06   | 0003-00                     |
| KAMA-0075-TAC | 0661-16         | 0669-50             | 0958-05            |                 |         |               |         |         |         | 0090-41   | 0003-00                     |
| KAMA-007E-TAC | 0661-16         | 0669-50             | 0958-05            |                 |         |               |         |         |         | 0090-41   | 0003-00                     |
| KAMB-0050-CAV | 0661-16         | 0669-50             | 0958-05            | 0061-29         | 0036-05 | 0064-00       | 0037-04 | 0166-09 | 0001-49 | 0092-37   | 0003-00                     |
| KAMB-0050-IAA | 0661-16         | 0669-50             | 0958-05            | 0061-02         | 0008-49 |               |         | 0166-08 | 0001-48 | 0092-06   | 0003-00                     |
| KAMB-0050-IAB | 0661-16         | 0669-50             | 0958-05            | 0061-09         | 0008-61 |               |         | 0166-09 | 0001-49 | 0092-05   | 0003-00                     |
| KAMB-0050-IAH | 0661-16         | 0669-50             | 0958-05            | 0061-09         | 0008-61 |               |         | 0166-09 | 0001-49 | 0092-05   | 0003-00                     |
| KAMB-0075-CAA | 0661-16         | 0669-50             | 0958-05            | 0061-05         | 0008-52 | 0064-08       | 0037-12 | 0166-11 | 0001-51 | 0092-40   | 0003-00                     |
| KAMB-0075-CAV | 0661-16         | 0669-50             | 0958-05            | 0061-04         | 0008-51 | 0064-00       | 0037-04 | 0166-09 | 0001-49 | 0092-29   | 0003-00                     |
| KAMB-0075-IAB | 0661-16         | 0669-50             | 0958-05            | 0061-04         | 0008-51 |               |         | 0166-09 | 0001-49 | 0092-27   | 0003-00                     |
| KAMB-0075-IAH | 0661-16         | 0669-50             | 0958-05            | 0061-04         | 0008-51 |               |         | 0166-09 | 0001-49 | 0092-27   | 0003-00                     |

**Note:** KW water cooled compressors are the same as the KA model having body fin casting except for a factory installed water jacket.

## KA - Compressor Parts (air cooled)

| Model         | Valve Plate Kit | Complete Gasket Kit | Valve Plate Gasket | Start Capacitor |         | Run Capacitor |         | Relay   |         | Protector | Terminal Insulator Assembly |
|---------------|-----------------|---------------------|--------------------|-----------------|---------|---------------|---------|---------|---------|-----------|-----------------------------|
|               | (998-)          | (998-)              | (020-)             | OEM             | Service | OEM           | Service | OEM     | Service |           |                             |
|               | (014-)          | (914-)              | (014-)             | (914-)          | (040-)  | (940-)        | (071-)  | (580-)  |         |           |                             |
| KAMB-007E-CAA | 0661-16         | 0669-50             | 0958-05            | 0061-05         | 0008-52 | 0064-08       | 0037-12 | 0166-11 | 0001-51 | 0092-40   | 0003-00                     |
| KAMB-007E-CAV | 0661-16         | 0669-50             | 0958-05            | 0061-04         | 0008-51 | 0064-00       | 0037-04 | 0166-09 | 0001-49 | 0092-29   | 0003-00                     |
| KAMC-0075-TAC | 0661-16         | 0669-50             | 0958-05            |                 |         |               |         |         |         | 0090-41   | 0003-00                     |
| KAN1-0050-TAC | 0661-16         | 0669-50             | 0958-05            |                 |         |               |         |         |         | 0090-06   | 0003-00                     |
| KAN1-0075-TAC | 0661-16         | 0669-50             | 0958-05            |                 |         |               |         |         |         | 0090-41   | 0003-00                     |
| KAN2-0050-CAV | 0661-16         | 0669-50             | 0958-05            | 0061-29         | 0036-05 | 0064-00       | 0037-04 | 0166-09 | 0001-49 | 0092-37   | 0003-00                     |
| KAN2-0050-IAA | 0661-16         | 0669-50             | 0958-05            | 0061-02         | 0008-49 |               |         | 0166-08 | 0001-48 | 0092-06   | 0003-00                     |
| KAN2-0050-IAB | 0661-16         | 0669-50             | 0958-05            | 0061-09         | 0008-61 |               |         | 0166-09 | 0001-49 | 0092-05   | 0003-00                     |
| KAN2-0050-IAH | 0661-16         | 0669-50             | 0958-05            | 0061-09         | 0008-61 |               |         | 0166-09 | 0001-49 | 0092-05   | 0003-00                     |
| KAN2-0075-CAA | 0661-16         | 0669-50             | 0958-05            | 0061-11         | 0008-63 | 0064-06       | 0037-10 | 0166-33 | 0001-75 | 0099-06   | 0003-00                     |
| KAN2-0075-CAV | 0661-16         | 0669-50             | 0958-05            | 0061-04         | 0008-51 | 0064-00       | 0037-04 | 0166-09 | 0001-49 | 0092-41   | 0003-00                     |
| KANA-006E-TAC | 0661-16         | 0669-50             | 0958-05            |                 |         |               |         |         |         | 0090-21   | 0003-00                     |
| KANA-007E-TAC | 0661-16         | 0669-50             | 0958-05            |                 |         |               |         |         |         | 0090-41   | 0003-00                     |
| KANB-0050-CAV | 0661-16         | 0669-50             | 0958-05            | 0061-29         | 0036-05 | 0064-00       | 0037-04 | 0166-09 | 0001-49 | 0092-37   | 0003-00                     |
| KANB-0050-IAA | 0661-16         | 0669-50             | 0958-05            | 0061-02         | 0008-49 |               |         | 0166-08 | 0001-48 | 0092-06   | 0003-00                     |
| KANB-005E-CAV | 0661-16         | 0669-50             | 0958-05            | 0061-29         | 0036-05 | 0064-00       | 0037-04 | 0166-09 | 0001-49 | 0092-37   | 0003-00                     |
| KANB-005E-IAA | 0661-16         | 0669-50             | 0958-05            | 0061-02         | 0008-49 |               |         | 0166-08 | 0001-48 | 0092-06   | 0003-00                     |
| KAR1-0100-TAC | 0661-42         | 0669-50             | 0958-07            |                 |         |               |         |         |         | 0090-40   | 0176-00                     |
| KAR1-0100-TAD | 0661-42         | 0669-50             | 0958-07            |                 |         |               |         |         |         | 0090-42   | 0176-00                     |
| KAR2-0100-CAA | 0661-42         | 0669-50             | 0958-07            | 0061-05         | 0008-52 | 0064-08       | 0037-12 | 0166-11 | 0001-51 | 0099-05   | 0176-00                     |
| KAR2-0100-CAV | 0661-42         | 0669-50             | 0958-07            | 0061-04         | 0008-51 | 0064-10       | 0037-14 | 0166-10 | 0001-50 | 0092-39   | 0176-00                     |
| KARA-010E-TAC | 0661-42         | 0669-50             | 0958-07            |                 |         |               |         |         |         | 0090-40   | 0176-00                     |
| KARA-011E-TAD | 0661-42         | 0669-50             | 0958-07            |                 |         |               |         |         |         | 0090-42   | 0176-00                     |
| KARB-010E-CAV | 0661-42         | 0669-50             | 0958-07            | 0061-04         | 0008-51 | 0064-10       | 0037-14 | 0166-10 | 0001-50 | 0092-39   | 0176-00                     |
| KATA-0100-TAC | 0661-16         | 0669-15             | 0958-04            |                 |         |               |         |         |         | 0090-04   | 0003-00                     |
| KATA-0100-TAD | 0661-16         | 0669-15             | 0958-04            |                 |         |               |         |         |         | 0090-07   | 0003-00                     |
| KATA-0150-TAC | 0661-16         | 0669-15             | 0958-06            |                 |         |               |         |         |         | 0090-03   | 0176-00                     |
| KATA-0150-TAD | 0661-16         | 0669-15             | 0958-06            |                 |         |               |         |         |         | 0090-27   | 0176-00                     |
| KATA-0151-TAC | 0661-16         | 0669-15             | 0958-06            |                 |         |               |         |         |         | 0090-22   | 0176-00                     |
| KATA-015E-TAC | 0661-16         | 0669-15             | 0958-06            |                 |         |               |         |         |         | 0090-03   | 0176-00                     |
| KATA-015E-TAD | 0661-16         | 0669-15             | 0958-06            |                 |         |               |         |         |         | 0090-03   | 0176-00                     |
| KATB-0100-CAA | 0661-16         | 0669-15             | 0958-04            | 0061-05         | 0008-52 | 0064-08       | 0037-12 | 0166-11 | 0001-51 | 0092-23   | 0176-00                     |
| KATB-0100-CAB | 0661-16         | 0669-15             | 0958-04            | 0061-04         | 0008-51 | 0064-00       | 0037-04 | 0166-10 | 0001-50 | 0092-25   | 0003-00                     |
| KATB-0100-CAH | 0661-16         | 0669-15             | 0958-04            | 0061-04         | 0008-51 | 0064-00       | 0037-04 | 0166-25 | 0001-66 | 0092-14   | 0003-00                     |
| KATB-0100-CAV | 0661-16         | 0669-15             | 0958-04            | 0061-04         | 0008-51 | 0064-10       | 0037-14 | 0166-10 | 0001-50 | 0092-39   | 0176-00                     |
| KATB-0150-CAB | 0661-16         | 0669-15             | 0958-06            | 0061-29         | 0036-05 | 0064-10       | 0037-14 | 0166-20 | 0001-61 | 0092-18   | 0176-00                     |
| KATB-0150-CAH | 0661-16         | 0669-15             | 0958-06            | 0061-29         | 0036-05 | 0064-10       | 0037-14 | 0166-30 | 0001-71 | 0092-18   | 0176-00                     |
| KATB-0150-CAV | 0661-16         | 0669-15             | 0958-06            | 0061-30         | 0006-01 | 0064-19       | 0037-23 | 0166-20 | 0001-61 | 0099-04   | 0176-00                     |
| KATB-0151-CAB | 0661-16         | 0669-15             | 0958-06            | 0061-29         | 0036-05 | 0064-19       | 0037-23 | 0166-20 | 0001-61 | 0092-18   | 0176-00                     |
| KATB-015E-CAV | 0661-16         | 0669-15             | 0958-06            | 0061-30         | 0006-01 | 0064-19       | 0037-23 | 0166-20 | 0001-61 | 0099-04   | 0176-00                     |
| KATC-0150-TAC | 0661-16         | 0669-15             | 0958-06            |                 |         |               |         |         |         | 0090-03   | 0176-00                     |

**Note:** KW water cooled compressors are the same as the KA model having body fin casting except for a factory installed water jacket.

# L – Semi-Hermetic Compressors

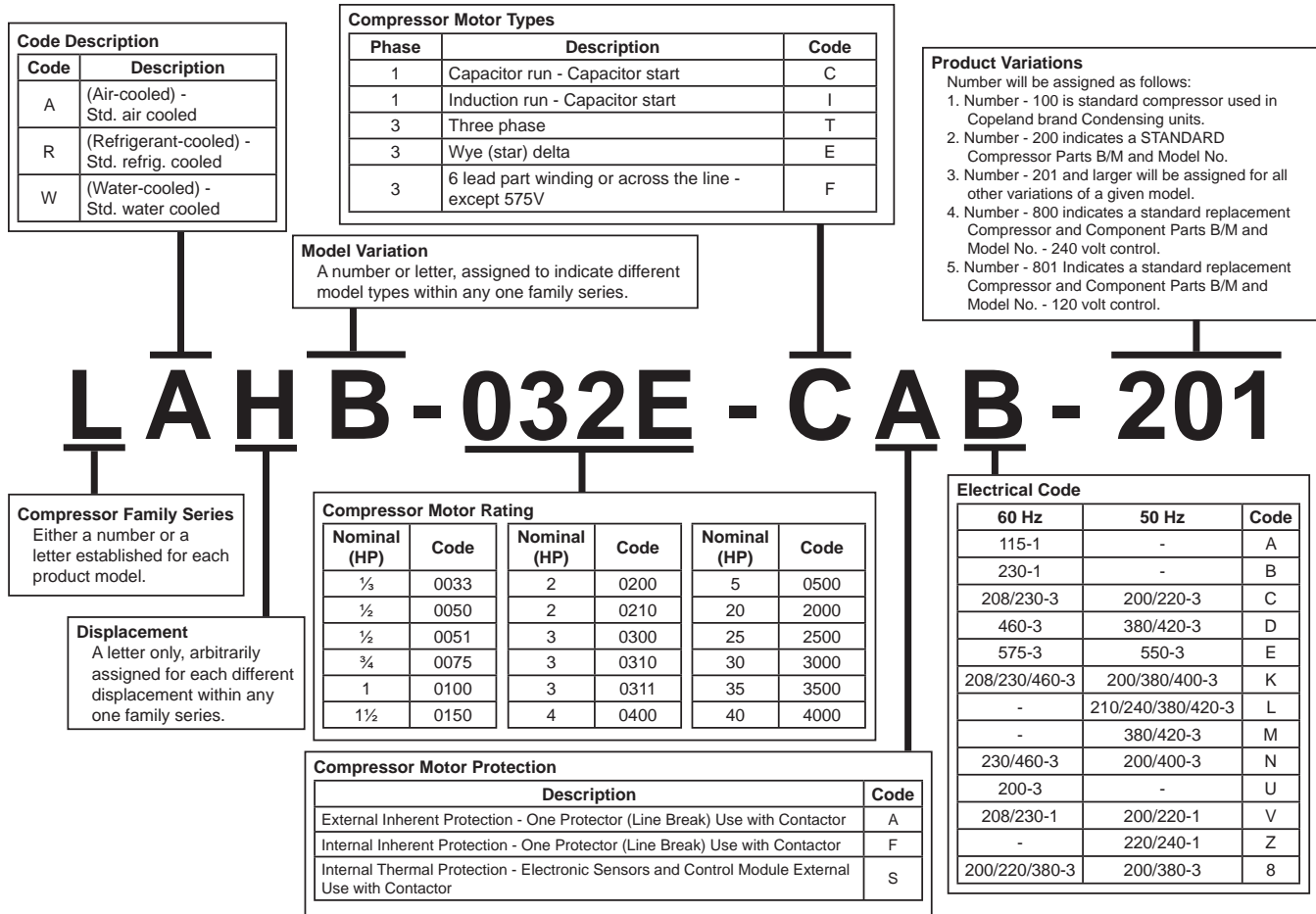

## Common Replacement Parts

| Common Parts                 | Part Number |
|------------------------------|-------------|
| Sight Glass                  | 998-0002-04 |
| Suction Screen               | 013-0038-00 |
| Cylinder Head Gasket         | 020-0954-00 |
| Stator Cover Gasket          | 020-0054-00 |
| Bottom Plate Gasket          | 020-0159-00 |
| Terminal Plate Gasket        | 020-0146-00 |
| Housing Cover Gasket         | 020-0749-00 |
| Suction Valve Adapter Gasket | 020-0330-00 |
| Suction Valve Gasket         | 020-0012-11 |
| Discharge Valve Gasket       | 020-0012-10 |
| Mounting Assembly            | 527-0007-00 |
| Cooling Fan Kits             | Part Number |
| 120V w/Complete Fan Guard    | 998-0550-02 |
| 240V w/Complete Fan Guard    | 998-0550-00 |
| 460V w/Complete Fan Guard    | 998-0550-01 |
| Mounting Kit w/Studs         | 998-0574-00 |
| Crankcase Heater             | Part Number |
| Bolt On 120 Volt 65 Watt     | 918-0009-00 |
| Bolt On 240 Volt 65 Watt     | 918-0009-01 |

## Three Phase Only

| Common Parts      | Part Number |
|-------------------|-------------|
| Terminal Fusite   | 521-0017-00 |
| Terminal Fusite   | 521-0018-00 |
| Fusite Seal       | 020-0844-02 |
| Connector T Block | 021-0227-02 |

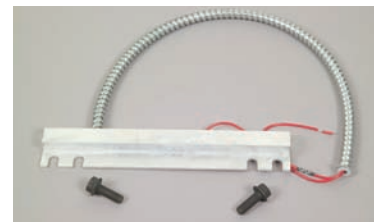

## LA - Compressor Parts

| Model         | Valve Plate Kit | Complete Gasket Kit | Valve Plate Gasket | Start Capacitor |         | Run Capacitor |         | Relay   |         | Protector | Terminal Board Assembly | Terminal Insulator Assembly |
|---------------|-----------------|---------------------|--------------------|-----------------|---------|---------------|---------|---------|---------|-----------|-------------------------|-----------------------------|
|               |                 |                     |                    | OEM             | Service | OEM           | Service | OEM     | Service |           |                         |                             |
|               | (998-)          | (998-)              | (020-)             | (014-)          | (914-)  | (014-)        | (914-)  | (040-)  | (940-)  |           |                         |                             |
| LAC1-0300-TAE | 0661-37         | 0669-19             | 0918-02            |                 |         |               |         |         |         | 0090-14   |                         |                             |
| LAC1-0310-CAB | 0661-37         | 0669-19             | 0918-02            | 0006-13         | 0006-03 | 0064-14       | 0037-18 | 0166-28 | 0001-69 | 0119-01   | 0010-01                 | 0149-00                     |
| LAC1-0310-TAC | 0661-37         | 0669-19             | 0918-02            |                 |         |               |         |         |         | 0090-01   |                         |                             |
| LAC1-0310-TAD | 0661-37         | 0669-19             | 0918-02            |                 |         |               |         |         |         | 0090-03   |                         |                             |
| LACA-032E-TAC | 0661-37         | 0669-19             | 0918-02            |                 |         |               |         |         |         | 0090-47   |                         |                             |
| LACA-032E-TAD | 0661-37         | 0669-19             | 0918-02            |                 |         |               |         |         |         | 0090-45   |                         |                             |
| LACB-032E-CAB | 0661-37         | 0669-19             | 0918-02            | 0006-13         | 0006-03 | 0064-18       | 0037-22 | 0166-28 | 0001-69 | 0119-05   | 0010-01                 | 0149-00                     |
| LAH1-0300-TAE | 0661-37         | 0669-16             | 0918-01            |                 |         |               |         |         |         | 0090-14   |                         |                             |
| LAH1-0310-CAB | 0661-37         | 0669-16             | 0918-01            | 0006-13         | 0006-03 | 0064-12       | 0037-16 | 0166-28 | 0001-69 | 0119-01   | 0010-01                 | 0149-00                     |
| LAH1-0310-TAC | 0661-37         | 0669-16             | 0918-01            |                 |         |               |         |         |         | 0090-19   |                         |                             |
| LAH1-0310-TAD | 0661-37         | 0669-16             | 0918-01            |                 |         |               |         |         |         | 0090-03   |                         |                             |
| LAHA-0310-TAC | 0661-37         | 0669-16             | 0918-01            |                 |         |               |         |         |         | 0090-19   |                         |                             |
| LAHA-0310-TAD | 0661-37         | 0669-16             | 0918-01            |                 |         |               |         |         |         | 0090-03   |                         |                             |
| LAHA-031E-TAC | 0661-37         | 0669-16             | 0918-01            |                 |         |               |         |         |         | 0090-19   |                         |                             |
| LAHA-032E-TAC | 0661-37         | 0669-16             | 0918-01            |                 |         |               |         |         |         | 0090-47   |                         |                             |
| LAHA-032E-TAD | 0661-37         | 0669-16             | 0918-01            |                 |         |               |         |         |         | 0090-45   |                         |                             |
| LAHA-032E-TAE | 0661-37         | 0669-16             | 0918-01            |                 |         |               |         |         |         | 0090-14   |                         |                             |
| LAHB-0311-CAB | 0661-37         | 0669-16             | 0918-01            | 0006-13         | 0006-03 | 0064-14       | 0037-18 | 0166-28 | 0001-69 | 0119-05   | 0010-01                 | 0149-00                     |
| LAHB-031E-CAB | 0661-37         | 0669-16             | 0918-01            | 0006-13         | 0006-03 | 0064-14       | 0037-18 | 0166-28 | 0001-69 | 0119-05   | 0010-01                 | 0149-00                     |
| LAHB-032E-CAB | 0661-37         | 0669-16             | 0918-01            | 0006-13         | 0006-03 | 0064-18       | 0037-22 | 0166-28 | 0001-69 | 0119-05   | 0010-01                 | 0149-00                     |
| LAL1-0300-TAE | 0661-37         | 0669-18             | 0918-00            |                 |         |               |         |         |         | 0090-14   |                         |                             |
| LAL1-0310-CAB | 0661-37         | 0669-18             | 0918-00            | 0006-13         | 0006-03 | 0064-14       | 0037-18 | 0166-28 | 0001-69 | 0119-01   | 0010-01                 | 0149-00                     |
| LAL1-0310-TAC | 0661-37         | 0669-18             | 0918-00            |                 |         |               |         |         |         | 0090-18   |                         |                             |
| LAL1-0310-TAD | 0661-37         | 0669-18             | 0918-00            |                 |         |               |         |         |         | 0090-03   |                         |                             |
| LALA-032E-TAC | 0661-37         | 0669-18             | 0918-00            |                 |         |               |         |         |         | 0090-47   |                         |                             |
| LALA-032E-TAD | 0661-37         | 0669-18             | 0918-00            |                 |         |               |         |         |         | 0090-46   |                         |                             |
| LALB-032E-CAB | 0661-37         | 0669-18             | 0918-00            | 0006-13         | 0006-03 | 0064-18       | 0037-22 | 0166-28 | 0001-69 | 0119-05   | 0010-01                 | 0149-00                     |
| LAM1-0300-TAE | 0661-37         | 0669-19             | 0918-02            |                 |         |               |         |         |         | 0090-13   |                         |                             |
| LAM1-0310-CAB | 0661-37         | 0669-19             | 0918-02            | 0006-13         | 0006-03 | 0064-12       | 0037-16 | 0166-28 | 0001-69 | 0119-01   | 0010-01                 | 0149-00                     |
| LAM1-0310-TAC | 0661-37         | 0669-19             | 0918-02            |                 |         |               |         |         |         | 0090-01   |                         |                             |
| LAM1-0310-TAD | 0661-37         | 0669-19             | 0918-02            |                 |         |               |         |         |         | 0090-03   |                         |                             |



A yellow warning tag on an L-model compressor indicates that the oil level should be adjusted to 3/4 sight glass with compressor running, due to more bearing stress and larger journal holes.



# M – Semi-Hermetic Compressors

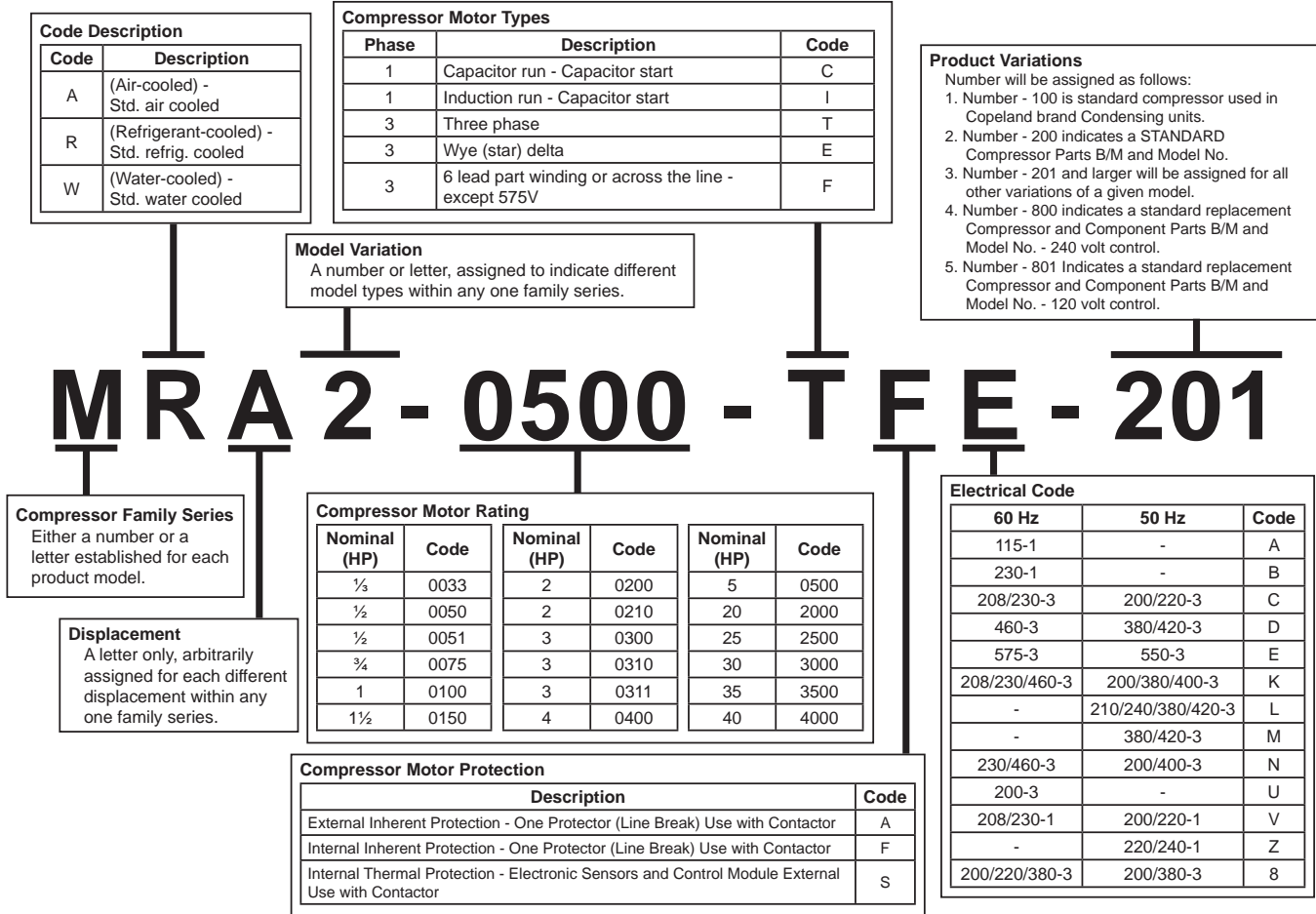

## Common Replacement Parts

| Common Parts                               | Part Number |
|--|-------------|
| Sight Glass                                | 998-0002-02 |
| Oil Pump Kit                               | 998-0008-33 |
| Suction Strainer Screen Kit                | 998-0513-04 |
| Gaskets                                    | Part Number |
| Cylinder Head                              | 020-0604-00 |
| Housing Cover                              | 020-0104-00 |
| Bottom Plate                               | 020-0159-00 |
| Stator Cover                               | 020-0130-00 |
| Terminal Plate                             | 020-0146-00 |
| Oil Pump                                   | 020-1204-00 |
| Suction Service Valve to Compressor Body   | 020-0489-00 |
| Discharge Service Valve to Compressor Body | 020-1224-00 |

| Cooling Fan Kits           | Part Number |
|----------------------------|-------------|
| 120V w/Complete Fan Guard  | 998-0550-02 |
| 240V w/Complete Fan Guard  | 998-0550-00 |
| 460V w/Complete Fan Guard  | 998-0550-01 |
| Mounting Kit w/Studs       | 998-0574-01 |
| Crankcase Heater           | Part Number |
| Bolt On 120 Volt 65 Watt   | 518-0009-00 |
| Bolt On 240 Volt 65 Watt   | 518-0009-01 |
| Sentronic 3 Kits and Parts | Part Number |
| Complete Kit               | 585-1076-02 |
| Sensor and Cable Kit       | 998-0162-00 |
| Sensor Only                | 998-0162-01 |
| Copper Gasket for Sensor   | 020-0297-13 |
| O-Ring Gasket for Sensor   | 020-0003-28 |

## MR - Compressor Parts

| Model         | Valve Plate Kit | Complete Gasket Kit | Valve Plate Gasket | Start Capacitor |         | Run Capacitor |         | Relay   |         | Protector   | Terminal Plate Group | Terminal Fused Cluster |
|---------------|-----------------|---------------------|--------------------|-----------------|---------|---------------|---------|---------|---------|-------------|----------------------|------------------------|
|               | (998-)          | (998-)              | (020-)             | OEM             | Service | OEM           | Service | OEM     | Service |             |                      |                        |
|               | (014-)          | (914-)              | (014-)             | (914-)          | (040-)  | (940-)        |         |         |         |             |                      |                        |
| MRA2-0500-CFB | 0661-23         | 0669-23             | 0103-00            | 0006-14         | 0006-09 | 0064-18       | 0037-22 | 0166-23 | 0001-64 |             | 0144-00              | 0018-00                |
| MRA2-0500-TFC | 0661-23         | 0669-23             | 0103-00            |                 |         |               |         |         |         | 071-0086-38 | 0144-00              | 0018-00                |
| MRA2-0500-TFD | 0661-23         | 0669-23             | 0103-00            |                 |         |               |         |         |         | 998-0086-17 | 0144-00              | 0018-00                |
| MRA2-0500-TFE | 0661-23         | 0669-23             | 0103-00            |                 |         |               |         |         |         | 998-0086-29 | 0144-00              | 0018-00                |
| MRA2-0506-CFB | 0661-23         | 0669-23             | 0103-00            | 0006-14         | 0006-09 | 0064-18       | 0037-22 | 0166-23 | 0001-64 | 998-0476-01 | 0144-00              | 0018-00                |
| MRA2-050A-CFB | 0661-23         | 0669-23             | 0103-00            | 0006-14         | 0006-09 | 0064-18       | 0037-22 | 0166-23 | 0001-64 | 998-0476-01 | 0144-00              | 0018-00                |
| MRA2-050A-TFC | 0661-23         | 0669-23             | 0103-00            |                 |         |               |         |         |         | 071-0086-38 | 0144-00              | 0018-00                |
| MRA2-050A-TFD | 0661-23         | 0669-23             | 0103-00            |                 |         |               |         |         |         | 998-0086-17 | 0144-00              | 0018-00                |
| MRB1-0500-TFC | 0661-50         | 0669-23             | 0103-04            |                 |         |               |         |         |         | 071-0086-38 | 0144-00              | 0018-00                |
| MRB1-0500-TFD | 0661-50         | 0669-23             | 0103-04            |                 |         |               |         |         |         | 998-0086-35 | 0144-00              | 0018-00                |
| MRB1-0500-TFE | 0661-50         | 0669-23             | 0103-04            |                 |         |               |         |         |         | 998-0086-36 | 0144-00              | 0018-00                |
| MRB1-050A-TFC | 0661-50         | 0669-23             | 0103-04            |                 |         |               |         |         |         | 071-0086-38 | 0144-00              | 0018-00                |
| MRB1-050A-TFD | 0661-50         | 0669-23             | 0103-04            |                 |         |               |         |         |         | 998-0086-35 | 0144-00              | 0018-00                |
| MRC1-0500-TFC | 0661-54         | 0669-23             | 0103-04            |                 |         |               |         |         |         | 071-0086-38 | 0144-00              | 0018-00                |
| MRC1-0500-TFD | 0661-54         | 0669-23             | 0103-04            |                 |         |               |         |         |         | 998-0086-35 | 0144-00              | 0018-00                |
| MRF2-0500-CFB | 0661-17         | 0669-23             | 0103-00            | 0006-14         | 0006-09 | 0064-18       | 0037-22 | 0166-23 | 0001-64 |             | 0144-00              | 0018-00                |
| MRF2-0500-TFC | 0661-17         | 0669-23             | 0103-00            |                 |         |               |         |         |         | 071-0086-38 | 0144-00              | 0018-00                |
| MRF2-0500-TFD | 0661-17         | 0669-23             | 0103-00            |                 |         |               |         |         |         | 998-0086-17 | 0144-00              | 0018-00                |
| MRF2-0500-TFE | 0661-17         | 0669-23             | 0103-00            |                 |         |               |         |         |         | 998-0086-29 | 0144-00              | 0018-00                |
| MRF2-0506-CFB | 0661-17         | 0669-23             | 0103-00            | 0006-14         | 0006-09 | 0064-18       | 0037-22 | 0166-23 | 0001-64 | 998-0476-01 | 0144-00              | 0018-00                |
| MRF2-050A-CFB | 0661-17         | 0669-23             | 0103-00            | 0006-14         | 0006-09 | 0064-18       | 0037-22 | 0166-23 | 0001-64 | 998-0476-01 | 0144-00              | 0018-00                |
| MRF2-050A-TFC | 0661-17         | 0669-23             | 0103-00            |                 |         |               |         |         |         | 071-0086-38 | 0144-00              | 0018-00                |
| MRF2-050A-TFD | 0661-17         | 0669-23             | 0103-00            |                 |         |               |         |         |         | 998-0086-17 | 0144-00              | 0018-00                |
| MRH4-0760-TFC | 0661-17         | 0669-52             | 0103-02            |                 |         |               |         |         |         | 998-0086-21 | 0144-00              | 0018-00                |
| MRH4-0760-TFD | 0661-17         | 0669-52             | 0103-02            |                 |         |               |         |         |         | 998-0086-20 | 0144-00              | 0018-00                |
| MRH4-0760-TFE | 0661-17         | 0669-52             | 0103-02            |                 |         |               |         |         |         | 998-0086-40 | 0144-00              | 0018-00                |
| MRH4-076A-TFC | 0661-17         | 0669-52             | 0103-02            |                 |         |               |         |         |         | 998-0086-21 | 0144-00              | 0018-00                |
| MRH4-076A-TFD | 0661-17         | 0669-52             | 0103-02            |                 |         |               |         |         |         | 998-0086-20 | 0144-00              | 0018-00                |



# N – Semi-Hermetic Compressors

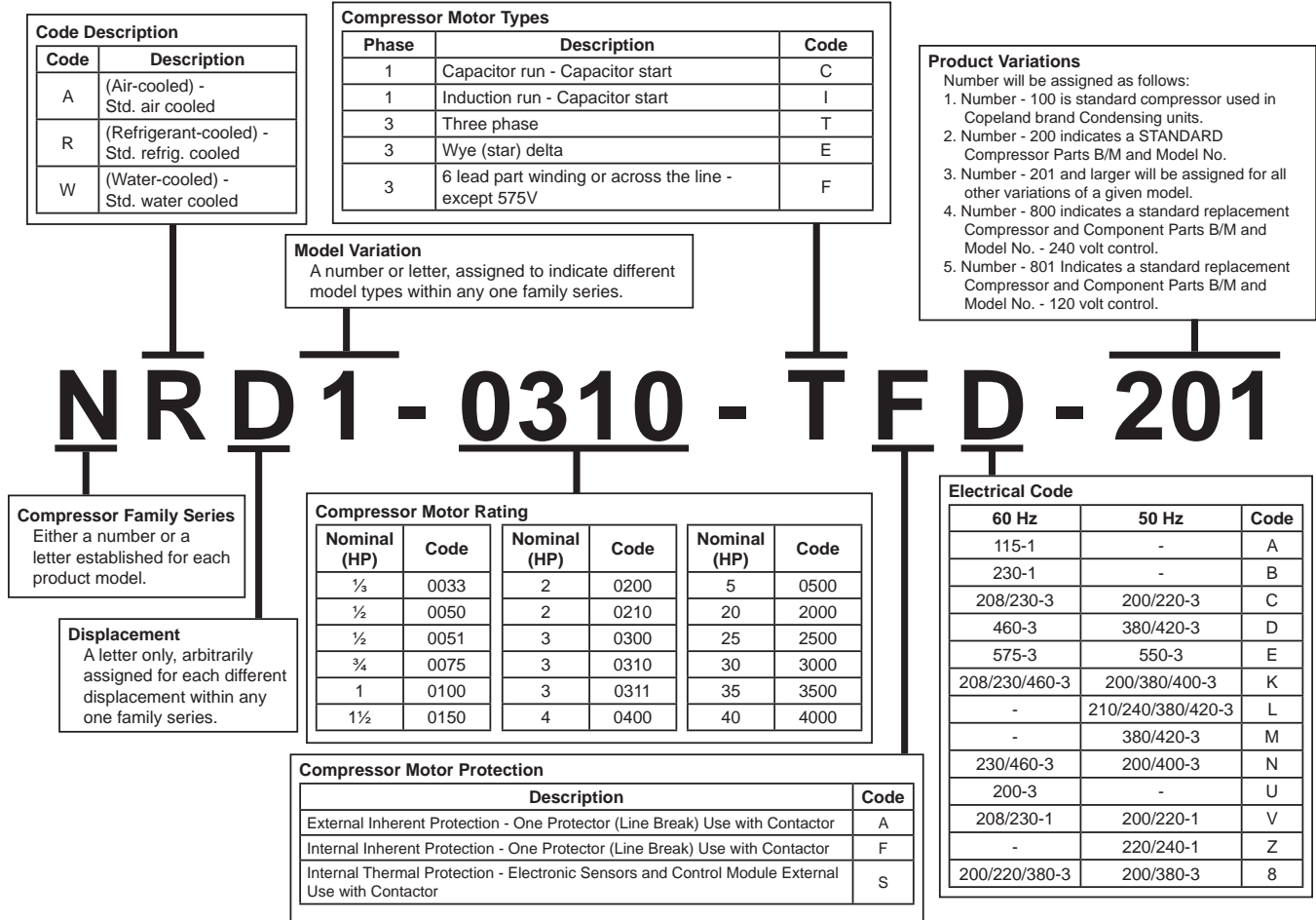

## Common Replacement Parts

| Common Parts                                  | Part Number |
|---|-------------|
| Sight Glass Kit                               | 998-0002-02 |
| Oil Pump Kit                                  | 998-0008-33 |
| Suction Screen                                | 013-0010-00 |
| Terminal Fused Cluster (Fusite)               | 521-0018-00 |
| Terminal Fused Seal (Fusite)                  | 020-0844-02 |
| Gaskets                                       | Part Number |
| Cylinder Head                                 | 020-0954-00 |
| Housing Cover                                 | 020-0749-00 |
| Bottom Plate                                  | 020-0159-00 |
| Stator Cover                                  | 020-0054-00 |
| Terminal Plate Gasket                         | 020-0146-00 |
| Oil Pump Gasket                               | 020-1204-00 |
| Suction or Discharge Valve to Compressor Body | 020-1224-00 |

| Cooling Fan Kits           | Part Number |
|----------------------------|-------------|
| 120V w/Complete Fan Guard  | 998-0550-02 |
| 240V w/Complete Fan Guard  | 998-0550-00 |
| 460V w/Complete Fan Guard  | 998-0550-01 |
| Mounting Kit w/Studs       | 998-0574-02 |
| Crankcase Heater           | Part Number |
| 120 Volt 65 Watt           | 918-0009-00 |
| 240 Volt 65 Watt           | 918-0009-01 |
| Sentronic 3 Kits and Parts | Part Number |
| Complete Kit               | 585-1076-02 |
| Sensor and Cable Kit       | 998-0162-00 |
| Sensor Only                | 998-0162-01 |
| Copper Gasket for Sensor   | 020-0297-13 |
| O-Ring Gasket for Sensor   | 020-0003-28 |

## NR - Compressor Parts

| Model         | Valve Plate Kit | Complete Gasket Kit | Valve Plate Gasket | Start Capacitor |         | Run Capacitor |         | Relay   |         | Protector   | Terminal Insulator Assembly |
|---------------|-----------------|---------------------|--------------------|-----------------|---------|---------------|---------|---------|---------|-------------|-----------------------------|
|               |                 |                     |                    | OEM             | Service | OEM           | Service | OEM     | Service |             |                             |
|               | (998-)          | (998-)              | (020-)             | (014-)          | (914-)  | (014-)        | (914-)  | (040-)  | (940-)  |             |                             |
| NRA2-0500-CFB | 0661-58         | 0669-49             | 0918-04            | 0006-14         | 0006-09 | 0064-22       | 0037-26 | 0166-20 | 0001-61 |             | 0018-00                     |
| NRA2-0500-TFC | 0661-58         | 0669-49             | 0918-04            |                 |         |               |         |         |         | 998-0086-39 | 0018-00                     |
| NRA2-0500-TFD | 0661-58         | 0669-49             | 0918-04            |                 |         |               |         |         |         | 998-0086-14 | 0018-00                     |
| NRA2-0500-TFE | 0661-58         | 0669-49             | 0918-04            |                 |         |               |         |         |         | 998-0086-17 | 0018-00                     |
| NRB2-0310-CFB | 0661-58         | 0669-49             | 0918-03            | 0006-13         | 0006-03 | 0064-12       | 0037-16 | 0166-28 | 0001-69 | 071-0128-00 | 0018-00                     |
| NRB2-0310-TFC | 0661-58         | 0669-49             | 0918-03            |                 |         |               |         |         |         | 998-0086-11 | 0018-00                     |
| NRB2-0310-TFD | 0661-58         | 0669-49             | 0918-03            |                 |         |               |         |         |         | 998-0086-37 | 0018-00                     |
| NRB2-0400-CFB | 0661-58         | 0669-49             | 0918-03            | 0006-13         | 0006-03 | 0064-11       | 0037-15 | 0166-30 | 0001-71 |             | 0018-00                     |
| NRB2-0400-TFC | 0661-58         | 0669-49             | 0918-03            |                 |         |               |         |         |         | 998-0086-39 | 0018-00                     |
| NRB2-0400-TFD | 0661-58         | 0669-49             | 0918-03            |                 |         |               |         |         |         | 998-0086-14 | 0018-00                     |
| NRB2-0400-TFE | 0661-58         | 0669-49             | 0918-03            |                 |         |               |         |         |         | 998-0086-17 | 0018-00                     |
| NRD1-0310-TFC | 0661-59         | 0669-49             | 0918-02            |                 |         |               |         |         |         | 998-0086-11 | 0018-00                     |
| NRD1-0310-TFD | 0661-59         | 0669-49             | 0918-02            |                 |         |               |         |         |         | 998-0086-37 | 0018-00                     |
| NRD1-0310-TFE | 0661-59         | 0669-49             | 0918-02            |                 |         |               |         |         |         | 998-0429-09 | 0018-00                     |
| NRD1-032E-TFC | 0661-59         | 0669-49             | 0918-02            |                 |         |               |         |         |         | 071-0429-30 | 0018-00                     |
| NRD1-0400-CFB | 0661-59         | 0669-49             | 0918-02            | 0006-14         | 0006-09 | 0064-14       | 0037-18 | 0166-28 | 0001-69 | 998-0476-01 | 0018-00                     |
| NRD1-0406-CFB | 0661-59         | 0669-49             | 0918-02            | 0006-14         | 0006-09 | 0064-14       | 0037-18 | 0166-28 | 0001-69 | 998-0476-01 | 0018-00                     |
| NRD1-040E-CFB | 0661-59         | 0669-49             | 0918-02            | 0006-14         | 0006-09 | 0064-14       | 0037-18 | 0166-28 | 0001-69 | 998-0476-01 | 0018-00                     |
| NRM1-0500-CFB | 0661-58         | 0669-49             | 0918-01            | 0006-14         | 0006-09 | 0064-22       | 0037-26 | 0166-20 | 0001-61 |             | 0018-00                     |
| NRM1-0500-TFC | 0661-58         | 0669-49             | 0918-01            |                 |         |               |         |         |         | 998-0086-39 | 0018-00                     |
| NRM1-0500-TFD | 0661-58         | 0669-49             | 0918-01            |                 |         |               |         |         |         | 998-0086-14 | 0018-00                     |
| NRM1-0500-TFE | 0661-58         | 0669-49             | 0918-01            |                 |         |               |         |         |         | 998-0086-17 | 0018-00                     |
| NRN2-0310-CFB | 0661-37         | 0669-49             | 0918-01            | 0006-14         | 0006-09 | 0064-12       | 0037-16 | 0166-28 | 0001-69 | 071-0128-00 | 0018-00                     |
| NRN2-0310-TFC | 0661-37         | 0669-49             | 0918-01            |                 |         |               |         |         |         | 998-0086-11 | 0018-00                     |
| NRN2-0310-TFD | 0661-37         | 0669-49             | 0918-01            |                 |         |               |         |         |         | 998-0086-37 | 0018-00                     |

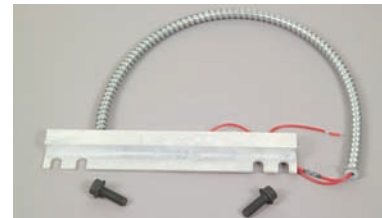
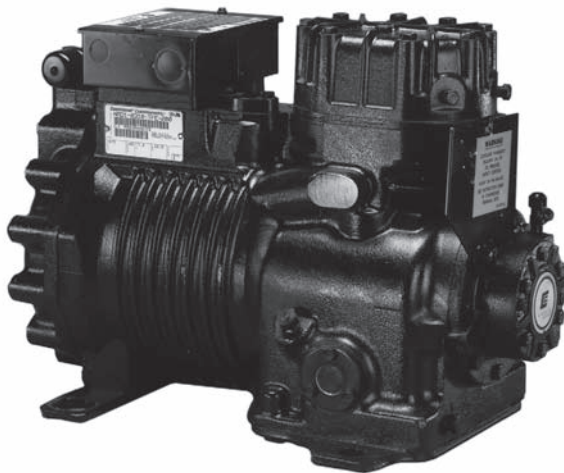

# 2D – Semi-Hermetic Compressors

| Compressor Cooling |                    |
|--------------------|--------------------|
| Code               | Description        |
| A                  | Air cooled         |
| D                  | Discus             |
| R                  | Refrigerant cooled |
| T                  | Std. two stage     |
| W                  | Water cooled       |

| Comp. Motor Rating Nominal |      |              |      |    |      |
|----------------------------|------|--------------|------|----|------|
| HP                         | Code | HP           | Code | HP | Code |
| 1/4                        | 0025 | 2-3/4        | 0275 | 15 | 1500 |
| 1/3                        | 0033 | 3 (0310)     | 0300 | 20 | 2000 |
| 1/2                        | 0050 | 3-1/2        | 0350 | 25 | 2500 |
| 3/4                        | 0075 | 4 (0406)     | 0400 | 30 | 3000 |
| 1                          | 0100 | 5 (0506)     | 0500 | 35 | 3500 |
| 1-1/4                      | 0125 | 6            | 0600 | 40 | 4000 |
| 1-1/2                      | 0150 | 7-1/2 (0766) | 0750 | 50 | 5000 |
| 1-3/4                      | 0175 | 9            | 0900 | 60 | 6000 |
| 2                          | 0200 | 10 (1015)    | 1000 |    |      |
| 2-1/2                      | 0250 | 12           | 1200 |    |      |

| Compressor Motor Type                       |      |
|---|------|
| Single Phase Motors                         | Code |
| Capacitor run - Capacitor start             | C    |
| Induction run - Capacitor start             | I    |
| Induction run - Split phase                 | S    |
| Induction run - Capacitor start, low torque | X    |
| Three Phase Motors                          | Code |
| General                                     | T    |
| 3 Lead single voltage                       |      |
| 6 Lead part winding (575 volt)              |      |
| 9 Lead dual voltage                         |      |
| Star (wye) delta                            | E    |
| 6 Lead motors                               | F    |
| Part winding or across the line             |      |

**Product Variations**  
Numbers will be assigned as follows:

- Numbers -001 through -199 are reserved for sub+b/m numbers.
- Numbers -200 indicates a standard compressor and component parts b/m and model no.
- Numbers -201 and larger will be assigned for all other variations of a given model.

**Tandem Style Models**  
Indicated by the digit representing the comp. model series connected in tandem with a comp. of the model series indicated by the first digit.

May be = (-) or A

Note: Nominal horsepower rating of tandem compressors is sum of individual compressor ratings

## 2DA3 - 0750 - TFE 800

| Compressor Family Series   |
|--|
| Either a number or a letter established for each product family. |

| Displacement and Valve Plate  |
|---|
| A letter only, arbitrarily assigned for each different displacement within any one family series. |

| Model Variation  |
|--|
| A number or letter, assigned to indicate different model types within any family series. |

| May also be          |
|----------------------|
| "A" = (Alkylbenzene) |
| "E" = (POE Oil)      |
| "L" = (Less Oil)     |

| Compressor Motor Protection  |      |
|--|------|
| Description  | Code |
| External inherent protection - one protector (line break) use with contactor   | A    |
| Internal inherent protection - one protector use with contactor  | F    |
| Internal thermostat(s); and ext, supplementary protector(s) use with contactor.  | H    |
| Internal thermostat(s); and three ext, supplementary protector(s) use with contactor.                                      | L    |
| Internal thermal protectors - electronic sensors; and control module external. Use with contactor.                         | S    |
| Internal thermal protectors - electronic sensors; and control module external. use with contactor (For European use only). | W    |

| Electrical Codes |               |      |                    |           |      |
|------------------|---------------|------|--------------------|-----------|------|
| 60 Hz            | 50 Hz         | Code | 60 Hz              | 50 Hz     | Code |
| 115-1            | 100-1         | A    | -                  | 220-1     | S    |
| 230-1            | 200-1         | B    | -                  | 200-1     | T    |
| 5206-230-3       | 200/220-3     | C    | 200-3              | -         | U    |
| 460-3            | 380/400-3     | D    | 208-230-1          | 200-1     | V    |
| 575-3            | 500-3         | E    | -                  | 200/220-3 | W    |
| -                | 115-1         | F    | Misc. A.C. Ratings | X         |      |
| -                | 230-1         | G    | -                  | 500-3     | Y    |
| 208-1            | 200-1         | H    | -                  | 220/240-1 | Z    |
| -                | 208/230-1     | I    | 200-1              | 200-1     | 3    |
| 208/230/460-3    | 200/400-3     | K    | 100-1              | 100-1     | 4    |
| -                | 210/240/380-3 | L    | 200-230-3          | -         | 5    |
| -                | 380-/420-3    | M    | 230-3              | -         | 6    |
| 230/460-3        | 200/400-3     | N    | 380                | 346       | 7    |
| -                | 200/380-3     | P    | 200/220/380        | 200/345   | 8    |
| -                | 200/240-3     | R    |                    |           |      |

\* When applicable, specific 50 HZ ratings (Not necessarily identical to typical shown above) will be shown as alternate on 60 HZ rated models.

# Semi-Hermetic Compressors – 2D

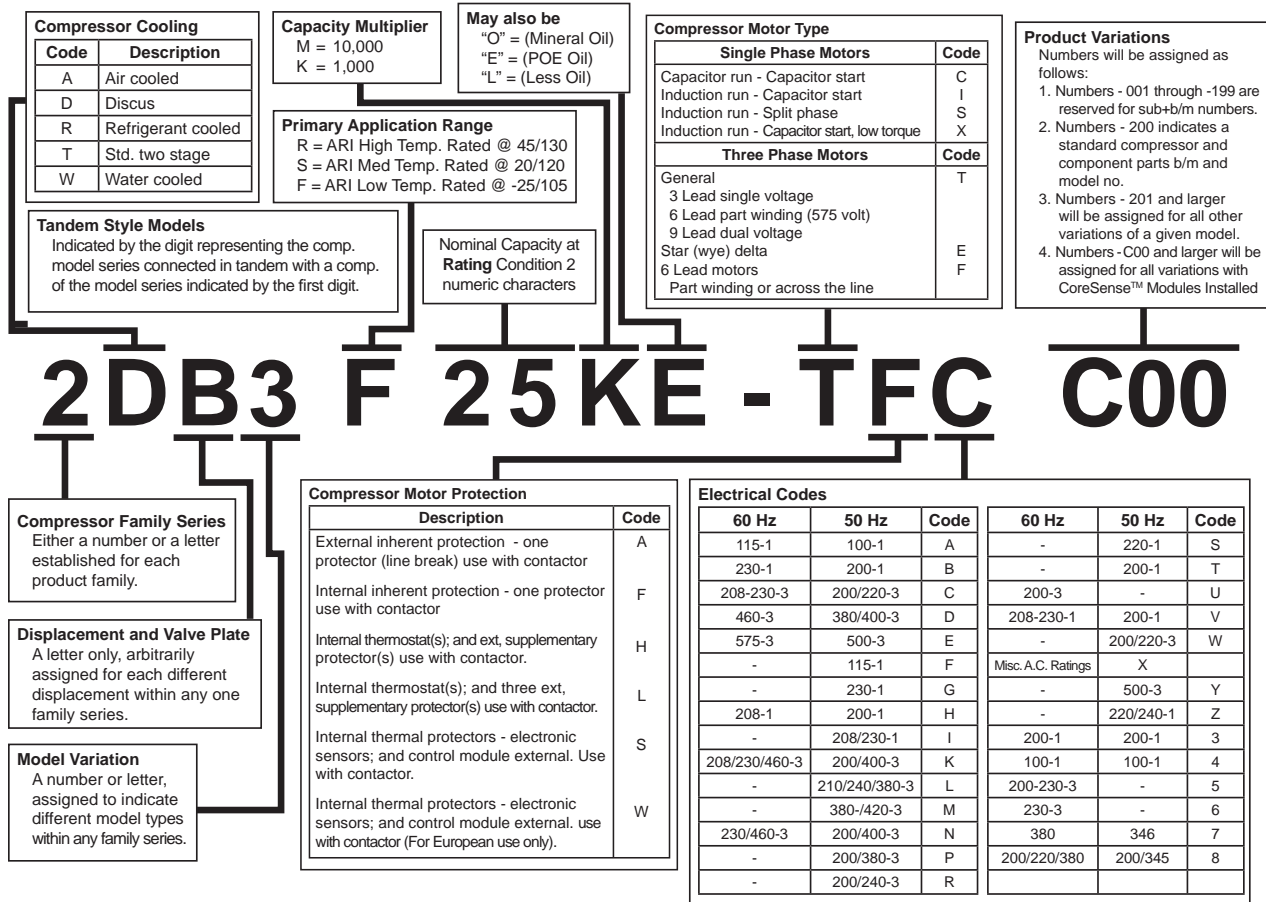



## 2D – Semi-Hermetic Compressors

### Common Replacement Parts

| Common Parts                | Part Number |
|-----------------------------|-------------|
| Sight Glass Kit             | 998-0002-02 |
| Sight Glass O-Ring          | 020-0844-05 |
| Oil Check Valve Assembly    | 510-0142-00 |
| Oil Screen Kit              | 998-0513-03 |
| Oil Pump Kit                | 998-0008-33 |
| Terminal Fused Cluster      | 521-0018-00 |
| Terminal Fused Cluster Seal | 020-0844-02 |
| Gaskets                     | Part Number |
| Cylinder Head               | 020-0756-00 |
| Housing Cover               | 020-0104-00 |
| Stator Cover                | 020-0709-00 |
| Bottom Plate                | 020-1201-00 |
| Oil Pump                    | 020-1204-00 |
| Gasket Kit (Complete)       | 998-1669-06 |
| Crankcase Heater            | Part Number |
| 120 Volt 100 Watt           | 518-0028-06 |
| 240 Volt 100 Watt           | 518-0028-07 |
| Crankcase Heater Well       | 030-0187-01 |
| CoreSense™ Parts            | Part Number |
| CoreSense Module            | 943-0109-00 |
| 2D CoreSense Wiring Harness | 929-0097-00 |
| CoreSense DLT Thermistor    | 085-0109-00 |
| Current Sensor Kit          | 943-0064-00 |
| Sensor Only                 | 998-0162-01 |
| Copper Gasket for Sensor    | 020-0297-13 |
| O-Ring Gasket for Sensor    | 020-0003-28 |



| Rotalock Adaptor Pad         | Part Number |
|------------------------------|-------------|
| Adaptor Pad to Rotalock Kit  | 998-0036-02 |
| Adaptor Pad                  | 036-0505-00 |
| Suction Valve Seal           | 020-0028-02 |
| Service Valve Gasket         | 020-0012-11 |
| Bolts                        | 100-0172-00 |
| Demand Cooling               | Part Number |
| Demand Cooling Kit- 120 Volt | 998-1000-12 |
| Demand Cooling Kit- 240 Volt | 998-1000-22 |
| 120 Volt Control Only        | 085-0110-00 |
| 240 Volt Control Only        | 085-0110-01 |
| Sensor Only                  | 085-0109-00 |
| Cooling Fan Kits             | Part Number |
| 120V w/Bottom Fan Guard      | 998-0550-05 |
| 120V w/Complete Fan Guard    | 998-0550-02 |
| 240V w/Bottom Fan Guard      | 998-0550-03 |
| 240V w/Complete Fan Guard    | 998-0550-00 |
| 460V w/Bottom Fan Guard      | 998-0550-04 |
| 460V w/Complete Fan Guard    | 998-0550-01 |
| Mounting Kit w/Studs         | 998-0574-11 |
| Fan Blade                    | 083-0118-00 |
| Top Guard                    | 024-0200-00 |
| Sentronic 3 Kits and Parts   | Part Number |
| Complete Kit                 | 585-1076-02 |
| Sensor and Cable Kit         | 998-0162-00 |
| Sensor Only                  | 998-0162-01 |
| Copper Gasket for Sensor     | 020-0297-13 |
| O-Ring Gasket for Sensor     | 020-0003-28 |



## 2D - Compressor Parts

| Model<br>HP<br>Nomenclature | Model<br>BTU<br>Nomenclature | Valve<br>Plate<br>Kit<br>(998-) | Valve<br>Plate<br>Gasket<br>(020-) | Start Capacitor |         | Run Capacitor |         | Relay   |         | Motor<br>Protector<br>Kit<br>(998-) | Terminal<br>Plate<br>Assembly<br>(521-) |
|-----------------------------|------------------------------|---------------------------------|------------------------------------|-----------------|---------|---------------|---------|---------|---------|-------------------------------------|---|
|                             |                              |                                 |                                    | OEM             | Service | OEM           | Service | OEM     | Service |                                     |   |
|                             |                              |                                 |                                    | (014-)          | (914-)  | (014-)        | (914-)  | (040-)  | (940-)  |                                     |   |
| 2DA3-0500-TFC               | 2DA3R58K0-TFC                | 1661-29                         | 0757-05                            |                 |         |               |         |         |         | 0429-02                             | 0144-00                                 |
| 2DA3-0500-TFD               | 2DA3R58K0-TFD                | 1661-29                         | 0757-05                            |                 |         |               |         |         |         | 0429-10                             | 0144-00                                 |
| 2DA3-0500-TFE               | 2DA3R58K0-TFE                | 1661-29                         | 0757-05                            |                 |         |               |         |         |         | 0429-23                             | 0144-00                                 |
| 2DA3-0600-TFC               | 2DA3F23K0-TFC                | 1661-29                         | 0757-05                            |                 |         |               |         |         |         | 0429-08                             | 0144-00                                 |
| 2DA3-0600-TFD               | 2DA3F23K0-TFD                | 1661-29                         | 0757-05                            |                 |         |               |         |         |         | 0429-10                             | 0144-00                                 |
| 2DA3-0600-TFE               | 2DA3F23K0-TFE                | 1661-29                         | 0757-05                            |                 |         |               |         |         |         | 0429-18                             | 0144-00                                 |
| 2DA3-060E-TFC               | 2DA3F23KE-TFC                | 1661-29                         | 0757-05                            |                 |         |               |         |         |         | 0429-08                             | 0144-00                                 |
| 2DA3-060E-TFD               | 2DA3F23KE-TFD                | 1661-29                         | 0757-05                            |                 |         |               |         |         |         | 0429-10                             | 0144-00                                 |
| 2DA3-060E-TFE               | 2DA3F23KE-TFE                | 1661-29                         | 0757-05                            |                 |         |               |         |         |         | 0429-18                             | 0144-00                                 |
| 2DA3-0750-TFC               | 2DA3R89K0-TFC                | 1661-23                         | 0757-05                            |                 |         |               |         |         |         | 0429-08                             | 0144-00                                 |
| 2DA3-0750-TFD               | 2DA3R89K0-TFD                | 1661-23                         | 0757-05                            |                 |         |               |         |         |         | 0429-05                             | 0144-00                                 |
| 2DA3-0750-TFE               | 2DA3R89K0-TFE                | 1661-23                         | 0757-05                            |                 |         |               |         |         |         | 0429-25                             | 0144-00                                 |
| 2DA3-075E-TFC               | 2DA3R89KE-TFC                | 1661-23                         | 0757-05                            |                 |         |               |         |         |         | 0429-08                             | 0144-00                                 |
| 2DA3-075E-TFD               | 2DA3R89KE-TFD                | 1661-23                         | 0757-05                            |                 |         |               |         |         |         | 0429-05                             | 0144-00                                 |
| 2DA3-075E-TFE               | 2DA3R89KE-TFE                | 1661-23                         | 0757-05                            |                 |         |               |         |         |         | 0429-25                             | 0144-00                                 |
| 2DB3-0490-TFC               | N/A                          | 1661-29                         | 0757-01                            |                 |         |               |         |         |         | 0429-08                             | 0144-00                                 |
| 2DB3-0500-TFC               | 2DB3F25K0-TFC                | 1661-29                         | 0757-01                            |                 |         |               |         |         |         | 0429-02                             | 0144-00                                 |
| 2DB3-0500-TFD               | 2DB3F25K0-TFD                | 1661-29                         | 0757-01                            |                 |         |               |         |         |         | 0429-10                             | 0144-00                                 |
| 2DB3-0500-TFE               | 2DB3F25K0-TFE                | 1661-29                         | 0757-01                            |                 |         |               |         |         |         | 0429-23                             | 0144-00                                 |
| 2DB3-0600-TFC               | 2DB3F25K0-TFC                | 1661-29                         | 0757-01                            |                 |         |               |         |         |         | 0429-08                             | 0144-00                                 |
| 2DB3-0600-TFD               | 2DB3F25K0-TFD                | 1661-29                         | 0757-01                            |                 |         |               |         |         |         | 0429-05                             | 0144-00                                 |
| 2DB3-0600-TFE               | 2DB3F25K0-TFE                | 1661-29                         | 0757-01                            |                 |         |               |         |         |         | 0429-26                             | 0144-00                                 |
| 2DB3-060E-TFC               | 2DB3F25KE-TFC                | 1661-29                         | 0757-01                            |                 |         |               |         |         |         | 0429-08                             | 0144-00                                 |
| 2DB3-060E-TFD               | 2DB3F25KE-TFD                | 1661-29                         | 0757-01                            |                 |         |               |         |         |         | 0429-05                             | 0144-00                                 |
| 2DB3-060E-TFE               | 2DB3F25KE-TFE                | 1661-29                         | 0757-01                            |                 |         |               |         |         |         | 0429-26                             | 0144-00                                 |
| 2DC3-0500-CFB               | 2DC3R53K0-CFB                | 1661-23                         | 0757-03                            | 0006-09         | 0006-09 | 0064-18       | 0037-22 | 0166-23 | 0001-64 | 0476-01                             | 0144-00                                 |
| 2DC3-0500-TFC               | 2DC3R53K0-TFC                | 1661-23                         | 0757-03                            |                 |         |               |         |         |         | 0429-13                             | 0144-00                                 |
| 2DC3-0500-TFD               | 2DC3R53K0-TFD                | 1661-23                         | 0757-03                            |                 |         |               |         |         |         | 0429-10                             | 0144-00                                 |
| 2DC3-0500-TFE               | 2DC3R53K0-TFE                | 1661-23                         | 0757-03                            |                 |         |               |         |         |         | 0429-23                             | 0144-00                                 |
| 2DC3-050E-TFC               | 2DC3R53KE-TFC                | 1661-23                         | 0757-03                            |                 |         |               |         |         |         | 0429-13                             | 0144-00                                 |
| 2DC3-050E-TFD               | 2DC3R53KE-TFD                | 1661-23                         | 0757-03                            |                 |         |               |         |         |         | 0429-10                             | 0144-00                                 |
| 2DC3-050E-TFE               | 2DC3R53KE-TFE                | 1661-23                         | 0757-03                            |                 |         |               |         |         |         | 0429-23                             | 0144-00                                 |
| 2DD3-0500-TFC               | 2DD3R63K0-TFC                | 1661-23                         | 0757-03                            |                 |         |               |         |         |         | 0429-24                             | 0144-00                                 |
| 2DD3-0500-TFD               | 2DD3R63K0-TFD                | 1661-23                         | 0757-03                            |                 |         |               |         |         |         | 0429-10                             | 0144-00                                 |
| 2DD3-0500-TFE               | 2DD3R63K0-TFE                | 1661-23                         | 0757-03                            |                 |         |               |         |         |         | 0429-23                             | 0144-00                                 |
| 2DD3-050E-TFC               | 2DD3R63KE-TFC                | 1661-23                         | 0757-03                            |                 |         |               |         |         |         | 0429-24                             | 0144-00                                 |
| 2DD3-050E-TFD               | 2DD3R63KE-TFD                | 1661-23                         | 0757-03                            |                 |         |               |         |         |         | 0429-10                             | 0144-00                                 |
| 2DD3-050E-TFE               | 2DD3R63KE-TFE                | 1661-23                         | 0757-03                            |                 |         |               |         |         |         | 0429-23                             | 0144-00                                 |

# 2D – Semi-Hermetic Compressors

## 2D - Compressor Parts

| Model<br>HP<br>Nomenclature | Model<br>BTU<br>Nomenclature | Valve<br>Plate<br>Kit<br>(998-) | Valve<br>Plate<br>Gasket<br>(020-) | Start Capacitor |         | Run Capacitor |         | Relay   |         | Motor<br>Protector<br>Kit<br>(998-) | Terminal<br>Plate<br>Assembly<br>(521-) |
|-----------------------------|------------------------------|---------------------------------|------------------------------------|-----------------|---------|---------------|---------|---------|---------|-------------------------------------|---|
|                             |                              |                                 |                                    | OEM             | Service | OEM           | Service | OEM     | Service |                                     |   |
|                             |                              |                                 |                                    | (014-)          | (914-)  | (014-)        | (914-)  | (040-)  | (940-)  |                                     |   |
| 2DF3-0300-CFB               | 2DF3F16K0-CFB                | 1661-29                         | 0757-01                            | 0006-09         | 0006-09 | 0064-18       | 0037-22 | 0166-23 | 0001-64 | 0476-01                             | 0144-00                                 |
| 2DF3-0300-TFC               | 2DF3F16K0-TFC                | 1661-29                         | 0757-01                            |                 |         |               |         |         |         | 0429-22                             | 0144-00                                 |
| 2DF3-0300-TFD               | 2DF3F16K0-TFD                | 1661-29                         | 0757-01                            |                 |         |               |         |         |         | 0429-23                             | 0144-00                                 |
| 2DF3-0300-TFE               | 2DF3F16K0-TFE                | 1661-29                         | 0757-01                            |                 |         |               |         |         |         | 0429-27                             | 0144-00                                 |
| 2DF3-030E-CFB               | 2DF3F16KE-CFB                | 1661-29                         | 0757-01                            | 0006-09         | 0006-09 | 0064-18       | 0037-22 | 0166-23 | 0001-64 | 0476-01                             | 0144-00                                 |
| 2DF3-030E-TFC               | 2DF3F16KE-TFC                | 1661-29                         | 0757-01                            |                 |         |               |         |         |         | 0429-22                             | 0144-00                                 |
| 2DF3-030E-TFD               | 2DF3F16KE-TFD                | 1661-29                         | 0757-01                            |                 |         |               |         |         |         | 0429-23                             | 0144-00                                 |
| 2DF3-030E-TFE               | 2DF3F16KE-TFE                | 1661-29                         | 0757-01                            |                 |         |               |         |         |         | 0429-27                             | 0144-00                                 |
| 2DL3-0400-TFC               | 2DL3F20K0-TFC                | 1661-29                         | 0757-03                            |                 |         |               |         |         |         | 0429-08                             | 0144-00                                 |
| 2DL3-0400-TFD               | 2DL3F20K0-TFD                | 1661-29                         | 0757-03                            |                 |         |               |         |         |         | 0429-10                             | 0144-00                                 |
| 2DL3-0400-TFE               | 2DL3F20KE-TFE                | 1661-29                         | 0757-03                            |                 |         |               |         |         |         | 0429-23                             | 0144-00                                 |
| 2DL3-040E-TFC               | 2DL3F20KE-TFC                | 1661-29                         | 0757-03                            |                 |         |               |         |         |         | 0429-08                             | 0144-00                                 |
| 2DL3-040E-TFD               | 2DL3F20KE-TFD                | 1661-29                         | 0757-03                            |                 |         |               |         |         |         | 0429-10                             | 0144-00                                 |
| 2DL3-040E-TFE               | 2DL3F20KE-TFE                | 1661-29                         | 0757-03                            |                 |         |               |         |         |         | 0429-23                             | 0144-00                                 |
| 2DL3-0750-TFC               | 2DL3R78K0-TFC                | 1661-23                         | 0757-03                            |                 |         |               |         |         |         | 0429-08                             | 0144-00                                 |
| 2DL3-0750-TFD               | 2DL3R78K0-TFD                | 1661-23                         | 0757-03                            |                 |         |               |         |         |         | 0429-05                             | 0144-00                                 |
| 2DL3-0750-TFE               | 2DL3R78K0-TFE                | 1661-23                         | 0757-03                            |                 |         |               |         |         |         | 0429-25                             | 0144-00                                 |
| 2DL3-075E-TFC               | 2DL3R78KE-TFC                | 1661-23                         | 0757-03                            |                 |         |               |         |         |         | 0429-08                             | 0144-00                                 |
| 2DL3-075E-TFD               | 2DL3R78KE-TFD                | 1661-23                         | 0757-03                            |                 |         |               |         |         |         | 0429-05                             | 0144-00                                 |
| 2DL3-075E-TFE               | 2DL3R78KE-TFE                | 1661-23                         | 0757-03                            |                 |         |               |         |         |         | 0429-25                             | 0144-00                                 |

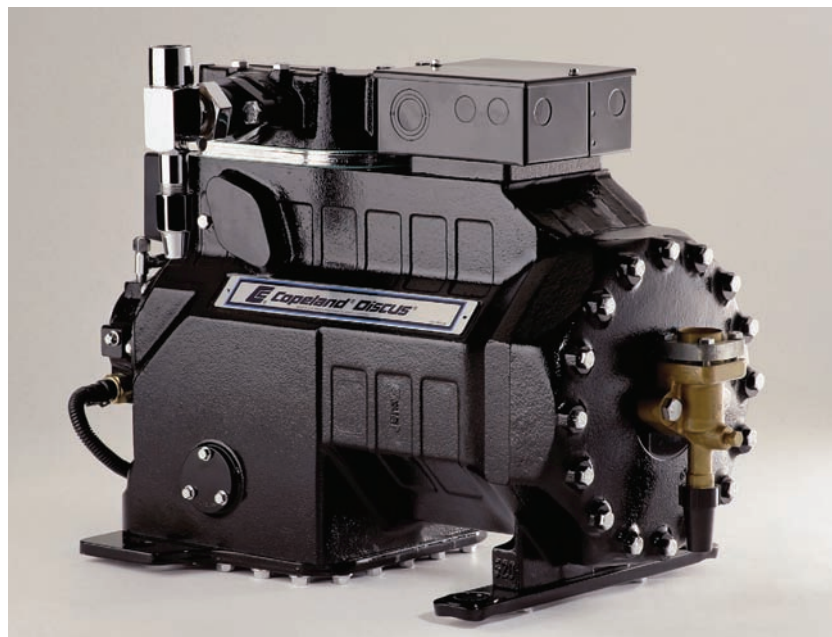

# Semi-Hermetic Compressors – 3A and 3R

| Compressor Cooling  |                    | Comp. Motor Rating Nominal |      |              |      |                                 |      | Compressor Motor Type                       |   | Product Variations<br>Numbers will be assigned as follows:<br>1. Numbers -001 through -199 are reserved for sub+b/m numbers.<br>2. Numbers -200 indicates a standard compressor and component parts b/m and model no.<br>3. Numbers -201 and larger will be assigned for all other variations of a given model. |
|---|--------------------|----------------------------|------|--------------|------|---------------------------------|------|---|---|---|
| Code  | Description        | HP                         | Code | HP           | Code | HP                              | Code | Code  |   |   |
| A   | Air cooled         | 1/4                        | 0025 | 2-3/4        | 0275 | 15                              | 1500 | Capacitor run - Capacitor start             | C |   |
| D   | Discus             | 1/3                        | 0033 | 3 (0310)     | 0300 | 20                              | 2000 | Induction run - Capacitor start             | I |   |
| R   | Refrigerant cooled | 1/2                        | 0050 | 3-1/2        | 0350 | 25                              | 2500 | Induction run - Split phase                 | S |   |
| T   | Std. two stage     | 3/4                        | 0075 | 4 (0406)     | 0400 | 30                              | 3000 | Induction run - Capacitor start, low torque | X |   |
| W   | Water cooled       | 1                          | 0100 | 5 (0506)     | 0500 | 35                              | 3500 |   |   |   |
| <b>Tandem Style Models</b><br>Indicated by the digit representing the comp. model series connected in tandem with a comp. of the model series indicated by the first digit. |                    | 1-1/4                      | 0125 | 6            | 0600 | 40                              | 4000 | <b>Three Phase Motors</b>                   |   |   |
|   |                    | 1-1/2                      | 0150 | 7-1/2 (0766) | 0750 | 50                              | 5000 | General                                     | T |   |
|   |                    | 1-3/4                      | 0175 | 9            | 0900 | 60                              | 6000 | 3 Lead single voltage                       |   |   |
|   |                    | 2                          | 0200 | 10 (1015)    | 1000 |                                 |      | 6 Lead part winding (575 volt)              |   |   |
|   |                    | 2-1/2                      | 0250 | 12           | 1200 |                                 |      | 9 Lead dual voltage                         |   |   |
|   |                    |                            |      |              |      |                                 |      | Star (wye) delta                            | E |   |
|   |                    |                            |      |              |      | 6 Lead motors                   | F    |   |   |   |
|   |                    |                            |      |              |      | Part winding or across the line |      |   |   |   |

May be = (-) or A      Note: Nominal horsepower rating of tandem compressors is sum of individual compressor ratings

## 3ABB - 032E - CAB 800

| Compressor Motor Protection  |      | Electrical Codes |               |      |                    |           |      |
|--|------|------------------|---------------|------|--------------------|-----------|------|
| Description  | Code | 60 Hz            | 50 Hz         | Code | 60 Hz              | 50 Hz     | Code |
| External inherent protection - one protector (line break) use with contactor   | A    | 115-1            | 100-1         | A    | -                  | 220-1     | S    |
| Internal inherent protection - one protector use with contactor  | F    | 230-1            | 200-1         | B    | -                  | 200-1     | T    |
| Internal thermostat(s); and ext. supplementary protector(s) use with contactor.  | H    | 5206-230-3       | 200/220-3     | C    | 200-3              | -         | U    |
| Internal thermostat(s); and three ext. supplementary protector(s) use with contactor.                                      | L    | 460-3            | 380/400-3     | D    | 208-230-1          | 200-1     | V    |
| Internal thermal protectors - electronic sensors; and control module external. Use with contactor.                         | S    | 575-3            | 500-3         | E    | -                  | 200/220-3 | W    |
| Internal thermal protectors - electronic sensors; and control module external. use with contactor (For European use only). | W    | -                | 115-1         | F    | Misc. A.C. Ratings | X         |      |
|  |      | -                | 230-1         | G    | -                  | 500-3     | Y    |
|  |      | 208-1            | 200-1         | H    | -                  | 220/240-1 | Z    |
|  |      | -                | 208/230-1     | I    | 200-1              | 200-1     | 3    |
|  |      | 208/230/460-3    | 200/400-3     | K    | 100-1              | 100-1     | 4    |
|  |      | -                | 210/240/380-3 | L    | 200-230-3          | -         | 5    |
|  |      | -                | 380/420-3     | M    | 230-3              | -         | 6    |
|  |      | 230/460-3        | 200/400-3     | N    | 380                | 346       | 7    |
|  |      | -                | 200/380-3     | P    | 200/220/380        | 200/345   | 8    |
|  |      | -                | 200/240-3     | R    |                    |           |      |

\* When applicable, specific 50 HZ ratings (Not necessarily identical to typical shown above) will be shown as alternate on 60 HZ rated models.

## Common Replacement Parts

| Common Parts                           | Part Number |
|--|-------------|
| Sight Glass Kit                        | 998-0002-04 |
| Suction Strainer Screen                | 013-0010-00 |
| Terminal Fused Cluster                 | 521-0017-00 |
| Terminal Fused Cluster Seal            | 020-0844-02 |
| Gaskets                                | Part Number |
| Complete Gasket Set for 3A Compressors | 998-0669-24 |
| Complete Gasket Set for 3R Compressors | 998-0669-25 |
| Crankcase Heater                       | Part Number |
| Bolt on 120 Volt 65 Watt               | 918-0009-00 |
| Bolt On 240 Volt 65 Watt               | 918-0009-01 |

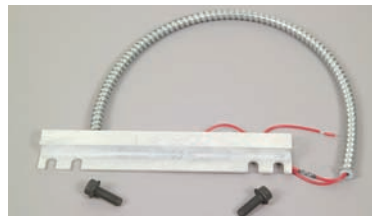
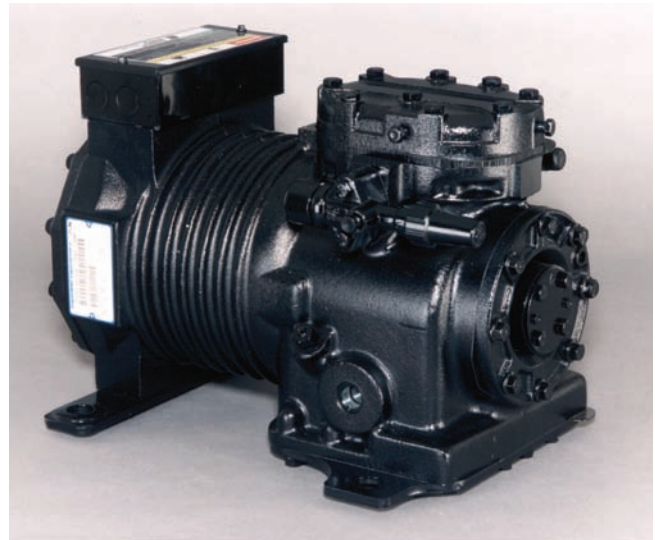

# 3A and 3R – Semi-Hermetic Compressors

## 3A - Compressor Parts

| Model         | Valve Plate Kit | Valve Plate Gasket | Start Capacitor |         | Run Capacitor |         | Relay   |         | Protector | Terminal Board Assembly | Terminal Insulator Assembly |
|---------------|-----------------|--------------------|-----------------|---------|---------------|---------|---------|---------|-----------|-------------------------|-----------------------------|
|               |                 |                    | OEM             | Service | OEM           | Service | OEM     | Service |           |                         |                             |
|               | (998-)          | (020-)             | (014-)          | (914-)  | (014-)        | (914-)  | (040-)  | (940-)  |           |                         |                             |
| 3AB1-0300-TAE | 0661-44         | 0112-02            |                 |         |               |         |         |         | 0090-16   | 0052-02                 | 0067-01                     |
| 3AB1-0310-TAC | 0661-44         | 0112-02            |                 |         |               |         |         |         | 0090-01   | 0052-01                 | 0067-01                     |
| 3AB1-0310-TAD | 0661-44         | 0112-02            |                 |         |               |         |         |         | 0090-03   | 0052-02                 | 0067-01                     |
| 3AB1-0311-TAC | 0661-44         | 0112-02            |                 |         |               |         |         |         | 0090-37   | 0052-01                 | 0067-01                     |
| 3AB1-0311-TAD | 0661-44         | 0112-02            |                 |         |               |         |         |         | 0090-03   | 0052-02                 | 0067-01                     |
| 3AB2-0310-CAB | 0661-44         | 0112-02            | 0006-13         | 0006-03 | 0064-12       | 0037-16 | 0166-28 | 0001-69 | 0119-01   | 0050-00                 | 0067-01                     |
| 3ABA-031E-TAC | 0661-44         | 0112-02            |                 |         |               |         |         |         | 0090-37   | 0052-01                 | 0067-01                     |
| 3ABA-031E-TAD | 0661-44         | 0112-02            |                 |         |               |         |         |         | 0090-03   | 0052-02                 | 0067-01                     |
| 3ABB-032E-CAB | 0661-44         | 0112-02            | 0006-13         | 0006-03 | 0064-14       | 0037-18 | 0166-28 | 0001-69 | 0119-02   | 0050-00                 | 0067-01                     |
| 3AH1-0200-TAC | 0661-21         | 0112-00            |                 |         |               |         |         |         | 0090-00   | 0052-02                 | 0067-01                     |
| 3AH1-0200-TAD | 0661-21         | 0112-00            |                 |         |               |         |         |         | 0090-08   | 0052-02                 | 0067-01                     |
| 3AH1-0200-TAE | 0661-21         | 0112-00            |                 |         |               |         |         |         | 0090-15   | 0052-00                 | 0067-01                     |
| 3AH2-0200-CAB | 0661-21         | 0112-00            | 0061-30         | 0006-01 | 0064-11       | 0037-15 | 0166-20 | 0001-61 | 0092-18   | 0051-00                 | 0067-01                     |
| 3AH2-0200-CAH | 0661-21         | 0112-00            | 0061-30         | 0006-01 | 0064-11       | 0037-15 | 0166-20 | 0001-61 | 0089-00   | 0051-00                 | 0067-01                     |
| 3AJ1-0200-TAC | 0661-21         | 0112-01            |                 |         |               |         |         |         | 0090-00   | 0052-02                 | 0067-01                     |
| 3AJ1-0200-TAD | 0661-21         | 0112-01            |                 |         |               |         |         |         | 0090-08   | 0052-02                 | 0067-01                     |
| 3AJ1-0200-TAE | 0661-21         | 0112-01            |                 |         |               |         |         |         | 0090-15   | 0052-00                 | 0067-01                     |
| 3AJ2-0200-CAB | 0661-21         | 0112-01            | 0061-30         | 0006-01 | 0064-11       | 0037-15 | 0166-20 | 0001-61 | 0092-18   | 0051-00                 | 0067-01                     |
| 3AJ2-0200-CAH | 0661-21         | 0112-01            | 0061-30         | 0006-01 | 0064-11       | 0037-15 | 0166-20 | 0001-61 | 0092-18   | 0051-00                 | 0067-01                     |
| 3AJ2-0310-CAB | 0661-21         | 0112-01            | 0006-13         | 0006-03 | 0064-12       | 0037-16 | 0166-28 | 0001-69 | 0119-01   | 0050-00                 | 0067-01                     |
| 3AJA-0210-TAC | 0661-21         | 0112-01            |                 |         |               |         |         |         | 0090-44   | 0052-01                 | 0067-01                     |
| 3AJB-0210-CAB | 0661-21         | 0112-01            | 0006-13         | 0006-03 | 0064-12       | 0037-16 | 0166-28 | 0001-69 | 0119-05   | 0051-00                 | 0067-01                     |

**Note:** 3W water cooled compressors are the same as the 3A model having body fin casting except for a factory installed water jacket.

## 3R - Compressor Parts

| Model         | Valve Plate Kit | Valve Plate Gasket | Start Capacitor |         | Run Capacitor |         | Relay   |         | Protector | Terminal Board Assembly | Terminal Insulator Assembly |
|---------------|-----------------|--------------------|-----------------|---------|---------------|---------|---------|---------|-----------|-------------------------|-----------------------------|
|               |                 |                    | OEM             | Service | OEM           | Service | OEM     | Service |           |                         |                             |
|               | (998-)          | (020-)             | (014-)          | (914-)  | (014-)        | (914-)  | (040-)  | (940-)  |           |                         |                             |
| 3RA1-0310-TAC | 0661-20         | 0112-00            |                 |         |               |         |         |         | 0090-17   | 0052-01                 | 0067-01                     |
| 3RA1-0310-TAD | 0661-20         | 0112-00            |                 |         |               |         |         |         | 0090-22   | 0052-02                 | 0067-01                     |
| 3RA1-0311-TAC | 0661-20         | 0112-00            |                 |         |               |         |         |         | 0090-32   | 0052-01                 | 0067-01                     |
| 3RA1-0311-TAD | 0661-20         | 0112-00            |                 |         |               |         |         |         | 0090-22   | 0052-02                 | 0067-01                     |
| 3RA2-0310-CAB | 0661-20         | 0112-00            | 0061-30         | 0006-01 | 0064-14       | 0037-18 | 0166-28 | 0001-69 | 0119-02   | 0050-00                 | 0067-01                     |
| 3RAA-031E-TAC | 0661-20         | 0112-00            |                 |         |               |         |         |         | 0090-32   | 0052-01                 | 0067-01                     |
| 3RAA-031E-TAD | 0661-20         | 0112-00            |                 |         |               |         |         |         | 0090-22   | 0052-02                 | 0067-01                     |
| 3RK1-0300-TAE | 0661-20         | 0113-00            |                 |         |               |         |         |         | 0090-16   | 0052-02                 | 0067-01                     |
| 3RK1-0310-TAC | 0661-20         | 0113-00            |                 |         |               |         |         |         | 0090-02   | 0052-01                 | 0067-01                     |
| 3RK1-0310-TAD | 0661-20         | 0113-00            |                 |         |               |         |         |         | 0090-03   | 0052-02                 | 0067-01                     |
| 3RK2-0310-CAB | 0661-20         | 0113-00            | 0061-30         | 0006-01 | 0064-14       | 0037-18 | 0166-28 | 0001-69 | 0119-00   | 0050-00                 | 0067-01                     |

# Semi-Hermetic Compressors – 3D

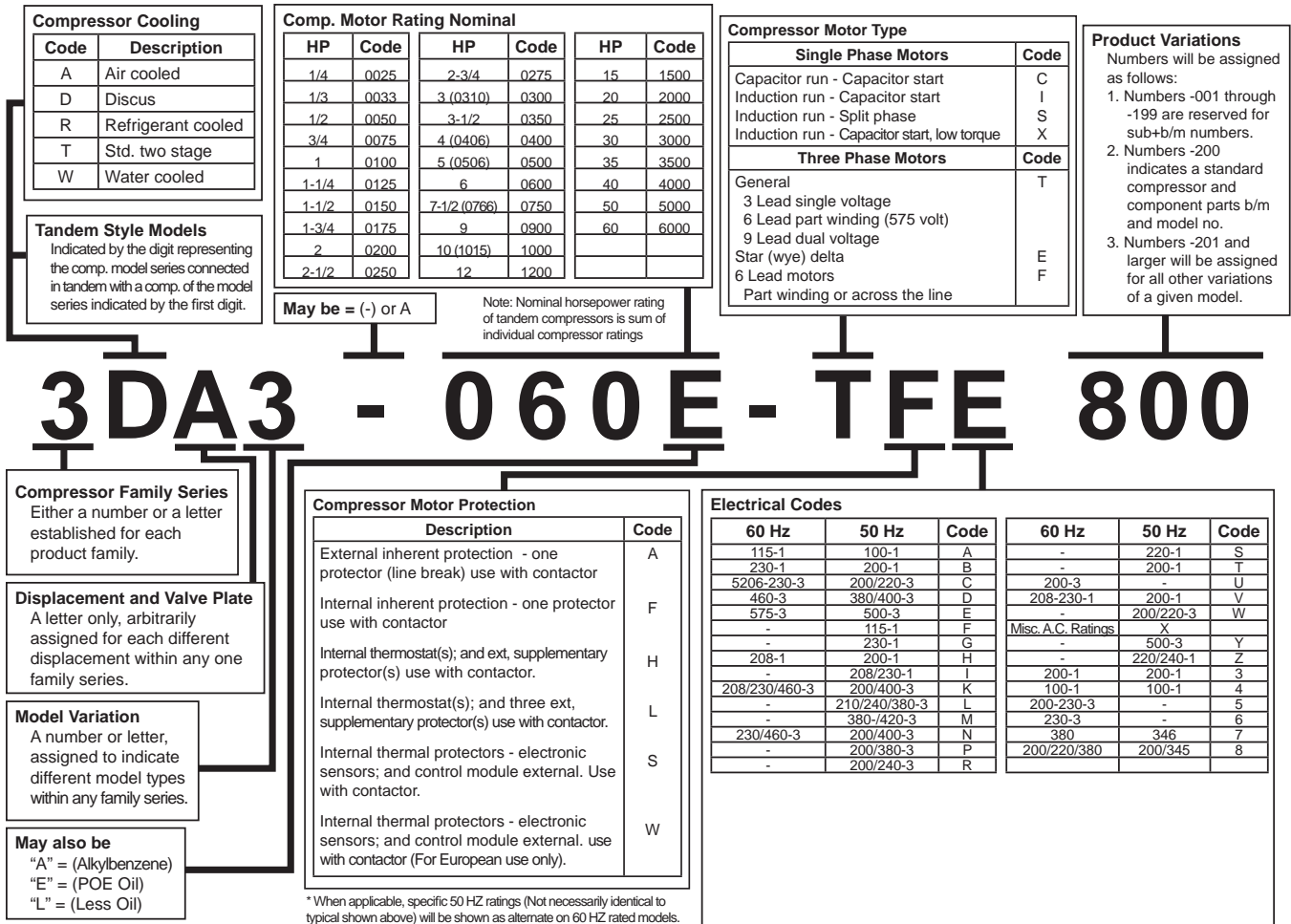

### New Model Nomenclature (5th Digit = Application Rating)

R = Rating at +45°F to +130°F at 90°F Ambient Air

S = Rating at +20°F to +120°F at 90°F Ambient Air

F = Rating at -25°F to +105°F at 90° Ambient Air



# 3D – Semi-Hermetic Compressors

| Compressor Cooling |                    |
|--------------------|--------------------|
| Code               | Description        |
| A                  | Air cooled         |
| D                  | Discus             |
| R                  | Refrigerant cooled |
| T                  | Std. two stage     |
| W                  | Water cooled       |

| Capacity Multiplier |
|---------------------|
| M = 10,000          |
| K = 1,000           |

**May also be**  
 "O" = (Mineral Oil)  
 "E" = (POE Oil)  
 "L" = (Less Oil)

| Compressor Motor Type                       |      |
|---|------|
| Single Phase Motors                         | Code |
| Capacitor run - Capacitor start             | C    |
| Induction run - Capacitor start             | I    |
| Induction run - Split phase                 | S    |
| Induction run - Capacitor start, low torque | X    |
| Three Phase Motors                          | Code |
| General                                     | T    |
| 3 Lead single voltage                       |      |
| 6 Lead part winding (575 volt)              |      |
| 9 Lead dual voltage                         |      |
| Star (wye) delta                            | E    |
| 6 Lead motors                               | F    |
| Part winding or across the line             |      |

| Product Variations   |  |
|--|--|
| Numbers will be assigned as follows:   |  |
| 1. Numbers - 001 through -199 are reserved for sub-b/m numbers.                                  |  |
| 2. Numbers - 200 indicates a standard compressor and component parts b/m and model no.           |  |
| 3. Numbers - 201 and larger will be assigned for all other variations of a given model.          |  |
| 4. Numbers -C00 and larger will be assigned for all variations with CoreSense™ Modules Installed |  |

**Primary Application Range**  
 R = ARI High Temp. Rated @ 45/130  
 S = ARI Med Temp. Rated @ 20/120  
 F = ARI Low Temp. Rated @ -25/105

**Tandem Style Models**  
 Indicated by the digit representing the comp. model series connected in tandem with a comp. of the model series indicated by the first digit.

**Nominal Capacity at Rating Condition 2**  
 numeric characters

## 3 DK3 R 15 ME - TFC 800

| Compressor Motor Protection  |      |
|--|------|
| Description  | Code |
| External inherent protection - one protector (line break) use with contactor                       | A    |
| Internal inherent protection - one protector use with contactor                                    | F    |
| Internal thermostat(s); and ext, supplementary protector(s) use with contactor.                    | H    |
| Internal thermostat(s); and three ext, supplementary protector(s) use with contactor.              | L    |
| Internal thermal protectors - electronic sensors; and control module external. Use with contactor. | S    |

\* When applicable, specific 50 HZ ratings (Not necessarily identical to typical shown above) will be shown as alternate on 60 HZ rated models.

| Electrical Codes |               |               | 60 Hz |                    |           | 50 Hz |  |  |
|------------------|---------------|---------------|-------|--------------------|-----------|-------|--|--|
|                  | 60 Hz         | 50 Hz         | Code  | 60 Hz              | 50 Hz     | Code  |  |  |
|                  | 115-1         | 100-1         | A     | -                  | 220-1     | S     |  |  |
|                  | 230-1         | 200-1         | B     | -                  | 200-1     | T     |  |  |
|                  | 5206-230-3    | 200/220-3     | C     | 200-3              | -         | U     |  |  |
|                  | 460-3         | 380/400-3     | D     | 208-230-1          | 200-1     | V     |  |  |
|                  | 575-3         | 500-3         | E     | -                  | 200/220-3 | W     |  |  |
|                  | -             | 115-1         | F     | Misc. A.C. Ratings | X         |       |  |  |
|                  | -             | 230-1         | G     | -                  | 500-3     | Y     |  |  |
|                  | 208-1         | 200-1         | H     | -                  | 220/240-1 | Z     |  |  |
|                  | -             | 208/230-1     | I     | 200-1              | 200-1     | 3     |  |  |
|                  | 208/230/460-3 | 200/400-3     | K     | 100-1              | 100-1     | 4     |  |  |
|                  | -             | 210/240/380-3 | L     | 200-230-3          | -         | 5     |  |  |
|                  | -             | 380-/420-3    | M     | 230-3              | -         | 6     |  |  |
|                  | 230/460-3     | 200/400-3     | N     | 380                | 346       | 7     |  |  |
|                  | -             | 200/380-3     | P     | 200/220/380        | 200/345   | 8     |  |  |
|                  | -             | 200/240-3     | R     |                    |           |       |  |  |

**Compressor Family Series**  
 Either a number or a letter established for each product family.

**Displacement and Valve Plate**  
 A letter only, arbitrarily assigned for each different displacement within any one family series.

**Model Variation**  
 A number or letter, assigned to indicate different model types within any family series.

**New Model Nomenclature (5th Digit = Application Rating)**  
 R = Rating at +45°F to +130°F at 90°F Ambient Air  
 S = Rating at +20°F to +120°F at 90°F Ambient Air  
 F = Rating at -25°F to +105°F at 90° Ambient Air

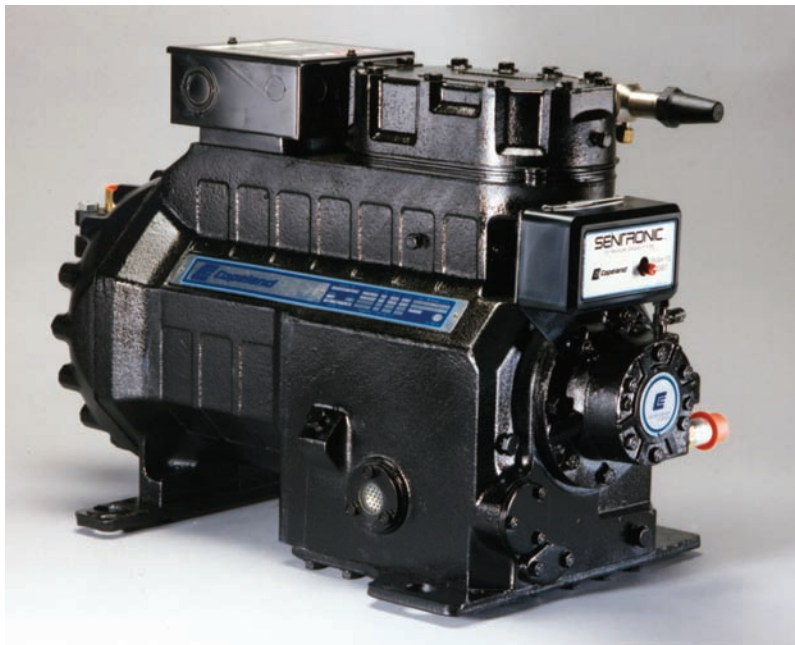

## Common Replacement Parts

| Common Parts                             | Part Number |
|--|-------------|
| Sight Glass Kit                          | 998-0002-02 |
| Sight Glass O-Ring                       | 020-0844-05 |
| Oil Check Valve Assembly                 | 510-0142-00 |
| Oil Screen Kit                           | 998-0513-03 |
| Oil Pump Kit                             | 998-0008-33 |
| Rotalock Adaptor Kit                     | 998-0036-00 |
| Gaskets                                  | Part Number |
| Complete Gasket Set                      | 998-1669-04 |
| Housing Cover                            | 020-0749-00 |
| Stator Cover                             | 020-0709-00 |
| Bottom Plate                             | 020-0479-00 |
| Oil Pump                                 | 020-1204-00 |
| Terminal Plate                           | 020-0146-00 |
| Rotalock Adaptor                         | 020-0012-09 |
| Cylinder Head - Standard/Moduload Models | 020-0730-00 |
| Cylinder Head - Digital Models           | 020-1368-00 |
| CoreSense™ Parts                         | Part Number |
| CoreSense Module                         | 943-0128-00 |
| 2D/3D CoreSense Wiring Harness           | 929-0097-00 |
| CoreSense DLT Thermistor                 | 985-0109-50 |
| Current Sensor Kit                       | 943-0064-00 |
| CoreSense Terminal Box Kit               | 962-0437-00 |
| Sensor Only                              | 998-0162-01 |
| Copper Gasket for Sensor                 | 020-0297-13 |
| O-Ring Gasket for Sensor                 | 020-0003-28 |

| Terminal Plate                                  | Part Number |
|---|-------------|
| Terminal Fused Cluster (Fusite)                 | 521-0018-00 |
| Terminal Fused Seal (Fusite)                    | 020-0844-02 |
| T Block - used with Fusite electrical connector | 021-0227-02 |
| Terminal Board Assembly                         | 580-0053-00 |
| Demand Cooling (R22/R407A/C/F)                  | Part Number |
| 120 Volt Demand Cooling Kit                     | 998-1000-13 |
| 120 Volt Control Only                           | 085-0110-00 |
| 240 Volt Demand Cooling Kit                     | 998-1000-23 |
| 240 Volt Control Only                           | 085-0110-01 |
| Sentronic 3 Kits and Parts                      | Part Number |
| Complete Kit                                    | 585-1076-02 |
| Sensor and Cable Kit                            | 998-0162-00 |
| Sensor Only                                     | 998-0162-01 |
| Copper Gasket for Sensor                        | 020-0297-13 |
| O-Ring Gasket for Sensor                        | 020-0003-28 |
| Crankcase Heater                                | Part Number |
| 120 Volt 100 Watt                               | 518-0028-06 |
| 240 Volt 100 Watt                               | 518-0028-07 |
| Crankcase Heater Well                           | 030-0187-01 |



# 3D – Semi-Hermetic Compressors

## Parts for 3D Moduload Compressors

| Moduload Unloaders          | Part Number | Obsolete (Alco) Valve |
|-----------------------------|-------------|-----------------------|
| Valve Less Coil             | 998-0326-00 |                       |
| 24 Volt Valve and Coil Kit  | 998-0326-01 |                       |
| 24 Volt Coil Only           | 023-0091-00 | 023-0039-09           |
| 120 Volt Valve and Coil Kit | 998-0326-02 |                       |
| 120 Volt Coil Only          | 023-0091-01 | 023-0039-10           |
| 240 Volt Valve and Coil Kit | 998-0326-03 |                       |
| 240 Volt Coil Only          | 023-0091-02 | 023-0039-11           |
| Unloader Gasket             | 020-0783-00 |                       |
| Spacer Plate                | 003-0616-01 |                       |
| Spacer Plate Gasket         | 020-0727-00 |                       |
| Top Plate                   | 003-0754-00 |                       |
| Top Plate Gasket            | 020-0726-00 |                       |

## Cooling Fan Kits

| Cooling Fan Kits          | Part Number | Used On              |
|---------------------------|-------------|----------------------|
| 120V w/Bottom Fan Guard   | 998-0550-05 | All 3D               |
| 120V w/Complete Fan Guard | 998-0550-02 |                      |
| 240V w/Bottom Fan Guard   | 998-0550-03 |                      |
| 240V w/Complete Fan Guard | 998-0550-00 |                      |
| 460V w/Bottom Fan Guard   | 998-0550-04 |                      |
| 460V w/Complete Fan Guard | 998-0550-01 |                      |
| Fan Mounting Kit          | 998-0574-08 | All Standard 3D      |
| Fan Mounting Kit          | 998-0574-10 | All Moduload/Digital |
| Fan Blade                 | 083-0118-00 | All 3D               |
| Top Fan Guard             | 024-0200-00 |                      |

## Service Valves

| Part Number | Size  | Discharge | Suction | Style                  | MTG Center             | Thread   |
|-------------|-------|-----------|---------|------------------------|------------------------|----------|
| 998-0510-02 | 1 1/8 | X         |         | Rotalock               | Rotalock Valve Adaptor | 1 3/4-12 |
| 998-0510-37 |       | X         |         | Rotalock               |                        | 1 3/4-12 |
| 998-0510-11 | 1 3/8 |           | X       | Bolt on (2)            | 2 1/4 x 2 1/4          |          |
| 998-0510-07 | 1 5/8 |           | X       | Bolt on (4)            | 2 1/2 x 2 1/2          |          |
| 998-0510-08 | 1 3/8 |           | X       | Bolt on (4)            | 2 1/2 x 2 1/2          |          |
| 998-0036-00 |       | X         |         | Rotalock Valve Adaptor | 1 3/4-12               |          |

## Parts for 3D Digital Compressors

| 3D Digital           | Part #      |
|----------------------|-------------|
| 24V Coil             | 923-0084-00 |
| 120V Coil            | 923-0084-01 |
| 240V Coil            | 923-0084-02 |
| Valve Only           | 910-0111-00 |
| Unloader Gasket      | 020-1369-01 |
| IDCM Control Module  | 943-0086-00 |
| Discharge Thermistor | 985-0109-07 |

## 3D Floating Reed Models - Compressor Parts

| Model           | Valve Plate Kit | Valve Plate Gasket | Motor Protector Kit | Terminal Plate Group |
|-----------------|-----------------|--------------------|---------------------|----------------------|
|                 | (998-)          | (920-)             | (998-)              |                      |
| 3DA3-0500-TFC   | 1661-43         | 0729-05            | 0429-02             | 521-0144-00          |
| 3DA3-0500-TFD   | 1661-43         | 0729-05            | 0429-03             | 521-0144-00          |
| 3DA3-0500-TFE   | 1661-43         | 0729-05            | 0429-19             | 521-0144-00          |
| 3DA3-0600-TFC   | 1661-43         | 0729-05            | 0429-08             | 521-0144-00          |
| 3DA3-0600-TFD   | 1661-43         | 0729-05            | 0429-05             | 521-0144-00          |
| 3DA3-0600-TFE   | 1661-43         | 0729-05            | 0429-03             | 521-0144-00          |
| 3DA3-060E-TFC   | 1661-43         | 0729-05            | 0429-08             | 521-0144-00          |
| 3DA3-060E-TFD   | 1661-43         | 0729-05            | 0429-05             | 521-0144-00          |
| 3DA3-060E-TFE   | 1661-43         | 0729-05            | 0429-03             | 521-0144-00          |
| 3DA3-0750-TFC   | 1661-51         | 0729-05            | 0429-06             | 503-0390-00          |
| 3DA3-0750-TFD   | 1661-51         | 0729-05            | 0429-17             | 503-0390-00          |
| 3DA3-0750-TFE   | 1661-51         | 0729-05            | 0429-11             | 503-0390-00          |
| 3DA3-075E-TFC   | 1661-51         | 0729-05            | 0429-11             | 503-0390-00          |
| 3DA3-075E-TFD   | 1661-51         | 0729-05            | 0429-17             | 503-0390-00          |
| 3DA3-075E-TFE   | 1661-51         | 0729-05            | 0429-11             | 503-0390-00          |
| 3DB2-1000-TFC   | 1661-51         | 0729-01            | 0429-06             | 503-0390-00          |
| 3DB2-1000-TFD   | 1661-51         | 0729-01            | 0429-17             | 503-0390-00          |
| 3DB2-1000-TFE   | 1661-51         | 0729-01            | 0429-11             | 503-0390-00          |
| 3DB3-0500-TFC   | 1661-43         | 0729-01            | 0429-02             | 521-0144-00          |
| 3DB3-0500-TFD   | 1661-43         | 0729-01            | 0429-03             | 521-0144-00          |
| 3DB3-0500-TFE   | 1661-43         | 0729-01            | 0429-19             | 521-0144-00          |
| 3DB3-0750-FSM   | 1661-43         | 0729-01            | 0524-12             | 521-0169-00          |
| 3DB3-0750-TFC   | 1661-43         | 0729-01            | 0429-04             | 503-0390-00          |
| 3DB3-0750-TFD   | 1661-43         | 0729-01            | 0429-09             | 503-0390-00          |
| 3DB3-0750-TFE   | 1661-43         | 0729-01            | 0429-03             | 503-0390-00          |
| 3DB3-075E-TFC   | 1661-43         | 0729-01            | 0429-04             | 503-0390-00          |
| 3DB3-075E-TFD   | 1661-43         | 0729-01            | 0429-09             | 503-0390-00          |
| 3DB3-075E-TFE   | 1661-43         | 0729-01            | 0429-03             | 503-0390-00          |
| 3DB3-1000-TFC   | 1661-51         | 0729-01            | 0429-06             | 503-0390-00          |
| 3DB3-1000-TFD   | 1661-51         | 0729-01            | 0429-17             | 503-0390-00          |
| 3DB3-1000-TFE   | 1661-51         | 0729-01            | 0429-11             | 503-0390-00          |
| 3DB3-100E-TFC   | 1661-51         | 0729-01            | 0429-06             | 503-0390-00          |
| 3DB3-100E-TFD   | 1661-51         | 0729-01            | 0429-17             | 503-0390-00          |
| 3DB3-100E-TFE   | 1661-51         | 0729-01            | 0429-11             | 503-0390-00          |
| • 3DE3-0500-TFC | 1661-64         | 0729-05            | 0429-02             | 521-0144-00          |
| • 3DE3-0500-TFD | 1661-64         | 0729-05            | 0429-03             | 521-0144-00          |
| • 3DE3-0500-TFE | 1661-64         | 0729-05            | 0429-19             | 521-0144-00          |
| • 3DE3-0750-TFC | 1661-53         | 0729-05            | 0429-06             | 503-0390-00          |
| • 3DE3-0750-TFD | 1661-53         | 0729-05            | 0429-17             | 503-0390-00          |
| • 3DE3-0750-TFE | 1661-53         | 0729-05            | 0429-11             | 503-0390-00          |
| • 3DE3-075E-TFC | 1661-53         | 0729-05            | 0429-06             | 503-0390-00          |
| • 3DE3-075E-TFD | 1661-53         | 0729-05            | 0429-17             | 503-0390-00          |

• = Moduload

# 3D – Semi-Hermetic Compressors

## 3D Floating Reed Models - Compressor Parts

| Model           | Valve Plate Kit | Valve Plate Gasket | Motor Protector Kit | Terminal Plate Group |
|-----------------|-----------------|--------------------|---------------------|----------------------|
|                 | (998-)          | (920-)             | (998-)              |                      |
| • 3DE3-075E-TFE | 1661-53         | 0729-05            | 0429-11             | 503-0390-00          |
| 3DEH-075E-TFC   | 1661-48         | 0729-05            | 0429-06             | 503-0390-00          |
| 3DEH-075E-TFD   | 1661-48         | 0729-05            | 0429-17             | 503-0390-00          |
| 3DEH-075E-TFE   | 1661-48         | 0729-05            | 0429-11             | 503-0390-00          |
| 3DF3-0750-TFC   | 1661-43         | 0729-03            | 0429-04             | 521-0144-00          |
| 3DF3-0750-TFD   | 1661-43         | 0729-03            | 0429-09             | 521-0144-00          |
| 3DF3-0900-TFC   | 1661-43         | 0729-03            | 0429-00             | 503-0390-00          |
| 3DF3-0900-TFD   | 1661-43         | 0729-03            | 0429-09             | 503-0390-00          |
| 3DF3-0900-TFE   | 1661-43         | 0729-03            | 0429-11             | 503-0390-00          |
| 3DF3-090E-TFC   | 1661-43         | 0729-03            | 0429-00             | 503-0390-00          |
| 3DF3-090E-TFD   | 1661-43         | 0729-03            | 0429-09             | 503-0390-00          |
| 3DF3-090E-TFE   | 1661-43         | 0729-03            | 0429-11             | 503-0390-00          |
| 3DF3-1200-TFC   | 1661-43         | 0729-03            | 0451-02             | 503-0390-00          |
| 3DF3-1200-TFD   | 1661-43         | 0729-03            | 0455-03             | 503-0390-00          |
| 3DF3-1200-TFE   | 1661-43         | 0729-03            | 0455-04             | 503-0390-00          |
| 3DF3-120E-TFC   | 1661-43         | 0729-03            | 0451-02             | 503-0390-00          |
| 3DF3-120E-TFD   | 1661-43         | 0729-03            | 0455-03             | 503-0390-00          |
| 3DF4-120E-TFC   | 1661-43         | 0729-03            | 0451-02             | 503-0390-00          |
| 3DF4-120E-TFD   | 1661-43         | 0729-03            | 0455-03             | 503-0390-00          |
| • 3DG3-0900-TFC | 1661-57         | 0729-03            | 0429-00             | 503-0390-00          |
| • 3DG3-0900-TFD | 1661-57         | 0729-03            | 0429-09             | 503-0390-00          |
| • 3DG3-0900-TFE | 1661-57         | 0729-03            | 0429-11             | 503-0390-00          |
| • 3DG3-090E-TFC | 1661-57         | 0729-03            | 0429-00             | 503-0390-00          |
| • 3DG3-090E-TFD | 1661-57         | 0729-03            | 0429-09             | 503-0390-00          |
| • 3DG3-090E-TFE | 1661-57         | 0729-03            | 0429-11             | 503-0390-00          |
| • 3DGH-090E-TFC | 1661-45         | 0729-03            | 0429-00             | 503-0390-00          |
| • 3DGH-090E-TFD | 1661-45         | 0729-03            | 0429-09             | 503-0390-00          |
| • 3DGH-090E-TFE | 1661-45         | 0729-03            | 0429-11             | 503-0390-00          |
| • 3DH3-0600-TFC | 1661-54         | 0729-05            | 0429-08             | 521-0144-00          |
| • 3DH3-0600-TFD | 1661-54         | 0729-05            | 0429-05             | 521-0144-00          |
| • 3DH3-0600-TFE | 1661-54         | 0729-05            | 0429-03             | 521-0144-00          |
| • 3DH3-060E-TFC | 1661-54         | 0729-05            | 0429-08             | 521-0144-00          |
| • 3DH3-060E-TFD | 1661-54         | 0729-05            | 0429-05             | 521-0144-00          |
| • 3DH3-060E-TFE | 1661-54         | 0729-05            | 0429-03             | 521-0144-00          |
| • 3DHH-060E-TFC | 1661-46         | 0729-05            | 0429-08             | 521-0144-00          |
| • 3DHH-060E-TFD | 1661-46         | 0729-05            | 0429-05             | 521-0144-00          |
| • 3DHH-060E-TFE | 1661-46         | 0729-05            | 0429-03             | 521-0144-00          |
| • 3DJ3-0750-TFC | 1661-54         | 0729-01            | 0429-04             | 521-0144-00          |
| • 3DJ3-0750-TFD | 1661-54         | 0729-01            | 0429-09             | 521-0144-00          |

• = Moduload

## 3D Floating Reed Models - Compressor Parts

| Model           | Valve Plate Kit | Valve Plate Gasket | Motor Protector Kit | Terminal Plate Group |
|-----------------|-----------------|--------------------|---------------------|----------------------|
|                 | (998-)          | (920-)             | (998-)              |                      |
| • 3DJ3-0750-TFE | 1661-54         | 0729-01            | 0429-03             | 521-0144-00          |
| • 3DJ3-075E-TFC | 1661-54         | 0729-01            | 0429-04             | 521-0144-00          |
| • 3DJ3-075E-TFD | 1661-54         | 0729-01            | 0429-09             | 521-0144-00          |
| • 3DJ3-075E-TFE | 1661-54         | 0729-01            | 0429-03             | 521-0144-00          |
| • 3DJH-075E-TFC | 1661-46         | 0729-01            | 0429-04             | 521-0144-00          |
| • 3DJH-075E-TFD | 1661-46         | 0729-01            | 0429-09             | 521-0144-00          |
| • 3DJH-075E-TFE | 1661-46         | 0729-01            | 0429-03             | 521-0144-00          |
| • 3DK3-0750-TFC | 1661-56         | 0729-03            | 0429-04             | 521-0144-00          |
| • 3DK3-0750-TFD | 1661-56         | 0729-03            | 0429-09             | 521-0144-00          |
| • 3DK3-0900-TFC | 1661-56         | 0729-03            | 0429-00             | 503-0390-00          |
| • 3DK3-0900-TFD | 1661-56         | 0729-03            | 0429-09             | 503-0390-00          |
| • 3DK3-0900-TFE | 1661-56         | 0729-03            | 0429-11             | 503-0390-00          |
| • 3DK3-1200-TFC | 1661-56         | 0729-03            | 0451-02             | 503-0390-00          |
| • 3DK3-1200-TFD | 1661-56         | 0729-03            | 0455-03             | 503-0390-00          |
| • 3DK3-120E-TFC | 1661-56         | 0729-03            | 0451-02             | 503-0390-00          |
| • 3DK3-120E-TFD | 1661-56         | 0729-03            | 0455-03             | 503-0390-00          |
| • 3DK4-1200-TFD | 1661-56         | 0729-03            | 0455-03             | 503-0390-00          |
| • 3DK8-0750-TFC | 1661-56         | 0729-03            | 0429-04             | 521-0144-00          |
| • 3DK8-0750-TFD | 1661-56         | 0729-03            | 0429-09             | 521-0144-00          |
| • 3DK8-075E-TFD | 1661-56         | 0729-03            | 0429-09             | 521-0144-00          |
| • 3DKB-0750-TFC | 1661-56         | 0729-03            | 0429-04             | 521-0144-00          |
| • 3DKB-0750-TFD | 1661-56         | 0729-03            | 0429-09             | 521-0144-00          |
| • 3DKH-120E-TFC | 1661-44         | 0729-03            | 0451-02             | 503-0390-00          |
| • 3DKH-120E-TFD | 1661-44         | 0729-03            | 0455-03             | 503-0390-00          |
| • 3DP3-0500-FSM | 1661-55         | 0729-01            | 0524-12             | 521-0169-00          |
| • 3DP3-0500-TFC | 1661-55         | 0729-01            | 0429-02             | 521-0144-00          |
| • 3DP3-0500-TFD | 1661-55         | 0729-01            | 0429-03             | 521-0144-00          |
| • 3DP3-0500-TFE | 1661-55         | 0729-01            | 0429-19             | 521-0144-00          |
| • 3DP3-0750-TFC | 1661-55         | 0729-01            | 0429-04             | 521-0144-00          |
| • 3DP3-0750-TFD | 1661-55         | 0729-01            | 0429-09             | 521-0144-00          |
| • 3DP3-0750-TFE | 1661-55         | 0729-01            | 0429-03             | 521-0144-00          |
| • 3DP3-075E-TFD | 1661-55         | 0729-01            | 0429-09             | 521-0144-00          |
| • 3DP3-1000-TFC | 1661-55         | 0729-01            | 0429-06             | 503-0390-00          |
| • 3DP3-1000-TFD | 1661-55         | 0729-01            | 0429-17             | 503-0390-00          |
| • 3DP3-1000-TFE | 1661-55         | 0729-01            | 0429-11             | 503-0390-00          |
| • 3DP3-100E-TFC | 1661-55         | 0729-01            | 0429-06             | 503-0390-00          |
| • 3DP3-100E-TFD | 1661-55         | 0729-01            | 0429-17             | 503-0390-00          |
| • 3DP3-100E-TFE | 1661-55         | 0729-01            | 0429-11             | 503-0390-00          |
| • 3DPH-100E-TFC | 1661-47         | 0729-01            | 0429-06             | 503-0390-00          |

• = Moduload



# 3D – Semi-Hermetic Compressors

## 3D Floating Reed Models - Compressor Parts

| Model           | Valve Plate Kit | Valve Plate Gasket | Motor Protector Kit | Terminal Plate Group |
|-----------------|-----------------|--------------------|---------------------|----------------------|
|                 | (998-)          | (920-)             | (998-)              |                      |
| • 3DPH-100E-TFD | 1661-47         | 0729-01            | 0429-17             | 503-0390-00          |
| • 3DPH-100E-TFE | 1661-47         | 0729-01            | 0429-11             | 503-0390-00          |
| • 3DR3-1000-TFC | 1661-57         | 0729-07            | 0429-00             | 503-0390-00          |
| • 3DR3-1000-TFD | 1661-57         | 0729-07            | 0429-09             | 503-0390-00          |
| • 3DR3-1000-TFE | 1661-57         | 0729-07            | 0429-11             | 503-0390-00          |
| • 3DR3-100E-TFC | 1661-57         | 0729-07            | 0429-00             | 503-0390-00          |
| • 3DR3-100E-TFD | 1661-57         | 0729-07            | 0429-09             | 503-0390-00          |
| • 3DR3-100E-TFE | 1661-57         | 0729-07            | 0429-11             | 503-0390-00          |
| • 3DRH-100E-TFC | 1661-45         | 0729-07            | 0429-00             | 503-0390-00          |
| • 3DRH-100E-TFD | 1661-45         | 0729-07            | 0429-09             | 503-0390-00          |
| • 3DRH-100E-TFE | 1661-45         | 0729-07            | 0429-11             | 503-0390-00          |
| 3DS3-0750-TFC   | 1661-43         | 0729-07            | 0429-04             | 521-0144-00          |
| 3DS3-0750-TFD   | 1661-43         | 0729-07            | 0429-09             | 521-0144-00          |
| 3DS3-0750-TFE   | 1661-43         | 0729-07            | 0429-03             | 521-0144-00          |
| 3DS3-1000-TFC   | 1661-43         | 0729-07            | 0429-00             | 503-0390-00          |
| 3DS3-1000-TFD   | 1661-43         | 0729-07            | 0429-09             | 503-0390-00          |
| 3DS3-1000-TFE   | 1661-43         | 0729-07            | 0429-11             | 503-0390-00          |
| 3DS3-100E-TFC   | 1661-43         | 0729-07            | 0429-00             | 503-0390-00          |
| 3DS3-100E-TFD   | 1661-43         | 0729-07            | 0429-09             | 503-0390-00          |
| 3DS3-100E-TFE   | 1661-43         | 0729-07            | 0429-11             | 503-0390-00          |

• = Modulo load

## 3D Delta Reed Models - Compressor Parts

| Model<br>(Horse Power<br>Nomenclature) | Model<br>(BTU<br>Nomenclature) | Valve<br>Plate Kit | Valve Plate<br>Gasket | Motor<br>Protector Kit | Terminal Plate<br>Group |
|--|--------------------------------|--------------------|-----------------------|------------------------|-------------------------|
|  |                                | (998-)             | (920-)                | (998-)                 |                         |
| 3DA3A0500-TFC                          | 3DA3F18K0-TFC                  | 2661-43            | 0981-02               | 0429-02                | 521-0144-00             |
| 3DA3A0500-TFD                          | 3DA3F18K0-TFD                  | 2661-43            | 0981-02               | 0429-03                | 521-0144-00             |
| 3DA3A0500-TFE                          | 3DA3F18K0-TFE                  | 2661-43            | 0981-02               | 0429-19                | 521-0144-00             |
| 3DA3A0600-TFC                          | 3DA3F28K0-TFC                  | 2661-43            | 0981-02               | 0429-08                | 521-0144-00             |
| 3DA3A0600-TFD                          | 3DA3F28K0-TFD                  | 2661-43            | 0981-02               | 0429-05                | 521-0144-00             |
| 3DA3A0600-TFE                          | 3DA3F28K0-TFE                  | 2661-43            | 0981-02               | 0429-03                | 521-0144-00             |
| 3DA3A060E-TFC                          | 3DA3F28KE-TFC                  | 2661-43            | 0981-02               | 0429-08                | 521-0144-00             |
| 3DA3A060E-TFD                          | 3DA3F28KE-TFD                  | 2661-43            | 0981-02               | 0429-05                | 521-0144-00             |
| 3DA3A060E-TFE                          | 3DA3F28KE-TFE                  | 2661-43            | 0981-02               | 0429-03                | 521-0144-00             |
| 3DA3A0750-TFC                          | 3DA3R10M0-TFC                  | 2661-51            | 0981-02               | 0429-06                | 503-0390-00             |
| 3DA3A0750-TFD                          | 3DA3R10M0-TFD                  | 2661-51            | 0981-02               | 0429-17                | 503-0390-00             |
| 3DA3A0750-TFE                          | 3DA3R10M0-TFE                  | 2661-51            | 0981-02               | 0429-11                | 503-0390-00             |
| 3DA3A075E-TFC                          | 3DA3R10ME-TFC                  | 2661-51            | 0981-02               | 0429-06                | 503-0390-00             |
| 3DA3A075E-TFD                          | 3DA3R10ME-TFD                  | 2661-51            | 0981-02               | 0429-17                | 503-0390-00             |
| 3DA3A075E-TFE                          | 3DA3R10ME-TFE                  | 2661-51            | 0981-02               | 0429-11                | 503-0390-00             |
| 3DB3A0500-TFC                          | 3DB3F22K0-TFC                  | 2661-43            | 0981-00               | 0429-02                | 521-0144-00             |
| 3DB3A0500-TFD                          | 3DB3F22K0-TFD                  | 2661-43            | 0981-00               | 0429-03                | 521-0144-00             |
| 3DB3A0500-TFE                          | 3DB3F22K0-TFE                  | 2661-43            | 0981-00               | 0429-19                | 521-0144-00             |
| 3DB3A0750-TFC                          | 3DB3F33K0-TFC                  | 2661-43            | 0981-00               | 0429-04                | 521-0144-00             |
| 3DB3A0750-TFD                          | 3DB3F33K0-TFD                  | 2661-43            | 0981-00               | 0429-09                | 521-0144-00             |
| 3DB3A0750-TFE                          | 3DB3F33K0-TFE                  | 2661-43            | 0981-00               | 0429-03                | 521-0144-00             |
| 3DB3A075E-TFC                          | 3DB3F33KE-TFC                  | 2661-43            | 0981-00               | 0429-04                | 521-0144-00             |
| 3DB3A075E-TFD                          | 3DB3F33KE-TFD                  | 2661-43            | 0981-00               | 0429-09                | 521-0144-00             |
| 3DB3A075E-TFE                          | 3DB3F33KE-TFE                  | 2661-43            | 0981-00               | 0429-03                | 521-0144-00             |
| 3DB3A1000-TFC                          | 3DB3R12M0-TFC                  | 2661-51            | 0981-00               | 0429-06                | 503-0390-00             |
| 3DB3A1000-TFD                          | 3DB3R12M0-TFD                  | 2661-51            | 0981-00               | 0429-17                | 503-0390-00             |
| 3DB3A1000-TFE                          | 3DB3R12M0-TFE                  | 2661-51            | 0981-00               | 0429-11                | 503-0390-00             |
| 3DB3A100E-TFC                          | 3DB3R12ME-TFC                  | 2661-51            | 0981-00               | 0429-06                | 503-0390-00             |
| 3DB3A100E-TFD                          | 3DB3R12ME-TFD                  | 2661-51            | 0981-00               | 0429-17                | 503-0390-00             |
| 3DB3A100E-TFE                          | 3DB3R12ME-TFE                  | 2661-51            | 0981-00               | 0429-11                | 503-0390-00             |
| • 3DE3A0500-TFC                        | 3DE3R70K0-TFC                  | 2661-64            | 0981-02               | 0429-02                | 521-0144-00             |
| • 3DE3A0500-TFD                        | 3DE3R70K0-TFD                  | 2661-64            | 0981-02               | 0429-03                | 521-0144-00             |
| • 3DE3A0500-TFE                        | 3DE3R70K0-TFE                  | 2661-64            | 0981-02               | 0429-19                | 521-0144-00             |
| • 3DE3A0750-TFC                        | 3DE3R10M0-TFC                  | 2661-53            | 0981-02               | 0429-06                | 503-0390-00             |
| • 3DE3A0750-TFD                        | 3DE3R10M0-TFD                  | 2661-53            | 0981-02               | 0429-17                | 503-0390-00             |
| • 3DE3A0750-TFE                        | 3DE3R10M0-TFE                  | 2661-53            | 0981-02               | 0429-11                | 503-0390-00             |
| • 3DE3A075E-TFC                        | 3DE3R10ME-TFC                  | 2661-53            | 0981-02               | 0429-06                | 503-0390-00             |
| • 3DE3A075E-TFD                        | 3DE3R10ME-TFD                  | 2661-53            | 0981-02               | 0429-17                | 503-0390-00             |
| • 3DE3A075E-TFE                        | 3DE3R10ME-TFE                  | 2661-53            | 0981-02               | 0429-11                | 503-0390-00             |
| • 3DEHA075E-TFC                        | 3DEHR10ME-TFC                  | 2661-48            | 0981-02               | 0429-06                | 503-0390-00             |

• = Moduload

# 3D – Semi-Hermetic Compressors

## 3D Delta Reed Models - Compressor Parts

| Model<br>(Horse Power<br>Nomenclature) | Model<br>(BTU<br>Nomenclature) | Valve<br>Plate Kit | Valve Plate<br>Gasket | Motor<br>Protector Kit | Terminal Plate<br>Group |
|--|--------------------------------|--------------------|-----------------------|------------------------|-------------------------|
|  |                                | (998-)             | (920-)                | (998-)                 |                         |
| • 3DEHA075E-TFD                        | 3DEHR10ME-TFD                  | 2661-48            | 0981-02               | 0429-17                | 503-0390-00             |
| • 3DEHA075E-TFE                        | 3DEHR10ME-TFE                  | 2661-48            | 0981-02               | 0429-11                | 503-0390-00             |
| 3DF3A0750-TFC                          | 3DF3F26K0-TFC                  | 2661-43            | 0981-01               | 0429-04                | 521-0144-00             |
| 3DF3A0750-TFD                          | 3DF3F26K0-TFD                  | 2661-43            | 0981-01               | 0429-09                | 521-0144-00             |
| 3DF3A0900-TFC                          | 3DF3F40K0-TFC                  | 2661-43            | 0981-01               | 0429-00                | 503-0390-00             |
| 3DF3A0900-TFD                          | 3DF3F40K0-TFD                  | 2661-43            | 0981-01               | 0429-09                | 503-0390-00             |
| 3DF3A0900-TFE                          | 3DF3F40K0-TFE                  | 2661-43            | 0981-01               | 0429-11                | 503-0390-00             |
| 3DF3A090E-TFC                          | 3DF3F40KE-TFC                  | 2661-43            | 0981-01               | 0429-00                | 503-0390-00             |
| 3DF3A090E-TFD                          | 3DF3F40KE-TFD                  | 2661-43            | 0981-01               | 0429-09                | 503-0390-00             |
| 3DF3A090E-TFE                          | 3DF3F40KE-TFE                  | 2661-43            | 0981-01               | 0429-11                | 503-0390-00             |
| 3DF3A1200-TFC                          | 3DF3R15M0-TFC                  | 2661-43            | 0981-01               | 0451-02                | 503-0390-00             |
| 3DF3A1200-TFD                          | 3DF3R15M0-TFD                  | 2661-43            | 0981-01               | 0455-03                | 503-0390-00             |
| 3DF3A120E-TFC                          | 3DF3R15ME-TFC                  | 2661-43            | 0981-01               | 0451-02                | 503-0390-00             |
| 3DF3A120E-TFD                          | 3DF3R15ME-TFD                  | 2661-43            | 0981-01               | 0455-03                | 503-0390-00             |
| • 3DG3A0900-TFC                        | 3DG3F40K0-TFC                  | 2661-57            | 0981-01               | 0429-00                | 503-0390-00             |
| • 3DG3A0900-TFE                        | 3DG3F40K0-TFE                  | 2661-57            | 0981-01               | 0429-11                | 503-0390-00             |
| • 3DG3A090E-TFC                        | 3DG3F40KE-TFC                  | 2661-57            | 0981-01               | 0429-00                | 503-0390-00             |
| • 3DG3A090E-TFD                        | 3DG3F40KE-TFD                  | 2661-57            | 0981-01               | 0429-09                | 503-0390-00             |
| • 3DG3A090E-TFE                        | 3DG3F40KE-TFE                  | 2661-57            | 0981-01               | 0429-11                | 503-0390-00             |
| • 3DGHA090E-TFC                        | 3DGHF40KE-TFC                  | 2661-45            | 0981-01               | 0429-00                | 503-0390-00             |
| • 3DGHA090E-TFD                        | 3DGHF40KE-TFD                  | 2661-45            | 0981-01               | 0429-09                | 503-0390-00             |
| • 3DGHA090E-TFE                        | 3DGHF40KE-TFC                  | 2661-45            | 0981-01               | 0429-11                | 503-0390-00             |
| • 3DH3A0600-TFC                        | 3DH3F28K0-TFC                  | 2661-54            | 0981-02               | 0429-08                | 521-0144-00             |
| • 3DH3A0600-TFD                        | 3DH3F28K0-TFD                  | 2661-54            | 0981-02               | 0429-05                | 521-0144-00             |
| • 3DH3A0600-TFE                        | 3DH3F28K0-TFE                  | 2661-54            | 0981-02               | 0429-03                | 521-0144-00             |
| • 3DH3A060E-TFC                        | 3DH3F28KE-TFC                  | 2661-54            | 0981-02               | 0429-08                | 521-0144-00             |
| • 3DH3A060E-TFD                        | 3DH3F28KE-TFD                  | 2661-54            | 0981-02               | 0429-05                | 521-0144-00             |
| • 3DH3A060E-TFE                        | 3DH3F28KE-TFE                  | 2661-54            | 0981-02               | 0429-03                | 521-0144-00             |
| • 3DHHA060E-TFC                        | 3DHHF28KE-TFC                  | 2661-46            | 0981-02               | 0429-08                | 521-0144-00             |
| • 3DHHA060E-TFD                        | 3DHHF28KE-TFD                  | 2661-46            | 0981-02               | 0429-05                | 521-0144-00             |
| • 3DHHA060E-TFE                        | 3DHHF28KE-TFE                  | 2661-46            | 0981-02               | 0429-03                | 521-0144-00             |
| • 3DJ3A0750-TFC                        | 3DJ3F33K0-TFC                  | 2661-54            | 0981-00               | 0429-04                | 521-0144-00             |
| • 3DJ3A0750-TFD                        | 3DJ3F33K0-TFD                  | 2661-54            | 0981-00               | 0429-09                | 521-0144-00             |
| • 3DJ3A0750-TFE                        | 3DJ3F33K0-TFE                  | 2661-54            | 0981-00               | 0429-03                | 521-0144-00             |
| • 3DJ3A075E-TFC                        | 3DJ3F33KE-TFC                  | 2661-54            | 0981-00               | 0429-04                | 521-0144-00             |
| • 3DJ3A075E-TFD                        | 3DJ3F33KE-TFD                  | 2661-54            | 0981-00               | 0429-09                | 521-0144-00             |
| • 3DJ3A075E-TFE                        | 3DJ3F33KE-TFE                  | 2661-54            | 0981-00               | 0429-03                | 521-0144-00             |
| • 3DJHA075E-TFC                        | 3DJHF33KE-TFC                  | 2661-46            | 0981-00               | 0429-04                | 521-0144-00             |
| • 3DJHA075E-TFD                        | 3DJHF33KE-TFD                  | 2661-46            | 0981-00               | 0429-09                | 521-0144-00             |
| • 3DJHA075E-TFE                        | 3DJHF33KE-TFE                  | 2661-46            | 0981-00               | 0429-03                | 521-0144-00             |

• = Moduload

## 3D Delta Reed Models - Compressor Parts

| Model<br>(Horse Power<br>Nomenclature) | Model<br>(BTU<br>Nomenclature) | Valve<br>Plate Kit | Valve Plate<br>Gasket | Motor<br>Protector Kit | Terminal Plate<br>Group |
|--|--------------------------------|--------------------|-----------------------|------------------------|-------------------------|
|  |                                | (998-)             | (920-)                | (998-)                 |                         |
| • 3DK3A0750-TFC                        | N/A                            | 2661-56            | 0981-01               | 0429-04                | 521-0144-00             |
| • 3DK3A0750-TFD                        | N/A                            | 2661-56            | 0981-01               | 0429-09                | 521-0144-00             |
| • 3DK3A0900-TFC                        | N/A                            | 2661-56            | 0981-01               | 0429-00                | 503-0390-00             |
| • 3DK3A0900-TFD                        | N/A                            | 2661-56            | 0981-01               | 0429-09                | 503-0390-00             |
| • 3DK3A0900-TFE                        | N/A                            | 2661-56            | 0981-01               | 0429-11                | 503-0390-00             |
| • 3DK3A1200-TFC                        | 3DK3R15M0-TFC                  | 2661-56            | 0981-01               | 0451-02                | 503-0390-00             |
| • 3DK3A1200-TFD                        | 3DK3R15M0-TFD                  | 2661-56            | 0981-01               | 0455-03                | 503-0390-00             |
| • 3DK3A120E-TFC                        | 3DK3R15ME-TFC                  | 2661-56            | 0981-01               | 0451-02                | 503-0390-00             |
| • 3DK3A120E-TFD                        | 3DK3R15ME-TFD                  | 2661-56            | 0981-01               | 0455-03                | 503-0390-00             |
| • 3DKHA120E-TFC                        | 3DKHR15ME-TFC                  | 2661-44            | 0981-01               | 0451-02                | 503-0390-00             |
| • 3DKHA120E-TFD                        | 3DKHR15ME-TFD                  | 2661-44            | 0981-01               | 0455-03                | 503-0390-00             |
| • 3DP3A0500-TFC                        | N/A                            | 2661-55            | 0981-00               | 0429-02                | 521-0144-00             |
| • 3DP3A0500-TFD                        | N/A                            | 2661-55            | 0981-00               | 0429-03                | 521-0144-00             |
| • 3DP3A0500-TFE                        | N/A                            | 2661-55            | 0981-00               | 0429-19                | 521-0144-00             |
| • 3DP3A0750-TFC                        | N/A                            | 2661-55            | 0981-00               | 0429-04                | 521-0144-00             |
| • 3DP3A0750-TFD                        | N/A                            | 2661-55            | 0981-00               | 0429-09                | 521-0144-00             |
| • 3DP3A0750-TFE                        | N/A                            | 2661-55            | 0981-00               | 0429-03                | 521-0144-00             |
| • 3DP3A075E-TFD                        | N/A                            | 2661-55            | 0981-00               | 0429-09                | 521-0144-00             |
| • 3DP3A1000-TFC                        | 3DP3R12M0-TFC                  | 2661-55            | 0981-00               | 0429-06                | 503-0390-00             |
| • 3DP3A1000-TFD                        | 3DP3R12M0-TFD                  | 2661-55            | 0981-00               | 0429-17                | 503-0390-00             |
| • 3DP3A1000-TFE                        | 3DP3R12M0-TFE                  | 2661-55            | 0981-00               | 0429-11                | 503-0390-00             |
| • 3DP3A100E-TFC                        | 3DP3R12ME-TFC                  | 2661-55            | 0981-00               | 0429-06                | 503-0390-00             |
| • 3DP3A100E-TFD                        | 3DP3R12ME-TFD                  | 2661-55            | 0981-00               | 0429-17                | 503-0390-00             |
| • 3DP3A100E-TFE                        | 3DP3R12ME-TFE                  | 2661-55            | 0981-00               | 0429-11                | 503-0390-00             |
| • 3DPHA100E-TFC                        | 3DPHR12ME-TFC                  | 2661-47            | 0981-00               | 0429-06                | 503-0390-00             |
| • 3DPHA100E-TFD                        | 3DPHR12M3-TFD                  | 2661-47            | 0981-00               | 0429-17                | 503-0390-00             |
| • 3DPHA100E-TFE                        | 3DPHR12ME-TFE                  | 2661-47            | 0981-00               | 0429-11                | 503-0390-00             |
| • 3DR3A1000-TFC                        | 3DR3F46K0-TFC                  | 2661-57            | 0981-03               | 0429-00                | 503-0390-00             |
| • 3DR3A1000-TFD                        | 3DR3F46K0-TFD                  | 2661-57            | 0981-03               | 0429-09                | 503-0390-00             |
| • 3DR3A1000-TFE                        | 3DR3F46K0-TFE                  | 2661-57            | 0981-03               | 0429-11                | 503-0390-00             |
| • 3DRHA100E-TFC                        | 3DRHF46KE-TFC                  | 2661-45            | 0981-03               | 0429-00                | 503-0390-00             |
| • 3DRHA100E-TFD                        | 3DRHF46KE-TFD                  | 2661-45            | 0981-03               | 0429-09                | 503-0390-00             |
| • 3DRHA100E-TFE                        | 3DRHF46KE-TFE                  | 2661-45            | 0981-03               | 0429-11                | 503-0390-00             |
| 3DS3A0750-TFC                          | 3DS3F30K0-TFC                  | 2661-43            | 0981-03               | 0429-04                | 521-0144-00             |
| 3DS3A0750-TFD                          | 3DS3F30K0-TFD                  | 2661-43            | 0981-03               | 0429-09                | 521-0144-00             |
| 3DS3A0750-TFE                          | 3DS3F30K0-TFE                  | 2661-43            | 0981-03               | 0429-03                | 521-0144-00             |
| 3DS3A1000-TFC                          | 3DS3F46K0-TFC                  | 2661-43            | 0981-03               | 0429-00                | 503-0390-00             |
| 3DS3A1000-TFD                          | 3DS3F46K0-TFD                  | 2661-43            | 0981-03               | 0429-09                | 503-0390-00             |
| 3DS3A1000-TFE                          | 3DS3F46K0-TFE                  | 2661-43            | 0981-03               | 0429-11                | 503-0390-00             |
| 3DS3A100E-TFC                          | 3DS3F46KE-TFC                  | 2661-43            | 0981-03               | 0429-00                | 503-0390-00             |

• = Moduload

# 3D – Semi-Hermetic Compressors

## 3D Delta Reed Models - Compressor Parts

| Model<br>(Horse Power<br>Nomenclature) | Model<br>(BTU<br>Nomenclature) | Valve<br>Plate Kit | Valve Plate<br>Gasket | Motor<br>Protector Kit | Terminal Plate<br>Group |
|--|--------------------------------|--------------------|-----------------------|------------------------|-------------------------|
|  |                                | (998-)             | (920-)                | (998-)                 |                         |
| 3DS3A100E-TFD                          | 3DS3F46KE-TFD                  | 2661-43            | 0981-03               | 0429-09                | 503-0390-00             |
| 3DS3A100E-TFE                          | 3DS3F46KE-TFE                  | 2661-43            | 0981-03               | 0429-11                | 503-0390-00             |
| 3DS3A1500-TFC                          | 3DS3R17M0-TFC                  | 2661-51            | 0981-03               | 0504-04                | 503-0390-00             |
| 3DS3A1500-TFD                          | 3DS3R17M0-TFD                  | 2661-51            | 0981-03               | 0504-00                | 503-0390-00             |
| 3DS3A1500-TFE                          | 3DS3R17M0-TFE                  | 2661-51            | 0981-03               | 0504-01                | 503-0390-00             |
| 3DS3A150E-TFC                          | 3DS3R17ME-TFC                  | 2661-51            | 0981-03               | 0504-04                | 503-0390-00             |
| 3DS3A150E-TFD                          | 3DS3R17ME-TFD                  | 2661-51            | 0981-03               | 0504-00                | 503-0390-00             |
| 3DS3A150E-TFE                          | 3DS3R17ME-TFE                  | 2661-51            | 0981-03               | 0504-01                | 503-0390-00             |
| • 3DT3A0750-TFC                        | 3DT3R11M0-TFC                  | 2661-56            | 0981-03               | 0429-04                | 521-0144-00             |
| • 3DT3A0750-TFD                        | 3DT3R11M0-TFD                  | 2661-56            | 0981-03               | 0429-09                | 521-0144-00             |
| • 3DT3A0750-TFE                        | 3DT3R11M0-TFE                  | 2661-56            | 0981-03               | 0429-03                | 521-0144-00             |
| • 3DT3A1000-TFC                        | 3DT3R11M0-TFC                  | 2661-56            | 0981-03               | 0429-00                | 503-0390-00             |
| • 3DT3A1000-TFD                        | 3DT3R11M0-TFD                  | 2661-56            | 0981-03               | 0429-09                | 503-0390-00             |
| • 3DT3A1000-TFE                        | 3DT3R11M0-TFE                  | 2661-56            | 0981-03               | 0429-11                | 503-0390-00             |
| • 3DT3A1500-TFC                        | 3DT3R17M0-TFC                  | 2661-56            | 0981-03               | 0504-04                | 503-0390-00             |
| • 3DT3A1500-TFD                        | 3DT3R17M0-TFD                  | 2661-56            | 0981-03               | 0504-00                | 503-0390-00             |
| • 3DT3A1500-TFE                        | 3DT3R17M0-TFE                  | 2661-56            | 0981-03               | 0504-01                | 503-0390-00             |
| • 3DT3A150E-TFC                        | 3DT3R17ME-TFC                  | 2661-56            | 0981-03               | 0504-04                | 503-0390-00             |
| • 3DT3A150E-TFD                        | 3DT3R17ME-TFD                  | 2661-56            | 0981-03               | 0504-00                | 503-0390-00             |
| • 3DT3A150E-TFE                        | 3DT3R17ME-TFE                  | 2661-56            | 0981-03               | 0504-01                | 503-0390-00             |
| • 3DTHA150E-TFC                        | 3DTHR17ME-TFC                  | 2661-44            | 0981-03               | 0504-04                | 503-0390-00             |
| • 3DTHA150E-TFD                        | 3DTHR17ME-TFD                  | 2661-44            | 0981-03               | 0504-00                | 503-0390-00             |
| • 3DTHA150E-TFE                        | 3DTHR17ME-TFE                  | 2661-44            | 0981-03               | 0504-01                | 503-0390-00             |

• = Moduload

## 3D Digital Models - Compressor Parts

| Digital Model | Standard Model | Valve Plate Kit | Valve Plate Gasket | Terminal Plate Group | Motor Protector Kit |
|---------------|----------------|-----------------|--------------------|----------------------|---------------------|
|               |                | (998-)          | (920-)             |                      | (998-)              |
| 3DADF28KE-TFC | 3DA3F28KE-TFC  | 6661-31         | 0981-02            | 503-0346-01          | 0429-05             |
| 3DADF28KE-TFD | 3DA3F28KE-TFD  | 6661-31         | 0981-02            | 503-0346-01          | 0429-05             |
| 3DADF28KE-TFE | 3DA3F28KE-TFE  | 6661-31         | 0981-02            | 503-0346-01          | 0429-05             |
| 3DADR10ME-TFE | 3DA3R10ME-TFE  | 6661-30         | 0981-02            | 503-0804-00          | 0429-11             |
| 3DBDF33KE-TFC | 3DB3F33KE-TFC  | 6661-31         | 0981-02            | 503-0346-01          | 0429-04             |
| 3DBDF33KE-TFD | 3DB3F33KE-TFD  | 6661-31         | 0981-02            | 503-0346-01          | 0429-09             |
| 3DBDF33KE-TFE | 3DB3F33KE-TFE  | 6661-31         | 0981-02            | 503-0346-01          | 0429-03             |
| 3DBDR12ME-TFC | 3DB3R12ME-TFC  | 6661-30         | 0981-02            | 503-0804-00          | 0429-06             |
| 3DBDR12ME-TFD | 3DB3R12ME-TFD  | 6661-30         | 0981-02            | 503-0804-00          | 0429-17             |
| 3DBDR12ME-TFE | 3DB3R12ME-TFE  | 6661-30         | 0981-02            | 503-0804-00          | 0429-11             |
| 3DFDF40KE-TFC | 3DF3F40KE-TFC  | 6661-31         | 0981-02            | 503-0804-00          | 0429-00             |
| 3DFDF40KE-TFD | 3DF3F40KE-TFD  | 6661-31         | 0981-02            | 503-0804-00          | 0429-09             |
| 3DFDF40KE-TFE | 3DF3F40KE-TFE  | 6661-31         | 0981-02            | 503-0804-00          | 0429-11             |
| 3DFDR15ME-TFC | 3DF3R15ME-TFC  | 6661-30         | 0981-02            | 503-0804-00          | 0451-02             |
| 3DFDR15ME-TFD | 3DF3R15ME-TFD  | 6661-30         | 0981-02            | 503-0804-00          | 0455-03             |
| 3DSDF46KE-TFC | 3DS3F46KE-TFC  | 6661-31         | 0981-02            | 503-0804-00          | 0429-00             |
| 3DSDF46KE-TFD | 3DS3F46KE-TFD  | 6661-31         | 0981-03            | 503-0804-00          | 0429-09             |
| 3DSDF46KE-TFE | 3DS3F46KE-TFE  | 6661-31         | 0981-03            | 503-0804-00          | 0429-11             |
| 3SDSR17ME-TFC | 3DS3R17ME-TFC  | 6661-30         | 0981-03            | 503-0804-00          | 0451-01             |
| 3SDSR17ME-TFD | 3DS3R17ME-TFD  | 6661-30         | 0981-03            | 503-0804-00          | 0455-00             |
| 3SDSR17ME-TFE | 3DS3R17ME-TFE  | 6661-30         | 0981-03            | 503-0804-00          | 0455-02             |





# 3D – Semi-Hermetic Compressors

## 3D Compressor Capacity Control Kits

| Standard Model | Moduload Capacity Control Model for HFC Refrigerant | Moduload Conversion Kit for HFC Refrigerant | Moduload Capacity Control Model for CFC Refrigerant | Moduload Conversion Kit for CFC Refrigerant |
|----------------|---|---|---|---|
| 3DA3F28KE      | 3DHHF28KE   | 998-2017-42                                 | 3DH3F28K0   | 998-2017-47                                 |
| 3DA3R10ME      | 3DEHR10ME   | 998-2017-44                                 | 3DE3R10M0   | 998-2017-49                                 |
| 3DB3F33KE      | 3DJHF33KE   | 998-2017-42                                 | 3DJ3F33K0   | 998-2017-47                                 |
| 3DB3R12ME      | 3DPHR12ME   | 998-2017-43                                 | 3DP3R12M0   | 998-2017-48                                 |
| 3DF3F40KE      | 3DGHF40KE   | 998-2017-41                                 | 3DG3F40K0   | 998-2017-46                                 |
| 3DF3R15ME      | 3DKHR15ME   | 998-2017-40                                 | 3DK3R15M0   | 998-2017-45                                 |
| 3DS3F46KE      | 3DRHF46KE   | 998-2017-41                                 | 3DR3F46K0   | 998-2017-46                                 |
| 3DS3R17ME      | 3DTHR17ME   | 998-2017-40                                 | 3DT3R17M0   | 998-2017-45                                 |

NOTE: Capacity Control Kits listed above do not include Unloader Solenoid Valves

## Moduload Unloader Solenoid Valve Kits

| Valve Less Coil | With 24V Coil | With 120V Coil | With 240V Coil |
|-----------------|---------------|----------------|----------------|
| 998-0326-00     | 998-0326-01   | 998-0326-02    | 998-0326-03    |

## Digital Conversion Kits

| Standard Model | Digital Model | Digital Conversion Kit |
|----------------|---------------|------------------------|
| 3DA3F28KE      | 3DADF28KE     | 980-3000-01            |
| 3DA3R10ME      | 3DADR10ME     | 980-3000-00            |
| 3DB3F33KE      | 3DBDF33KE     | 980-3000-01            |
| 3DB3R12ME      | 3DBDR12ME     | 980-3000-00            |
| 3DF3F40KE      | 3DFDF40KE     | 980-3000-01            |
| 3DF3R15ME      | 3DFDR15ME     | 980-3000-00            |
| 3DS3F46KE      | 3DSDF46KE     | 980-3000-01            |
| 3DS3R17ME      | 3DSDR17ME     | 980-3000-00            |



## Digital Unloader Solenoid Valve Kits

| Valve Less Coil | 24V Coil Only | 120V Coil Only | 240V Coil Only |
|-----------------|---------------|----------------|----------------|
| 910-0111-00     | 923-0084-00   | 923-0084-01    | 923-0084-02    |

# Semi-Hermetic Compressors – 4D and 4R

| Compressor Cooling |                    |
|--------------------|--------------------|
| Code               | Description        |
| A                  | Air cooled         |
| D                  | Discus             |
| R                  | Refrigerant cooled |
| T                  | Std. two stage     |
| W                  | Water cooled       |

| Comp. Motor Rating Nominal |      |              |      |    |      |
|----------------------------|------|--------------|------|----|------|
| HP                         | Code | HP           | Code | HP | Code |
| 1/4                        | 0025 | 2-3/4        | 0275 | 15 | 1500 |
| 1/3                        | 0033 | 3 (0310)     | 0300 | 20 | 2000 |
| 1/2                        | 0050 | 3-1/2        | 0350 | 25 | 2500 |
| 3/4                        | 0075 | 4 (0406)     | 0400 | 30 | 3000 |
| 1                          | 0100 | 5 (0506)     | 0500 | 35 | 3500 |
| 1-1/4                      | 0125 | 6            | 0600 | 40 | 4000 |
| 1-1/2                      | 0150 | 7-1/2 (0766) | 0750 | 50 | 5000 |
| 1-3/4                      | 0175 | 9            | 0900 | 60 | 6000 |
| 2                          | 0200 | 10 (1015)    | 1000 |    |      |
| 2-1/2                      | 0250 | 12           | 1200 |    |      |

| Compressor Motor Type                       |      |
|---|------|
| Single Phase Motors                         | Code |
| Capacitor run - Capacitor start             | C    |
| Induction run - Capacitor start             | I    |
| Induction run - Split phase                 | S    |
| Induction run - Capacitor start, low torque | X    |
| Three Phase Motors                          | Code |
| General                                     | T    |
| 3 Lead single voltage                       |      |
| 6 Lead part winding (575 volt)              |      |
| 9 Lead dual voltage                         |      |
| Star (wye) delta                            | E    |
| 6 Lead motors                               | F    |
| Part winding or across the line             |      |

**Product Variations**  
Numbers will be assigned as follows:

- Numbers -001 through -199 are reserved for sub-b/m numbers.
- Numbers -200 indicates a standard compressor and component parts b/m and model no.
- Numbers -201 and larger will be assigned for all other variations of a given model.

**Tandem Style Models**  
Indicated by the digit representing the comp. model series connected in tandem with a comp. of the model series indicated by the first digit.

May be = (-) or A  
Note: Nominal horsepower rating of tandem compressors is sum of individual compressor ratings

## 4DA3 - 100E - TSK 800

| Compressor Family Series   |
|--|
| Either a number or a letter established for each product family. |

| Displacement and Valve Plate  |
|---|
| A letter only, arbitrarily assigned for each different displacement within any one family series. |

| Model Variation  |
|--|
| A number or letter, assigned to indicate different model types within any family series. |

| May also be          |
|----------------------|
| "A" = (Alkylbenzene) |
| "E" = (POE Oil)      |
| "L" = (Less Oil)     |

| Compressor Motor Protection  |      |
|--|------|
| Description  | Code |
| External inherent protection - one protector (line break) use with contactor   | A    |
| Internal inherent protection - one protector use with contactor  | F    |
| Internal thermostat(s); and ext, supplementary protector(s) use with contactor.  | H    |
| Internal thermostat(s); and three ext, supplementary protector(s) use with contactor.                                      | L    |
| Internal thermal protectors - electronic sensors; and control module external. Use with contactor.                         | S    |
| Internal thermal protectors - electronic sensors; and control module external. use with contactor (For European use only). | W    |

| Electrical Codes |               |      |                    |           |      |
|------------------|---------------|------|--------------------|-----------|------|
| 60 Hz            | 50 Hz         | Code | 60 Hz              | 50 Hz     | Code |
| 115-1            | 100-1         | A    | -                  | 220-1     | S    |
| 230-1            | 200-1         | B    | -                  | 200-1     | T    |
| 5206-230-3       | 200/220-3     | C    | 200-3              | -         | U    |
| 460-3            | 380/400-3     | D    | 208-230-1          | 200-1     | V    |
| 575-3            | 500-3         | E    | -                  | 200/220-3 | W    |
| -                | 115-1         | F    | Misc. A.C. Ratings | X         |      |
| -                | 230-1         | G    | -                  | 500-3     | Y    |
| 208-1            | 200-1         | H    | -                  | 220/240-1 | Z    |
| -                | 208/230-1     | I    | 200-1              | 200-1     | 3    |
| 208/230/460-3    | 200/400-3     | K    | 100-1              | 100-1     | 4    |
| -                | 210/240/380-3 | L    | 200-230-3          | -         | 5    |
| -                | 380-/420-3    | M    | 230-3              | -         | 6    |
| 230/460-3        | 200/400-3     | N    | 380                | 346       | 7    |
| -                | 200/380-3     | P    | 200/220/380        | 200/345   | 8    |
| -                | 200/240-3     | R    |                    |           |      |

\* When applicable, specific 50 HZ ratings (Not necessarily identical to typical shown above) will be shown as alternate on 60 HZ rated models.

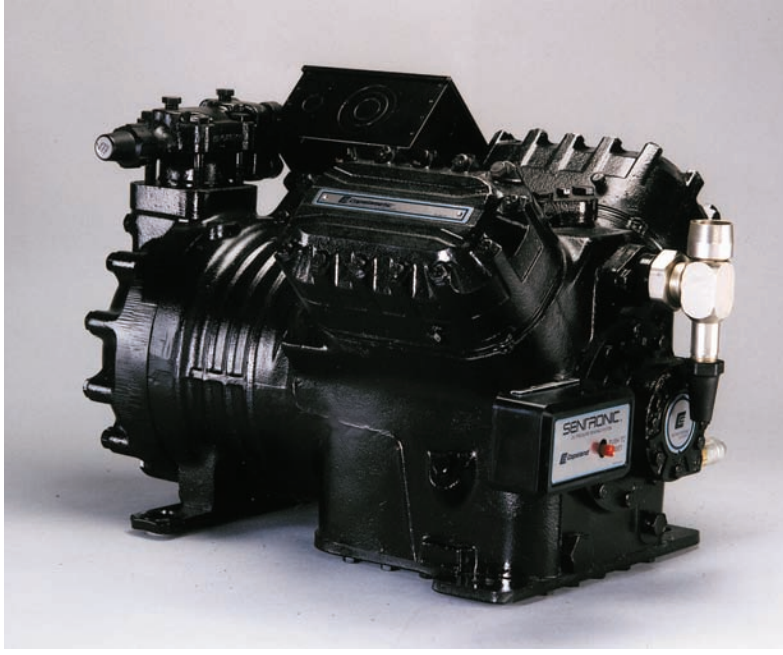

# 4D and 4R – Semi-Hermetic Compressors

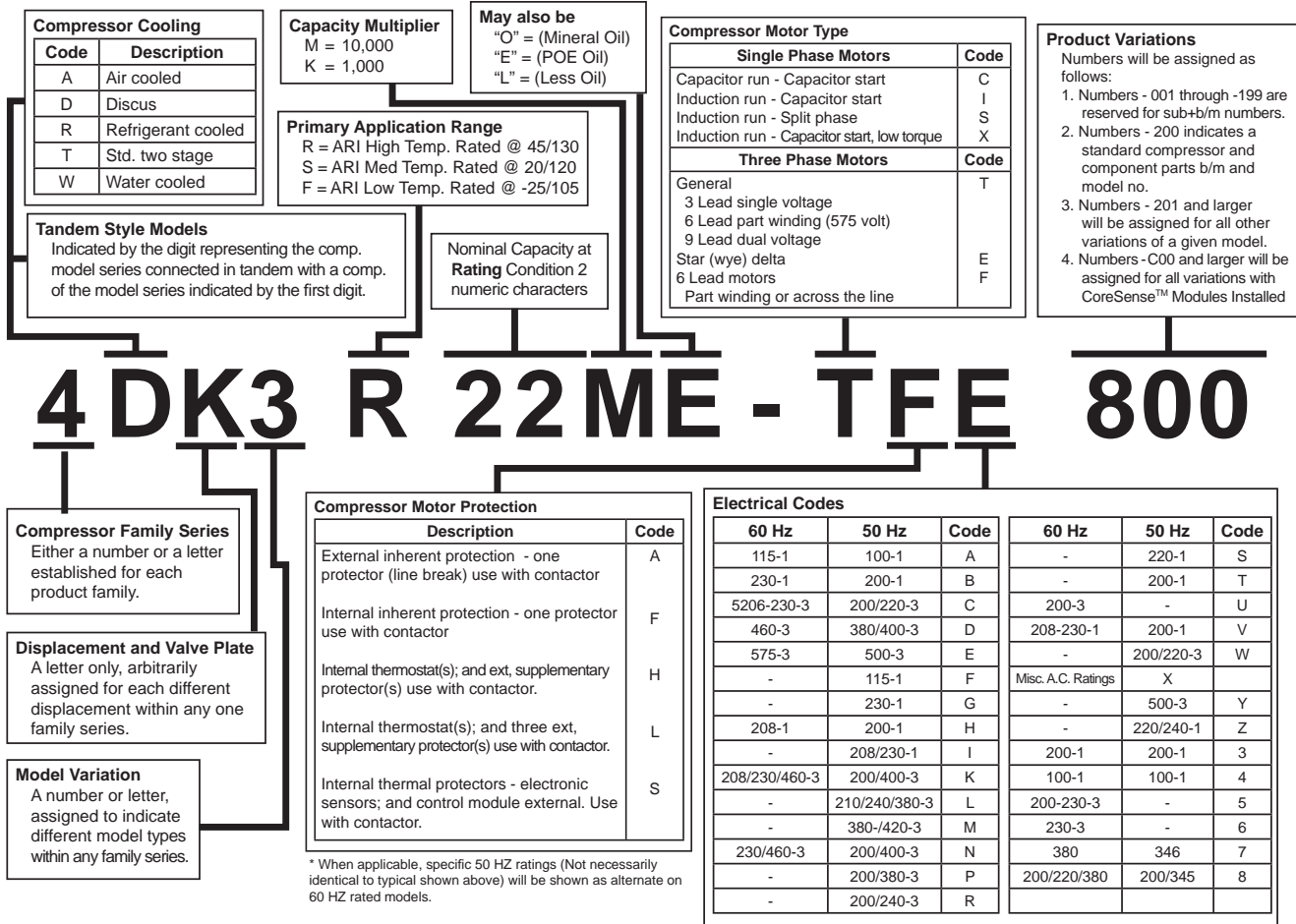

## New Model Nomenclature (5th Digit = Application Rating)

R = Rating at +45°F to +130°F at 90°F Ambient Air

S = Rating at +20°F to +120°F at 90°F Ambient Air

F = Rating at -25°F to +105°F at 90° Ambient Air

## Common Replacement Parts

| Common Parts                                  | Part Number |
|---|-------------|
| Sight Glass Kit                               | 998-0002-02 |
| Sight Glass O-Ring                            | 020-0844-05 |
| Oil Screen Kit                                | 998-0513-02 |
| Magnetic Plug Gasket - 1" Internal Thread     | 020-0006-52 |
| Magnetic Plug Gasket - 1 1/8" Internal Thread | 020-0006-38 |
| Oil Pump Kit                                  | 998-0008-33 |
| Suction Strainer Assembly                     | 548-0116-00 |
| Terminal Jumpers/Extensions                   | 521-0065-00 |
| Gaskets                                       | Part Number |
| Complete Gasket Set (Floating Reed)           | 998-1669-00 |
| Complete Gasket Set (Delta Reed)              | 998-2669-00 |
| Capacity Control Valve 4D*1/4D*3 Models       | 020-0783-00 |
| Capacity Control Blank Plate Full Load Gasket | 020-0931-00 |
| Housing Cover                                 | 020-0636-00 |
| Stator Cover                                  | 020-0755-00 |
| Bottom Plate                                  | 020-1265-00 |
| Oil Pump                                      | 020-1267-00 |
| Crankcase Heater (Flat Bottom Plate Models)   | Part Number |
| 120 Volt 100 Watt (US part# 918-0028-00)      | 518-0028-06 |
| 240 Volt 100 Watt (US part# 918-0028-01)      | 518-0028-07 |
| Crankcase Heater Sleeve                       | 030-0186-01 |
| Crankcase Heater (Deep Sump Models)           | Part Number |
| 120V 200 Watt All 4D*8, 4RJ2 & 4RR2 Models    | 918-0518-00 |
| 240V 200 Watt All 4D*8, 4RJ2 & 4RR2 Models    | 918-0518-01 |
| 480V 200 Watt All 4D*8, 4RJ2 & 4RR2 Models    | 918-0518-02 |
| CoreSense™ Kits and Parts                     | Part Number |
| CoreSense Module                              | 943-0128-00 |
| 4D/6D CoreSense Wiring Harness                | 929-0098-00 |
| CoreSense DLT Thermistor                      | 985-0109-50 |
| CoreSense Module Mounting Bracket/Stud Kit    | 974-1315-00 |
| CoreSense Current Torroid                     | 943-0064-00 |
| Sensor Only Kit                               | 998-0162-01 |
| Copper Gasket for Sensor                      | 020-0297-13 |
| O-Ring Gasket for Sensor                      | 020-0003-28 |
| Solid State Module                            | Part Number |
| 24 Volt Module                                | 998-0424-06 |
| 120/240 Volt Module                           | 998-0524-10 |
| Sensor Terminal Board                         | 580-0054-00 |
| Sentronic 3 Kits and Parts                    | Part Number |
| Complete Kit                                  | 585-1076-02 |
| Sensor and Cable Kit                          | 998-0162-00 |
| Sensor Only Kit                               | 998-0162-01 |
| Copper Gasket for Sensor                      | 020-0297-13 |
| O-Ring Gasket for Sensor                      | 020-0003-28 |



# 4D and 4R – Semi-Hermetic Compressors

| Blocked Suction Unloader Valve/<br>Coil (4D*1, 4D*3) | Part Number |             |
|--|-------------|-------------|
| Valve Less Coil                                      | 998-0212-00 |             |
| 24 Volt Valve and Coil Kit                           | 998-0212-01 |             |
| 24 Volt Coil Only                                    | 023-0091-00 | 023-0039-09 |
| 120 Volt Valve and Coil Kit                          | 998-0212-02 |             |
| 120 Volt Coil Only                                   | 023-0091-01 | 023-0039-10 |
| 240 Volt Valve and Coil Kit                          | 998-0212-03 |             |
| 240 Volt Coil Only                                   | 023-0091-02 | 023-0039-11 |
| Unloader Piston Kit                                  | 998-0130-00 |             |

| Digital Unloader Valves & Coils | Part Number |
|---------------------------------|-------------|
| Valve Less Coil - 4D*D models   | 910-0111-00 |
| 24V Coil Only Kit               | 923-0084-00 |
| 120V Coil Only Kit              | 923-0084-01 |
| 240V Coil Only Kit              | 923-0084-02 |
| Unloader Gasket - 4D*D models   | 020-1369-01 |
| IDCM Control Module             | 943-0088-00 |
| Discharge Thermistor            | 985-0109-07 |

## Cooling Fan Kits

| Cooling Fan Kits               | Part #      | Used On       |
|--------------------------------|-------------|---------------|
| 115 Volt Fan Motor Kit         | 998-0550-02 |               |
| 115 Volt Replacement Fan Motor | 998-0550-05 |               |
| 230 Volt Fan Motor Kit         | 998-0550-00 | 4R, 4DL & 4DT |
| 230 Volt Replacement Fan Motor | 998-0550-03 |               |
| 460 Volt Fan Motor Kit         | 998-0550-01 |               |
| 460 Volt Replacement Fan Motor | 998-0550-04 |               |
| Fan Mounting Kit               | 998-0574-03 | 4R & 4D*1     |
| Fan Mounting Kit               | 998-0574-12 | 4D*3          |
| Fan Blade                      | 083-0118-00 | 4R & 4D       |

## Service Valves

| Part #      | Size   | Discharge | Suction | Style       | MTG Center        | Thread    |
|-------------|--------|-----------|---------|-------------|-------------------|-----------|
| 998-0510-02 | 1 1/8" | X         |         | Rotalock    |                   | 1 3/7"-12 |
| 998-0510-46 | 1 3/8" | X         |         | Rotalock    |                   | 1 3/7"-12 |
| 998-0510-09 | 1 1/8" | X         |         | Bolt on (2) | 2 3/4" x 2 3/4"   |           |
| 998-0510-11 | 1 3/8" | X         |         | Bolt on (2) | 2 3/4" x 2 3/4"   |           |
| 998-0510-07 | 1 5/8" |           | X       | Bolt on (4) | 2 1/2" x 2 1/2"   |           |
| 998-0510-20 | 2 1/8" |           | X       | Bolt on (4) | 3 1/16" x 3 1/16" |           |

# Semi-Hermetic Compressors – 4D and 4R

## 4D Floating Reed Models - Compressor Parts

| Model           | Valve Plate Kit | Unloader Valve Plate Kit | Cylinder Head Gasket | Unloader Cylinder Head Gasket | Valve Plate Gasket | Terminal Plate Group |
|-----------------|-----------------|--------------------------|----------------------|-------------------------------|--------------------|----------------------|
|                 | (998-)          | (998-)                   | (020-)               | (020-)                        | (020-)             | (521-)               |
| 4DA1-1000-FSD   | 1661-26         |                          | 0600-00              |                               | 0664-07            | 0140-00              |
| 4DA1-1000-TSE   | 1661-26         |                          | 0600-00              |                               | 0664-07            | 0143-00              |
| 4DA1-1000-TSK   | 1661-26         |                          | 0600-00              |                               | 0664-07            | 0142-00              |
| 4DA1-2000-FSD   | 1661-27         |                          | 0600-00              |                               | 0664-07            | 0140-00              |
| 4DA1-2000-TSE   | 1661-27         |                          | 0600-00              |                               | 0664-07            | 0140-00              |
| 4DA1-2000-TSK   | 1661-27         |                          | 0600-00              |                               | 0664-07            | 0142-00              |
| 4DA2-1000-TSE   | 1661-26         |                          | 0600-00              |                               | 0664-07            | 0143-00              |
| 4DA2-2000-TSE   | 1661-27         |                          | 0600-00              |                               | 0664-07            | 0140-00              |
| 4DA2-2000-TSK   | 1661-27         |                          | 0600-00              |                               | 0664-07            | 0142-00              |
| 4DA3-1000-FSD   | 1661-26         |                          | 0600-00              |                               | 0664-07            | 0140-00              |
| 4DA3-1000-TSE   | 1661-26         |                          | 0600-00              |                               | 0664-07            | 0143-00              |
| 4DA3-1000-TSK   | 1661-26         |                          | 0600-00              |                               | 0664-07            | 0142-00              |
| 4DA3-100E-FSD   | 1661-26         |                          | 0600-00              |                               | 0664-07            | 0140-00              |
| 4DA3-100E-TSE   | 1661-26         |                          | 0600-00              |                               | 0664-07            | 0143-00              |
| 4DA3-100E-TSK   | 1661-26         |                          | 0600-00              |                               | 0664-07            | 0142-00              |
| 4DA3-1010-TSE   | 1661-26         |                          | 0600-00              |                               | 0664-07            | 0143-00              |
| 4DA3-1010-TSK   | 1661-26         |                          | 0600-00              |                               | 0664-07            | 0142-00              |
| 4DA3-101E-TSE   | 1661-26         |                          | 0600-00              |                               | 0664-07            | 0143-00              |
| 4DA3-101E-TSK   | 1661-26         |                          | 0600-00              |                               | 0664-07            | 0142-00              |
| 4DA3-2000-FSD   | 1661-27         |                          | 0600-00              |                               | 0664-07            | 0140-00              |
| 4DA3-2000-TSE   | 1661-27         |                          | 0600-00              |                               | 0664-07            | 0140-00              |
| 4DA3-2000-TSK   | 1661-27         |                          | 0600-00              |                               | 0664-07            | 0142-00              |
| 4DA3-200E-FSD   | 1661-27         |                          | 0600-00              |                               | 0664-07            | 0140-00              |
| 4DA3-200E-TSE   | 1661-27         |                          | 0600-00              |                               | 0664-07            | 0140-00              |
| 4DA3-200E-TSK   | 1661-27         |                          | 0600-00              |                               | 0664-07            | 0142-00              |
| 4DA4-2000-TSK   | 1661-27         |                          | 0600-00              |                               | 0664-07            | 0142-00              |
| 4DB3-2200-FSD   | 1661-27         |                          | 0600-00              |                               | 0664-07            | 0140-00              |
| 4DB3-2200-TSE   | 1661-27         |                          | 0600-00              |                               | 0664-03            | 0140-00              |
| 4DB3-2200-TSK   | 1661-27         |                          | 0600-00              |                               | 0664-03            | 0142-00              |
| 4DB3-220E-FSD   | 1661-27         |                          | 0600-00              |                               | 0664-03            | 0140-00              |
| 4DB3-220E-TSE   | 1661-27         |                          | 0600-00              |                               | 0664-03            | 0140-00              |
| 4DB3-220E-TSK   | 1661-27         |                          | 0600-00              |                               | 0664-03            | 0142-00              |
| • 4DC3-2200-FSD | 1661-27         | 1661-28                  | 0600-00              | 0616-00                       | 0664-03            | 0140-00              |
| • 4DC3-2200-TSE | 1661-27         | 1661-28                  | 0600-00              | 0616-00                       | 0664-03            | 0140-00              |
| • 4DC3-2200-TSK | 1661-27         | 1661-28                  | 0600-00              | 0616-00                       | 0664-03            | 0142-00              |
| • 4DC3-220E-FSD | 1661-27         | 1661-28                  | 0600-00              | 0616-00                       | 0664-03            | 0140-00              |
| • 4DC3-220E-TSE | 1661-27         | 1661-28                  | 0600-00              | 0616-00                       | 0664-03            | 0140-00              |
| • 4DC3-220E-TSK | 1661-27         | 1661-28                  | 0600-00              | 0616-00                       | 0664-03            | 0142-00              |

• = 1 Bank Unloading



# 4D and 4R – Semi-Hermetic Compressors

## 4D Floating Reed Models - Compressor Parts

| Model           | Valve Plate Kit | Unloader Valve Plate Kit | Cylinder Head Gasket | Unloader Cylinder Head Gasket | Valve Plate Gasket | Terminal Plate Group |
|-----------------|-----------------|--------------------------|----------------------|-------------------------------|--------------------|----------------------|
|                 | (998-)          | (998-)                   | (020-)               | (020-)                        | (020-)             | (521-)               |
| • 4DE1-1000-TSE | 1661-26         | 1661-25                  | 0600-00              | 0616-00                       | 0664-07            | 0143-00              |
| • 4DE1-1000-TSK | 1661-26         | 1661-25                  | 0600-00              | 0616-00                       | 0664-07            | 0142-00              |
| • 4DE1-2000-FSD | 1661-27         | 1661-28                  | 0600-00              | 0616-00                       | 0664-07            | 0140-00              |
| • 4DE1-2000-TSE | 1661-27         | 1661-28                  | 0600-00              | 0616-00                       | 0664-07            | 0140-00              |
| • 4DE1-2000-TSK | 1661-27         | 1661-28                  | 0600-00              | 0616-00                       | 0664-07            | 0142-00              |
| • 4DE2-2000-TSK | 1661-27         | 1661-28                  | 0600-00              | 0616-00                       | 0664-07            | 0142-00              |
| • 4DE3-100E-TSK | 1661-26         | 1661-25                  | 0600-00              | 0616-00                       | 0664-07            | 0142-00              |
| • 4DE3-2000-FSD | 1661-27         | 1661-28                  | 0600-00              | 0616-00                       | 0664-07            | 0140-00              |
| • 4DE3-2000-TSE | 1661-27         | 1661-28                  | 0600-00              | 0616-00                       | 0664-07            | 0140-00              |
| • 4DE3-2000-TSK | 1661-27         | 1661-28                  | 0600-00              | 0616-00                       | 0664-07            | 0142-00              |
| • 4DE3-200E-FSD | 1661-27         | 1661-28                  | 0600-00              | 0616-00                       | 0664-07            | 0140-00              |
| • 4DE3-200E-TSE | 1661-27         | 1661-28                  | 0600-00              | 0616-00                       | 0664-07            | 0140-00              |
| • 4DE3-200E-TSK | 1661-27         | 1661-28                  | 0600-00              | 0616-00                       | 0664-07            | 0142-00              |
| • 4DE4-2000-TSK | 1661-27         | 1661-28                  | 0600-00              | 0616-00                       | 0664-07            | 0142-00              |
| • 4DE5-2000-TSK | 1661-27         | 1661-28                  | 0600-00              | 0616-00                       | 0664-07            | 0142-00              |
| • 4DE8-2000-FSD | 1661-27         | 1661-28                  | 0600-00              | 0616-00                       | 0664-07            | 0140-00              |
| • 4DE8-200E-TSK | 1661-27         | 1661-28                  | 0600-00              | 0616-00                       | 0664-07            | 0142-00              |
| 4DH1-1500-FSD   | 1661-26         |                          | 0600-00              |                               | 0664-03            | 0140-00              |
| 4DH1-1500-TSE   | 1661-26         |                          | 0600-00              |                               | 0664-03            | 0143-00              |
| 4DH1-1500-TSK   | 1661-26         |                          | 0600-00              |                               | 0664-03            | 0142-00              |
| 4DH1-2500-FSD   | 1661-27         |                          | 0600-00              |                               | 0664-03            | 0140-00              |
| 4DH1-2500-TSE   | 1661-27         |                          | 0600-00              |                               | 0664-03            | 0140-00              |
| 4DH1-2500-TSK   | 1661-27         |                          | 0600-00              |                               | 0664-03            | 0142-00              |
| 4DH3-150E-TSE   | 1661-26         |                          | 0600-00              |                               | 0664-03            | 0143-00              |
| 4DH3-150E-TSK   | 1661-26         |                          | 0600-00              |                               | 0664-03            | 0142-00              |
| 4DH3-2500-FSD   | 1661-27         |                          | 0600-00              |                               | 0664-03            | 0140-00              |
| 4DH3-2500-TSE   | 1661-27         |                          | 0600-00              |                               | 0664-03            | 0140-00              |
| 4DH3-2500-TSK   | 1661-27         |                          | 0600-00              |                               | 0664-03            | 0142-00              |
| 4DH3-250E-FSD   | 1661-27         |                          | 0600-00              |                               | 0664-03            | 0140-00              |
| 4DH3-250E-TSE   | 1661-27         |                          | 0600-00              |                               | 0664-03            | 0140-00              |
| 4DH3-250E-TSK   | 1661-27         |                          | 0600-00              |                               | 0664-03            | 0142-00              |
| 4DHB-1500-TSE   | 1661-26         |                          | 0600-00              |                               | 0664-03            | 0143-00              |
| 4DHB-1500-TSK   | 1661-26         |                          | 0600-00              |                               | 0664-03            | 0142-00              |
| 4DJ1-2000-FSD   | 1661-26         |                          | 0600-00              |                               | 0664-05            | 0140-00              |
| 4DJ1-2000-TSE   | 1661-26         |                          | 0600-00              |                               | 0664-05            | 0140-00              |
| 4DJ1-2000-TSK   | 1661-26         |                          | 0600-00              |                               | 0664-05            | 0142-00              |
| 4DJ1-3000-FSD   | 1661-27         |                          | 0600-00              |                               | 0664-05            | 0140-00              |
| 4DJ1-3000-TSE   | 1661-27         |                          | 0600-00              |                               | 0664-05            | 0140-00              |

• = 1 Bank Unloading

# Semi-Hermetic Compressors – 4D and 4R

## 4D Floating Reed Models - Compressor Parts

| Model           | Valve Plate Kit | Unloader Valve Plate Kit | Cylinder Head Gasket | Unloader Cylinder Head Gasket | Valve Plate Gasket | Terminal Plate Group |
|-----------------|-----------------|--------------------------|----------------------|-------------------------------|--------------------|----------------------|
|                 | (998-)          | (998-)                   | (020-)               | (020-)                        | (020-)             | (521-)               |
| 4DJ1-3000-TSK   | 1661-27         |                          | 0600-00              |                               | 0664-05            | 0142-00              |
| 4DJ2-2000-TSK   | 1661-26         |                          | 0600-00              |                               | 0664-05            | 0142-00              |
| 4DJ2-3000-TSK   | 1661-27         |                          | 0600-00              |                               | 0664-05            | 0142-00              |
| 4DJ3-200E-TSE   | 1661-26         |                          | 0600-00              |                               | 0664-05            | 0140-00              |
| 4DJ3-200E-TSK   | 1661-26         |                          | 0600-00              |                               | 0664-05            | 0142-00              |
| 4DJ3-3000-FSD   | 1661-27         |                          | 0600-00              |                               | 0664-05            | 0140-00              |
| 4DJ3-3000-TSE   | 1661-27         |                          | 0600-00              |                               | 0664-05            | 0140-00              |
| 4DJ3-3000-TSK   | 1661-27         |                          | 0600-00              |                               | 0664-05            | 0142-00              |
| 4DJ3-300E-FSD   | 1661-27         |                          | 0600-00              |                               | 0664-05            | 0140-00              |
| 4DJ3-300E-TSE   | 1661-27         |                          | 0600-00              |                               | 0664-05            | 0140-00              |
| 4DJ3-300E-TSK   | 1661-27         |                          | 0600-00              |                               | 0664-05            | 0142-00              |
| 4DJ8-200E-TSK   | 1661-26         |                          | 0600-00              |                               | 0664-05            | 0142-00              |
| 4DJ8-3000-TSK   | 1661-26         |                          | 0600-00              |                               | 0664-05            | 0142-00              |
| • 4DK1-1500-TSK | 1661-26         | 1661-25                  | 0600-00              | 0616-00                       | 0664-03            | 0142-00              |
| • 4DK1-2500-FSD | 1661-27         | 1661-28                  | 0600-00              | 0616-00                       | 0664-03            | 0140-00              |
| • 4DK1-2500-TSE | 1661-27         | 1661-28                  | 0600-00              | 0616-00                       | 0664-03            | 0140-00              |
| • 4DK1-2500-TSK | 1661-27         | 1661-28                  | 0600-00              | 0616-00                       | 0664-03            | 0142-00              |
| • 4DK3-150E-FSM | 1661-26         | 1661-25                  | 0600-00              | 0616-00                       | 0664-03            | 0140-00              |
| • 4DK3-150E-TSE | 1661-26         | 1661-25                  | 0600-00              | 0616-00                       | 0664-03            | 0143-00              |
| • 4DK3-150E-TSK | 1661-26         | 1661-25                  | 0600-00              | 0616-00                       | 0664-03            | 0142-00              |
| • 4DK3-2500-FSD | 1661-27         | 1661-28                  | 0600-00              | 0616-00                       | 0664-03            | 0140-00              |
| • 4DK3-2500-TSE | 1661-27         | 1661-28                  | 0600-00              | 0616-00                       | 0664-03            | 0140-00              |
| • 4DK3-2500-TSK | 1661-27         | 1661-28                  | 0600-00              | 0616-00                       | 0664-03            | 0142-00              |
| • 4DK3-250E-FSD | 1661-27         | 1661-28                  | 0600-00              | 0616-00                       | 0664-03            | 0140-00              |
| • 4DK3-250E-TSE | 1661-27         | 1661-28                  | 0600-00              | 0616-00                       | 0664-03            | 0140-00              |
| • 4DK3-250E-TSK | 1661-27         | 1661-28                  | 0600-00              | 0616-00                       | 0664-03            | 0142-00              |
| 4DL1-1500-FSD   | 1661-26         | 1661-25                  | 0600-00              |                               | 0664-03            | 0140-00              |
| 4DL1-1500-TSE   | 1661-26         | 1661-25                  | 0600-00              |                               | 0664-03            | 0143-00              |
| 4DL1-1500-TSK   | 1661-26         | 1661-25                  | 0600-00              |                               | 0664-03            | 0142-00              |
| 4DL3-1500-FSD   | 1661-26         | 1661-25                  | 0600-00              |                               | 0664-03            | 0140-00              |
| 4DL3-1500-TSE   | 1661-26         | 1661-25                  | 0600-00              |                               | 0664-03            | 0143-00              |
| 4DL3-1500-TSK   | 1661-26         | 1661-25                  | 0600-00              |                               | 0664-03            | 0142-00              |
| 4DL3-150E-FSD   | 1661-26         | 1661-25                  | 0600-00              |                               | 0664-03            | 0140-00              |
| 4DL3-150E-TSE   | 1661-26         | 1661-25                  | 0600-00              |                               | 0664-03            | 0143-00              |
| 4DL3-150E-TSK   | 1661-26         | 1661-25                  | 0600-00              |                               | 0664-03            | 0142-00              |
| • 4DN1-1000-FSD | 1661-26         | 1661-25                  | 0600-00              | 0616-00                       | 0664-07            | 0140-00              |
| • 4DN1-1000-TSE | 1661-26         | 1661-25                  | 0600-00              | 0616-00                       | 0664-07            | 0143-00              |
| • 4DN1-1000-TSK | 1661-26         | 1661-25                  | 0600-00              | 0616-00                       | 0664-07            | 0142-00              |

• = 1 Bank Unloading

# 4D and 4R – Semi-Hermetic Compressors

## 4D Floating Reed Models - Compressor Parts

| Model           | Valve Plate Kit | Unloader Valve Plate Kit | Cylinder Head Gasket | Unloader Cylinder Head Gasket | Valve Plate Gasket | Terminal Plate Group |
|-----------------|-----------------|--------------------------|----------------------|-------------------------------|--------------------|----------------------|
|                 | (998-)          | (998-)                   | (020-)               | (020-)                        | (020-)             | (521-)               |
| • 4DN3-1000-FSD | 1661-26         | 1661-25                  | 0600-00              | 0616-00                       | 0664-07            | 0140-00              |
| • 4DN3-1000-TSE | 1661-26         | 1661-25                  | 0600-00              | 0616-00                       | 0664-07            | 0143-00              |
| • 4DN3-1000-TSK | 1661-26         | 1661-25                  | 0600-00              | 0616-00                       | 0664-07            | 0142-00              |
| • 4DN3-100E-FSD | 1661-26         | 1661-25                  | 0600-00              | 0616-00                       | 0664-07            | 0140-00              |
| • 4DN3-100E-TSE | 1661-26         | 1661-25                  | 0600-00              | 0616-00                       | 0664-07            | 0143-00              |
| • 4DN3-1010-TSE | 1661-26         | 1661-25                  | 0600-00              | 0616-00                       | 0664-07            | 0143-00              |
| • 4DN3-1010-TSK | 1661-26         | 1661-25                  | 0600-00              | 0616-00                       | 0664-07            | 0142-00              |
| • 4DN3-101E-TSE | 1661-26         | 1661-25                  | 0600-00              | 0616-00                       | 0664-07            | 0143-00              |
| • 4DN3-101E-TSK | 1661-26         | 1661-25                  | 0600-00              | 0616-00                       | 0664-07            | 0142-00              |
| • 4DP1-1500-FSD | 1661-26         | 1661-25                  | 0600-00              | 0616-00                       | 0664-03            | 0140-00              |
| • 4DP1-1500-TSK | 1661-26         | 1661-25                  | 0600-00              | 0616-00                       | 0664-03            | 0142-00              |
| • 4DP3-1500-FSD | 1661-26         | 1661-25                  | 0600-00              | 0616-00                       | 0664-03            | 0140-00              |
| • 4DP3-1500-TSE | 1661-26         | 1661-25                  | 0600-00              | 0616-00                       | 0664-03            | 0143-00              |
| • 4DP3-1500-TSK | 1661-26         | 1661-25                  | 0600-00              | 0616-00                       | 0664-03            | 0142-00              |
| • 4DP3-150E-FSD | 1661-26         | 1661-25                  | 0600-00              | 0616-00                       | 0664-03            | 0140-00              |
| • 4DP3-150E-TSE | 1661-26         | 1661-25                  | 0600-00              | 0616-00                       | 0664-03            | 0143-00              |
| • 4DP3-150E-TSK | 1661-26         | 1661-25                  | 0600-00              | 0616-00                       | 0664-03            | 0142-00              |
| • 4DP8-1500-TSK | 1661-26         | 1661-25                  | 0600-00              | 0616-00                       | 0664-03            | 0142-00              |
| • 4DP8-150E-TSK | 1661-26         | 1661-25                  | 0600-00              | 0616-00                       | 0664-03            | 0142-00              |
| • 4DR1-2000-TSE | 1661-26         | 1661-28                  | 0600-00              | 0616-00                       | 0664-05            | 0140-00              |
| • 4DR1-2000-TSK | 1661-26         | 1661-28                  | 0600-00              | 0616-00                       | 0664-05            | 0142-00              |
| • 4DR1-3000-FSD | 1661-27         | 1661-28                  | 0600-00              | 0616-00                       | 0664-05            | 0140-00              |
| • 4DR1-3000-TSE | 1661-27         | 1661-28                  | 0600-00              | 0616-00                       | 0664-05            | 0140-00              |
| • 4DR1-3000-TSK | 1661-27         | 1661-28                  | 0600-00              | 0616-00                       | 0664-05            | 0142-00              |
| • 4DR3-200E-FSM | 1661-26         | 1661-28                  | 0600-00              | 0616-00                       | 0664-05            | 0140-00              |
| • 4DR3-200E-TSE | 1661-26         | 1661-28                  | 0600-00              | 0616-00                       | 0664-05            | 0140-00              |
| • 4DR3-200E-TSK | 1661-26         | 1661-28                  | 0600-00              | 0616-00                       | 0664-05            | 0142-00              |
| • 4DR3-3000-FSD | 1661-27         | 1661-28                  | 0600-00              | 0616-00                       | 0664-05            | 0140-00              |
| • 4DR3-3000-TSE | 1661-27         | 1661-28                  | 0600-00              | 0616-00                       | 0664-05            | 0140-00              |
| • 4DR3-3000-TSK | 1661-27         | 1661-28                  | 0600-00              | 0616-00                       | 0664-05            | 0142-00              |
| • 4DR3-300E-FSD | 1661-27         | 1661-28                  | 0600-00              | 0616-00                       | 0664-05            | 0140-00              |
| • 4DR3-300E-TSE | 1661-27         | 1661-28                  | 0600-00              | 0616-00                       | 0664-05            | 0140-00              |
| • 4DR3-300E-TSK | 1661-27         | 1661-28                  | 0600-00              | 0616-00                       | 0664-05            | 0142-00              |
| • 4DR8-200E-TSK | 1661-27         | 1661-28                  | 0600-00              | 0616-00                       | 0664-05            | 0142-00              |
| • 4DRB-2000-TSE | 1661-26         | 1661-28                  | 0600-00              | 0616-00                       | 0664-05            | 0140-00              |
| • 4DRB-2000-TSK | 1661-26         | 1661-28                  | 0600-00              | 0616-00                       | 0664-05            | 0142-00              |
| • 4DS1-2200-FSD | 1661-26         | 1661-25                  | 0600-00              | 0616-00                       | 0664-05            | 0140-00              |
| • 4DS1-2200-TSE | 1661-26         | 1661-25                  | 0600-00              | 0616-00                       | 0664-05            | 0140-00              |

• = 1 Bank Unloading

# Semi-Hermetic Compressors – 4D and 4R

## 4D Floating Reed Models - Compressor Parts

| Model           | Valve Plate Kit | Unloader Valve Plate Kit | Cylinder Head Gasket | Unloader Cylinder Head Gasket | Valve Plate Gasket | Terminal Plate Group |
|-----------------|-----------------|--------------------------|----------------------|-------------------------------|--------------------|----------------------|
|                 | (998-)          | (998-)                   | (020-)               | (020-)                        | (020-)             | (521-)               |
| • 4DS1-2200-TSK | 1661-26         | 1661-25                  | 0600-00              | 0616-00                       | 0664-05            | 0142-00              |
| • 4DS3-2200-FSD | 1661-26         | 1661-25                  | 0600-00              | 0616-00                       | 0664-05            | 0140-00              |
| • 4DS3-2200-TSE | 1661-26         | 1661-25                  | 0600-00              | 0616-00                       | 0664-05            | 0140-00              |
| • 4DS3-2200-TSK | 1661-26         | 1661-25                  | 0600-00              | 0616-00                       | 0664-05            | 0142-00              |
| • 4DS3-220E-FSD | 1661-26         | 1661-25                  | 0600-00              | 0616-00                       | 0664-05            | 0140-00              |
| • 4DS3-220E-TSE | 1661-26         | 1661-25                  | 0600-00              | 0616-00                       | 0664-05            | 0140-00              |
| • 4DS3-220E-TSK | 1661-26         | 1661-25                  | 0600-00              | 0616-00                       | 0664-05            | 0142-00              |
| 4DT1-2200-FSD   | 1661-26         |                          | 0600-00              |                               | 0664-05            | 0140-00              |
| 4DT1-2200-TSE   | 1661-26         |                          | 0600-00              |                               | 0664-05            | 0140-00              |
| 4DT1-2200-TSK   | 1661-26         |                          | 0600-00              |                               | 0664-05            | 0142-00              |
| 4DT3-2200-FSD   | 1661-26         |                          | 0600-00              |                               | 0664-05            | 0140-00              |
| 4DT3-2200-TSE   | 1661-26         |                          | 0600-00              |                               | 0664-05            | 0140-00              |
| 4DT3-2200-TSK   | 1661-26         |                          | 0600-00              |                               | 0664-05            | 0142-00              |
| 4DT3-220E-FSD   | 1661-26         |                          | 0600-00              |                               | 0664-05            | 0140-00              |
| 4DT3-220E-TSE   | 1661-26         |                          | 0600-00              |                               | 0664-05            | 0140-00              |
| 4DT3-220E-TSK   | 1661-26         |                          | 0600-00              |                               | 0664-05            | 0142-00              |

• = 1 Bank Unloading

# 4D and 4R – Semi-Hermetic Compressors

## 4D Delta Reed Models - Compressor Parts

| Model<br>(Horse Power<br>Nomenclature) | New Model<br>(BTU<br>Nomenclature) | Delta<br>Valve<br>Plate Kit | Unloader<br>Valve<br>Plate Kit | Cylinder<br>Head<br>Gasket | Unloader<br>Cylinder<br>Head<br>Gasket | Valve<br>Plate<br>Gasket | Terminal<br>Plate<br>Group |
|--|------------------------------------|-----------------------------|--------------------------------|----------------------------|--|--------------------------|----------------------------|
|  |                                    | (998-)                      | (998-)                         | (020-)                     | (020-)                                 | (020-)                   | (521-)                     |
| 4DA1A1000-FSD                          | 4DA1R12M0-FSD                      | 2661-26                     |                                | 0600-00                    |  | 1235-05                  | 0140-00                    |
| 4DA1A1000-TSE                          | 4DA1R12M0-TSE                      | 2661-26                     |                                | 0600-00                    |  | 1235-05                  | 0143-00                    |
| 4DA1A1000-TSK                          | 4DA1R12M0-TSK                      | 2661-26                     |                                | 0600-00                    |  | 1235-05                  | 0142-00                    |
| 4DA1A2000-FSD                          | 4DA1R18M0-FSD                      | 2661-27                     |                                | 0600-00                    |  | 1235-05                  | 0140-00                    |
| 4DA1A2000-TSE                          | 4DA1R18M0-TSE                      | 2661-27                     |                                | 0600-00                    |  | 1235-05                  | 0140-00                    |
| 4DA1A2000-TSK                          | 4DA1R18M0-TSK                      | 2661-27                     |                                | 0600-00                    |  | 1235-05                  | 0142-00                    |
| 4DA2A1000-TSE                          | 4DA2R12M0-TSE                      | 2661-26                     |                                | 0600-00                    |  | 1235-05                  | 0143-00                    |
| 4DA2A2000-TSE                          | 4DA2R18M0-TSE                      | 2661-27                     |                                | 0600-00                    |  | 1235-05                  | 0140-00                    |
| 4DA2A2000-TSK                          | 4DA2R18M0-TSK                      | 2661-27                     |                                | 0600-00                    |  | 1235-05                  | 0142-00                    |
| 4DA3A1000-FSD                          | 4DA3R12M0-FSD                      | 2661-26                     |                                | 0600-00                    |  | 1235-05                  | 0140-00                    |
| 4DA3A1000-TSE                          | 4DA3R12M0-TSE                      | 2661-26                     |                                | 0600-00                    |  | 1235-05                  | 0143-00                    |
| 4DA3A1000-TSK                          | 4DA3R12M0-TSK                      | 2661-26                     |                                | 0600-00                    |  | 1235-05                  | 0142-00                    |
| 4DA3A100E-FSD                          | 4DA3R12ME-FSD                      | 2661-26                     |                                | 0600-00                    |  | 1235-05                  | 0140-00                    |
| 4DA3A100E-TSE                          | 4DA3R12ME-TSE                      | 2661-26                     |                                | 0600-00                    |  | 1235-05                  | 0143-00                    |
| 4DA3A100E-TSK                          | 4DA3R12ME-TSK                      | 2661-26                     |                                | 0600-00                    |  | 1235-05                  | 0142-00                    |
| 4DA3A1010-TSE                          | 4DA3F47K0-TSE                      | 2661-26                     |                                | 0600-00                    |  | 1235-05                  | 0143-00                    |
| 4DA3A1010-TSK                          | 4DA3F47K0-TSK                      | 2661-26                     |                                | 0600-00                    |  | 1235-05                  | 0142-00                    |
| 4DA3A101E-TSE                          | 4DA3F47KE-TSE                      | 2661-26                     |                                | 0600-00                    |  | 1235-05                  | 0143-00                    |
| 4DA3A101E-TSK                          | 4DA3F47KE-TSK                      | 2661-26                     |                                | 0600-00                    |  | 1235-05                  | 0142-00                    |
| 4DA3A2000-FSD                          | 4DA3R18M0-FSD                      | 2661-27                     |                                | 0600-00                    |  | 1235-05                  | 0140-00                    |
| 4DA3A2000-TSE                          | 4DA3R18M0-TSE                      | 2661-27                     |                                | 0600-00                    |  | 1235-05                  | 0140-00                    |
| 4DA3A2000-TSK                          | 4DA3R18M0-TSK                      | 2661-27                     |                                | 0600-00                    |  | 1235-05                  | 0142-00                    |
| 4DA3A200E-FSD                          | 4DA3R18ME-FSD                      | 2661-27                     |                                | 0600-00                    |  | 1235-05                  | 0140-00                    |
| 4DA3A200E-TSE                          | 4DA3R18ME-TSE                      | 2661-27                     |                                | 0600-00                    |  | 1235-05                  | 0140-00                    |
| 4DA3A200E-TSK                          | 4DA3R18ME-TSK                      | 2661-27                     |                                | 0600-00                    |  | 1235-05                  | 0142-00                    |
| 4DA4A2000-TSK                          | 4DA4R18M0-TSK                      | 2661-27                     |                                | 0600-00                    |  | 1235-05                  | 0142-00                    |
| 4DB3A2200-FSD                          | 4DB3R20M0-FSD                      | 2661-27                     |                                | 0600-00                    |  | 1235-01                  | 0140-00                    |
| 4DB3A2200-TSE                          | 4DB3R20M0-TSE                      | 2661-27                     |                                | 0600-00                    |  | 1235-01                  | 0140-00                    |
| 4DB3A2200-TSK                          | 4DB3R20M0-TSK                      | 2661-27                     |                                | 0600-00                    |  | 1235-01                  | 0142-00                    |
| 4DB3A220E-FSD                          | 4DB3R20ME-FSD                      | 2661-27                     |                                | 0600-00                    |  | 1235-01                  | 0140-00                    |
| 4DB3A220E-TSE                          | 4DB3R20ME-TSE                      | 2661-27                     |                                | 0600-00                    |  | 1235-01                  | 0140-00                    |
| 4DB3A220E-TSK                          | 4DB3R20ME-TSK                      | 2661-27                     |                                | 0600-00                    |  | 1235-01                  | 0142-00                    |
| 4DC3A2200-FSD                          | 4DC3R20M0-FSD                      | 2661-27                     | 2661-28                        | 0600-00                    | 0616-00                                | 1235-01                  | 0140-00                    |
| • 4DC3A2200-TSE                        | 4DC3R20M0-TSE                      | 2661-27                     | 2661-28                        | 0600-00                    | 0616-00                                | 1235-01                  | 0140-00                    |
| • 4DC3A2200-TSK                        | 4DC3R20M0-TSK                      | 2661-27                     | 2661-28                        | 0600-00                    | 0616-00                                | 1235-01                  | 0142-00                    |
| • 4DC3A220E-FSD                        | 4DC3R20ME-FSD                      | 2661-27                     | 2661-28                        | 0600-00                    | 0616-00                                | 1235-01                  | 0140-00                    |

• = 1 Bank Unloading

# Semi-Hermetic Compressors – 4D and 4R

## 4D Delta Reed Models - Compressor Parts

| Model<br>(Horse Power<br>Nomenclature) | New Model<br>(BTU<br>Nomenclature) | Delta<br>Valve<br>Plate Kit | Unloader<br>Valve<br>Plate Kit | Cylinder<br>Head<br>Gasket | Unloader<br>Cylinder<br>Head<br>Gasket | Valve<br>Plate<br>Gasket | Terminal<br>Plate<br>Group |
|--|------------------------------------|-----------------------------|--------------------------------|----------------------------|--|--------------------------|----------------------------|
|  |                                    | (998-)                      | (998-)                         | (020-)                     | (020-)                                 | (020-)                   | (521-)                     |
| • 4DC3A220E-TSE                        | 4DC3R20ME-TSE                      | 2661-27                     | 2661-28                        | 0600-00                    | 0616-00                                | 1235-01                  | 0140-00                    |
| • 4DC3A220E-TSK                        | 4DC3R20ME-TSK                      | 2661-27                     | 2661-28                        | 0600-00                    | 0616-00                                | 1235-01                  | 0142-00                    |
| • 4DE1A1000-TSE                        | 4DE1R12M0-TSE                      | 2661-26                     | 2661-25                        | 0600-00                    | 0616-00                                | 1235-05                  | 0143-00                    |
| • 4DE1A1000-TSK                        | 4DE1R12M0-TSK                      | 2661-26                     | 2661-25                        | 0600-00                    | 0616-00                                | 1235-05                  | 0142-00                    |
| • 4DE1A2000-FSD                        | 4DE1R18M0-FSD                      | 2661-27                     | 2661-28                        | 0600-00                    | 0616-00                                | 1235-05                  | 0140-00                    |
| • 4DE1A2000-TSE                        | 4DE1R18M0-TSE                      | 2661-27                     | 2661-28                        | 0600-00                    | 0616-00                                | 1235-05                  | 0140-00                    |
| • 4DE1A2000-TSK                        | 4DE1R18M0-TSK                      | 2661-27                     | 2661-28                        | 0600-00                    | 0616-00                                | 1235-05                  | 0142-00                    |
| • 4DE2A2000-TSK                        | 4DE2R18M0-TSK                      | 2661-27                     | 2661-28                        | 0600-00                    | 0616-00                                | 1235-05                  | 0142-00                    |
| • 4DE3A100E-TSK                        | 4DE3R12ME-TSK                      | 2661-26                     | 2661-25                        | 0600-00                    | 0616-00                                | 1235-05                  | 0142-00                    |
| • 4DE3A2000-FSD                        | 4DE3R18M0-FSD                      | 2661-27                     | 2661-28                        | 0600-00                    | 0616-00                                | 1235-05                  | 0140-00                    |
| • 4DE3A2000-TSE                        | 4DE3R18M0-TSE                      | 2661-27                     | 2661-28                        | 0600-00                    | 0616-00                                | 1235-05                  | 0140-00                    |
| • 4DE3A2000-TSK                        | 4DE3R18M0-TSK                      | 2661-27                     | 2661-28                        | 0600-00                    | 0616-00                                | 1235-05                  | 0142-00                    |
| • 4DE3A200E-FSD                        | 4DE3R18ME-FSD                      | 2661-27                     | 2661-28                        | 0600-00                    | 0616-00                                | 1235-05                  | 0140-00                    |
| • 4DE3A200E-TSE                        | 4DE3R18ME-TSE                      | 2661-27                     | 2661-28                        | 0600-00                    | 0616-00                                | 1235-05                  | 0140-00                    |
| • 4DE3A200E-TSK                        | 4DE3R18ME-TSK                      | 2661-27                     | 2661-28                        | 0600-00                    | 0616-00                                | 1235-05                  | 0142-00                    |
| • 4DE4A2000-TSK                        | 4DE4R18M0-TSK                      | 2661-27                     | 2661-28                        | 0600-00                    | 0616-00                                | 1235-05                  | 0142-00                    |
| • 4DE8A2000-FSD                        | 4DE8R18M0-FSD                      | 2661-27                     | 2661-28                        | 0600-00                    | 0616-00                                | 1235-05                  | 0140-00                    |
| • 4DE8A200E-TSK                        | 4DE8R18ME-TSK                      | 2661-27                     | 2661-28                        | 0600-00                    | 0616-00                                | 1235-05                  | 0142-00                    |
| 4DH1A1500-FSD                          | 4DH1R16M0-FSD                      | 2661-26                     |                                | 0600-00                    |  | 1235-01                  | 0140-00                    |
| 4DH1A1500-TSE                          | 4DH1R16M0-TSE                      | 2661-26                     |                                | 0600-00                    |  | 1235-01                  | 0143-00                    |
| 4DH1A1500-TSK                          | 4DH1R16M0-TSK                      | 2661-26                     |                                | 0600-00                    |  | 1235-01                  | 0142-00                    |
| 4DH1A2500-FSD                          | 4DH1R22M0-FSD                      | 2661-27                     |                                | 0600-00                    |  | 1235-01                  | 0140-00                    |
| 4DH1A2500-TSE                          | 4DH1R22M0-TSE                      | 2661-27                     |                                | 0600-00                    |  | 1235-01                  | 0140-00                    |
| 4DH1A2500-TSK                          | 4DH1R22M0-TSK                      | 2661-27                     |                                | 0600-00                    |  | 1235-01                  | 0142-00                    |
| 4DH3A150E-TSE                          | 4DH3R16ME-TSE                      | 2661-26                     |                                | 0600-00                    |  | 1235-01                  | 0143-00                    |
| 4DH3A150E-TSK                          | 4DH3R16ME-TSK                      | 2661-26                     |                                | 0600-00                    |  | 1235-01                  | 0142-00                    |
| 4DH3A2500-FSD                          | 4DH3R22M0-FSD                      | 2661-27                     |                                | 0600-00                    |  | 1235-01                  | 0140-00                    |
| 4DH3A2500-TSE                          | 4DH3R22M0-TSE                      | 2661-27                     |                                | 0600-00                    |  | 1235-01                  | 0140-00                    |
| 4DH3A2500-TSK                          | 4DH3R22M0-TSK                      | 2661-27                     |                                | 0600-00                    |  | 1235-01                  | 0142-00                    |
| 4DH3A250E-FSD                          | 4DH3R22ME-FSD                      | 2661-27                     |                                | 0600-00                    |  | 1235-01                  | 0140-00                    |
| 4DH3A250E-TSE                          | 4DH3R22ME-TSE                      | 2661-27                     |                                | 0600-00                    |  | 1235-01                  | 0140-00                    |
| 4DH3A250E-TSK                          | 4DH3R22ME-TSK                      | 2661-27                     |                                | 0600-00                    |  | 1235-01                  | 0142-00                    |
| 4DJ1A2000-FSD                          | 4DJ1R19M0-FSD                      | 2661-26                     |                                | 0600-00                    |  | 1235-03                  | 0140-00                    |
| 4DJ1A2000-TSE                          | 4DJ1R19M0-TSE                      | 2661-26                     |                                | 0600-00                    |  | 1235-03                  | 0140-00                    |
| 4DJ1A2000-TSK                          | 4DJ1R19M0-TSK                      | 2661-26                     |                                | 0600-00                    |  | 1235-03                  | 0142-00                    |
| 4DJ1A3000-FSD                          | 4DJ1R28M0-FSD                      | 2661-27                     |                                | 0600-00                    |  | 1235-03                  | 0140-00                    |

• = 1 Bank Unloading



# 4D and 4R – Semi-Hermetic Compressors

## 4D Delta Reed Models - Compressor Parts

| Model<br>(Horse Power<br>Nomenclature) | New Model<br>(BTU<br>Nomenclature) | Delta<br>Valve<br>Plate Kit | Unloader<br>Valve<br>Plate Kit | Cylinder<br>Head<br>Gasket | Unloader<br>Cylinder<br>Head<br>Gasket | Valve<br>Plate<br>Gasket | Terminal<br>Plate<br>Group |
|--|------------------------------------|-----------------------------|--------------------------------|----------------------------|--|--------------------------|----------------------------|
|  |                                    | (998-)                      | (998-)                         | (020-)                     | (020-)                                 | (020-)                   | (521-)                     |
| 4DJ1A3000-TSE                          | 4DJ1R28M0-TSE                      | 2661-27                     |                                | 0600-00                    |  | 1235-03                  | 0140-00                    |
| 4DJ1A3000-TSK                          | 4DJ1R28M0-TSK                      | 2661-27                     |                                | 0600-00                    |  | 1235-03                  | 0142-00                    |
| 4DJ2A2000-TSK                          | 4DJ2R19M0-TSK                      | 2661-26                     |                                | 0600-00                    |  | 1235-03                  | 0142-00                    |
| 4DJ2A3000-TSK                          | 4DJ2R28M0-TSK                      | 2661-27                     |                                | 0600-00                    |  | 1235-03                  | 0142-00                    |
| 4DJ3A200E-TSE                          | 4DJ3R19ME-TSE                      | 2661-26                     |                                | 0600-00                    |  | 1235-03                  | 0140-00                    |
| 4DJ3A200E-TSK                          | 4DJ3R19ME-TSK                      | 2661-26                     |                                | 0600-00                    |  | 1235-03                  | 0142-00                    |
| 4DJ3A3000-FSD                          | 4DJ3R28M0-FSD                      | 2661-27                     |                                | 0600-00                    |  | 1235-03                  | 0140-00                    |
| 4DJ3A3000-TSE                          | 4DJ3R28M0-TSE                      | 2661-27                     |                                | 0600-00                    |  | 1235-03                  | 0140-00                    |
| 4DJ3A3000-TSK                          | 4DJ3R28M0-TSK                      | 2661-27                     |                                | 0600-00                    |  | 1235-03                  | 0142-00                    |
| 4DJ3A300E-FSD                          | 4DJ3R28ME-FSD                      | 2661-27                     |                                | 0600-00                    |  | 1235-03                  | 0140-00                    |
| 4DJ3A300E-TSE                          | 4DJ3R28ME-TSE                      | 2661-27                     |                                | 0600-00                    |  | 1235-03                  | 0140-00                    |
| 4DJ3A300E-TSK                          | 4DJ3R28ME-TSK                      | 2661-27                     |                                | 0600-00                    |  | 1235-03                  | 0142-00                    |
| 4DJ8A200E-TSK                          | 4DJ8R19ME-TSK                      | 2661-26                     |                                | 0600-00                    |  | 1235-03                  | 0142-00                    |
| 4DJ8A3000-TSK                          | 4DJ8R28M0-TSK                      | 2661-26                     |                                | 0600-00                    |  | 1235-03                  | 0142-00                    |
| • 4DK1A1500-TSK                        | 4DK1R16M0-TSK                      | 2661-26                     | 2661-25                        | 0600-00                    | 0616-00                                | 1235-01                  | 0142-00                    |
| • 4DK1A2500-FSD                        | 4DK1R22M0-FSD                      | 2661-27                     | 2661-28                        | 0600-00                    | 0616-00                                | 1235-01                  | 0140-00                    |
| • 4DK1A2500-TSE                        | 4DK1R22M0-TSE                      | 2661-27                     | 2661-28                        | 0600-00                    | 0616-00                                | 1235-01                  | 0140-00                    |
| • 4DK1A2500-TSK                        | 4DK1R16M0-TSK                      | 2661-27                     | 2661-28                        | 0600-00                    | 0616-00                                | 1235-01                  | 0142-00                    |
| • 4DK3A150E-FSM                        | 4DK3R16ME-FSM                      | 2661-26                     | 2661-25                        | 0600-00                    | 0616-00                                | 1235-01                  | 0140-00                    |
| • 4DK3A150E-TSE                        | 4DK3R16ME-TSE                      | 2661-26                     | 2661-25                        | 0600-00                    | 0616-00                                | 1235-01                  | 0143-00                    |
| • 4DK3A150E-TSK                        | 4DK3R16ME-TSK                      | 2661-26                     | 2661-25                        | 0600-00                    | 0616-00                                | 1235-01                  | 0142-00                    |
| • 4DK3A2500-FSD                        | 4DK3R22M0-FSD                      | 2661-27                     | 2661-28                        | 0600-00                    | 0616-00                                | 1235-01                  | 0140-00                    |
| • 4DK3A2500-TSE                        | 4DK3R22M0-TSE                      | 2661-27                     | 2661-28                        | 0600-00                    | 0616-00                                | 1235-01                  | 0140-00                    |
| • 4DK3A2500-TSK                        | 4DK3R22M0-TSK                      | 2661-27                     | 2661-28                        | 0600-00                    | 0616-00                                | 1235-01                  | 0142-00                    |
| • 4DK3A250E-FSD                        | 4DK3R22ME-FSD                      | 2661-27                     | 2661-28                        | 0600-00                    | 0616-00                                | 1235-01                  | 0140-00                    |
| • 4DK3A250E-TSE                        | 4DK3R22ME-TSE                      | 2661-27                     | 2661-28                        | 0600-00                    | 0616-00                                | 1235-01                  | 0140-00                    |
| • 4DK3A250E-TSK                        | 4DK3R22ME-TSK                      | 2661-27                     | 2661-28                        | 0600-00                    | 0616-00                                | 1235-01                  | 0142-00                    |
| 4DL1A1500-FSD                          | 4DL1F63K0-FSD                      | 2661-26                     | 2661-25                        | 0600-00                    |  | 1235-01                  | 0140-00                    |
| 4DL1A1500-TSE                          | 4DL1F63K0-TSE                      | 2661-26                     | 2661-25                        | 0600-00                    |  | 1235-01                  | 0143-00                    |
| 4DL1A1500-TSK                          | 4DL1F63K0-TSK                      | 2661-26                     | 2661-25                        | 0600-00                    |  | 1235-01                  | 0142-00                    |
| 4DL3A1500-FSD                          | 4DL3F63K0-FSD                      | 2661-26                     | 2661-25                        | 0600-00                    |  | 1235-01                  | 0140-00                    |
| 4DL3A1500-TSE                          | 4DL3F63K0-TSE                      | 2661-26                     | 2661-25                        | 0600-00                    |  | 1235-01                  | 0143-00                    |
| 4DL3A1500-TSK                          | 4DL3F63K0-TSK                      | 2661-26                     | 2661-25                        | 0600-00                    |  | 1235-01                  | 0142-00                    |
| 4DL3A150E-FSD                          | 4DL3F63KE-FSD                      | 2661-26                     | 2661-25                        | 0600-00                    |  | 1235-01                  | 0140-00                    |
| 4DL3A150E-TSE                          | 4DL3F63KE-TSE                      | 2661-26                     | 2661-25                        | 0600-00                    |  | 1235-01                  | 0143-00                    |
| 4DL3A150E-TSK                          | 4DL3F63KE-TSK                      | 2661-26                     | 2661-25                        | 0600-00                    |  | 1235-01                  | 0142-00                    |

• = 1 Bank Unloading

# Semi-Hermetic Compressors – 4D and 4R

## 4D Delta Reed Models - Compressor Parts

| Model<br>(Horse Power<br>Nomenclature) | New Model<br>(BTU<br>Nomenclature) | Delta<br>Valve<br>Plate Kit | Unloader<br>Valve<br>Plate Kit | Cylinder<br>Head<br>Gasket | Unloader<br>Cylinder<br>Head<br>Gasket | Valve<br>Plate<br>Gasket | Terminal<br>Plate<br>Group |
|--|------------------------------------|-----------------------------|--------------------------------|----------------------------|--|--------------------------|----------------------------|
|  |                                    | (998-)                      | (998-)                         | (020-)                     | (020-)                                 | (020-)                   | (521-)                     |
| • 4DN1A1000-FSD                        | N/A                                | 2661-26                     | 2661-25                        | 0600-00                    | 0616-00                                | 1235-05                  | 0140-00                    |
| • 4DN1A1000-TSE                        | N/A                                | 2661-26                     | 2661-25                        | 0600-00                    | 0616-00                                | 1235-05                  | 0143-00                    |
| • 4DN1A1000-TSK                        | N/A                                | 2661-26                     | 2661-25                        | 0600-00                    | 0616-00                                | 1235-05                  | 0142-00                    |
| • 4DN3A1000-FSD                        | N/A                                | 2661-26                     | 2661-25                        | 0600-00                    | 0616-00                                | 1235-05                  | 0140-00                    |
| • 4DN3A1000-TSE                        | N/A                                | 2661-26                     | 2661-25                        | 0600-00                    | 0616-00                                | 1235-05                  | 0143-00                    |
| • 4DN3A1000-TSK                        | N/A                                | 2661-26                     | 2661-25                        | 0600-00                    | 0616-00                                | 1235-05                  | 0142-00                    |
| • 4DN3A100E-FSD                        | N/A                                | 2661-26                     | 2661-25                        | 0600-00                    | 0616-00                                | 1235-05                  | 0140-00                    |
| • 4DN3A100E-TSE                        | N/A                                | 2661-26                     | 2661-25                        | 0600-00                    | 0616-00                                | 1235-05                  | 0143-00                    |
| • 4DN3A1010-TSE                        | 4DN3F47K0-TSE                      | 2661-26                     | 2661-25                        | 0600-00                    | 0616-00                                | 1235-05                  | 0143-00                    |
| • 4DN3A1010-TSK                        | 4DN3F47K0-TSK                      | 2661-26                     | 2661-25                        | 0600-00                    | 0616-00                                | 1235-05                  | 0142-00                    |
| • 4DN3A101E-TSE                        | 4DN3F47KE-TSE                      | 2661-26                     | 2661-25                        | 0600-00                    | 0616-00                                | 1235-05                  | 0143-00                    |
| • 4DN3A101E-TSK                        | 4DN3F47KE-TSK                      | 2661-26                     | 2661-25                        | 0600-00                    | 0616-00                                | 1235-05                  | 0142-00                    |
| • 4DP1A1500-FSD                        | 4DP1F63K0-FSD                      | 2661-26                     | 2661-25                        | 0600-00                    | 0616-00                                | 1235-01                  | 0140-00                    |
| • 4DP1A1500-TSK                        | 4DP1F63K0-TSK                      | 2661-26                     | 2661-25                        | 0600-00                    | 0616-00                                | 1235-01                  | 0142-00                    |
| • 4DP3A1500-FSD                        | 4DP3F63K0-FSD                      | 2661-26                     | 2661-25                        | 0600-00                    | 0616-00                                | 1235-01                  | 0140-00                    |
| • 4DP3A1500-TSE                        | 4DP3F63K0-TSE                      | 2661-26                     | 2661-25                        | 0600-00                    | 0616-00                                | 1235-01                  | 0143-00                    |
| • 4DP3A1500-TSK                        | 4DP3F63K0-TSK                      | 2661-26                     | 2661-25                        | 0600-00                    | 0616-00                                | 1235-01                  | 0142-00                    |
| • 4DP3A150E-FSD                        | 4DP3F63KE-FSD                      | 2661-26                     | 2661-25                        | 0600-00                    | 0616-00                                | 1235-01                  | 0140-00                    |
| • 4DP3A150E-TSE                        | 4DP3F63KE-TSE                      | 2661-26                     | 2661-25                        | 0600-00                    | 0616-00                                | 1235-01                  | 0143-00                    |
| • 4DP3A150E-TSK                        | 4DP3F63KE-TSK                      | 2661-26                     | 2661-25                        | 0600-00                    | 0616-00                                | 1235-01                  | 0142-00                    |
| • 4DP8A1500-TSK                        | 4DP8F63K0-TSK                      | 2661-26                     | 2661-25                        | 0600-00                    | 0616-00                                | 1235-01                  | 0142-00                    |
| • 4DP8A150E-TSK                        | 4DP8F63KE-TSK                      | 2661-26                     | 2661-25                        | 0600-00                    | 0616-00                                | 1235-01                  | 0142-00                    |
| • 4DR1A2000-TSE                        | 4DR1R19M0-TSE                      | 2661-26                     | 2661-28                        | 0600-00                    | 0616-00                                | 1235-03                  | 0140-00                    |
| • 4DR1A2000-TSK                        | 4DR1R19M0-TSK                      | 2661-26                     | 2661-28                        | 0600-00                    | 0616-00                                | 1235-03                  | 0142-00                    |
| • 4DR1A3000-FSD                        | 4DR1R28M0-FSD                      | 2661-27                     | 2661-28                        | 0600-00                    | 0616-00                                | 1235-03                  | 0140-00                    |
| • 4DR1A3000-TSE                        | 4DR1R28M0-TSE                      | 2661-27                     | 2661-28                        | 0600-00                    | 0616-00                                | 1235-03                  | 0140-00                    |
| • 4DR1A3000-TSK                        | 4DR1R28M0-TSK                      | 2661-27                     | 2661-28                        | 0600-00                    | 0616-00                                | 1235-03                  | 0142-00                    |
| • 4DR3A200E-TSE                        | 4DR3R19ME-TSE                      | 2661-26                     | 2661-28                        | 0600-00                    | 0616-00                                | 1235-03                  | 0140-00                    |
| • 4DR3A200E-TSK                        | 4DR3R19ME-TSK                      | 2661-26                     | 2661-28                        | 0600-00                    | 0616-00                                | 1235-03                  | 0142-00                    |
| • 4DR3A3000-FSD                        | 4DR3R28M0-FSD                      | 2661-27                     | 2661-28                        | 0600-00                    | 0616-00                                | 1235-03                  | 0140-00                    |
| • 4DR3A3000-TSE                        | 4DR3R28M0-TSE                      | 2661-27                     | 2661-28                        | 0600-00                    | 0616-00                                | 1235-03                  | 0140-00                    |
| • 4DR3A3000-TSK                        | 4DR3R28M0-TSK                      | 2661-27                     | 2661-28                        | 0600-00                    | 0616-00                                | 1235-03                  | 0142-00                    |
| • 4DR3A300E-FSD                        | 4DR3R28ME-FSD                      | 2661-27                     | 2661-28                        | 0600-00                    | 0616-00                                | 1235-03                  | 0140-00                    |
| • 4DR3A300E-TSE                        | 4DR3R28ME-TSE                      | 2661-27                     | 2661-28                        | 0600-00                    | 0616-00                                | 1235-03                  | 0140-00                    |
| • 4DR3A300E-TSK                        | 4DR3R28ME-TSK                      | 2661-27                     | 2661-28                        | 0600-00                    | 0616-00                                | 1235-03                  | 0142-00                    |
| • 4DR8A200E-TSK                        | 4DR8R19ME-TSK                      | 2661-27                     | 2661-28                        | 0600-00                    | 0616-00                                | 1235-03                  | 0142-00                    |

• = 1 Bank Unloading

# 4D and 4R – Semi-Hermetic Compressors

## 4D Delta Reed Models - Compressor Parts

| Model<br>(Horse Power<br>Nomenclature) | New Model<br>(BTU<br>Nomenclature) | Delta<br>Valve<br>Plate Kit | Unloader<br>Valve<br>Plate Kit | Cylinder<br>Head<br>Gasket | Unloader<br>Cylinder<br>Head<br>Gasket | Valve<br>Plate<br>Gasket | Terminal<br>Plate<br>Group |
|--|------------------------------------|-----------------------------|--------------------------------|----------------------------|--|--------------------------|----------------------------|
|  |                                    | (998-)                      | (998-)                         | (020-)                     | (020-)                                 | (020-)                   | (521-)                     |
| • 4DS1A2200-FSD                        | 4DS1F76K0-FSD                      | 2661-26                     | 2661-25                        | 0600-00                    | 0616-00                                | 1235-03                  | 0140-00                    |
| • 4DS1A2200-TSE                        | 4DS1F76K0-TSE                      | 2661-26                     | 2661-25                        | 0600-00                    | 0616-00                                | 1235-03                  | 0140-00                    |
| • 4DS1A2200-TSK                        | 4DS1F76K0-TSK                      | 2661-26                     | 2661-25                        | 0600-00                    | 0616-00                                | 1235-03                  | 0142-00                    |
| • 4DS3A2200-FSD                        | 4DS3F76K0-FSD                      | 2661-26                     | 2661-25                        | 0600-00                    | 0616-00                                | 1235-03                  | 0140-00                    |
| • 4DS3A2200-TSE                        | 4DS3F76K0-TSE                      | 2661-26                     | 2661-25                        | 0600-00                    | 0616-00                                | 1235-03                  | 0140-00                    |
| • 4DS3A2200-TSK                        | 4DS3F76K0-TSK                      | 2661-26                     | 2661-25                        | 0600-00                    | 0616-00                                | 1235-03                  | 0142-00                    |
| • 4DS3A220E-FSD                        | 4DS3F76KE-FSD                      | 2661-26                     | 2661-25                        | 0600-00                    | 0616-00                                | 1235-03                  | 0140-00                    |
| • 4DS3A220E-TSE                        | 4DS3F76KE-TSE                      | 2661-26                     | 2661-25                        | 0600-00                    | 0616-00                                | 1235-03                  | 0140-00                    |
| • 4DS3A220E-TSK                        | 4DS3F76KE-TSK                      | 2661-26                     | 2661-25                        | 0600-00                    | 0616-00                                | 1235-03                  | 0142-00                    |
| 4DT1A2200-FSD                          | 4DT1F76K0-FSD                      | 2661-26                     |                                | 0600-00                    |  | 1235-03                  | 0140-00                    |
| 4DT1A2200-TSE                          | 4DT1F76K0-TSE                      | 2661-26                     |                                | 0600-00                    |  | 1235-03                  | 0140-00                    |
| 4DT1A2200-TSK                          | 4DT1F76K0-TSK                      | 2661-26                     |                                | 0600-00                    |  | 1235-03                  | 0142-00                    |
| 4DT3A2200-FSD                          | 4DT3F76K0-FSD                      | 2661-26                     |                                | 0600-00                    |  | 1235-03                  | 0140-00                    |
| 4DT3A2200-TSE                          | 4DT3F76K0-TSE                      | 2661-26                     |                                | 0600-00                    |  | 1235-03                  | 0140-00                    |
| 4DT3A2200-TSK                          | 4DT3F76K0-TSK                      | 2661-26                     |                                | 0600-00                    |  | 1235-03                  | 0142-00                    |
| 4DT3A220E-FSD                          | 4DT3F76KE-FSD                      | 2661-26                     |                                | 0600-00                    |  | 1235-03                  | 0140-00                    |
| 4DT3A220E-TSE                          | 4DT3F76KE-TSE                      | 2661-26                     |                                | 0600-00                    |  | 1235-03                  | 0140-00                    |
| 4DT3A220E-TSK                          | 4DT3F76KE-TSK                      | 2661-26                     |                                | 0600-00                    |  | 1235-03                  | 0142-00                    |

• = 1 Bank Unloading

## 4D Compressor Capacity Control Kits

| Standard Model | Blocked Suction Capacity Control Model | Digital Capacity Control Model | Capacity Control Conversion Kit with 24V Unloader | Capacity Control Conversion Kit with 120V Unloader | Capacity Control Conversion Kit with 240V Unloader |
|----------------|--|--------------------------------|---|--|--|
| 4DA3A101*      | 4DE3A101*                              |                                | 998-2119-35                                       | 998-2119-36  | 998-2119-37  |
| 4DA3A200*      | 4DE3R18M*                              |                                | 998-2119-31                                       | 998-2119-32  | 998-2119-33  |
| 4DB3A220*      | 4DC3R20M*                              |                                | 998-2119-31                                       | 998-2119-32  | 998-2119-33  |
| 4DL3A150*      | 4DL3F63K*                              |                                | 998-2119-35                                       | 998-2119-36  | 998-2119-37  |
| 4DH3A150*      | 4DK3R16M*                              |                                | 998-2119-31                                       | 998-2119-32  | 998-2119-33  |
| 4DH3A250*      | 4DK3R22M*                              |                                | 998-2119-31                                       | 998-2119-32  | 998-2119-33  |
| 4DT3A220*      | 4DS3F76M*                              |                                | 998-2119-35                                       | 998-2119-36  | 998-2119-37  |
| 4DJ3A200*      | 4DR3R19M*                              |                                | 998-2119-31                                       | 998-2119-32  | 998-2119-33  |
| 4DJ3R28M*      | 4DR3R28M*                              |                                | 998-2119-31                                       | 998-2119-32  | 998-2119-33  |
| 4DA3F47K*      | 4DE3F47K*                              |                                | 998-2119-35                                       | 998-2119-36  | 998-2119-37  |
| 4DA3F47K*      |  | 4DADF47KE                      | 980-6000-01                                       | 980-6000-01  | 980-6000-01  |
| 4DA3R18M*      | 4DE3R18M*                              |                                | 998-2119-31                                       | 998-2119-32  | 998-2119-33  |
| 4DA3R18M*      |  | 4DADR18ME                      | 980-6000-00                                       | 980-6000-00  | 980-6000-00  |
| 4DB3R20M*      | 4DC3R20M*                              |                                | 998-2119-31                                       | 998-2119-32  | 998-2119-33  |
| 4DB3R20M*      |  | 4DBDR20ME                      | 980-6000-00                                       | 980-6000-00  | 980-6000-00  |
| 4DL3F63K*      | 4DL3F63K*                              |                                | 998-2119-35                                       | 998-2119-36  | 998-2119-37  |
| 4DL3F63K*      |  | 4DLDF63KE                      | 980-6000-01                                       | 980-6000-01  | 980-6000-01  |
| 4DH3R16M*      | 4DK3R16M*                              |                                | 998-2119-31                                       | 998-2119-32  | 998-2119-33  |
| 4DH3R22M*      | 4DK3R22M*                              |                                | 998-2119-31                                       | 998-2119-32  | 998-2119-33  |
| 4DH3R22M*      |  | 4DHDR22ME                      | 980-6000-00                                       | 980-6000-00  | 980-6000-00  |
| 4DT3F76M*      | 4DS3F76M*                              |                                | 998-2119-35                                       | 998-2119-36  | 998-2119-37  |
| 4DT3F76M*      |  | 4DTDF76ME                      | 980-6000-01                                       | 980-6000-01  | 980-6000-01  |
| 4DJ3R19M*      | 4DR3R19M*                              |                                | 998-2119-31                                       | 998-2119-32  | 998-2119-33  |
| 4DJ3R28M*      | 4DR3R28M*                              |                                | 998-2119-31                                       | 998-2119-32  | 998-2119-33  |
| 4DJ3R28M*      |  | 4DJDR28ME                      | 980-6000-00                                       | 980-6000-00  | 980-6000-00  |

**Note:** Digital conversion kits include 24V, 120V, 240V unloader solenoids and IDCM module.

Digital conversion kits shown are for standard Copeland Discus compressors.

Contact Emerson's Technical Department to obtain kit numbers for Copeland Discus compressors with CoreSense Diagnostics.

\* = E (for POE oil models), 0 (for mineral oil models) or L (for less oil models)

# 4D and 4R – Semi-Hermetic Compressors

## 4R - Compressor Parts

| Model           | Valve Plate Kit | Complete Gasket Set | Cylinder Head Gasket | Valve Plate Gasket | Terminal Plate Group |
|-----------------|-----------------|---------------------|----------------------|--------------------|----------------------|
|                 | (998-)          | (998-)              | (020-)               | (020-)             | (521-)               |
| 4RA3-1000-FSM   | 0661-00         | 0669-00             | 0629-00              | 0626-00            | 0140-00              |
| 4RA3-1000-TSE   | 0661-00         | 0669-00             | 0629-00              | 0626-00            | 0143-00              |
| 4RA3-1000-TSK   | 0661-00         | 0669-00             | 0629-00              | 0626-00            | 0142-00              |
| 4RA3-2000-FSD   | 0661-52         | 0669-00             | 0629-00              | 0626-00            | 0140-00              |
| 4RA3-2000-TSE   | 0661-52         | 0669-00             | 0629-00              | 0626-00            | 0140-00              |
| 4RA3-2000-TSK   | 0661-52         | 0669-00             | 0629-00              | 0626-00            | 0142-00              |
| 4RA4-1000-TSE   | 0661-00         | 0669-00             | 0629-00              | 0626-00            | 0143-00              |
| 4RA4-1000-TSK   | 0661-00         | 0669-00             | 0629-00              | 0626-00            | 0142-00              |
| 4RA4-2000-FSD   | 0661-52         | 0669-00             | 0629-00              | 0626-00            | 0140-00              |
| 4RA4-2000-TSE   | 0661-52         | 0669-00             | 0629-00              | 0626-00            | 0140-00              |
| 4RA4-2000-TSK   | 0661-52         | 0669-00             | 0629-00              | 0626-00            | 0142-00              |
| • 4RE2-1000-FSM | 0661-66         | 0669-00             | 0629-00              | 0626-00            | 0140-00              |
| • 4RE2-1000-TSE | 0661-66         | 0669-00             | 0629-00              | 0626-00            | 0143-00              |
| • 4RE2-1000-TSK | 0661-66         | 0669-00             | 0629-00              | 0626-00            | 0142-00              |
| • 4RE2-2000-FSD | 0661-52         | 0669-00             | 0629-00              | 0626-00            | 0140-00              |
| • 4RE2-2000-TSE | 0661-52         | 0669-00             | 0629-00              | 0626-00            | 0140-00              |
| • 4RE2-2000-TSK | 0661-52         | 0669-00             | 0629-00              | 0626-00            | 0142-00              |
| 4RH1-1500-FSM   | 0661-51         | 0669-54             | 0629-00              | 0627-00            | 0140-00              |
| 4RH1-1500-TSE   | 0661-51         | 0669-54             | 0629-00              | 0627-00            | 0143-00              |
| 4RH1-1500-TSK   | 0661-51         | 0669-54             | 0629-00              | 0627-00            | 0142-00              |
| 4RH1-2500-FSD   | 0661-51         | 0669-54             | 0629-00              | 0627-00            | 0140-00              |
| 4RH1-2500-TSE   | 0661-51         | 0669-54             | 0629-00              | 0627-00            | 0140-00              |
| 4RH1-2500-TSK   | 0661-51         | 0669-54             | 0629-00              | 0627-00            | 0142-00              |
| 4RJ1-2000-FSM   | 0661-60         | 0669-55             | 0629-00              | 0628-01            | 0140-00              |
| 4RJ1-3000-FSD   | 0661-60         | 0669-55             | 0629-00              | 0628-01            | 0140-00              |
| 4RJ1-3000-TSE   | 0661-60         | 0669-55             | 0629-00              | 0628-01            | 0140-00              |
| 4RJ1-3000-TSK   | 0661-60         | 0669-55             | 0629-00              | 0628-01            | 0142-00              |
| 4RJ2-2000-FSM   | 0661-60         | 0669-55             | 0629-00              | 0628-01            | 0140-00              |
| 4RJ2-3000-FSD   | 0661-60         | 0669-55             | 0629-00              | 0628-01            | 0140-00              |
| 4RJ2-3000-TSE   | 0661-60         | 0669-55             | 0629-00              | 0628-01            | 0140-00              |
| 4RJ2-3000-TSK   | 0661-60         | 0669-55             | 0629-00              | 0628-01            | 0142-00              |
| • 4RK2-1500-FSM | 0661-51         | 0669-54             | 0629-00              | 0627-00            | 0140-00              |
| • 4RK2-1500-TSE | 0661-51         | 0669-54             | 0629-00              | 0627-00            | 0143-00              |
| • 4RK2-1500-TSK | 0661-51         | 0669-54             | 0629-00              | 0627-00            | 0142-00              |
| • 4RK2-2500-FSD | 0661-51         | 0669-54             | 0629-00              | 0627-00            | 0140-00              |
| • 4RK2-2500-TSE | 0661-51         | 0669-54             | 0629-00              | 0627-00            | 0140-00              |
| • 4RK2-2500-TSK | 0661-51         | 0669-54             | 0629-00              | 0627-00            | 0142-00              |
| 4RL1-1500-FSM   | 0661-49         | 0669-54             | 0629-00              | 0627-00            | 0140-00              |
| 4RL1-1500-TSE   | 0661-49         | 0669-54             | 0629-00              | 0627-00            | 0141-00              |
| 4RL1-1500-TSK   | 0661-49         | 0669-54             | 0629-00              | 0627-00            | 0142-00              |

• = 1 Bank Unloading

## 4R - Compressor Parts

| Model           | Valve Plate Kit | Complete Gasket Set | Cylinder Head Gasket | Valve Plate Gasket | Terminal Plate Group |
|-----------------|-----------------|---------------------|----------------------|--------------------|----------------------|
|                 | (998-)          | (998-)              | (020-)               | (020-)             | (521-)               |
| • 4RR1-3000-FSD | 0661-60         | 0669-55             | 0629-00              | 0628-01            | 0140-00              |
| • 4RR1-3000-TSE | 0661-60         | 0669-55             | 0629-00              | 0628-01            | 0140-00              |
| • 4RR1-3000-TSK | 0661-60         | 0669-55             | 0629-00              | 0628-01            | 0142-00              |
| • 4RR2-3000-FSD | 0661-60         | 0669-55             | 0629-00              | 0628-01            | 0140-00              |
| • 4RR2-3000-TSE | 0661-60         | 0669-55             | 0629-00              | 0628-01            | 0140-00              |
| • 4RR2-3000-TSK | 0661-60         | 0669-55             | 0629-00              | 0628-01            | 0142-00              |

• = 1 Bank Unloading

## 4R Compressor Capacity Control Kits

| Standard Model | Capacity Control Model | Capacity Control Conversion Kit with 24V Unloader | Capacity Control Conversion Kit with 120V Unloader | Capacity Control Conversion Kit with 240V Unloader |
|----------------|------------------------|---|--|--|
| 4RA*-1000      | 4RE*-1000              | 998-0119-08                                       | 998-0119-09  | 998-0119-10  |
| 4RA*-2000      | 4RE*-2000              | 998-0119-08                                       | 998-0119-09  | 998-0119-10  |
| 4RH*-1500      | 4RK*-1500              | 998-0119-08                                       | 998-0119-09  | 998-0119-10  |
| 4RH*-2500      | 4RK*-2500              | 998-0119-08                                       | 998-0119-09  | 998-0119-10  |
| 4RJ*-2000      | 4RR*-2000              | 998-0119-16                                       | 998-0119-17  | 998-0119-18  |
| 4RJ*-3000      | 4RR*-3000              | 998-0119-16                                       | 998-0119-17  | 998-0119-18  |

**Note:** The position occupied by \* can be the number 1, 2, 3, 4, or 8

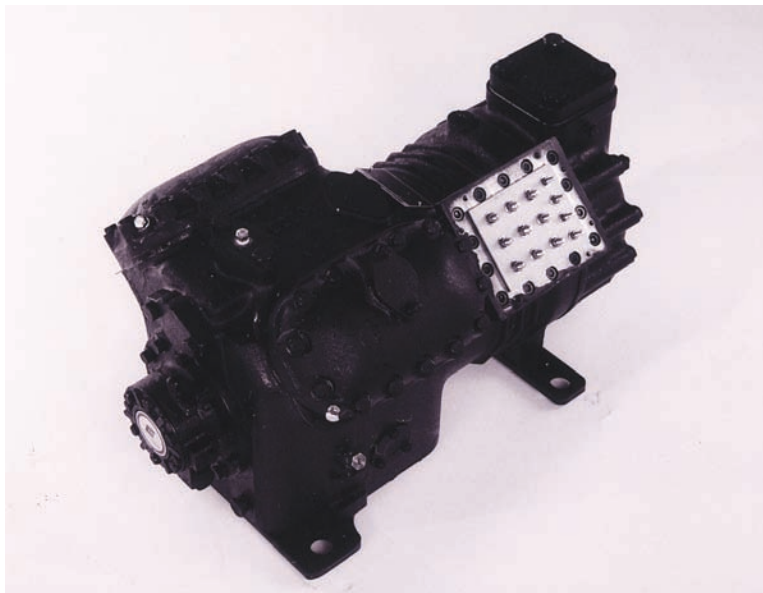



# 4D Copeland Discus™ III – Semi-Hermetic Compressors

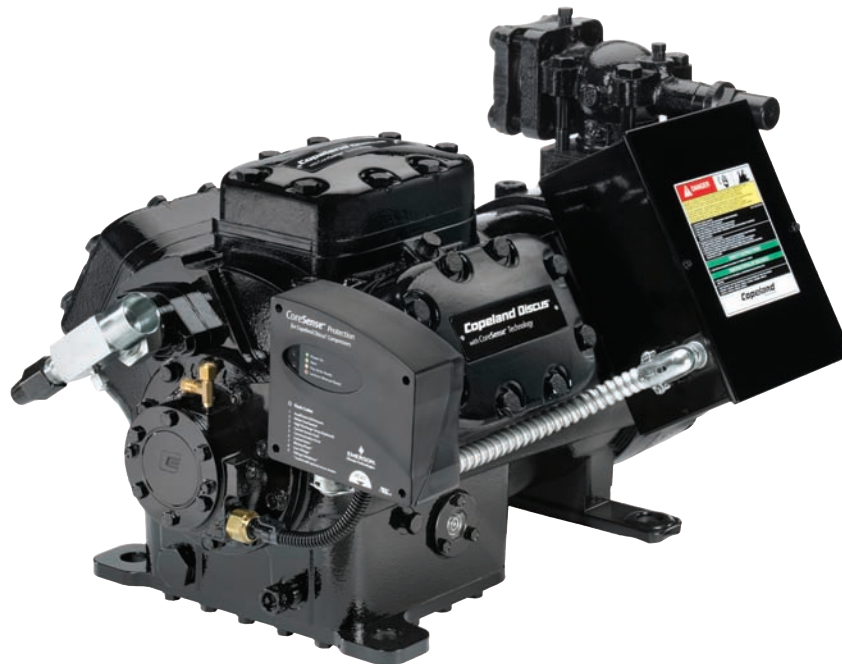
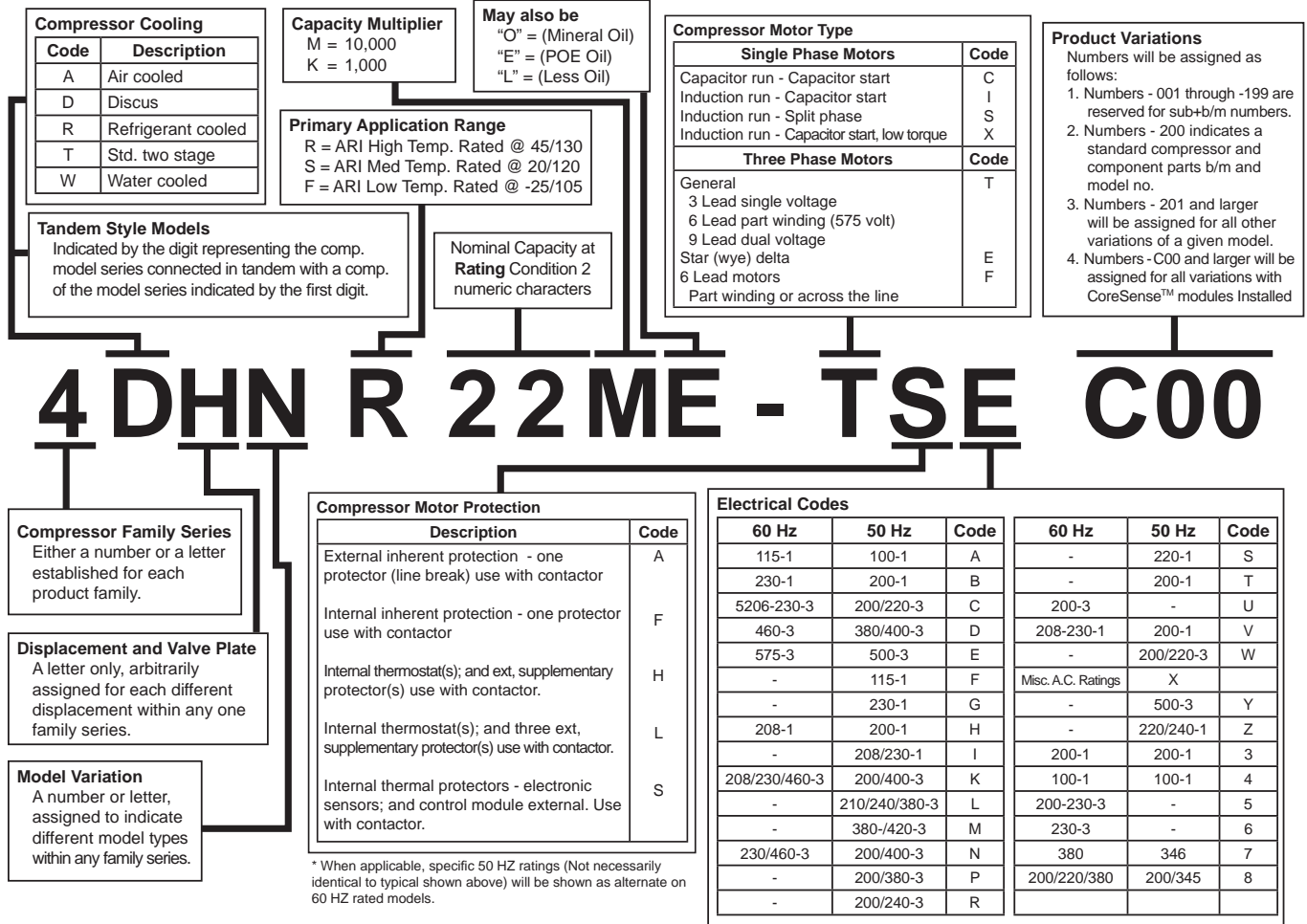

# Semi-Hermetic Compressors – 4D Copeland Discus™ III

## Copeland Discus™ III to Copeland Discus™ II cross reference matrix

Use this matrix to determine required accessory kits if you are replacing a field-failed Copeland Discus™ III compressor with a Copeland Discus™ II service model.

| 4D                     | Kit Number  |  | Do I need this Kit?<br>Check the Discus™ III nomenclature                           | Kit includes:   | Special notes  |
|------------------------|---|--|---|---|--|
|                        | CoreSense™ Protection   | CoreSense™ Diagnostics (ISD)                 |   |   |  |
| <b>Electronics Kit</b> | 974-1315-00   | 998-3000-04                                  | 4DKNF63KE-TSE-C00<br>C = Protection kit<br>4DKNF63KE-TSE-A00<br>A = Diagnostics kit | Mounting parts (studs and nuts) necessary to reinstall CoreSense™ Protection or Diagnostics on Discus™ II service models. | You will never need both of these kits, but you will always need one. (The exception is the -441 BOM. In this case, neither kit is required.)  |
| <b>Low Temp Kit</b>    | 998-3000-14 (Demand Cooling™)<br>998-0574-12 (head fan)<br>998-0574-20 (digital head fan) |  | 4DKNF63KE-TSE-A00<br>You need it if this digit is F**                               | Head fan and Demand Cooling™ mounting kits (including studs and nuts)   | Depending on the refrigerant in the system, you may not need to use the demand cooling mounting parts.   |
| <b>Unloading Kit</b>   | 998-0212-00 (less coil)<br>998-0212-02 (115V coil)<br>998-0212-03 (208/220V coil)         | 998-0212-00 (less coil)<br>998-0212-01 (24V) | 4DKNF63KE-TSE-A00<br>You need it if this digit is anything except H, J, B or G      | Gasket and solenoid valve assembly  | 4D models receive one unloading kit. NOTE: It is possible unloading has been added to the compressor at the time of install. If this is the case, an unloading kit will be required. |

\*\* Refer to OEM equipment guidelines. Demand Cooling is only used in R-22, R-407A, R-407C and R-407F applications.

Due to the lack of an installed base for remanufacturing, Emerson Climate Technologies, Inc. have decided at this time to replace Discus III compressors that fail in the field with Discus II. The primary reason for this decision is to avoid the need for wholesalers to stock two separate models for the same application.

# 4D Copeland Discus™ III – Semi-Hermetic Compressors

## Common Replacement Parts

| Common Parts   | Part Number |
|--|-------------|
| Sight Glass Kit  | 998-0002-02 |
| Sight Glass O-Ring   | 020-0844-05 |
| Oil Screen Kit   | 998-0513-02 |
| Magnetic Plug Gasket - 1" Internal Thread                                | 020-0006-52 |
| Magnetic Plug Gasket - 1 1/8" Internal Thread                            | 020-0006-38 |
| Oil Pump Kit   | 998-0008-33 |
| Suction Strainer Assembly  | 548-0116-00 |
| Terminal Jumpers/Extensions  | 521-0065-00 |
| Gaskets  | Part Number |
| Complete Gasket Set (Discus III)   | 998-3669-00 |
| Capacity Control Valve   |             |
| Discus III - 4D*N Models   | 020-1465-00 |
| Capacity Control Blank Plate (Full Load Gasket) Discus III - 4D*N Models | 020-1445-00 |
| Stator Cover   | 020-0755-00 |
| Bottom Plate   | 020-1265-00 |
| Oil Pump   | 020-1267-00 |
| Housing Cover  | 020-1545-00 |
| CoreSense™ Kits and Parts  | Part Number |
| CoreSense Module   | 943-0128-00 |
| 4D/6D CoreSense Wiring Harness   | 929-0098-00 |
| CoreSense DLT Thermistor   | 985-0109-50 |
| CoreSense Module Mounting Bracket/Stud Kit                               | 974-1315-00 |
| CoreSense Current Torroid  | 943-0064-00 |
| Sensor Only Kit  | 998-0162-01 |
| Copper Gasket for Sensor   | 020-0297-13 |
| O-Ring Gasket for Sensor   | 020-0003-28 |
| Crankcase Heater (Flat Bottom Plate Models)                              | Part Number |
| 120V 100 Watt (US part# 918-0028-00)                                     | 518-0028-06 |
| 240V 100 Watt (US part# 918-0028-01)                                     | 518-0028-07 |
| Crankcase Heater Sleeve  | 030-0186-01 |



## Common Replacement Parts

| Digital Compressor Unloader Valve/Coil  | Part Number |
|---|-------------|
| Valve Less Coil - 4D*X Models           | 910-0127-00 |
| 24 Volt Coil Only                       | 923-0084-00 |
| 120 Volt Coil Only                      | 923-0084-01 |
| 240 Volt Coil Only                      | 923-0084-02 |
| IDCM Module                             | 943-0088-00 |
| Digital Unloader Gasket - 4D*X Models   | 020-1446-00 |
| Blocked Suction Unloader Valves & Coils | Part Number |
| Valve Less Coil                         | 998-0213-00 |
| 24 Volt Valve and Coil Kit              | 998-0213-01 |
| 24 Volt Coil Only                       | 023-0091-00 |
| 120 Volt Valve and Coil Kit             | 998-0213-02 |
| 120 Volt Coil Only                      | 023-0091-01 |
| 240 Volt Valve and Coil Kit             | 998-0213-03 |
| 240 Volt Coil Only                      | 023-0091-02 |
| Unloader Piston Kit                     | 998-0130-00 |

## Cooling Fan Kits

| Cooling Fan Kits               | Part #      | Used On              |
|--------------------------------|-------------|----------------------|
| 115 Volt Fan Motor Kit         | 998-0550-02 | All 4D Discus III    |
| 115 Volt Replacement Fan Motor | 998-0550-05 | All 4D Discus III    |
| 230 Volt Fan Motor Kit         | 998-0550-00 | All 4D Discus III    |
| 230 Volt Replacement Fan Motor | 998-0550-03 | All 4D Discus III    |
| 460 Volt Fan Motor Kit         | 998-0550-01 | All 4D Discus III    |
| 460 Volt Replacement Fan Motor | 998-0550-04 | All 4D Discus III    |
| Fan Mounting Kit               | 998-0574-16 | All 4D*N/4D*X Models |
| Fan Blade                      | 083-0118-00 | All 4D Discus III    |

## Service Valves

| Part #      | Size   | Discharge | Suction | Style       | MTG Center        | Thread    |
|-------------|--------|-----------|---------|-------------|-------------------|-----------|
| 998-0510-02 | 1 1/8" | X         |         | Rotalock    |                   | 1 3/7"-12 |
| 998-0510-46 | 1 3/8" | X         |         | Rotalock    |                   | 1 3/7"-12 |
| 998-0510-09 | 1 1/8" | X         |         | Bolt on (2) | 2 3/4" x 2 3/4"   |           |
| 998-0510-11 | 1 3/8" | X         |         | Bolt on (2) | 2 3/4" x 2 3/4"   |           |
| 998-0510-07 | 1 5/8" |           | X       | Bolt on (4) | 2 1/2" x 2 1/2"   |           |
| 998-0510-20 | 2 1/8" |           | X       | Bolt on (4) | 3 1/16" x 3 1/16" |           |

# 4D Copeland Discus™ III – Semi-Hermetic Compressors

## 4D Discus™ III Delta Reed Models - Compressor Parts

| Model                  | Equivalent Digital Model | Standard Valve Plate Kit | Unloader Valve Plate Kit | Cylinder Head Gasket | Unloader Cylinder Head Gasket | Valve Plate Gasket | Terminal Plate Group |
|------------------------|--------------------------|--------------------------|--------------------------|----------------------|-------------------------------|--------------------|----------------------|
|                        |                          | (998-)                   | (998-)                   | (020-)               | (020-)                        | (020-)             | (521-)               |
| 4DBNF54KE-TSE          | 4DBXF54KE-TSE            | 3661-26                  |                          | 1505-00              |                               | 1450-00            | 0143-00              |
| 4DBNF54KE-TSK          | 4DBXF54KE-TSK            | 3661-26                  |                          | 1505-00              |                               | 1450-00            | 0142-00              |
| 4DBNR20ME-FSD          | 4DBXR20ME-FSD            | 3661-27                  |                          | 1505-00              |                               | 1450-00            | 0140-00              |
| 4DBNR20ME-TSE          | 4DBXR20ME-TSE            | 3661-27                  |                          | 1505-00              |                               | 1450-00            | 0140-00              |
| 4DBNR20ME-TSK          | 4DBXR20ME-TSK            | 3661-27                  |                          | 1505-00              |                               | 1450-00            | 0142-00              |
| <b>D</b> 4DBXF54KE-TSE |                          | 3661-26                  | 3661-65                  | 1505-00              | 1455-00                       | 1450-00            | 0143-00              |
| <b>D</b> 4DBXF54KE-TSK |                          | 3661-26                  | 3661-65                  | 1505-00              | 1455-00                       | 1450-00            | 0142-00              |
| <b>D</b> 4DBXR20ME-FSD |                          | 3661-27                  | 3661-66                  | 1505-00              | 1455-00                       | 1450-00            | 0140-00              |
| <b>D</b> 4DBXR20ME-TSE |                          | 3661-27                  | 3661-66                  | 1505-00              | 1455-00                       | 1450-00            | 0140-00              |
| <b>D</b> 4DBXR20ME-TSK |                          | 3661-27                  | 3661-66                  | 1505-00              | 1455-00                       | 1450-00            | 0142-00              |
| • 4DCNF54KE-TSE        | 4DBXF54KE-TSE            | 3661-26                  | 3661-25                  | 1505-00              | 1454-00                       | 1450-00            | 0143-00              |
| • 4DCNF54KE-TSK        | 4DBXF54KE-TSK            | 3661-26                  | 3661-25                  | 1505-00              | 1454-00                       | 1450-00            | 0142-00              |
| • 4DCNR20ME-FSD        | 4DBXR20ME-FSD            | 3661-27                  | 3661-28                  | 1505-00              | 1454-00                       | 1450-00            | 0140-00              |
| • 4DCNR20ME-TSE        | 4DBXR20ME-TSE            | 3661-27                  | 3661-28                  | 1505-00              | 1454-00                       | 1450-00            | 0140-00              |
| • 4DCNR20ME-TSK        | 4DBXR20ME-TSK            | 3661-27                  | 3661-28                  | 1505-00              | 1454-00                       | 1450-00            | 0142-00              |
| 4DHNF63KE-FSD          | 4DHXF63KE-FSD            | 3661-26                  |                          | 1505-00              |                               |                    | 0140-00              |
| 4DHNF63KE-TSE          | 4DHXF63KE-TSE            | 3661-26                  |                          | 1505-00              |                               | 1450-01            | 0143-00              |
| 4DHNF63KE-TSK          | 4DHXF63KE-TSK            | 3661-26                  |                          | 1505-00              |                               | 1450-01            | 0142-00              |
| 4DHNR16ME-TSK          | N/A                      | 3661-27                  |                          | 1505-00              |                               | 1450-01            | 0142-00              |
| 4DHNR22ME-FSD          | 4DHXR22ME-FSD            | 3661-27                  |                          | 1505-00              |                               | 1450-01            | 0140-00              |
| 4DHNR22ME-TSE          | 4DHXR22ME-TSE            | 3661-27                  |                          | 1505-00              |                               | 1450-01            | 0140-00              |
| 4DHNR22ME-TSK          | 4DHXR22ME-TSK            | 3661-27                  |                          | 1505-00              |                               | 1450-01            | 0142-00              |
| <b>D</b> 4DHXF63KE-FSD |                          | 3661-26                  | 3661-65                  | 1505-00              | 1455-00                       | 1450-01            | 0140-00              |
| <b>D</b> 4DHXF63KE-TSE |                          | 3661-26                  | 3661-65                  | 1505-00              | 1455-00                       | 1450-01            | 0143-00              |
| <b>D</b> 4DHXF63KE-TSK |                          | 3661-26                  | 3661-65                  | 1505-00              | 1455-00                       | 1450-01            | 0142-00              |
| <b>D</b> 4DHXR22ME-FSD |                          | 3661-27                  | 3661-66                  | 1505-00              | 1455-00                       | 1450-01            | 0140-00              |
| <b>D</b> 4DHXR22ME-TSE |                          | 3661-27                  | 3661-66                  | 1505-00              | 1455-00                       | 1450-01            | 0140-00              |
| <b>D</b> 4DHXR22ME-TSK |                          | 3661-27                  | 3661-66                  | 1505-00              | 1455-00                       | 1450-01            | 0142-00              |
| 4DJNF76ME-FSD          | 4DJXF76ME-FSD            | 3661-26                  |                          | 1505-00              |                               | 1450-03            | 0140-00              |
| 4DJNF76ME-TSE          | 4DJXF76ME-TSK            | 3661-26                  |                          | 1505-00              |                               | 1450-03            | 0140-00              |
| 4DJNF76ME-TSK          | 4DJXF76ME-TSE            | 3661-26                  |                          | 1505-00              |                               | 1450-03            | 0142-00              |
| 4DJNR19ME-TSK          | N/A                      | 3661-27                  |                          | 1505-00              |                               | 1450-03            | 0142-00              |
| 4DJNR28ME-FSD          | 4DJXR28ME-FSD            | 3661-27                  |                          | 1505-00              |                               | 1450-03            | 0140-00              |
| 4DJNR28ME-TSE          | 4DJXR28ME-TSE            | 3661-27                  |                          | 1505-00              |                               | 1450-03            | 0140-00              |
| 4DJNR28ME-TSK          | 4DJXR28ME-TSK            | 3661-27                  |                          | 1505-00              |                               | 1450-03            | 0142-00              |
| <b>D</b> 4DJXF76ME-FSD |                          | 3661-26                  | 3661-65                  | 1505-00              | 1455-00                       | 1450-03            | 0140-00              |
| <b>D</b> 4DJXF76ME-TSE |                          | 3661-26                  | 3661-65                  | 1505-00              | 1455-00                       | 1450-03            | 0140-00              |
| <b>D</b> 4DJXF76ME-TSK |                          | 3661-26                  | 3661-65                  | 1505-00              | 1455-00                       | 1450-03            | 0142-00              |

**D** = Digital Model  
 • = 1 Bank Unloading

New Model Nomenclature (5th Digit = Application Rating)  
 R = Rating at +45°F to +130°F at 90°F Ambient Air  
 S = Rating at +20°F to +120°F at 90°F Ambient Air  
 F = Rating at -25°F to +105°F at 90° Ambient Air

# Semi-Hermetic Compressors – 4D Copeland Discus™ III

## 4D Discus™ III Delta Reed Models - Compressor Parts

| Model                  | Equivalent Digital Model | Standard Valve Plate Kit | Unloader Valve Plate Kit | Cylinder Head Gasket | Unloader Cylinder Head Gasket | Valve Plate Gasket | Terminal Plate Group |
|------------------------|--------------------------|--------------------------|--------------------------|----------------------|-------------------------------|--------------------|----------------------|
|                        |                          | (998-)                   | (998-)                   | (020-)               | (020-)                        | (020-)             | (521-)               |
| <b>D</b> 4DJXR28ME-FSD |                          | 3661-27                  | 3661-66                  | 1505-00              | 1455-00                       | 1450-03            | 0140-00              |
| <b>D</b> 4DJXR28ME-TSE |                          | 3661-27                  | 3661-66                  | 1505-00              | 1455-00                       | 1450-03            | 0140-00              |
| <b>D</b> 4DJXR28ME-TSK |                          | 3661-27                  | 3661-66                  | 1505-00              | 1455-00                       | 1450-03            | 0142-00              |
| • 4DKNF63KE-FSD        | 4DHXF63KE-FSD            | 3661-26                  | 3661-25                  | 1505-00              | 1454-00                       | 1450-01            | 0140-00              |
| • 4DKNF63KE-TSE        | 4DHXF63KE-TSE            | 3661-26                  | 3661-25                  | 1505-00              | 1454-00                       | 1450-01            | 0143-00              |
| • 4DKNF63KE-TSK        | 4DHXF63KE-TSK            | 3661-26                  | 3661-25                  | 1505-00              | 1454-00                       | 1450-01            | 0142-00              |
| • 4DKNR16ME-TSE        | N/A                      | 3661-27                  | 3661-28                  | 1505-00              | 1454-00                       | 1450-01            | 0143-00              |
| • 4DKNR16ME-TSK        | N/A                      | 3661-27                  | 3661-28                  | 1505-00              | 1454-00                       | 1450-01            | 0142-00              |
| • 4DKNR22ME-FSD        | 4DHXR22ME-FSD            | 3661-27                  | 3661-28                  | 1505-00              | 1454-00                       | 1450-01            | 0140-00              |
| • 4DKNR22ME-TSE        | 4DHXR22ME-TSE            | 3661-27                  | 3661-28                  | 1505-00              | 1454-00                       | 1450-01            | 0140-00              |
| • 4DKNR22ME-TSK        | 4DHXR22ME-TSK            | 3661-27                  | 3661-28                  | 1505-00              | 1454-00                       | 1450-01            | 0142-00              |
| • 4DRNF76KE-FSD        | 4DJXF76KE-FSD            | 3661-26                  | 3661-25                  | 1505-00              | 1454-00                       | 1450-03            | 0140-00              |
| • 4DRNF76KE-TSE        | 4DJXF76KE-TSE            | 3661-26                  | 3661-25                  | 1505-00              | 1454-00                       | 1450-03            | 0140-00              |
| • 4DRNF76KE-TSK        | 4DJXF76KE-TSK            | 3661-26                  | 3661-25                  | 1505-00              | 1454-00                       | 1450-03            | 0142-00              |
| • 4DRNR19ME-TSK        |                          | 3661-27                  | 3661-28                  | 1505-00              | 1454-00                       | 1450-03            | 0142-00              |
| • 4DRNR28ME-FSD        | 4DJXR28ME-FSD            | 3661-27                  | 3661-28                  | 1505-00              | 1454-00                       | 1450-03            | 0140-00              |
| • 4DRNR28ME-TSE        | 4DJXR28ME-TSE            | 3661-27                  | 3661-28                  | 1505-00              | 1454-00                       | 1450-03            | 0140-00              |
| • 4DRNR28ME-TSK        | 4DJXR28ME-TSK            | 3661-27                  | 3661-28                  | 1505-00              | 1454-00                       | 1450-03            | 0142-00              |

**D** = Digital Model  
 • = 1 Bank Unloading

New Model Nomenclature (5th Digit = Application Rating)  
 R = Rating at +45°F to +130°F at 90°F Ambient Air  
 S = Rating at +20°F to +120°F at 90°F Ambient Air  
 F = Rating at -25°F to +105°F at 90° Ambient Air





# CO<sub>2</sub> Semi-Hermetic Compressors – 4M

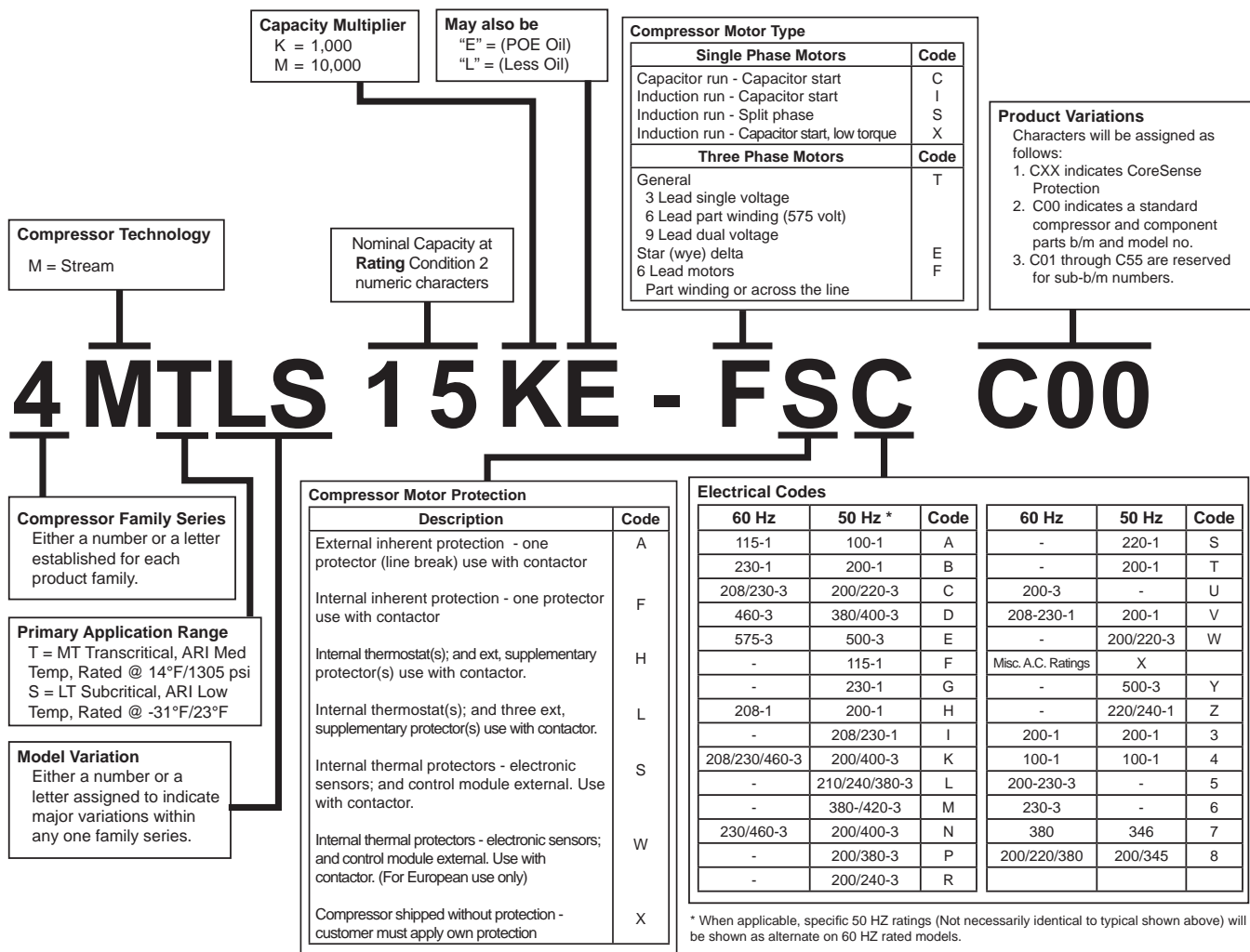

# 4M – CO<sub>2</sub> Semi-Hermetic Compressors

| CO <sub>2</sub> Service Parts Kit      | Part Number |
|--|-------------|
| Sight Glass Kit                        | 970-0026-00 |
| Oil Sensor CO2 Kit                     | 998-0244-00 |
| Low Pressure Release Valve Kit         | 910-0006-00 |
| High Pressure Release Valve Kit        | 910-0006-01 |
| Shut-off Valves Kit                    | 910-0006-02 |
| Bolt Head Kit                          | 911-0105-00 |
| Bolt Stator Kit                        | 911-0105-01 |
| Bolt Housing Kit                       | 911-0105-02 |
| Crankcase Heater Kit 115 Volt 100 Watt | 918-0003-00 |
| Crankcase Heater Kit 230 Volt 100 Watt | 918-0003-01 |
| Gasket Shut-off Valve Kit              | 920-0015-00 |
| Gasket Stator Kit                      | 920-0015-01 |
| Gasket Housing Kit                     | 920-0015-02 |
| Gasket Cylinder Head Gasket Kit        | 920-0015-03 |
| Terminal Plate Gasket FSC Kit          | 920-0019-01 |
| Terminal Plate FSC                     | 921-0022-00 |
| Compressor Mounting Kit                | 927-0041-00 |
| CoreSense™ Kit                         | 943-0030-00 |
| Suction Filter Kit                     | 998-0256-00 |

## 4M CO<sub>2</sub> Models - Compressor Parts

| Model         | Valve Plate K | Complete Gasket | Valve Plate Gasket |
|---------------|---------------|-----------------|--------------------|
|               | (903-)        | (920-)          |                    |
| 4MTLS11ME-FSC | 0986-01       | 0015-00         | 020-1501-00        |
| 4MTLS15ME-TSE | 0986-02       | 0015-00         | 020-1502-00        |
| 4MTLS82KL-FSD | 0986-00       | 0015-00         | 020-1500-00        |
| 4MTLS11ML-FSD | 0986-01       | 0015-00         | 020-1501-00        |
| 4MTLS15ML-FSD | 0986-02       | 0015-00         | 020-1502-00        |
| 4MTLS82KL-FSD | 0986-00       | 0015-00         | 020-1500-00        |
| 4MTLS11ML-FSD | 0986-01       | 0015-00         | 020-1501-00        |
| 4MTLS15ML-FSD | 0986-02       | 0015-00         | 020-1502-00        |
| 4MTLS11ME-FSD | 0986-01       | 0015-00         | 020-1501-00        |
| 4MTLS11ME-TSE | 0986-01       | 0015-00         | 020-1501-00        |
| 4MTLS11ML-TSE | 0986-01       | 1501-00         | 020-1501-00        |
| 4MTLS15ME-FSC | 0986-02       | 0015-00         | 020-1502-00        |
| 4MTLS15ME-FSD | 0986-02       | 0015-00         | 020-1502-00        |
| 4MTLS15ML-TSE | 0986-02       | 0015-00         | 020-1502-00        |
| 4MTLS82KE-FSC | 0986-00       | 0015-00         | 020-1500-00        |
| 4MTLS82KE-FSD | 0986-00       | 0015-00         | 020-1500-00        |
| 4MTLS82KE-TSE | 0986-00       | 0015-00         | 020-1500-00        |
| 4MTLS82KL-TSE | 0986-00       | 0015-00         | 020-1500-00        |

# Semi-Hermetic Compressors – 6D, 6R and 6T

| Compressor Cooling |                    |
|--------------------|--------------------|
| Code               | Description        |
| A                  | Air cooled         |
| D                  | Discus             |
| R                  | Refrigerant cooled |
| T                  | Std. two stage     |
| W                  | Water cooled       |

| Comp. Motor Rating Nominal |      |              |      |    |      |
|----------------------------|------|--------------|------|----|------|
| HP                         | Code | HP           | Code | HP | Code |
| 1/4                        | 0025 | 2-3/4        | 0275 | 15 | 1500 |
| 1/3                        | 0033 | 3 (0310)     | 0300 | 20 | 2000 |
| 1/2                        | 0050 | 3-1/2        | 0350 | 25 | 2500 |
| 3/4                        | 0075 | 4 (0406)     | 0400 | 30 | 3000 |
| 1                          | 0100 | 5 (0506)     | 0500 | 35 | 3500 |
| 1-1/4                      | 0125 | 6            | 0600 | 40 | 4000 |
| 1-1/2                      | 0150 | 7-1/2 (0766) | 0750 | 50 | 5000 |
| 1-3/4                      | 0175 | 9            | 0900 | 60 | 6000 |
| 2                          | 0200 | 10 (1015)    | 1000 |    |      |
| 2-1/2                      | 0250 | 12           | 1200 |    |      |

| Compressor Motor Type                       |  | Code |
|---|--|------|
| Single Phase Motors                         |  | Code |
| Capacitor run - Capacitor start             |  | C    |
| Induction run - Capacitor start             |  | I    |
| Induction run - Split phase                 |  | S    |
| Induction run - Capacitor start, low torque |  | X    |
| Three Phase Motors                          |  | Code |
| General                                     |  | T    |
| 3 Lead single voltage                       |  |      |
| 6 Lead part winding (575 volt)              |  |      |
| 9 Lead dual voltage                         |  |      |
| Star (wye) delta                            |  |      |
| 6 Lead motors                               |  | E    |
| Part winding or across the line             |  | F    |

**Product Variations**  
Numbers will be assigned as follows:  
1. Numbers -001 through -199 are reserved for sub+b/m numbers.  
2. Numbers -200 indicates a standard compressor and component parts b/m and model no.  
3. Numbers -201 and larger will be assigned for all other variations of a given model.

**Tandem Style Models**  
Indicated by the digit representing the comp. model series connected in tandem with a comp. of the model series indicated by the first digit.

**May be = (-) or A**  
Note: Nominal horsepower rating of tandem compressors is sum of individual compressor ratings

## 6RN2 - 3000 - TSE 800

| Compressor Motor Protection  |      |
|--|------|
| Description  | Code |
| External inherent protection - one protector (line break) use with contactor   | A    |
| Internal inherent protection - one protector use with contactor  | F    |
| Internal thermostat(s); and ext. supplementary protector(s) use with contactor.  | H    |
| Internal thermostat(s); and three ext. supplementary protector(s) use with contactor.                                      | L    |
| Internal thermal protectors - electronic sensors; and control module external. Use with contactor.                         | S    |
| Internal thermal protectors - electronic sensors; and control module external. use with contactor (For European use only). | W    |

| Electrical Codes |               |      |                    |           |      |
|------------------|---------------|------|--------------------|-----------|------|
| 60 Hz            | 50 Hz         | Code | 60 Hz              | 50 Hz     | Code |
| 115-1            | 100-1         | A    | -                  | 220-1     | S    |
| 230-1            | 200-1         | B    | -                  | 200-1     | T    |
| 5206-230-3       | 200/220-3     | C    | 200-3              | -         | U    |
| 460-3            | 380/400-3     | D    | 208-230-1          | 200-1     | V    |
| 575-3            | 500-3         | E    | -                  | 200/220-3 | W    |
| -                | 115-1         | F    | Misc. A.C. Ratings | X         |      |
| -                | 230-1         | G    | -                  | 500-3     | Y    |
| 208-1            | 200-1         | H    | -                  | 220/240-1 | Z    |
| -                | 208/230-1     | I    | 200-1              | 200-1     | 3    |
| 208/230/460-3    | 200/400-3     | K    | 100-1              | 100-1     | 4    |
| -                | 210/240/380-3 | L    | 200-230-3          | -         | 5    |
| -                | 380/420-3     | M    | 230-3              | -         | 6    |
| 230/460-3        | 200/400-3     | N    | 380                | 346       | 7    |
| -                | 200/380-3     | P    | 200/220/380        | 200/345   | 8    |
| -                | 200/240-3     | R    |                    |           |      |

**Compressor Family Series**  
Either a number or a letter established for each product family.

**Displacement and Valve Plate**  
A letter only, arbitrarily assigned for each different displacement within any one family series.

**Model Variation**  
A number or letter, assigned to indicate different model types within any family series.

**May also be**  
"A" = (Alkylbenzene)  
"E" = (POE Oil)  
"L" = (Less Oil)

\*When applicable, specific 50 Hz ratings (Not necessarily identical to typical shown above) will be shown as alternate on 60 HZ rated models.



# 6D, 6R and 6T – Semi-Hermetic Compressors

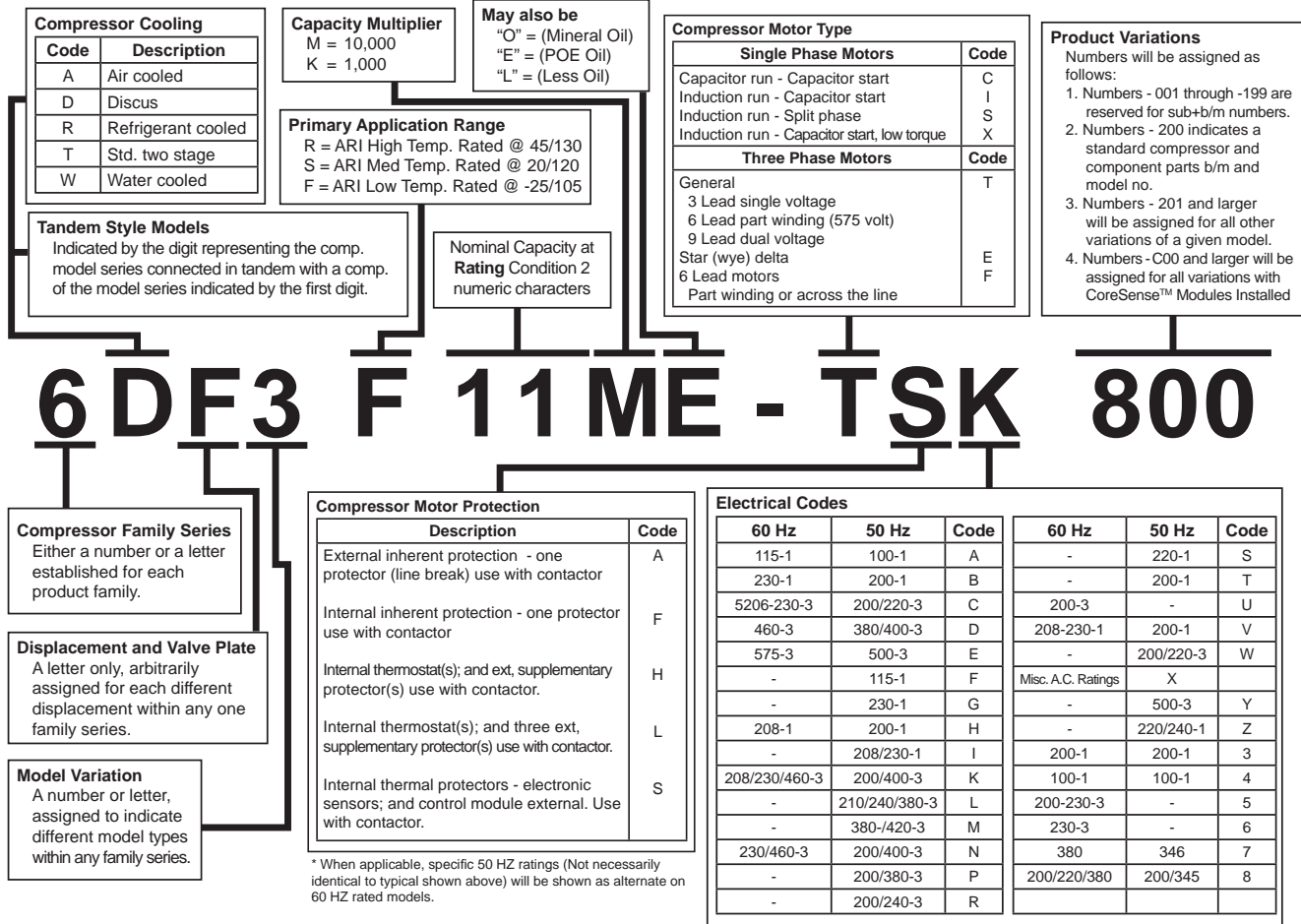

| Unloader Valves and Coils   | Part Number | Obsolete (Alco) Valve |
|-----------------------------|-------------|-----------------------|
| Valve Less Coil             | 998-0212-00 |                       |
| 24 Volt Valve and Coil Kit  | 998-0212-01 |                       |
| 24 Volt Coil Only           | 023-0091-00 | 023-0039-09           |
| 120 Volt Valve and Coil Kit | 998-0212-02 |                       |
| 120 Volt Coil Only          | 023-0091-01 | 023-0039-10           |
| 240 Volt Valve and Coil Kit | 998-0212-03 |                       |
| 240 Volt Coil Only          | 023-0091-02 | 023-0039-11           |
| Unloader Piston Kit         | 998-0130-00 |                       |

# Semi-Hermetic Compressors – 6D, 6R and 6T

## Common Replacement Parts

| Common Parts                                  | Part Number |
|---|-------------|
| Sight Glass Kit                               | 998-0002-02 |
| Sight Glass O-Ring                            | 020-0844-05 |
| Oil Screen Kit                                | 998-0513-02 |
| Magnetic Plug Gasket - 1" Internal Thread     | 020-0006-52 |
| Magnetic Plug Gasket - 1 1/8" Internal Thread | 020-0006-38 |
| Oil Pump Kit                                  | 998-0008-33 |
| Suction Strainer Assembly                     | 548-0116-00 |
| Terminal Jumpers/Extensions                   | 521-0065-00 |
| Gaskets                                       | Part Number |
| Complete Gasket Set (Floating Reed)           | 998-1669-01 |
| Complete Gasket Set (Delta Reed)              | 998-2669-01 |
| Unloading Valve                               | 020-0783-00 |
| Housing Cover                                 | 020-0636-00 |
| Stator Cover                                  | 020-0755-00 |
| Bottom Plate                                  | 020-1265-00 |
| Oil Pump                                      | 020-1267-00 |
| Crankcase Heater (Flat Bottom Plate Models)   | Part Number |
| 120 Volt 100 Watt (US part# 918-0028-00)      | 518-0028-06 |
| 240 Volt 100 Watt (US part# 918-0028-01)      | 518-0028-07 |
| Crankcase Heater Sleeve                       | 030-0186-01 |
| Crankcase Heater (Deep Sump Models)           | Part Number |
| 120V 200 Watt All 6DJ/R/S, 6DT/E/F & 6D*8     | 918-0518-00 |
| 240V 200 Watt All 6DJ/R/S, 6DT/E/F & 6D*8     | 918-0518-01 |
| 480V 200 Watt All 6DJ/R/S, 6DT/E/F & 6D*8     | 918-0518-02 |
| CoreSense™ Parts                              | Part Number |
| CoreSense Module                              | 943-0109-00 |
| 6R/6D CoreSense Wiring Harness                | 929-0098-00 |
| CoreSense DLT Thermistor                      | 985-0109-50 |
| CoreSense Module Mounting Bracket/Stud Kit    | 974-1315-00 |
| Sensor Only Kit                               | 998-0162-01 |
| Copper Gasket for Sensor                      | 020-0297-13 |
| O-Ring Gasket for Sensor                      | 020-0003-28 |
| Solid State Module                            | Part Number |
| 24 Volt Module                                | 998-0424-06 |
| 120/240 Volt Module                           | 998-0524-10 |
| Sensor Terminal Board                         | 580-0054-00 |
| Sentronic 3 Kits and Parts                    | Part Number |
| Complete Kit                                  | 585-1076-02 |
| Sensor and Cable Kit                          | 998-0162-00 |
| Sensor Only Kit                               | 998-0162-01 |
| Copper Gasket for Sensor                      | 020-0297-13 |
| O-Ring Gasket for Sensor                      | 020-0003-28 |



# 6D, 6R and 6T – Semi-Hermetic Compressors

## Cooling Fan Kits

| Cooling Fan Kits               | Part Number | Used On                   |
|--------------------------------|-------------|---------------------------|
| 115 Volt Fan Motor Kit         | 998-0550-02 | All 6D's & 6R's           |
| 115 Volt Replacement Fan Motor | 998-0550-05 | All 6D's & 6R's           |
| 230 Volt Fan Motor Kit         | 998-0550-00 | All 6D's & 6R's           |
| 230 Volt Replacement Fan Motor | 998-0550-03 | All 6D's & 6R's           |
| 460 Volt Fan Motor Kit         | 998-0550-01 | All 6D's & 6R's           |
| 460 Volt Replacement Fan Motor | 998-0550-04 | All 6D's & 6R's           |
| Fan Mounting Kit               | 998-0574-04 | 6D*1 & 6R's (Small Head)  |
| Fan Mounting Kit               | 998-0574-05 | 6RL's, 6RT's, 6DL1 & 6DT1 |
| Fan Mounting Kit               | 998-0574-13 | 6D*3's Only               |
| Fan Blade                      | 083-0118-00 | All 6D's & 6R's           |

## Oil Screen Kits

| Oil Screen Kits | Part Number | Used On         |
|-----------------|-------------|-----------------|
| Oil Screen Kit  | 998-0513-02 | All 6D's        |
| Oil Screen Kit  | 998-0513-00 | All 6R's & 6T's |

## Oil Cooler Kits

| Oil Cooler Kits | Part Number | Used On                   |
|-----------------|-------------|---------------------------|
| Oil Cooler Kit  | 998-1123-00 | 6RL/T & 6D*1 (Small Head) |
| Oil Cooler Kit  | 998-1126-00 | 6D*3's                    |
| Tee Fitting     | 036-0415-01 | All 6D's & 6R's           |

## Service Valves

| Part #      | Size   | Discharge | Suction | Style       | MTG Center        | Thread    |
|-------------|--------|-----------|---------|-------------|-------------------|-----------|
| 998-0510-46 | 1 3/8" | X         |         | Rotalock    |                   | 1 3/4"-12 |
| 998-0510-66 | 1 5/8" | X         |         | Rotalock    |                   | 1 3/4"-12 |
| 998-0510-11 | 1 3/8" |           | X       | Bolt on (2) | 2 1/4" x 2 1/4"   |           |
| 998-0510-07 | 1 5/8" |           | X       | Bolt on (4) | 2 1/2" x 2 1/2"   |           |
| 998-0510-20 | 2 1/8" |           | X       | Bolt on (4) | 3 1/16" x 3 1/16" |           |

| Digital Compressor Parts      | Part #      |
|-------------------------------|-------------|
| Valve Less Coil - 6D*D models | 910-0111-00 |
| 24V Coil Only Kit             | 923-0084-00 |
| 120V Coil Only Kit            | 923-0084-01 |
| 240V Coil Only Kit            | 923-0084-02 |
| Unloader Gasket               | 020-1369-01 |
| IDCM Control Module           | 943-0194-00 |
| Discharge Thermistor          | 985-0109-07 |
| Unloader Piston Kit           | 998-0130-00 |

# Semi-Hermetic Compressors – 6D, 6R and 6T

## 6D Floating Reed Models - Compressor Parts

| Model            | Valve Plate Kit | Unloader Valve Plate Kit | Cylinder Head Gasket | Unloader Cylinder Head Gasket | Valve Plate Gasket | Terminal Plate Group |
|------------------|-----------------|--------------------------|----------------------|-------------------------------|--------------------|----------------------|
|                  | (998-)          | (998-)                   | (020-)               | (020-)                        | (020-)             | (521-)               |
| 6DB3-3000-FSD    | 1661-27         |                          | 0600-00              |                               | 0664-03            | 0140-01              |
| 6DB3-3000-TSE    | 1661-27         |                          | 0600-00              |                               | 0664-03            | 0140-01              |
| 6DB3-3000-TSK    | 1661-27         |                          | 0600-00              |                               | 0664-03            | 0142-01              |
| 6DB3-300E-FSD    | 1661-27         |                          | 0600-00              |                               | 0664-03            | 0140-01              |
| 6DB3-300E-TSE    | 1661-27         |                          | 0600-00              |                               | 0664-03            | 0140-01              |
| 6DB3-300E-TSK    | 1661-27         |                          | 0600-00              |                               | 0664-03            | 0142-01              |
| • 6DC1-2700-TSE  | 1661-26         | 1661-25                  | 0600-00              | 0616-00                       | 0664-03            | 0140-00              |
| • 6DC1-2700-TSK  | 1661-26         | 1661-25                  | 0600-00              | 0616-00                       | 0664-03            | 0142-00              |
| • 6DC3-2700-FSD  | 1661-26         | 1661-25                  | 0600-00              | 0616-00                       | 0664-03            | 0140-00              |
| • 6DC3-2700-TSE  | 1661-26         | 1661-25                  | 0600-00              | 0616-00                       | 0664-03            | 0140-00              |
| • 6DC3-2700-TSK  | 1661-26         | 1661-25                  | 0600-00              | 0616-00                       | 0664-03            | 0142-00              |
| • 6DC3-270E-FSD  | 1661-26         | 1661-25                  | 0600-00              | 0616-00                       | 0664-03            | 0140-00              |
| • 6DC3-270E-TSE  | 1661-26         | 1661-25                  | 0600-00              | 0616-00                       | 0664-03            | 0140-00              |
| • 6DC3-270E-TSK  | 1661-26         | 1661-25                  | 0600-00              | 0616-00                       | 0664-03            | 0142-00              |
| •• 6DD1-2700-FSD | 1661-26         | 1661-25                  | 0600-00              | 0616-00                       | 0664-03            | 0140-00              |
| •• 6DD1-2700-TSK | 1661-26         | 1661-25                  | 0600-00              | 0616-00                       | 0664-03            | 0142-00              |
| •• 6DD3-2700-FSD | 1661-26         | 1661-25                  | 0600-00              | 0616-00                       | 0664-03            | 0140-00              |
| •• 6DD3-2700-TSE | 1661-26         | 1661-25                  | 0600-00              | 0616-00                       | 0664-03            | 0140-00              |
| •• 6DD3-2700-TSK | 1661-26         | 1661-25                  | 0600-00              | 0616-00                       | 0664-03            | 0142-00              |
| •• 6DD3-270E-FSD | 1661-26         | 1661-25                  | 0600-00              | 0616-00                       | 0664-03            | 0140-00              |
| •• 6DD3-270E-TSE | 1661-26         | 1661-25                  | 0600-00              | 0616-00                       | 0664-03            | 0140-00              |
| •• 6DD3-270E-TSK | 1661-26         | 1661-25                  | 0600-00              | 0616-00                       | 0664-03            | 0142-00              |
| • 6DE1-3000-ES8  | 1661-26         | 1661-25                  | 0600-00              | 0616-00                       | 0664-05            | 0141-00              |
| • 6DE1-3000-TSK  | 1661-26         | 1661-25                  | 0600-00              | 0616-00                       | 0664-05            | 0142-00              |
| • 6DE3-3000-FSD  | 1661-26         | 1661-25                  | 0600-00              | 0616-00                       | 0664-05            | 0140-00              |
| • 6DE3-3000-TSE  | 1661-26         | 1661-25                  | 0600-00              | 0616-00                       | 0664-05            | 0140-00              |

- 1 Bank Unloading
- 2 Banks Unloading

# 6D, 6R and 6T – Semi-Hermetic Compressors

## 6D Floating Reed Models - Compressor Parts

| Model            | Valve Plate Kit | Unloader Valve Plate Kit | Cylinder Head Gasket | Unloader Cylinder Head Gasket | Valve Plate Gasket | Terminal Plate Group |
|------------------|-----------------|--------------------------|----------------------|-------------------------------|--------------------|----------------------|
|                  | (998-)          | (998-)                   | (020-)               | (020-)                        | (020-)             | (521-)               |
| • 6DE3-3000-TSK  | 1661-26         | 1661-25                  | 0600-00              | 0616-00                       | 0664-05            | 0142-00              |
| • 6DE3-300E-FSD  | 1661-26         | 1661-25                  | 0600-00              | 0616-00                       | 0664-05            | 0140-00              |
| • 6DE3-300E-TSE  | 1661-26         | 1661-25                  | 0600-00              | 0616-00                       | 0664-05            | 0140-00              |
| • 6DE3-300E-TSK  | 1661-26         | 1661-25                  | 0600-00              | 0616-00                       | 0664-05            | 0142-00              |
| •• 6DF1-3000-ES8 | 1661-26         | 1661-25                  | 0600-00              | 0616-00                       | 0664-05            | 0141-00              |
| •• 6DF1-3000-FSD | 1661-26         | 1661-25                  | 0600-00              | 0616-00                       | 0664-05            | 0140-00              |
| •• 6DF1-3000-TSK | 1661-26         | 1661-25                  | 0600-00              | 0616-00                       | 0664-05            | 0142-00              |
| •• 6DF3-3000-FSD | 1661-26         | 1661-25                  | 0600-00              | 0616-00                       | 0664-05            | 0140-00              |
| •• 6DF3-3000-TSE | 1661-26         | 1661-25                  | 0600-00              | 0616-00                       | 0664-05            | 0140-00              |
| •• 6DF3-3000-TSK | 1661-26         | 1661-25                  | 0600-00              | 0616-00                       | 0664-05            | 0142-00              |
| •• 6DF3-300E-FSD | 1661-26         | 1661-25                  | 0600-00              | 0616-00                       | 0664-05            | 0140-00              |
| •• 6DF3-300E-TSE | 1661-26         | 1661-25                  | 0600-00              | 0616-00                       | 0664-05            | 0140-00              |
| •• 6DF3-300E-TSK | 1661-26         | 1661-25                  | 0600-00              | 0616-00                       | 0664-05            | 0142-00              |
| 6DG3-3500-FSD    | 1661-27         |                          | 0600-00              |                               | 0664-15            | 0140-01              |
| 6DG3-3500-FSU    | 1661-27         |                          | 0600-00              |                               | 0664-15            | 0140-01              |
| 6DG3-3500-TSE    | 1661-27         |                          | 0600-00              |                               | 0664-15            | 0140-01              |
| 6DG3-3500-TSN    | 1661-27         |                          | 0600-00              |                               | 0664-15            | 0142-01              |
| 6DG3-350E-FSD    | 1661-27         |                          | 0600-00              |                               | 0664-15            | 0140-01              |
| 6DG3-350E-FSU    | 1661-27         |                          | 0600-00              |                               | 0664-15            | 0140-01              |
| 6DG3-350E-TSE    | 1661-27         |                          | 0600-00              |                               | 0664-15            | 0140-01              |
| 6DG3-350E-TSN    | 1661-27         |                          | 0600-00              |                               | 0664-15            | 0142-01              |
| 6DH1-2000-FSD    | 1661-26         |                          | 0600-00              |                               | 0664-03            | 0140-00              |
| 6DH1-2000-TSE    | 1661-26         |                          | 0600-00              |                               | 0664-03            | 0140-00              |
| 6DH1-2000-TSK    | 1661-26         |                          | 0600-00              |                               | 0664-03            | 0142-00              |
| 6DH1-3500-ES8    | 1661-27         |                          | 0600-00              |                               | 0664-03            | 0141-01              |
| 6DH1-3500-FSD    | 1661-27         |                          | 0600-00              |                               | 0664-03            | 0140-01              |
| 6DH1-3500-TSE    | 1661-27         |                          | 0600-00              |                               | 0664-03            | 0140-01              |
| 6DH1-3500-TSK    | 1661-27         |                          | 0600-00              |                               | 0664-03            | 0142-01              |
| 6DH3-200E-FSM    | 1661-26         |                          | 0600-00              |                               | 0664-03            | 0140-00              |
| 6DH3-200E-TSE    | 1661-26         |                          | 0600-00              |                               | 0664-03            | 0140-00              |
| 6DH3-200E-TSK    | 1661-26         |                          | 0600-00              |                               | 0664-03            | 0142-00              |
| 6DH3-3500-FSD    | 1661-27         |                          | 0600-00              |                               | 0664-03            | 0140-01              |
| 6DH3-3500-TSE    | 1661-27         |                          | 0600-00              |                               | 0664-03            | 0140-01              |
| 6DH3-3500-TSK    | 1661-27         |                          | 0600-00              |                               | 0664-03            | 0142-01              |

- 1 Bank Unloading
- 2 Banks Unloading

# Semi-Hermetic Compressors – 6D, 6R and 6T

## 6D Floating Reed Models - Compressor Parts

| Model           | Valve Plate Kit | Unloader Valve Plate Kit | Cylinder Head Gasket | Unloader Cylinder Head Gasket | Valve Plate Gasket | Terminal Plate Group |
|-----------------|-----------------|--------------------------|----------------------|-------------------------------|--------------------|----------------------|
|                 | (998-)          | (998-)                   | (020-)               | (020-)                        | (020-)             | (521-)               |
| 6DH3-350E-FSD   | 1661-27         |                          | 0600-00              |                               | 0664-03            | 0140-01              |
| 6DH3-350E-TSE   | 1661-27         |                          | 0600-00              |                               | 0664-03            | 0140-01              |
| 6DH3-350E-TSK   | 1661-27         |                          | 0600-00              |                               | 0664-03            | 0142-01              |
| 6DJ1-4000-FSD   | 1661-27         |                          | 0600-00              |                               | 0644-05            | 0140-01              |
| 6DJ1-4000-FSU   | 1661-27         |                          | 0600-00              |                               | 0644-05            | 0140-01              |
| 6DJ1-4000-TSE   | 1661-27         |                          | 0600-00              |                               | 0644-05            | 0140-01              |
| 6DJ1-4000-TSN   | 1661-27         |                          | 0600-00              |                               | 0644-05            | 0142-01              |
| 6DJ3-300E-TSE   | 1661-27         |                          | 0600-00              |                               | 0644-05            | 0140-00              |
| 6DJ3-300E-TSK   | 1661-27         |                          | 0600-00              |                               | 0644-05            | 0142-00              |
| 6DJ3-4000-FSD   | 1661-27         |                          | 0600-00              |                               | 0644-05            | 0140-01              |
| 6DJ3-4000-FSU   | 1661-27         |                          | 0600-00              |                               | 0644-05            | 0140-01              |
| 6DJ3-4000-TSE   | 1661-27         |                          | 0600-00              |                               | 0644-05            | 0140-01              |
| 6DJ3-4000-TSN   | 1661-27         |                          | 0600-00              |                               | 0644-05            | 0142-01              |
| 6DJ3-400E-FSD   | 1661-27         |                          | 0600-00              |                               | 0644-05            | 0140-01              |
| 6DJ3-400E-FSU   | 1661-27         |                          | 0600-00              |                               | 0644-05            | 0140-01              |
| 6DJ3-400E-TSE   | 1661-27         |                          | 0600-00              |                               | 0644-05            | 0140-01              |
| 6DJ3-400E-TSN   | 1661-27         |                          | 0600-00              |                               | 0644-05            | 0142-01              |
| • 6DK1-2000-TSK | 1661-27         | 1661-25                  | 0600-00              | 0616-00                       | 0664-03            | 0142-00              |
| • 6DK1-3500-FSD | 1661-27         | 1661-28                  | 0600-00              | 0616-00                       | 0664-03            | 0140-01              |
| • 6DK1-3500-TSE | 1661-27         | 1661-28                  | 0600-00              | 0616-00                       | 0664-03            | 0140-01              |
| • 6DK1-3500-TSK | 1661-27         | 1661-28                  | 0600-00              | 0616-00                       | 0664-03            | 0142-01              |
| • 6DK1-350E-TSK | 1661-27         | 1661-28                  | 0600-00              | 0616-00                       | 0664-03            | 0142-01              |
| • 6DK3-200E-FSM | 1661-26         | 1661-25                  | 0600-00              | 0616-00                       | 0664-03            | 0140-00              |
| • 6DK3-200E-TSE | 1661-26         | 1661-25                  | 0600-00              | 0616-00                       | 0664-03            | 0140-00              |
| • 6DK3-200E-TSK | 1661-26         | 1661-25                  | 0600-00              | 0616-00                       | 0664-03            | 0142-00              |
| • 6DK3-3500-FSD | 1661-27         | 1661-28                  | 0600-00              | 0616-00                       | 0664-03            | 0140-01              |
| • 6DK3-3500-TSE | 1661-27         | 1661-28                  | 0600-00              | 0616-00                       | 0664-03            | 0140-01              |
| • 6DK3-3500-TSK | 1661-27         | 1661-28                  | 0600-00              | 0616-00                       | 0664-03            | 0142-01              |
| • 6DK3-350E-FSD | 1661-27         | 1661-28                  | 0600-00              | 0616-00                       | 0664-03            | 0140-01              |
| • 6DK3-350E-TSE | 1661-27         | 1661-28                  | 0600-00              | 0616-00                       | 0664-03            | 0140-01              |
| • 6DK3-350E-TSK | 1661-27         | 1661-28                  | 0600-00              | 0616-00                       | 0664-03            | 0142-01              |
| 6DL1-2700-FSD   | 1661-26         | 1661-25                  | 0600-00              | 0616-00                       | 0664-03            | 0140-00              |
| 6DL1-2700-TSE   | 1661-26         | 1661-25                  | 0600-00              | 0616-00                       | 0664-03            | 0140-00              |
| 6DL1-2700-TSK   | 1661-26         | 1661-25                  | 0600-00              | 0616-00                       | 0664-03            | 0142-00              |

- 1 Bank Unloading
- 2 Banks Unloading

# 6D, 6R and 6T – Semi-Hermetic Compressors

## 6D Floating Reed Models - Compressor Parts

| Model            | Valve Plate Kit | Unloader Valve Plate Kit | Cylinder Head Gasket | Unloader Cylinder Head Gasket | Valve Plate Gasket | Terminal Plate Group |
|------------------|-----------------|--------------------------|----------------------|-------------------------------|--------------------|----------------------|
|                  | (998-)          | (998-)                   | (020-)               | (020-)                        | (020-)             | (521-)               |
| 6DL3-2700-FSD    | 1661-26         | 1661-25                  | 0600-00              | 0616-00                       | 0664-03            | 0140-00              |
| 6DL3-2700-TSE    | 1661-26         | 1661-25                  | 0600-00              | 0616-00                       | 0664-03            | 0140-00              |
| 6DL3-2700-TSK    | 1661-26         | 1661-25                  | 0600-00              | 0616-00                       | 0664-03            | 0142-00              |
| 6DL3-270E-FSD    | 1661-26         | 1661-25                  | 0600-00              | 0616-00                       | 0664-03            | 0140-00              |
| 6DL3-270E-TSE    | 1661-26         | 1661-25                  | 0600-00              | 0616-00                       | 0664-03            | 0140-00              |
| 6DL3-270E-TSK    | 1661-26         | 1661-25                  | 0600-00              | 0616-00                       | 0664-03            | 0142-00              |
| • 6DM3-3500-FSD  | 1661-27         | 1661-28                  | 0600-00              | 0616-00                       | 0664-15            | 0140-01              |
| • 6DM3-3500-FSU  | 1661-27         | 1661-28                  | 0600-00              | 0616-00                       | 0664-15            | 0140-01              |
| • 6DM3-3500-TSE  | 1661-27         | 1661-28                  | 0600-00              | 0616-00                       | 0664-15            | 0140-01              |
| • 6DM3-3500-TSN  | 1661-27         | 1661-28                  | 0600-00              | 0616-00                       | 0664-15            | 0142-01              |
| • 6DM3-350E-FSD  | 1661-27         | 1661-28                  | 0600-00              | 0616-00                       | 0664-15            | 0140-01              |
| • 6DM3-350E-FSU  | 1661-27         | 1661-28                  | 0600-00              | 0616-00                       | 0664-15            | 0140-01              |
| • 6DM3-350E-TSE  | 1661-27         | 1661-28                  | 0600-00              | 0616-00                       | 0664-15            | 0140-01              |
| • 6DM3-350E-TSN  | 1661-27         | 1661-28                  | 0600-00              | 0616-00                       | 0664-15            | 0142-01              |
| •• 6DN3-3500-ES8 | 1661-27         | 1661-28                  | 0600-00              | 0616-00                       | 0664-15            | 0141-01              |
| •• 6DN3-3500-FSD | 1661-27         | 1661-28                  | 0600-00              | 0616-00                       | 0664-15            | 0140-01              |
| •• 6DN3-3500-FSU | 1661-27         | 1661-28                  | 0600-00              | 0616-00                       | 0664-15            | 0140-01              |
| •• 6DN3-3500-TSE | 1661-27         | 1661-28                  | 0600-00              | 0616-00                       | 0664-15            | 0140-01              |
| •• 6DN3-3500-TSN | 1661-27         | 1661-28                  | 0600-00              | 0616-00                       | 0664-15            | 0142-01              |
| •• 6DN3-350E-FSD | 1661-27         | 1661-28                  | 0600-00              | 0616-00                       | 0664-15            | 0140-01              |
| •• 6DN3-350E-FSU | 1661-27         | 1661-28                  | 0600-00              | 0616-00                       | 0664-15            | 0140-01              |
| •• 6DN3-350E-TSE | 1661-27         | 1661-28                  | 0600-00              | 0616-00                       | 0664-15            | 0140-01              |
| •• 6DN3-350E-TSN | 1661-27         | 1661-28                  | 0600-00              | 0616-00                       | 0664-15            | 0142-01              |
| •• 6DP1-2000-TSK | 1661-27         | 1661-28                  | 0600-00              | 0616-00                       | 0664-03            | 0142-00              |
| •• 6DP1-3500-FSD | 1661-27         | 1661-28                  | 0600-00              | 0616-00                       | 0664-03            | 0140-01              |
| •• 6DP1-3500-TSE | 1661-27         | 1661-28                  | 0600-00              | 0616-00                       | 0664-03            | 0140-01              |
| •• 6DP1-3500-TSK | 1661-27         | 1661-28                  | 0600-00              | 0616-00                       | 0664-03            | 0141-01              |
| •• 6DP1-350E-TSK | 1661-27         | 1661-28                  | 0600-00              | 0616-00                       | 0664-03            | 0141-01              |
| •• 6DP3-200E-FSM | 1661-26         | 1661-28                  | 0600-00              | 0616-00                       | 0664-03            | 0140-00              |
| •• 6DP3-200E-TSE | 1661-27         | 1661-28                  | 0600-00              | 0616-00                       | 0664-03            | 0140-00              |
| •• 6DP3-200E-TSK | 1661-27         | 1661-28                  | 0600-00              | 0616-00                       | 0664-03            | 0142-00              |
| •• 6DP3-3500-FSD | 1661-27         | 1661-28                  | 0600-00              | 0616-00                       | 0664-03            | 0140-01              |
| •• 6DP3-3500-TSE | 1661-27         | 1661-28                  | 0600-00              | 0616-00                       | 0664-03            | 0140-01              |
| •• 6DP3-3500-TSK | 1661-27         | 1661-28                  | 0600-00              | 0616-00                       | 0664-03            | 0142-01              |

• 1 Bank Unloading  
•• 2 Banks Unloading

# Semi-Hermetic Compressors – 6D, 6R and 6T

## 6D Floating Reed Models - Compressor Parts

| Model            | Valve Plate Kit | Unloader Valve Plate Kit | Cylinder Head Gasket | Unloader Cylinder Head Gasket | Valve Plate Gasket | Terminal Plate Group |
|------------------|-----------------|--------------------------|----------------------|-------------------------------|--------------------|----------------------|
|                  | (998-)          | (998-)                   | (020-)               | (020-)                        | (020-)             | (521-)               |
| •• 6DP3-350E-FSD | 1661-27         | 1661-28                  | 0600-00              | 0616-00                       | 0664-03            | 0140-01              |
| •• 6DP3-350E-TSE | 1661-27         | 1661-28                  | 0600-00              | 0616-00                       | 0664-03            | 0140-01              |
| •• 6DP3-350E-TSK | 1661-27         | 1661-28                  | 0600-00              | 0616-00                       | 0664-03            | 0142-01              |
| • 6DR1-4000-FSD  | 1661-27         | 1661-28                  | 0600-00              | 0616-00                       | 0664-05            | 0140-01              |
| • 6DR1-4000-FSU  | 1661-27         | 1661-28                  | 0600-00              | 0616-00                       | 0664-05            | 0140-01              |
| • 6DR1-4000-TSE  | 1661-27         | 1661-28                  | 0600-00              | 0616-00                       | 0664-05            | 0140-01              |
| • 6DR1-4000-TSN  | 1661-27         | 1661-28                  | 0600-00              | 0616-00                       | 0664-05            | 0142-01              |
| • 6DR3-300E-TSE  | 1661-27         | 1661-28                  | 0600-00              | 0616-00                       | 0664-05            | 0140-01              |
| • 6DR3-300E-TSK  | 1661-27         | 1661-28                  | 0600-00              | 0616-00                       | 0664-05            | 0142-01              |
| • 6DR3-4000-FSD  | 1661-27         | 1661-28                  | 0600-00              | 0616-00                       | 0664-05            | 0140-01              |
| • 6DR3-4000-FSU  | 1661-27         | 1661-28                  | 0600-00              | 0616-00                       | 0664-05            | 0140-01              |
| • 6DR3-4000-TSE  | 1661-27         | 1661-28                  | 0600-00              | 0616-00                       | 0664-05            | 0140-01              |
| • 6DR3-4000-TSN  | 1661-27         | 1661-28                  | 0600-00              | 0616-00                       | 0664-05            | 0142-01              |
| • 6DR3-400E-FSD  | 1661-27         | 1661-28                  | 0600-00              | 0616-00                       | 0664-05            | 0140-01              |
| • 6DR3-400E-FSU  | 1661-27         | 1661-28                  | 0600-00              | 0616-00                       | 0664-05            | 0140-01              |
| • 6DR3-400E-TSE  | 1661-27         | 1661-28                  | 0600-00              | 0616-00                       | 0664-05            | 0140-01              |
| • 6DR3-400E-TSN  | 1661-27         | 1661-28                  | 0600-00              | 0616-00                       | 0664-05            | 0142-01              |
| •• 6DS1-4000-ES8 | 1661-27         | 1661-28                  | 0600-00              | 0616-00                       | 0664-05            | 0141-01              |
| •• 6DS1-4000-FSD | 1661-27         | 1661-28                  | 0600-00              | 0616-00                       | 0664-05            | 0140-01              |
| •• 6DS1-4000-FSU | 1661-27         | 1661-28                  | 0600-00              | 0616-00                       | 0664-05            | 0140-01              |
| •• 6DS1-4000-TSE | 1661-27         | 1661-28                  | 0600-00              | 0616-00                       | 0664-05            | 0140-01              |
| •• 6DS1-4000-TSN | 1661-27         | 1661-28                  | 0600-00              | 0616-00                       | 0664-05            | 0142-01              |
| •• 6DS3-300E-TSE | 1661-27         | 1661-28                  | 0600-00              | 0616-00                       | 0664-05            | 0140-00              |
| •• 6DS3-300E-TSK | 1661-27         | 1661-28                  | 0600-00              | 0616-00                       | 0664-05            | 0142-00              |
| •• 6DS3-4000-FSD | 1661-27         | 1661-28                  | 0600-00              | 0616-00                       | 0664-05            | 0140-01              |
| •• 6DS3-4000-FSU | 1661-27         | 1661-28                  | 0600-00              | 0616-00                       | 0664-05            | 0140-01              |
| •• 6DS3-4000-TSE | 1661-27         | 1661-28                  | 0600-00              | 0616-00                       | 0664-05            | 0140-01              |
| •• 6DS3-4000-TSN | 1661-27         | 1661-28                  | 0600-00              | 0616-00                       | 0664-05            | 0142-01              |
| •• 6DS3-400E-FSD | 1661-27         | 1661-28                  | 0600-00              | 0616-00                       | 0664-05            | 0140-01              |
| •• 6DS3-400E-FSU | 1661-27         | 1661-28                  | 0600-00              | 0616-00                       | 0664-05            | 0140-01              |
| •• 6DS3-400E-TSE | 1661-27         | 1661-28                  | 0600-00              | 0616-00                       | 0664-05            | 0140-01              |
| •• 6DS3-400E-TSN | 1661-27         | 1661-28                  | 0600-00              | 0616-00                       | 0664-05            | 0140-01              |
| 6DT1-3000-ES8    | 1661-26         |                          | 0600-00              |                               | 0664-05            | 0141-00              |
| 6DT1-3000-FSD    | 1661-26         |                          | 0600-00              |                               | 0664-05            | 0140-00              |

- 1 Bank Unloading
- 2 Banks Unloading



# 6D, 6R and 6T – Semi-Hermetic Compressors

## 6D Floating Reed Models - Compressor Parts

| Model            | Valve Plate Kit | Unloader Valve Plate Kit | Cylinder Head Gasket | Unloader Cylinder Head Gasket | Valve Plate Gasket | Terminal Plate Group |
|------------------|-----------------|--------------------------|----------------------|-------------------------------|--------------------|----------------------|
|                  | (998-)          | (998-)                   | (020-)               | (020-)                        | (020-)             | (521-)               |
| 6DT1-3000-TSE    | 1661-26         |                          | 0600-00              |                               | 0664-05            | 0140-00              |
| 6DT1-3000-TSK    | 1661-26         |                          | 0600-00              |                               | 0664-05            | 0142-00              |
| 6DT3-3000-FSD    | 1661-26         |                          | 0600-00              |                               | 0664-05            | 0140-00              |
| 6DT3-3000-TSE    | 1661-26         |                          | 0600-00              |                               | 0664-05            | 0140-00              |
| 6DT3-3000-TSK    | 1661-26         |                          | 0600-00              |                               | 0664-05            | 0142-00              |
| 6DT3-300E-FSD    | 1661-26         |                          | 0600-00              |                               | 0664-05            | 0140-00              |
| 6DT3-300E-TSE    | 1661-26         |                          | 0600-00              |                               | 0664-05            | 0140-00              |
| 6DT3-300E-TSK    | 1661-26         |                          | 0600-00              |                               | 0664-05            | 0142-00              |
| • 6DW3-3000-FSD  | 1661-27         | 1661-28                  | 0600-00              | 0616-00                       | 0664-03            | 0140-01              |
| • 6DW3-3000-TSE  | 1661-27         | 1661-28                  | 0600-00              | 0616-00                       | 0664-03            | 0140-01              |
| • 6DW3-3000-TSK  | 1661-27         | 1661-28                  | 0600-00              | 0616-00                       | 0664-03            | 0142-01              |
| • 6DW3-300E-FSD  | 1661-27         | 1661-28                  | 0600-00              | 0616-00                       | 0664-03            | 0140-01              |
| • 6DW3-300E-TSE  | 1661-27         | 1661-28                  | 0600-00              | 0616-00                       | 0664-03            | 0140-01              |
| • 6DW3-300E-TSK  | 1661-27         | 1661-28                  | 0600-00              | 0616-00                       | 0664-03            | 0142-01              |
| •• 6DY3-3000-FSD | 1661-27         | 1661-28                  | 0600-00              | 0616-00                       | 0664-03            | 0140-01              |
| •• 6DY3-3000-TSE | 1661-27         | 1661-28                  | 0600-00              | 0616-00                       | 0664-03            | 0140-01              |
| •• 6DY3-3000-TSK | 1661-27         | 1661-28                  | 0600-00              | 0616-00                       | 0664-03            | 0142-01              |
| •• 6DY3-300E-FSD | 1661-27         | 1661-28                  | 0600-00              | 0616-00                       | 0664-03            | 0140-01              |
| •• 6DY3-300E-TSE | 1661-27         | 1661-28                  | 0600-00              | 0616-00                       | 0664-03            | 0140-01              |
| •• 6DY3-300E-TSK | 1661-27         | 1661-28                  | 0600-00              | 0616-00                       | 0664-03            | 0142-01              |

• 1 Bank Unloading  
 •• 2 Banks Unloading

# Semi-Hermetic Compressors – 6D, 6R and 6T

## 6D Delta Reed Models - Compressor Parts

| Model<br>(Horse Power<br>Nomenclature) | New Model<br>(BTU<br>Nomenclature) | Delta<br>Valve<br>Plate Kit | Unloader<br>Valve<br>Plate Kit | Cylinder<br>Head<br>Gasket | Unloader<br>Cylinder<br>Head<br>Gasket | Valve<br>Plate<br>Gasket | Terminal<br>Plate<br>Group |
|--|------------------------------------|-----------------------------|--------------------------------|----------------------------|--|--------------------------|----------------------------|
|  |                                    | (998-)                      | (998-)                         | (020-)                     | (020-)                                 | (020-)                   | (521-)                     |
| 6DB3A3000-FSD                          | 6DB3R32M0-FSD                      | 2661-27                     |                                | 0600-00                    |  | 1235-01                  | 0140-01                    |
| 6DB3A3000-TSE                          | 6DB3R32M0-TSE                      | 2661-27                     |                                | 0600-00                    |  | 1235-01                  | 0140-01                    |
| 6DB3A3000-TSK                          | 6DB3R32M0-TSK                      | 2661-27                     |                                | 0600-00                    |  | 1235-01                  | 0142-01                    |
| 6DB3A300E-FSD                          | 6DB3R32ME-FSD                      | 2661-27                     |                                | 0600-00                    |  | 1235-01                  | 0140-01                    |
| 6DB3A300E-TSE                          | 6DB3R32ME-TSE                      | 2661-27                     |                                | 0600-00                    |  | 1235-01                  | 0140-01                    |
| 6DB3A300E-TSK                          | 6DB3R32ME-TSK                      | 2661-27                     |                                | 0600-00                    |  | 1235-01                  | 0142-01                    |
| • 6DC1A2700-TSE                        | N/A                                | 2661-26                     | 2661-25                        | 0600-00                    | 0616-00                                | 1235-01                  | 0140-00                    |
| • 6DC1A2700-TSK                        | N/A                                | 2661-26                     | 2661-25                        | 0600-00                    | 0616-00                                | 1235-01                  | 0142-00                    |
| • 6DC3A2700-ES8                        | N/A                                | 2661-26                     | 2661-25                        | 0600-00                    | 0616-00                                | 1235-01                  | 0141-00                    |
| • 6DC3A2700-FSD                        | 6DC3F93K0-FSD                      | 2661-26                     | 2661-25                        | 0600-00                    | 0616-00                                | 1235-01                  | 0140-00                    |
| • 6DC3A2700-TSE                        | 6DC3F93K0-TSE                      | 2661-26                     | 2661-25                        | 0600-00                    | 0616-00                                | 1235-01                  | 0140-00                    |
| • 6DC3A2700-TSK                        | 6DC3F93K0-TSK                      | 2661-26                     | 2661-25                        | 0600-00                    | 0616-00                                | 1235-01                  | 0142-00                    |
| • 6DC3A270E-FSD                        | 6DC3F93KE-FSD                      | 2661-26                     | 2661-25                        | 0600-00                    | 0616-00                                | 1235-01                  | 0140-00                    |
| • 6DC3A270E-TSE                        | 6DC3F93KE-TSE                      | 2661-26                     | 2661-25                        | 0600-00                    | 0616-00                                | 1235-01                  | 0140-00                    |
| • 6DC3A270E-TSK                        | 6DC3F93KE-TSK                      | 2661-26                     | 2661-25                        | 0600-00                    | 0616-00                                | 1235-01                  | 0142-00                    |
| •• 6DD1A2700-FSD                       | N/A                                | 2661-26                     | 2661-25                        | 0600-00                    | 0616-00                                | 1235-01                  | 0140-00                    |
| •• 6DD1A2700-TSK                       | N/A                                | 2661-26                     | 2661-25                        | 0600-00                    | 0616-00                                | 1235-01                  | 0142-00                    |
| •• 6DD3A2700-ES8                       | N/A                                | 2661-26                     | 2661-25                        | 0600-00                    | 0616-00                                | 1235-01                  | 0141-00                    |
| •• 6DD3A2700-FSD                       | 6DD3F93K0-FSD                      | 2661-26                     | 2661-25                        | 0600-00                    | 0616-00                                | 1235-01                  | 0140-00                    |
| •• 6DD3A2700-TSE                       | 6DD3F93K0-TSE                      | 2661-26                     | 2661-25                        | 0600-00                    | 0616-00                                | 1235-01                  | 0140-00                    |
| •• 6DD3A2700-TSK                       | 6DD3F93K0-TSK                      | 2661-26                     | 2661-25                        | 0600-00                    | 0616-00                                | 1235-01                  | 0142-00                    |
| •• 6DD3A270E-FSD                       | 6DD3F93KE-FSD                      | 2661-26                     | 2661-25                        | 0600-00                    | 0616-00                                | 1235-01                  | 0140-00                    |
| •• 6DD3A270E-TSE                       | 6DD3F93KE-TSE                      | 2661-26                     | 2661-25                        | 0600-00                    | 0616-00                                | 1235-01                  | 0140-00                    |
| •• 6DD3A270E-TSK                       | 6DD3F93KE-TSK                      | 2661-26                     | 2661-25                        | 0600-00                    | 0616-00                                | 1235-01                  | 0142-00                    |
| • 6DE1A3000-ES8                        | N/A                                | 2661-26                     | 2661-25                        | 0600-00                    | 0616-00                                | 1235-03                  | 0141-00                    |
| • 6DE1A3000-TSK                        | N/A                                | 2661-26                     | 2661-25                        | 0600-00                    | 0616-00                                | 1235-03                  | 0142-00                    |
| • 6DE3A3000-FSD                        | 6DE3F11M0-FSD                      | 2661-26                     | 2661-25                        | 0600-00                    | 0616-00                                | 1235-03                  | 0140-00                    |
| • 6DE3A3000-TSE                        | 6DE3F11M0-TSE                      | 2661-26                     | 2661-25                        | 0600-00                    | 0616-00                                | 1235-03                  | 0140-00                    |
| • 6DE3A3000-TSK                        | 6DE3F11M0-TSK                      | 2661-26                     | 2661-25                        | 0600-00                    | 0616-00                                | 1235-03                  | 0142-00                    |
| • 6DE3A300E-FSD                        | 6DE3F11ME-FSD                      | 2661-26                     | 2661-25                        | 0600-00                    | 0616-00                                | 1235-03                  | 0140-00                    |
| • 6DE3A300E-TSE                        | 6DE3F11ME-TSE                      | 2661-26                     | 2661-25                        | 0600-00                    | 0616-00                                | 1235-03                  | 0140-00                    |
| • 6DE3A300E-TSK                        | 6DE3F11ME-TSK                      | 2661-26                     | 2661-25                        | 0600-00                    | 0616-00                                | 1235-03                  | 0142-00                    |
| •• 6DF1A3000-ES8                       | N/A                                | 2661-26                     | 2661-25                        | 0600-00                    | 0616-00                                | 1235-03                  | 0141-00                    |
| •• 6DF1A3000-FSD                       | N/A                                | 2661-26                     | 2661-25                        | 0600-00                    | 0616-00                                | 1235-03                  | 0140-00                    |
| •• 6DF1A3000-TSK                       | N/A                                | 2661-26                     | 2661-25                        | 0600-00                    | 0616-00                                | 1235-03                  | 0142-00                    |
| •• 6DF3A3000-FSD                       | 6DF3F11M0-FSD                      | 2661-26                     | 2661-25                        | 0600-00                    | 0616-00                                | 1235-03                  | 0140-00                    |

New Model Nomenclature (5th Digit = Application Rating)

R = Rating at +45°F to +130°F at 90°F Ambient Air

S = Rating at +20°F to +120°F at 90°F Ambient Air

F = Rating at -25°F to +105°F at 90° Ambient Air

- 1 Bank Unloading
- 2 Banks Unloading

# 6D, 6R and 6T – Semi-Hermetic Compressors

## 6D Delta Reed Models - Compressor Parts

| Model<br>(Horse Power<br>Nomenclature) | New Model<br>(BTU<br>Nomenclature) | Delta<br>Valve<br>Plate Kit | Unloader<br>Valve<br>Plate Kit | Cylinder<br>Head<br>Gasket | Unloader<br>Cylinder<br>Head<br>Gasket | Valve<br>Plate<br>Gasket | Terminal<br>Plate<br>Group |
|--|------------------------------------|-----------------------------|--------------------------------|----------------------------|--|--------------------------|----------------------------|
|  |                                    | (998-)                      | (998-)                         | (020-)                     | (020-)                                 | (020-)                   | (521-)                     |
| •• 6DF3A3000-TSE                       | 6DF3F11M0-TSE                      | 2661-26                     | 2661-25                        | 0600-00                    | 0616-00                                | 1235-03                  | 0140-00                    |
| •• 6DF3A3000-TSK                       | 6DF3F11M0-TSK                      | 2661-26                     | 2661-25                        | 0600-00                    | 0616-00                                | 1235-03                  | 0142-00                    |
| •• 6DF3A300E-FSD                       | 6DF3F11ME-FSD                      | 2661-26                     | 2661-25                        | 0600-00                    | 0616-00                                | 1235-03                  | 0140-00                    |
| •• 6DF3A300E-TSE                       | 6DF3F11ME-TSE                      | 2661-26                     | 2661-25                        | 0600-00                    | 0616-00                                | 1235-03                  | 0140-00                    |
| •• 6DF3A300E-TSK                       | 6DF3F11ME-TSK                      | 2661-26                     | 2661-25                        | 0600-00                    | 0616-00                                | 1235-03                  | 0142-00                    |
| 6DG3A3500-FSD                          | 6DG3R37M0-FSD                      | 2661-27                     |                                | 0600-00                    |  | 1235-07                  | 0140-01                    |
| 6DG3A3500-FSU                          | 6DG3R37M0-FSU                      | 2661-27                     |                                | 0600-00                    |  | 1235-07                  | 0140-01                    |
| 6DG3A3500-TSE                          | 6DG3R37M0-TSE                      | 2661-27                     |                                | 0600-00                    |  | 1235-07                  | 0140-01                    |
| 6DG3A3500-TSN                          | 6DG3R37M0-TSN                      | 2661-27                     |                                | 0600-00                    |  | 1235-07                  | 0142-01                    |
| 6DG3A350E-FSD                          | 6DG3R37ME-FSD                      | 2661-27                     |                                | 0600-00                    |  | 1235-07                  | 0140-01                    |
| 6DG3A350E-FSU                          | 6DG3R37ME-FSU                      | 2661-27                     |                                | 0600-00                    |  | 1235-07                  | 0140-01                    |
| 6DG3A350E-TSE                          | 6DG3R37ME-TSE                      | 2661-27                     |                                | 0600-00                    |  | 1235-07                  | 0140-01                    |
| 6DG3A350E-TSN                          | 6DG3R37ME-TSN                      | 2661-27                     |                                | 0600-00                    |  | 1235-07                  | 0142-01                    |
| 6DH1A2000-FSD                          | N/A                                | 2661-26                     |                                | 0600-00                    |  | 1235-01                  | 0140-00                    |
| 6DH1A2000-TSE                          | N/A                                | 2661-26                     |                                | 0600-00                    |  | 1235-01                  | 0140-00                    |
| 6DH1A2000-TSK                          | N/A                                | 2661-26                     |                                | 0600-00                    |  | 1235-01                  | 0142-00                    |
| 6DH1A3500-FSD                          | 6DH1R35M0-FSD                      | 2661-27                     |                                | 0600-00                    |  | 1235-01                  | 0140-01                    |
| 6DH1A3500-TSE                          | 6DH1R35M0-TSE                      | 2661-27                     |                                | 0600-00                    |  | 1235-01                  | 0140-01                    |
| 6DH1A3500-TSK                          | 6DH1R35M0-TSK                      | 2661-27                     |                                | 0600-00                    |  | 1235-01                  | 0142-01                    |
| 6DH3A200E-FSM                          | 6DH3R23ME-FSM                      | 2661-26                     |                                | 0600-00                    |  | 1235-01                  | 0140-00                    |
| 6DH3A200E-TSE                          | 6DH3R23ME-TSE                      | 2661-26                     |                                | 0600-00                    |  | 1235-01                  | 0140-00                    |
| 6DH3A200E-TSK                          | 6DH3R23ME-TSK                      | 2661-26                     |                                | 0600-00                    |  | 1235-01                  | 0142-00                    |
| 6DH3A3500-FSD                          | 6DH3R35M0-FSD                      | 2661-27                     |                                | 0600-00                    |  | 1235-01                  | 0140-01                    |
| 6DH3A3500-TSE                          | 6DH3R35M0-TSE                      | 2661-27                     |                                | 0600-00                    |  | 1235-01                  | 0140-01                    |
| 6DH3A3500-TSK                          | 6DH3R35M0-TSK                      | 2661-27                     |                                | 0600-00                    |  | 1235-01                  | 0142-01                    |
| 6DH3A350E-FSD                          | 6DH3R35ME-FSD                      | 2661-27                     |                                | 0600-00                    |  | 1235-01                  | 0140-01                    |
| 6DH3A350E-TSE                          | 6DH3R35ME-TSE                      | 2661-27                     |                                | 0600-00                    |  | 1235-01                  | 0140-01                    |
| 6DH3A350E-TSK                          | 6DH3R35ME-TSK                      | 2661-27                     |                                | 0600-00                    |  | 1235-01                  | 0142-01                    |
| 6DJ1A4000-FSD                          | 6DJ1R40M0-FSD                      | 2661-27                     |                                | 0600-00                    |  | 1235-03                  | 0140-01                    |
| 6DJ1A4000-FSU                          | 6DJ1R40M0-FSU                      | 2661-27                     |                                | 0600-00                    |  | 1235-03                  | 0140-01                    |
| 6DJ1A4000-TSE                          | 6DJ1R40M0-TSE                      | 2661-27                     |                                | 0600-00                    |  | 1235-03                  | 0140-01                    |
| 6DJ1A4000-TSN                          | 6DJ1R40M0-TSN                      | 2661-27                     |                                | 0600-00                    |  | 1235-03                  | 0142-01                    |
| 6DJ3A300E-TSE                          | 6DJ3R28ME-TSE                      | 2661-27                     |                                | 0600-00                    |  | 1235-03                  | 0140-00                    |
| 6DJ3A300E-TSK                          | 6DJ3R28ME-TSK                      | 2661-27                     |                                | 0600-00                    |  | 1235-03                  | 0142-00                    |
| 6DJ3A4000-FSD                          | 6DJ3R40M0-FSD                      | 2661-27                     |                                | 0600-00                    |  | 1235-03                  | 0140-01                    |
| 6DJ3A4000-FSU                          | 6DJ3R40M0-FSU                      | 2661-27                     |                                | 0600-00                    |  | 1235-03                  | 0140-01                    |

New Model Nomenclature (5th Digit = Application Rating)

R = Rating at +45°F to +130°F at 90°F Ambient Air

S = Rating at +20°F to +120°F at 90°F Ambient Air

F = Rating at -25°F to +105°F at 90° Ambient Air

- 1 Bank Unloading
- 2 Banks Unloading

# Semi-Hermetic Compressors – 6D, 6R and 6T

## 6D Delta Reed Models - Compressor Parts

| Model<br>(Horse Power<br>Nomenclature) | New Model<br>(BTU<br>Nomenclature) | Delta<br>Valve<br>Plate Kit | Unloader<br>Valve<br>Plate Kit | Cylinder<br>Head<br>Gasket | Unloader<br>Cylinder<br>Head<br>Gasket | Valve<br>Plate<br>Gasket | Terminal<br>Plate<br>Group |
|--|------------------------------------|-----------------------------|--------------------------------|----------------------------|--|--------------------------|----------------------------|
|  |                                    | (998-)                      | (998-)                         | (020-)                     | (020-)                                 | (020-)                   | (521-)                     |
| 6DJ3A4000-TSE                          | 6DJ3R40M0-TSE                      | 2661-27                     |                                | 0600-00                    |  | 1235-03                  | 0140-01                    |
| 6DJ3A4000-TSN                          | 6DJ3R40M0-TSN                      | 2661-27                     |                                | 0600-00                    |  | 1235-03                  | 0142-01                    |
| 6DJ3A400E-FSD                          | 6DJ3R40ME-FSD                      | 2661-27                     |                                | 0600-00                    |  | 1235-03                  | 0140-01                    |
| 6DJ3A400E-FSU                          | 6DJ3R40ME-FSU                      | 2661-27                     |                                | 0600-00                    |  | 1235-03                  | 0140-01                    |
| 6DJ3A400E-TSE                          | 6DJ3R40ME-TSE                      | 2661-27                     |                                | 0600-00                    |  | 1235-03                  | 0140-01                    |
| 6DJ3A400E-TSN                          | 6DJ3R40ME-TSN                      | 2661-27                     |                                | 0600-00                    |  | 1235-03                  | 0142-01                    |
| • 6DK1A2000-TSK                        | N/A                                | 2661-27                     | 2661-25                        | 0600-00                    | 0616-00                                | 1235-01                  | 0142-00                    |
| • 6DK1A3500-ES8                        | 6DK1R35M0-ES8                      | 2661-27                     | 2661-28                        | 0600-00                    | 0616-00                                | 1235-01                  | 0141-01                    |
| • 6DK1A3500-FSD                        | 6DK1R35M0-FSD                      | 2661-27                     | 2661-28                        | 0600-00                    | 0616-00                                | 1235-01                  | 0140-01                    |
| • 6DK1A3500-TSE                        | 6DK1R35M0-TSE                      | 2661-27                     | 2661-28                        | 0600-00                    | 0616-00                                | 1235-01                  | 0140-01                    |
| • 6DK1A3500-TSK                        | 6DK1R35M0-TSK                      | 2661-27                     | 2661-28                        | 0600-00                    | 0616-00                                | 1235-01                  | 0142-01                    |
| • 6DK1A350E-TSK                        | 6DK1R35ME-TSK                      | 2661-27                     | 2661-28                        | 0600-00                    | 0616-00                                | 1235-01                  | 0142-01                    |
| • 6DK3A200E-FSM                        | 6DK3R23ME-FSM                      | 2661-26                     | 2661-25                        | 0600-00                    | 0616-00                                | 1235-01                  | 0140-00                    |
| • 6DK3A200E-TSE                        | 6DK3R23ME-TSE                      | 2661-26                     | 2661-25                        | 0600-00                    | 0616-00                                | 1235-01                  | 0140-00                    |
| • 6DK3A200E-TSK                        | 6DK3R23ME-TSK                      | 2661-26                     | 2661-25                        | 0600-00                    | 0616-00                                | 1235-01                  | 0142-00                    |
| • 6DK3A3500-FSD                        | 6DK3R35M0-FSD                      | 2661-27                     | 2661-28                        | 0600-00                    | 0616-00                                | 1235-01                  | 0140-01                    |
| • 6DK3A3500-TSE                        | 6DK3R35M0-TSE                      | 2661-27                     | 2661-28                        | 0600-00                    | 0616-00                                | 1235-01                  | 0140-01                    |
| • 6DK3A3500-TSK                        | 6DK3R35M0-TSK                      | 2661-27                     | 2661-28                        | 0600-00                    | 0616-00                                | 1235-01                  | 0142-01                    |
| • 6DK3A350E-FSD                        | 6DK3R35ME-FSD                      | 2661-27                     | 2661-28                        | 0600-00                    | 0616-00                                | 1235-01                  | 0140-01                    |
| • 6DK3A350E-TSE                        | 6DK3R35ME-TSE                      | 2661-27                     | 2661-28                        | 0600-00                    | 0616-00                                | 1235-01                  | 0140-01                    |
| • 6DK3A350E-TSK                        | 6DK3R35ME-TSK                      | 2661-27                     | 2661-28                        | 0600-00                    | 0616-00                                | 1235-01                  | 0142-01                    |
| 6DL1A2700-FSD                          | N/A                                | 2661-26                     | 2661-25                        | 0600-00                    | 0616-00                                | 1235-01                  | 0140-00                    |
| 6DL1A2700-TSE                          | N/A                                | 2661-26                     | 2661-25                        | 0600-00                    | 0616-00                                | 1235-01                  | 0140-00                    |
| 6DL1A2700-TSK                          | N/A                                | 2661-26                     | 2661-25                        | 0600-00                    | 0616-00                                | 1235-01                  | 0142-00                    |
| 6DL3A2700-ES8                          | N/A                                | 2661-26                     | 2661-25                        | 0600-00                    | 0616-00                                | 1235-01                  | 0141-00                    |
| 6DL3A2700-FSD                          | 6DL3F93K0-FSD                      | 2661-26                     | 2661-25                        | 0600-00                    | 0616-00                                | 1235-01                  | 0140-00                    |
| 6DL3A2700-TSE                          | 6DL3F93K0-TSE                      | 2661-26                     | 2661-25                        | 0600-00                    | 0616-00                                | 1235-01                  | 0140-00                    |
| 6DL3A2700-TSK                          | 6DL3F93K0-TSK                      | 2661-26                     | 2661-25                        | 0600-00                    | 0616-00                                | 1235-01                  | 0142-00                    |
| 6DL3A270E-FSD                          | 6DL3F93KE-FSD                      | 2661-26                     | 2661-25                        | 0600-00                    | 0616-00                                | 1235-01                  | 0140-00                    |
| 6DL3A270E-TSE                          | 6DL3F93KE-TSE                      | 2661-26                     | 2661-25                        | 0600-00                    | 0616-00                                | 1235-01                  | 0140-00                    |
| 6DL3A270E-TSK                          | 6DL3F93KE-TSK                      | 2661-26                     | 2661-25                        | 0600-00                    | 0616-00                                | 1235-01                  | 0142-00                    |
| • 6DM3A3500-FSD                        | 6DM3R37M0-FSD                      | 2661-27                     | 2661-28                        | 0600-00                    | 0616-00                                | 1235-07                  | 0140-01                    |
| • 6DM3A3500-FSU                        | 6DM3R37M0-FSU                      | 2661-27                     | 2661-28                        | 0600-00                    | 0616-00                                | 1235-07                  | 0140-01                    |
| • 6DM3A3500-TSE                        | 6DM3R37M0-TSE                      | 2661-27                     | 2661-28                        | 0600-00                    | 0616-00                                | 1235-07                  | 0140-01                    |
| • 6DM3A3500-TSN                        | 6DM3R37M0-TSN                      | 2661-27                     | 2661-28                        | 0600-00                    | 0616-00                                | 1235-07                  | 0142-01                    |
| • 6DM3A350E-FSD                        | 6DM3R37ME-FSD                      | 2661-27                     | 2661-28                        | 0600-00                    | 0616-00                                | 1235-07                  | 0140-01                    |

New Model Nomenclature (5th Digit = Application Rating)

R = Rating at +45°F to +130°F at 90°F Ambient Air

S = Rating at +20°F to +120°F at 90°F Ambient Air

F = Rating at -25°F to +105°F at 90° Ambient Air

- 1 Bank Unloading
- 2 Banks Unloading

# 6D, 6R and 6T – Semi-Hermetic Compressors

## 6D Delta Reed Models - Compressor Parts

| Model<br>(Horse Power<br>Nomenclature) | New Model<br>(BTU<br>Nomenclature) | Delta<br>Valve<br>Plate Kit | Unloader<br>Valve<br>Plate Kit | Cylinder<br>Head<br>Gasket | Unloader<br>Cylinder<br>Head<br>Gasket | Valve<br>Plate<br>Gasket | Terminal<br>Plate<br>Group |
|--|------------------------------------|-----------------------------|--------------------------------|----------------------------|--|--------------------------|----------------------------|
|  |                                    | (998-)                      | (998-)                         | (020-)                     | (020-)                                 | (020-)                   | (521-)                     |
| • 6DM3A350E-FSU                        | 6DM3R37ME-FSU                      | 2661-27                     | 2661-28                        | 0600-00                    | 0616-00                                | 1235-07                  | 0140-01                    |
| • 6DM3A350E-TSE                        | 6DM3R37ME-TSE                      | 2661-27                     | 2661-28                        | 0600-00                    | 0616-00                                | 1235-07                  | 0140-01                    |
| • 6DM3A350E-TSN                        | 6DM3R37ME-TSN                      | 2661-27                     | 2661-28                        | 0600-00                    | 0616-00                                | 1235-07                  | 0142-01                    |
| •• 6DN3A3500-FSD                       | 6DN3R37M0-FSD                      | 2661-27                     | 2661-28                        | 0600-00                    | 0616-00                                | 1235-07                  | 0140-01                    |
| •• 6DN3A3500-FSU                       | 6DN3R37M0-FSU                      | 2661-27                     | 2661-28                        | 0600-00                    | 0616-00                                | 1235-07                  | 0140-01                    |
| •• 6DN3A3500-TSE                       | 6DN3R37M0-TSE                      | 2661-27                     | 2661-28                        | 0600-00                    | 0616-00                                | 1235-07                  | 0140-01                    |
| •• 6DN3A3500-TSN                       | 6DN3R37M0-TSN                      | 2661-27                     | 2661-28                        | 0600-00                    | 0616-00                                | 1235-07                  | 0142-01                    |
| •• 6DN3A350E-FSD                       | 6DN3R37ME-FSD                      | 2661-27                     | 2661-28                        | 0600-00                    | 0616-00                                | 1235-07                  | 0140-01                    |
| •• 6DN3A350E-FSU                       | 6DN3R37ME-FSU                      | 2661-27                     | 2661-28                        | 0600-00                    | 0616-00                                | 1235-07                  | 0140-01                    |
| •• 6DN3A350E-TSE                       | 6DN3R37ME-TSE                      | 2661-27                     | 2661-28                        | 0600-00                    | 0616-00                                | 1235-07                  | 0140-01                    |
| •• 6DN3A350E-TSN                       | 6DN3R37ME-TSN                      | 2661-27                     | 2661-28                        | 0600-00                    | 0616-00                                | 1235-07                  | 0142-01                    |
| •• 6DP1A2000-TSK                       | N/A                                | 2661-27                     | 2661-28                        | 0600-00                    | 0616-00                                | 1235-01                  | 0142-00                    |
| •• 6DP1A3500-FSD                       | 6DP1R35M0-FSD                      | 2661-27                     | 2661-28                        | 0600-00                    | 0616-00                                | 1235-01                  | 0140-01                    |
| •• 6DP1A3500-TSE                       | 6DP1R35M0-TSE                      | 2661-27                     | 2661-28                        | 0600-00                    | 0616-00                                | 1235-01                  | 0140-01                    |
| •• 6DP1A3500-TSK                       | 6DP1R35M0-TSK                      | 2661-27                     | 2661-28                        | 0600-00                    | 0616-00                                | 1235-01                  | 0141-01                    |
| •• 6DP1A350E-TSK                       | 6DP1R35ME-TSK                      | 2661-27                     | 2661-28                        | 0600-00                    | 0616-00                                | 1235-01                  | 0141-01                    |
| •• 6DP3A200E-FSM                       | 6DP3R23ME-FSM                      | 2661-26                     | 2661-28                        | 0600-00                    | 0616-00                                | 1235-01                  | 0140-00                    |
| •• 6DP3A200E-TSE                       | 6DP3R23ME-TSE                      | 2661-27                     | 2661-28                        | 0600-00                    | 0616-00                                | 1235-01                  | 0140-00                    |
| •• 6DP3A200E-TSK                       | 6DP3R23ME-TSK                      | 2661-27                     | 2661-28                        | 0600-00                    | 0616-00                                | 1235-01                  | 0142-00                    |
| •• 6DP3A3500-FSD                       | 6DP3R35M0-FSD                      | 2661-27                     | 2661-28                        | 0600-00                    | 0616-00                                | 1235-01                  | 0140-01                    |
| •• 6DP3A3500-TSE                       | 6DP3R35M0-TSE                      | 2661-27                     | 2661-28                        | 0600-00                    | 0616-00                                | 1235-01                  | 0140-01                    |
| •• 6DP3A3500-TSK                       | 6DP3R35M0-TSK                      | 2661-27                     | 2661-28                        | 0600-00                    | 0616-00                                | 1235-01                  | 0142-01                    |
| •• 6DP3A350E-FSD                       | 6DP3R35ME-FSD                      | 2661-27                     | 2661-28                        | 0600-00                    | 0616-00                                | 1235-01                  | 0140-01                    |
| •• 6DP3A350E-TSE                       | 6DP3R35ME-TSE                      | 2661-27                     | 2661-28                        | 0600-00                    | 0616-00                                | 1235-01                  | 0140-01                    |
| •• 6DP3A350E-TSK                       | 6DP3R35ME-TSK                      | 2661-27                     | 2661-28                        | 0600-00                    | 0616-00                                | 1235-01                  | 0142-01                    |
| • 6DR1A4000-FSD                        | 6DR1R40M0-FSD                      | 2661-27                     | 2661-28                        | 0600-00                    | 0616-00                                | 1235-03                  | 0140-01                    |
| • 6DR1A4000-FSU                        | 6DR1R40M0-FSU                      | 2661-27                     | 2661-28                        | 0600-00                    | 0616-00                                | 1235-03                  | 0140-01                    |
| • 6DR1A4000-TSE                        | 6DR1R40M0-TSE                      | 2661-27                     | 2661-28                        | 0600-00                    | 0616-00                                | 1235-03                  | 0140-01                    |
| • 6DR1A4000-TSN                        | 6DR1R40M0-TSN                      | 2661-27                     | 2661-28                        | 0600-00                    | 0616-00                                | 1235-03                  | 0142-01                    |
| • 6DR3A300E-TSE                        | 6DR3R28ME-TSE                      | 2661-27                     | 2661-28                        | 0600-00                    | 0616-00                                | 1235-03                  | 0140-01                    |
| • 6DR3A300E-TSK                        | 6DR3R28ME-TSK                      | 2661-27                     | 2661-28                        | 0600-00                    | 0616-00                                | 1235-03                  | 0142-01                    |
| • 6DR3A4000-FSD                        | 6DR3R40M0-FSD                      | 2661-27                     | 2661-28                        | 0600-00                    | 0616-00                                | 1235-03                  | 0140-01                    |
| • 6DR3A4000-FSU                        | 6DR3R40M0-FSU                      | 2661-27                     | 2661-28                        | 0600-00                    | 0616-00                                | 1235-03                  | 0140-01                    |
| • 6DR3A4000-TSE                        | 6DR3R40M0-TSE                      | 2661-27                     | 2661-28                        | 0600-00                    | 0616-00                                | 1235-03                  | 0140-01                    |
| • 6DR3A4000-TSN                        | 6DR3R40M0-TSN                      | 2661-27                     | 2661-28                        | 0600-00                    | 0616-00                                | 1235-03                  | 0142-01                    |
| • 6DR3A400E-FSD                        | 6DR3R40ME-FSD                      | 2661-27                     | 2661-28                        | 0600-00                    | 0616-00                                | 1235-03                  | 0140-01                    |

New Model Nomenclature (5th Digit = Application Rating)

R = Rating at +45°F to +130°F at 90°F Ambient Air

S = Rating at +20°F to +120°F at 90°F Ambient Air

F = Rating at -25°F to +105°F at 90° Ambient Air

- 1 Bank Unloading
- 2 Banks Unloading

# Semi-Hermetic Compressors – 6D, 6R and 6T

## 6D Delta Reed Models - Compressor Parts

| Model<br>(Horse Power<br>Nomenclature) | New Model<br>(BTU<br>Nomenclature) | Delta<br>Valve<br>Plate Kit | Unloader<br>Valve<br>Plate Kit | Cylinder<br>Head<br>Gasket | Unloader<br>Cylinder<br>Head<br>Gasket | Valve<br>Plate<br>Gasket | Terminal<br>Plate<br>Group |
|--|------------------------------------|-----------------------------|--------------------------------|----------------------------|--|--------------------------|----------------------------|
|  |                                    | (998-)                      | (998-)                         | (020-)                     | (020-)                                 | (020-)                   | (521-)                     |
| • 6DR3A400E-FSU                        | 6DR3R40ME-FSU                      | 2661-27                     | 2661-28                        | 0600-00                    | 0616-00                                | 1235-03                  | 0140-01                    |
| • 6DR3A400E-TSE                        | 6DR3R40ME-TSE                      | 2661-27                     | 2661-28                        | 0600-00                    | 0616-00                                | 1235-03                  | 0140-01                    |
| • 6DR3A400E-TSN                        | 6DR3R40ME-TSN                      | 2661-27                     | 2661-28                        | 0600-00                    | 0616-00                                | 1235-03                  | 0142-01                    |
| •• 6DS1A4000-FSD                       | 6DS1R40M0-FSD                      | 2661-27                     | 2661-28                        | 0600-00                    | 0616-00                                | 1235-03                  | 0140-01                    |
| •• 6DS1A4000-FSU                       | 6DS1R40M0-FSU                      | 2661-27                     | 2661-28                        | 0600-00                    | 0616-00                                | 1235-03                  | 0140-01                    |
| •• 6DS1A4000-TSE                       | 6DS1R40M0-TSE                      | 2661-27                     | 2661-28                        | 0600-00                    | 0616-00                                | 1235-03                  | 0140-01                    |
| •• 6DS1A4000-TSN                       | 6DS1R40M0-TSN                      | 2661-27                     | 2661-28                        | 0600-00                    | 0616-00                                | 1235-03                  | 0142-01                    |
| •• 6DS3A300E-TSE                       | 6DS3R28ME-TSE                      | 2661-27                     | 2661-28                        | 0600-00                    | 0616-00                                | 1235-03                  | 0140-00                    |
| •• 6DS3A300E-TSK                       | 6DS3R28ME-TSK                      | 2661-27                     | 2661-28                        | 0600-00                    | 0616-00                                | 1235-03                  | 0142-00                    |
| •• 6DS3A4000-FSD                       | 6DS3R40M0-FSD                      | 2661-27                     | 2661-28                        | 0600-00                    | 0616-00                                | 1235-03                  | 0140-01                    |
| •• 6DS3A4000-FSU                       | 6DS3R40M0-FSU                      | 2661-27                     | 2661-28                        | 0600-00                    | 0616-00                                | 1235-03                  | 0140-01                    |
| •• 6DS3A4000-TSE                       | 6DS3R40M0-TSE                      | 2661-27                     | 2661-28                        | 0600-00                    | 0616-00                                | 1235-03                  | 0140-01                    |
| •• 6DS3A4000-TSN                       | 6DS3R40M0-TSN                      | 2661-27                     | 2661-28                        | 0600-00                    | 0616-00                                | 1235-03                  | 0142-01                    |
| •• 6DS3A400E-FSD                       | 6DS3R40ME-FSD                      | 2661-27                     | 2661-28                        | 0600-00                    | 0616-00                                | 1235-03                  | 0140-01                    |
| •• 6DS3A400E-FSU                       | 6DS3R40ME-FSU                      | 2661-27                     | 2661-28                        | 0600-00                    | 0616-00                                | 1235-03                  | 0140-01                    |
| •• 6DS3A400E-TSE                       | 6DS3R40ME-TSE                      | 2661-27                     | 2661-28                        | 0600-00                    | 0616-00                                | 1235-03                  | 0140-01                    |
| •• 6DS3A400E-TSN                       | 6DS3R40ME-TSN                      | 2661-27                     | 2661-28                        | 0600-00                    | 0616-00                                | 1235-03                  | 0140-01                    |
| 6DT1A3000-FSD                          | 6DT1F11M0-FSD                      | 2661-26                     |                                | 0600-00                    |  | 1235-03                  | 0140-00                    |
| 6DT1A3000-TSE                          | 6DT1F11M0-TSE                      | 2661-26                     |                                | 0600-00                    |  | 1235-03                  | 0140-00                    |
| 6DT1A3000-TSK                          | 6DT1F11M0-TSK                      | 2661-26                     |                                | 0600-00                    |  | 1235-03                  | 0142-00                    |
| 6DT3A3000-FSD                          | 6DT3F11M0-FSD                      | 2661-26                     |                                | 0600-00                    |  | 1235-03                  | 0140-00                    |
| 6DT3A3000-TSE                          | 6DT3F11M0-TSE                      | 2661-26                     |                                | 0600-00                    |  | 1235-03                  | 0140-00                    |
| 6DT3A3000-TSK                          | 6DT3F11M0-TSK                      | 2661-26                     |                                | 0600-00                    |  | 1235-03                  | 0142-00                    |
| 6DT3A300E-FSD                          | 6DT3F11ME-FSD                      | 2661-26                     |                                | 0600-00                    |  | 1235-03                  | 0140-00                    |
| 6DT3A300E-TSE                          | 6DT3F11ME-TSE                      | 2661-26                     |                                | 0600-00                    |  | 1235-03                  | 0140-00                    |
| 6DT3A300E-TSK                          | 6DT3F11ME-TSK                      | 2661-26                     |                                | 0600-00                    |  | 1235-03                  | 0142-00                    |
| • 6DW3A3000-FSD                        | 6DW3R32M0-FSD                      | 2661-27                     | 2661-28                        | 0600-00                    | 0616-00                                | 1235-01                  | 0140-01                    |
| • 6DW3A3000-TSE                        | 6DW3R32M0-TSE                      | 2661-27                     | 2661-28                        | 0600-00                    | 0616-00                                | 1235-01                  | 0140-01                    |
| • 6DW3A3000-TSK                        | 6DW3R32M0-TSK                      | 2661-27                     | 2661-28                        | 0600-00                    | 0616-00                                | 1235-01                  | 0142-01                    |
| • 6DW3A300E-FSD                        | 6DW3R32ME-FSD                      | 2661-27                     | 2661-28                        | 0600-00                    | 0616-00                                | 1235-01                  | 0140-01                    |
| • 6DW3A300E-TSE                        | 6DW3R32ME-TSE                      | 2661-27                     | 2661-28                        | 0600-00                    | 0616-00                                | 1235-01                  | 0140-01                    |
| • 6DW3A300E-TSK                        | 6DW3R32ME-TSK                      | 2661-27                     | 2661-28                        | 0600-00                    | 0616-00                                | 1235-01                  | 0142-01                    |
| •• 6DY3A3000-FSD                       | 6DY3R32M0-FSD                      | 2661-27                     | 2661-28                        | 0600-00                    | 0616-00                                | 1235-01                  | 0140-01                    |
| •• 6DY3A3000-TSE                       | 6DY3R32M0-TSE                      | 2661-27                     | 2661-28                        | 0600-00                    | 0616-00                                | 1235-01                  | 0140-01                    |
| •• 6DY3A3000-TSK                       | 6DY3R32M0-TSK                      | 2661-27                     | 2661-28                        | 0600-00                    | 0616-00                                | 1235-01                  | 0142-01                    |
| •• 6DY3A300E-FSD                       | 6DY3R32ME-FSD                      | 2661-27                     | 2661-28                        | 0600-00                    | 0616-00                                | 1235-01                  | 0140-01                    |

New Model Nomenclature (5th Digit = Application Rating)

R = Rating at +45°F to +130°F at 90°F Ambient Air

S = Rating at +20°F to +120°F at 90°F Ambient Air

F = Rating at -25°F to +105°F at 90° Ambient Air

- 1 Bank Unloading
- 2 Banks Unloading



# 6D, 6R and 6T – Semi-Hermetic Compressors

## 6D Delta Reed Models - Compressor Parts

| Model<br>(Horse Power<br>Nomenclature) | New Model<br>(BTU<br>Nomenclature) | Delta<br>Valve<br>Plate Kit | Unloader<br>Valve<br>Plate Kit | Cylinder<br>Head<br>Gasket | Unloader<br>Cylinder<br>Head<br>Gasket | Valve<br>Plate<br>Gasket | Terminal<br>Plate<br>Group |
|--|------------------------------------|-----------------------------|--------------------------------|----------------------------|--|--------------------------|----------------------------|
|  |                                    | (998-)                      | (998-)                         | (020-)                     | (020-)                                 | (020-)                   | (521-)                     |
| •• 6DY3A300E-TSE                       | 6DY3R32ME-TSE                      | 2661-27                     | 2661-28                        | 0600-00                    | 0616-00                                | 1235-01                  | 0140-01                    |
| •• 6DY3A300E-TSK                       | 6DY3R32ME-TSK                      | 2661-27                     | 2661-28                        | 0600-00                    | 0616-00                                | 1235-01                  | 0142-01                    |

New Model Nomenclature (5th Digit = Application Rating)

R = Rating at +45°F to +130°F at 90°F Ambient Air

S = Rating at +20°F to +120°F at 90°F Ambient Air

F = Rating at -25°F to +105°F at 90° Ambient Air

- 1 Bank Unloading
- 2 Banks Unloading

## 6D Compressor Capacity Control Kits

| Standard<br>Model | Blocked Suction<br>Capacity Control<br>Model<br>(33% Single Bank) | Blocked Suction<br>Capacity Control<br>Model<br>(66% Two Bank) | Capacity<br>Control<br>Conversion Kit<br>with 24V<br>Unloader | Capacity<br>Control<br>Conversion Kit<br>with 120V<br>Unloader | Capacity<br>Control<br>Conversion Kit<br>with 240V<br>Unloader |
|-------------------|---|--|---|--|--|
| 6DB3A300*         | 6DW3A300*   | 6DY3A300*  | 998-2119-31   | 998-2119-32  | 998-2119-33  |
| 6DG3A350*         | 6DM3A350*   | 6DN3A350*  | 998-2119-31   | 998-2119-32  | 998-2119-33  |
| 6DL3A270*         | 6DC3A270*   | 6DD3A270*  | 998-2119-35   | 998-2119-36  | 998-2119-37  |
| 6DH3A200*         | 6DK3A200*   | 6DP3A200*  | 998-2119-31   | 998-2119-32  | 998-2119-33  |
| 6DH3A350*         | 6DK3A350*   | 6DP3A350*  | 998-2119-31   | 998-2119-32  | 998-2119-33  |
| 6DT3A300*         | 6DE3A300*   | 6DF3A300*  | 998-2119-35   | 998-2119-36  | 998-2119-37  |
| 6DJ3A300*         | 6DR3A300*   | 6DS3A300*  | 998-2119-31   | 998-2119-32  | 998-2119-33  |
| 6DJ3A400*         | 6DR3A400*   | 6DS3A400*  | 998-2119-31   | 998-2119-32  | 998-2119-33  |
| 6DB3R32M*         | 6DW3R32M*   | 6DY3R32M*  | 998-2119-31   | 998-2119-32  | 998-2119-33  |
| 6DG3R37M*         | 6DM3R37M*   | 6DN3R37M*  | 998-2119-31   | 998-2119-32  | 998-2119-33  |
| 6DL3F93K*         | 6DC3F93K*   | 6DD3F93K*  | 998-2119-35   | 998-2119-36  | 998-2119-37  |
| 6DH3R23M*         | 6DK3R23M*   | 6DP3R23M*  | 998-2119-31   | 998-2119-32  | 998-2119-33  |
| 6DH3R35M*         | 6DK3R35M*   | 6DP3R35M*  | 998-2119-31   | 998-2119-32  | 998-2119-33  |
| 6DT3F11M*         | 6DE3F11M*   | 6DSNF11M*  | 998-2119-35   | 998-2119-36  | 998-2119-37  |
| 6DJ3R28M*         | 6DR3R28M*   | 6DS3R28M*  | 998-2119-31   | 998-2119-32  | 998-2119-33  |
| 6DJ3R40M*         | 6DR3R40M*   | 6DS3R40M*  | 998-2119-31   | 998-2119-32  | 998-2119-33  |

\* = E (for POE oil models), 0 (for mineral oil models) or L (for less oil models)



# Semi-Hermetic Compressors – 6D, 6R and 6T

## 6R - Compressor Parts

| Model           | Valve Plate Kit | Complete Gasket Set | Cylinder Head Gasket | Unloader Cylinder Head Gasket | Valve Plate Gasket | Terminal Plate Group |
|-----------------|-----------------|---------------------|----------------------|-------------------------------|--------------------|----------------------|
|                 | (998-)          | (998-)              | (020-)               | (020-)                        | (020-)             | (521-)               |
| 6RA4-1000-ESL   | 0661-00         | 0669-00             | 0629-00              |                               | 0626-00            | 0141-00              |
| 6RA4-1000-FSM   | 0661-00         | 0669-00             | 0629-00              |                               | 0626-00            | 0140-00              |
| 6RA4-1000-TSE   | 0661-00         | 0669-00             | 0629-00              |                               | 0626-00            | 0140-00              |
| 6RA4-1000-TSK   | 0661-00         | 0669-00             | 0629-00              |                               | 0626-00            | 0142-00              |
| 6RA4-2000-FSD   | 0661-00         | 0669-00             | 0629-00              |                               | 0626-00            | 0140-00              |
| 6RA4-2000-TSE   | 0661-00         | 0669-00             | 0629-00              |                               | 0626-00            | 0140-00              |
| 6RA4-2000-TSK   | 0661-00         | 0669-00             | 0629-00              |                               | 0626-00            | 0142-00              |
| 6RA4-3000-FSD   | 0661-52         | 0669-00             | 0629-00              |                               | 0626-00            | 0140-00              |
| 6RA4-3000-TSE   | 0661-52         | 0669-00             | 0629-00              |                               | 0626-00            | 0140-00              |
| 6RA4-3000-TSK   | 0661-52         | 0669-00             | 0629-00              |                               | 0626-00            | 0142-00              |
| 6RA5-1000-TSK   | 0661-00         | 0669-00             | 0629-00              |                               | 0626-00            | 0142-00              |
| 6RA5-2000-TSK   | 0661-00         | 0669-00             | 0629-00              |                               | 0626-00            | 0142-00              |
| 6RB2-1000-FSM   | 0661-52         | 0669-00             | 0629-00              | 0630-00                       | 0626-00            | 0140-00              |
| 6RB2-1000-TSK   | 0661-52         | 0669-00             | 0629-00              | 0630-00                       | 0626-00            | 0142-00              |
| 6RB2-2000-FSD   | 0661-52         | 0669-00             | 0629-00              | 0630-00                       | 0626-00            | 0140-00              |
| 6RB2-2000-TSE   | 0661-52         | 0669-00             | 0629-00              | 0630-00                       | 0626-00            | 0140-00              |
| 6RB2-2000-TSK   | 0661-52         | 0669-00             | 0629-00              | 0630-00                       | 0626-00            | 0142-00              |
| 6RB5-2000-TSK   | 0661-52         | 0669-00             | 0629-00              | 0630-00                       | 0626-00            | 0142-00              |
| • 6RE2-2000-FSD | 0661-66         | 0669-00             | 0629-00              |                               | 0626-00            | 0140-00              |
| • 6RE2-2000-TSE | 0661-66         | 0669-00             | 0629-00              |                               | 0626-00            | 0140-00              |
| • 6RE2-2000-TSK | 0661-66         | 0669-00             | 0629-00              |                               | 0626-00            | 0142-00              |
| • 6RE2-3000-FSD | 0661-52         | 0669-00             | 0629-00              |                               | 0626-00            | 0140-00              |
| • 6RE2-3000-TSE | 0661-52         | 0669-00             | 0629-00              |                               | 0626-00            | 0140-00              |
| • 6RE2-3000-TSK | 0661-52         | 0669-00             | 0629-00              |                               | 0626-00            | 0140-00              |
| 6RF5-2000-FSD   | 0661-00         | 0669-00             | 0629-00              |                               | 0626-00            | 0140-00              |
| 6RF5-2000-TSE   | 0661-00         | 0669-00             | 0629-00              |                               | 0626-00            | 0140-00              |
| 6RH1-2000-TSE   | 0661-51         | 0669-54             | 0629-00              |                               | 0627-00            | 0140-00              |
| 6RH1-2000-TSK   | 0661-51         | 0669-54             | 0629-00              |                               | 0627-00            | 0142-00              |
| 6RH1-3500-FSD   | 0661-51         | 0669-54             | 0629-00              |                               | 0627-00            | 0140-01              |
| 6RH1-3500-TSE   | 0661-51         | 0669-54             | 0629-00              |                               | 0627-00            | 0140-01              |
| 6RH1-3500-TSK   | 0661-51         | 0669-54             | 0629-00              |                               | 0627-00            | 0142-01              |
| 6RH5-2000-TSK   | 0661-51         | 0669-54             | 0629-00              |                               | 0627-00            | 0142-01              |
| 6RH5-3500-TSE   | 0661-51         | 0669-54             | 0629-00              |                               | 0627-00            | 0140-01              |
| 6RJ1-3000-FSD   | 0661-60         | 0669-55             | 0629-00              |                               | 0628-01            | 0140-00              |
| 6RJ1-4000-FSD   | 0661-60         | 0669-55             | 0629-00              |                               | 0628-01            | 0140-01              |
| 6RJ1-4000-FSU   | 0661-60         | 0669-55             | 0629-00              |                               | 0628-01            | 0140-01              |
| 6RJ1-4000-TSE   | 0661-60         | 0669-55             | 0629-00              |                               | 0628-01            | 0140-01              |
| 6RJ1-4000-TSN   | 0661-60         | 0669-55             | 0629-00              |                               | 0628-01            | 0142-01              |

- 1 Bank Unloading
- 2 Banks Unloading

# 6D, 6R and 6T – Semi-Hermetic Compressors

## 6R - Compressor Parts

| Model            | Valve Plate Kit | Complete Gasket Set | Cylinder Head Gasket | Unloader Cylinder Head Gasket | Valve Plate Gasket | Terminal Plate Group |
|------------------|-----------------|---------------------|----------------------|-------------------------------|--------------------|----------------------|
|                  | (998-)          | (998-)              | (020-)               | (020-)                        | (020-)             | (521-)               |
| • 6RK2-2000-TSE  | 0661-51         | 0669-54             | 0629-00              |                               | 0627-00            | 0140-00              |
| • 6RK2-2000-TSK  | 0661-51         | 0669-54             | 0629-00              |                               | 0627-00            | 0142-00              |
| • 6RK2-3500-FSD  | 0661-51         | 0669-54             | 0629-00              |                               | 0627-00            | 0140-01              |
| • 6RK2-3500-TSE  | 0661-51         | 0669-54             | 0629-00              |                               | 0627-00            | 0140-01              |
| • 6RK2-3500-TSK  | 0661-51         | 0669-54             | 0629-00              |                               | 0627-00            | 0142-01              |
| • 6RK5-3500-FSD  | 0661-51         | 0669-54             | 0629-00              |                               | 0627-00            | 0140-01              |
| • 6RK5-3500-TSK  | 0661-51         | 0669-54             | 0629-00              |                               | 0627-00            | 0142-01              |
| 6RL1-2500-FSM    | 0661-49         | 0669-54             | 0629-00              |                               | 0627-00            | 0140-00              |
| 6RL1-2500-TSE    | 0661-49         | 0669-54             | 0629-00              |                               | 0627-00            | 0140-00              |
| 6RL1-2500-TSK    | 0661-49         | 0669-54             | 0629-00              |                               | 0627-00            | 0142-00              |
| 6RL5-2500-FSM    | 0661-49         | 0669-54             | 0629-00              |                               | 0627-00            | 0140-00              |
| 6RL5-2500-TSE    | 0661-49         | 0669-54             | 0629-00              |                               | 0627-00            | 0140-00              |
| •• 6RN2-2000-FSD | 0661-52         | 0669-00             | 0629-00              |                               | 0626-00            | 0140-00              |
| •• 6RN2-2000-TSE | 0661-52         | 0669-00             | 0629-00              |                               | 0626-00            | 0140-00              |
| •• 6RN2-2000-TSK | 0661-52         | 0669-00             | 0629-00              |                               | 0626-00            | 0142-00              |
| •• 6RN2-3000-FSD | 0661-52         | 0669-00             | 0629-00              |                               | 0626-00            | 0140-00              |
| •• 6RN2-3000-TSE | 0661-52         | 0669-00             | 0629-00              |                               | 0626-00            | 0140-00              |
| •• 6RN2-3000-TSK | 0661-52         | 0669-00             | 0629-00              |                               | 0626-00            | 0142-00              |
| •• 6RN5-3000-TSK | 0661-52         | 0669-00             | 0629-00              |                               | 0626-00            | 0142-00              |
| •• 6RP2-2000-TSE | 0661-51         | 0669-54             | 0629-00              |                               | 0627-00            | 0140-00              |
| •• 6RP2-2000-TSK | 0661-51         | 0669-54             | 0629-00              |                               | 0627-00            | 0142-00              |
| •• 6RP2-3500-FSD | 0661-51         | 0669-54             | 0629-00              |                               | 0627-00            | 0140-01              |
| •• 6RP2-3500-TSE | 0661-51         | 0669-54             | 0629-00              |                               | 0627-00            | 0140-01              |
| •• 6RP2-3500-TSK | 0661-51         | 0669-54             | 0629-00              |                               | 0627-00            | 0142-01              |
| •• 6RP5-3500-TSK | 0661-51         | 0669-54             | 0629-00              |                               | 0627-00            | 0142-01              |
| • 6RR2-4000-FSD  | 0661-60         | 0669-55             | 0629-00              |                               | 0628-01            | 0140-01              |
| • 6RR2-4000-FSU  | 0661-60         | 0669-55             | 0629-00              |                               | 0628-01            | 0140-01              |
| • 6RR2-4000-TSE  | 0661-60         | 0669-55             | 0629-00              |                               | 0628-01            | 0140-01              |
| • 6RR2-4000-TSN  | 0661-60         | 0669-55             | 0629-00              |                               | 0628-01            | 0142-01              |
| •• 6RS2-4000-FSD | 0661-60         | 0669-55             | 0629-00              |                               | 0628-01            | 0140-01              |
| •• 6RS2-4000-FSU | 0661-60         | 0669-55             | 0629-00              |                               | 0628-01            | 0140-01              |
| •• 6RS2-4000-TSE | 0661-60         | 0669-55             | 0629-00              |                               | 0628-01            | 0140-01              |
| •• 6RS2-4000-TSN | 0661-60         | 0669-55             | 0629-00              |                               | 0628-01            | 0142-01              |
| 6RT1-3000-FSD    | 0661-57         | 0669-56             | 0629-00              |                               | 0628-00            | 0140-00              |
| 6RT1-3000-TSE    | 0661-57         | 0669-56             | 0629-00              |                               | 0628-00            | 0140-00              |
| 6RT1-3000-TSK    | 0661-57         | 0669-56             | 0629-00              |                               | 0628-00            | 0142-00              |

- 1 Bank Unloading
- 2 Banks Unloading

## 6R Compressor Capacity Control Kits

| Standard Model | Blocked Suction Capacity Control Model (33% Single Bank) | Blocked Suction Capacity Control Model (66% Two Bank) | Capacity Control Conversion Kit with 24V Unloader | Capacity Control Conversion Kit with 120V Unloader | Capacity Control Conversion Kit with 240V Unloader |
|----------------|--|---|---|--|--|
| 6RA*-2000      | 6RE*-2000  | 6RN*-2000   | 998-0119-08                                       | 998-0119-09  | 998-0119-10  |
| 6RA*-3000      | 6RE*-3000  | 6RN*-3000   | 998-0119-08                                       | 998-0119-09  | 998-0119-10  |
| 6RH*-2000      | 6RK*-2000  | 6RP*-2000   | 998-0119-08                                       | 998-0119-09  | 998-0119-10  |
| 6RH*-3500      | 6RK*-3500  | 6RP*-3500   | 998-0119-08                                       | 998-0119-09  | 998-0119-10  |
| 6RJ*-3000      | 6RR*-3000  | 6RS*-3000   | 998-0119-16                                       | 998-0119-17  | 998-0119-18  |
| 6RJ*-4000      | 6RR*-4000  | 6RS*-4000   | 998-0119-16                                       | 998-0119-17  | 998-0119-18  |

Note : The position occupied by \* can be the number 1, 2, 3, 4, 5 or 8

## 6T - Compressor Parts

| Model         | Valve Plate Kit | Complete Gasket Set | Cylinder Head Gasket | Valve Plate Gasket | Terminal Plate Group |
|---------------|-----------------|---------------------|----------------------|--------------------|----------------------|
|               | (998-)          | (998-)              | (020-)               | (020-)             | (521-)               |
| 6TM1-2000-TSE | 0661-49         | 0669-54             | 0632-00              | 0627-00            | 0140-00              |
| 6TM1-2000-TSK | 0661-49         | 0669-54             | 0632-00              | 0627-00            | 0142-00              |



# 6D Copeland Discus™ III – Semi-Hermetic Compressors

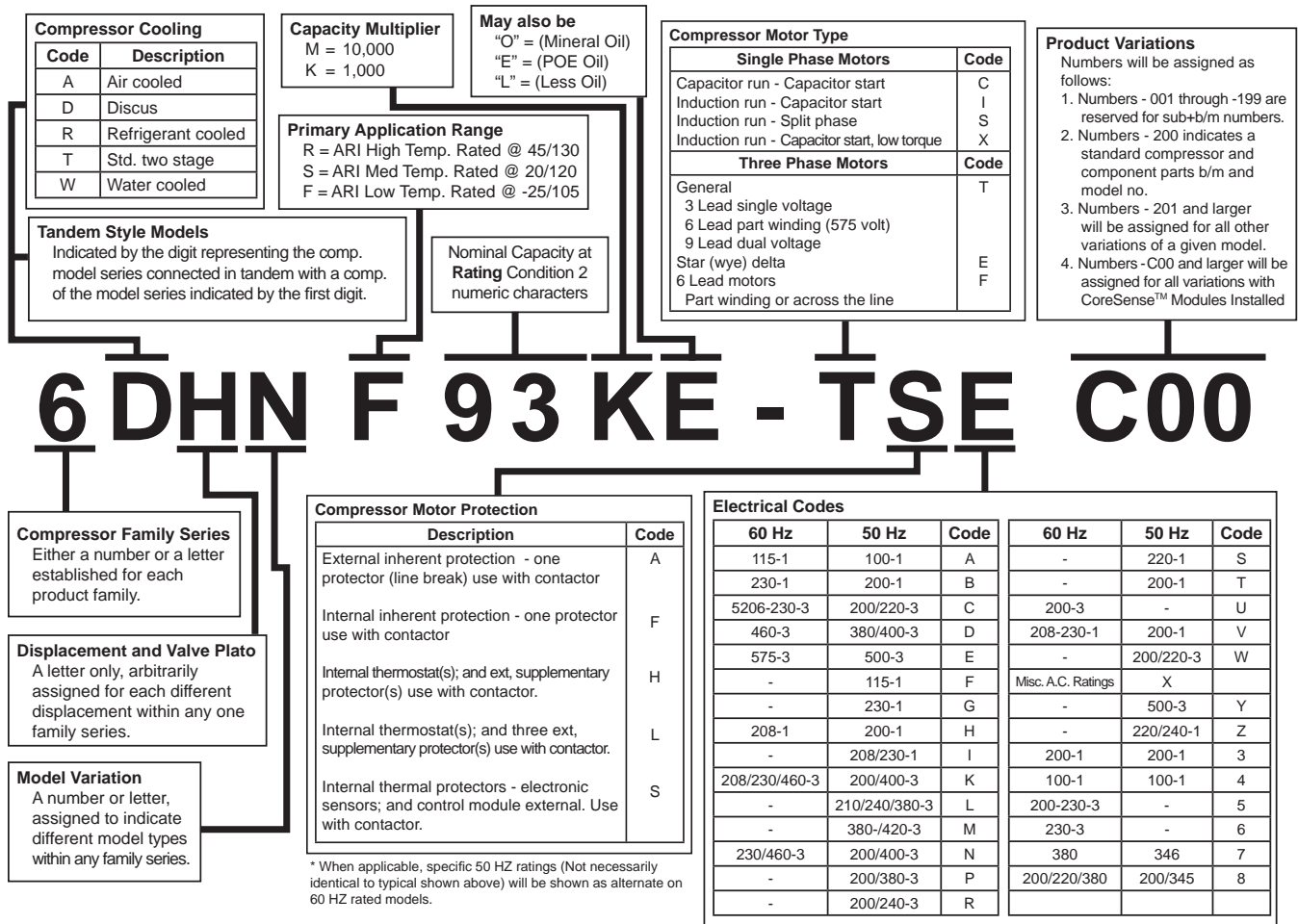

## Cooling Fan Kits

| Cooling Fan Kits               | Part #      | Used On           |
|--------------------------------|-------------|-------------------|
| 115 Volt Fan Motor Kit         | 998-0550-02 |                   |
| 115 Volt Replacement Fan Motor | 050-0254-04 |                   |
| 230 Volt Fan Motor Kit         | 998-0550-00 |                   |
| 230 Volt Replacement Fan Motor | 050-0254-02 | All 6D Discus III |
| 460 Volt Fan Motor Kit         | 998-0550-01 |                   |
| 460 Volt Replacement Fan Motor | 050-0254-05 |                   |
| Fan Mounting Kit               | 998-0574-18 |                   |
| Fan Blade                      | 083-0118-00 |                   |

## Service Valves

| Part #      | Size   | Discharge | Suction | Style       | MTG Center        | Thread    |
|-------------|--------|-----------|---------|-------------|-------------------|-----------|
| 998-0510-46 | 1 3/8" | X         |         | Rotalock    |                   | 1 3/4"-12 |
| 998-0510-66 | 1 5/8" | X         |         | Rotalock    |                   | 1 3/4"-12 |
| 998-0510-11 | 1 3/8" |           | X       | Bolt on (2) | 2 1/4" x 2 1/4"   |           |
| 998-0510-07 | 1 5/8" |           | X       | Bolt on (4) | 2 1/2" x 2 1/2"   |           |
| 998-0510-20 | 2 1/8" |           | X       | Bolt on (4) | 3 1/16" x 3 1/16" |           |

## Common Replacement Parts

| Common Parts  | Part Number |
|---|-------------|
| Sight Glass Kit   | 998-0002-02 |
| Sight Glass O-Ring  | 020-0844-05 |
| Oil Screen Kit  | 998-0513-02 |
| Magnetic Plug Gasket - 1" Internal Thread                   | 020-0006-52 |
| Magnetic Plug Gasket - 1 1/8" Internal Thread               | 020-0006-38 |
| Oil Pump Kit  | 998-0008-33 |
| Suction Strainer Assembly                                   | 548-0116-00 |
| Terminal Jumpers/Extensions                                 | 521-0065-00 |
| Gaskets   | Part Number |
| Complete Gasket Set   | 998-3669-01 |
| Capacity Control Valve - 6D*N models                        | 020-1465-00 |
| Capacity Control Blank Plate (Full Load Gasket) 6D*N models | 020-1445-00 |
| Stator Cover  | 020-0755-00 |
| Bottom Plate  | 020-1265-00 |
| Oil Pump  | 020-1267-00 |
| Housing Cover   | 020-1545-00 |
| CoreSense™ Kits and Parts                                   | Part Number |
| CoreSense Module  | 943-0128-00 |
| 6D CoreSense Wiring Harness                                 | 929-0098-00 |
| CoreSense DLT Thermistor                                    | 985-0109-50 |
| CoreSense Module Mounting Bracket/Stud Kit                  | 974-1315-00 |
| CoreSense Current Torroid                                   | 943-0064-00 |
| Oil Sensor Kit  | 998-0162-01 |
| Copper Gasket for Sensor                                    | 020-0297-13 |
| O-Ring Gasket for Sensor                                    | 020-0003-28 |
| Crankcase Heater  | Part Number |
| 120V 100 Watt (US part# 918-0028-00)                        | 518-0028-06 |
| 240V 100 Watt (US part# 918-0028-01)                        | 518-0028-07 |
| Crankcase Heater Sleeve                                     | 030-0186-01 |
| Digital Compressor Unloader Valve/Coil                      | Part Number |
| Valve Less Coil - 6D*X models                               | 910-0127-00 |
| 24 Volt Coil Only   | 923-0084-00 |
| 120 Volt Coil Only  | 923-0084-01 |
| 240 Volt Coil Only  | 923-0084-02 |
| IDCM Module   | 943-0194-00 |
| Digital Unloader Gasket - 6D*X models                       | 020-1446-00 |
| Unloader Valves & Coils                                     | Part Number |
| Valve Less Coil   | 998-0213-00 |
| 24 Volt Valve and Coil Kit                                  | 998-0213-01 |
| 24 Volt Coil Only   | 023-0091-00 |
| 120 Volt Valve and Coil Kit                                 | 998-0213-02 |
| 120 Volt Coil Only  | 023-0091-01 |
| 240 Volt Valve and Coil Kit                                 | 998-0213-03 |
| 240 Volt Coil Only  | 023-0091-02 |



# 6D Copeland Discus™ III – Semi-Hermetic Compressors

## Copeland Discus™ III to Copeland Discus™ II cross reference matrix

Use this matrix to determine required accessory kits if you are replacing a field-failed Copeland Discus™ III compressor with a Copeland Discus™ II service model.

| 6D                      | Kit Number  |  | Do I need this Kit?<br>Check the Discus III nomenclature                            | Kit includes:   | Special notes   |
|-------------------------|---|--|---|---|---|
|                         | CoreSense Protection                                    | CoreSense Diagnostics (ISD)                  |   |   |   |
| <b>Electronics Kit</b>  | 974-1315-00   | 998-3000-06                                  | 6DKNF93KE-TSK-C00<br>C = Protection kit<br>6DKNF93KE-TSK-A00<br>A = Diagnostics kit | Mounting parts (studs and nuts) necessary to reinstall CoreSense Protection or Diagnostics on Discus II service models. | You will never need both of these kits, but you will always need one. (The exception is the -441 BOM. In this case, neither kit is required.)                                       |
| <b>Low Temp Kit</b>     | 998-3000-16 (Demand Cooling™)<br>998-0574-13 (head fan) |  | 6DKXF93KE-TSK-A00<br>You need it if this digit is F**                               | Head fan and Demand Cooling™ mounting kits (including studs and nuts)   | Depending on the refrigerant in the system, you may not need to use the demand cooling mounting parts.  |
| <b>Unloading Kit</b>    | 998-0212-00 (less coil)                                 | 998-0212-00 (less coil)<br>998-0212-01 (24V) | 6DKXF93KE-TSK-A00<br>You need it if this digit is anything except H, J, B or G      | Gasket and solenoid valve assembly  | 6D models receive two unloading kits. NOTE: It is possible unloading has been added to the compressor at the time of install. If this is the case, unloading kits will be required. |
|                         | 998-0212-02 (115V coil)<br>998-0212-03 (208/220V coil)  |  |   |   |   |
| (2 kits will be sent *) |   |  |   |   |   |

\* Digital compressors (6DKXF93KE-TSK-A00/this digit of the Discus™ III nomenclature is X) will only receive one kit. Digital applications run one unloader head and one digital head.

\*\*Refer to OEM equipment guidelines. Demand Cooling is only used in R-22, R-407A, R-407C and R-407F applications.  
NOTE: Any 6DJ, 6DR, or 6DS Discus™ III model being replaced with a Discus™ II must be a -899 BOM (ie: 6DE3F11ME-TSK-899). This model is a standard bottom plate in place of the deep sump bottom plate.

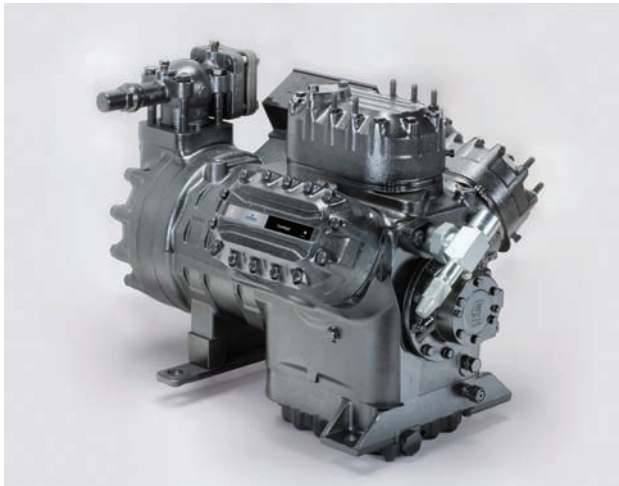

# Semi-Hermetic Compressors – 6D Copeland Discus™ III

## 6D Discus™ III Delta Reed Models - Compressor Parts

| Model                  | Equivalent Digital Model | Standard Valve Plate Kit | Unloader Valve Plate Kit | Digital Valve Plate Kit | Cylinder Head Gasket | Unloader Cylinder Head Gasket | Digital Cylinder Head Gasket | Valve Plate Gasket | Terminal Plate Group |
|------------------------|--------------------------|--------------------------|--------------------------|-------------------------|----------------------|-------------------------------|------------------------------|--------------------|----------------------|
|                        |                          | (998-)                   | (998-)                   | (998-)                  | (020-)               | (020-)                        | (020-)                       | (020-)             | (521-)               |
| 6DBNR32ME-FSD          | N/A                      | 3661-27                  |                          |                         | 1505-00              |                               |                              | 1450-00            | 0140-01              |
| 6DBNR32ME-TSE          | N/A                      | 3661-27                  |                          |                         | 1505-00              |                               |                              | 1450-00            | 0140-01              |
| 6DBNR32ME-TSK          | 6DBXR32ME-TSK            | 3661-27                  |                          |                         | 1505-00              |                               |                              | 1450-00            | 0142-01              |
| <b>D</b> 6DBXR32ME-TSK |                          | 3661-27                  |                          | 3661-66                 | 1505-00              |                               | 1455-00                      | 1450-00            | 0142-01              |
| 6DGNR37ME-FSD          | N/A                      | 3661-27                  |                          |                         | 1505-00              |                               |                              | 1450-02            | 0140-01              |
| 6DGNR37ME-FSU          | N/A                      | 3661-27                  |                          |                         | 1505-00              |                               |                              | 1450-02            | 0140-01              |
| 6DGNR37ME-TSE          | 6DGXR37ME-TSE            | 3661-27                  |                          |                         | 1505-00              |                               |                              | 1450-02            | 0140-01              |
| 6DGNR37ME-TSN          | 6DGXR37ME-TSN            | 3661-27                  |                          |                         | 1505-00              |                               |                              | 1450-02            | 0142-01              |
| <b>D</b> 6DGXR37ME-TSE |                          | 3661-27                  | 3661-28                  | 3661-66                 | 1505-00              |                               | 1455-00                      | 1450-02            | 0140-01              |
| <b>D</b> 6DGXR37ME-TSN |                          | 3661-27                  | 3661-28                  | 3661-66                 | 1505-00              |                               | 1455-00                      | 1450-02            | 0142-01              |
| 6DHNF93KE-FSD          | 6DHXF93KE-FSD            | 3661-26                  |                          |                         | 1505-00              |                               |                              | 1450-00            | 0140-00              |
| 6DHNF93KE-TSE          | 6DHXF93KE-TSE            | 3661-26                  |                          |                         | 1505-00              |                               |                              | 1450-00            | 0140-00              |
| 6DHNF93KE-TSK          | 6DHXF93KE-TSK            | 3661-26                  |                          |                         | 1505-00              |                               |                              | 1450-00            | 0142-00              |
| <b>D</b> 6DHXF93KE-TSE |                          | 3661-26                  |                          | 3661-65                 | 1505-00              |                               | 1455-00                      | 1450-00            | 0140-00              |
| <b>D</b> 6DHXF93KE-TSK |                          | 3661-26                  |                          | 3661-65                 | 1505-00              |                               | 1455-00                      | 1450-00            | 0142-00              |
| 6DHNR23ME-TSK          | N/A                      | 3661-26                  |                          |                         | 1505-00              |                               |                              | 1450-00            | 0142-00              |
| 6DHNR35ME-FSD          | N/A                      | 3661-27                  |                          |                         | 1505-00              |                               |                              | 1450-00            | 0140-01              |
| 6DHNR35ME-TSE          | 6DHXR35ME-TSE            | 3661-27                  |                          |                         | 1505-00              |                               |                              | 1450-00            | 0140-01              |
| 6DHNR35ME-TSK          | 6DHXR35ME-TSK            | 3661-27                  |                          |                         | 1505-00              |                               |                              | 1450-00            | 0142-01              |
| <b>D</b> 6DHXR35ME-TSE |                          | 3661-27                  |                          | 3661-66                 | 1505-00              |                               | 1455-00                      | 1450-00            | 0140-01              |
| <b>D</b> 6DHXR35ME-TSK |                          | 3661-27                  |                          | 3661-66                 | 1505-00              |                               | 1455-00                      | 1450-00            | 0142-01              |
| 6DJNF11ME-FSD          | N/A                      | 3661-26                  |                          |                         | 1505-00              |                               |                              | 1450-03            | 0140-00              |
| 6DJNF11ME-TSE          | 6DJXF11ME-TSE            | 3661-26                  |                          |                         | 1505-00              |                               |                              | 1450-03            | 0140-00              |
| 6DJNF11ME-TSK          | 6DJXF11ME-TSK            | 3661-26                  |                          |                         | 1505-00              |                               |                              | 1450-03            | 0142-00              |
| <b>D</b> 6DJXF11ME-TSE |                          | 3661-26                  |                          | 3661-65                 | 1505-00              |                               | 1455-00                      | 1450-03            | 0140-00              |
| <b>D</b> 6DJXF11ME-TSK |                          | 3661-26                  |                          | 3661-65                 | 1505-00              |                               | 1455-00                      | 1450-03            | 0142-00              |
| 6DJNR28ME-TSE          | N/A                      | 3661-27                  |                          |                         | 1505-00              |                               |                              | 1450-03            | 0140-00              |
| 6DJNR28ME-TSK          | N/A                      | 3661-27                  |                          |                         | 1505-00              |                               |                              | 1450-03            | 0142-00              |
| 6DJNR40ME-FSD          | N/A                      | 3661-27                  |                          |                         | 1505-00              |                               |                              | 1450-03            | 0140-01              |
| 6DJNR40ME-TSE          | 6DJXR40ME-TSE            | 3661-27                  |                          |                         | 1505-00              |                               |                              | 1450-03            | 0140-01              |
| 6DJNR40ME-TSN          | 6DJXR40ME-TSN            | 3661-27                  |                          |                         | 1505-00              |                               |                              | 1450-03            | 0142-01              |
| <b>D</b> 6DJXR40ME-TSE |                          | 3661-27                  |                          | 3661-66                 | 1505-00              |                               | 1455-00                      | 1450-03            | 0140-01              |
| <b>D</b> 6DJXR40ME-TSN |                          | 3661-27                  |                          | 3661-66                 | 1505-00              |                               | 1455-00                      | 1450-03            | 0142-01              |
| • 6DKNF93KE-FSD        | N/A                      | 3661-26                  | 3661-25                  |                         | 1505-00              | 1454-00                       |                              | 1450-00            | 0140-00              |
| • 6DKNF93KE-TSE        | 6DHXF93KE-TSE            | 3661-26                  | 3661-25                  |                         | 1505-00              | 1454-00                       |                              | 1450-00            | 0140-00              |
| • 6DKNF93KE-TSK        | 6DHXF93KE-TSK            | 3661-26                  | 3661-25                  |                         | 1505-00              | 1454-00                       |                              | 1450-00            | 0142-00              |
| <b>D</b> 6DKXF93KE-TSE |                          | 3661-26                  | 3661-25                  | 3661-65                 | 1505-00              | 1454-00                       | 1455-00                      | 1450-00            | 0140-00              |
| <b>D</b> 6DKXF93KE-TSK |                          | 3661-26                  | 3661-25                  | 3661-65                 | 1505-00              | 1454-00                       | 1455-00                      | 1450-00            | 0142-00              |

**D** Digital Model

• 1 Bank Unloading

•• 2 Banks Unloading

# 6D Copeland Discus™ III – Semi-Hermetic Compressors

## 6D Discus™ III Delta Reed Models - Compressor Parts

| Model                  | Equivalent Digital Model | Standard Valve Plate Kit | Unloader Valve Plate Kit | Digital Valve Plate Kit | Cylinder Head Gasket | Unloader Cylinder Head Gasket | Digital Cylinder Head Gasket | Valve Plate Gasket | Terminal Plate Group |
|------------------------|--------------------------|--------------------------|--------------------------|-------------------------|----------------------|-------------------------------|------------------------------|--------------------|----------------------|
|                        |                          | (998-)                   | (998-)                   | (998-)                  | (020-)               | (020-)                        | (020-)                       | (020-)             | (521-)               |
| <b>D</b> 6DHXR35ME-TSK |                          | 3661-27                  |                          | 3661-66                 | 1505-00              |                               | 1455-00                      | 1450-00            | 0142-01              |
| 6DJNF11ME-FSD          | N/A                      | 3661-26                  |                          |                         | 1505-00              |                               |                              | 1450-03            | 0140-00              |
| 6DJNF11ME-TSE          | 6DJXF11ME-TSE            | 3661-26                  |                          |                         | 1505-00              |                               |                              | 1450-03            | 0140-00              |
| 6DJNF11ME-TSK          | 6DJXF11ME-TSK            | 3661-26                  |                          |                         | 1505-00              |                               |                              | 1450-03            | 0142-00              |
| <b>D</b> 6DJXF11ME-TSE |                          | 3661-26                  |                          | 3661-65                 | 1505-00              |                               | 1455-00                      | 1450-03            | 0140-00              |
| <b>D</b> 6DJXF11ME-TSK |                          | 3661-26                  |                          | 3661-65                 | 1505-00              |                               | 1455-00                      | 1450-03            | 0142-00              |
| 6DJNR28ME-TSE          | N/A                      | 3661-27                  |                          |                         | 1505-00              |                               |                              | 1450-03            | 0140-00              |
| 6DJNR28ME-TSK          | N/A                      | 3661-27                  |                          |                         | 1505-00              |                               |                              | 1450-03            | 0142-00              |
| 6DJNR40ME-FSD          | N/A                      | 3661-27                  |                          |                         | 1505-00              |                               |                              | 1450-03            | 0140-01              |
| 6DJNR40ME-TSE          | 6DJXR40ME-TSE            | 3661-27                  |                          |                         | 1505-00              |                               |                              | 1450-03            | 0140-01              |
| 6DJNR40ME-TSN          | 6DJXR40ME-TSN            | 3661-27                  |                          |                         | 1505-00              |                               |                              | 1450-03            | 0142-01              |
| <b>D</b> 6DJXR40ME-TSE |                          | 3661-27                  |                          | 3661-66                 | 1505-00              |                               | 1455-00                      | 1450-03            | 0140-01              |
| <b>D</b> 6DJXR40ME-TSN |                          | 3661-27                  |                          | 3661-66                 | 1505-00              |                               | 1455-00                      | 1450-03            | 0142-01              |
| • 6DKNF93KE-FSD        | N/A                      | 3661-26                  | 3661-25                  |                         | 1505-00              | 1454-00                       |                              | 1450-00            | 0140-00              |
| • 6DKNF93KE-TSE        | 6DHXF93KE-TSE            | 3661-26                  | 3661-25                  |                         | 1505-00              | 1454-00                       |                              | 1450-00            | 0140-00              |
| • 6DKNF93KE-TSK        | 6DHXF93KE-TSK            | 3661-26                  | 3661-25                  |                         | 1505-00              | 1454-00                       |                              | 1450-00            | 0142-00              |
| <b>D</b> 6DKXF93KE-TSE |                          | 3661-26                  | 3661-25                  | 3661-65                 | 1505-00              | 1454-00                       | 1455-00                      | 1450-00            | 0140-00              |
| <b>D</b> 6DKXF93KE-TSK |                          | 3661-26                  | 3661-25                  | 3661-65                 | 1505-00              | 1454-00                       | 1455-00                      | 1450-00            | 0142-00              |
| • 6DKNR23ME-TSK        | N/A                      | 3661-27                  | 3661-28                  |                         | 1505-00              | 1454-00                       |                              | 1450-00            | 0142-00              |
| • 6DKNR35ME-FSD        | N/A                      | 3661-27                  | 3661-28                  |                         | 1505-00              | 1454-00                       |                              | 1450-00            | 0140-01              |
| • 6DKNR35ME-TSE        | 6DJXR35ME-TSE            | 3661-27                  | 3661-28                  |                         | 1505-00              | 1454-00                       |                              | 1450-00            | 0140-01              |
| • 6DKNR35ME-TSK        | 6DJXR35ME-TSK            | 3661-27                  | 3661-28                  |                         | 1505-00              | 1454-00                       |                              | 1450-00            | 0142-01              |
| <b>D</b> 6DKXR35ME-TSE |                          | 3661-27                  | 3661-28                  | 3661-66                 | 1505-00              | 1454-00                       | 1455-00                      | 1450-00            | 0140-01              |
| <b>D</b> 6DKXR35ME-TSK |                          | 3661-27                  | 3661-28                  | 3661-66                 | 1505-00              | 1454-00                       | 1455-00                      | 1450-00            | 0142-01              |
| • 6DMNR37ME-FSD        | N/A                      | 3661-27                  | 3661-28                  |                         | 1505-00              | 1454-00                       |                              | 1450-02            | 0140-01              |
| • 6DMNR37ME-FSU        | N/A                      | 3661-27                  | 3661-28                  |                         | 1505-00              | 1454-00                       |                              | 1450-02            | 0140-01              |
| • 6DMNR37ME-TSE        | 6DGXR37ME-TSE            | 3661-27                  | 3661-28                  |                         | 1505-00              | 1454-00                       |                              | 1450-02            | 0140-01              |
| • 6DMNR37ME-TSN        | 6DGXR37ME-TSN            | 3661-27                  | 3661-28                  |                         | 1505-00              | 1454-00                       |                              | 1450-02            | 0142-01              |
| <b>D</b> 6DMXR37ME-TSE |                          | 3661-27                  | 3661-28                  | 3661-66                 | 1505-00              |                               | 1455-00                      | 1450-02            | 0140-01              |
| <b>D</b> 6DMXR37ME-TSN |                          | 3661-27                  | 3661-28                  | 3661-66                 | 1505-00              |                               | 1455-00                      | 1450-02            | 0142-01              |
| •• 6DNNR37ME-FSD       | N/A                      | 3661-27                  | 3661-28                  |                         | 1505-00              | 1454-00                       |                              | 1450-02            | 0140-01              |
| •• 6DNNR37ME-FSU       | N/A                      | 3661-27                  | 3661-28                  |                         | 1505-00              | 1454-00                       |                              | 1450-02            | 0140-01              |
| •• 6DNNR37ME-TSE       | 6DMXR37ME-TSE            | 3661-27                  | 3661-28                  |                         | 1505-00              | 1454-00                       |                              | 1450-02            | 0140-01              |
| •• 6DNNR37ME-TSN       | 6DMXR37ME-TSN            | 3661-27                  | 3661-28                  |                         | 1505-00              | 1454-00                       |                              | 1450-02            | 0142-01              |
| •• 6DPNF93KE-FSD       | N/A                      | 3661-26                  | 3661-25                  |                         | 1505-00              | 1454-00                       |                              | 1450-00            | 0140-00              |
| •• 6DPNF93KE-TSE       | 6DKXF93KE-TSE            | 3661-26                  | 3661-25                  |                         | 1505-00              | 1454-00                       |                              | 1450-00            | 0140-00              |
| •• 6DPNF93KE-TSK       | 6DKXF93KE-TSK            | 3661-26                  | 3661-25                  |                         | 1505-00              | 1454-00                       |                              | 1450-00            | 0142-00              |
| •• 6DPNR23ME-TSE       | N/A                      | 3661-27                  | 3661-28                  |                         | 1505-00              | 1454-00                       |                              | 1450-00            | 0140-00              |

**D** Digital Model

- 1 Bank Unloading
- 2 Banks Unloading

# Semi-Hermetic Compressors – 6D Copeland Discus™ III

## 6D Discus™ III Delta Reed Models - Compressor Parts

| Model                  | Equivalent Digital Model | Standard Valve Plate Kit | Unloader Valve Plate Kit | Digital Valve Plate Kit | Cylinder Head Gasket | Unloader Cylinder Head Gasket | Digital Cylinder Head Gasket | Valve Plate Gasket | Terminal Plate Group |
|------------------------|--------------------------|--------------------------|--------------------------|-------------------------|----------------------|-------------------------------|------------------------------|--------------------|----------------------|
|                        |                          | (998-)                   | (998-)                   | (998-)                  | (020-)               | (020-)                        | (020-)                       | (020-)             | (521-)               |
| •• 6DPNR23ME-TSK       | N/A                      | 3661-27                  | 3661-28                  |                         | 1505-00              | 1454-00                       |                              | 1450-00            | 0142-00              |
| •• 6DPNR35ME-FSD       | N/A                      | 3661-27                  | 3661-28                  |                         | 1505-00              | 1454-00                       |                              | 1450-00            | 0140-01              |
| •• 6DPNR35ME-TSE       | 6DKXR35ME-TSE            | 3661-27                  | 3661-28                  |                         | 1505-00              | 1454-00                       |                              | 1450-00            | 0140-01              |
| •• 6DPNR35ME-TSK       | 6DKXR35ME-TSK            | 3661-27                  | 3661-28                  |                         | 1505-00              | 1454-00                       |                              | 1450-00            | 0142-01              |
| • 6DRNF11ME-FSD        | 6DJXF11ME-FSD            | 3661-26                  | 3661-25                  |                         | 1505-00              | 1454-00                       |                              | 1450-03            | 0140-00              |
| • 6DRNF11ME-TSE        | 6DJXF11ME-TSE            | 3661-26                  | 3661-25                  |                         | 1505-00              | 1454-00                       |                              | 1450-03            | 0140-00              |
| • 6DRNF11ME-TSK        | 6DJXF11ME-TSK            | 3661-26                  | 3661-25                  |                         | 1505-00              | 1454-00                       |                              | 1450-03            | 0142-00              |
| <b>D</b> 6DRXF11ME-TSE |                          | 3661-26                  | 3661-25                  | 3661-65                 | 1505-00              | 1454-00                       | 1455-00                      | 1450-03            | 0140-00              |
| <b>D</b> 6DRXF11ME-TSK |                          | 3661-26                  | 3661-25                  | 3661-65                 | 1505-00              | 1454-00                       | 1455-00                      | 1450-03            | 0142-00              |
| • 6DRNR28ME-TSK        | N/A                      | 3661-27                  | 3661-28                  |                         | 1505-00              | 1454-00                       |                              | 1450-03            | 0142-00              |
| • 6DRNR40ME-FSD        | N/A                      | 3661-27                  | 3661-28                  |                         | 1505-00              | 1454-00                       |                              | 1450-03            | 0140-01              |
| • 6DRNR40ME-FSU        | N/A                      | 3661-27                  | 3661-28                  |                         | 1505-00              | 1454-00                       |                              | 1450-03            | 0140-01              |
| • 6DRNR40ME-TSE        | 6DJXR40ME-TSE            | 3661-27                  | 3661-28                  |                         | 1505-00              | 1454-00                       |                              | 1450-03            | 0140-01              |
| • 6DRNR40ME-TSN        | 6DJXR40ME-TSN            | 3661-27                  | 3661-28                  |                         | 1505-00              | 1454-00                       |                              | 1450-03            | 0142-01              |
| <b>D</b> 6DRXR40ME-TSE |                          | 3661-27                  | 3661-28                  | 3661-66                 | 1505-00              | 1454-00                       | 1455-00                      | 1450-03            | 0140-01              |
| <b>D</b> 6DRXR40ME-TSN |                          | 3661-27                  | 3661-28                  | 3661-66                 | 1505-00              | 1454-00                       | 1455-00                      | 1450-03            | 0142-01              |
| •• 6DSNF11ME-FSD       | N/A                      | 3661-26                  | 3661-25                  |                         | 1505-00              | 1454-00                       |                              | 1450-03            | 0140-00              |
| •• 6DSNF11ME-TSE       | 6DRXR40ME-TSE            | 3661-26                  | 3661-25                  |                         | 1505-00              | 1454-00                       |                              | 1450-03            | 0140-00              |
| •• 6DSNF11ME-TSK       | 6DRXR40ME-TSN            | 3661-26                  | 3661-25                  |                         | 1505-00              | 1454-00                       |                              | 1450-03            | 0142-00              |
| •• 6DSNR28ME-TSE       | N/A                      | 3661-27                  | 3661-28                  |                         | 1505-00              | 1454-00                       |                              | 1450-03            | 0140-00              |
| •• 6DSNR28ME-TSK       | N/A                      | 3661-27                  | 3661-28                  |                         | 1505-00              | 1454-00                       |                              | 1450-03            | 0142-00              |
| •• 6DSNR40ME-FSD       | N/A                      | 3661-27                  | 3661-28                  |                         | 1505-00              | 1454-00                       |                              | 1450-03            | 0140-01              |
| •• 6DSNR40ME-FSU       | N/A                      | 3661-27                  | 3661-28                  |                         | 1505-00              | 1454-00                       |                              | 1450-03            | 0140-01              |
| •• 6DSNR40ME-TSE       | 6DRXR40ME-TSE            | 3661-27                  | 3661-28                  |                         | 1505-00              | 1454-00                       |                              | 1450-03            | 0140-01              |
| •• 6DSNR40ME-TSN       | 6DRXR40ME-TSN            | 3661-27                  | 3661-28                  |                         | 1505-00              | 1454-00                       |                              | 1450-03            | 0142-01              |
| 6DUNF13ME-AWD          | 6DUXF13ME-AWD            | 3661-30                  |                          |                         | 1505-00              | 1454-00                       |                              | 1450-04            | 0140-01              |
| 6DUNR49ME-AWD          | 6DUXR49ME-AWD            | 3661-31                  |                          |                         | 1505-00              | 1454-00                       |                              | 1450-04            | 0140-01              |
| <b>D</b> 6DUXF13ME-AWD |                          | 3661-30                  |                          | 3661-67                 | 1505-00              | 1454-00                       | 1455-00                      | 1450-04            | 0140-01              |
| <b>D</b> 6DUXR49ME-AWD |                          | 3661-31                  |                          | 3661-68                 | 1505-00              | 1454-00                       | 1455-00                      | 1450-04            | 0140-01              |
| 6DVNF13ME-AWD          | 6DVXF13ME-AWD            | 3661-30                  | 3661-29                  |                         | 1505-00              | 1454-00                       |                              | 1450-04            | 0140-01              |
| 6DVNR49ME-AWD          | 6DVXR49ME-AWD            | 3661-31                  | 3661-32                  |                         | 1505-00              | 1454-00                       |                              | 1450-04            | 0140-01              |
| <b>D</b> 6DVXF13ME-AWD |                          | 3661-30                  | 3661-29                  | 3661-67                 | 1505-00              | 1454-00                       | 1455-00                      | 1450-04            | 0140-01              |
| <b>D</b> 6DVXR49ME-AWD |                          | 3661-31                  | 3661-32                  | 3661-68                 | 1505-00              | 1454-00                       | 1455-00                      | 1450-04            | 0140-01              |
| 6DWRN32ME-FSD          | N/A                      | 3661-27                  | 3661-28                  |                         | 1505-00              | 1454-00                       |                              | 1450-00            | 0140-01              |
| 6DWRN32ME-TSE          | 6DBXR32ME-TSE            | 3661-27                  | 3661-28                  |                         | 1505-00              | 1454-00                       |                              | 1450-00            | 0140-01              |
| 6DWRN32ME-TSK          | 6DBXR32ME-TSK            | 3661-27                  | 3661-28                  |                         | 1505-00              | 1454-00                       |                              | 1450-00            | 0142-01              |
| 6DYNR32ME-FSD          | N/A                      | 3661-27                  | 3661-28                  |                         | 1505-00              | 1454-00                       |                              | 1450-00            | 0140-01              |
| 6DYNR32ME-TSE          | 6DWXR32ME-TSE            | 3661-27                  | 3661-28                  |                         | 1505-00              | 1454-00                       |                              | 1450-00            | 0140-01              |
| 6DYNR32ME-TSK          | 6DWXR32ME-TSK            | 3661-27                  | 3661-28                  |                         | 1505-00              | 1454-00                       |                              | 1450-00            | 0142-01              |

**D** Digital Model

• 1 Bank Unloading

•• 2 Banks Unloading

# 6D Copeland Discus™ III – Semi-Hermetic Compressors

## 6D Discus™ III Compressor Capacity Control Kits

| Standard Model | Blocked Suction Capacity Control Model (33% Single Bank) | Blocked Suction Capacity Control Model (66% Two Bank) | Capacity Control Conversion Kit with 24V Unloader | Capacity Control Conversion Kit with 120V Unloader | Capacity Control Conversion Kit with 240V Unloader |
|----------------|--|---|---|--|--|
| 6DBNR32ME      | 6DWRNR32ME   | 6DYNR32ME   | 998-3119-22                                       | 998-3119-23  | 998-3119-24  |
| 6DGNR37ME      | 6DMNR37ME  | 6DNNR37ME   | 998-3119-22                                       | 998-3119-23  | 998-3119-24  |
| 6DHNF93KE      | 6DKNF93KE  | 6DPNF93KE   | 998-3119-27                                       | 998-3119-28  | 998-3119-29  |
| 6DHNR23ME      | 6DKNR23ME  | 6DPNR23ME   | 998-3119-22                                       | 998-3119-23  | 998-3119-24  |
| 6DHNR35ME      | 6DKNR35ME  | 6DPNR35ME   | 998-3119-22                                       | 998-3119-23  | 998-3119-24  |
| 6DJNF11ME      | 6DRNF11ME  | 6DSNF11ME   | 998-3119-27                                       | 998-3119-28  | 998-3119-29  |
| 6DJNR28ME      | 6DRNR28ME  | 6DSNR28ME   | 998-3119-22                                       | 998-3119-23  | 998-3119-24  |
| 6DJNR40ME      | 6DRNR40ME  | 6DSNR40ME   | 998-3119-22                                       | 998-3119-23  | 998-3119-24  |

Contact Technical Services for any 6D Digital Capacity Modulation Applications.





# Semi-Hermetic Compressors – 9R

| Compressor Cooling |                    |
|--------------------|--------------------|
| Code               | Description        |
| A                  | Air cooled         |
| D                  | Discus             |
| R                  | Refrigerant cooled |
| T                  | Std. two stage     |
| W                  | Water cooled       |

**Tandem Style Models**  
Indicated by the digit representing the comp. model series connected in tandem with a comp. of the model series indicated by the first digit.

| Comp. Motor Rating Nominal |      |              |      |    |      |
|----------------------------|------|--------------|------|----|------|
| HP                         | Code | HP           | Code | HP | Code |
| 1/4                        | 0025 | 2-3/4        | 0275 | 15 | 1500 |
| 1/3                        | 0033 | 3 (0310)     | 0300 | 20 | 2000 |
| 1/2                        | 0050 | 3-1/2        | 0350 | 25 | 2500 |
| 3/4                        | 0075 | 4 (0406)     | 0400 | 30 | 3000 |
| 1                          | 0100 | 5 (0506)     | 0500 | 35 | 3500 |
| 1-1/4                      | 0125 | 6            | 0600 | 40 | 4000 |
| 1-1/2                      | 0150 | 7-1/2 (0766) | 0750 | 50 | 5000 |
| 1-3/4                      | 0175 | 9            | 0900 | 60 | 6000 |
| 2                          | 0200 | 10 (1015)    | 1000 |    |      |
| 2-1/2                      | 0250 | 12           | 1200 |    |      |

Note: Nominal horsepower rating of tandem compressors is sum of individual compressor ratings

| Compressor Motor Type                       |      |
|---|------|
| Single Phase Motors                         | Code |
| Capacitor run - Capacitor start             | C    |
| Induction run - Capacitor start             | I    |
| Induction run - Split phase                 | S    |
| Induction run - Capacitor start, low torque | X    |
| Three Phase Motors                          | Code |
| General                                     | T    |
| 3 Lead single voltage                       |      |
| 6 Lead part winding (575 volt)              |      |
| 9 Lead dual voltage                         |      |
| Star (wye) delta                            | E    |
| 6 Lead motors                               | F    |
| Part winding or across the line             |      |

**Product Variations**  
Numbers will be assigned as follows:  
1. Numbers -001 through -199 are reserved for sub+b/m numbers.  
2. Numbers -200 indicates a standard compressor and component parts b/m and model no.  
3. Numbers -201 and larger will be assigned for all other variations of a given model.

# 9RP2 - 1015 - TFE 800

**Compressor Family Series**  
Either a number or a letter established for each product family.

**Displacement and Valve Plate**  
A letter only, arbitrarily assigned for each different displacement within any one family series.

**Model Variation**  
A number or letter, assigned to indicate different model types within any family series.

**May also be**  
"A" = (Alkylbenzene)  
"E" = (POE Oil)  
"L" = (Less Oil)

| Compressor Motor Protection  |      |
|--|------|
| Description  | Code |
| External inherent protection - one protector (line break) use with contactor                       | A    |
| Internal inherent protection - one protector use with contactor                                    | F    |
| Internal thermostat(s); and ext, supplementary protector(s) use with contactor.                    | H    |
| Internal thermostat(s); and three ext, supplementary protector(s) use with contactor.              | L    |
| Internal thermal protectors - electronic sensors; and control module external. Use with contactor. | S    |

\* When applicable, specific 50 Hz ratings (Not necessarily identical to typical shown above) will be shown as alternate on 60 HZ rated models.

| Electrical Codes |               |      |                    |           |      |
|------------------|---------------|------|--------------------|-----------|------|
| 60 Hz            | 50 Hz         | Code | 60 Hz              | 50 Hz     | Code |
| 115-1            | 100-1         | A    | -                  | 220-1     | S    |
| 230-1            | 200-1         | B    | -                  | 200-1     | T    |
| 5206-230-3       | 200/220-3     | C    | 200-3              | -         | U    |
| 460-3            | 380/400-3     | D    | 208-230-1          | 200-1     | V    |
| 575-3            | 500-3         | E    | -                  | 200/220-3 | W    |
| -                | 115-1         | F    | Misc. A.C. Ratings | X         |      |
| -                | 230-1         | G    | -                  | 500-3     | Y    |
| 208-1            | 200-1         | H    | -                  | 220/240-1 | Z    |
| -                | 208/230-1     | I    | 200-1              | 200-1     | 3    |
| 208/230/460-3    | 200/400-3     | K    | 100-1              | 100-1     | 4    |
| -                | 210/240/380-3 | L    | 200-230-3          | -         | 5    |
| -                | 380-/420-3    | M    | 230-3              | -         | 6    |
| 230/460-3        | 200/400-3     | N    | 380                | 346       | 7    |
| -                | 200/380-3     | P    | 200/220/380        | 200/345   | 8    |
| -                | 200/240-3     | R    |                    |           |      |





# 9R – Semi-Hermetic Compressors

## Common Replacement Parts

| Common Parts  | Part Number |
|---|-------------|
| Sight Glass Kit   | 998-0002-02 |
| Sight Glass O-Ring  | 020-0844-04 |
| Oil Screen Kit  | 998-0513-03 |
| Oil Pump Kit  | 998-0008-33 |
| Rotalock Adaptor Kit  | 998-0036-00 |
| Terminal Plate Parts  | Part Number |
| Terminal Fused Cluster (Fusite)   | 521-0018-00 |
| Terminal Fused Seal (Fusite)  | 020-0844-02 |
| “T” Block - used with Fusite electrical connector                       | 921-0227-00 |
| Terminal Insulator - models with terminal stud electrical connections   | 080-0026-00 |
| Gaskets   | Part Number |
| Complete Gasket Set   | 998-0669-37 |
| Cylinder Head Gasket - all except 9RP and 9RT                           | 020-0610-00 |
| Cylinder Head Gasket - 9RP2   | 020-0607-00 |
| Cylinder Head Gasket - 9RT  | 020-0608-00 |
| Housing Cover   | 020-0749-00 |
| Stator Cover  | 020-0130-00 |
| Bottom Plate  | 020-0479-00 |
| Oil Pump  | 020-1204-00 |
| Terminal Plate  | 020-0146-00 |
| Rotalock Adaptor  | 020-0012-09 |
| Crankcase Heater  | Part Number |
| 120 Volt 100 Watt   | 518-0028-06 |
| 240 Volt 100 Watt   | 518-0028-07 |
| Crankcase Heater Well   | 030-0187-01 |
| 9T (Two Stage) Compressor Parts   | Part Number |
| Subcooler - replaces all previous part#'s                               | 567-0014-00 |
| Desuperheating/Subcooler TXV - all 9TK1/9TK2                            | 510-0144-00 |
| Desuperheating/Subcooler TXV - all 9TL1/9TL2/9TH1/9TH2                  | 510-0144-02 |
| Sentronic 3 Kits and Parts  | Part Number |
| Complete Kit  | 585-1076-02 |
| Sensor and Cable Kit  | 998-0162-00 |
| Sensor Only   | 998-0162-01 |
| Copper Gasket for Sensor  | 020-0297-13 |
| O-Ring Gasket for Sensor  | 020-0003-28 |
| Cooling Fan Kits for 9R Compressors                                     | Part Number |
| 120V w/Bottom Fan Guard   | 998-0550-05 |
| 120V w/Complete Fan Guard   | 998-0550-02 |
| 240V w/Bottom Fan Guard   | 998-0550-03 |
| 240V w/Complete Fan Guard   | 998-0550-00 |
| 460V w/Bottom Fan Guard   | 998-0550-04 |
| 460V w/Complete Fan Guard   | 998-0550-01 |
| Fan Mounting Kit - "new" style 9R -0505/0765/1015/1505                  | 998-0574-08 |
| Fan Mounting Kit - "old" style (short cyl.head) 9R -0500/0760/1010/1500 | 998-0574-06 |
| Fan Blade   | 083-0118-00 |
| Top Fan Guard   | 024-0200-00 |

# Semi-Hermetic Compressors – 9R

## 9R - Compressor Parts

| Model         | Valve Plate Kit | Valve Plate Gasket | Start Capacitor |         | Run Capacitor |         | Relay   |         | Motor Protector Kit | Protector | Terminal Board Assy. |
|---------------|-----------------|--------------------|-----------------|---------|---------------|---------|---------|---------|---------------------|-----------|----------------------|
|               |                 |                    | OEM             | Service | OEM           | Service | OEM     | Service |                     |           |                      |
|               | (998-)          | (020-)             | (014-)          | (914-)  | (014-)        | (914-)  | (040-)  | (940-)  |                     |           |                      |
| 9RA1-0505-CFB | 0661-08         | 0128-01            | 0006-14         | 0006-09 | 0064-18       | 0037-22 | 0166-23 | 0001-64 | 998-0087-04         | 0144-00   | 0018-00              |
| 9RA1-0505-TFC | 0661-08         | 0128-01            |                 |         |               |         |         |         | 998-0086-09         | 0144-00   | 0018-00              |
| 9RA1-0505-TFD | 0661-08         | 0128-01            |                 |         |               |         |         |         | 998-0086-17         | 0144-00   | 0018-00              |
| 9RA1-0505-TFE | 0661-08         | 0128-01            |                 |         |               |         |         |         | 998-0086-29         | 0144-00   | 0018-00              |
| 9RA1-0506-CFB | 0661-08         | 0128-01            | 0006-14         | 0006-09 | 0064-18       | 0037-22 | 0166-23 | 0001-64 | 998-0476-01         | 0144-00   | 0018-00              |
| 9RB1-0505-CFB | 0661-09         | 0128-00            |                 |         |               |         |         |         | 998-0087-04         | 0144-00   | 0018-00              |
| 9RB1-0505-TFC | 0661-09         | 0128-00            |                 |         |               |         |         |         | 998-0086-09         | 0144-00   | 0018-00              |
| 9RB1-0505-TFD | 0661-09         | 0128-00            |                 |         |               |         |         |         | 998-0086-17         | 0144-00   | 0018-00              |
| 9RB1-0505-TFE | 0661-09         | 0128-00            |                 |         |               |         |         |         | 998-0086-29         | 0144-00   | 0018-00              |
| 9RB1-0765-TFC | 0661-09         | 0128-00            |                 |         |               |         |         |         | 998-0086-22         | 0144-00   | 0018-00              |
| 9RB1-0765-TFD | 0661-09         | 0128-00            |                 |         |               |         |         |         | 998-0086-20         | 0144-00   | 0018-00              |
| 9RB1-0765-TFE | 0661-09         | 0128-00            |                 |         |               |         |         |         | 998-0086-40         | 0144-00   | 0018-00              |
| 9RC1-0765-TFC | 0661-08         | 0128-00            |                 |         |               |         |         |         | 998-0086-22         | 0144-00   | 0018-00              |
| 9RC1-0765-TFD | 0661-08         | 0128-00            |                 |         |               |         |         |         | 998-0086-20         | 0144-00   | 0018-00              |
| 9RC1-0765-TFE | 0661-08         | 0128-00            |                 |         |               |         |         |         | 998-0086-40         | 0144-00   | 0018-00              |
| 9RC1-1015-TFC | 0661-08         | 0128-00            |                 |         |               |         |         |         | 971-0504-06         | 0201-00   |                      |
| 9RC1-1015-TFD | 0661-08         | 0128-00            |                 |         |               |         |         |         | 998-0429-17         | 0201-00   |                      |
| 9RC1-1015-TFE | 0661-08         | 0128-00            |                 |         |               |         |         |         | 998-0429-11         | 0201-00   |                      |
| 9RJ1-0505-CFB | 0661-09         | 0128-01            | 0006-14         | 0006-09 | 0064-16       | 0037-20 | 0166-23 | 0001-64 | 998-0087-04         | 0144-00   | 0018-00              |
| 9RJ1-0505-TFC | 0661-09         | 0128-01            |                 |         |               |         |         |         | 998-0086-09         | 0144-00   | 0018-00              |
| 9RJ1-0505-TFD | 0661-09         | 0128-01            |                 |         |               |         |         |         | 998-0086-17         | 0144-00   | 0018-00              |
| 9RJ1-0505-TFE | 0661-09         | 0128-01            |                 |         |               |         |         |         | 998-0086-29         | 0144-00   | 0018-00              |
| 9RJ1-0765-TFC | 0661-09         | 0128-01            |                 |         |               |         |         |         | 998-0086-21         | 0144-00   | 0018-00              |
| 9RJ1-0765-TFD | 0661-09         | 0128-01            |                 |         |               |         |         |         | 998-0086-20         | 0144-00   | 0018-00              |
| 9RJ1-0765-TFE | 0661-09         | 0128-01            |                 |         |               |         |         |         | 998-0086-40         | 0144-00   | 0018-00              |
| 9RP2-0765-TFC | 0661-08         | 0128-00            |                 |         |               |         |         |         | 998-0086-22         | 0144-00   | 0018-00              |
| 9RP2-0765-TFD | 0661-08         | 0128-00            |                 |         |               |         |         |         | 998-0086-20         | 0144-00   | 0018-00              |
| 9RP2-0765-TFE | 0661-08         | 0128-00            |                 |         |               |         |         |         | 998-0086-40         | 0144-00   | 0018-00              |
| 9RP2-1015-TFC | 0661-08         | 0128-00            |                 |         |               |         |         |         | 971-0504-06         | 0201-00   |                      |
| 9RP2-1015-TFD | 0661-08         | 0128-00            |                 |         |               |         |         |         | 998-0429-17         | 0201-00   |                      |
| 9RP2-1015-TFE | 0661-08         | 0128-00            |                 |         |               |         |         |         | 998-0429-11         | 0201-00   |                      |
| 9RS1-1505-TFD | 0661-41         | 0320-00            |                 |         |               |         |         |         | 998-0455-00         | 0201-00   |                      |
| 9RS1-1505-TFE | 0661-41         | 0320-00            |                 |         |               |         |         |         | 998-0455-02         | 0201-00   |                      |
| 9RS1-1505-TSC | 0661-41         | 0320-00            |                 |         |               |         |         |         | 998-0524-11         | 0145-00   |                      |
| 9RS2-0765-TFC | 0661-08         | 0128-04            |                 |         |               |         |         |         | 998-0086-23         | 0144-00   | 0018-00              |
| 9RS2-0765-TFD | 0661-08         | 0128-04            |                 |         |               |         |         |         | 998-0086-20         | 0144-00   | 0018-00              |
| 9RS2-0765-TFE | 0661-08         | 0128-04            |                 |         |               |         |         |         | 998-0086-26         | 0144-00   | 0018-00              |
| 9RS3-0765-TFC | 0661-08         | 0128-04            |                 |         |               |         |         |         | 998-0086-23         | 0144-00   | 0018-00              |
| 9RS3-0765-TFD | 0661-08         | 0128-04            |                 |         |               |         |         |         | 998-0086-20         | 0144-00   | 0018-00              |
| 9RS3-0765-TFE | 0661-08         | 0128-04            |                 |         |               |         |         |         | 998-0086-26         | 0144-00   | 0018-00              |
| 9RS3-1015-TFC | 0661-08         | 0128-04            |                 |         |               |         |         |         | 971-0504-06         | 0201-00   |                      |
| 9RS3-1015-TFD | 0661-08         | 0128-04            |                 |         |               |         |         |         | 998-0429-17         | 0201-00   |                      |
| 9RS3-1015-TFE | 0661-08         | 0128-04            |                 |         |               |         |         |         | 998-0429-11         | 0201-00   |                      |
| 9RT1-1505-TFD | 0661-45         | 0320-00            |                 |         |               |         |         |         | 998-0455-00         | 0201-00   |                      |
| 9RT1-1505-TFE | 0661-45         | 0320-00            |                 |         |               |         |         |         | 998-0455-02         | 0201-00   |                      |
| 9RT1-1505-TSC | 0661-45         | 0320-00            |                 |         |               |         |         |         | 998-0524-11         | 0145-00   |                      |

# 9T– Semi-Hermetic Compressors

## 9T - Compressor Parts

| Model         | Valve Plate Kit | Valve Plate Gasket | Start Capacitor |         | Run Capacitor |         | Relay |         | Motor Protector Kit | Protector | Terminal Board Assy. |
|---------------|-----------------|--------------------|-----------------|---------|---------------|---------|-------|---------|---------------------|-----------|----------------------|
|               | (998-)          | (020-)             | OEM             | Service | OEM           | Service | OEM   | Service |                     |           |                      |
|               | (014-)          | (914-)             | (014-)          | (914-)  | (040-)        | (940-)  |       |         |                     |           |                      |
| 9TK1-0505-TFC | 0661-36         | 0128-01            |                 |         |               |         |       |         | 998-0086-38         | 0144-00   | 0018-00              |
| 9TK1-0505-TFD | 0661-36         | 0128-01            |                 |         |               |         |       |         | 998-0086-17         | 0144-00   | 0018-00              |
| 9TK1-0505-TFE | 0661-36         | 0128-01            |                 |         |               |         |       |         | 998-0086-29         | 0144-00   | 0018-00              |
| 9TK2-050E-TFC | 0661-36         | 0128-01            |                 |         |               |         |       |         | 998-0086-38         | 0144-00   | 0018-00              |
| 9TK2-050E-TFD | 0661-36         | 0128-01            |                 |         |               |         |       |         | 071-0429-31         | 0144-00   | 0018-00              |
| 9TL1-0765-TFC | 0661-36         | 0128-00            |                 |         |               |         |       |         | 998-0086-22         | 0144-00   | 0018-00              |
| 9TL1-0765-TFD | 0661-36         | 0128-00            |                 |         |               |         |       |         | 998-0086-20         | 0144-00   | 0018-00              |
| 9TL1-0765-TFE | 0661-36         | 0128-00            |                 |         |               |         |       |         | 998-0086-40         | 0144-00   | 0018-00              |
| 9TL2-076E-TFC | 0661-36         | 0128-00            |                 |         |               |         |       |         | 998-0086-22         | 0144-00   | 0018-00              |
| 9TL2-076E-TFD | 0661-36         | 0128-00            |                 |         |               |         |       |         | 998-0086-20         | 0144-00   | 0018-00              |
| 9TH1-1015-TFC | 0661-36         | 0128-04            |                 |         |               |         |       |         | 971-0504-06         | 0201-00   |                      |
| 9TH1-1015-TFD | 0661-36         | 0128-04            |                 |         |               |         |       |         | 998-0429-17         | 0201-00   |                      |
| 9TH2-101E-TFC | 0661-36         | 0128-04            |                 |         |               |         |       |         | 971-0504-06         | 0201-00   |                      |
| 9TH2-101E-TFD | 0661-36         | 0128-04            |                 |         |               |         |       |         | 998-0429-17         | 0201-00   |                      |

**Note:** All 9RC\*/9RP\*/9RS\*-1015 models with a THC/THD/THE or TLC/TLD/TLE motor code use the same mechanical components listed above.

**Note:** All 9RS\*/9RT\*-1505 models with a THC/THD/THE or TLC/TLD/TLE motor code use the same mechanical components listed above. Motor ptoectors for the THC/THD/THE/TLC/TLD/TLE models are no longer available (NLA)

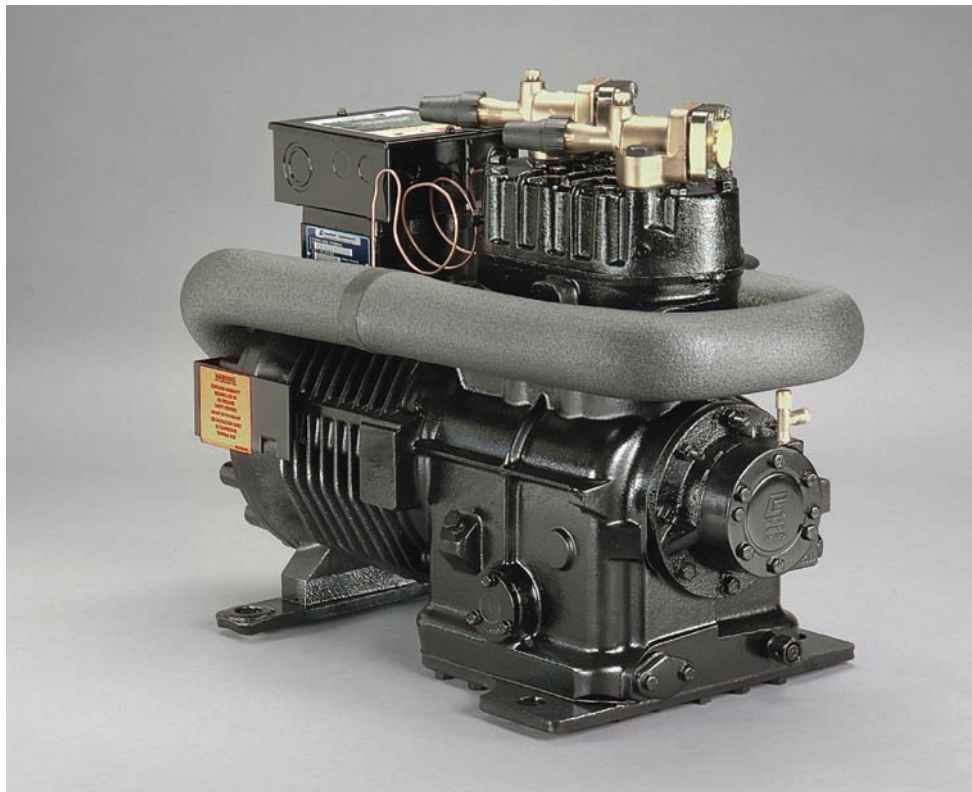

| Application Range |             |                                  |
|-------------------|-------------|----------------------------------|
| Code              | Application | Refrn/Substance Compressed       |
| B                 | Ref MT / HT | R-22/R-404A, 410A/407A/407C/407F |

| Compressor Motor Types |  |      |
|------------------------|--|------|
| Phase                  | Description  | Code |
| 1                      | Capacitor Run - Permanent Split Capacitor                              | P    |
| 3                      | General<br>- 3 Lead Single Voltage<br>- 6 Lead Part Winding (575 Volt) | T    |

| Compressor Motor Protection    |      |
|--------------------------------|------|
| Type Protection                | Code |
| Internal Inherent Protection   | F    |
| External Electronic Protection | W    |
| External Enhanced              | E    |

Family Series  
Z = Scroll

Optional  
E = POE Oil - AK/DA, 3MA or SP32

# ZBD 15KCE - PFV - 230

| Modulation |                       |
|------------|-----------------------|
| Code       | Description           |
| D          | Digital               |
| DU         | Digital Uneven Tandem |
| DT         | Digital Even Tandem   |
| S          | Ultra Tech            |
| T          | Even Tandem           |
| U          | Uneven Tandem         |

Capacity Multiplier  
M = 10,000  
K = 1,000

Bill of Material Product Variation

Nominal Capacity at Rating Condition  
2 - 3 numeric characters

| Model Variation |   |
|-----------------|---|
| 1               | R |
| 2               | H |
| 3               | L |
| 4               | M |
| 5               | Q |
| 6               | S |
| A               | W |
| B               | V |
| C               | T |
| D               |   |

| Voltage Electrical Codes |           |           |
|--------------------------|-----------|-----------|
| Voltage Code             | 60 Hertz  | 50 Hertz  |
| B                        | 230-1     |           |
| C                        | 208-230-3 | 200-3     |
| D                        | 460-3     | 380-240-3 |
| E                        | 575-3     |           |
| J                        | 265-1     | 220-240-1 |
| M                        |           | 380-420-3 |
| P                        |           | 380-3     |
| Q                        | 265-1     |           |
| R                        |           | 220-240-3 |
| S                        |           | 220-1     |
| V                        | 208-230-1 | 200-1*    |
| W                        |           | 200-220-3 |

| Misc AC Voltages |           |           |
|------------------|-----------|-----------|
| Z                |           | 220-240-1 |
| 5                | 200-230-3 | 200-220-3 |
| 7                | 380-3     |           |
| 0                |           | 415-3     |
| 3                | 220-1     | 220-1     |



# ZB – Copeland Scroll™ Compressors

## Common Replacement Parts

| Oil Controls and Adapters    | Part Number                        |
|------------------------------|------------------------------------|
| OMB Oil Control - All Models | 065365                             |
| OMB Adapters                 | Sight Glass Connection-Part#       |
| ZB15KCE-ZB48KCE, ZB57KCE     | Int. Thread (3/4" NPTF)-065668     |
| ZB56/75/92KCE, ZB11MCE       | Int. Thread (3/4" NPTF)-065668     |
| ZB56/75/92KCE, ZB11MCE       | Ext. Thread (1 3/4"-12 UNF)-066078 |
| ZB15KCE-ZB48KCE, ZB57KCE     | Ext. Thread (1 1/4"-12 UNF)-066650 |
| ZB50KCE, ZB58KCE-ZB114KCE    | Ext. Thread (1 1/4"-12 UNF)-066077 |
| All ZBK5E models             | Ext. Thread (1 1/4"-12 UNF)-066077 |

| CoreSense™ Parts                                   | Part Number |
|--|-------------|
| <b>ZB58K5E-ZB114K5E and ZF34K5E-ZF49K5E models</b> |             |
| CoreSense Module Kit                               | 943-0151-00 |
| CoreSense Current Module Kit                       | 943-0159-00 |
| Top Cap Thermistor Kit                             | 998-0229-00 |

| Discharge Line Thermostat      | Part Number |
|--------------------------------|-------------|
| 1/2" Discharge Line Thermostat | 998-7022-02 |
| 5/8" Discharge Line Thermostat | 998-7022-04 |
| 3/4" Discharge Line Thermostat | 998-7022-07 |
| 7/8" Discharge Line Thermostat | 998-7022-05 |

| Miscellaneous Parts                                     | Part Number |
|---|-------------|
| Oil Sight Glass Kit - All models with sight glass       | 998-0010-00 |
| Oil Adjustment (fill drain) Valve                       | 910-0715-00 |
| Terminal Block (T-block) Kit - includes terminal screws | 921-0227-00 |
| Molded Plug (for ZSKAE models)                          | 529-0060-04 |



## Motor Protector Modules

| Note # | OEM         | Service     | Voltage  |
|--------|-------------|-------------|----------|
| 2A     | 071-0660-00 | 971-0641-00 | 120/240V |
| 2A     | 071-0660-01 | 971-0641-01 | 24V      |
| 2B     | 071-0650-00 | 971-0547-01 | 120/240V |

## CoreSense Communication Motor Protector

| Note # | OEM         | Service     | Voltage  |
|--------|-------------|-------------|----------|
| 3      | 571-0064-06 | 971-0064-05 | 120/240V |
| 3      | 571-0065-05 | 971-0065-04 | 24V      |

## Crankcase Heater Notes

| Note # | OEM         | Service     | Volts | Watts       | Lead Length |
|--------|-------------|-------------|-------|-------------|-------------|
| 4      | 018-0091-21 | 918-0047-00 | 120V  | 90 WATT     | 48" LEAD    |
|        | 018-0091-22 | 918-0047-01 | 240V  |             |             |
|        | 018-0091-23 | 918-0047-02 | 480V  |             |             |
|        | 018-0091-24 | 918-0047-03 | 575V  |             |             |
|        |             | 998-7029-00 |       | CONDUIT BOX |             |
| 6      | 018-0094-00 | 918-0052-00 | 240V  | 40 WATT     | 21" LEAD    |
|        | 018-0094-01 | 918-0052-01 | 120V  |             |             |
| 7      | 018-0095-00 |             | 240V  | 70 WATT     | 29" LEAD    |
|        | 018-0095-01 |             | 480V  |             |             |
|        | 018-0095-02 |             | 575V  |             |             |
|        | 018-0095-04 | 918-0043-00 | 240V  |             | 48" LEAD    |
|        | 018-0095-05 | 918-0043-01 | 480V  |             |             |
|        | 018-0095-06 | 918-0043-02 | 575V  |             |             |
|        | 018-0095-07 | 918-0043-07 | 120V  |             |             |
| 9      | 018-0091-17 | 918-0019-01 | 120V  | 70 WATT     | 30" LEAD    |
|        | 018-0091-18 | 918-0019-04 | 240V  |             |             |
|        | 018-0091-19 | 918-0019-08 | 460V  |             |             |
|        | 018-0091-15 | 918-0019-09 | 575V  |             |             |





## ZB - Compressor Parts

| Model           | Start Capacitor |         | Run Capacitor |         | Relay   |         | Motor Protector | Mounting Parts | Hard Mounting Parts | Crankcase Heater |
|-----------------|-----------------|---------|---------------|---------|---------|---------|-----------------|----------------|---------------------|------------------|
|                 | OEM             | Service | OEM           | Service | OEM     | Service |                 |                |                     |                  |
|                 | (014-)          | (914-)  | (014-)        | (914-)  | (040-)  | (940-)  |                 |                |                     |                  |
| ZB10KCE-PFV*    | 0061-27         | 0036-03 | 0064-06       | 0037-10 | 0166-37 | 0001-79 | IP              | N/A            | 0116-00             | 6                |
| ZB11KC(E)-PFV*  | 0061-27         | 0036-03 | 0064-07       | 0037-11 | 0166-37 | 0001-79 | IP              | N/A            | 0116-00             | 6                |
| ZB13KCE-PFV*    | 0061-27         | 0036-03 | 0064-07       | 0037-11 | 0166-37 | 0001-79 | IP              | N/A            | 0116-00             | 6                |
| ZB14KCE-PFV*    | 0061-27         | 0036-03 | 0064-07       | 0037-11 | 0166-37 | 0001-79 | IP              | N/A            | 0116-00             | 6                |
| ZB15KA-PFV*     | 0061-27         | 0036-03 | 0064-08       | 0037-12 | 0166-37 | 0001-79 | IP              | N/A            | 0116-00             | 7                |
| ZB15KA-TF*      |                 |         |               |         |         |         | IP              | N/A            | 0116-00             | 7                |
| ZB15KC(E)-PFV*  | 0061-27         | 0036-03 | 0064-08       | 0037-12 | 0166-37 | 0001-79 | IP              | 998-0178-00    | 0116-00             | 7                |
| ZB15KC(E)-TF*   |                 |         |               |         |         |         | IP              | 998-0178-00    | 0116-00             | 7                |
| ZB19KA-PFV*     | 0061-27         | 0036-03 | 0064-25       | 0037-36 | 0166-37 | 0001-79 | IP              | N/A            | 0116-00             | 7                |
| ZB19KA-TF*      |                 |         |               |         |         |         | IP              | N/A            | 0116-00             | 7                |
| ZB19KC(E)-PFV*  | 0061-27         | 0036-03 | 0064-25       | 0037-36 | 0166-37 | 0001-79 | IP              | N/A            | 0116-00             | 7                |
| ZB19KC(E)-TF*   |                 |         |               |         |         |         | IP              | N/A            | 0116-00             | 7                |
| ZB21KA-PFV*     | 0061-27         | 0036-03 | 0064-25       | 0037-36 | 0166-37 | 0001-79 | IP              | N/A            | 0116-00             | 7                |
| ZB21KA-TF*      |                 |         |               |         |         |         | IP              | 998-0178-00    | 0116-00             | 7                |
| ZB21KC(E)-PFV*  | 0061-27         | 0036-03 | 0064-29       | 0037-40 | 0166-37 | 0001-79 | IP              | 998-0178-00    | 0116-00             | 7                |
| ZB21KC(E)-TF*   |                 |         |               |         |         |         | IP              | 998-0178-00    | 0116-00             | 7                |
| D ZBD21KCE-PFV* | 0061-27         | 0036-03 | 0064-29       | 0037-40 | 166.37  | 0001-79 | IP              | 998-0178-00    | 0116-00             | 7                |
| D ZBD21KCE-TF*  |                 |         |               |         |         |         | IP              | 998-0178-00    | 0116-00             | 7                |
| ZB26KA-PFV*     | 0061-27         | 0036-03 | 0064-25       | 0037-36 | 0166-37 | 0001-79 | IP              | N/A            | 0116-00             | 7                |
| ZB26KA-TF*      |                 |         |               |         |         |         | IP              | 998-0178-00    | 0116-00             | 7                |
| ZB26KC(E)-PFV*  | 0061-27         | 0036-03 | 0064-29       | 0037-40 | 0166-37 | 0001-79 | IP              | N/A            | 0116-00             | 7                |
| ZB26KC(E)-TF*   |                 |         |               |         |         |         | IP              | 998-0178-00    | 0116-00             | 7                |
| D ZBD28KCB-TF*  |                 |         |               |         |         |         | IP              | 527-0158-00    | 0116-00             | 7                |
| ZB29KCE-PFV*    | 0061-27         | 0036-03 | 0064-18       | 0037-22 | 0166-37 | 0001-79 | IP              | 998-0178-00    | 0116-00             | 7                |
| ZB29KCE-TF*     |                 |         |               |         |         |         | IP              | 998-0178-00    | 0116-00             | 7                |
| D ZBD29KCE-TF5  |                 |         |               |         |         |         | IP              | 0178-00        | 0116-00             | 7                |
| ZB30KA-PFV*     | 0006-15         | 0006-10 | 0064-26       | 0037-37 | 0166-37 | 0001-79 | IP              | N/A            | 0116-00             | 7                |
| ZB30KA-TF*      |                 |         |               |         |         |         | IP              | N/A            | 0116-00             | 7                |
| ZB30KC(E)-PFV*  | 0006-15         | 0006-10 | 0064-26       | 0037-37 | 0166-37 | 0001-79 | IP              | N/A            | 0116-00             | 7                |
| ZB30KC(E)-TF*   |                 |         |               |         |         |         | IP              | N/A            | 0116-00             | 7                |
| D ZBD30KCE-TF*  |                 |         |               |         |         |         | IP              | 0158-00        | 0116-00             | 7                |
| ZB38KA-PFV*     | 0006-15         | 0006-10 | 0064-27       | 0037-38 | 0166-37 | 0001-79 | IP              | 998-0178-00    | 0116-00             | 7                |
| ZB38KA-TF*      |                 |         |               |         |         |         | IP              | 998-0178-00    | 0116-00             | 7                |
| ZB38KC(E)-PFV*  | 0006-15         | 0006-10 | 0064-27       | 0037-38 | 0166-37 | 0001-79 | IP              | 998-0178-00    | 0116-00             | 7                |
| ZB38KC(E)-TF*   |                 |         |               |         |         |         | IP              | 998-0178-00    | 0116-00             | 7                |
| ZB38KCP-TF*     |                 |         |               |         |         |         | IP              | 998-0178-00    | 0116-00             | 7                |
| D ZBD38KCE-PFV  |                 |         |               |         |         |         | IP              | 527-0158-00    | 0116-00             | 7                |
| D ZBD38KCE-TF*  |                 |         |               |         |         |         | IP              | 527-0158-00    | 0116-00             | 7                |
| D ZBD38KCP-TF*  |                 |         |               |         |         |         | IP              | 527-0158-00    | 0116-00             | 7                |
| ZB42KA-PFV*     | 0006-15         | 0006-10 | 0064-26       | 0037-37 | 0166-37 | 0001-79 | IP              | N/A            | 0116-00             | 7                |
| ZB42KC(E)-PFV*  | 0006-15         | 0006-10 | 0064-16       | 0037-20 | 0166-28 | 0001-69 | IP              | N/A            | 0116-00             | 7                |
| ZB45KA-TF*      |                 |         |               |         |         |         | IP              | N/A            | 0116-00             | 7                |
| ZB45KC(E)-TF*   |                 |         |               |         |         |         | IP              | N/A            | 0116-00             | 7                |
| D ZBD45KCE-TF*  |                 |         |               |         |         |         | IP              | 527-0158-00    | 0116-00             | 7                |
| ZB48KCE-TF*     |                 |         |               |         |         |         | IP              | 527-0158-00    | 0116-00             | 7                |
| ZB49KCP-TF*     |                 |         |               |         |         |         | IP              | N/A            | 0116-00             | 7                |
| ZB50KC(E)-TF*   |                 |         |               |         |         |         | IP              | N/A            | 0116-00             | 4                |
| ZB56KA-TW*      |                 |         |               |         |         |         | NOTE 2B         | N/A            | 0116-00             | 9                |
| ZB56KC(E)-TW*   |                 |         |               |         |         |         | NOTE 2B         | N/A            | 0116-00             | 9                |
| ZB57KC(E)-TF*   |                 |         |               |         |         |         | IP              | N/A            | 0116-00             | 7                |
| D ZBD57KCE-TF*  |                 |         |               |         |         |         | IP              | 527-0158-00    | 0116-00             | 7                |
| ZB58K5E-TF*     |                 |         |               |         |         |         | IP              | 998-0178-00    | 0116-00             | 4                |
| ZB58KC(E)-TF*   |                 |         |               |         |         |         | IP              | 998-0178-00    | 0116-00             | 4                |
| D ZBD58KCE-TF*  |                 |         |               |         |         |         | IP              | N/A            | 0116-00             | 4                |

D = Digital



# ZB – Copeland Scroll™ Compressors

## ZB - Compressor Parts

| Model          | Start Capacitor |                | Run Capacitor |                | Relay      |                | Motor Protector | Mounting Parts | Hard Mounting Parts | Crankcase Heater |
|----------------|-----------------|----------------|---------------|----------------|------------|----------------|-----------------|----------------|---------------------|------------------|
|                | OEM (014-)      | Service (914-) | OEM (014-)    | Service (914-) | OEM (040-) | Service (940-) |                 |                |                     |                  |
| ZB66K5E-TF*    |                 |                |               |                |            |                | IP              | 998-0178-00    | 0116-00             | 4                |
| ZB66KC(E)-TF*  |                 |                |               |                |            |                | IP              | 998-0178-00    | 0116-00             | 4                |
| ZB68KA-TW*     |                 |                |               |                |            |                | NOTE 2B         | 527-0158-00    | 0159-00             | 9                |
| ZB69KCP-TF*    |                 |                |               |                |            |                | NOTE 2B         | N/A            | 0116-00             | 4                |
| D ZBD69KCP-TF* |                 |                |               |                |            |                | IP              | N/A            | 0116-00             | 4                |
| ZB75KA-TW*     |                 |                |               |                |            |                | NOTE 2B         | 527-0158-00    | 0159-00             | 9                |
| ZB75KC(E)-TW*  |                 |                |               |                |            |                | NOTE 2B         | 527-0158-00    | 0159-00             | 9                |
| ZB76K5E-TF*    |                 |                |               |                |            |                | IP              | 998-0178-00    | 0116-00             | 4                |
| ZB76KC(E)-TF*  |                 |                |               |                |            |                | IP              | 998-0178-00    | 0116-00             | 4                |
| D ZBD76KCE-TF  |                 |                |               |                |            |                | IP              | N/A            | 0116-00             | 4                |
| ZB78KCP-TF*    |                 |                |               |                |            |                | IP              | N/A            | 0116-00             | 4                |
| D ZBD78KCP-TF* |                 |                |               |                |            |                | IP              | N/A            | 0116-00             | 4                |
| ZB88KC(E)-TF*  |                 |                |               |                |            |                | IP              | N/A            | 0116-00             | 4                |
| ZB92KA-TW*     |                 |                |               |                |            |                | NOTE 2B         | N/A            | 0159-00             | 9                |
| ZB92KC(E)-TW*  |                 |                |               |                |            |                | NOTE 2B         | N/A            | 0159-00             | 9                |
| ZB95K5E-TF*    |                 |                |               |                |            |                | IP              | 998-0178-00    | 0210-00             | 4                |
| ZB95K5E-TW*    |                 |                |               |                |            |                | NOTE 2A         | 998-0178-00    | 0210-00             | 4                |
| ZB95KC(E)-TE*  |                 |                |               |                |            |                | NOTE 3          | 998-0178-00    | 0210-00             | 4                |
| ZB95KC(E)-TW*  |                 |                |               |                |            |                | NOTE 2A         | 998-0178-00    | 0210-00             | 4                |
| ZB107KCP-TE*   |                 |                |               |                |            |                | NOTE 3          | 998-0178-00    | 0210-00             | 4                |
| ZB107KCP-TW*   |                 |                |               |                |            |                | NOTE 2B         | N/A            | 0116-00             | 4                |
| ZB11MA-TW*     |                 |                |               |                |            |                | NOTE 2B         | N/A            | 0159-00             | 9                |
| ZB11MC(E)-TW*  |                 |                |               |                |            |                | NOTE 2B         | N/A            | 0159-00             | 9                |
| ZB114K5E-TF*   |                 |                |               |                |            |                | IP              | 527-0158-00    | 0210-00             | 4                |
| ZB114K5E-TW*   |                 |                |               |                |            |                | NOTE 2A         | 527-0158-00    | 0210-00             | 4                |
| ZB114KC(E)-TE* |                 |                |               |                |            |                | NOTE 3          | 527-0158-00    | 0210-00             | 4                |
| ZB114KC(E)-TW* |                 |                |               |                |            |                | NOTE 2A         | N/A            | 0210-00             | 4                |
| ZB135KCP-TE*   |                 |                |               |                |            |                | NOTE 3          | N/A            | 0178-00             | 4                |
| ZB172KCP-TE*   |                 |                |               |                |            |                | NOTE 3          | N/A            | 0175-02             | 4                |

D = Digital

**Advanced Scroll Temperature Protection (ASTP), a feature to guard scroll compressors from overheating.**

| ASTP MODELS |       |       |
|-------------|-------|-------|
| ZB50        | -     | ZR84  |
| ZB58        | ZP90  | ZR94  |
| ZB66        | ZP103 | ZR108 |
| ZB76        | ZP120 | ZR125 |
| ZB88        | ZP137 | ZR144 |
| ZB95        | ZP154 | ZR160 |
| ZB114       | ZP182 | ZR190 |

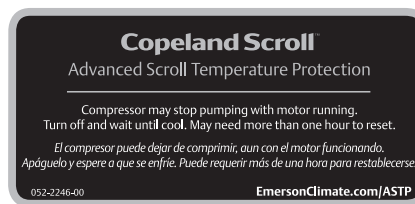

# Copeland Scroll™ Compressors – ZF

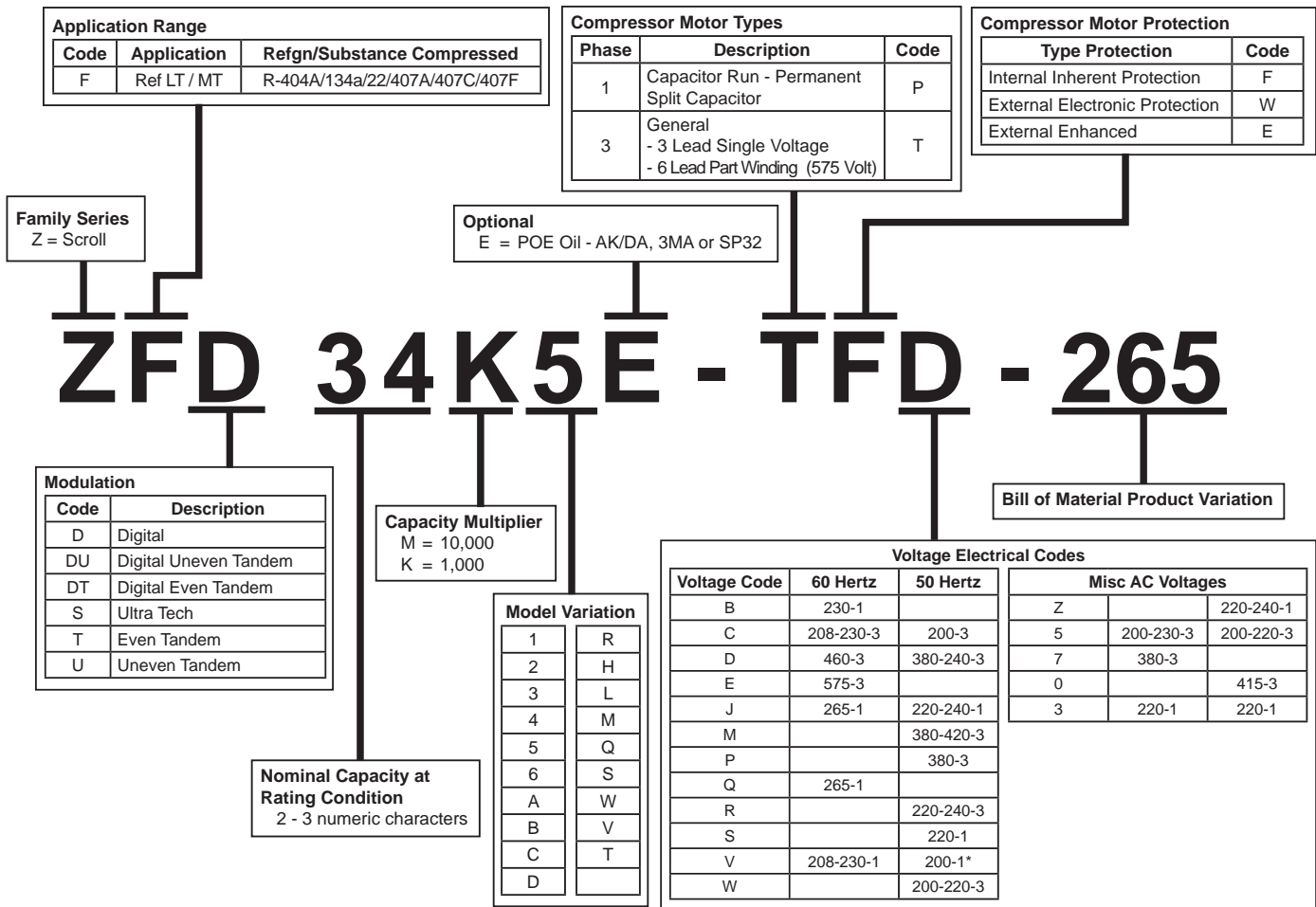

# ZF – Copeland Scroll™ Compressors

## Common Replacement Parts

| Oil Controls and Adapters  | Part Number |
|--|-------------|
| OMB Oil Control - All Models                                     | 065365      |
| Oil Management Control w/ Series Relief Connector 24V, 50/60Hz   | 65366       |
| Oil Management, OMB Adapter (3/4" NPT)                           | 65668       |
| Oil Management, OMB Adapter (1 1/4"-12 Rotalock)                 | 66650       |
| Injection Kit  | Part Number |
| Scroll Demand Cooling Kit, 120V                                  | 998-1000-50 |
| Scroll Demand Cooling Kit, 240V                                  | 998-1000-51 |
| Cap Tube Injection Kit   | Part Number |
| Scroll Demand Cooling Kit, 120V                                  | 998-1000-50 |
| Scroll Demand Cooling Kit, 240V                                  | 998-1000-51 |
| Digital Components   | Part Number |
| IDCM With 2 Minute Anti Short Cycle Delay                        | 543-0024-00 |
| IDCM Without 2 Minute Anti Short Cycle Delay                     | 543-0086-01 |
| Solenoid Coil, 24 VAC, 12" Lead Length                           | 923-0058-00 |
| Solenoid Coil, 110 VAC, 63" Lead Length                          | 923-0058-08 |
| Solenoid Coil, 220 VAC, 63" Lead Length                          | 923-0058-09 |
| IDCM Without 2 Minute Anti Short Cycle Delay With T1-T2 Resistor | 943-0086-00 |
| Digital Valve & Tubing Kit, Rotalock Models                      | 998-0066-00 |
| Digital Valve & Tubing Kit, Stub Tube/Braze Models               | 998-0073-00 |
| Closed Loop Digital Controller (Single Compressor Applications)  | 998-0189-00 |

| Discharge Line Thermostat                               | Part Number |
|---|-------------|
| 1/2" Discharge Line Thermostat                          | 998-7022-02 |
| 5/8" Discharge Line Thermostat                          | 998-7022-04 |
| 3/4" Discharge Line Thermostat                          | 998-7022-07 |
| Miscellaneous Parts                                     | Part Number |
| Oil Sight Glass Kit - All models with sight glass       | 998-0010-00 |
| Oil Adjustment (fill drain) Valve                       | 910-0715-00 |
| Terminal Block (T-block) Kit - includes terminal screws | 921-0227-00 |
| Molded Plug (for ZSKAE models)                          | 529-0060-04 |

## Crankcase Heater Notes

| Note # | OEM         | Service     | Volts | Watts       | Lead Length |
|--------|-------------|-------------|-------|-------------|-------------|
| 4      | 018-0091-21 | 918-0047-00 | 120V  | 90 WATT     | 48" LEAD    |
|        | 018-0091-22 | 918-0047-01 | 240V  |             |             |
|        | 018-0091-23 | 918-0047-02 | 480V  |             |             |
|        | 018-0091-24 | 918-0047-03 | 575V  |             |             |
|        |             | 998-7029-00 |       | CONDUIT BOX |             |
| 5A     | 018-0091-06 | 918-0056-06 | 120 V | 120 WATT    | 28" LEAD    |
|        | 018-0091-04 | 918-0056-04 | 240 V |             |             |
|        | 018-0091-05 | 918-0056-05 | 480 V |             |             |
|        | 018-0091-07 | 918-0056-07 | 575 V |             |             |
| 5B     | 018-0091-10 | 918-0056-10 | 120 V | 150 WATT    | 28" LEAD    |
|        | 018-0091-09 | 918-0056-09 | 240 V |             |             |
|        | 018-0091-08 | 918-0056-08 | 480 V |             |             |
|        | 018-0091-11 | 918-0056-11 | 575 V |             |             |
| 6      | 018-0094-00 | 918-0052-00 | 240V  | 40 WATT     | 21" LEAD    |
|        | 018-0094-01 | 918-0052-01 | 120V  |             |             |
| 7      | 018-0095-00 |             | 240V  | 70 WATT     | 29" LEAD    |
|        | 018-0095-01 |             | 480V  |             |             |
|        | 018-0095-02 |             | 575V  |             |             |
|        | 018-0095-04 | 918-0043-00 | 240V  |             |             |
|        | 018-0095-05 | 918-0043-01 | 480V  |             | 48" LEAD    |
|        | 018-0095-06 | 918-0043-02 | 575V  |             |             |
|        | 018-0095-07 | 918-0043-07 | 120V  |             |             |
|        |             |             |       |             |             |
| 9      | 018-0091-17 | 918-0019-01 | 120V  | 70 WATT     | 30" LEAD    |
|        | 018-0091-18 | 918-0019-04 | 240V  |             |             |
|        | 018-0091-19 | 918-0019-08 | 460V  | 60 WATT     |             |
|        | 018-0091-15 | 918-0019-09 | 575V  |             |             |
| 10     | 018-0096-02 | 918-0041-02 | 120 V | 40 WATT     | 28" LEAD    |
|        | 018-0096-00 | 918-0041-00 | 240 V |             |             |
|        | 018-0096-01 | 918-041-01  | 480 V |             |             |
|        | 018-0096-03 | 918-0041-03 | 575 V |             |             |



# ZF – Copeland Scroll™ Compressors

## ZF - Compressor Parts

| Model          | Start Capacitor |         | Run Capacitor |         | Relay   |         | Motor Protec-tor | Mounting Parts (527-) | Hard Mounting Parts | CH * | Sight-glass Kit (998-) |
|----------------|-----------------|---------|---------------|---------|---------|---------|------------------|-----------------------|---------------------|------|------------------------|
|                | OEM             | Service | OEM           | Service | OEM     | Service |                  |                       |                     |      |                        |
|                | (014-)          | (914-)  | (014-)        | (914-)  | (040-)  | (940-)  |                  |                       |                     |      |                        |
| ZF06K4(E)-PFV* | 0061-27         | 0036-03 | 0064-08       | 0037-12 | 0166-37 | 0001-79 | IP               | 0116-00               | 998-0178-00         | 7    | 0010-02                |
| ZF06K4(E)-TF*  |                 |         |               |         |         |         | IP               | 0116-00               | 998-0178-00         | 7    | 0010-02                |
| ZF08K4(E)-PFV* | 0061-27         | 0036-03 | 0064-25       | 0037-36 | 0116-37 | 0001-79 | IP               | 0116-00               | 998-0178-00         | 7    | 0010-02                |
| ZF08K4(E)-TF*  |                 |         |               |         |         |         | IP               | 0116-00               | 998-0178-00         | 7    | 0010-02                |
| ZF09K4(E)-PFV* | 0061-27         | 0036-03 | 0064-29       | 0037-40 | 0166-37 | 0001-79 | IP               | 0116-00               | 998-0178-00         | 7    | 0010-02                |
| ZF09K4(E)-TF*  |                 |         |               |         |         |         | IP               | 0116-00               | 998-0178-00         | 7    | 0010-02                |
| ZF11K4(E)-PFV* | 0061-27         | 0036-03 | 0064-26       | 0037-37 | 0166-37 | 0001-79 | IP               | 0116-00               | 998-0178-00         | 7    | 0010-02                |
| ZF11K4(E)-TF*  |                 |         |               |         |         |         | IP               | 0116-00               | 998-0178-00         | 7    | 0010-02                |
| ZF13K4(E)-PFV* | 0006-15         | 0006-10 | 0064-26       | 0037-37 | 0166-37 | 0001-79 | IP               | 0116-00               | 527-0158-00         | 7    | 0010-02                |
| ZF13K4(E)-TF*  |                 |         |               |         |         |         | IP               | 0116-00               | 527-0158-00         | 7    | 0010-02                |
| ZF13KVE-TF*    |                 |         |               |         |         |         | IP               | 0116-00               | 527-0158-00         | 7    | 0010-02                |
| D ZFD13KVE-TF* |                 |         |               |         |         |         |                  | 0116-00               | 527-0158-00         |      | 0010-02                |
| ZF15K4(E)-PFV* | 0006-15         | 0006-10 | 0064-27       | 0037-38 | 0166-37 | 0001-79 | IP               | 0116-00               | 527-0158-00         | 7    | 0010-02                |
| ZF15K4(E)-TF*  |                 |         |               |         |         |         | IP               | 0116-00               | 527-0158-00         | 7    | 0010-02                |
| ZF18K4(E)-TF*  |                 |         |               |         |         |         | IP               | 0116-00               | 527-0158-00         | 7    | 0010-02                |
| ZF18KVE-TF*    |                 |         |               |         |         |         | IP               | 0116-00               | 527-0158-00         | 7    | 0010-02                |
| D ZFD18KVE-TF* |                 |         |               |         |         |         | IP               | 0116-00               | 527-0158-00         | 7    | 0010-02                |
| ZF24K4(E)-TW*  |                 |         |               |         |         |         | NOTE 2B          | 0159-00               | 527-0158-00         | 9    | 0010-02                |
| ZF24KVE-TW*    |                 |         |               |         |         |         | NOTE 2B          | 0159-00               | 527-0158-00         | 9    | 0010-02                |
| ZF25K4E-TF*    |                 |         |               |         |         |         | IP               | 0116-00               | 527-0158-00         | 7    | 0010-02                |
| ZF25KVE-TF*    |                 |         |               |         |         |         | IP               | 0116-00               | 527-0158-00         | 7    | 0010-02                |
| D ZFD25KVE-TF* |                 |         |               |         |         |         | IP               | 0116-00               | 527-0158-00         | 7    | 0010-02                |
| ZF33K4(E)-TW*  |                 |         |               |         |         |         | NOTE 2B          | 0159-00               | 527-0158-00         | 9    | 0010-02                |
| ZF33KVE-TW*    |                 |         |               |         |         |         | NOTE 2B          | 0159-00               | 527-0158-00         | 9    | 0010-02                |
| ZF34K5E-TF*    |                 |         |               |         |         |         | IP               | 0210-00               | 998-0178-00         | 4    | 0010-02                |
| ZF40K4(E)-TW*  |                 |         |               |         |         |         | NOTE 2B          | 0159-00               | 527-0158-00         | 9    | 0010-02                |
| ZF40KVE-TW*    |                 |         |               |         |         |         | NOTE 2B          | 0159-00               | 527-0158-00         | 9    | 0010-02                |
| ZF41K5E-TF*    |                 |         |               |         |         |         | IP               | 0210-00               | 998-0178-00         | 4    | 0010-02                |
| ZF48K4(E)-TW*  |                 |         |               |         |         |         | NOTE 2B          | 0159-00               | 527-0158-00         | 9    | 0010-02                |
| ZF48KVE-TW*    |                 |         |               |         |         |         | NOTE 2B          | 0159-00               | 527-0158-00         | 9    | 0010-02                |
| ZF49K5E-TF*    |                 |         |               |         |         |         | IP               | 0210-00               | 998-0178-00         | 4    | 0010-02                |
| ZF49K5E-TW*    |                 |         |               |         |         |         | NOTE 2A          | 0210-00               | 998-0178-00         | 4    | 0010-02                |
| ZF54K5E-TF*    |                 |         |               |         |         |         | IP               | 0210-00               | 998-0178-00         | 4    | 0010-02                |
| ZF54K5E-TW*    |                 |         |               |         |         |         | NOTE 2A          | 0210-00               | 998-0178-00         | 4    | 0010-02                |

D = Digital

\* Crankcase Heater Note

# Copeland Scroll™ CO<sub>2</sub> Compressors – ZO

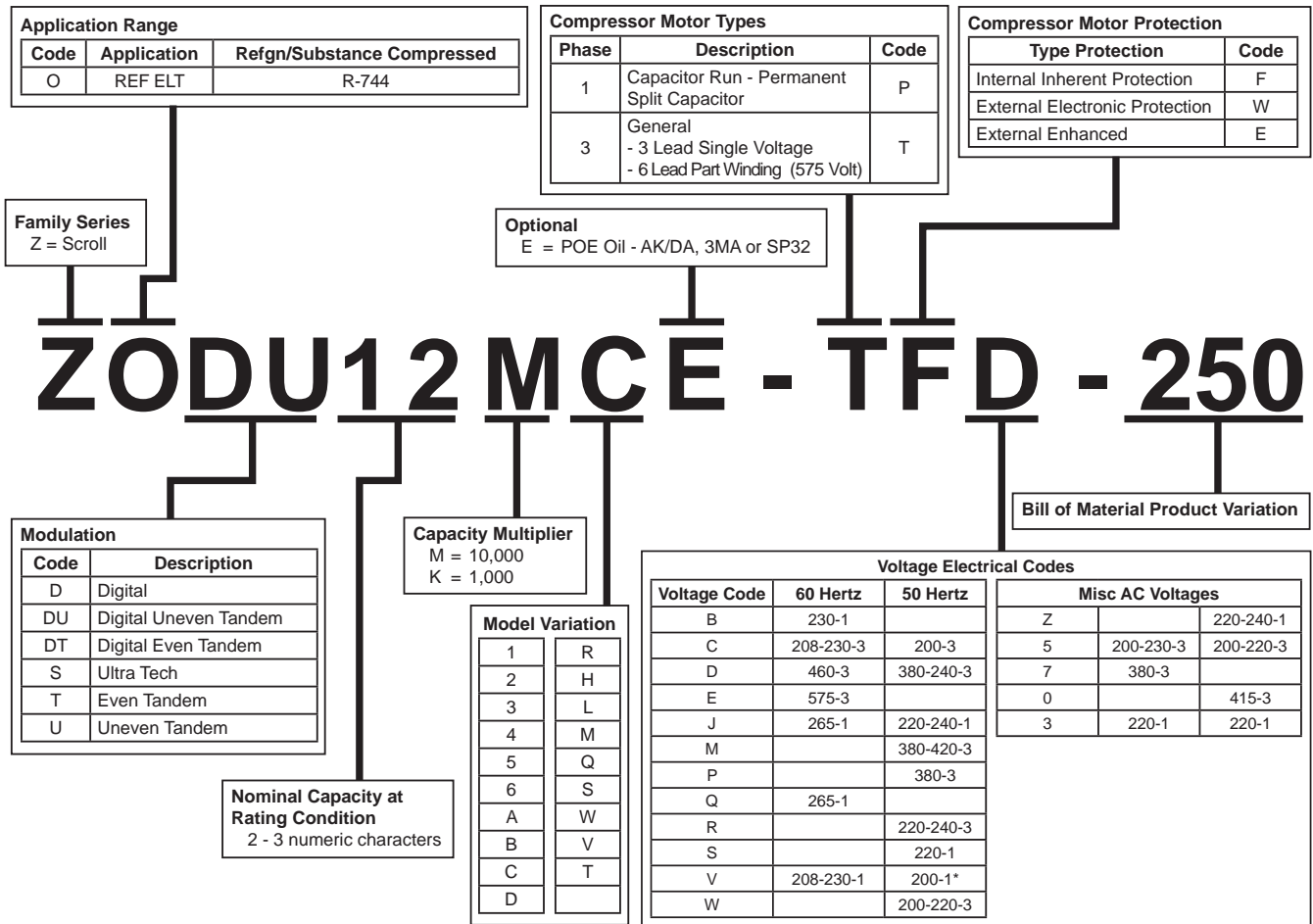



# ZO – Copeland Scroll™ CO<sub>2</sub> Compressors

## Common Replacement Parts

| Oil Controls and Adapters  | Part Number   |
|--|---|
| O MB Oil - All Models  | 065365  |
| ZOD104KCE, ZOD34K3E  | Int. Thread (3/4" NPT)-065668                             |
| ZOD34K3E   | Ext. Thread (1 1/4-12UNF)-066650                          |
| Oil Management Control   | 65365   |
| O MB Adapters  | Sight Glass Connection-Part #                             |
| ZO88/104KCE, ZO34K3E, ZO34K3E-ZO58K3E                              | (3/4" NPT) 65668  |
| ZO88/104KCE, ZO34K3E, ZO34K3E-ZO58K3E                              | Oil Management, OMB Adapter<br>(1 1/4"-12 Rotalock) 66650 |
| Discharge Line Thermostat  | Part Number   |
| 1/2" Discharge Line Thermostat                                     | 998-0540-02   |
| 5/8" Discharge Line Thermostat                                     | 998-7022-04   |
| 3/4" Discharge Line Thermostat                                     | 998-0548-01   |
| Digital Components   | Part Number   |
| Solenoid Coil, 24 VAC, 12" Lead Length                             | 923-0058-00   |
| Solenoid Coil, 110 VAC, 63" Lead Length                            | 923-0058-08   |
| Solenoid Coil, 220 VAC, 63" Lead Length                            | 923-0058-09   |
| DCM without 2 minute anti-short-cycle delay<br>with T1-T2 resistor | 943-0086-00   |
| Digital Valve & Tubing Kit, Rotalock Models                        | 998-0066-00   |
| Miscellaneous Parts  | Part Number   |
| ALL REF SCROLL SG KIT  | 998-0010-02   |
| Dual High and Low Pressure Cut-Out Control                         | 085-CP2M-7K   |
| Suction High Pressure Pop Off Valve (500 psi)                      | 510-0730-01   |
| Oil Sight Glass Kit - All models with sightglass                   | 998-0010-02   |
| Oil Adjustment Valve Kit   | 910-0715-00   |
| Suction High Pressure Pop Off Valve (500 psi)                      | 510-0730-01   |
| 1 Gallon Can Ultra RL68HB CO2 Oil - US                             | 998-E068-01   |

## Crankcase Heater Notes

| Note # | OEM         | Service     | Volts | Watts   | Lead Length |
|--------|-------------|-------------|-------|---------|-------------|
| 6      | 018-0094-01 | 918-0052-01 | 120V  | 40 WATT | 21" LEAD    |
|        | 018-0094-00 | 918-0052-00 | 240V  |         |             |
| 7      | 018-0095-00 |             | 240V  | 70 WATT | 29" LEAD    |
|        | 018-0095-01 |             | 480V  |         |             |
|        | 018-0095-02 |             | 575V  |         |             |
|        | 018-0095-04 | 918-0043-00 | 240V  |         | 48" LEAD    |
|        | 018-0095-05 | 918-0043-01 | 480V  |         |             |
|        | 018-0095-06 | 918-0043-02 | 575V  |         |             |
|        | 018-0095-07 | 918-0043-07 | 120V  |         |             |

# Copeland Scroll™ CO<sub>2</sub> Compressors – ZO

## ZO Compressor Parts

| Model         | Motor Protector | Mounting Parts | Hard Mounting Parts | Crankcase Heater | Sight-Glass Kit |
|---------------|-----------------|----------------|---------------------|------------------|-----------------|
|               |                 | (527-)         |                     |                  | (998-)          |
| ZO21K5E-TF5   | IP              | 0044-15        |                     | 6                | 0010-02         |
| ZO21K5E-TF7   | IP              | 0044-15        |                     | 6                | 0010-02         |
| ZO21K5E-TFD   | IP              | 0044-15        |                     | 6                | 0010-02         |
| ZO34K3E-TF5   | IP              | 0116-00        | 998-0178-00         | 7                | 0010-02         |
| ZO34K3E-TF7   | IP              | 0116-00        | 998-0178-00         | 7                | 0010-02         |
| ZO34K3E-TFD   | IP              | 0116-00        | 998-0178-00         | 7                | 0010-02         |
| ZO34K3E-TFE   | IP              | 0116-00        | 998-0178-00         | 7                | 0010-02         |
| ZOD34K3E-TF5  | IP              | 0116-00        | 998-0178-00         | 7                | 0010-02         |
| ZOD34K3E-TF7  | IP              | 0116-00        | 998-0178-00         | 7                | 0010-02         |
| ZOD34K3E-TFD  | IP              | 0116-00        | 998-0178-00         | 7                | 0010-02         |
| ZOD34K3E-TFE  | IP              | 0116-00        | 998-0178-00         | 7                | 0010-02         |
| ZO45K3E-TF5   | IP              | 0116-00        | 998-0178-00         | 7                | 0010-02         |
| ZO45K3E-TFD   | IP              | 0116-00        | 998-0178-00         | 7                | 0010-02         |
| ZO45K3E-TFE   | IP              | 0116-00        | 998-0178-00         | 7                | 0010-02         |
| ZO58K3E-TF7   | IP              | 0116-00        | 998-0178-00         | 7                | 0010-02         |
| ZO58K3E-TFD   | IP              | 0116-00        | 998-0178-00         | 7                | 0010-02         |
| ZO58K3E-TFE   | IP              | 0116-00        | 998-0178-00         | 7                | 0010-02         |
| ZO88KCE-TF5   | IP              | 0116-00        | 527-0158-00         | 7                | 0010-02         |
| ZO88KCE-TF7   | IP              | 0116-00        | 527-0158-00         | 7                | 0010-02         |
| ZO88KCE-TFD   | IP              | 0116-00        | 527-0158-00         | 7                | 0010-02         |
| ZO88KCE-TFE   | IP              | 0116-00        | 527-0158-00         | 7                | 0010-02         |
| ZO104KCE-TF5  | IP              | 0116-00        | 527-0158-00         | 7                | 0010-02         |
| ZO104KCE-TF7  | IP              | 0116-00        | 527-0158-00         | 7                | 0010-02         |
| ZO104KCE-TFD  | IP              | 0116-00        | 527-0158-00         | 7                | 0010-02         |
| ZO104KCE-TFE  | IP              | 0116-00        | 527-0158-00         | 7                | 0010-02         |
| ZOD104KCE-TF5 | IP              | 0116-00        | 527-0158-00         | 7                | 0010-02         |
| ZOD104KCE-TF7 | IP              | 0116-00        | 527-0158-00         | 7                | 0010-02         |
| ZOD104KCE-TFE | IP              | 0116-00        | 527-0158-00         | 7                | 0010-02         |

# ZP – Copeland Scroll™ Compressors

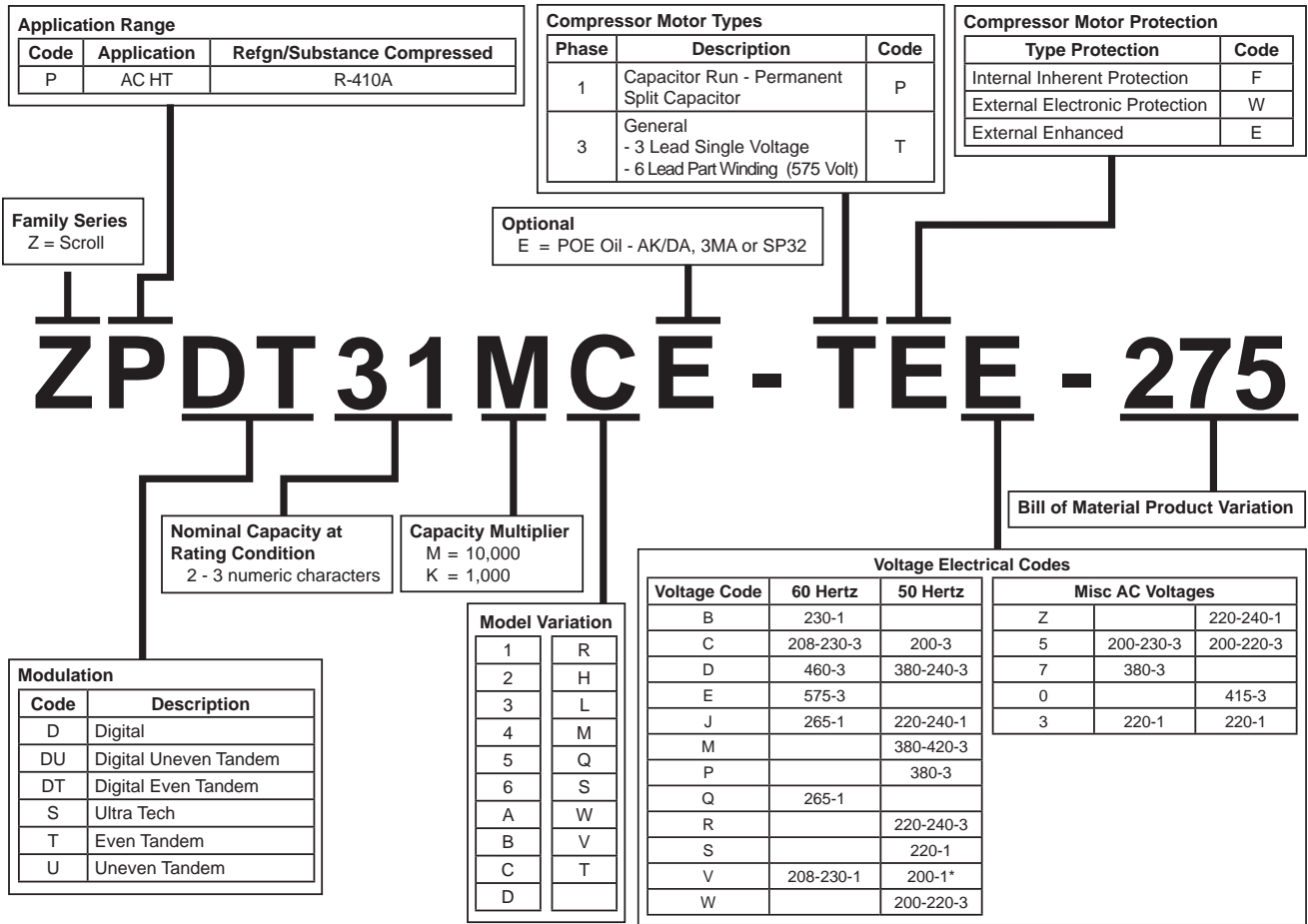

## Common Replacement Parts

| Molded Plug   | Part Number |
|---|-------------|
| 10 GA. - All K4/K4E and K5/K5E 130 or 830 BOM compressors | 529-0060-04 |
| Miscellaneous Parts                                       | Part Number |
| Oil Sight Glass Kit - All models with sight glass         | 998-0010-00 |
| Oil Adjustment (fill drain) Valve                         | 910-0715-00 |
| Terminal Block (T-block) Kit - includes terminal screws   | 921-0227-00 |

## Motor Protector Modules

| Note # | OEM         | Service     | Voltage  |
|--------|-------------|-------------|----------|
| 2A     | 071-0660-01 | 971-0641-01 | 24V      |
| 2A     | 071-0660-00 | 971-0641-00 | 120/240V |
| 2D     | 071-0649-01 | 998-0520-04 | 24V      |
| 2D     | 071-0649-00 | 998-0520-00 | 120/240V |

## CoreSense Communication Motor Protector

| Note # | OEM         | Service     | Voltage  |
|--------|-------------|-------------|----------|
| 3      | 571-0064-06 | 971-0064-05 | 120/240V |
| 3      | 571-0065-05 | 971-0065-04 | 24V      |

## Crankcase Heater Notes

| Note # | OEM         | Service     | Volts | Watts    | Lead Length |
|--------|-------------|-------------|-------|----------|-------------|
| 4      | 018-0091-21 | 918-0047-00 | 120V  | 90 WATT  | 48" LEAD    |
|        | 018-0091-22 | 918-0047-01 | 240V  | 90 WATT  |             |
|        | 018-0091-23 | 918-0047-02 | 480V  | 90 WATT  |             |
|        | 018-0091-24 | 918-0047-03 | 575V  | 90 WATT  |             |
|        | 998-7029-00 | CONDUIT BOX |       |          |             |
| 5A     | 018-0091-06 | 918-0056-06 | 120V  | 120 WATT | 28" LEAD    |
|        | 018-0091-04 | 918-0056-04 | 240V  | 120 WATT |             |
|        | 018-0091-05 | 918-0056-05 | 480V  | 120 WATT |             |
|        | 018-0091-07 | 918-0056-07 | 575V  | 120 WATT |             |
| 5B     | 018-0091-10 | 918-0056-10 | 120V  | 150 WATT | 28" LEAD    |
|        | 018-0091-09 | 918-0056-09 | 240V  | 150 WATT |             |
|        | 018-0091-08 | 918-0056-08 | 480V  | 150 WATT |             |
|        | 018-0091-11 | 918-0056-11 | 575V  | 150 WATT |             |
| 6      | 018-0094-01 | 918-0052-01 | 120V  | 40 WATT  | 21" LEAD    |
|        | 018-0094-00 | 918-0052-00 | 240V  | 40 WATT  |             |
| 7      | 018-0095-00 |             | 240V  | 70 WATT  | 29" LEAD    |
|        | 018-0095-01 |             | 480V  | 70 WATT  |             |
|        | 018-0095-02 |             | 575V  | 70 WATT  |             |
|        | 018-0095-07 | 918-0043-07 | 120V  | 70 WATT  | 48" LEAD    |
|        | 018-0095-04 | 918-0043-00 | 240V  | 70 WATT  |             |
|        | 018-0095-05 | 918-0043-01 | 480V  | 70 WATT  |             |
|        | 018-0095-06 | 918-0043-02 | 575V  | 70 WATT  |             |
| 9      | 018-0091-17 | 918-0019-01 | 120V  | 70 WATT  | 30" LEAD    |
|        | 018-0091-18 | 918-0019-04 | 240V  | 70 WATT  |             |
|        | 018-0091-19 | 918-0019-08 | 460V  | 70 WATT  |             |
|        | 018-0091-15 | 918-0019-09 | 575V  | 60 WATT  |             |
| 13     | 018-0096-02 | 918-0041-02 | 120V  | 40 WATT  | 28" LEAD    |
|        | 018-0096-00 | 918-0041-00 | 240V  | 40 WATT  |             |
|        | 018-0096-01 | 918-0041-01 | 480V  | 40 WATT  |             |
|        | 018-0096-03 | 918-0041-03 | 575V  | 40 WATT  |             |

# ZP – Copeland Scroll™ Compressors

## ZP - Compressor Parts

| Model           | Start Capacitor |         | Run Capacitor |         | Relay   |         | Motor Protector | Mounting Parts (527-) | Crankcase Heater |
|-----------------|-----------------|---------|---------------|---------|---------|---------|-----------------|-----------------------|------------------|
|                 | OEM             | Service | OEM           | Service | OEM     | Service |                 |                       |                  |
|                 | (014-)          | (914-)  | (014-)        | (914-)  | (040-)  | (940-)  |                 |                       |                  |
| D ZPDT12MCE-TF* |                 |         |               |         |         |         | IP              | 0150-00               | 7                |
| D ZPDU13MCE-TFD |                 |         |               |         |         |         | IP              | 0150-00               | 7                |
| ZP14K5E-PFV*    | 0061-27         | 0036-03 | 0064-06       | 0037-10 | 0166-07 | 0140-08 | IP              | 0044-15               | 6                |
| ZP16K3E-PFV*    | 0061-27         | 0036-03 | 0064-08       | 0037-12 | 0166-37 | 0001-79 | IP              | 0116-00               | 7                |
| ZP16K5E-PFV*    | 0061-27         | 0036-03 | 0064-08       | 0037-12 | 0166-37 | 0001-79 | IP              | 0116-00               | 6                |
| D ZPDT16MCE-TF* |                 |         |               |         |         |         | IP              | 0150-00               | 7                |
| D ZPDT18MCE-TF* |                 |         |               |         |         |         | IP              | 0150-00               | 7                |
| ZP20K3E-PFV*    | 0061-27         | 0036-03 | 0064-07       | 0037-11 | 0166-37 | 0001-79 | IP              | 0116-00               | 7                |
| ZP20K3E-TF*     |                 |         |               |         |         |         | IP              | 0116-00               | 6                |
| ZP20K5E-PFV*    | 0061-27         | 0036-03 | 0064-07       | 0037-11 | 0166-37 | 0001-79 | IP              | 0116-00               | 6                |
| ZP20K5E-TF*     |                 |         |               |         |         |         | IP              | 0044-15               | 6                |
| ZP21K5E-PFV*    | 0061-27         | 0036-03 | 0064-08       | 0037-12 | 0166-37 | 0001-79 | IP              | 0116-00               | 6                |
| ZP21K5E-TF*     |                 |         |               |         |         |         | IP              | 0044-15               | 6                |
| D ZPDT21MCE-TF* |                 |         |               |         |         |         | IP              | 0177-00               | 4                |
| ZP22KCE-PFV*    | 0061-27         | 0036-03 | 0064-08       | 0037-12 | 0166-37 | 0001-79 | IP              | 0116-00               | 7                |
| ZP23K3E-PFV*    | 0061-27         | 0036-03 | 0064-08       | 0037-12 | 0166-37 | 0001-79 | IP              | 0116-00               | 7                |
| ZP23K3E-TF*     |                 |         |               |         |         |         | IP              | 0116-00               | 7                |
| ZP24K5E-PFV*    | 0061-27         | 0036-03 | 0064-08       | 0037-12 | 0166-37 | 0001-79 | IP              | 0044-15               | 6                |
| ZP24K5E-TF*     |                 |         |               |         |         |         | IP              | 0044-15               | 6                |
| D ZPDT24MCE-TF* |                 |         |               |         |         |         | IP              | 0177-00               | 4                |
| ZP25K5E-PFV*    | 0061-27         | 0036-03 | 0064-08       | 0037-12 | 0166-37 | 0001-79 | IP              | 0044-15               | 6                |
| ZP25K5E-TF*     |                 |         |               |         |         |         | IP              | 0044-15               | 6                |
| ZP26K3E-PFV*    | 0061-27         | 0036-03 | 0064-25       | 0037-36 | 0166-37 | 0001-79 | IP              | 0116-00               | 7                |
| ZP26K3E-TF*     |                 |         |               |         |         |         | IP              | 0116-00               | 7                |
| ZP26KCE-PFV*    | 0061-27         | 0036-03 | 0064-13       | 0037-17 | 0166-37 | 0001-79 | IP              | 0116-00               | 7                |
| D ZPDT27MCE-TF* |                 |         |               |         |         |         | IP              | 0177-00               | 4                |
| ZP28K5E-PFV*    | 0061-27         | 0036-03 | 0064-25       | 0037-36 | 0166-37 | 0001-79 | IP              | 0044-15               | 6                |
| ZP28K5E-TF*     |                 |         |               |         |         |         | IP              | 0044-15               | 6                |
| ZP29K5E-PFV*    | 0061-27         | 0036-03 | 0064-25       | 0037-36 | 0166-37 | 0001-79 | IP              | 0044-15               | 6                |
| ZP29K5E-TF*     |                 |         |               |         |         |         | IP              | 0044-15               | 6                |
| ZP31K5E-PFV*    | 0061-27         | 0036-03 | 0064-25       | 0037-36 | 0166-37 | 0001-79 | IP              | 0044-15               | 6                |
| ZP31K5E-TF*     |                 |         |               |         |         |         | IP              | 0044-15               | 6                |
| D ZPDT31MCE-TE* |                 |         |               |         |         |         | EP              | 0177-00               | 4                |
| ZP32K3E-PFV*    | 0061-27         | 0036-03 | 0064-25       | 0037-36 | 0166-37 | 0001-79 | IP              | 0116-00               | 7                |
| ZP32K3E-TF*     |                 |         |               |         |         |         | IP              | 0116-00               | 7                |
| ZP32KCE-PFV*    |                 |         | 0064-14       | 0037-18 |         |         | IP              | 0116-00               | 7                |
| ZP34K5E-PFV*    | 0061-27         | 0036-03 | 0064-25       | 0037-36 | 0166-37 | 0001-79 | IP              | 0116-00               | 13               |
| ZP34K5E-TF*     |                 |         |               |         |         |         | IP              | 0116-00               | 13               |
| D ZPD34K5E-TF*  |                 |         |               |         |         |         | IP              | 0116-00               | 13               |
| ZP36K3E-PFV*    | 0061-27         | 0036-03 | 0064-28       | 0037-39 | 0166-37 | 0001-79 | IP              | 0116-00               | 7                |
| ZP36K3E-TF*     |                 |         |               |         |         |         | IP              | 0116-00               | 7                |
| ZP36K5E-PFV*    | 0061-27         | 0036-03 | 0064-25       | 0037-36 | 0166-37 | 0001-79 | IP              | 0116-00               | 13               |
| ZP36K5E-TF*     |                 |         |               |         |         |         | IP              | 0116-00               | 13               |
| D ZPDT36MCE-TE* |                 |         |               |         |         |         | EP              | 0177-00               | 4                |
| ZP38K3E-PFV*    | 0061-27         | 0036-03 | 0064-28       | 0037-39 | 0166-37 | 0001-79 | IP              | 0116-00               | 7                |
| ZP38K3E-TF*     |                 |         |               |         |         |         | IP              | 0116-00               | 7                |
| ZP38K5E-PFV*    | 0061-27         | 0036-03 | 0064-25       | 0037-36 | 0166-37 | 0001-79 | IP              | 0116-00               | 13               |
| ZP38K5E-TF*     |                 |         |               |         |         |         | IP              | 0116-00               | 13               |
| ZP38KCE-PFV*    | 0061-27         | 0036-03 | 0064-14       | 0037-18 | 0166-37 | 0001-79 | IP              | 0116-00               | 7                |
| ZP39K5E-PFV*    | 0061-27         | 0036-03 | 0064-25       | 0037-36 | 0166-37 | 0001-79 | IP              | 0116-00               | 13               |

D = Digital

## ZP - Compressor Parts

| Model           | Start Capacitor |         | Run Capacitor |         | Relay   |         | Motor Protector | Mounting Parts (527-) | Crankcase Heater |
|-----------------|-----------------|---------|---------------|---------|---------|---------|-----------------|-----------------------|------------------|
|                 | OEM             | Service | OEM           | Service | OEM     | Service |                 |                       |                  |
|                 | (014-)          | (914-)  | (014-)        | (914-)  | (040-)  | (940-)  |                 |                       |                  |
| ZP39K5E-TF*     |                 |         |               |         |         |         | IP              | 0116-00               | 13               |
| ZP41K3E-PFV*    | 0061-27         | 0036-03 | 0064-26       | 0037-37 | 0166-37 | 0001-79 | IP              | 0116-00               | 7                |
| ZP41K3E-TF*     |                 |         |               |         |         |         | IP              | 0116-00               | 7                |
| ZP42K5E-PFV*    | 0061-27         | 0036-03 | 0064-34       | 0037-51 | 0166-37 | 0001-79 | IP              | 0116-00               | 13               |
| ZP42K5E-TF*     |                 |         |               |         |         |         | IP              | 0116-00               | 13               |
| D ZPDU42MCE-TE* |                 |         |               |         |         |         | EP              | 0213-00               | N/A              |
| ZP44K3E-PFV*    | 0061-27         | 0036-03 | 0064-26       | 0037-37 | 0166-37 | 0001-79 | IP              | 0116-00               | 7                |
| ZP44K3E-TF*     |                 |         |               |         |         |         | IP              | 0116-00               | 7                |
| ZP44K5E-PFV*    | 0061-27         | 0036-03 | 0064-34       | 0037-51 | 0166-37 | 0001-79 | IP              | 0116-00               | 13               |
| D ZPD42K5E-PFV* | 0061-27         | 0036-03 | 0057-01       | 0037-38 | 0166-37 | 0001-79 | IP              | 0116-00               | N/A              |
| D ZPD42K5E-PFZ  | 0061-27         | 0036-03 | 0064-27       | 0037-38 | 0166-37 | 0001-79 | IP              | 0116-00               | N/A              |
| D ZPD42K5E-TF*  |                 |         |               |         |         |         | IP              | 0116-00               | 13               |
| ZP44K5E-TF*     |                 |         |               |         |         |         | IP              | 0116-00               | 13               |
| ZP44KCE-PFV*    | 0061-27         | 0036-03 | 0064-29       | 0037-40 | 0166-37 | 0001-79 | IP              | 0116-00               | 7                |
| ZP49K5E-PFV*    | 0061-27         | 0036-03 | 0064-34       | 0037-51 | 0166-37 | 0001-79 | IP              | 0116-00               | 13               |
| ZP49K5E-TF*     |                 |         |               |         |         |         | IP              | 0116-00               | 13               |
| ZP50K3E-PFV*    | 0006-15         | 0006-10 | 0064-27       | 0037-38 | 0166-37 | 0001-79 | IP              | 0116-00               | 7                |
| ZP50K3E-TF*     |                 |         |               |         |         |         | IP              | 0116-00               | 7                |
| ZP51K5E-PFV*    | 0061-27         | 0036-03 | 0064-34       | 0037-51 | 0166-37 | 0001-79 | IP              | 0116-00               | 13               |
| ZP51K5E-TF*     |                 |         |               |         |         |         | IP              | 0116-00               | 13               |
| D ZPD51K5E-PF*  | 0061-27         | 0036-03 | 0057-01       | 0037-51 | 0166-37 | 0001-79 | IP              | 0116-00               | 13               |
| D ZPD51K5E-TF*  |                 |         |               |         |         |         | IP              | 0116-00               | 13               |
| ZP54K3E-PFV*    | 0006-15         | 0006-10 | 0064-27       | 0037-38 | 0166-37 | 0001-79 | IP              | 0116-00               | 7                |
| ZP54K3E-TF*     |                 |         |               |         |         |         | IP              | 0116-00               | 7                |
| ZP54K5E-PFV*    | 0061-27         | 0036-03 | 0064-27       | 0037-38 | 0166-37 | 0001-79 | IP              | 0116-00               | 13               |
| D ZPD54K5E-PFV  | 0061-27         | 0036-03 | 0057-01       | 0037-38 | 0166-37 | 0001-79 | IP              | 0116-00               | 13               |
| ZP54K5E-TF*     |                 |         |               |         |         |         | IP              | 0116-00               | 13               |
| D ZPD54K5E-TF*  |                 |         |               |         |         |         | IP              | 0116-00               | 13               |
| ZP57K3E-PFV*    | 0006-15         | 0006-10 | 0064-27       | 0037-38 | 0166-37 | 0001-79 | IP              | 0116-00               | 7                |
| ZP57K3E-TF*     |                 |         |               |         |         |         | IP              | 0116-00               | 7                |
| ZP57K5E-PFV*    | 0061-27         | 0036-03 | 0064-27       | 0037-38 | 0166-37 | 0001-79 | IP              | 0116-00               | 13               |
| ZP57K5E-TF*     |                 |         |               |         |         |         | IP              | 0116-00               | 13               |
| ZP57KCE-PFV*    | 0006-15         | 0006-10 | 0064-27       | 0037-38 | 0166-37 | 0001-79 | IP              | 0116-00               | 7                |
| ZP57KCE-TF*     |                 |         |               |         |         |         | IP              | 0116-00               | 7                |
| ZP61K5E-PFV*    | 0061-27         | 0036-03 | 0064-27       | 0037-38 | 0166-37 | 0001-79 | IP              | 0116-00               | 13               |
| ZP61K5E-TF*     |                 |         |               |         |         |         | IP              | 0116-00               | 13               |
| ZP61KCE-TF*     |                 |         |               |         |         |         | IP              | 0116-00               | 7                |
| D ZPD61KCE-TFE* |                 |         |               |         |         |         | IP              | 0116-00               | 7                |
| D ZPD61KCE-TF0* |                 |         |               |         |         |         | IP              | 0221-00               | N/A              |
| D ZPD61KCE-TF5  |                 |         |               |         |         |         | IP              | 0116-00               | 7                |
| ZP67KCE-PFV*    | 0006-15         | 0006-10 | 0064-35       | 0037-52 | 0166-28 | 0001-69 | IP              | 0116-00               | 7                |
| ZP67KCE-TF*     |                 |         |               |         |         |         | IP              | 0116-00               | 7                |
| D ZPD67KCE-PFZ* | 0006-17         |         | 0064-40       |         | 0166-28 |         | IP              | 0116-00               | 7                |
| ZP70KWE-PFV*    | 0006-15         | 0006-10 | 0064-27       | 0037-38 | 0166-37 | 0001-79 | IP              | 0116-00               | 7                |
| ZP72KCE-PFV*    | 0006-15         | 0006-10 | 0064-35       | 0037-52 | 0166-28 | 0001-69 | IP              | 0116-00               | 7                |
| ZP72KCE-TF*     |                 |         |               |         |         |         | IP              | 0116-00               | 7                |
| D ZPD72KCE-TF0  |                 |         |               |         |         |         | IP              | 0116-00               | 7                |
| ZP76KCE-TF*     |                 |         |               |         |         |         | IP              | 0116-00               | 7                |
| ZP83KCE-TF*     |                 |         |               |         |         |         | IP              | 0116-00               | 7                |
| D ZPD83KCE-TFD* |                 |         |               |         |         |         | IP              | 0116-00               | 7                |

D = Digital



# ZP – Copeland Scroll™ Compressors

## ZP - Compressor Parts

| Model           | Start Capacitor |         | Run Capacitor |         | Relay   |         | Motor Protector | Mounting Parts (527-) | Crankcase Heater |
|-----------------|-----------------|---------|---------------|---------|---------|---------|-----------------|-----------------------|------------------|
|                 | OEM             | Service | OEM           | Service | OEM     | Service |                 |                       |                  |
|                 | (014-)          | (914-)  | (014-)        | (914-)  | (040-)  | (940-)  |                 |                       |                  |
| D ZPD83KCE-TFE  |                 |         |               |         |         |         | IP              | 0116-00               | 7                |
| D ZPD83KCE-TF5  |                 |         |               |         |         |         | IP              | 0116-00               | 7                |
| D ZPD83KCE-TF7  |                 |         |               |         |         |         | IP              | 0116-00               | 7                |
| D ZPD83KCE-TF0  |                 |         |               |         |         |         | IP              | 0221-00               | N/A              |
| ZP83KWE-PFV*    | 0053-30         | 0053-14 | 0064-35       | 0037-52 | 0166-02 | 0140-03 | IP              | 0116-00               | 7                |
| ZP83KWE-TF*     |                 |         |               |         |         |         | IP              | 0116-00               | 7                |
| ZP90KCE-TF*     |                 |         |               |         |         |         | IP              | 0116-00               | 4                |
| ZP91KCE-TF*     |                 |         |               |         |         |         | IP              | 0221-00               | 7                |
| D ZPD91KCE-TF*  |                 |         |               |         |         |         | IP              | 0116-00               | 7                |
| ZP103KCE-TF*    |                 |         |               |         |         |         | IP              | 0210-00               | 4                |
| D ZPD103KCE-TF* |                 |         |               |         |         |         | IP              | 0116-00               | 4                |
| D ZPD103KCE-TF* |                 |         |               |         |         |         | IP              | 0116-00               | 4                |
| ZP104KCE-TF*    |                 |         |               |         |         |         | IP              | 0221-00               | 7                |
| ZP120KCE-TF*    |                 |         |               |         |         |         | IP              | 0210-00               | 4                |
| D ZPD120KCE-TF* |                 |         |               |         |         |         | IP              | 0116-00               | 4                |
| ZP122KCE-TF*    |                 |         |               |         |         |         | IP              | 0221-00               | 7                |
| ZP137KCE-TF*    |                 |         |               |         |         |         | IP              | 0210-00               | 4                |
| D ZPD137KCE-TF* |                 |         |               |         |         |         | IP              | 0116-00               | 4                |
| ZP154KCE-TE*    |                 |         |               |         |         |         | NOTE 3          | 0210-00               | 4                |
| ZP154KCE-TW*    |                 |         |               |         |         |         | NOTE 2D         | 0210-00               | 4                |
| D ZPD154KCE-TE* |                 |         |               |         |         |         | EP              | 0210-00               | 4                |
| D ZPD154KCE-TF* |                 |         |               |         |         |         | IP              | 0210-00               | 4                |
| ZP180KCE-TW*    |                 |         |               |         |         |         | NOTE 2A         | 0159-00               | 9                |
| ZP181KCE-TW*    |                 |         |               |         |         |         | NOTE 2D         | 0210-00               | 4                |
| D ZPD181KCE-TE* |                 |         |               |         |         |         | EP              | 0210-00               | 4                |
| ZP182KCE-TE*    |                 |         |               |         |         |         | NOTE 3          | 0210-00               | 4                |
| ZP182KCE-TW*    |                 |         |               |         |         |         | NOTE 2D         | 0210-00               | 4                |
| D ZPD182KCE-TE* |                 |         |               |         |         |         | EP              | 0210-00               | 4                |
| D ZPD182KCE-TF* |                 |         |               |         |         |         | IP              | N/A                   | N/A              |
| ZP235KCE-TE*    |                 |         |               |         |         |         | NOTE 3          | 0175-02               | 5A               |
| ZP235KCE-TW*    |                 |         |               |         |         |         | NOTE 2A         | 0175-02               | 5A               |
| ZP236KCE-TE*    |                 |         |               |         |         |         | NOTE 2C         | 0175-02               | 5A               |
| ZP285KCE-TE*    |                 |         |               |         |         |         | NOTE 3          | 0175-00               | 5B               |
| ZP285KCE-TW*    |                 |         |               |         |         |         | NOTE 2A         | 0175-00               | 5B               |
| ZP295KCE-TE*    |                 |         |               |         |         |         | NOTE 3          | 0175-00               | 5B               |
| ZP295KCE-TW*    |                 |         |               |         |         |         | NOTE 2A         | 0175-02               | 5B               |
| ZP296KCE-TE*    |                 |         |               |         |         |         | NOTE 3          | 0175-02               | 5A               |
| ZP385KCE-TE*    |                 |         |               |         |         |         | NOTE 3          | 0175-02               | 5B               |
| ZP385KCE-TW*    |                 |         |               |         |         |         | NOTE 2A         | 0175-02               | 5B               |
| ZP485KCE-TE*    |                 |         |               |         |         |         | NOTE 3          | 0175-02               | 5B               |
| ZP485KCE-TW*    |                 |         |               |         |         |         | NOTE 2A         | 0175-02               | 5B               |
| ZPS20K4E-PFV*   | 0061-27         | 0036-03 | 0064-35       | 0037-52 | 0166-07 | 0140-08 | IP              | 0116-00               | 7                |
| ZPS20K4E-TF*    |                 |         |               |         |         |         | IP              | 0116-00               | 7                |
| ZPS20K5E-PFV*   | 0061-27         | 0036-03 | 0064-07       | 0037-11 | 0166-37 | 0001-79 | IP              | 0044-15               | 6                |
| ZPS20K5E-TF*    |                 |         |               |         |         |         | IP              | 0044-15               | 6                |
| ZPS21K5E-PFV*   | 0061-27         | 0036-03 | 0064-07       | 0037-11 | 0166-37 | 0001-79 | IP              | 0044-15               | 6                |
| ZPS25K4E-TF*    |                 |         |               |         |         |         | IP              | 0116-00               | 7                |
| ZPS26K4E-PFV*   | 0061-27         | 0036-03 | 0064-08       | 0037-12 | 0166-21 | 0001-62 | IP              | 0116-00               | 7                |
| ZPS26K4E-TF*    |                 |         |               |         |         |         | IP              | 0116-00               | 7                |
| ZPS26K5E-PFV*   | 0061-27         | 0036-03 | 0064-08       | 0037-12 | 0166-37 | 0001-79 | IP              | 0044-15               | 6                |

D = Digital

## ZP - Compressor Parts

| Model         | Start Capacitor |         | Run Capacitor |         | Relay   |         | Motor Protector | Mounting Parts (527-) | Crankcase Heater |
|---------------|-----------------|---------|---------------|---------|---------|---------|-----------------|-----------------------|------------------|
|               | OEM             | Service | OEM           | Service | OEM     | Service |                 |                       |                  |
|               | (014-)          | (914-)  | (014-)        | (914-)  | (040-)  | (940-)  |                 |                       |                  |
| ZPS26K5E-TF*  |                 |         |               |         |         |         | IP              | 0044-15               | 6                |
| ZPS30K3E-PFV* | 0061-27         | 0036-03 | 0064-12       | 0037-16 | 0166-07 | 0140-08 | IP              | 0116-00               | 7                |
| ZPS30K4E-PFV* | 0061-27         | 0036-03 | 0064-08       | 0037-12 | 0166-21 | 0001-62 | IP              | 0116-00               | 7                |
| ZPS30K4E-TF*  |                 |         |               |         |         |         | IP              | 0116-00               | 7                |
| ZPS30K5E-PFV* | 0061-27         | 0036-03 | 0064-08       | 0037-12 | 0166-37 | 0001-79 | IP              | 0044-15               | 6                |
| ZPS30K5E-TF*  |                 |         |               |         |         |         | IP              | 0044-15               | 6                |
| ZPS31K5E-PFV* | 0061-27         | 0036-03 | 0064-08       | 0037-12 | 0166-37 | 0001-79 | IP              | 0044-15               | 6                |
| ZPS35K4E-PFV* | 0061-27         | 0036-03 | 0064-25       | 0037-36 | 0166-37 | 0001-79 | IP              | 0116-00               | 7                |
| ZPS35K4E-TF*  |                 |         |               |         |         |         | IP              | 0116-00               | 7                |
| ZPS35K5E-PFV* | 0061-27         | 0036-03 | 0064-25       | 0037-36 | 0166-37 | 0001-79 | IP              | 0116-00               | 13               |
| ZPS35K5E-TF*  |                 |         |               |         |         |         | IP              | 0116-00               | 13               |
| ZPS40K3E-PFV* | 0061-27         | 0036-03 | 0064-14       | 0037-18 | 0166-37 | 0001-79 | IP              | 0116-00               | 7                |
| ZPS40K4E-PFV* | 0061-27         | 0036-03 | 0064-25       | 0037-36 | 0166-37 | 0001-79 | IP              | 0116-00               | 7                |
| ZPS40K4E-TF*  |                 |         |               |         |         |         | IP              | 0116-00               | 7                |

D = Digital

**Advanced Scroll Temperature Protection (ASTP), a feature to guard scroll compressors from overheating.**

| ASTP MODELS |       |       |
|-------------|-------|-------|
| ZB50        | -     | ZR84  |
| ZB58        | ZP90  | ZR94  |
| ZB66        | ZP103 | ZR108 |
| ZB76        | ZP120 | ZR125 |
| ZB88        | ZP137 | ZR144 |
| ZB95        | ZP154 | ZR160 |
| ZB114       | ZP182 | ZR190 |

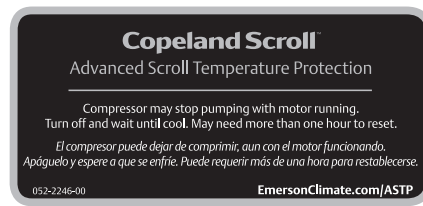

# ZP – Copeland Scroll™ Compressors

## ZPS - Compressor Parts

| Model         | Start Capacitor |         | Run Capacitor |         | Relay   |         | Motor Protec-tor | Mounting Parts | Crankcase Heater |
|---------------|-----------------|---------|---------------|---------|---------|---------|------------------|----------------|------------------|
|               | OEM             | Service | OEM           | Service | OEM     | Service |                  |                |                  |
|               | (014-)          | (914-)  | (014-)        | (914-)  | (040-)  | (940-)  |                  | (527-)         |                  |
| ZPS40K5E-PFV* | 0061-27         | 0036-03 | 0064-06       | 0037-10 | 0166-02 | 0140-03 | IP               | 0116-00        | 13               |
| ZPS40K5E-TF*  |                 |         |               |         |         |         | IP               | 0116-00        | 13               |
| ZPS49K4E-PFV* | 0006-15         | 0006-10 | 0064-27       | 0037-38 | 0166-07 | 0140-08 | IP               | 0116-00        | 7                |
| ZPS49K4E-TF*  |                 |         |               |         |         |         | IP               | 0116-00        | 7                |
| ZPS49K5E-PFV* | 0061-27         | 0036-03 | 0064-14       | 0037-18 | 0166-02 | 0140-03 | IP               | 0116-00        | 13               |
| ZPS49K5E-TF*  |                 |         |               |         |         |         | IP               | 0116-00        | 13               |
| ZPS51K4E-PFV* | 0006-15         | 0006-10 | 0064-27       | 0037-38 | 0166-07 | 0140-08 | IP               | 0116-00        | 7                |
| ZPS51K4E-TF*  |                 |         |               |         |         |         | IP               | 0116-00        | 7                |
| ZPS51K5E-PFV* | 0061-27         | 0036-03 | 0064-14       | 0037-18 | 0166-02 | 0140-03 | IP               | 0116-00        | 13               |
| ZPS51K5E-TF*  |                 |         |               |         |         |         | IP               | 0116-00        | 13               |
| ZPS60K4E-PFV* | 0006-15         | 0006-10 | 0064-27       | 0037-38 | 0166-07 | 0140-08 | IP               | 0116-00        | 7                |
| ZPS60K4E-TF*  |                 |         |               |         |         |         | IP               | 0116-00        | 7                |
| ZPS60K5E-PFV* | 0053-38         | 0053-07 | 0064-14       | 0037-18 | 0166-02 | 0140-03 | IP               | 0116-00        | 13               |
| ZPS60K5E-TF*  |                 |         |               |         |         |         | IP               | 0116-00        | 13               |

## ZPT - Compressor Parts

| Model          | Mounting Parts      |                           | For Crankcase Heaters and Start Components, see Compressor |
|----------------|---------------------|---------------------------|--|
|                | Compressor to Rails | Rails to Mounting Surface |  |
| ZPT88K5E-TF*   | 527-0212-00         | 527-0150-00               | ZP44K5E  |
| ZPT98K5E-PFV*  | 527-0212-00         | 527-0150-00               | ZP49K5E  |
| ZPT98K5E-TF*   | 527-0212-00         | 527-0150-00               | ZP49K5E  |
| ZPT100K3E-TF*  | 527-0181-00         | 527-0150-00               | ZP50K3E  |
| ZPT108K3E-TF*  | 527-0181-00         | 527-0150-00               | ZP54K3E  |
| ZPT108K5E-PFV* | 527-0212-00         | 527-0150-00               | ZP54K5E  |
| ZPT108K5E-TF*  | 527-0212-00         | 527-0150-00               | ZP54K5E  |
| ZPT114K3E-PFV* | 527-0181-00         | 527-0150-00               | ZP57K3E  |
| ZPT114K3E-TF*  | 527-0181-00         | 527-0150-00               | ZP57K3E  |
| ZPT114K5E-PFV* | 527-0181-00         | 527-0150-00               | ZP57K5E  |
| ZPT114K5E-TF*  | 527-0181-00         | 527-0150-00               | ZP57K5E  |
| ZPT122K5E-PFV* | 527-0181-00         | 527-0150-00               | ZP61K5E  |
| ZPT122K5E-TF*  | 527-0181-00         | 527-0150-00               | ZP61K5E  |
| ZPT122KCE-TF*  | 527-0181-00         | 527-0150-00               | ZP61KCE  |
| ZPT134KCE-TF*  | 527-0181-00         | 527-0150-00               | ZP67KCE  |
| ZPT144KCE-TF*  | 527-0181-00         | 527-0150-00               | ZP72KCE  |
| ZPT152KCE-TF*  | 527-0181-00         | 527-0150-00               | ZP76KCE  |
| ZPT166KCE-TF*  | 527-0181-00         | 527-0150-00               | ZP83KCE  |
| ZPT180KCE-TF*  | 027-0385-00         | 527-0177-00               | ZP90KCE  |
| ZPT182KCE-TF*  | 527-0181-00         | 527-0150-00               | ZP91KCE  |
| ZPT206KCE-TF*  | 027-0385-00         | 527-0177-00               | ZP103KCE   |
| ZPT208KCE-TF*  | 027-0385-00         | 527-0177-00               | ZP104KCE   |
| ZPT240KCE-TF*  | 027-0385-00         | 527-0177-00               | ZP120KCE   |
| ZPT244KCE-TF*  | 027-0385-00         | 527-0177-00               | ZP122KCE   |

## ZPT - Compressor Parts

| Model         | Mounting Parts      |                           | For Crankcase Heaters and Start Components, see Compressor |
|---------------|---------------------|---------------------------|--|
|               | Compressor to Rails | Rails to Mounting Surface |  |
| ZPT274KCE-TF* | 027-0385-00         | 527-0177-00               | ZP137KCE   |
| ZPT308KCE-TE* | 027-0385-00         | 527-0177-00               | ZP154KCE-TE*   |
| ZPT308KCE-TW* | 027-0385-00         | 527-0177-00               | ZP154KCE-TW*   |
| ZPT360KCE-TW* | 527-0166-00         | 527-0177-00               | ZP180KCE   |
| ZPT364KCE-TE* | 027-0385-00         | 527-0177-00               | ZP182KCE-TE*   |
| ZPT364KCE-TW* | 027-0385-00         | 527-0177-00               | ZP182KCE-TW*   |
| ZPT470KCE-TE* | 527-0178-00         | N/A                       | ZP235KCE-TE*   |
| ZPT470KCE-TW* | 527-0178-00         | N/A                       | ZP235KCE-TW*   |
| ZPT472KCE-TE* | 527-0178-00         | N/A                       | ZP236KCE-TE*   |
| ZPT570KCE-TE* | 527-0178-00         | N/A                       | ZP285KCE-TE*   |
| ZPT570KCE-TW* | 527-0178-00         | N/A                       | ZP285KCE-TW*   |
| ZPT590KCE-TE* | 527-0178-00         | N/A                       | ZP295KCE-TE*   |
| ZPT590KCE-TW* | 527-0178-00         | N/A                       | ZP295KCE-TW*   |
| ZPT592KCE-TE* | 527-0178-00         | N/A                       | ZP296KCE-TE*   |
| ZPT770KCE-TE* | 527-0178-00         | N/A                       | ZP385KCE-TE*   |
| ZPT770KCE-TW* | 527-0178-00         | N/A                       | ZP385KCE-TW*   |
| ZPT970KCE-TE* | 527-0178-00         | N/A                       | ZP485KCE-TE*   |
| ZPT970KCE-TW* | 527-0178-00         | N/A                       | ZP485KCE-TW*   |

## ZPU - Uneven Tandems

| Model         | Motor Protector | Mounting Parts | Crankcase Heater | Model         | Motor Protector | Mounting Parts | Crankcase Heater |
|---------------|-----------------|----------------|------------------|---------------|-----------------|----------------|------------------|
|               |                 | (527-)         |                  |               |                 | (527-)         |                  |
| ZPU223KCE-TFD | IP              | 0177-00        | 4                | ZPU336KCE-TE5 | EP              | 0177-00        | 4                |
| ZPU223KCE-TFE | IP              | 0177-00        | 4                | ZPU336KCE-TE7 | EP              | 0177-00        | 4                |
| ZPU223KCE-TF5 | IP              | 0177-00        | 4                | ZPU417KCE-TEC | EP              | 0213-00        | 4                |
| ZPU223KCE-TF7 | IP              | 0177-00        | 4                | ZPU417KCE-TED | EP              | 0213-00        | 4                |
| ZPU240KCE-TFD | IP              | 0177-00        | 4                | ZPU417KCE-TEE | EP              | 0213-00        | 4                |
| ZPU240KCE-TFE | IP              | 0177-00        | 4                | ZPU417KCE-TE7 | EP              | 0213-00        | 4                |
| ZPU240KCE-TF5 | IP              | 0177-00        | 4                | ZPU418KCE-TED | EP              | 0213-00        |                  |
| ZPU240KCE-TF7 | IP              | 0177-00        | 4                | ZPU418KCE-TEE | EP              | 0213-00        |                  |
| ZPU257KCE-TFD | IP              | 0177-00        | 4                | ZPU418KCE-TE5 | EP              | 0213-00        |                  |
| ZPU257KCE-TFE | IP              | 0177-00        | 4                | ZPU418KCE-TE7 | EP              | 0213-00        |                  |
| ZPU257KCE-TF5 | IP              | 0177-00        | 4                | ZPU870KWE-TED | EP              | 0213-00        |                  |
| ZPU257KCE-TF7 | IP              | 0177-00        | 4                | ZPU870KWE-TEE | EP              | 0177-00        |                  |
| ZPU336KCE-TED | EP              | 0177-00        | 4                | ZPU870KWE-TE7 | EP              | 0178-00        |                  |
| ZPU336KCE-TEE | EP              | 0177-00        | 4                |               |                 |                |                  |

# ZR – Copeland Scroll™ Compressors

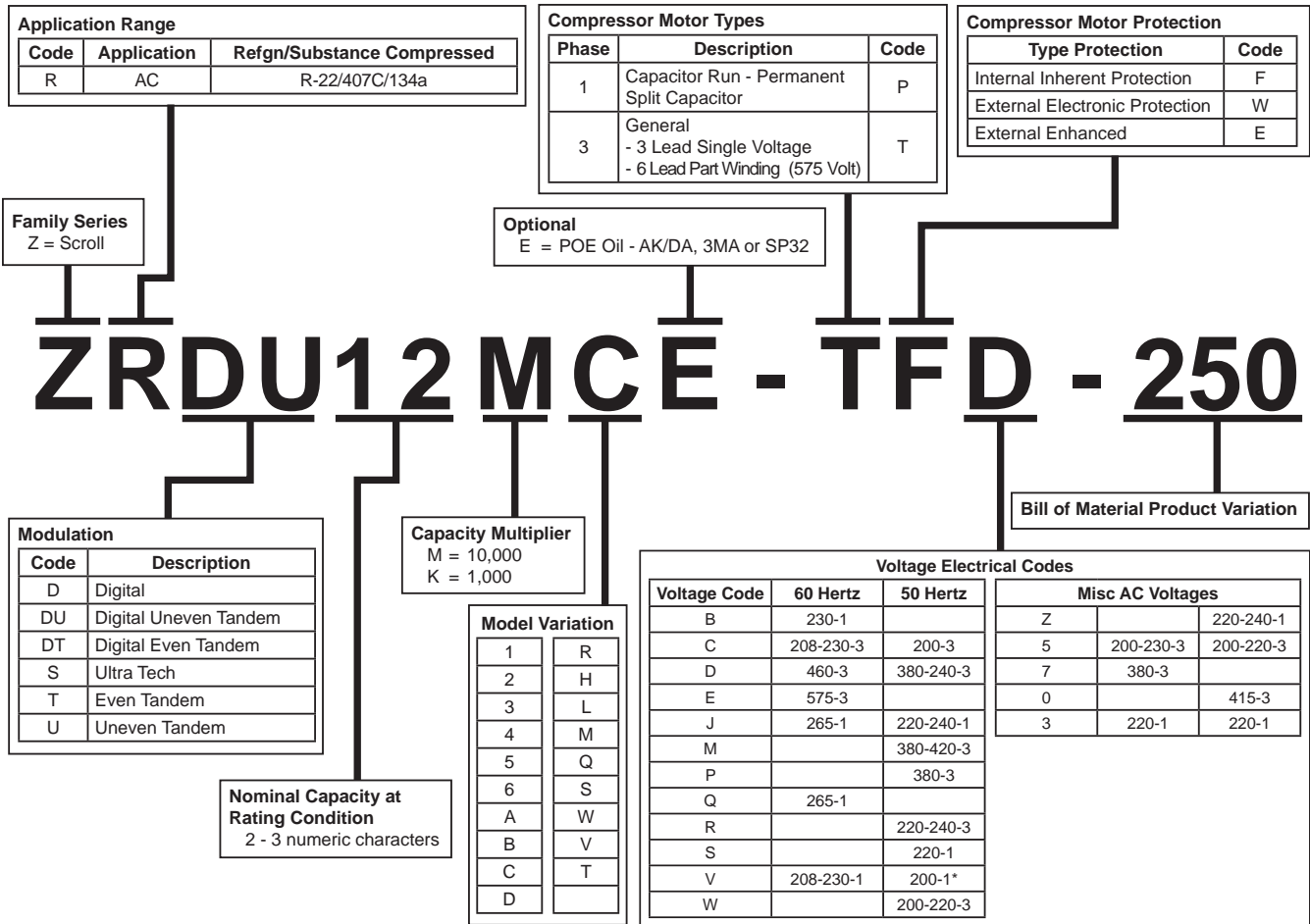

## Common Replacement Parts

| Molded Plug   | Part Number |
|---|-------------|
| 10 GA. - All K4/K4E and K5/K5E 130 or 830 BOM compressors | 529-0060-04 |
| Miscellaneous Parts                                       | Part Number |
| Oil Sight Glass Kit - All models with sight glass         | 998-0010-00 |
| Oil Adjustment (fill drain) Valve                         | 910-0715-00 |
| Terminal Block (T-block) Kit - includes terminal screws   | 921-0227-00 |
| Digital Components  | Part Number |
| Digital Copressor Controller                              | 543-0024-01 |

## Motor Protector Modules

| Note # | OEM         | Service     | Voltage  |
|--------|-------------|-------------|----------|
| 2A     | 071-0660-01 | 971-0641-01 | 24V      |
| 2A     | 071-0660-00 | 971-0641-00 | 120/240V |
| 2D     | 071-0649-01 | 998-0520-04 | 24V      |
| 2D     | 071-0649-00 | 998-0520-00 | 120/240V |

## CoreSense Communication Motor Protector

| Note # | OEM         | Service     | Voltage  |
|--------|-------------|-------------|----------|
| 3      | 571-0064-06 | 971-0064-05 | 120/240V |
| 3      | 571-0065-05 | 971-0065-04 | 24V      |

## Crankcase Heater Notes

| Note #      | OEM         | Service     | Volts | Watts    | Lead Length |
|-------------|-------------|-------------|-------|----------|-------------|
| 4           | 018-0091-21 | 918-0047-00 | 120 V | 90 WATT  | 48"LEAD     |
|             | 018-0091-22 | 918-0047-01 | 240 V |          |             |
|             | 018-0091-23 | 918-0047-02 | 480V  |          |             |
|             | 018-0091-24 | 918-0047-03 | 575 V |          |             |
|             | 998-7029-00 | CONDUIT BOX |       |          |             |
| 5A          | 018-0091-06 | 918-0056-06 | 120V  | 120 WATT | 28"LEAD     |
|             | 018-0091-04 | 918-0056-04 | 240V  |          |             |
|             | 018-0091-05 | 918-0056-05 | 480V  |          |             |
|             | 018-0091-07 | 918-0056-07 | 575V  |          |             |
| 5B          | 018-0091-10 | 918-0056-10 | 120V  | 150 WATT | 28"LEAD     |
|             | 018-0091-09 | 918-0056-09 | 240V  |          |             |
|             | 018-0091-08 | 918-0056-08 | 480V  |          |             |
|             | 018-0091-11 | 918-0056-11 | 575V  |          |             |
| 6           | 018-0094-01 | 918-0052-01 | 120V  | 40 WATT  | 21" LEAD    |
|             | 018-0094-00 | 918-0052-00 | 240V  |          |             |
| 7           | 018-0095-00 |             | 240V  | 70 WATT  | 29" LEAD    |
|             | 018-0095-01 |             | 480V  |          |             |
|             | 018-0095-02 |             | 575V  |          |             |
|             | 018-0095-07 | 918-0043-07 | 120V  |          | 48" LEAD    |
|             | 018-0095-04 | 918-0043-00 | 240V  |          |             |
|             | 018-0095-05 | 918-0043-01 | 480V  |          |             |
| 018-0095-06 | 918-0043-02 | 575V        |       |          |             |
| 9           | 018-0091-17 | 918-0019-01 | 120V  | 70 WATT  | 30" LEAD    |
|             | 018-0091-18 | 918-0019-04 | 240V  |          |             |
|             | 018-0091-19 | 918-0019-08 | 460V  |          |             |
|             | 018-0091-15 | 918-0019-09 | 575V  | 60 WATT  |             |
| 13          | 018-0096-02 | 918-0041-02 | 120V  | 40 WATT  | 28"LEAD     |
|             | 018-0096-00 | 918-0041-00 | 240V  |          |             |
|             | 018-0096-01 | 918-0041-01 | 480V  |          |             |
|             | 018-0096-03 | 918-0041-03 | 575V  |          |             |



# ZR – Copeland Scroll™ Compressors

## ZR - Compressor Parts

| Model           | Start Capacitor |         | Run Capacitor |         | Relay   |         | Motor Protector | Mounting Parts<br>(527-) | Crankcase Heater |
|-----------------|-----------------|---------|---------------|---------|---------|---------|-----------------|--------------------------|------------------|
|                 | OEM             | Service | OEM           | Service | OEM     | Service |                 |                          |                  |
|                 | (014-)          | (914-)  | (014-)        | (914-)  | (040-)  | (940-)  |                 |                          |                  |
| D ZRDU11MCE-TF* |                 |         |               |         |         |         | IP              | 0150-00                  | 7                |
| D ZRDU11MC-TF*  |                 |         |               |         |         |         | IP              | 0150-00                  | 7                |
| D ZRDT12MC-TF*  |                 |         |               |         |         |         | IP              | 0150-00                  | 7                |
| D ZRDT12MCE-TF* |                 |         |               |         |         |         | IP              | 0150-00                  | 7                |
| D ZRDU13MC-TF*  |                 |         |               |         |         |         | IP              | 0150-00                  | 7                |
| D ZRDU13MCE-TFD |                 |         |               |         |         |         | IP              | 0150-00                  | 7                |
| D ZRDT14MC-TF*  |                 |         |               |         |         |         | IP              | 0150-00                  | 7                |
| D ZRDT14MCE-TF* |                 |         |               |         |         |         | IP              | 0150-00                  | 7                |
| ZR16K4(E)-PFJ*  | 0061-27         | 0036-03 | 0064-07       | 0037-11 | 0166-37 | 0001-79 | IP              | 0044-15                  | 6                |
| ZR16K4(E)-PFV*  | 0061-27         | 0036-03 | 0064-06       | 0037-10 | 0166-37 | 0001-79 | IP              | 0044-15                  | 6                |
| ZR16K5(E)-PFV*  | 0061-27         | 0036-03 | 0064-06       | 0037-10 | 0166-37 | 0001-79 | IP              | 0044-15                  | 6                |
| ZR16K5E-PFJ*    | 0061-27         | 0036-03 | 0064-06       | 0037-10 | 0166-37 | 0001-79 | IP              | 0044-15                  | 6                |
| ZR16KC-PFV*     | 0061-27         | 0036-03 | 0064-06       | 0037-10 | 0166-37 | 0001-79 | IP              | 0044-15                  | 6                |
| D ZRDT16MC-TF*  |                 |         |               |         |         |         | IP              | 0150-00                  | 7                |
| D ZRDT16MCE-TFD |                 |         |               |         |         |         | IP              | 0150-00                  | 7                |
| D ZRDT25MC-TF5  |                 |         |               |         |         |         | IP              | 0177-00                  | 4                |
| ZR18K3(E)-PFV*  | 0061-27         | 0036-03 | 0064-06       | 0037-10 | 0166-37 | 0001-79 | IP              | 0116-00                  | 8                |
| ZR18K4(E)-PFJ*  | 0061-27         | 0036-03 | 0064-13       | 0037-17 | 0166-37 | 0001-79 | IP              | 0044-15                  | 6                |
| ZR18K4(E)-PFV*  | 0061-27         | 0036-03 | 0064-07       | 0037-11 | 0166-37 | 0001-79 | IP              | 0044-15                  | 6                |
| ZR18K5(E)-PFV*  | 0061-27         | 0036-03 | 0064-06       | 0037-10 | 0166-37 | 0001-79 | IP              | 0044-15                  | 6                |
| ZR18K5E-PFJ*    | 0061-27         | 0036-03 | 0064-06       | 0037-10 | 0166-37 | 0001-79 | IP              | 0044-15                  | 6                |
| ZR18KC-PFV*     | 0061-27         | 0036-03 | 0064-06       | 0037-10 | 0166-37 | 0001-79 | IP              | 0044-15                  | 6                |
| ZR21K5(E)-PFJ*  | 0061-27         | 0036-03 | 0064-07       | 0037-11 | 0166-15 | 0001-55 | IP              | 0044-15                  | 6                |
| ZR21K5(E)-PFV*  | 0061-27         | 0036-03 | 0064-07       | 0037-11 | 0166-37 | 0001-79 | IP              | 0044-15                  | 6                |
| ZR21K5(E)-TF*   |                 |         |               |         |         |         | IP              | 0044-15                  | 6                |
| ZR22K3(E)-PFJ*  |                 |         | 0064-14       | 0037-18 |         |         | IP              | 0116-00                  | 7                |
| ZR22K3(E)-PFV*  | 0061-27         | 0036-03 | 0064-25       | 0037-36 | 0166-37 | 0001-79 | IP              | 0116-00                  | 7                |
| ZR22K3(E)-TF*   |                 |         |               |         |         |         | IP              | 0116-00                  | 7                |
| ZR22K4(E)-PFJ*  | 0061-27         | 0036-03 | 0064-25       | 0037-36 | 0166-37 | 0001-79 | IP              | 0044-15                  | 6                |
| ZR22K4(E)-PFV*  | 0061-27         | 0036-03 | 0064-07       | 0037-11 | 0166-37 | 0001-79 | IP              | 0044-15                  | 6                |
| ZR22KC-PFV*     | 0061-27         | 0036-03 | 0064-07       | 0037-11 | 0166-37 | 0001-79 | IP              | 0044-15                  | 6                |
| ZR24K3(E)-PFJ*  | 0061-27         | 0036-03 | 0064-25       | 0037-18 | 0166-37 | 0001-79 | IP              | 0116-00                  | 7                |
| ZR24K3(E)-PFV*  | 0061-27         | 0036-03 | 0064-08       | 0037-12 | 0166-37 | 0001-79 | IP              | 0116-00                  | 7                |
| ZR24K3(E)-TF*   |                 |         |               |         |         |         | IP              | 0116-00                  | 7                |
| ZR24K4(E)-PFJ*  | 0061-27         | 0036-03 | 0064-25       | 0037-36 | 0166-37 | 0001-79 | IP              | 0044-15                  | 6                |
| ZR24K4(E)-PFV*  | 0061-27         | 0036-03 | 0064-07       | 0037-11 | 0166-37 | 0001-79 | IP              | 0044-15                  | 6                |
| ZR24KC-PFV*     | 0061-27         | 0036-03 | 0064-07       | 0037-11 | 0166-37 | 0001-79 | IP              | 0044-15                  | 6                |
| ZR25K5(E)-PFJ*  | 0061-27         | 0036-03 | 0064-13       | 0037-17 | 0166-37 | 0001-79 | IP              | 0044-15                  | 6                |
| ZR25K5(E)-PFV*  | 0061-27         | 0036-03 | 0064-08       | 0037-12 | 0166-37 | 0001-79 | IP              | 0044-15                  | 6                |
| ZR25K5(E)-TF*   |                 |         |               |         |         |         | IP              | 0044-15                  | 6                |
| D ZRDT25MCE-TFD |                 |         |               |         |         |         | IP              | 0177-00                  |                  |
| ZR26K3(E)-PFJ*  |                 |         | 0064-25       | 0037-18 |         |         | IP              | 0116-00                  | 7                |
| ZR26K3(E)-PFV*  | 0061-27         | 0036-03 | 0064-08       | 0037-12 | 0166-37 | 0001-79 | IP              | 0116-00                  | 7                |
| ZR26K3(E)-TF*   |                 |         |               |         |         |         | IP              | 0116-00                  | 7                |
| ZR26K5-PFV*     | 0061-27         | 0036-03 | 0064-25       | 0037-36 | 0166-37 | 0001-79 | IP              | 0044-15                  | 6                |
| ZR26KC-PFV*     | 0061-27         | 0036-03 | 0064-12       | 0037-16 | 0166-37 | 0001-79 | IP              | 0044-15                  | 7                |
| ZR28K3(E)-PFJ*  |                 |         | 0064-15       | 0037-19 |         |         | IP              | 0116-00                  | 7                |
| ZR28K3(E)-PFV*  | 0061-27         | 0036-03 | 0064-25       | 0037-36 | 0166-37 | 0001-79 | IP              | 0116-00                  | 7                |
| ZR28K3(E)-TF*   |                 |         |               |         |         |         | IP              | 0116-00                  | 7                |
| ZR28K5(E)-PFJ*  | 0061-27         | 0036-03 | 0064-25       | 0037-36 | 0166-37 | 0001-79 | IP              | 0044-15                  | 6                |
| ZR28K5(E)-PFV*  | 0061-27         | 0036-03 | 0064-25       | 0037-36 | 0166-37 | 0001-79 | IP              | 0044-15                  | 6                |
| ZR28K5(E)-TF*   |                 |         |               |         |         |         | IP              | 0044-15                  | 6                |

D = Digital

## ZR - Compressor Parts

| Model           | Start Capacitor |         | Run Capacitor |         | Relay   |         | Motor Protector | Mounting Parts | Crankcase Heater |
|-----------------|-----------------|---------|---------------|---------|---------|---------|-----------------|----------------|------------------|
|                 | OEM             | Service | OEM           | Service | OEM     | Service |                 |                |                  |
|                 | (014-)          | (914-)  | (014-)        | (914-)  | (040-)  | (940-)  |                 | (527-)         |                  |
| ZR28KC-PFV*     | 0061-27         | 0036-03 | 0064-13       | 0037-17 | 0166-37 | 0001-79 | IP              | 0044-15        | 7                |
| ZR28KC-TF*      |                 |         |               |         |         |         | IP              | 0044-15        | 7                |
| ZR30K3(E)-PFJ*  |                 |         | 0064-15       | 0037-19 |         |         | IP              | 0116-00        | 7                |
| ZR30K3(E)-PFV*  | 0061-27         | 0036-03 | 0064-25       | 0037-36 | 0166-37 | 0001-79 | IP              | 0116-00        | 7                |
| ZR30K3(E)-TF*   |                 |         |               |         |         |         | IP              | 0116-00        | 7                |
| ZR30KC-PFV*     | 0061-27         | 0036-03 | 0064-07       | 0037-11 | 0166-37 | 0001-79 | IP              | 0116-00        | 7                |
| ZR32K3(E)-PFJ*  |                 |         | 0064-15       | 0037-19 |         |         | IP              | 0116-00        | 7                |
| ZR32K3(E)-PFV*  | 0061-27         | 0036-03 | 0064-25       | 0037-36 | 0166-37 | 0001-79 | IP              | 0116-00        | 7                |
| ZR32K3(E)-TF*   |                 |         |               |         |         |         | IP              | 0116-00        | 7                |
| ZR32K5(E)-PFJ*  |                 |         | 0064-25       | 0037-36 |         |         | IP              | 0044-15        | 6                |
| ZR32K5(E)-PFV*  | 0061-27         | 0036-03 | 0064-29       | 0037-40 | 0166-37 | 0001-79 | IP              | 0044-15        | 6                |
| ZR32K5(E)-TF*   |                 |         |               |         |         |         | IP              | 0044-15        | 6                |
| ZR32KC-PFV*     | 0061-27         | 0036-03 | 0064-13       | 0037-17 | 0166-37 | 0001-79 | IP              | 0116-00        | 7                |
| ZR34K3(E)-PFJ*  |                 |         | 0064-16       | 0037-20 |         |         | IP              | 0116-00        | 7                |
| ZR34K3(E)-PFV*  | 0061-27         | 0036-03 | 0064-29       | 0037-40 | 0166-37 | 0001-79 | IP              | 0116-00        | 7                |
| ZR34K3(E)-TF*   |                 |         |               |         |         |         | IP              | 0116-00        | 7                |
| ZR34K5(E)-PFV*  | 0061-27         | 0036-03 | 0064-26       | 0037-37 | 0166-07 | 0140-08 | IP              | 0044-15        | 6                |
| ZR34K5-TF*      |                 |         |               |         |         |         | IP              | 0044-15        | 6                |
| ZR34KC-PFV*     | 0061-27         | 0036-03 | 0064-08       | 0037-12 | 0166-37 | 0001-79 | IP              | 0116-00        | 7                |
| ZR34KC-TF*      |                 |         |               |         |         |         | IP              | 0116-00        | 7                |
| ZR35K5-TF*      |                 |         |               |         |         |         | IP              | 0044-15        | 6                |
| ZR36K3(E)-PFJ*  |                 |         | 0064-16       | 0037-20 |         |         | IP              | 0116-00        | 7                |
| ZR36K3(E)-PFV*  | 0061-27         | 0036-03 | 0064-29       | 0037-40 | 0166-37 | 0001-79 | IP              | 0116-00        | 7                |
| ZR36K3(E)-TF*   |                 |         |               |         |         |         | IP              | 0116-00        | 7                |
| ZR36KC-PFV*     | 0061-27         | 0036-03 | 0064-14       | 0037-18 | 0166-37 | 0001-79 | IP              | 0116-00        | 7                |
| D ZRD36KCE-PF*  |                 |         | 0064-29       | 0037-40 |         |         | IP              | 0116-00        | 7 and 13         |
| ZR36KC-TF*      |                 |         |               |         |         |         | IP              | 0116-00        | 7                |
| D ZRD36KC-TF*   |                 |         |               |         |         |         | IP              | 0116-00        | 4 and 7          |
| D ZRD36KCE-TF*  |                 |         |               |         |         |         | IP              | 0116-00        | 7 and 13         |
| ZR38K5(E)-PFJ*  |                 |         | 0064-26       | 0037-37 |         |         | IP              | 0116-00        | 13               |
| ZR38K5(E)-PFV*  | 0061-27         | 0036-03 | 0064-28       | 0037-39 | 0166-37 | 0001-79 | IP              | 0116-00        | 13               |
| ZR38K5(E)-TF*   |                 |         |               |         |         |         | IP              | 0116-00        | 13               |
| ZR40K3(E)-PFJ*  |                 |         | 0064-17       | 0037-21 |         |         | IP              | 0116-00        | 7                |
| ZR40K3(E)-PFV*  | 0061-27         | 0036-03 | 0064-28       | 0037-39 | 0166-37 | 0001-79 | IP              | 0116-00        | 7                |
| ZR40K3(E)-TF*   |                 |         |               |         |         |         | IP              | 0116-00        | 7                |
| ZR40KC-PFV*     | 0061-27         | 0036-03 | 0064-14       | 0037-18 | 0166-37 | 0001-79 | IP              | 0116-00        | 7                |
| ZR40KC-TF*      |                 |         |               |         |         |         | IP              | 0116-00        | 7                |
| ZR42K3(E)-PFJ*  |                 |         | 0064-18       | 0037-22 |         |         | IP              | 0116-00        | 7                |
| ZR42K3(E)-PFV*  | 0061-27         | 0036-03 | 0064-26       | 0037-37 | 0166-37 | 0001-79 | IP              | 0116-00        | 7                |
| ZR42K3(E)-TF*   |                 |         |               |         |         |         | IP              | 0116-00        | 7                |
| ZR42K5(E)-PFJ*  |                 |         | 0064-18       | 0037-22 |         |         | IP              | 0116-00        | 13               |
| ZR42K5(E)-PFV*  | 0061-27         | 0036-03 | 0064-28       | 0037-39 | 0166-37 | 0001-79 | IP              | 0116-00        | 13               |
| ZR42K5(E)-TF*   |                 |         |               |         |         |         | IP              | 0116-00        | 13               |
| ZR42KC-PFV*     | 0061-27         | 0036-03 | 0064-14       | 0037-18 | 0166-37 | 0001-79 | IP              | 0116-00        | 7                |
| D ZRD42KCE-PFJ* | 0061-27         | 0036-03 | 0064-26       | 0037-22 | 0166-37 | 0001-79 | IP              | 0116-00        | 7 and 13         |
| ZR42KC-TF*      |                 |         |               |         |         |         | IP              | 0116-00        | 7                |
| D ZRD42KCE-TF*  |                 |         |               |         |         |         | IP              | 0116-00        | 7 and 13         |
| ZR44K5-PFV*     | 0061-27         | 0036-03 | 0064-26       | 0037-37 | 0166-37 | 0001-79 | IP              | 0116-00        | 13               |
| ZR44K5-TF*      |                 |         |               |         |         |         | IP              | 0116-00        | 13               |
| ZR45K3(E)-PFJ*  |                 |         | 0064-18       | 0037-22 |         |         | IP              | 0116-00        | 7                |
| ZR45K3(E)-PFV*  | 0061-27         | 0036-03 | 0064-28       | 0037-39 | 0166-37 | 0001-79 | IP              | 0116-00        | 7                |
| ZR45K3-TF*      |                 |         |               |         |         |         | IP              | 0116-00        | 7                |

D = Digital

# ZR – Copeland Scroll™ Compressors

## ZR - Compressor Parts

| Model           | Start Capacitor |         | Run Capacitor |         | Relay   |         | Motor Protector | Mounting Parts<br>(527-) | Crankcase Heater |
|-----------------|-----------------|---------|---------------|---------|---------|---------|-----------------|--------------------------|------------------|
|                 | OEM             | Service | OEM           | Service | OEM     | Service |                 |                          |                  |
|                 | (014-)          | (914-)  | (014-)        | (914-)  | (040-)  | (940-)  |                 |                          |                  |
| ZR45KC(E)-TF*   |                 |         |               |         |         |         | IP              | 0116-00                  | 7                |
| ZR45KC-PFV*     | 0061-27         | 0036-03 | 0064-08       | 0037-12 | 0166-37 | 0001-79 | IP              | 0116-00                  | 7                |
| ZR46K3(E)-PFV*  | 0006-15         | 0006-10 | 0064-26       | 0037-37 | 0166-37 | 0001-79 | IP              | 0116-00                  | 7                |
| ZR46K3(E)-TF*   |                 |         |               |         |         |         | IP              | 0116-00                  | 7                |
| ZR46KC(E)-TF*   |                 |         |               |         |         |         | IP              | 0116-00                  | 7                |
| ZR47K3(E)-PFJ*  |                 |         | 0064-18       | 0037-22 |         |         | IP              | 0116-00                  | 7                |
| ZR47K3(E)-PFV*  | 0061-27         | 0036-03 | 0064-18       | 0037-22 | 0166-37 | 0001-79 | IP              | 0116-00                  | 7                |
| ZR47K3(E)-TF*   |                 |         |               |         |         |         | IP              | 0116-00                  | 7                |
| ZR47KC(E)-TF*   |                 |         |               |         |         |         | IP              | 0116-00                  | 7                |
| ZR47KC-PFV*     | 0061-27         | 0036-03 | 0064-25       | 0037-36 | 0166-37 | 0001-79 | IP              | 0116-00                  | 7                |
| ZR48K3(E)-PFJ*  |                 |         | 0064-18       | 0037-22 |         |         | IP              | 0116-00                  | 7                |
| ZR48K3(E)-PFV*  | 0061-27         | 0036-03 | 0064-18       | 0037-22 | 0166-37 | 0001-79 | IP              | 0116-00                  | 7                |
| ZR48K3(E)-TF*   |                 |         |               |         |         |         | IP              | 0116-00                  | 7                |
| ZR48K5(E)-PFJ*  |                 |         | 0064-35       | 0037-52 |         |         | IP              | 0116-00                  | 13               |
| ZR48K5(E)-PFV*  | 0061-27         | 0036-03 | 0064-18       | 0037-22 | 0166-37 | 0001-79 | IP              | 0116-00                  | 13               |
| ZR48K5(E)-TF*   |                 |         |               |         |         |         | IP              | 0116-00                  | 13               |
| ZR48KC(E)-PFV*  | 0061-27         | 0036-03 | 0064-14       | 0037-18 | 0166-37 | 0001-79 | IP              | 0116-00                  | 7                |
| D ZRD48KCE-PFV* |                 |         | 0064-26       | 0037-37 |         |         | IP              | 0116-00                  | 7 and 13         |
| D ZRD48KC-TF*   |                 |         |               |         |         |         | IP              | 0116-00                  | 7 and 13         |
| ZR48KC(E)-TF*   |                 |         |               |         |         |         | IP              | 0116-00                  | 7                |
| D ZRD48KCE-TF*  |                 |         |               |         |         |         | IP              | 0116-00                  | 7 and 13         |
| ZR49K3(E)-PFV*  | 0006-15         | 0006-10 | 0064-26       | 0037-37 | 0166-37 | 0001-79 | IP              | 0116-00                  | 7                |
| ZR49K3(E)-TF*   |                 |         |               |         |         |         | IP              | 0116-00                  | 7                |
| ZR49K3-PFV*     | 0006-15         | 0006-10 | 0064-26       | 0037-37 | 0166-37 | 0001-79 | IP              | 0116-00                  | 7                |
| ZR49KC(E)-PFV*  | 0006-15         | 0006-10 | 0064-15       | 0037-19 | 0166-37 | 0001-79 | IP              | 0116-00                  | 7                |
| D ZRD49KCE-PFV* | 0006-15         |         | 0064-26       | 0037-37 | 0166-37 | 0001-79 | IP              | 0116-00                  | 7                |
| ZR49KC(E)-TF*   |                 |         |               |         |         |         | IP              | 0116-00                  | 7                |
| D ZRD49KCE-TF*  |                 |         |               |         |         |         | IP              | 0116-00                  | 7                |
| ZR51KC-TF*      |                 |         |               |         |         |         | IP              | 0116-00                  | 7                |
| ZR52K3-PFV*     | 0006-15         | 0006-10 | 0064-27       | 0037-38 | 0166-37 | 0001-79 | IP              | 0116-00                  | 7                |
| ZR52K3-TF*      |                 |         |               |         |         |         | IP              | 0116-00                  | 7                |
| ZR54K3(E)-PFV*  | 0006-15         | 0006-10 | 0064-27       | 0037-38 | 0166-37 | 0001-79 | IP              | 0116-00                  | 7                |
| ZR54K3(E)-TF*   |                 |         |               |         |         |         | IP              | 0116-00                  | 7                |
| ZR54K3-PFV*     | 0006-15         | 0006-10 | 0064-27       | 0037-38 | 0166-37 | 0001-79 | IP              | 0116-00                  | 7                |
| ZR54K5(E)-PFV*  | 0061-27         | 0036-03 | 0064-27       | 0037-38 | 0166-37 | 0001-79 | IP              | 0116-00                  | 13               |
| ZR54K5(E)-TF*   |                 |         |               |         |         |         | IP              | 0116-00                  | 13               |
| ZR54KC(E)-TF*   |                 |         |               |         |         |         | IP              | 0116-00                  | 7                |
| ZR54KC-PFV*     | 0006-15         | 0006-10 | 0064-26       | 0037-37 | 0166-37 | 0001-79 | IP              | 0116-00                  |                  |
| ZR57K3(E)-PFV*  | 0006-15         | 0006-10 | 0064-27       | 0037-38 | 0166-37 | 0001-79 | IP              | 0116-00                  | 7                |
| ZR57K3(E)-TF*   |                 |         |               |         |         |         | IP              | 0116-00                  | 7                |
| ZR57K3-PFV*     | 0006-15         | 0006-10 | 0064-27       | 0037-38 | 0166-37 | 0001-79 | IP              | 0116-00                  | 7                |
| ZR57KC(E)-TF*   |                 |         |               |         |         |         | IP              | 0116-00                  | 7                |
| ZR57KC-PFV*     | 0006-15         | 0006-10 | 0064-26       | 0037-37 | 0166-37 | 0001-79 | IP              | 0116-00                  | 7                |
| ZR61K3(E)-PFV*  | 0006-15         | 0006-10 | 0064-27       | 0037-38 | 0166-37 | 0001-79 | IP              | 0116-00                  | 7                |
| D ZRD61KCE-PFV* | 0006-15         | 0006-10 | 0064-27       | 0037-38 | 0166-37 | 0001-79 | IP              | 0116-00                  | 7                |
| ZR61K3(E)-TF*   |                 |         |               |         |         |         | IP              | 0116-00                  | 7                |
| ZR61KC(E)-PFV*  | 0006-15         | 0006-10 | 0064-34       | 0037-51 | 0166-37 | 0001-79 | IP              | 0116-00                  | 7                |
| ZR61KC(E)-TF*   |                 |         |               |         |         |         | IP              | 0116-00                  | 7                |
| D ZRD61KCE-TF*  |                 |         |               |         |         |         | IP              | 0116-00                  | 7                |
| ZR67KC-PFV*     | 0006-15         | 0006-10 | 0064-26       | 0037-37 | 0166-37 | 0001-79 | IP              | 0116-00                  | 7                |
| ZR67KW(E)-PFV*  | 0006-15         | 0006-10 | 0064-26       | 0037-37 | 0166-37 | 0001-79 | IP              | 0116-00                  | 7                |
| ZR68KC(E)-PFJ*  |                 |         | 0064-16       | 0037-20 |         |         | IP              | 0116-00                  | 7                |

D = Digital

## ZR - Compressor Parts

| Model           | Start Capacitor |         | Run Capacitor |         | Relay   |         | Motor Protector | Mounting Parts | Crankcase Heater |
|-----------------|-----------------|---------|---------------|---------|---------|---------|-----------------|----------------|------------------|
|                 | OEM             | Service | OEM           | Service | OEM     | Service |                 |                |                  |
|                 | (014-)          | (914-)  | (014-)        | (914-)  | (040-)  | (940-)  |                 | (527-)         |                  |
| ZR68KC(E)-PFV*  | 0006-15         | 0006-10 | 0064-35       | 0037-52 | 0166-37 | 0001-79 | IP              | 0116-00        | 7                |
| ZR68KC(E)-TF*   |                 |         |               |         |         |         | IP              | 0116-00        | 7                |
| ZR72KC(E)-TF*   |                 |         |               |         |         |         | IP              | 0116-00        | 7                |
| D ZRD72KCE-TF*  |                 |         |               |         |         |         | IP              | 0116-00        | 7                |
| ZR80KC-PFV*     | 0006-15         | 0006-10 | 0064-35       | 0037-52 | 0166-37 | 0001-79 | IP              | 0116-00        | 7                |
| ZR80KW-PFV*     | 0006-15         | 0006-10 | 0064-35       | 0037-52 | 0166-37 | 0001-79 | IP              | 0116-00        | 7                |
| ZR81KC(E)-TF*   |                 |         |               |         |         |         | IP              | 0116-00        | 7                |
| ZR84KC(E)-TF*   |                 |         |               |         |         |         | IP              | 0116-00        | 4                |
| ZR90K3(E)-TW*   |                 |         |               |         |         |         | NOTE 2D         | 0159-00        | 9                |
| ZR94KC(E)-TF*   |                 |         |               |         |         |         | IP              | 0116-00        | 4                |
| D ZRD94KCE-TF*  |                 |         |               |         |         |         | IP              | 0116-00        |                  |
| D ZRDT96KC-TF*  |                 |         |               |         |         |         | IP              | 0150-00        | 7 and 13         |
| ZR108KC(E)-TF*  |                 |         |               |         |         |         | IP              | 0116-00        | 4                |
| ZR11M3(E)-TW*   |                 |         |               |         |         |         | NOTE 2D         | 0159-00        | 9                |
| ZR12M3(E)-TW*   |                 |         |               |         |         |         | NOTE 2D         | 0159-00        | 9                |
| ZR125KC(E)-TF*  |                 |         |               |         |         |         | IP              | 0116-00        | 4                |
| D ZRD125KCE-TF* |                 |         |               |         |         |         | IP              | 0116-00        | 4 and 7          |
| ZR144KC(E)-TF*  |                 |         |               |         |         |         | IP              | 0116-00        | 4                |
| ZR160KC(E)-TE*  |                 |         |               |         |         |         | NOTE 3          | 0210-00        | 4                |
| ZR160KC(E)-TW*  |                 |         |               |         |         |         | NOTE 2A         | 0210-00        | 4                |
| ZR16M3(E)-TW*   |                 |         |               |         |         |         | NOTE 2D         | 0159-00        | 9                |
| ZR190KC(E)-TE*  |                 |         |               |         |         |         | NOTE 3          | 0210-00        | 4                |
| ZR190KC(E)-TW*  |                 |         |               |         |         |         | NOTE 2A         | 0210-00        | 4                |
| ZR19M3(E)-TW*   |                 |         |               |         |         |         | NOTE 2D         | 0159-00        | 9                |
| ZR250KC(E)-TE*  |                 |         |               |         |         |         | NOTE 3          | 0175-02        | 5A               |
| ZR250KC(E)-TW*  |                 |         |               |         |         |         | NOTE 2D         | 0175-02        | 5A               |
| ZR300KC(E)-TE*  |                 |         |               |         |         |         | NOTE 3          | 0175-00        | 5B               |
| ZR300KC(E)-TW*  |                 |         |               |         |         |         | NOTE 2D         | 0175-00        | 5B               |
| ZR310KC(E)-TE*  |                 |         |               |         |         |         | NOTE 3          | 0175-00        | 5B               |
| ZR310KC(E)-TW*  |                 |         |               |         |         |         | NOTE 2D         | 0175-02        | 5B               |
| ZR380KC(E)-TE*  |                 |         |               |         |         |         | NOTE 3          | 0175-00        | 5B               |
| ZR380KC(E)-TW*  |                 |         |               |         |         |         | NOTE 2D         | 0175-02        | 5B               |

D = Digital

**Advanced Scroll Temperature Protection (ASTP), a feature to guard scroll compressors from overheating.**

| ASTP MODELS |       |       |
|-------------|-------|-------|
| ZB50        | -     | ZR84  |
| ZB58        | ZP90  | ZR94  |
| ZB66        | ZP103 | ZR108 |
| ZB76        | ZP120 | ZR125 |
| ZB88        | ZP137 | ZR144 |
| ZB95        | ZP154 | ZR160 |
| ZB114       | ZP182 | ZR190 |

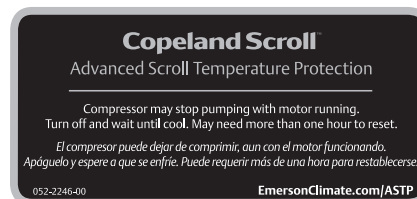

# ZR – Copeland Scroll™ Compressors

## ZRS - Compressor Parts

| Model           | Start Capacitor |         | Run Capacitor |         | Relay   |         | Motor Protector | Mounting Parts | Crankcase Heater |
|-----------------|-----------------|---------|---------------|---------|---------|---------|-----------------|----------------|------------------|
|                 | OEM             | Service | OEM           | Service | OEM     | Service |                 |                |                  |
|                 | (014-)          | (914-)  | (014-)        | (914-)  | (040-)  | (940-)  |                 | (527-)         |                  |
| ZRS35K4(E)-PFV* | 0061-27         | 0036-03 | 0064-08       | 0037-12 | 0166-21 | 0001-62 | IP              | 0116-00        | 7                |
| ZRS43K4(E)-PFV* | 0061-27         | 0036-03 | 0064-25       | 0037-36 | 0166-37 | 0001-79 | IP              | 0116-00        | 7                |
| ZRS43K4(E)-TF*  |                 |         |               |         |         |         | IP              | 0116-00        | 7                |
| ZRS52K4(E)-PFV* | 0006-17         | 0006-12 | 0064-27       | 0037-38 | 0166-07 | 0140-08 | IP              | 0116-00        | 7                |
| ZRS52K4(E)-TF*  |                 |         |               |         |         |         | IP              | 0116-00        | 7                |

## ZRU - Uneven Tandems

| Model         | Motor Protector | Mounting Parts | Crankcase Heater | Model         | Motor Protector | Mounting Parts | Crankcase Heater |
|---------------|-----------------|----------------|------------------|---------------|-----------------|----------------|------------------|
|               |                 | (527-)         |                  |               |                 | (527-)         |                  |
| ZRU140KCE-TFD | IP              | 0181-00        | 7                | ZRU350KC-TEE  | EP              | 0177-00        | 4                |
| ZRU140KCE-TF5 | IP              | 0181-00        | 7                | ZRU350KC-TE5  | EP              | 0177-00        | 4                |
| ZRU178KCE-TFD | IP              | 0177-00        | 4                | ZRU350KC-TE7  | EP              | 0177-00        | 4                |
| ZRU178KCE-TFE | IP              | 0177-00        | 4                | ZRU350KCE-TED | EP              | 0177-00        | 4                |
| ZRU178KCE-TF5 | IP              | 0177-00        | 4                | ZRU350KCE-TEE | EP              | 0177-00        | 4                |
| ZRU178KCE-TF7 | IP              | 0177-00        | 4                | ZRU350KCE-TE5 | EP              | 0177-00        | 4                |
| ZRU350KC-TED  | EP              | 0177-00        | 4                | ZRU350KCE-TE7 | EP              | 0177-00        | 4                |



## ZRT - Compressor Parts

| Model            | Mounting Parts      |                           | For Crankcase Heaters and Start Components, see Compressor |
|------------------|---------------------|---------------------------|--|
|                  | Compressor to Rails | Rails to Mounting Surface |  |
| ZRT90K3(E)-PFV*  | 527-0212-00         | 527-0150-00               | ZR45K3(E)  |
| ZRT90K3-TF*      | 527-0212-00         | 527-0150-00               | ZR45K3   |
| ZRT90KC-PFV*     | 527-0212-00         | 527-0150-00               | ZR45KC   |
| ZRT90KC-TF*      | 527-0212-00         | 527-0150-00               | ZR45KC   |
| ZRT92K3-PFV*     | 527-0212-00         | 527-0150-00               | ZR46K3   |
| ZRT92K3-TF*      | 527-0212-00         | 527-0150-00               | ZR46K3   |
| ZRT96K3(E)-PFV*  | 527-0212-00         | 527-0150-00               | ZR48K3(E)  |
| ZRT96K3(E)-TF*   | 527-0212-00         | 527-0150-00               | ZR48K3(E)  |
| ZRT96KC(E)-PFV*  | 527-0212-00         | 527-0150-00               | ZR48KC(E)  |
| ZRT96KC(E)-TF*   | 527-0212-00         | 527-0150-00               | ZR48KC(E)  |
| ZRT98K3(E)-TF*   | 527-0212-00         | 527-0150-00               | ZR49K3(E)  |
| ZRT98K3-PFV*     | 527-0212-00         | 527-0150-00               | ZR49K3   |
| ZRT108K3(E)-TF*  | 527-0212-00         | 527-0150-00               | ZR54K3(E)  |
| ZRT108K3-PFV*    | 527-0212-00         | 527-0150-00               | ZR54K3   |
| ZRT108KC-TF*     | 527-0212-00         | 527-0150-00               | ZR54KC   |
| ZRT114K3-TF*     | 527-0212-00         | 527-0150-00               | ZR57K3   |
| ZRT114K3-PFV*    | 527-0212-00         | 527-0150-00               | ZR57K3   |
| ZRT122K3(E)-PFV* | 527-0212-00         | 527-0150-00               | ZR61K3(E)  |
| ZRT122K3(E)-TF*  | 527-0212-00         | 527-0150-00               | ZR61K3(E)  |
| ZRT122KC(E)-TF*  | 527-0212-00         | 527-0150-00               | ZR61KC(E)  |
| ZRT136KC(E)-TF*  | 527-0181-00         | 527-0150-00               | ZR68KC(E)  |
| ZRT144KC(E)-TF*  | 527-0181-00         | 527-0150-00               | ZR72KC(E)  |
| ZRT162KC(E)-TF*  | 527-0181-00         | 527-0150-00               | ZR81KC(E)  |
| ZRT168KC(E)-TF*  | 027-0385-00         | 527-0177-00               | ZR84KC(E)  |
| ZRT180K3(E)-TW*  | 527-0166-00         | 527-0177-00               | ZR90K3(E)  |
| ZRT188KC(E)-TF*  | 027-0385-00         | 527-0177-00               | ZR94KC(E)  |
| ZRT216KC(E)-TF*  | 027-0385-00         | 527-0177-00               | ZR108KC(E)   |
| ZRT220K3(E)-TW*  | 527-0166-00         | 527-0177-00               | ZR11M3(E)  |
| ZRT240K3(E)-TW*  | 527-0166-00         | 527-0177-00               | ZR12M3(E)  |
| ZRT250KC(E)-TF*  | 027-0385-00         | 527-0177-00               | ZR125KC(E)   |
| ZRT288KC(E)-TF*  | 027-0385-00         | 527-0177-00               | ZR144KC(E)   |
| ZRT320K3(E)-TW*  | 527-0166-00         | 527-0177-00               | ZR160K3(E)   |
| ZRT320KC(E)-TE*  | 027-0385-00         | 527-0177-00               | ZR160KC(E)   |
| ZRT320KC(E)-TW*  | 027-0385-00         | 527-0177-00               | ZR160KC(E)   |
| ZRT380K3(E)-TW*  | 527-0166-00         | 527-0177-00               | ZR19M3(E)  |
| ZRT380KC(E)-TE*  | 027-0385-00         | 527-0177-00               | ZR190KC(E)   |
| ZRT380KC(E)-TW*  | 027-0385-00         | 527-0177-00               | ZR190KC(E)   |
| ZRT500KC(E)-TE*  | 527-0178-00         | N/A                       | ZR250KC(E)   |
| ZRT500KC(E)-TW*  | 527-0178-00         | N/A                       | ZR250KC(E)   |
| ZRT600KC(E)-TE*  | 527-0178-00         | N/A                       | ZR300KC(E)   |
| ZRT600KC(E)-TW*  | 527-0178-00         | N/A                       | ZR300KC(E)   |
| ZRT760KC(E)-TE*  | 527-0178-00         | N/A                       | ZR380KC(E)   |
| ZRT760KC(E)-TW   | 527-0178-00         | N/A                       | ZR380KC(E)   |



# ZS – Copeland Scroll™ Compressors

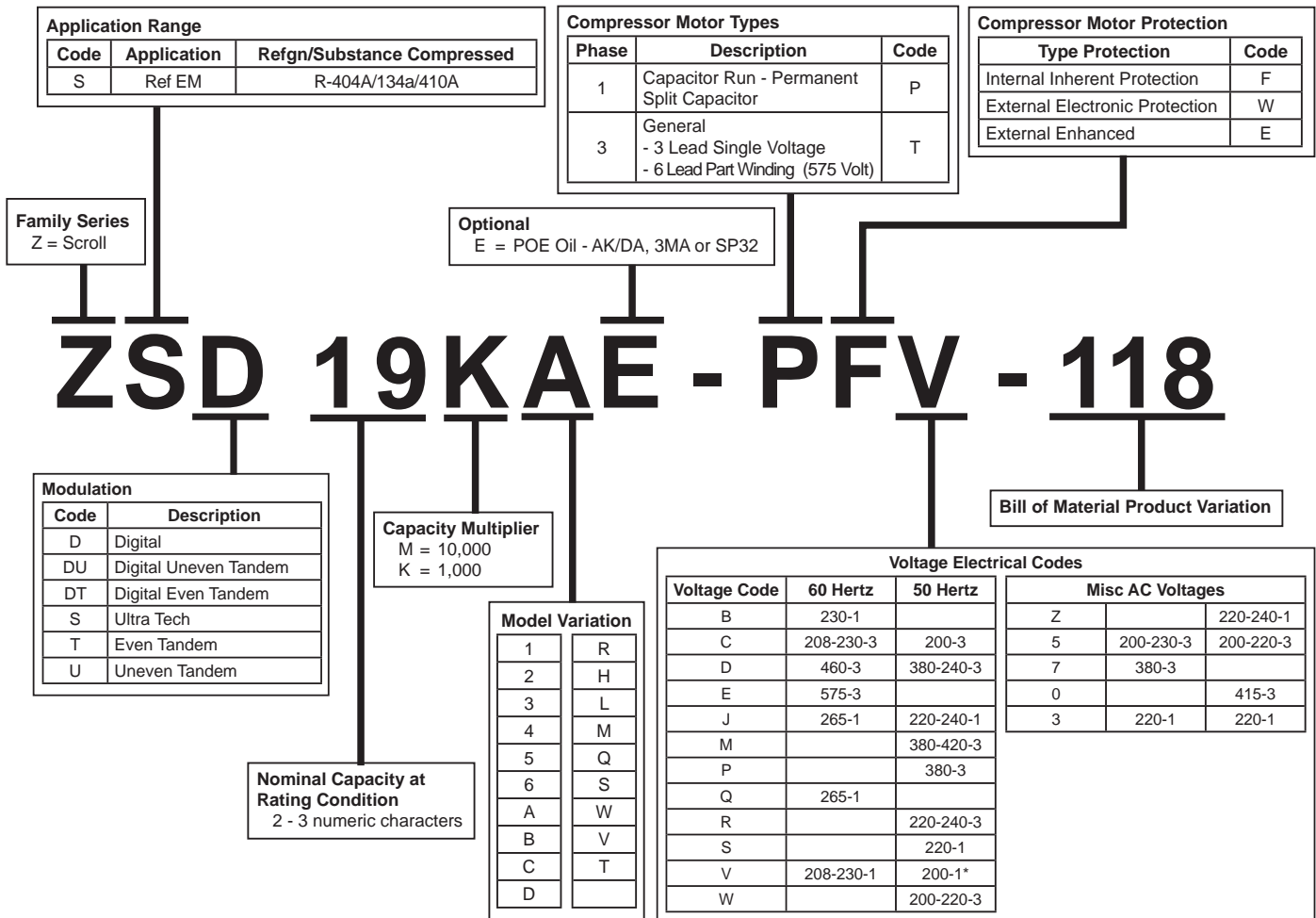

## Common Replacement Parts

| Molded Plug   | Part Number                         |
|---|-------------------------------------|
| 10 GA. - All K4/K4E and K5/K5E 130 or 830 BOM compressors | 529-0060-04                         |
| Oil Controls and Adapters                                 | Part Number                         |
| OMB Oil Control - All Models                              | 065365                              |
| OMB Adapter   | Sight Glass Connection-Part#        |
| ZS15K4E-ZS92K4E, ZS11MCE                                  | Int. Thread (3/4" NPTF)-065668      |
| ZS15K4E-ZS45K4E   | Ext. Thread (1 1/4" -12 UNF)-066650 |
| ZS56/75/92KCE, ZS11MCE                                    | Ext. Thread (1 3/4" -12 UNF)-066078 |
| Discharge Line Thermostat                                 | Part Number                         |
| 1/2" Discharge Line Thermostat                            | 998-7022-02                         |
| 5/8" Discharge Line Thermostat                            | 998-7022-04                         |
| 7/8" Discharge Line Thermostat                            | 998-7022-05                         |



## ZS Motor Protector Modules

| Note # | OEM         | Service     | Voltage  |
|--------|-------------|-------------|----------|
| 2A     | 071-0660-00 | 971-0641-00 | 24V      |
| 2A     | 071-0660-01 | 971-0641-01 | 120/240V |
| 2B     | 071-0650-00 | 971-0547-01 | 120/240V |

## ZS Crankcase Heater Notes

| Note # | OEM         | Service     | Volts | Watts   | Lead Length |
|--------|-------------|-------------|-------|---------|-------------|
| 6      | 018-0094-01 | 918-0052-01 | 120 V | 40 WATT | 21" LEAD    |
| 6      | 018-0094-00 | 918-0052-00 | 240 V | 40 WATT | 21" LEAD    |
| 7      | 018-0095-00 |             | 240 V | 70 WATT | 29" LEAD    |
| 7      | 018-0095-01 |             | 480 V | 70 WATT | 29" LEAD    |
| 7      | 018-0095-02 |             | 575 V | 70 WATT | 29" LEAD    |
| 7      | 018-0095-07 | 918-0043-07 | 120 V | 70 WATT | 48" LEAD    |
| 7      | 018-0095-04 | 918-0043-00 | 240 V | 70 WATT | 48" LEAD    |
| 7      | 018-0095-05 | 918-0043-01 | 480 V | 70 WATT | 48" LEAD    |
| 7      | 018-0095-06 | 918-0043-02 | 575 V | 70 WATT | 48" LEAD    |
| 9      | 018-0091-17 | 918-0019-01 | 120 V | 70 WATT | 30" LEAD    |
| 9      | 018-0091-18 | 918-0019-04 | 240 V | 70 WATT | 30" LEAD    |
| 9      | 018-0091-19 | 918-0019-08 | 460 V | 70 WATT | 30" LEAD    |
| 9      | 018-0091-15 | 918-0019-09 | 575 V | 60 WATT | 30" LEAD    |



# ZS – Copeland Scroll™ Compressors

## ZS - Compressor Parts

| Model         | Start Capacitor |         | Run Capacitor |         | Relay   |         | Motor Protec-<br>tor | Mounting<br>Parts<br>(527-) | Hard<br>Mount<br>Kit<br>(527-) | CH<br>* | Molded<br>Plug<br>(529-) | Sight-<br>glass<br>Kit<br>(998-) |
|---------------|-----------------|---------|---------------|---------|---------|---------|----------------------|-----------------------------|--------------------------------|---------|--------------------------|----------------------------------|
|               | OEM             | Service | OEM           | Service | OEM     | Service |                      |                             |                                |         |                          |                                  |
|               | (014-)          | (914-)  | (014-)        | (914-)  | (040-)  | (940-)  |                      |                             |                                |         |                          |                                  |
| ZS09KAE-PFV   | 0061-27         | 0036-03 | 0064-06       | 0037-10 | 0166-37 | 0001-79 | IP                   | 0044-15                     |                                | 6       | 0060-24                  |                                  |
| ZS09KAE-TF*   |                 |         |               |         |         |         | IP                   | 0044-15                     |                                | 6       | 0060-24                  |                                  |
| ZS11KAE-PFV   | 0061-27         | 0036-03 | 0064-06       | 0037-10 | 0166-37 | 0001-79 | IP                   | 0044-15                     |                                | 6       | 0060-24                  |                                  |
| ZS11KAE-TF*   |                 |         |               |         |         |         | IP                   | 0044-15                     |                                | 6       | 0060-24                  |                                  |
| ZS13KAE-PFV   | 0061-27         | 0036-03 | 0064-07       | 0037-11 | 0166-37 | 0001-79 | IP                   | 0044-15                     |                                | 6       | 0060-24                  |                                  |
| ZS13KAE-TF*   |                 |         |               |         |         |         | IP                   | 0044-15                     |                                | 6       | 0060-24                  |                                  |
| ZS15K4(E)-PFV | 0061-27         | 0036-03 | 0064-08       | 0037-12 | 0166-37 | 0001-79 | IP                   | 0116-00                     | 0157-00                        | 7       |                          | 0010-02                          |
| ZS15K4(E)-TF* |                 |         |               |         |         |         | IP                   | 0116-00                     | 0157-00                        | 7       |                          | 0010-02                          |
| ZS15KAE-PFV   | 0061-27         | 0036-03 | 0064-08       | 0037-12 | 0166-37 | 0001-79 | IP                   | 0044-15                     |                                | 6       | 0060-24                  |                                  |
| ZS15KAE-TF*   |                 |         |               |         |         |         | IP                   | 0044-15                     |                                | 6       | 0060-24                  |                                  |
| ZS19K4(E)-PFV | 0061-27         | 0036-03 | 0064-25       | 0037-36 | 0166-37 | 0001-79 | IP                   | 0116-00                     | 0157-00                        | 7       |                          | 0010-02                          |
| ZS19K4(E)-TF* |                 |         |               |         |         |         | IP                   | 0116-00                     | 0157-00                        | 7       |                          | 0010-02                          |
| ZS19KAE-PFV   | 0061-27         | 0036-03 | 0064-25       | 0037-36 | 0166-37 | 0001-79 | IP                   | 0044-15                     |                                | 6       | 0060-24                  |                                  |
| ZS19KAE-TF*   |                 |         |               |         |         |         | IP                   | 0044-15                     |                                | 6       | 0060-24                  |                                  |
| ZS21K4(E)-PFV | 0061-27         | 0036-03 | 0064-29       | 0037-40 | 0166-37 | 0001-79 | IP                   | 0116-00                     | 0157-00                        | 7       |                          | 0010-02                          |
| ZS21K4(E)-TF* |                 |         |               |         |         |         | IP                   | 0116-00                     | 0157-00                        | 7       |                          | 0010-02                          |
| ZS21KAE-PFV   | 0061-27         | 0036-03 | 0064-28       | 0037-39 | 0166-37 | 0001-79 | IP                   | 0116-00                     |                                | 7       | 0060-24                  |                                  |
| ZS21KAE-TF*   |                 |         |               |         |         |         | IP                   | 0116-00                     |                                | 7       | 0060-24                  |                                  |
| ZS26K4(E)-PFV | 0061-27         | 0036-03 | 0064-26       | 0037-37 | 0166-37 | 0001-79 | IP                   | 0116-00                     | 0157-00                        | 7       |                          | 0010-02                          |
| ZS26K4(E)-TF* |                 |         |               |         |         |         | IP                   | 0116-00                     | 0157-00                        | 7       |                          | 0010-02                          |
| ZS26KAE-PFV   | 0061-27         | 0036-03 | 0064-28       | 0037-39 | 0166-37 | 0001-79 | IP                   | 0116-00                     |                                | 7       | 0060-24                  |                                  |
| ZS26KAE-TF*   |                 |         |               |         |         |         | IP                   | 0116-00                     |                                | 7       | 0060-24                  |                                  |
| ZS29KAE-PFV   | 0061-27         | 0036-03 | 0064-18       | 0037-22 | 0166-37 | 0001-79 | IP                   | 0116-00                     |                                | 7       | 0060-24                  |                                  |
| ZS29KAE-TF*   |                 |         |               |         |         |         | IP                   | 0116-00                     |                                | 7       | 0060-24                  |                                  |
| ZS30K4(E)-PFV | 0061-27         | 0036-03 | 0064-26       | 0037-37 | 0166-37 | 0001-79 | IP                   | 0116-00                     | 0157-00                        | 7       |                          | 0010-02                          |
| ZS30K4(E)-TF* |                 |         |               |         |         |         | IP                   | 0116-00                     | 0157-00                        | 7       |                          | 0010-02                          |
| ZS33KAE-PFV   | 0061-27         | 0036-03 | 0064-27       | 0037-38 | 0166-37 | 0001-79 | IP                   | 0116-00                     |                                | 7       | 0060-24                  |                                  |
| ZS33KAE-TF*   |                 |         |               |         |         |         | IP                   | 0116-00                     |                                | 7       | 0060-24                  |                                  |
| ZS38K4(E)-TF* |                 |         |               |         |         |         | IP                   | 0116-00                     | 0157-00                        | 7       |                          | 0010-02                          |
| ZS38K4E-PFV   | 0006-15         | 0006-10 | 0064-27       | 0037-38 | 0166-37 | 0001-79 | IP                   | 0116-00                     | 0157-00                        | 7       |                          | 0010-02                          |
| ZS45K4(E)-TF* |                 |         |               |         |         |         | IP                   | 0116-00                     | 0157-00                        | 7       |                          | 0010-02                          |
| ZS56K4(E)-TW* |                 |         |               |         |         |         | NOTE<br>2B           | 0159-00                     | 0158-00                        | 9       |                          | 0010-02                          |
| ZS75K4(E)-TW* |                 |         |               |         |         |         | NOTE<br>2B           | 0159-00                     | 0158-00                        | 9       |                          | 0010-02                          |
| ZS75KA-TW*    |                 |         |               |         |         |         | NOTE<br>2B           | 0159-00                     | 0158-00                        | 9       |                          | 0010-02                          |
| ZS92K4(E)-TW* |                 |         |               |         |         |         | NOTE<br>2B           | 0159-00                     | 0158-00                        | 9       |                          | 0010-02                          |
| ZS92K5E-TW*   |                 |         |               |         |         |         | NOTE<br>2B           | 0159-00                     | 0158-00                        | 9       |                          | 0010-02                          |
| ZS11M4(E)-TW* |                 |         |               |         |         |         | NOTE<br>2B           | 0159-00                     | 0158-00                        | 9       |                          | 0010-02                          |

## Copeland Semi-Hermetic Mounting Parts and Kits

| Compressor Model       | Kit Number (527) | Mounting Stud |     | Spring (Motor End) |     |             | Spring (Compressor End) |     |             | Rubber Spacer |     | Shipping Retainer |     |
|------------------------|------------------|---------------|-----|--------------------|-----|-------------|-------------------------|-----|-------------|---------------|-----|-------------------|-----|
|                        |                  | Part Number   | QTY | Part # (006)       | QTY | Color       | Part # (006)            | QTY | Color       | Part # (027)  | QTY | Part # (074)      | QTY |
| EA/ER                  | <b>0006-00</b>   | 100-0012-45   | 4   | 0012-00            | 2   | Grey        | 0012-00                 | 2   | Grey        | 0192-00       | 4   | 0619-00           | 4   |
| H                      | <b>0005-01</b>   | 103-0001-03 * | 4   | 0013-01            | 2   | Dark Blue   | 0013-01                 | 2   | Dark Blue   | 0015-00       | 4   |                   |     |
| K 1/2 to 1 HP          | <b>0005-02</b>   | 103-0001-03 * | 4   | 0013-01            | 2   | Dark Blue   | 0013-02                 | 2   | Dark Maroon | 0015-00       | 4   |                   |     |
| K 1-1/2 & 2 HP         | <b>0005-03</b>   | 103-0001-03 * | 4   | 0013-02            | 2   | Dark Maroon | 0013-02                 | 2   | Dark Maroon | 0015-00       | 4   |                   |     |
| LA                     | <b>0007-00</b>   | 100-0012-45   | 4   | 0012-01            | 2   | Dark Blue   | 0012-01                 | 2   | Dark Blue   | 0192-00       | 4   | 0619-00           | 4   |
| MR                     | <b>0105-00</b>   | 100-0012-46   | 4   | 0012-02            | 2   | Maroon      | 0012-02                 | 2   | Maroon      | 0192-00       | 4   | 0619-01           | 4   |
| NR 3 HP                | <b>0007-00</b>   | 100-0012-45   | 4   | 0012-01            | 2   | Dark Blue   | 0012-01                 | 2   | Dark Blue   | 0192-00       | 4   | 0619-00           | 4   |
| NR 4 to 5 HP           | <b>0040-00</b>   | 100-0012-45   | 4   | 0103-00            | 2   | Orange      | 0103-00                 | 2   | Orange      | 0192-00       | 4   | 0619-00           | 4   |
| 2D                     | <b>0105-00</b>   | 100-0012-46   | 4   | 0012-02            | 2   | Maroon      | 0012-02                 | 2   | Maroon      | 0192-00       | 4   | 0619-01           | 4   |
| 3A/3R                  | <b>0007-00</b>   | 100-0012-45   | 4   | 0012-01            | 2   | Dark Blue   | 0012-01                 | 2   | Dark Blue   | 0192-00       | 4   | 0619-00           | 4   |
| 3D 5 to 6 HP           | <b>0009-00</b>   | 100-0012-43   | 4   | 0012-02            | 2   | Maroon      | 0012-02                 | 2   | Maroon      | 0192-00       | 4   | 0619-01           | 4   |
| 3DA 7-1/2 HP           | <b>0009-00</b>   | 100-0012-43   | 4   | 0012-02            | 2   | Maroon      | 0012-02                 | 2   | Maroon      | 0192-00       | 4   | 0619-01           | 4   |
| 3DB 10 HP              | <b>0045-00</b>   | 100-0012-43   | 4   | 0012-02            | 2   | Maroon      | 0110-00                 | 2   | White       | 0192-00       | 4   | 0619-01           | 4   |
| 3DB 7-1/2 HP           | <b>0009-00</b>   | 100-0012-43   | 4   | 0012-02            | 2   | Maroon      | 0012-02                 | 2   | Maroon      | 0192-00       | 4   | 0619-01           | 4   |
| 3DF/3DS 7-1/2 to 10 HP | <b>0045-00</b>   | 100-0012-43   | 4   | 0012-02            | 2   | Maroon      | 0110-00                 | 2   | White       | 0192-00       | 4   | 0619-01           | 4   |
| 4D/4R 10 to 22 HP      | <b>0037-00</b>   | 100-0012-43   | 4   | 0087-00            | 2   | Yellow      | 0086-00                 | 2   | Green       | 0192-00       | 4   | 0619-01           | 4   |
| 6R 10 HP               | <b>0037-00</b>   | 100-0012-43   | 4   | 0087-00            | 2   | Yellow      | 0086-00                 | 2   | Green       | 0192-00       | 4   | 0619-01           | 4   |
| <b>FLAT BOTTOM</b>     |                  |               |     |                    |     |             |                         |     |             |               |     |                   |     |
| 3D 15 HP               | <b>0081-00</b>   | 100-0012-43   | 4   | 0087-00            | 2   | Yellow      | 0211-00                 | 2   | Red         | 0192-00       | 4   | 0619-01           | 4   |
| 4D/4R 25 to 30 HP      | <b>0042-00</b>   | 100-0012-43   | 4   | 0108-00            | 2   | Black       | 0086-00                 | 2   | Green       | 0192-00       | 4   | 0619-01           | 4   |
| 6D/6R 20 to 30 HP      | <b>0042-00</b>   | 100-0012-43   | 4   | 0108-00            | 2   | Black       | 0086-00                 | 2   | Green       | 0192-00       | 4   | 0619-01           | 4   |
| 6D/6R 35 HP            | <b>0057-00</b>   | 100-0012-43   | 4   | 0149-00            | 2   | Blue        | 0086-00                 | 2   | Green       | 0192-00       | 4   | 0619-01           | 4   |
| <b>DEEP SUMP **</b>    |                  |               |     |                    |     |             |                         |     |             |               |     |                   |     |
| 4DA/4DH                | <b>0081-00</b>   | 100-0012-43   | 4   | 0087-00            | 2   | Yellow      | 0211-00                 | 2   | Red         | 0192-00       | 4   | 0619-01           | 4   |
| 4DJ 20 & 30 HP         | <b>0079-00</b>   | 100-0012-43   | 4   | 0108-00            | 2   | Black       | 0211-00                 | 2   | Red         | 0192-00       | 4   | 0619-01           | 4   |
| 4RA, 4RH, 4RE, & 4RK   | <b>0081-00</b>   | 100-0012-43   | 4   | 0087-00            | 2   | Yellow      | 0211-00                 | 2   | Red         | 0192-00       | 4   | 0619-01           | 4   |
| 4RJ 20 & 30 HP         | <b>0079-00</b>   | 100-0012-43   | 4   | 0108-00            | 2   | Black       | 0211-00                 | 2   | Red         | 0192-00       | 4   | 0619-01           | 4   |
| 6D 40 HP               | <b>0080-00</b>   | 100-0012-43   | 4   | 0149-00            | 2   | Blue        | 0211-00                 | 2   | Red         | 0192-00       | 4   | 0619-01           | 4   |
| 6DH, 6RA, & 6RH        | <b>0081-00</b>   | 100-0012-43   | 4   | 0087-00            | 2   | Yellow      | 0211-00                 | 2   | Red         | 0192-00       | 4   | 0619-01           | 4   |
| 6DT 30 HP              | <b>0080-00</b>   | 100-0012-43   | 4   | 0149-00            | 2   | Blue        | 0211-00                 | 2   | Red         | 0192-00       | 4   | 0619-01           | 4   |
| 8D                     | <b>0115-00</b>   | 100-0012-49   | 4   | 0284-00            | 2   | Purple      | 0283-00                 | 2   | Brown       | 0192-00       | 4   | 0619-04           | 4   |

\* Rubber Space (Lower) 027-0014-00 QTY 4

\*\* Deep Sump - Only commonly used models are listed

# Quick Reference Guide

## Copeland Reed Compressor Service Valves

| Comp. Model                 | Discharge Valves   |  |               |             |                      | Suction Valves     |  |                |             |                      |
|-----------------------------|--------------------|--|---------------|-------------|----------------------|--------------------|--|----------------|-------------|----------------------|
|                             | Dischg. Size (ODF) | Discharge Valve Kit (Valve, Cap, Gasket) | Valve Type    | Cap (Metal) | Gasket Valve to Body | Suction Size (ODF) | Suction Valve Kit (Valve, Cap, Gasket) | Valve Type     | Cap (Metal) | Gasket Valve to Body |
| <b>EA</b><br><b>2HP/3HP</b> | 1/2                | 998-0510-34                              | <b>2 Bolt</b> | 505-0431-00 | 020-1224-01          | 7/8                | 998-0510-12                            | <b>2 Bolt</b>  | 505-0374-00 | 020-1224-00          |
| <b>ER 2 HP</b>              | 5/8                | 998-0510-33                              | <b>2 Bolt</b> | 505-0431-00 | 020-1224-01          | 7/8                | 998-0510-12                            | <b>2 Bolt</b>  | 505-0374-00 | 020-1224-00          |
| <b>ER 3 HP</b>              | 5/8                | 998-0510-33                              | <b>2 Bolt</b> | 505-0431-00 | 020-1224-01          | 1-1/8              | 998-0510-13                            | <b>2 Bolt</b>  | 505-0374-00 | 020-1224-00          |
| <b>H 1/2 HP</b>             | 3/8                | 998-0510-36                              | <b>2 Bolt</b> | 505-0431-00 | 020-1224-01          | 1/2                | 998-0510-32                            | <b>2 Bolt</b>  | 505-0431-00 | 020-1224-01          |
| <b>K 3/4 HP</b>             | 3/8                | 998-0510-36                              | <b>2 Bolt</b> | 505-0431-00 | 020-1224-01          | 5/8                | 998-0510-31                            | <b>2 Bolt</b>  | 505-0431-00 | 020-1224-01          |
| <b>K 11/2 HP</b>            | 1/2                | 998-0510-34                              | <b>2 Bolt</b> | 505-0431-00 | 020-1224-01          | 7/8                | 998-0510-12                            | <b>2 Bolt</b>  | 505-0374-00 | 020-1224-00          |
| <b>KAGB</b><br><b>1 HP</b>  | 3/8                | 998-0510-36                              | <b>2 Bolt</b> | 505-0431-00 | 020-1224-01          | 5/8                | 998-0510-31                            | <b>2 Bolt</b>  | 505-0431-00 | 020-1224-01          |
| <b>KAJ/M</b><br><b>1 HP</b> | 1/2                | 998-0510-34                              | <b>2 Bolt</b> | 505-0431-00 | 020-1224-01          | 5/8                | 998-0510-31                            | <b>2 Bolt</b>  | 505-0431-00 | 020-1224-01          |
| <b>KAK</b><br><b>2 HP</b>   | 1/2                | 998-0510-34                              | <b>2 Bolt</b> | 505-0431-00 | 020-1224-01          | 7/8                | 998-0510-12                            | <b>2 Bolt</b>  | 505-0374-00 | 020-1224-00          |
| <b>KAL</b><br><b>11/2HP</b> | 1/2                | 998-0510-34                              | <b>2 Bolt</b> | 505-0431-00 | 020-1224-01          | 7/8                | 998-0510-12                            | <b>2 Bolt</b>  | 505-0374-00 | 020-1224-00          |
| <b>KAN</b><br><b>1/2 HP</b> | 3/8                | 998-0510-36                              | <b>2 Bolt</b> | 505-0431-00 | 020-1224-01          | 1/2                | 998-0510-32                            | <b>2 Bolt</b>  | 505-0431-00 | 020-1224-01          |
| <b>KAR</b>                  | 1/2                | 998-0510-34                              | <b>2 Bolt</b> | 505-0431-00 | 020-1224-01          | 5/8                | 998-0510-31                            | <b>2 Bolt</b>  | 505-0431-00 | 020-1224-01          |
| <b>LA/3A/3R</b>             | 5/8                | 998-0510-33                              | <b>2 Bolt</b> | 505-0431-00 | 020-1224-01          | 1-1/8              | 998-0510-13                            | <b>2 Bolt</b>  | 505-0374-00 | 020-1224-00          |
| <b>NR</b>                   | 5/8                | 998-0510-06                              | <b>2 Bolt</b> | 005-0601-00 | 020-1224-00          | 1-1/8              | 998-0510-13                            | <b>2 Bolt</b>  | 505-0374-00 | 020-1224-00          |
| <b>MR</b>                   | 7/8                | 998-0510-12                              | <b>2 Bolt</b> | 505-0374-00 | 020-1224-00          | 1-3/8              | 998-0510-11                            | <b>*2 Bolt</b> | 505-0374-00 | 020-0489-00          |

\* Adaptor Fitting and Gasket Kit # 998-0036-14 goes with 998-0510-11

### Discharge Rotalock Adapter Kit for 2D

Kit # 998-0036-02 Can be used with Valve Models

|             |        |    |
|-------------|--------|----|
| 998-0510-38 | 3/4"   | 2D |
| 998-0510-90 | 7/8"   | 2D |
| 998-0510-51 | 1-1/8" | 2D |

### Discharge Rotalock Adapter Kit for 3D, 4D, 4R, 6D, 6R, 9R

Kit # 998-0036-00 can be used with valve models

|             |         |                |
|-------------|---------|----------------|
| 998-0510-02 | 1-1/8 " | 3D, 9R         |
| 998-0510-46 | 1-3/8"  | 4D, 4R, 6D, 6R |
| 998-0510-66 | 1-5/8"  | 4D, 4R, 6D, 6R |



## Copeland Discus Compressor Service Discharge Valves

| Comp. Model    | Dischg. Size (ODF) | Discharge Valve Kit (Valve, Cap, Gasket) | Valve Type | Discharge Valve Cap | Rotalock Fitting Teflon Seal | Gasket Flange Body | Metal Cap   | Mueller Valve Cap | Mueller Adaptor Fitting and Gasket Kit |
|----------------|--------------------|--|------------|---------------------|------------------------------|--------------------|-------------|-------------------|--|
| 2D             | 7/8                | 998-0510-12                              | 2 Bolt     | 505-0280-00         | --                           | 020-1224-00        | 505-0374-00 | --                | --                                     |
| 3D             | 7/8                | 998-0510-37                              | Rotalock   | 505-0438-00         | 020-0028-03                  | 020-0489-00        | 505-0438-00 | --                | --                                     |
| 3D             | 1-1/8              | 998-0510-02                              | Rotalock   | 505-0438-00         | 020-0028-03                  | 020-0489-00        | 505-0438-00 | --                | --                                     |
| 4DA/E3-10 HP   | 1-1/8              | 998-0510-09                              | 2 Bolt     | 505-0280-00         | --                           | 020-0489-00        | 505-0374-00 | --                | 998-0036-13                            |
| 4DA/E3-20 HP   | 1-3/8              | 998-0510-11                              | 2 Bolt     | 505-0280-00         | --                           | 020-0489-00        | --          | 505-0280-00       | 998-0036-14                            |
| 4DH/K3-25 HP   | 1-3/8              | 998-0510-11                              | 2 Bolt     | 505-0280-00         | --                           | 020-0489-00        | --          | 505-0280-00       | 998-0036-14                            |
| 4DJ/R3-30 HP   | 1-3/8              | 998-0510-11                              | 2 Bolt     | 505-0280-00         | --                           | 020-0489-00        | --          | 505-0280-00       | 998-0036-14                            |
| 4DL/P3-15 HP   | 1-3/8              | 998-0510-46                              | Rotalock   | 505-0438-00         | 020-0028-03                  | 020-0489-00        | 505-0438-00 | --                | --                                     |
| 4DT/S3-22HP    | 1-3/8              | 998-0510-46                              | Rotalock   | 505-0438-00         | 020-0028-03                  | 020-0489-00        | 505-0438-00 | --                | --                                     |
| 6DG/M/N3-35 HP | 1-5/8              | 998-0510-66                              | Rotalock   | 505-0435-00         | 020-0028-03                  | 020-0489-00        | --          | --                | --                                     |
| 6DH/K/P3-35 HP | 1-5/8              | 998-0510-66                              | Rotalock   | 505-0435-00         | 020-0028-03                  | 020-0489-00        | --          | --                | --                                     |
| 6DJ/R/S3-40 HP | 1-5/8              | 998-0510-66                              | Rotalock   | 505-0435-00         | 020-0028-03                  | 020-0489-00        | --          | --                | --                                     |
| 6DL/C/D3-27 HP | 1-3/8              | 998-0510-46                              | Rotalock   | 505-0438-00         | 020-0028-03                  | 020-0489-00        | 505-0438-00 | --                | --                                     |
| 6DT/E/F3-30 HP | 1-3/8              | 998-0510-46                              | Rotalock   | 505-0438-00         | 020-0028-03                  | 020-0489-00        | 505-0438-00 | --                | --                                     |





## Copeland Discus Compressor Service Suction Valves

| Comp. Model    | Suction Size (ODF) | Suction Valve Kit (Valve, Cap, Gasket) | Valve Type | Gasket Valve to Body | Mueller Valve Cap | Mueller Adaptor Fitting and Gasket Kit | Hans Nobis Valve Cap | Hans Nobis Adaptor Fitting and Gasket Kit |
|----------------|--------------------|--|------------|----------------------|-------------------|--|----------------------|---|
| 2D             | 13/8               | 998-0510-11                            | 2 Bolt     | 020-0489-00          | 505-0280-00       | 998-0036-14                            | --                   | --  |
| 3D             | 13/8               | 998-0510-11                            | 2 Bolt     | 020-0489-00          | 505-0280-00       | 998-0036-14                            | --                   | --  |
| 3D             | 15/8               | 998-0510-07                            | 4 Bolt     | 020-0006-46          | 005-0663-00       | 998-0036-10                            | 005-0955-00          | 998-0036-20                               |
| 4DA/E3-10 HP   | 15/8               | 998-0510-07                            | 4 Bolt     | 020-0006-46          | 005-0663-00       | 998-0036-10                            | 005-0955-00          | 998-0036-20                               |
| 4DA/E3-20 HP   | 15/8               | 998-0510-07                            | 4 Bolt     | 020-0006-46          | 005-0663-00       | 998-0036-10                            | 005-0955-00          | 998-0036-20                               |
| 4DH/K3-25 HP   | 21/8               | 998-0510-20                            | 4 Bolt     | 020-0006-47          | 005-0664-00       | 998-0036-05                            | 005-0956-00          | 998-0036-23                               |
| 4DJ/R3-30 HP   | 21/8               | 998-0510-20                            | 4 Bolt     | 020-0006-47          | 005-0664-00       | 998-0036-05                            | 005-0956-00          | 998-0036-23                               |
| 4DL/P3-15 HP   | 15/8               | 998-0510-07                            | 4 Bolt     | 020-0006-46          | 005-0663-00       | 998-0036-10                            | 005-0955-00          | 998-0036-20                               |
| 4DT/S3-22HP    | 21/8               | 998-0510-20                            | 4 Bolt     | 020-0006-47          | 005-0664-00       | 998-0036-05                            | 005-0956-00          | 998-0036-23                               |
| 6DG/M/N3-35 HP | 21/8               | 998-0510-20                            | 4 Bolt     | 020-0006-47          | 005-0664-00       | 998-0036-05                            | 005-0956-00          | 998-0036-23                               |
| 6DH/K/P3-35 HP | 21/8               | 998-0510-20                            | 4 Bolt     | 020-0006-47          | 005-0664-00       | 998-0036-05                            | 005-0956-00          | 998-0036-23                               |
| 6DJ/R/S3-40 HP | 21/8               | 998-0510-20                            | 4 Bolt     | 020-0006-47          | 005-0664-00       | 998-0036-05                            | 005-0956-00          | 998-0036-23                               |
| 6DL/C/D3-27 HP | 21/8               | 998-0510-20                            | 4 Bolt     | 020-0006-47          | 005-0664-00       | 998-0036-05                            | 005-0956-00          | 998-0036-23                               |
| 6DT/E/F3-30 HP | 21/8               | 998-0510-20                            | 4 Bolt     | 020-0006-47          | 005-0664-00       | 998-0036-05                            | 005-0956-00          | 998-0036-23                               |



## A-model Sweat Connection Sizes

| Model    | Suction Connection Size | Discharge Connection Size |
|----------|-------------------------|---------------------------|
| AF07C1*  | 5/16" ODF               | 1/4" ODF                  |
| AF22C1*  | 3/8" ODF                | 1/4" ODF                  |
| AFB04C3* | 5/16" ODF               | 1/4" ODF                  |
| AFB05C3* | 5/16" ODF               | 1/4" ODF                  |
| AFB06C3* | 5/16" ODF               | 1/4" ODF                  |
| AFB09C3* | 5/16" ODF               | 1/4" ODF                  |
| AFE05C4* | 5/16" ODF               | 1/4" ODF                  |
| AFE06C4* | 5/16" ODF               | 1/4" ODF                  |
| AFE07C3* | 5/16" ODF               | 1/4" ODF                  |
| AFE08C4* | 5/16" ODF               | 1/4" ODF                  |
| AFE10C3* | 5/16" ODF               | 1/4" ODF                  |
| AFE11C3* | 5/16" ODF               | 1/4" ODF                  |
| AFE11C4* | 5/16" ODF               | 1/4" ODF                  |
| AFE12C3* | 5/16" ODF               | 1/4" ODF                  |
| AFE12C4* | 5/16" ODF               | 1/4" ODF                  |
| AFE13C3* | 5/16" ODF               | 1/4" ODF                  |
| AFE13C4* | 5/16" ODF               | 1/4" ODF                  |
| AFE17C4* | 5/16" ODF               | 1/4" ODF                  |
| AFJ23C1* | ROTALOCK                | 5/16" ODF                 |
| AFJ23C2* | ROTALOCK                | 5/16" ODF                 |
| AFJ31C1* | ROTALOCK                | 5/16" ODF                 |
| AFJ37C1* | ROTALOCK                | 5/16" ODF                 |
| AFJ37C2* | ROTALOCK                | 1/4" ODF                  |
| AFT12C1* | 3/8" ODF                | 1/4" ODF                  |
| AFT18C1* | 3/8" ODF                | 1/4" ODF                  |
| AFT22C1* | 3/8" ODF                | 1/4" ODF                  |
| AFT26C1* | 3/8" ODF                | 1/4" ODF                  |
| AFT29C1* | 3/8" ODF                | 1/4" ODF                  |
| ARB10C3* | 5/16" ODF               | 1/4" ODF                  |
| ARB13C3* | 5/16" ODF               | 1/4" ODF                  |
| ARB17C3* | 5/16" ODF               | 1/4" ODF                  |
| ARB21C3* | 5/16" ODF               | 1/4" ODF                  |
| ARE13C4* | 5/16" ODF               | 1/4" ODF                  |
| ARE17C4* | 5/16" ODF               | 1/4" ODF                  |
| ARE25C3* | 5/16" ODF               | 1/4" ODF                  |
| ARE25C4* | 5/16" ODF               | 1/4" ODF                  |

| Model    | Suction Connection Size | Discharge Connection Size |
|----------|-------------------------|---------------------------|
| ARE27C3* | 5/16" ODF               | 1/4" ODF                  |
| ARE29C4* | 5/16" ODF               | 1/4" ODF                  |
| ARE34C4* | 5/16" ODF               | 1/4" ODF                  |
| ARE35C3* | 5/16" ODF               | 1/4" ODF                  |
| ARE36C3* | 5/16" ODF               | 1/4" ODF                  |
| ARE37C3* | 5/16" ODF               | 1/4" ODF                  |
| ARE40C4* | 5/16" ODF               | 1/4" ODF                  |
| ARE41C3* | 5/16" ODF               | 1/4" ODF                  |
| ARE46C4* | 5/16" ODF               | 1/4" ODF                  |
| ARE47C3* | 5/16" ODF               | 1/4" ODF                  |
| ARE51C4* | 5/16" ODF               | 1/4" ODF                  |
| ARE59C3* | 5/16" ODF               | 1/4" ODF                  |
| ARJ11K1* | 3/8" ODF                | 5/16" ODF                 |
| ARJ11K2* | ROTALOCK                | 5/16" ODF                 |
| ARJ13K1* | 3/8" ODF                | 5/16" ODF                 |
| ARJ84C2* | ROTALOCK                | 5/16" ODF                 |
| ART51C1* | 3/8" ODF                | 1/4" ODF                  |
| ART62C1* | 3/8" ODF                | 1/4" ODF                  |
| ART64C1* | 3/8" ODF                | 1/4" ODF                  |
| ART69C1* | 3/8" ODF                | 1/4" ODF                  |
| ART82C1* | 3/8" ODF                | 1/4" ODF                  |
| ART97C1* | 3/8" ODF                | 1/4" ODF                  |
| ASB12C3* | 5/16" ODF               | 1/4" ODF                  |
| ASB14C3* | 5/16" ODF               | 1/4" ODF                  |
| ASE12C4* | 5/16" ODF               | 1/4" ODF                  |
| ASE14C4* | 5/16" ODF               | 1/4" ODF                  |
| ASE19C3* | 5/16" ODF               | 1/4" ODF                  |
| ASE19C4* | 5/16" ODF               | 1/4" ODF                  |
| ASE20C4* | 5/16" ODF               | 1/4" ODF                  |
| ASE24C3* | 5/16" ODF               | 1/4" ODF                  |
| ASE26C4* | 5/16" ODF               | 1/4" ODF                  |
| ASE32C3* | 5/16" ODF               | 1/4" ODF                  |
| ASE35C4* | 5/16" ODF               | 1/4" ODF                  |
| AST40C1* | 3/8" ODF                | 1/4" ODF                  |
| AST45C1* | 3/8" ODF                | 1/4" ODF                  |
| AST54C1* | 3/8" ODF                | 1/4" ODF                  |

Standard connection sizes are shown above. The connection sizes may vary on special OEM Bill of Materials.

# Quick Reference Guide

## C-model Sweat Connection Sizes

| Model   | Suction Connection Size | Discharge Connection Size |
|---------|-------------------------|---------------------------|
| CF04K6* | 3/4" ODF                | 3/8" ODF                  |
| CF06K6* | 3/4" ODF                | 3/8" ODF                  |
| CF09K6* | 3/4" ODF                | 1/2" ODF                  |
| CF12K6* | 3/4" ODF                | 1/2" ODF                  |
| CR16K6* | 3/4" ODF                | 3/8" ODF                  |
| CR16KQ* | 5/8" ODF                | 3/8" ODF                  |
| CR18K6* | 3/4" ODF                | 3/8" ODF                  |
| CR18KQ* | 5/8" ODF                | 3/8" ODF                  |
| CR20K6* | 3/4" ODF                | 3/8" ODF                  |
| CR20KQ* | 5/8" ODF                | 3/8" ODF                  |
| CR22K6* | 3/4" ODF                | 3/8" ODF                  |
| CR22KQ* | 5/8" ODF                | 3/8" ODF                  |
| CR24K6* | 5/8" ODF                | 3/8" ODF                  |
| CR24KQ* | 5/8" ODF                | 3/8" ODF                  |
| CR28K6* | 3/4" ODF                | 1/2" ODF                  |
| CR28KQ* | 5/8" ODF                | 3/8" ODF                  |
| CR30K6* | 3/4" ODF                | 3/8" ODF                  |
| CR30KF* | 3/4" ODF                | 3/8" ODF                  |
| CR30KQ* | 5/8" ODF                | 3/8" ODF                  |
| CR32K6* | 3/4" ODF                | 1/2" ODF                  |
| CR32KQ* | 5/8" ODF                | 3/8" ODF                  |
| CR33KQ* | 3/4" ODF                | 3/8" ODF                  |
| CR34K6* | 3/4" ODF                | 3/8" ODF                  |
| CR34KQ* | 3/4" ODF                | 3/8" ODF                  |
| CR35K6* | 3/4" ODF                | 1/2" ODF                  |
| CR35KF* | 3/4" ODF                | 1/2" ODF                  |
| CR37KQ* | 3/4" ODF                | 3/8" ODF                  |
| CR38K6* | 3/4" ODF                | 3/8" ODF                  |
| CR41KQ* | 3/4" ODF                | 3/8" ODF                  |
| CR42K6* | 3/4" ODF                | 1/2" ODF                  |

| Model      | Suction Connection Size | Discharge Connection Size |
|------------|-------------------------|---------------------------|
| CR47KQ*    | 7/8" ODF                | 1/2" ODF                  |
| CR53KQ*    | 7/8" ODF                | 1/2" ODF                  |
| CRA1-0150* | 5/8" ODF                | 3/8" ODF                  |
| CRB1-0175* | 5/8" ODF                | 3/8" ODF                  |
| CRC1-0175* | 5/8" ODF                | 3/8" ODF                  |
| CRD1-0200* | 5/8" ODF                | 3/8" ODF                  |
| CRE2-0225* | 5/8" ODF                | 3/8" ODF                  |
| CRF2-0250* | 3/4" ODF                | 3/8" ODF                  |
| CRG3-0250* | 3/4" ODF                | 3/8" ODF                  |
| CRH3-0275* | 3/4" ODF                | 3/8" ODF                  |
| CRJ3-0300* | 3/4" ODF                | 3/8" ODF                  |
| CRK3-0325* | 3/4" ODF                | 3/8" ODF                  |
| CRL3-0350* | 7/8" ODF                | 1/2" ODF                  |
| CRM3-0400* | 7/8" ODF                | 1/2" ODF                  |
| CRN5-0500* | 7/8" ODF                | 1/2" ODF                  |
| CRP5-0450* | 7/8" ODF                | 1/2" ODF                  |
| CRT5-0450* | 7/8" ODF                | 1/2" ODF                  |
| CS10K6*    | 3/4" ODF                | 3/8" ODF                  |
| CS12K6*    | 3/4" ODF                | 3/8" ODF                  |
| CS14K6*    | 3/4" ODF                | 3/8" ODF                  |
| CS18K6*    | 3/4" ODF                | 3/8" ODF                  |
| CS20K6*    | 3/4" ODF                | 1/2" ODF                  |
| CS27K3*    | 3/4" ODF                | 1/2" ODF                  |
| CS27K6*    | 3/4" ODF                | 1/2" ODF                  |
| CS33K3*    | 7/8" ODF                | 1/2" ODF                  |
| CS33K6*    | 7/8" ODF                | 1/2" ODF                  |
| CTH1-0275* | 7/8" ODF                | 1/2" ODF                  |
| CTL1-0350* | 7/8" ODF                | 1/2" ODF                  |
| CTN1-0500* | 7/8" ODF                | 1/2" ODF                  |
| CTN1-0501* | 7/8" ODF                | 1/2" ODF                  |

Standard connection sizes are shown above. The connection sizes may vary on special OEM Bill of Materials.

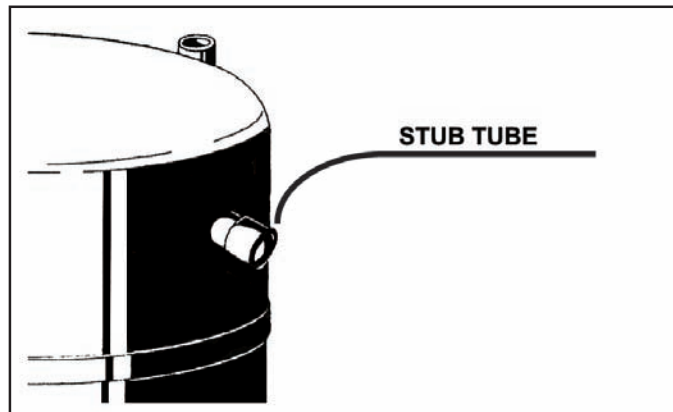

## R-model Sweat Connection Sizes

| Model      | Suction Connection Size | Discharge Connection Size |
|------------|-------------------------|---------------------------|
| REB3-0150* | 1/2" ODF                | 1/3" ODF                  |
| REK3-0125* | 1/2" ODF                | 1/3" ODF                  |
| REL3-0200* | 1/2" ODF                | 1/3" ODF                  |
| RES3-0175* | 1/2" ODF                | 1/3" ODF                  |
| REY3-0175* | 1/2" ODF                | 1/3" ODF                  |
| REZ3-0125* | 1/2" ODF                | 1/3" ODF                  |
| RF18C1*    | 1/2" ODF                | 3/8" ODF                  |
| RF18C2*    | 1/2" ODF                | 3/8" ODF                  |
| RF40C1*    | 1/2" ODF                | 3/8" ODF                  |
| RF41C1*    | 1/2" ODF                | 3/8" ODF                  |
| RF41C5*    | 1/2" ODF                | 3/8" ODF                  |
| RF42C1*    | 1/2" ODF                | 3/8" ODF                  |
| RFT18C1*   | 3/8" ODF                | 1/4" ODF                  |
| RFT22C1*   | 3/8" ODF                | 1/4" ODF                  |
| RFT26C1*   | 3/8" ODF                | 1/4" ODF                  |
| RFT29C1*   | 3/8" ODF                | 1/4" ODF                  |
| RFT32C1*   | 3/8" ODF                | 1/4" ODF                  |
| RFT42C1*   | 3/8" ODF                | 1/4" ODF                  |
| RR10K1*    | 1/2" ODF                | 3/8" ODF                  |
| RR10K2*    | 1/2" ODF                | 3/8" ODF                  |
| RR12K1*    | 1/2" ODF                | 3/8" ODF                  |
| RR14K1*    | 1/2" ODF                | 1/3" ODF                  |
| RR16K1*    | 1/2" ODF                | 3/8" ODF                  |
| RR17K1*    | 1/2" ODF                | 1/3" ODF                  |
| RR20K1*    | 1/2" ODF                | 1/3" ODF                  |
| RR81C1*    | 1/2" ODF                | 3/8" ODF                  |
| RR81C2*    | 1/2" ODF                | 3/8" ODF                  |
| RRG4-0100* | 3/8" ODF                | 1/4" ODF                  |
| RRK4-0126* | 3/8" ODF                | 1/4" ODF                  |
| RRL4-0100* | 1/2" ODF                | 1/4" ODF                  |
| RRL6-0100* | 1/2" ODF                | 1/4" ODF                  |
| RRS4-0075* | 1/2" ODF                | 1/4" ODF                  |
| RRT10K1*   | 1/2" ODF                | 3/8" ODF                  |
| RRT62C1*   | 3/8" ODF                | 1/4" ODF                  |
| RRT64C1*   | 3/8" ODF                | 1/4" ODF                  |
| RRT73C1*   | 3/8" ODF                | 1/4" ODF                  |
| RRT81C1*   | 1/2" ODF                | 3/8" ODF                  |
| RS40C1*    | 1/2" ODF                | 3/8" ODF                  |
| RS40C2*    | 1/2" ODF                | 3/8" ODF                  |
| RS43C1*    | 1/2" ODF                | 3/8" ODF                  |

| Model      | Suction Connection Size | Discharge Connection Size |
|------------|-------------------------|---------------------------|
| RS43C2*    | 1/2" ODF                | 3/8" ODF                  |
| RS47C2*    | 3/8" ODF                | 1/4" ODF                  |
| RS54C1*    | 1/2" ODF                | 3/8" ODF                  |
| RS54C2*    | 1/2" ODF                | 3/8" ODF                  |
| RS55C1*    | 1/2" ODF                | 3/8" ODF                  |
| RS55C2*    | 1/2" ODF                | 3/8" ODF                  |
| RS64C1*    | 1/2" ODF                | 3/8" ODF                  |
| RS64C2*    | 1/2" ODF                | 3/8" ODF                  |
| RS70C1*    | 1/2" ODF                | 3/8" ODF                  |
| RS80C1*    | 1/2" ODF                | 3/8" ODF                  |
| RS80C2*    | 1/2" ODF                | 3/8" ODF                  |
| RS86C2*    | 1/2" ODF                | 3/8" ODF                  |
| RS97C1*    | 1/2" ODF                | 3/8" ODF                  |
| RS97C2*    | 1/2" ODF                | 3/8" ODF                  |
| RS97CE*    | 1/2" ODF                | 3/8" ODF                  |
| RSE4-0075* | 3/8" ODF                | 1/4" ODF                  |
| RSE4-0076* | 3/8" ODF                | 1/4" ODF                  |
| RSF2-0050* | 3/8" ODF                | 1/4" ODF                  |
| RSL2-0075* | 1/2" ODF                | 1/4" ODF                  |
| RSL2-0100* | 1/2" ODF                | 1/4" ODF                  |
| RSL2-0101* | 1/2" ODF                | 1/4" ODF                  |
| RSL5-0101* | 1/2" ODF                | 3/8" ODF                  |
| RSN4-0050* | 3/8" ODF                | 1/4" ODF                  |
| RSN4-0075* | 3/8" ODF                | 1/4" ODF                  |
| RSN4-0100* | 3/8" ODF                | 1/4" ODF                  |
| RSN5-0075* | 1/2" ODF                | 1/4" ODF                  |
| RSN6-0075* | 3/8" ODF                | 1/4" ODF                  |
| RSU4-0050* | 3/8" ODF                | 1/4" ODF                  |
| RSU5-0050* | 3/8" ODF                | 1/4" ODF                  |
| RST10K1*   | 1/2" ODF                | 3/8" ODF                  |
| RST40C1*   | 3/8" ODF                | 1/4" ODF                  |
| RST45C1*   | 3/8" ODF                | 1/4" ODF                  |
| RST55C1*   | 3/8" ODF                | 1/4" ODF                  |
| RST61C1*   | 3/8" ODF                | 1/4" ODF                  |
| RST64C1*   | 3/8" ODF                | 1/4" ODF                  |
| RST70C1*   | 1/2" ODF                | 3/8" ODF                  |
| RST80C1*   | 1/2" ODF                | 3/8" ODF                  |
| RST97C1*   | 1/2" ODF                | 3/8" ODF                  |

Standard connection sizes are shown above. The connection sizes may vary on special OEM Bill of Materials.

# Quick Reference Guide

## Z-model Sweat Connection Sizes

| Model               | Suction Connection Size | Discharge Connection Size |
|---------------------|-------------------------|---------------------------|
| <b>1.3 - 2.0 HP</b> |                         |                           |
| ZB10K               | 3/4" ODF                | 1/2" ODF                  |
| ZB11K               | 3/4" ODF                | 1/2" ODF                  |
| ZB13K               | 3/4" ODF                | 1/2" ODF                  |
| ZB14K               | 3/4" ODF                | 1/2" ODF                  |
| ZP14K               | 3/4" ODF                | 1/2" ODF                  |
| ZP16K               | 3/4" ODF                | 1/2" ODF                  |
| ZP20K               | 3/4" ODF                | 1/2" ODF                  |
| ZP21K               | 3/4" ODF                | 1/2" ODF                  |
| ZP22K               | 3/4" ODF                | 1/2" ODF                  |
| ZP23K               | 3/4" ODF                | 1/2" ODF                  |
| ZP24K               | 3/4" ODF                | 1/2" ODF                  |
| ZR16K               | 3/4" ODF                | 1/2" ODF                  |
| ZR18K               | 3/4" ODF                | 1/2" ODF                  |
| ZR18K               | 3/4" ODF                | 1/2" ODF                  |
| ZR21K               | 3/4" ODF                | 1/2" ODF                  |
| ZR22K               | 3/4" ODF                | 1/2" ODF                  |
| ZR24K               | 3/4" ODF                | 1/2" ODF                  |
| ZS09K               | 3/4" ODF                | 1/2" ODF                  |
| ZS11K               | 3/4" ODF                | 1/2" ODF                  |
| ZS13K               | 3/4" ODF                | 1/2" ODF                  |
| <b>2.0 - 3.5 HP</b> |                         |                           |
| ZB15K               | 3/4" ODF                | 1/2" ODF                  |
| ZB19K               | 3/4" ODF                | 1/2" ODF                  |
| ZB21K               | 3/4" ODF                | 1/2" ODF                  |
| ZB26K               | 3/4" ODF                | 1/2" ODF                  |
| ZB29K               | 7/8" ODF                | 1/2" ODF                  |
| ZF06K               | 3/4" ODF                | 1/2" ODF                  |
| ZF08K               | 3/4" ODF                | 1/2" ODF                  |
| ZF09K               | 3/4" ODF                | 1/2" ODF                  |
| ZF11K               | 3/4" ODF                | 1/2" ODF                  |
| ZP25K               | 3/4" ODF                | 1/2" ODF                  |
| ZP26K               | 3/4" ODF                | 1/2" ODF                  |
| ZP28K               | 3/4" ODF                | 1/2" ODF                  |
| ZP29K               | 3/4" ODF                | 1/2" ODF                  |
| ZP31K               | 3/4" ODF                | 1/2" ODF                  |
| ZP32K               | 3/4" ODF                | 1/2" ODF                  |
| ZP34K               | 7/8" ODF                | 1/2" ODF                  |
| ZP36K3              | 3/4" ODF                | 1/2" ODF                  |
| ZP36K5              | 7/8" ODF                | 1/2" ODF                  |
| ZP38K3/C            | 3/4" ODF                | 1/2" ODF                  |
| ZP38K5              | 7/8" ODF                | 1/2" ODF                  |

| Model                       | Suction Connection Size | Discharge Connection Size |
|-----------------------------|-------------------------|---------------------------|
| <b>2.0 - 3.5 HP (cont.)</b> |                         |                           |
| ZP39K                       | 7/8" ODF                | 1/2" ODF                  |
| ZP41K                       | 3/4" ODF                | 1/2" ODF                  |
| ZP42K                       | 7/8" ODF                | 1/2" ODF                  |
| ZP44K3/C                    | 3/4" ODF                | 1/2" ODF                  |
| ZP44K5                      | 7/8" ODF                | 1/2" ODF                  |
| ZR25K                       | 3/4" ODF                | 1/2" ODF                  |
| ZR26K                       | 3/4" ODF                | 1/2" ODF                  |
| ZR28K                       | 3/4" ODF                | 1/2" ODF                  |
| ZR30K                       | 3/4" ODF                | 1/2" ODF                  |
| ZR32K                       | 3/4" ODF                | 1/2" ODF                  |
| ZR34K                       | 3/4" ODF                | 1/2" ODF                  |
| ZR35K                       | 3/4" ODF                | 1/2" ODF                  |
| ZR36K                       | 3/4" ODF                | 1/2" ODF                  |
| ZR38K                       | 7/8" ODF                | 1/2" ODF                  |
| ZR40K                       | 3/4" ODF                | 1/2" ODF                  |
| ZR42K3                      | 3/4" ODF                | 1/2" ODF                  |
| ZR42K5                      | 7/8" ODF                | 1/2" ODF                  |
| ZR44K                       | 7/8" ODF                | 1/2" ODF                  |
| ZR45K                       | 7/8" ODF                | 1/2" ODF                  |
| ZR46K                       | 7/8" ODF                | 1/2" ODF                  |
| ZS15K                       | 3/4" ODF                | 1/2" ODF                  |
| ZS19K                       | 3/4" ODF                | 1/2" ODF                  |
| ZS21K                       | 3/4" ODF                | 1/2" ODF                  |
| ZS26K                       | 3/4" ODF                | 1/2" ODF                  |
| <b>4.0 - 6.0 HP</b>         |                         |                           |
| ZB30K                       | 7/8" ODF                | 1/2" ODF                  |
| ZB38K                       | 7/8" ODF                | 1/2" ODF                  |
| ZB42K                       | 7/8" ODF                | 1/2" ODF                  |
| ZB45K                       | 7/8" ODF                | 1/2" ODF                  |
| ZB48K                       | 7/8" ODF                | 3/4" ODF                  |
| ZF13K                       | 7/8" ODF                | 1/2" ODF                  |
| ZF15K                       | 7/8" ODF                | 1/2" ODF                  |
| ZF18K                       | 7/8" ODF                | 1/2" ODF                  |
| ZP50K                       | 7/8" ODF                | 1/2" ODF                  |
| ZP51K                       | 7/8" ODF                | 1/2" ODF                  |
| ZP54K                       | 7/8" ODF                | 1/2" ODF                  |
| ZP57K                       | 7/8" ODF                | 1/2" ODF                  |
| ZP61K                       | 7/8" ODF                | 1/2" ODF                  |
| ZP67K                       | 7/8" ODF                | 1/2" ODF                  |
| ZP70K                       | 7/8" ODF                | 1/2" ODF                  |
| ZP72K                       | 7/8" ODF                | 1/2" ODF                  |

Standard connection sizes are shown above. The connection sizes may vary on special OEM Bill of Materials.

## Z-model Sweat Connection Sizes

| Model                       | Suction Connection Size | Discharge Connection Size |
|-----------------------------|-------------------------|---------------------------|
| <b>4.0 - 6.0 HP (cont.)</b> |                         |                           |
| ZP76K                       | 7/8" ODF                | 1/2" ODF                  |
| ZP83K                       | 7/8" ODF                | 1/2" ODF                  |
| ZR49K                       | 7/8" ODF                | 1/2" ODF                  |
| ZR54K                       | 7/8" ODF                | 1/2" ODF                  |
| ZR57K                       | 7/8" ODF                | 1/2" ODF                  |
| ZR61K                       | 7/8" ODF                | 1/2" ODF                  |
| ZR67K                       | 7/8" ODF                | 1/2" ODF                  |
| ZR68K                       | 7/8" ODF                | 1/2" ODF                  |
| ZR72K                       | 7/8" ODF                | 1/2" ODF                  |
| ZR80K                       | 7/8" ODF                | 3/4" ODF                  |
| ZR81K                       | 7/8" ODF                | 3/4" ODF                  |
| ZS29K                       | 7/8" ODF                | 1/2" ODF                  |
| ZS30K                       | 7/8" ODF                | 1/2" ODF                  |
| ZS33K                       | 7/8" ODF                | 1/2" ODF                  |
| ZS38K                       | 7/8" ODF                | 1/2" ODF                  |
| ZS45K                       | 7/8" ODF                | 1/2" ODF                  |
| <b>7.0 - 15.0 HP</b>        |                         |                           |
| ZB50K                       | 1-1/8" ODF              | 7/8" ODF                  |
| ZB58K                       | 1-1/8" ODF              | 7/8" ODF                  |
| ZB66K                       | 1-3/8" ODF              | 7/8" ODF                  |
| ZB76K                       | 1-3/8" ODF              | 7/8" ODF                  |
| ZB88K                       | 1-3/8" ODF              | 7/8" ODF                  |
| ZB95K                       | 1-3/8" ODF              | 7/8" ODF                  |
| ZB114K                      | 1-3/8" ODF              | 7/8" ODF                  |
| ZF25K                       | 7/8" ODF                | 3/4" ODF                  |
| ZR84K                       | 1-1/8" ODF              | 7/8" ODF                  |
| ZR94K                       | 1-1/8" ODF              | 7/8" ODF                  |
| ZR11M                       | 1-3/8" ODF              | 7/8" ODF                  |
| ZR108K                      | 1-3/8" ODF              | 7/8" ODF                  |
| ZR125K                      | 1-3/8" ODF              | 7/8" ODF                  |
| ZR144K                      | 1-3/8" ODF              | 7/8" ODF                  |
| ZR160K                      | 1-3/8" ODF              | 7/8" ODF                  |
| ZR190K                      | 1-3/8" ODF              | 7/8" ODF                  |
| ZP90K                       | 1-1/8" ODF              | 7/8" ODF                  |
| ZP91K                       | 7/8" ODF                | 3/4" ODF                  |
| ZP103K                      | 1-3/8" ODF              | 7/8" ODF                  |
| ZP104K                      | 1-1/8" ODF              | 7/8" ODF                  |
| ZP120K                      | 1-3/8" ODF              | 7/8" ODF                  |
| ZP137K                      | 1-3/8" ODF              | 7/8" ODF                  |
| ZP154K                      | 1-3/8" ODF              | 7/8" ODF                  |
| ZP181K                      | 1-3/8" ODF              | 7/8" ODF                  |

| Model                | Suction Connection Size | Discharge Connection Size |
|----------------------|-------------------------|---------------------------|
| <b>7.5 - 15.0 HP</b> |                         |                           |
| ZB11M                | 1-5/8" ODF              | 1-3/8" ODF                |
| ZB56K                | 1-3/8" ODF              | 7/8" ODF                  |
| ZB68K                | 1-3/8" ODF              | 7/8" ODF                  |
| ZB75K                | 1-3/8" ODF              | 7/8" ODF                  |
| ZB92K                | 1-3/8" ODF              | 7/8" ODF                  |
| ZF24K                | 1-3/8" ODF              | 7/8" ODF                  |
| ZF33K                | 1-3/8" ODF              | 7/8" ODF                  |
| ZF40K                | 1-3/8" ODF              | 7/8" ODF                  |
| ZF48K                | 1-5/8" ODF              | 1-3/8" ODF                |
| ZR11M                | 1-3/8" ODF              | 7/8" ODF                  |
| ZR12M                | 1-3/8" ODF              | 7/8" ODF                  |
| ZR16M                | 1-3/8" ODF              | 7/8" ODF                  |
| ZR19M                | 1-5/8" ODF              | 1-1/8" ODF                |
| ZR90K                | 1-3/8" ODF              | 7/8" ODF                  |
| ZS11M                | 1-5/8" ODF              | 1-3/8" ODF                |
| ZS56K                | 1-3/8" ODF              | 7/8" ODF                  |
| ZS75K                | 1-3/8" ODF              | 7/8" ODF                  |
| ZS92K                | 1-3/8" ODF              | 7/8" ODF                  |
| ZP180K               | 1-5/8" ODF              | 1-1/8" ODF                |
| <b>LCS</b>           |                         |                           |
| ZR250K               | 1-5/8" ODF              | 1-3/8" ODF                |
| ZR300K               | 2-1/8" ODF              | 1-3/8" ODF                |
| ZR310K               | 1-5/8" ODF              | 1-3/8" ODF                |
| ZR380K               | 1-5/8" ODF              | 1-3/8" ODF                |
| ZP235K               | 1-5/8" ODF              | 1-3/8" ODF                |
| ZP236K               | 1-5/8" ODF              | 1-3/8" ODF                |
| ZP285K               | 2-1/8" ODF              | 1-3/8" ODF                |
| ZP295K               | 1-5/8" ODF              | 1-3/8" ODF                |
| ZP296K               | 1-5/8" ODF              | 1-3/8" ODF                |
| ZP385K               | 1-5/8" ODF              | 1-3/8" ODF                |
| ZP485K               | 1-5/8" ODF              | 1-3/8" ODF                |

Standard connection sizes are shown above. The connection sizes may vary on special OEM Bill of Materials.



## Single Rotalock Valve Kits

| Kit Number  | Connection Size | Thread Size    | Valve Part Number | Gasket Part Number |
|-------------|-----------------|----------------|-------------------|--------------------|
| 998-0510-42 | 3/8" Flare      | 1 - 14 UNC     | 510-0132-02       | 020-0028-00        |
| 998-0510-43 | 3/8" Sweat      | 1 - 14 UNC     | 510-0133-00       | 020-0028-00        |
| 998-0510-40 | 1/2" Flare      | 1 - 14 UNC     | 510-0132-00       | 020-0028-00        |
| 998-0510-44 | 1/2" Sweat      | 1 - 14 UNC     | 510-0133-09       | 020-0028-00        |
| 998-0510-41 | 5/8" Flare      | 1 - 14 UNC     | 510-0132-01       | 020-0028-00        |
| 998-0510-45 | 5/8" Sweat      | 1 - 14 UNC     | 510-0133-02       | 020-0028-00        |
| 998-0510-52 | 7/8" Sweat      | 1 - 14 UNC     | 510-0133-13       | 020-0028-00        |
| 998-0510-38 | 3/4" Sweat      | 1-1/4 - 12 UNC | 510-0080-04       | 020-0028-02        |
| 998-0510-90 | 7/8" Sweat      | 1-1/4 - 12 UNC | 510-0133-04       | 020-0028-02        |
| 998-0510-51 | 1-1/8" Sweat    | 1-1/4 - 12 UNC | 510-0133-12       | 020-0028-02        |
| 998-0510-37 | 7/8" Sweat      | 1-3/4 - 12 UNC | 510-0330-02       | 020-0028-03        |
| 998-0510-02 | 1-1/8" Sweat    | 1-3/4 - 12 UNC | 510-0330-01       | 020-0028-03        |
| 998-0510-46 | 1-3/8" Sweat    | 1-3/4 - 12 UNC | 510-0330-00       | 020-0028-03        |
| 998-0510-66 | 1-5/8" Sweat    | 1-3/4 - 12 UNC | 510-0323-00       | 020-0028-03        |
| 998-0510-67 | 1-3/8" Sweat    | 2-1/4 - 12 UNC | 510-0402-01       | 020-0941-00        |
| 998-0510-68 | 1-5/8" Sweat    | 2-1/4 - 12 UNC | 510-0402-00       | 020-0941-00        |



## Suction and Discharge Rotalock Valve Kits

| Kit Number  | Suction Size/Style | Suction Thread Size | Discharge Size/Style | Discharge Thread Size |
|-------------|--------------------|---------------------|----------------------|-----------------------|
| 998-5100-24 | 1-1/8" Sweat       | 1-3/4 - 12 UNC      | 3/4" Sweat           | 1-1/4 - 12 UNC        |
| 998-5100-17 | 1-1/8" Sweat       | 1-3/4 - 12 UNC      | 7/8" Sweat           | 1-1/4 - 12 UNC        |
| 998-5100-16 | 1-3/8" Sweat       | 1-3/4 - 12 UNC      | 3/4" Sweat           | 1-1/4 - 12 UNC        |
| 998-5100-27 | 1-3/8" Sweat       | 1-3/4 - 12 UNC      | 7/8" Sweat           | 1-1/4 - 12 UNC        |
| 998-5100-41 | 1-3/8" Sweat       | 2-1/4 - 12 UNC      | 1-1/8" Sweat         | 1-3/4 - 12 UNC        |
| 998-5100-39 | 1-5/8" Sweat       | 2-1/4 - 12 UNC      | 1-1/8" Sweat         | 1-3/4 - 12 UNC        |
| 998-5100-38 | 1-5/8" Sweat       | 2-1/4 - 12 UNC      | 1-3/8" Sweat         | 1-3/4 - 12 UNC        |

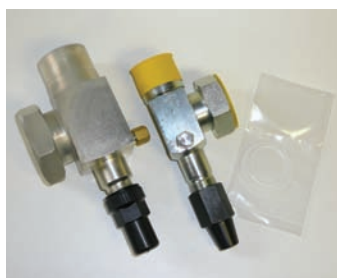

## Stub Tube to Rotalock Adapter Kits

| Kit Part Number | Stub Tube I.D. | Thread Size |
|-----------------|----------------|-------------|
| 998-0034-14     | 3/8"           | 1" - 14     |
| 998-0034-15     | 1/2"           | 1" - 14     |
| 998-0034-16     | 5/8"           | 1" - 14     |
| 998-0034-01     | 3/4"           | 1-1/4" - 12 |
| 998-0034-02     | 7/8"           | 1-1/4" - 12 |
| 998-0034-03     | 1-1/8"         | 1-3/4" - 12 |
| 998-0034-04     | 1-3/8"         | 1-3/4" - 12 |
| 998-0034-06     | 1-5/8"         | 2-1/4" - 12 |

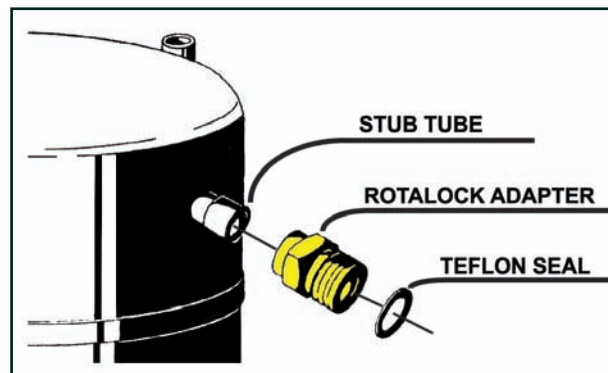

## Rotalock to Stub Tube Adapter Kits

| Kit Part Number | Thread Size | I.D.   |
|-----------------|-------------|--------|
| 998-0034-18     | 1" - 14     | 1/2"   |
| 998-0034-17     | 1" - 14     | 5/8"   |
| 998-0034-07     | 1-1/4" - 12 | 3/4"   |
| 998-0034-08     | 1-1/4" - 12 | 7/8"   |
| 998-0034-09     | 1-1/4" - 12 | 1-1/8" |
| 998-0034-10     | 1-3/4" - 12 | 1-1/8" |
| 998-0034-13     | 1-3/4" - 12 | 1-3/8" |
| 998-0034-11     | 2-1/4" - 12 | 1-3/8" |
| 998-0034-12     | 2-1/4" - 12 | 1-5/8" |

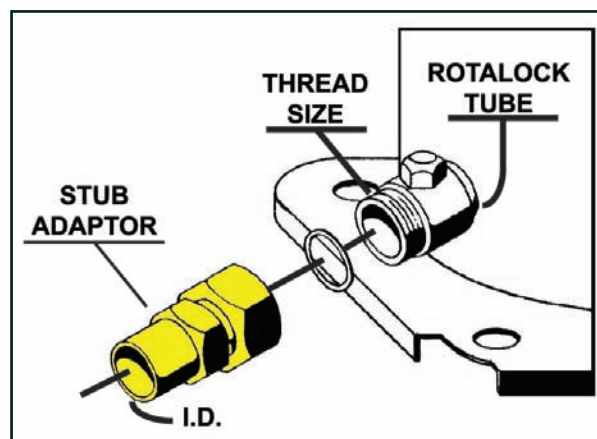

# Quick Reference Guide

## Semi-Hermetic Compressor Oil Charges

### Discus Models

| Model Family | Standard |          | Deep Sump |          |
|--------------|----------|----------|-----------|----------|
|              | Initial  | Recharge | Initial   | Recharge |
| 2D           | 80       | 72       | 110       | 95       |
| 3D           | 115      | 105      | 190       | 170      |
| 4DA3A100E    | 140      | 130      | -         | -        |
| 4DL3A150E    | 135      | 120      | 250       | 235      |
| 4DA3A200E    | 135      | 120      | 250       | 235      |
| 4DT3A220E    | 130      | 120      | 245       | 235      |
| 4DH3A250E    | 130      | 120      | 245       | 235      |
| 4DJ3A300E    | 140      | 125      | 255       | 240      |
| 4DA3R12ME    | 140      | 130      | -         | -        |
| 4DL3F63KE    | 135      | 120      | 250       | 235      |
| 4DA3R18ME    | 135      | 120      | 250       | 235      |
| 4DT3F76KE    | 130      | 120      | 245       | 235      |
| 4DH3R22ME    | 130      | 120      | 245       | 235      |
| 4DJ3R28ME    | 140      | 125      | 255       | 240      |
| 6D           | 140      | 130      | 255       | 245      |
| 6DT3A300*    | 255      | 245      | 255       | 245      |
| 6DJ3A400*    | 255      | 245      | 255       | 245      |
| 6DT3F11M*    | 255      | 245      | 255       | 245      |
| 6DJ3R40M*    | 255      | 245      | 255       | 245      |

### Non-Discus Models

| Model Family | Standard |          | Deep Sump |          |
|--------------|----------|----------|-----------|----------|
|              | Initial  | Recharge | Initial   | Recharge |
| H            | 22       | 16       | -         | -        |
| K            | 22       | 20       | -         | -        |
| E            | 60       | 55       | -         | -        |
| 3            | 70       | 65       | -         | -        |
| L            | 80       | 75       | -         | -        |
| M            | 80       | 70       | 110       | 95       |
| N            | 70       | 70       | -         | -        |
| 4RA          | 135      | 120      | 250       | 235      |
| 4RH          | 130      | 120      | 245       | 235      |
| 4RJ          | 140      | 125      | 255       | 240      |
| 6R           | 140      | 130      | 255       | 245      |
| 9R           | 115      | 105      | 165       | 155      |

## 3D Moduload

3DE3-0500-TFC

3DE3-0500-TFD

3DE3-0500-TFE

3DE3-0750-TFC

3DE3-0750-TFD

3DE3-0750-TFE

3DE3-075E-TFC

3DE3-075E-TFD

3DE3-075E-TFE

3DG3-0900-TFC

3DG3-0900-TFD

3DG3-0900-TFE

3DG3-090E-TFC

3DG3-090E-TFD

3DG3-090E-TFE

3DGH-090E-TFC

3DGH-090E-TFD

3DGH-090E-TFE

3DH3-0600-TFC

3DH3-0600-TFD

3DH3-0600-TFE

3DH3-060E-TFC

3DH3-060E-TFD

3DH3-060E-TFE

3DHH-060E-TFC

3DHH-060E-TFD

3DHH-060E-TFE

3DJ3-0750-TFC

3DJ3-0750-TFD

3DJ3-0750-TFE

3DJ3-075E-TFC

3DJ3-075E-TFD

3DJ3-075E-TFE

3DJH-075E-TFC

3DJH-075E-TFD

3DJH-075E-TFE

3DK3-0750-TFC

3DK3-0750-TFD

3DK3-0900-TFC

3DK3-0900-TFD

3DK3-0900-TFE

3DK3-1200-TFC

3DK3-1200-TFD

3DK3-120E-TFC

3DK3-120E-TFD

3DK4-1200-TFD

3DK8-0750-TFC

3DK8-0750-TFD

3DK8-075E-TFD

3DKB-0750-TFC

3DKB-0750-TFD

3DKH-120E-TFC

3DKH-120E-TFD

3DP3-0500-FSM

3DP3-0500-TFC

3DP3-0500-TFD

3DP3-0500-TFE

3DP3-0750-TFC

3DP3-0750-TFD

3DP3-0750-TFE

3DP3-075E-TFD

3DP3-1000-TFC

3DP3-1000-TFD

3DP3-1000-TFE

3DP3-100E-TFC

3DP3-100E-TFD

3DP3-100E-TFE

3DPH-100E-TFC

3DPH-100E-TFD

3DPH-100E-TFE

3DR3-1000-TFC

3DR3-1000-TFD

3DR3-1000-TFE

3DR3-100E-TFC

3DR3-100E-TFD

3DR3-100E-TFE

3DRH-100E-TFC

3DRH-100E-TFD

3DRH-100E-TFE

3DE3A0500-TFC

3DE3A0500-TFD

3DE3A0500-TFE

3DE3A0750-TFC

3DE3A0750-TFD

3DE3A0750-TFE

3DE3A075E-TFC

3DE3A075E-TFD

3DE3A075E-TFE

3DEHA075E-TFC

3DEHA075E-TFD

3DEHA075E-TFE

3DG3A0900-TFC

3DG3A0900-TFE

3DG3A090E-TFC

3DG3A090E-TFD

3DG3A090E-TFE

3DGHA090E-TFC

3DGHA090E-TFD

3DGHA090E-TFE

3DH3A0600-TFC

3DH3A0600-TFD

3DH3A0600-TFE

3DH3A060E-TFC

3DH3A060E-TFD

3DH3A060E-TFE

3DHHA060E-TFC

3DHHA060E-TFD

3DHHA060E-TFE

3DJ3A0750-TFC

3DJ3A0750-TFD

3DJ3A0750-TFE

3DJ3A075E-TFC

3DJ3A075E-TFD

3DJ3A075E-TFE

3DJHA075E-TFC

3DJHA075E-TFD

3DJHA075E-TFE

3DK3A0750-TFC

3DK3A0750-TFD

3DK3A0900-TFC

3DK3A0900-TFD

3DK3A0900-TFE

3DK3A1200-TFC

3DK3A1200-TFD

3DK3A120E-TFC

3DK3A120E-TFD

3DKHA120E-TFC

3DKHA120E-TFD

3DP3A0500-TFC

3DP3A0500-TFD

3DP3A0500-TFE

3DP3A0750-TFC

3DP3A0750-TFD

3DP3A0750-TFE

3DP3A075E-TFD

3DP3A1000-TFC

3DP3A1000-TFD

3DP3A1000-TFE

3DP3A100E-TFC

3DP3A100E-TFD

3DP3A100E-TFE

3DPHA100E-TFC

3DPHA100E-TFD

3DPHA100E-TFE

3DR3A1000-TFC

3DR3A1000-TFD

3DR3A1000-TFE

3DRHA100E-TFC

3DRHA100E-TFD

3DRHA100E-TFE

3DT3A0750-TFC

3DT3A0750-TFD

3DT3A0750-TFE

3DT3A1000-TFC

3DT3A1000-TFD

3DT3A1000-TFE

3DT3A1500-TFC

3DT3A1500-TFD

3DT3A1500-TFE

3DT3A150E-TFC

3DT3A150E-TFD

3DT3A150E-TFE

3DTHA150E-TFC

3DTHA150E-TFD

3DTHA150E-TFE

# Quick Reference Guide

- 4DC3-2200-FSD
- 4DC3-2200-TSE
- 4DC3-2200-TSK
- 4DC3-220E-FSD
- 4DC3-220E-TSE
- 4DC3-220E-TSK
- 4DE1-1000-TSE
- 4DE1-1000-TSK
- 4DE1-2000-FSD
- 4DE1-2000-TSE
- 4DE1-2000-TSK
- 4DE2-2000-TSK
- 4DE3-100E-TSK
- 4DE3-2000-FSD
- 4DE3-2000-TSE
- 4DE3-2000-TSK
- 4DE3-200E-FSD
- 4DE3-200E-TSE
- 4DE3-200E-TSK
- 4DE4-2000-TSK
- 4DE5-2000-TSK
- 4DE8-2000-FSD
- 4DE8-200E-TSK
- 4DK1-1500-TSK
- 4DK1-2500-FSD
- 4DK1-2500-TSE
- 4DK1-2500-TSK
- 4DK3-150E-FSM
- 4DK3-150E-TSE
- 4DK3-150E-TSK
- 4DK3-2500-FSD
- 4DK3-2500-TSE
- 4DK3-2500-TSK
- 4DK3-250E-FSD
- 4DK3-250E-TSE
- 4DK3-250E-TSK
- 4DN1-1000-FSD
- 4DN1-1000-TSE
- 4DN1-1000-TSK
- 4DN3-1000-FSD
- 4DN3-1000-TSE
- 4DN3-1000-TSK
- 4DN3-100E-FSD
- 4DN3-100E-TSE
- 4DN3-1010-TSE
- 4DN3-1010-TSK
- 4DN3-101E-TSE
- 4DN3-101E-TSK
- 4DN3-1500-FSD
- 4DN3-1500-TSE
- 4DP3-1500-TSK
- 4DP3-150E-FSD
- 4DP3-150E-TSE
- 4DP3-150E-TSK
- 4DP8-1500-TSK
- 4DP8-150E-TSK
- 4DR1-2000-TSE
- 4DR1-2000-TSK
- 4DR1-3000-FSD
- 4DR1-3000-TSE
- 4DR1-3000-TSK
- 4DR3-200E-FSM
- 4DR3-200E-TSE
- 4DR3-200E-TSK
- 4DR3-3000-FSD
- 4DR3-3000-TSE
- 4DR3-3000-TSK
- 4DR3-300E-FSD
- 4DR3-300E-TSE
- 4DR3-300E-TSK
- 4DR8-200E-TSK
- 4DRB-2000-TSE
- 4DRB-2000-TSK
- 4DS1-2200-FSD
- 4DS1-2200-TSE
- 4DS1-2200-TSK
- 4DS3-2200-FSD
- 4DS3-2200-TSE
- 4DS3-2200-TSK
- 4DS3-220E-FSD
- 4DS3-220E-TSE
- 4DS3-220E-TSK
- 4DC3A2200-TSE
- 4DC3A2200-TSK
- 4DC3A220E-FSD
- 4DC3A220E-TSE
- 4DC3A220E-TSK
- 4DE1A1000-TSE
- 4DE1A1000-TSK
- 4DE1A2000-FSD
- 4DE1A2000-TSE
- 4DE1A2000-TSK
- 4DE2A2000-TSK
- 4DE3A100E-TSK
- 4DE3A2000-FSD
- 4DE3A2000-TSE
- 4DE3A2000-TSK
- 4DE3A200E-FSD
- 4DE3A200E-TSE
- 4DE3A200E-TSK
- 4DE4A2000-TSK
- 4DE8A2000-FSD
- 4DE8A200E-TSK
- 4DK1A1500-TSK
- 4DK1A2500-FSD
- 4DK1A2500-TSE
- 4DK3A150E-FSM
- 4DK3A150E-TSE
- 4DK3A150E-TSK
- 4DK3A2500-FSD
- 4DK3A2500-TSE
- 4DK3A2500-TSK
- 4DK3A250E-FSD
- 4DK3A250E-TSE
- 4DK3A250E-TSK
- 4DN1A1000-FSD
- 4DN1A1000-TSE
- 4DN1A1000-TSK
- 4DN3A1000-FSD
- 4DN3A1000-TSE
- 4DN3A1000-TSK
- 4DN3A100E-FSD
- 4DN3A100E-TSE
- 4DN3A1010-TSE
- 4DN3A1010-TSK
- 4DN3A101E-TSE
- 4DN3A101E-TSK
- 4DP1A1500-FSD
- 4DP1A1500-TSK
- 4DP3A1500-FSD
- 4DP3A1500-TSE
- 4DP3A1500-TSK
- 4DP3A150E-FSD
- 4DP3A150E-TSE
- 4DP3A150E-TSK
- 4DP8A1500-TSK
- 4DP8A150E-TSK
- 4DR1A2000-TSE
- 4DR1A2000-TSK
- 4DR1A3000-FSD
- 4DR1A3000-TSE
- 4DR1A3000-TSK
- 4DR3A200E-TSE
- 4DR3A200E-TSK
- 4DR3A3000-FSD
- 4DR3A3000-TSE
- 4DR3A3000-TSK
- 4DR3A300E-FSD
- 4DR3A300E-TSE
- 4DR3A300E-TSK
- 4DR8A200E-TSK
- 4DS1A2200-FSD
- 4DS1A2200-TSE
- 4DS1A2200-TSK
- 4DS3A2200-FSD
- 4DS3A2200-TSE
- 4DS3A2200-TSK
- 4DS3A220E-FSD
- 4DS3A220E-TSE
- 4DS3A220E-TSK
- 4RE2-1000-FSM
- 4RE2-1000-TSE
- 4RE2-1000-TSK
- 4RE2-2000-FSD
- 4RE2-2000-TSE
- 4RE2-2000-TSK
- 4RK2-1500-FSM
- 4RK2-1500-TSE
- 4RK2-1500-TSK
- 4RK2-2500-FSD
- 4RK2-2500-TSE
- 4RK2-2500-TSK
- 4RR1-3000-FSD
- 4RR1-3000-TSE
- 4RR1-3000-TSK
- 4RR2-3000-FSD
- 4RR2-3000-TSE
- 4RR2-3000-TSK
- D 4DBXF54KE-TSE
- D 4DBXF54KE-TSK
- D 4DBXR20ME-FSD
- D 4DBXR20ME-TSE
- D 4DBXR20ME-TSK
- 4DCNF54KE-TSE
- 4DCNF54KE-TSK
- 4DCNR20ME-FSD
- 4DCNR20ME-TSE
- 4DCNR20ME-TSK
- D 4DHXF63KE-FSD
- D 4DHXF63KE-TSE
- D 4DHXF63KE-TSK
- D 4DHXR22ME-FSD
- D 4DHXR22ME-TSE
- D 4DHXR22ME-TSK
- D 4DJXF76ME-FSD
- D 4DJXF76ME-TSE
- D 4DJXF76ME-TSK
- D 4DJXR28ME-FSD
- D 4DJXR28ME-TSE
- D 4DJXR28ME-TSK
- 4DKNF63KE-FSD
- 4DKNF63KE-TSE
- 4DKNF63KE-TSK
- 4DKNR16ME-TSE
- 4DKNR16ME-TSK
- 4DKNR22ME-FSD
- 4DKNR22ME-TSE
- 4DKNR22ME-TSK
- 4DRNF76KE-FSD
- 4DRNF76KE-TSE
- 4DRNF76KE-TSK
- 4DRNR19ME-TSK
- 4DRNR28ME-FSD
- 4DRNR28ME-TSE
- 4DRNR28ME-TSK

D = Digital Model  
• = 1 Bank Unloading



# Quick Reference Guide

|                  |                  |                  |                 |
|------------------|------------------|------------------|-----------------|
| • 6DK3A350E-TSK  | • 6DR3A400E-FSU  | •• 6RN2-2000-FSD | • 6DKNF93KE-FSD |
| • 6DM3A3500-FSD  | • 6DR3A400E-TSE  | •• 6RN2-2000-TSE | • 6DKNF93KE-TSE |
| • 6DM3A3500-FSU  | • 6DR3A400E-TSN  | •• 6RN2-2000-TSK | • 6DKNF93KE-TSK |
| • 6DM3A3500-TSE  | •• 6DS1A4000-FSD | •• 6RN2-3000-FSD | D 6DKXF93KE-TSE |
| • 6DM3A3500-TSN  | •• 6DS1A4000-FSU | •• 6RN2-3000-TSE | D 6DKXF93KE-TSK |
| • 6DM3A350E-FSD  | •• 6DS1A4000-TSE | •• 6RN2-3000-TSK | • 6DKNR23ME-TSK |
| • 6DM3A350E-FSU  | •• 6DS1A4000-TSN | •• 6RN5-3000-TSK | • 6DKNR35ME-FSD |
| • 6DM3A350E-TSE  | •• 6DS3A300E-TSE | •• 6RP2-2000-TSE | • 6DKNR35ME-TSE |
| • 6DM3A350E-TSN  | •• 6DS3A300E-TSK | •• 6RP2-2000-TSK | • 6DKNR35ME-TSK |
| •• 6DN3A3500-FSD | •• 6DS3A4000-FSD | •• 6RP2-3500-FSD | D 6DKXR35ME-TSE |
| •• 6DN3A3500-FSU | •• 6DS3A4000-FSU | •• 6RP2-3500-TSE | D 6DKXR35ME-TSK |
| •• 6DN3A3500-TSE | •• 6DS3A4000-TSE | •• 6RP2-3500-TSK | • 6DMNR37ME-FSD |
| •• 6DN3A3500-TSN | •• 6DS3A4000-TSN | •• 6RP5-3500-TSK | • 6DMNR37ME-FSU |
| •• 6DN3A350E-FSD | •• 6DS3A400E-FSD | • 6RR2-4000-FSD  | • 6DMNR37ME-TSE |
| •• 6DN3A350E-FSU | •• 6DS3A400E-FSU | • 6RR2-4000-FSU  | • 6DMNR37ME-TSN |
| •• 6DN3A350E-TSE | •• 6DS3A400E-TSE | • 6RR2-4000-TSE  | D 6DMXR37ME-TSE |
| •• 6DN3A350E-TSN | •• 6DS3A400E-TSN | • 6RR2-4000-TSN  | D 6DMXR37ME-TSN |
| •• 6DP1A2000-TSK | • 6DW3A3000-FSD  | •• 6RS2-4000-FSD | • 6DRNF11ME-FSD |
| •• 6DP1A3500-FSD | • 6DW3A3000-TSE  | •• 6RS2-4000-FSU | • 6DRNF11ME-TSE |
| •• 6DP1A3500-TSE | • 6DW3A3000-TSK  | •• 6RS2-4000-TSE | • 6DRNF11ME-TSK |
| •• 6DP1A3500-TSK | • 6DW3A300E-FSD  | •• 6RS2-4000-TSN | • 6DRNR28ME-TSK |
| •• 6DP1A350E-TSK | • 6DW3A300E-TSE  | D 6DBXR32ME-TSK  | • 6DRNR40ME-FSD |
| •• 6DP3A200E-FSM | • 6DW3A300E-TSK  | D 6DGXR37ME-TSE  | • 6DRNR40ME-FSU |
| •• 6DP3A200E-TSE | •• 6DY3A3000-FSD | D 6DGXR37ME-TSN  | • 6DRNR40ME-TSE |
| •• 6DP3A200E-TSK | •• 6DY3A3000-TSE | D 6DHXF93KE-TSE  | • 6DRNR40ME-TSN |
| •• 6DP3A3500-FSD | •• 6DY3A3000-TSK | D 6DHXF93KE-TSK  |                 |
| •• 6DP3A3500-TSE | •• 6DY3A300E-FSD | D 6DHXR35ME-TSE  |                 |
| •• 6DP3A3500-TSK | •• 6DY3A300E-TSE | D 6DHXR35ME-TSK  |                 |
| •• 6DP3A350E-FSD | •• 6DY3A300E-TSK | D 6DJXF11ME-TSE  |                 |
| •• 6DP3A350E-TSE | • 6RE2-2000-FSD  | D 6DJXF11ME-TSK  |                 |
| •• 6DP3A350E-TSK | • 6RE2-2000-TSE  | D 6DJXR40ME-TSE  |                 |
| • 6DR1A4000-FSD  | • 6RE2-2000-TSK  | D 6DJXR40ME-TSN  |                 |
| • 6DR1A4000-FSU  | • 6RE2-3000-FSD  | • 6DKNF93KE-FSD  |                 |
| • 6DR1A4000-TSE  | • 6RE2-3000-TSE  | • 6DKNF93KE-TSE  |                 |
| • 6DR1A4000-TSN  | • 6RE2-3000-TSK  | • 6DKNF93KE-TSK  |                 |
| • 6DR3A300E-TSE  | • 6RK2-2000-TSE  | D 6DKXF93KE-TSE  |                 |
| • 6DR3A300E-TSK  | • 6RK2-2000-TSK  | D 6DKXF93KE-TSK  |                 |
| • 6DR3A4000-FSD  | • 6RK2-3500-FSD  | D 6DHXR35ME-TSK  |                 |
| • 6DR3A4000-FSU  | • 6RK2-3500-TSE  | D 6DJXF11ME-TSE  |                 |
| • 6DR3A4000-TSE  | • 6RK2-3500-TSK  | D 6DJXF11ME-TSK  |                 |
| • 6DR3A4000-TSN  | • 6RK5-3500-FSD  | D 6DJXR40ME-TSE  |                 |
| • 6DR3A400E-FSD  | • 6RK5-3500-TSK  | D 6DJXR40ME-TSN  |                 |

D = Digital Model  
 • = 1 Bank Unloading  
 •• = 2 Banks Unloading



## Digital Models

### 3D

3DADF28KE-TFC  
 3DADF28KE-TFD  
 3DADF28KE-TFE  
 3DADR10ME-TFE  
 3DBDF33KE-TFC  
 3DBDF33KE-TFD  
 3DBDF33KE-TFE  
 3DBDR12ME-TFC  
 3DBDR12ME-TFD  
 3DBDR12ME-TFE  
 3DFDF40KE-TFC  
 3DFDF40KE-TFD  
 3DFDF40KE-TFE  
 3DFDR15ME-TFC  
 3DFDR15ME-TFD  
 3DSDF46KE-TFC  
 3DSDF46KE-TFD  
 3DSDF46KE-TFE  
 3SDSR17ME-TFC  
 3SDSR17ME-TFD  
 3SDSR17ME-TFE

### 4D

4DBXF54KE-TSE  
 4DBXF54KE-TSK  
 4DBXR20ME-FSD  
 4DBXR20ME-TSE  
 4DBXR20ME-TSK  
 4DHXF63KE-FSD  
 4DHXF63KE-TSE  
 4DHXF63KE-TSK  
 4DHXR22ME-FSD  
 4DHXR22ME-TSE  
 4DHXR22ME-TSK  
 4DJXF76ME-FSD  
 4DJXF76ME-TSE  
 4DJXF76ME-TSK  
 4DJXR28ME-FSD  
 4DJXR28ME-TSE  
 4DJXR28ME-TSK

### 6D

6DBXR32ME-TSK  
 6DGXR37ME-TSE  
 6DGXR37ME-TSN  
 6DHXF93KE-TSE  
 6DHXF93KE-TSK  
 6DHXR35ME-TSE  
 6DHXR35ME-TSK  
 6DJXF11ME-TSE  
 6DJXF11ME-TSK  
 6DJXR40ME-TSE  
 6DJXR40ME-TSN  
 6DKXF93KE-TSE  
 6DKXF93KE-TSK  
 6DHXR35ME-TSK  
 6DJXF11ME-TSE  
 6DJXF11ME-TSK  
 6DJXR40ME-TSE  
 6DJXR40ME-TSN  
 6DKXF93KE-TSE  
 6DKXF93KE-TSK  
 6DKXR35ME-TSE  
 6DKXR35ME-TSK  
 6DMXR37ME-TSE  
 6DMXR37ME-TSN

### ZBD

ZBD30KCE-TFD  
 ZBD30KCE-TFE  
 ZBD30KCE-TF5  
 ZBD38KCE-PFV  
 ZBD38KCE-TFD  
 ZBD38KCE-TFE  
 ZBD38KCE-TF5  
 ZBD38KCE-TF7  
 ZBD38KCP-TFD  
 ZBD38KCP-TF5  
 ZBD45KCE-TFD  
 ZBD45KCE-TFE  
 ZBD45KCE-TF5  
 ZBD45KCE-TF7  
 ZBD57KCE-TFD  
 ZBD57KCE-TFE  
 ZBD57KCE-TF5  
 ZBD57KCE-TF7  
 ZBD58KCE-TFD  
 ZBD58KCE-TF5  
 ZBD58KCE-TF7  
 ZBD69KCP-TFD  
 ZBD69KCP-TFE  
 ZBD76KCE-TFD  
 ZBD76KCE-TF5  
 ZBD76KCE-TF7  
 ZBD78KCP-TFD  
 ZBD78KCP-TFE

### ZFD

ZFD13KVE-TF5  
 ZFD13KVE-TF7  
 ZFD18KVE-TFD  
 ZFD18KVE-TFE  
 ZFD18KVE-TF5  
 ZFD18KVE-TF7  
 ZFD25KVE-TFD  
 ZFD25KVE-TFE  
 ZFD25KVE-TF5  
 ZFD25KVE-TF7

### ZPD

ZPD42K5E-TFD  
 ZPD42K5E-TFE  
 ZPD42K5E-TF5  
 ZPD42K5E-TF7  
 ZPD51K5E-PFZ  
 ZPD51K5E-PFV  
 ZPD51K5E-PFZ  
 ZPD51K5E-TFD  
 ZPD51K5E-TFE  
 ZPD51K5E-TF5  
 ZPD51K5E-TF7  
 ZPD54K5E-PFZ  
 ZPD54K5E-PFV  
 ZPD54K5E-PFZ  
 ZPD54K5E-TFD  
 ZPD54K5E-TFE  
 ZPD54K5E-TF5  
 ZPD54K5E-TF7  
 ZPD61KCE-TFE  
 ZPD61KCE-TF0  
 ZPD61KCE-TF5  
 ZPD67KCE-PFZ  
 ZPD72KCE-TF0  
 ZPD83KCE-TFD  
 ZPD83KCE-TFE  
 ZPD83KCE-TF0  
 ZPD83KCE-TF5  
 ZPD83KCE-TF7  
 ZPD91KCE-TFE  
 ZPD91KCE-TF5  
 ZPD91KCE-TF7

### ZRD

ZRDU13MC-TF7  
 ZRDU13MCE-TFD  
 ZRDU13MCE-TF5  
 ZRDU13MCE-TF7  
 ZRD125KCE-TFD  
 ZRD125KCE-TFE  
 ZRD125KCE-TF5  
 ZRD125KCE-TF7  
 ZRD36KC-TF5  
 ZRD36KCE-PFV  
 ZRD36KCE-TF7  
 ZRD42KCE-PFJ  
 ZRD42KCE-TFD  
 ZRD48KC-TFD  
 ZRD48KCE-PFV  
 ZRD48KCE-TF5  
 ZRD48KCE-TF7  
 ZRD49KCE-PFV  
 ZRD49KCE-TF5  
 ZRD49KCE-TF7  
 ZRD61KCE-PFV  
 ZRD61KCE-TFD  
 ZRD61KCE-TFE  
 ZRD61KCE-TF5  
 ZRD61KCE-TF7  
 ZRD72KCE-TF5  
 ZRD72KCE-TF7  
 ZRD94KCE-TFD  
 ZRD94KCE-TFE  
 ZRD94KCE-TF5  
 ZRD94KCE-TF7

### ZOD

ZOD104KCE-TFE  
 ZOD104KCE-TF5  
 ZOD104KCE-TF7  
 ZOD34K3E-TFD  
 ZOD34K3E-TFE  
 ZOD34K3E-TF5  
 ZOD34K3E-TF7

## Emerson Approved Contactors

| Emerson Part # | Description                        |
|----------------|------------------------------------|
| 912-1025-00    | 1 Pole, 25A Ind. 24v               |
| 912-1025-01    | 1 Pole, 25A Ind. 120v              |
| 912-1025-02    | 1 Pole, 25A Ind. 208/240v          |
| 912-1030-00    | 1 Pole, 30A Ind. 24v               |
| 912-1030-01    | 1 Pole, 30A Ind. 120v              |
| 912-1030-02    | 1 Pole, 30A Ind. 208/240v          |
| 912-1040-00    | 1 Pole, 40A Ind. 24v               |
| 912-1040-01    | 1 Pole, 40A Ind. 120v              |
| 912-1040-02    | 1 Pole, 40A Ind. 208/240v          |
| 912-1925-00    | 1 Pole, 25A Ind. 24v w/Shunt       |
| 912-1925-01    | 1 Pole, 25A Ind. 120v w/ Shunt     |
| 912-1925-02    | 1 Pole, 25A Ind. 208/240v w/ Shunt |
| 912-1930-00    | 1 Pole, 30A Ind. 24v w/ Shunt      |
| 912-1930-01    | 1 Pole, 30A Ind. 120v w/ Shunt     |
| 912-1930-02    | 1 Pole, 30A Ind. 208/240v w/ Shunt |
| 912-1940-00    | 1 Pole, 40A Ind. 24v w/ Shunt      |
| 912-1940-01    | 1 Pole, 40A Ind. 120v w/ Shunt     |
| 912-1940-02    | 1 Pole, 40A Ind. 208/240v w/ Shunt |
| 912-2020-00    | 2 Pole, 20A Ind. 24v               |
| 912-2020-01    | 2 Pole, 20A Ind. 120v              |
| 912-2020-02    | 2 Pole, 20A Ind. 208/240v          |
| 912-2025-00    | 2 Pole, 25A Ind. 24v               |
| 912-2025-01    | 2 Pole, 25A Ind. 120v              |
| 912-2025-02    | 2 Pole, 25A Ind. 208/240v          |
| 912-2030-00    | 2 Pole, 30A Ind. 24v               |
| 912-2030-01    | 2 Pole, 30A Ind. 120v              |
| 912-2030-02    | 2 Pole, 30A Ind. 208/240v          |
| 912-2040-00    | 2 Pole, 40A Ind. 24v               |
| 912-2040-01    | 2 Pole, 40A Ind. 120v              |
| 912-2040-02    | 2 Pole, 40A Ind. 208/240v          |
| 912-3015-00    | 3 Pole, 15A Ind. 24v               |
| 912-3015-01    | 3 Pole, 15A Ind. 120v              |
| 912-3015-02    | 3 Pole, 15A Ind. 208/240v          |
| 912-3015-03    | 3 Pole, 15A Ind. 440v              |
| 912-3025-00    | 3 Pole, 25A Ind. 24v               |
| 912-3025-01    | 3 Pole, 25A Ind. 120v              |
| 912-3025-02    | 3 Pole, 25A Ind. 208/240v          |
| 912-3025-03    | 3 Pole, 25A Ind. 440v              |
| 912-3030-00    | 3 Pole, 30A Ind. 24v               |
| 912-3030-01    | 3 Pole, 30A Ind. 120v              |
| 912-3030-02    | 3 Pole, 30A Ind. 208/240v          |
| 912-3030-03    | 3 Pole, 30A Ind. 440v              |
| 912-3040-00    | 3 Pole, 40A Ind. 24v               |
| 912-3040-01    | 3 Pole, 40A Ind. 120v              |
| 912-3040-02    | 3 Pole, 40A Ind. 208/240v          |
| 912-3040-03    | 3 Pole, 40A Ind. 440v              |
| 912-3050-00    | 3 Pole, 50A Ind. 24v               |
| 912-3050-01    | 3 Pole, 50A Ind. 120v              |

| Emerson Part # | Description                |
|----------------|----------------------------|
| 912-3050-02    | 3 Pole, 50A Ind. 208/240v  |
| 912-3050-03    | 3 Pole, 50A Ind. 440v      |
| 912-3060-00    | 3 Pole, 60A Ind. 24v       |
| 912-3060-01    | 3 Pole, 60A Ind. 120v      |
| 912-3060-02    | 3 Pole, 60A Ind. 208/240v  |
| 912-3060-03    | 3 Pole, 60A Ind. 440v      |
| 912-3075-00    | 3 Pole, 75A Ind. 24v       |
| 912-3075-01    | 3 Pole, 75A Ind. 120v      |
| 912-3075-02    | 3 Pole, 75A Ind. 208/240v  |
| 912-3075-03    | 3 Pole, 75A Ind. 440v      |
| 912-3090-04    | 3 Pole, 90A Ind. 24v       |
| 912-3090-05    | 3 Pole, 90A Ind. 120v      |
| 912-3090-06    | 3 Pole, 90A Ind. 208/240v  |
| 912-3090-07    | 3 Pole, 90A Ind. 440v      |
| 912-3120-00    | 3 Pole, 120A Ind. 24v      |
| 912-3120-01    | 3 Pole, 120A Ind. 120v     |
| 912-3120-02    | 3 Pole, 120A Ind. 208/240v |
| 912-3120-03    | 3 Pole, 120A Ind. 440v     |
| 912-3200-00    | 3 Pole, 200A Ind. 24v      |
| 912-3200-01    | 3 Pole, 200A Ind. 120v     |
| 912-3200-02    | 3 Pole, 200A Ind. 208/240v |
| 912-3200-03    | 3 Pole, 200A Ind. 440v     |
| 912-3300-00    | 3 Pole, 300A Ind. 24v      |
| 912-3300-01    | 3 Pole, 300A Ind. 120v     |
| 912-3300-02    | 3 Pole, 300A Ind. 208/240v |
| 912-3300-03    | 3 Pole, 300A Ind. 440v     |
| 912-3360-00    | 3 Pole, 360A Ind. 24v      |
| 912-3360-01    | 3 Pole, 360A Ind. 120v     |
| 912-3360-02    | 3 Pole, 360A Ind. 208/240v |
| 912-3360-03    | 3 Pole, 360A Ind. 440v     |

### Auxilliary Contact Kits (Side Mounted)

|             |                              |
|-------------|------------------------------|
| 912-0001-10 | 1 NO - For 15-75A            |
| 912-0001-11 | 1 NC - For 15-75A            |
| 912-0001-12 | 1 NO/1 NC - For 15-75A       |
| 912-0001-13 | 2 NO - For 15-75A            |
| 912-0001-14 | 2 NC - For 15-75A            |
| 912-0001-39 | 1 NO - For 90A               |
| 912-0001-40 | 1 NC - For 90A               |
| 912-0001-41 | 1 NO/1 NC - For 90A          |
| 912-0001-42 | 2 NO - For 90A               |
| 912-0001-19 | 1 NO - For 120-360A          |
| 912-0001-20 | 1 NC - For 120-360A          |
| 912-0001-21 | 1 NO/1 NC - For 120-360A     |
| 912-0001-22 | Mech. Interlock - For 15-75A |

For more information see Application Engineering bulletin AE10-1244.



## Parts Warranty Information

When parts are being returned (or parts of a compressor or condensing unit that are being returned separately), they have a 12/20 warranty (12 months of service and received at Emerson Climate Technologies, Inc. within 20 months from date of manufacture). When parts were sold as service replacement, then the warranty is 12 months or less in-service. The wholesaler must provide their sales invoice number and date of sale for the part.

To obtain warranty credit on a Copeland brand part, simply send in a completed warranty claim tag which contains the required information to verify warranty credit is due. The warranty claim tag should be marked “Field Scrap” and attached to any returned goods paperwork a wholesaler may also use.

The tag and paperwork should be sent to:

Emerson Climate Technologies, Inc.  
Distribution Services  
6579 West 350N, Suite A  
Greenfield, IN 46140

Such failed parts need to be retained by the wholesaler for 30 days, but can be scrapped after that time, unless otherwise directed by Emerson Climate Technologies, Inc. If we choose to audit a particular claim, we shall provide prior notice within such 30-day time period.

There are a select group of electronics and diagnostics parts that must be returned to receive warranty credit. Be sure to confirm with customer service that the electronics part is not required to be returned before submitting a field scrap warranty request.

## Notes

---

---

---

---

---

---

---

---

---

---

---

---

---

---

---

---

---

---

---

---

---

---

---

---

## EmersonClimate.com

The contents of this publication are presented for informational purposes only and are not to be construed as warranties or guarantees, express or implied, regarding the products or services described herein or their use or applicability. Emerson Climate Technologies, Inc. and/or its affiliates (collectively "Emerson"), as applicable, reserve the right to modify the design or specifications of such products at any time without notice. Emerson does not assume responsibility for the selection, use or maintenance of any product. Responsibility for proper selection, use and maintenance of any Emerson product remains solely with the purchaser or end user.

2014DS-78 R2 (2/16)

Emerson, Copeland Discus, Copeland Scroll and CoreSense are trademarks of Emerson Electric Co. or one of its affiliated companies. ©2016 Emerson Climate Technologies, Inc. All rights reserved.