



Fall 2017

# Product Catalog and Dimensional Data

# InnoFlue®

## Polypropylene Vent Systems

**InnoFlue® Single Wall, Flex and Concentric**  
 Single Wall Rigid, Flexible and Concentric Polypropylene  
 Category II & IV Special Gas Vent • Gas Vent BH, Class IIC

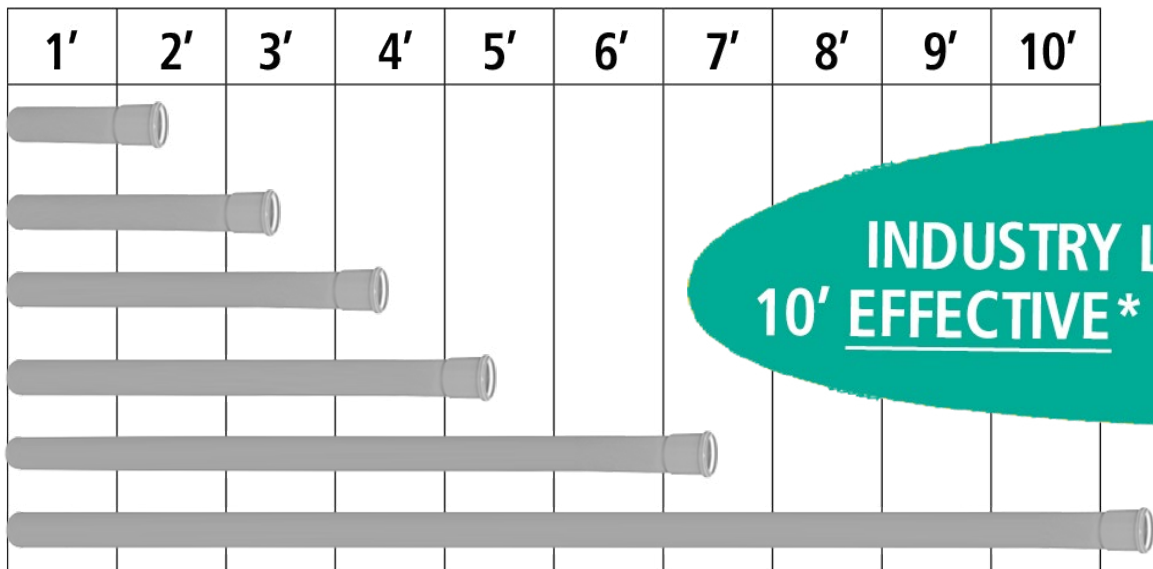

**NOW in  
 INDUSTRY LEADING  
 10' EFFECTIVE\* lengths!**

\*Enjoy 3% of each vent length FREE! InnoFlue® sockets extend past the effective length.

**UL-1738**



**ULC-S636**

# InnoFlue®

## The Intelligent Alternative to PVC & CPVC

Across North America, home owners, maintenance professionals, contractors, distributors, engineers and heating equipment manufacturers are recognizing the unmatched value InnoFlue® delivers to the HVAC industry.

Manufactured from environmentally friendly polypropylene, InnoFlue® has been tested and is listed to all relevant American, Canadian and European Safety Standards. It is listed and warranted for sustained flue gas temperatures up to 230°F (110°C), thus providing enhanced performance properties and significant safety margins. Centrotherm offers a comprehensive product line including test/inspection ports, condensate drains, siphons, flue collar adaptors, as well as excellent technical, sales and marketing support.

InnoFlue® Vent Systems are professional, reliable, environmentally sustainable and offer substantial labor savings due to reduced installation times.



**Proudly made  
in the U.S.A.**

**Safety  
Speed  
Innovation**



	InnoFlue®	PVC	CPVC
<b>Chemical Resistance</b>			
<i>Aromatic Hydrocarbons</i>	✓	X	X
<i>Sulfuric Acid</i>	✓	X	X
<i>Hydrochloric Acid</i>	✓	X	X
<b>Working Temperature</b>	0° C (32°F) - 110° C (230°F)	15° C (50°F) - 65° C (149°F)	15° C (50°F) - 90° C (194° F)
<b>Softening Temperature</b>	150° C (302°F)	80° C (176°F)	110° C (230°F)
<b>Environmentally Friendly Production</b>	✓	X	X
<b>No Chloride Leaching</b>	✓	X	X
<b>Fully Recyclable</b>	✓	X	X

# Why InnoFlue®?

## Ease of Installation

- Integrated gasket system allows for:
  - Faster, cleaner, V.O.C.-free installation
  - Immediate use of appliances upon installation
  - Post-installation adjustments
- No fit up, couplers, primers or adhesives needed
- Light weight makes for easy handling and rapid installation
- **New 1/4" pitch for 2", 3" and 4" Single Wall vent systems**

## Health and Safety

ETL Listed: UL 1738, ULC-S636

Listed: CE EN 14471

- Performs at sustained flue temperatures up to 230°F (110°C)
- Listed at zero clearance to combustibles for all systems configurations
- Environmentally-friendly polypropylene is **100% recyclable**
- Industry leading wall thickness enhances structural durability
- Chloride free

## Warranty & Reliability

- Manufacturer-supported and guaranteed with an unprecedented 10-year limited warranty
- Enhanced corrosion resistance allows for use with oil, propane, and gas fired appliances
- Over 20 years of field service history



## Product Approvals

Since 2010, Centrotherm's InnoFlue® has been accepted and approved by over 50 North American manufacturers of boilers, water heaters and furnaces. For a complete listing of the approvals, visit [www.centrotherm.us.com/literature/o-e-m-approvals](http://www.centrotherm.us.com/literature/o-e-m-approvals) For appliances that require specific appliance adaptors, contact your manufacturer's representative or Centrotherm Eco Systems.

## Listings

Centrotherm made the commitment and investment to have its Single Wall, Flexible and Concentric Vent Systems tested to the industry relevant



UL-1738, ULC-S636 and CE EN 14471 safety standards. Thus InnoFlue® is approved for use in the United States, Canada and most European Countries.

As of this printing, InnoFlue® is the only polypropylene vent system to be listed by an accredited third party to the rigorous U.S. safety standard, UL 1738.

For detailed information about Centrotherm's product testing and listing, feel free to visit [www.intertek.com](http://www.intertek.com)

**UL 1738**  
**ULC-S636**  
**CE EN 14471**



# TABLE OF CONTENTS

## InnoFlue® SW Residential

Applications and Limitations.....	7
Typical Configurations.....	8

### COMPONENTS

#### Appliance Adaptors

Appliance Adaptor for Coupler Style Flue Collars.....	9
Appliance Adaptor for Flue Collars with Hose Clamp.....	9
Appliance Adaptor SS to InnoFlue®.....	9
Appliance Adaptor 101 mm to InnoFlue®.....	10

#### Increasesers & Reducers

Eccentric Increaser.....	10
Centric Increaser.....	10
3"/2" Reducer.....	11
Reducers.....	11

#### Test Ports

Test Port.....	11
----------------	----

#### Vent Lenth

Rigid Vent Length.....	12
------------------------	----

#### Base Supports

Base Support.....	12
Base Support Bracket.....	12

#### Elbows

15° Elbow.....	13
30° Elbow.....	13
45° Elbow.....	13
45° Elbow Long.....	13
87° Elbow.....	14
Tee.....	14
Tee Cap.....	14

#### Condensate Management

Horizontal Drain Tee.....	15
Tee Cap with Drain.....	15
Universal Ball Valve Siphon.....	15

#### Horizontal Vent Kits

Horizontal Vent Kits.....	16
---------------------------	----

#### Terminations

Chimney Cover PPs-UV.....	17
Chimney Cover SS with PPs-UV End Pipe.....	17
Low Profile Wall Termination.....	17
Universal B-Vent Cap.....	18
Termination Tee.....	18
End Pipe PPs-UV.....	19
Vent Lengths PPs-UV.....	19
45° Elbow Long PPs-UV.....	19
45° Elbow PPs-UV.....	19
87° Elbow Long PPs-UV.....	20
87° Elbow PPs-UV.....	20
PPs to PVC Termination Kit.....	20
Bird Screen PPs-UV.....	20
Bird Screen SS.....	20

#### Spacers

2", 3", 4", and 5" Spacer.....	21
--------------------------------	----

#### Accessories

Flue Clamp.....	21
Support Clamp.....	21
Wall Plate.....	22
Connector Ring.....	22
EPDM Gaskets.....	22
B-Vent Gasket.....	23
Centrocerin.....	23

## InnoFlue® Flex

Typical Configurations.....	24
-----------------------------	----

### COMPONENTS

#### Flex Vent Lengths

2" Flex.....	25
3" and 4" Flex.....	25

#### Couplers

SW to Flex Coupler.....	26
Flex to SW Couplers.....	26
Flex to Flex Couplers.....	26

#### B-Vent Kits

2" B-Vent Kit.....	27
3" and 4" B-Vent Kit.....	27

#### Flex Component B-Vent Kits

2" Flex Component B-Vent Kit.....	28
3" and 4" Flex Component B-Vent Kit.....	28

#### Chimney Kits

2" Chimney Kit.....	29
3" and 4" Chimney Kit.....	29
2" Flex Component Chimney Kit.....	30
3" and 4" Flex Component Chimney Kit.....	30

#### Terminations

Chimney Covers PPs-UV.....	30
Custom Chimney Cover PPs-UV.....	30
2" Flex End Pipe.....	31
3" and 4" Flex End Pipe.....	31
Universal B-Vent Cap.....	31



## InnoFlue® Concentric

Applications and Limitations.....	32
Typical Configurations.....	33

### COMPONENTS

#### Concentric Adaptors

Concentric Centric Increaser.....	33
Concentric Test Port.....	33
Concentric to Twin Pipe Adaptors.....	34
Twin Pipe to Concentric Adaptors.....	34
Concentric Horizontal Drain Tee.....	34

#### Concentric Vent Lengths

Concentric Vent Length.....	35
-----------------------------	----

#### Elbows

Concentric 45° Elbow.....	35
Concentric 87° Elbow.....	35

#### Wall Plates

Wall Plates.....	35
------------------	----

#### Terminations

Concentric Roof Terminations.....	36
Concentric Wall Terminations.....	36

#### Accessories

Support Clamp.....	36
--------------------	----

#### Concentric Kits

Concentric Kit Horizontal.....	37
Concentric Kit Vertical.....	37

## InnoFlue® SW Commercial

Applications and Limitations.....	38
Typical Configurations.....	39

### COMPONENTS

#### Appliance Adaptors

Commercial Appliance Adaptor for Coupler Style Flue Collars.....	40
Commercial Appliance Adaptor for Flue Collars with Hose Clamp....	40
Commercial Appliance Adaptor with Condensation Drain & Vibration Isolation Boot OEM to InnoFlue®....	40
Commercial Appliance Adaptors OEM to InnoFlue®.....	41
Commercial Appliance Adaptors SS to PPs.....	41
Vibration Isolation Boot w/ Clamps.....	42

#### Increases and Reducers

Centric Increaser.....	42
Eccentric Increaser.....	42
Reducer.....	43
Tapered Reducer.....	43

#### Test Ports

Test Port.....	43
----------------	----

#### Vent Lengths

Rigid Vent Lengths.....	44
-------------------------	----

#### Elbows

15° Elbow.....	44
30° Elbow.....	45
45° Elbow.....	45
87° Elbow.....	45
Base Support.....	45

#### Cascade Components

Branch Tees.....	46
------------------	----

#### Cascade Component Kits

Cascade Component Kits.....	47
-----------------------------	----

#### Condensate Management

Horizontal Drain Tee.....	48
Horizontal Drain Fitting.....	48
Tee.....	48
Tee Cap.....	49
Tee Cap with Drain.....	49
Universal Ball Valve Siphon.....	49

#### Terminations

Roof Flashings.....	50
Chimney Cover SS w/ PPs-UV End Pipe.....	50
End Pipe PPs-Gray.....	51
Termination Tees.....	51
Velocity Cone.....	52
PPs to PVC Termination Kit.....	52
Bird Screen PPs-UV.....	52
Bird Screen SS.....	52

#### Spacers

Spacers.....	53
--------------	----

#### Accessories

Flue Clamp.....	53
Connector Ring.....	53
Connector Double Hose Clamp.....	54
Support Clamp.....	54
EPDM Gaskets.....	54
Wall Plates.....	54
Centrocerin.....	54

Leaders Sustainability Dynamic Efficient  
Experience Safety Creative Energy Health  
Innovative Solutions Unprecedented Diverse

# WORLDWIDE

Established in 2009 for the purpose of introducing Polypropylene Vent Systems to the North American market, **Centrotherm Eco Systems** is the most recent addition to the Ubbink Centrotherm Group.

Ubbink was founded in the Netherlands in 1896. In 1976, Centrotherm Systemtechnik was established in Brilon, Germany, and in 1998, CENTROTEC Sustainable AG was formed as its parent holding company. Subsequently, Ubbink was acquired by Centrotec Sustainable AG in 2000. Today, CENTROTEC is one of Europe's leading manufacturers of a variety of sustainable building solutions, as you will find by visiting: <http://centrotec.de>.

Now, **Centrotherm Eco Systems** produces its InnoFlue® Vent Systems based on a wealth of technical know-how and experience accumulated over time. Field proven for 20 years, it has been installed and is performing successfully in millions of homes in the North American and European markets today.

**Centrotherm Eco Systems** supplies its standard **InnoFlue®** vent products to heating professionals through heating and plumbing wholesalers, as well as commercial spec. representatives.

**Centrotherm Eco Systems** also designs, produces, and delivers internal equipment components to many OEMs of high efficiency boilers, tankless water heaters and furnaces.

The following catalog pages describe our standard products available today.

We are looking forward to your feedback and input to help keep our products on the cutting edge of technology, simplicity, and ease of installation.



# INNOFLUE® Polypropylene Vent Systems

## Applications and Limitations

- In order to maintain relevant listings and Centrotherm's warranty, **InnoFlue®** vent systems may not be combined with any polymeric or stainless steel vent components that are not part of Centrotherm's published offerings.
- **InnoFlue®** SW and **InnoFlue®** Flex must be installed following Centrotherm's published installation instructions.
- **InnoFlue®** SW and **InnoFlue®** Flex are ETL listed to UL and ULC standards for use with natural gas or propane fired, Cat. II or Cat. IV appliances (US) or BH Gas Class II A, B and C gas or propane fired appliances (Canada).
- **InnoFlue®** SW and **InnoFlue®** Flex can also be used for oil fired, condensing appliances with a maximum flue gas temperature that does not exceed 230°F (110°C).
- **InnoFlue®** SW and **InnoFlue®** Flex are ETL listed to UL 1738 and ULC-S636 at zero clearance to combustibles.
- **InnoFlue®** SW may be installed inside a masonry or sheet rocked chase, through an existing structurally intact metal flue, between floor joists, directly through a wall or if properly supported, can even be left exposed along the interior of a structure.
- **InnoFlue®** Flex is available in 2", 3" and 4" diameters and offers all necessary components for combining it with **InnoFlue®** SW and InnoFlue Concentric to meet specific job requirements.

- **InnoFlue®** Flex may be used in offsets or bends not to exceed 45 degrees from vertical.
- **InnoFlue®** Flex must be installed inside a masonry chimney or sheet rocked chase, or through an existing, structurally intact metal flue.
- Single or multiple **InnoFlue®** Flex may be installed into an existing masonry chimney or structurally intact metal flue or chase.
- Do not install where ambient air temperature can exceed 300°F.

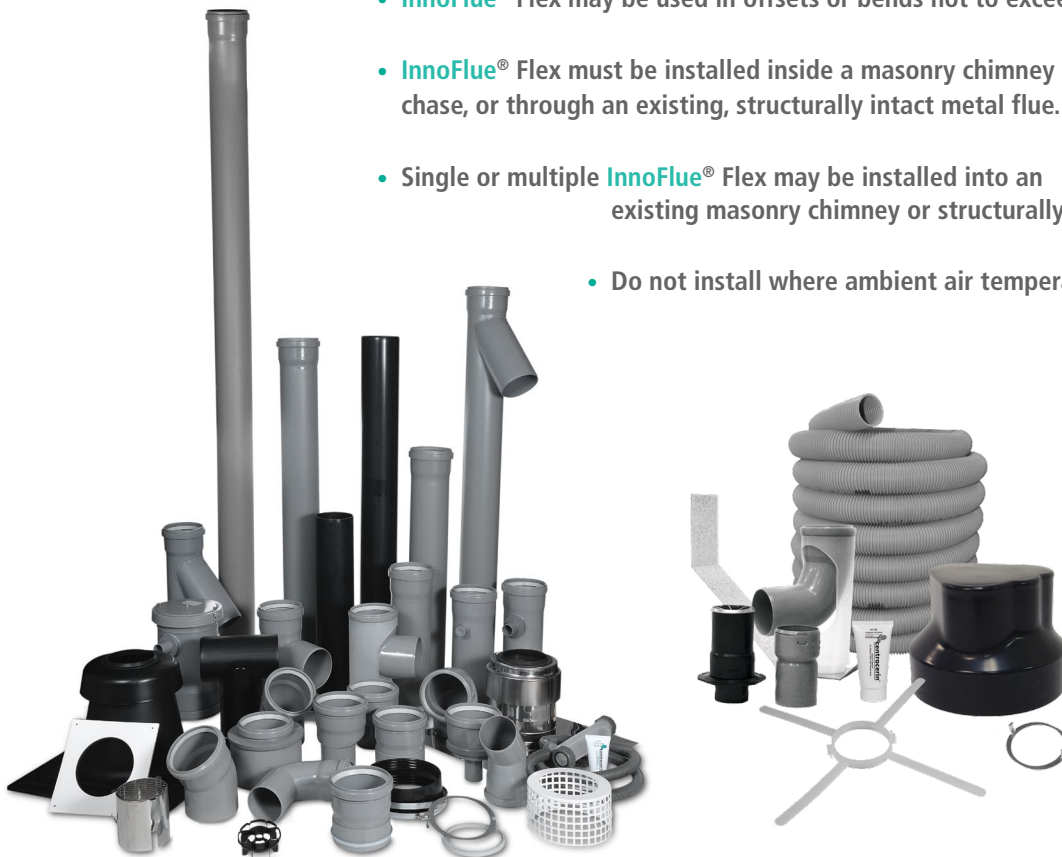

# INNOFLUE® SINGLE WALL TYPICAL CONFIGURATIONS

- 2 ISEL87: 87° Elbow
- 3 ISVL: Vent Length
- 4 IASCM: Support Clamp
- 5 IANS: Connector Ring
- 6 IAWP: Wall Plate
- 7 ISEP: End Pipe PPs-UV
- 8 ISTT: Termination Tee PPs-UV
- 9 IASPP: Bird Screen PPs-UV
- 11 ISELLUV: 87° Elbow Long PPs-UV
- 12 ISAGL or ISAAL: Appliance Adaptor
- 13 ISLPT: Low Profile Wall Termination
- 14 ICTC: Twin Pipe to Concentric Adaptor
- 15 ICRT: Concentric Roof Termination
- 16 ISVLUV: Vent Length PPs-UV Black
- 24 ISBS: Base Support
- 25 IASP: Spacer
- 27 IFVL: Flexible Vent Length
- 28 ISCP: Chimney Cover PPs-UV
- 29 IFEP: Flex End Pipe
- 30 IFFSC: Flex to SW Coupler
- 36 IAUBV: Universal B-Vent Cap
- 37 IFPT: Custom Chimney Cover  
Refer to pg. 24

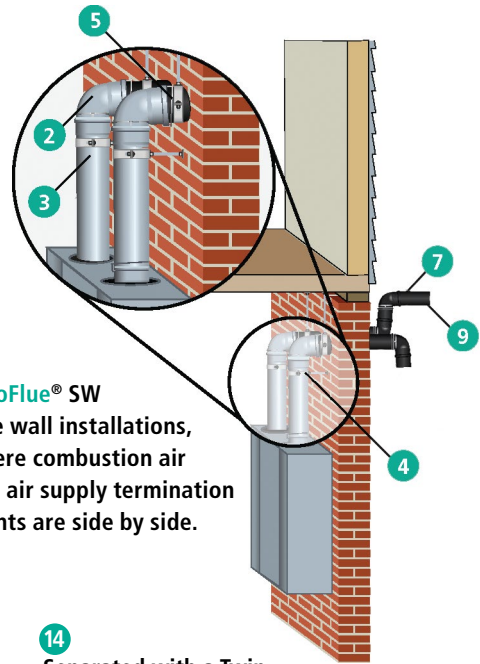

InnoFlue® SW side wall installations, where combustion air and air supply termination points are side by side.

InnoFlue® SW side wall installations where combustion air and supply termination points can be significantly separated.

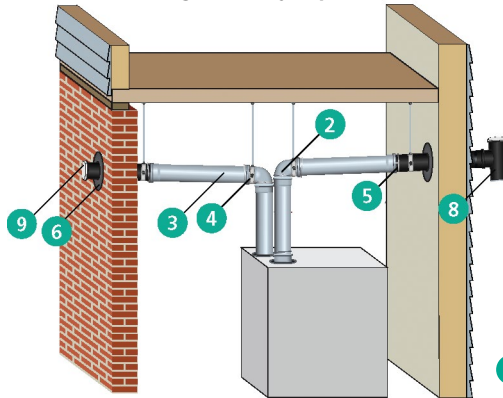

Separated with a Twin Pipe to Concentric Adaptor below the roof for the final concentric vent run and Concentric Roof Termination.

InnoFlue® SW side wall installations, where exhaust and air supply remain separated through the Low Profile Wall Termination.

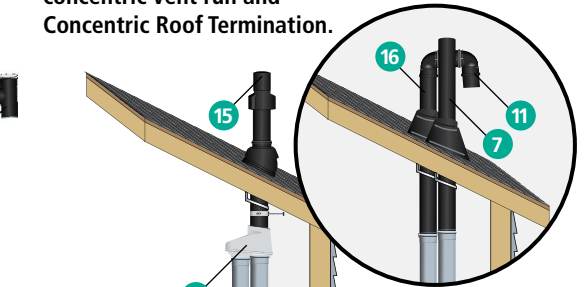
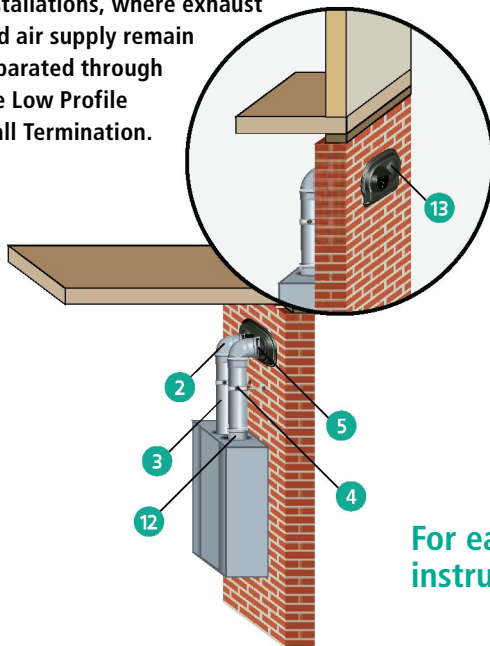

Exhaust and air supply remain separated with a dual exhaust termination.

InnoFlue® SW installations, where exhaust and air supply are installed parallel and vertical.

For each configuration, see installation instructions and specific code requirements.

## Appliance Adaptors

Check adaptor matrix at [www.centrotherm.us.com/literature/o-e-m-approvals](http://www.centrotherm.us.com/literature/o-e-m-approvals)



### Appliance Adaptor for Coupler Style Flue Collars

Adapts a female PVC / CPVC coupler or appliance flue exhaust to InnoFlue® SW diameters.

Nominal Diameter PVC to PP	Part #	Overall Length "A"	Effective Length "B"	Max O.D. "C"
2" / 2" (60/60)	ISAGL0202	3.3 (83)	1.0 (26)	3.0 (76)
3" / 3" (89/80)	ISAGL0303	3.0 (75)	0.8 (21)	3.8 (97)
4" / 4" (114/110)	ISAGL0404	3.4 (87)	0.8 (21)	5.1 (129)
5" / 5" (140/125)	ISAGL0505	5.7 (144)	0.8 (21)	5.8 (146)

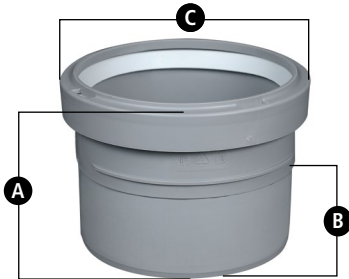

### Appliance Adaptor for Flue Collar with Hose Clamp

Adapts a female PVC / CPVC sized appliance collar (with integrated gasket) to InnoFlue® SW diameters.

Nominal Diameter PVC to PP	Part #	Overall Length "A"	Effective Length "B"	Max O.D. "C"
2" / 2" (60/60)	ISAAL0202	3.3 (83)	1.0 (26)	3.0 (76)
3" / 3" (89/80)	ISAAL0303	3.0 (75)	0.8 (21)	3.8 (97)
4" / 4" (114/110)	ISAAL0404	3.4 (87)	0.8 (21)	5.1 (129)
5" / 5" (140/125)	ISAAL0505	5.7 (144)	0.8 (21)	5.8 (146)

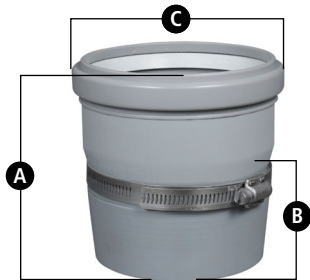

### Appliance Adaptor SS to InnoFlue®

Adapts a tapered female stainless steel appliance flue exhaust with tabs to InnoFlue®.

Nominal Diameter	Part #	Overall Length "A"	Effective Length "B"	Max O.D. "C"
3" (80)	ISAAS0303	4.5 (115)	0.8 (21)	3.8 (97)
4" (110)	ISAAS0404	4.8 (122)	0.8 (21)	5.1 (129)

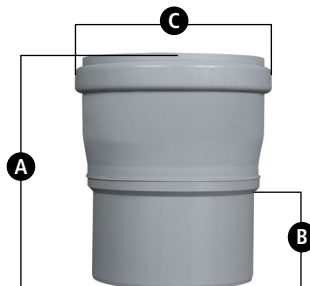

### Appliance Adaptor SS to InnoFlue®

Adapts a stainless steel appliance flue exhaust with gasket and clamp to InnoFlue®.

Nominal Diameter	Part #	Overall Length "A"	Effective Length "B"	Max O.D. "C"
3" / 3" (76/80)	ISSA0303	6.0 (153)	3.1 (78)	3.8 (97)
4" / 4" (102/110)	ISSA0404	6.0 (153)	3.6 (91)	5.1 (129)
5" / 5" (127/125)	ISSA0505	6.5 (166)	3.9 (99)	5.8 (146)



# INNOFLUE® SW RESIDENTIAL

Residential SW



## Appliance Adaptors 101mm to PPs

Adapts 101mm diameter flue exhaust to InnoFlue.® Adaptors include replacement o-ring for flue collar.

Nominal Diameter PVC to PP	Part #	Overall Length "A"	Effective Length "B"	Max O.D. "C"
4" (100/101)/3" (80)	ISA010103	6.5 ( 165 )	3.3 (84)	3.8 (97)
4" (100/101)/4" (110)	ISA010104	6.4 (163)	4.0 (102)	5.1 (129)

## Custom Appliance Adaptors Available

Available to fit most residential and commercial heating appliances. Call for pricing.

## Increasesers & Reducers

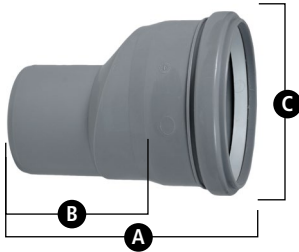

### Eccentric Increaser

Transitions vent system to a larger diameter. Install in horizontal or vertical orientation. Other size combinations available upon request.

Nominal Diameter	Part #	Overall Length "A"	Effective Length "B"	Max O.D. "C"
2"/3" (60/80)	ISEI0203	5.3 (135)	3.1 (79)	3.8 (97)
3"/4" (80/110)	ISEI0304	6.1 (156)	3.6 (91)	5.1 (129)
4"/5" (110/125)	ISEI0405	6.7 (170)	4.2 (106)	5.8 (146)



### Centric Increaser

Transitions vent system to a larger diameter. Install in vertical orientation only. Additional configurations available upon request.

Nominal Diameter	Part #	Overall Length "A"	Effective Length "B"	Max O.D. "C"
2"/3" (60/80)	ISIA0203	5.9 (150)	3.5 (89)	3.8 (97)
3"/4" (80/110)	ISIA0304	5.7 (145)	3.2 (81)	5.1 (129)
4"/4" (100/110)	ISIA10004	6.4 (163)	4.2 (105)	5.1 (129)
4"/5" (110/125)	ISIA0405	6.8 (173)	4.3 (110)	5.8 (146)

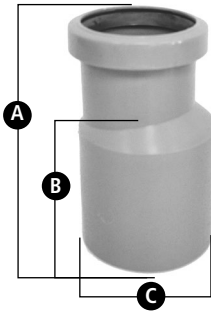

### 3 1/2" Reducer

Transitions vent system to a smaller diameter.

Nominal Diameter	Part #	Overall Length "A"	Effective Length "B"	Max O.D. "C"
3 1/2" (80/60)	ISRD0302	60 (153)	3.5 (89)	3.2 (80)

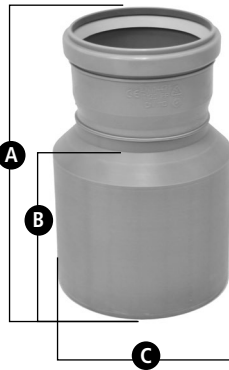

### Reducers

Transitions vent system to a smaller diameter.

Nominal Diameter	Part #	Overall Length "A"	Effective Length "B"	Max O.D. "C"
4 1/3" (110/80)	ISRD0403	6.0 (153)	3.5 (89)	4.3 (110)
5 1/4" (125/110)	ISRD0504	6.5 (166)	4.0 (102)	4.9 (125)
6 1/4" (160/110)	ISRD0604	6.5 (166)	4.0 (102)	6.3 (160)
6 1/5" (160/125)	ISRD0605	6.5 (166)	4.0 (102)	6.3 (160)
5 1/5" (130/125)	ISRD13005	5.0 (127)	4.7 (120)	5.1 (130)
6 1/4" (150/110)	ISRD15004	8.8 (223)	6.5 (165)	5.9 (150)
6 1/5" (150/125)	ISRD15005	9.1 (230)	6.7 (170)	5.9 (150)

### Test Ports

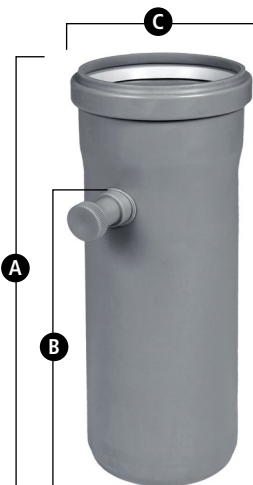

### Test Port

Installed immediately above the appliance, the test port allows plumbing and heating professionals to sample flue gases and ensure the appliance is operating at optimum efficiency.

Nominal Diameter	Part #	Overall Length "A"	Effective Length "B"	Max O.D. "C"
2" (60)	ISTP02	7.0 (170)	4.3 (110)	3.0 (76)
3" (80)	ISTP03	7.0 (170)	4.5 (115)	3.8 (97)
4" (110)	ISTP04	12.4 (314)	9.8 (250)	5.1 (129)
5" (125)	ISTP05	12.6 (320)	9.8 (250)	5.8 (146)

## Vent Lengths

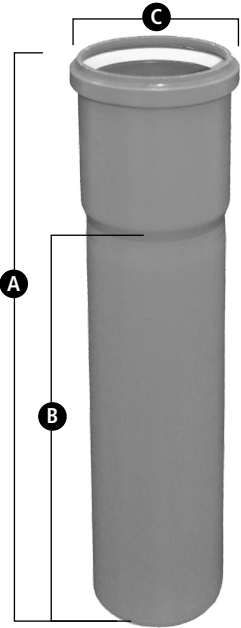

### Rigid Vent Length

Rigid polypropylene vent lengths with dedicated male and female ends. Female ends contain internal gasket and male ends can be field cut and chamfered to desired length.

Nominal Diameter	Part #	Overall Length "A"	Effective Length "B"	Max O.D. "C"
2" (60)	ISVL021	16.4 (411)	12 (305)	3.0 (76)
2" (60)	ISVL022	28.4 (716)	24 (610)	3.0 (76)
2" (60)	ISVL023	40.4 (1021)	36 (914)	3.0 (76)
2" (60)	ISVL026	76.4 (1935)	72 (1829)	3.0 (76)
2" (60)	ISVL0210	124.2 (3155)	120 (3048)	3.0 (76)
3" (80)	ISVL031	16.4 (411)	12 (305)	3.8 (97)
3" (80)	ISVL032	28.4 (716)	24 (610)	3.8 (97)
3" (80)	ISVL033	40.2 (1021)	36 (914)	3.8 (97)
3" (80)	ISVL036	76.4 (1935)	72 (1829)	3.8 (97)
3" (80)	ISVL0310	124.2 (3155)	120 (3048)	3.8 (97)
4" (110)	ISVL041	16.0 (406)	12 (305)	5.1 (129)
4" (110)	ISVL042	28.0 (711)	24 (610)	5.1 (129)
4" (110)	ISVL043	40.2 (1016)	36 (914)	5.1 (129)
4" (110)	ISVL046	76.2 (1930)	72 (1829)	5.1 (129)
4" (110)	ISVL0410	124.2 (3155)	120 (3048)	5.1 (129)
5" (125)	ISVL051	15.9 (404)	12 (305)	5.8 (146)
5" (125)	ISVL052	27.9 (709)	24 (610)	5.8 (146)
5" (125)	ISVL053	39.9 (1013)	36 (914)	5.8 (146)
5" (125)	ISVL056	75.9 (1928)	72 (1829)	5.8 (146)

**Now in 10 foot effective lengths!**

## Base Supports

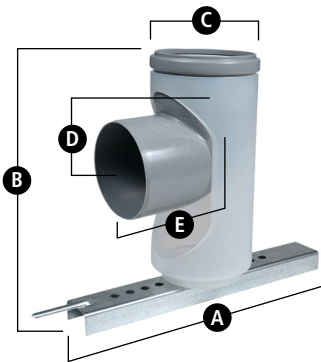

### Base Support

Supports vertical sections of rigid (up to 164') and flexible (up to 98' with Flex end pipe) vent lengths installed in chimneys and chases.

Nominal Diameter	Part #	Base Length "A"	Height "B"	Max O.D. "C"	Effective "D"	Effective "E"
2" (60)	ISBS0287	15.8 (400)	9.4 (238)	3.0 (76)	2.7 (69)	4.6 (118)
3" (80)	ISBS0387	15.8 (400)	10.6 (269)	3.8 (97)	3.4 (86)	4.9 (125)
4" (110)	ISBS0487	15.8 (400)	11.5 (291)	5.1 (129)	2.6 (65)	4.5 (115)
5" (125)	ISBS0587	15.8 (400)	13.4 (341)	5.8 (146)	2.9 (74)	5.4 (136)

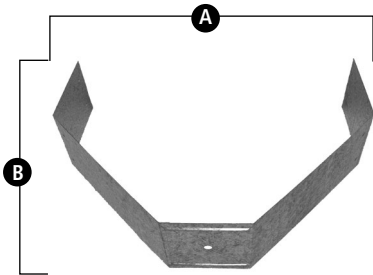

### Base Support Bracket

B-Vent Support Bracket (IABVSB) replaces metal channel on base support to support vertical sections of rigid and flexible vent lengths installed inside a B-Vent. Fastens to floor joists.

Part #	Width "A"	Height "B"
IABVSB	17.5 (446)	11.8 (298)

Elbows

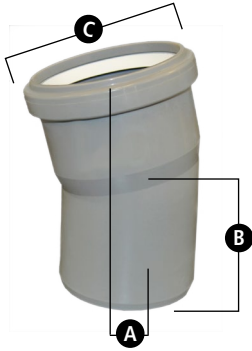

15° Elbow

For offsets or changes in the direction of the vent system.

Nominal Diameter	Part #	Centerline Offset "A"	Effective Length "B"	Max O.D. "C"
2" (60)	ISEL0215	0.7 (18)	3.3 (84)	3.0 (76)
3" (80)	ISEL0315	0.7 (18)	3.1 (79)	3.8 (97)
4" (110)	ISEL0415	0.8 (20)	3.6 (91)	5.1 (129)
5" (125)	ISEL0515	0.9 (23)	4.6 (117)	5.8 (146)

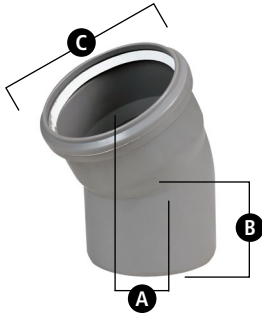

30° Elbow

For offsets or changes in the direction of the vent system.

Nominal Diameter	Part #	Centerline Offset "A"	Effective Length "B"	Max O.D. "C"
2" (60)	ISEL0230	1.5 (38)	3.6 (91)	3.0 (76)
3" (80)	ISEL0330	1.4 (36)	3.4 (86)	3.8 (97)
4" (110)	ISEL0430	1.7 (43)	4.1 (104)	5.1 (129)
5" (125)	ISEL0530	1.8 (46)	5.1 (130)	5.8 (146)

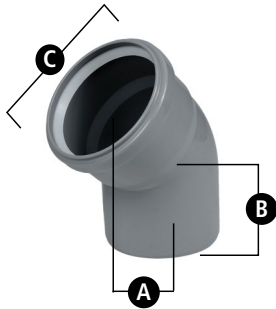

45° Elbow

For offsets or changes in the direction of the vent system.

Nominal Diameter	Part #	Centerline Offset "A"	Effective Length "B"	Max O.D. "C"
3" (80)	ISEL0345	2.2 (56)	3.6 (92)	3.8 (97)
4" (110)	ISEL0445	2.2 (63)	4.1 (105)	5.1 (129)
5" (125)	ISEL0545	2.7 (68)	4.8 (122)	5.8 (146)

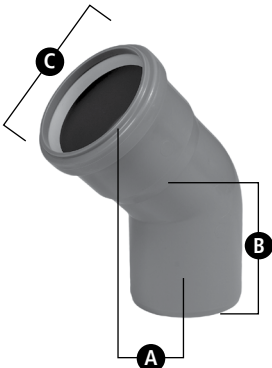

45° Elbow Long

Longer 45° Elbow allows for greater offsets or changes in the direction of the vent system.

Nominal Diameter	Part #	Centerline Offset "A"	Effective Length "B"	Max O.D. "C"
2" (60)	ISELL0245	2.2 (56)	3.8 (96)	3.0 (76)

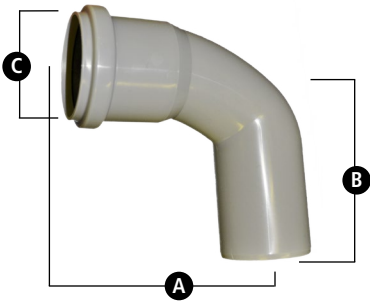

### 87° Elbow

For offsets or changes in the direction of the vent system.

Nominal Diameter	Part #	Centerline Offset "A"	Effective Length "B"	Max O.D. "C"
2" (60)	ISELL0287	2.5 (63)	4.8 (121)	3.0 (76)

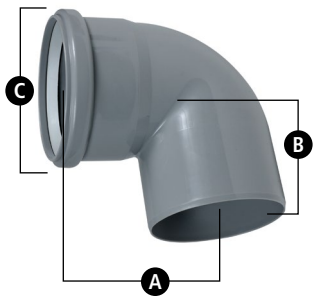

### 87° Elbow

For offsets or changes in the direction of the vent system.

Nominal Diameter	Part #	Centerline Offset "A"	Effective Length "B"	Max O.D. "C"
3" (80)	ISEL0387	5.3 (133)	5.0 (127)	3.7 (97)
4" (110)	ISEL0487	2.4 (60)	4.6 (118)	5.1 (129)
5" (125)	ISEL0587	2.7 (68)	5.5 (139)	5.8 (146)

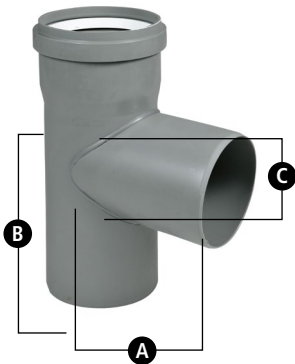

### Tee

Use to change the direction of the vent system, combine multiple appliances, and capture condensates at base of long vertical runs.

Nominal Diameter	Part #	Effective Length "A"	Effective Length "B"	Effective Length "C"
2" (60)	IST02	6.3 (160)	8.7 (221)	2.6 (66)
3" (80)	IST03	6.3 (160)	8.7 (221)	2.7 (69)
4" (110)	IST04	5.6 (142)	8.4 (214)	3.0 (76)
5" (125)	IST05	5.9 (149)	10.1 (256)	3.7 (94)



### Tee Cap

Seals non-utilized tees and branch tees.

Nominal Diameter	Part #	Max O.D. "A"
2" (60)	ISTC02	3.0 (76)
3" (80)	ISTC03	3.8 (97)
4" (110)	ISTC04	5.1 (129)
5" (125)	ISTC05	5.8 (146)



Condensate Management

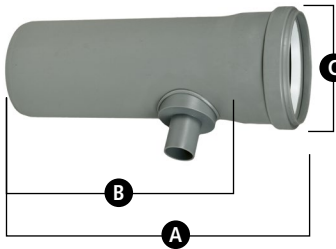

Horizontal Drain Tee

Use with any InnoFlue® siphon to drain condensate from the vent system. Install in horizontal section closest to appliance. 1.26" (32mm) O.D. drain.

Nominal Diameter	Part #	Overall Length "A"	Effective Length "B"	Max O.D. "C"
2" (60)	ISHDT02	9.8 (250)	7.3 (186)	3.0 (76)
3" (80)	ISHDT03	9.8 (250)	7.3 (186)	3.7 (94)
4" (110)	ISHDT04	12.4 (315)	9.8 (250)	4.1 (129)
5" (125)	ISHDT05	12.4 (315)	9.8 (250)	5.8 (146)

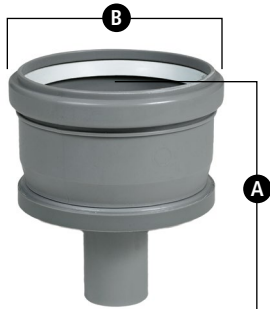

Tee Cap with Drain

Use with any InnoFlue® siphon to drain condensate from the vent system.

Nominal Diameter	Part #	Overall Length "A"	Max O.D. "B"	Drain O.D. "C"
2" (60)	ISTCD02	6.1 (155)	3.0 (75)	1.3 (32)
3" (80)	ISTCD03	5.3 (135)	3.7 (95)	1.3 (32)
4" (110)	ISTCD04	5.9 (150)	5.0 (126)	1.3 (32)
5" (125)	ISTCD05	6.4 (163)	5.8 (146)	1.3 (32)

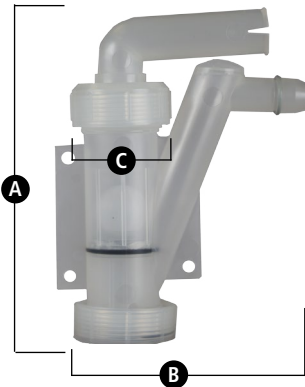

Universal Ball Valve Siphon

Attaches to any InnoFlue® drain. Allows condensates to flow while unique ball valve assures combustion gases remain contained at higher temperatures. Comes with and can be installed with a barbed or compression fitting. See configuration options below.

Part #	Overall Height "A"	Width "B"	Length "C"
IASJBVS	6.5	4.5	1.9

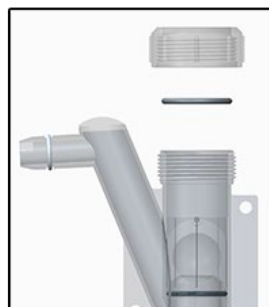

Standard



Barbed



NRV

Horizontal Vent Kits

Residential  
SW



Horizontal Vent Kit

Includes all fittings and accessories required for short sidewall termination vent runs.

Nominal Diameter	Part #
2" (60)	ISVKH02
3" (80)	ISVKH03
4" (110)	ISVKH04
5" (125)	ISVKH05

Terminations

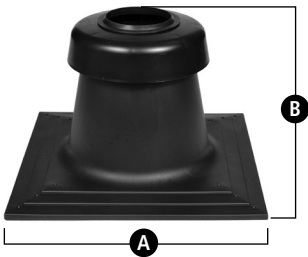

**Chimney Cover PPs-UV**

This termination incorporates a combustion air intake and flue gas termination in a single assembly. Cover seals top of the chimney or chase. Use with End Pipe or Flex End Pipe. End Pipes sold separately.

Nominal Diameter	Part #	Length "A"	Height "B"
2" (60)	ISCP02	15.8 (400)	9.6 (245)
3" (80)	ISCP03	15.8 (400)	9.6 (245)
4" (110)	ISCP04	15.8 (400)	9.6 (245)

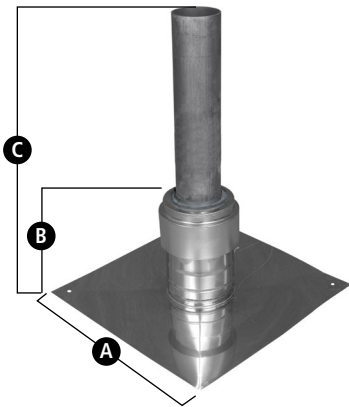

**Chimney Cover SS W/PPs-UV End Pipe**

Stainless steel termination with polypropylene end pipe incorporates a combustion air intake and flue gas termination in a single assembly.

Nominal Diameter	Part #	Length "A"	Height "B"	Height "C"
3" (80)	ISCM03	16.5 (419.1)	7.9 (200)	13.75 (349.3)
4" (110)	ISCM04	16.5 (419.1)	7.9 (200)	13.75 (349.3)
5" (125)	ISCM05	16.5 (419.1)	7.9 (200)	13.75 (349.3)

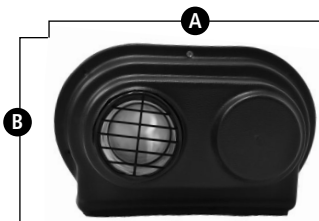

**Low Profile Wall Termination**

Low Profile Wall Termination incorporates air intake and exhaust into a single aesthetically pleasing termination. Part is paintable to match exterior of structure. Comes with interior wall plate and bird screen. Exhaust can be extended or re-directed with elbows or vent lengths. Vent lengths and elbows sold separately.

Nominal Diameter	Part #	Overall Width "A"	Overall Height "B"
2" (60)	ISLPT0202	13 (330)	9.1 (231)
3" (80)	ISLPT0303	13 (330)	9.1 (231)



SW Residential



## Universal B-Vent Cap

Allows for multiple flue configurations. Utilize existing B-Vent as a chase. Clean, professional and aesthetically pleasing. Installs quickly and easily.

Part #	Length	Height	Width
IAUBVC	10"	10"	10"

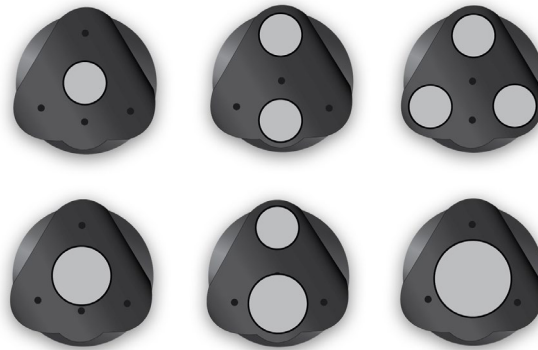

One Part → Multiple Configurations

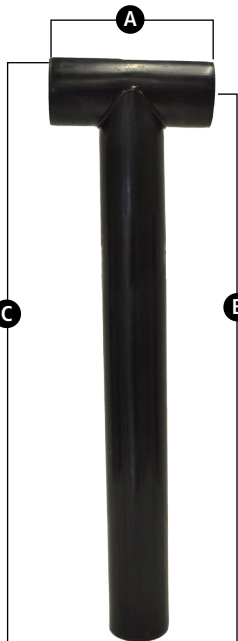

## Termination Tee

Made from black U.V. stabilized polypropylene. Use where termination is exposed to excessive sunlight, wind or prone to freeze ups.

Nominal Diameter	Part #	Overall Width "A"	Effective Length "B"	Max Length "C"
2" (60)	ISTT0220	7.6 (193)	27.6	28.8
3" (80)	ISTT0320	7.6 (193)	27.6	29.2
4" (110)	ISTT0420	7.6 (193)	27.6	29.8
5" (125)	ISTT0520	8.0 (203)	27.6	30.1

### End Pipe PPs-UV

Made from black U.V. stabilized polypropylene. Use where termination is exposed to excessive sunlight.

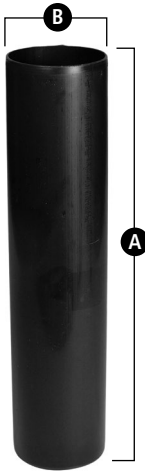

Nominal Diameter	Part #	Overall Length "A"	Max O.D. "B"
2" (60)	ISEP02	19.7 (500)	2.4 (60)
2" (60)	ISEP0239	39.4 (1000)	2.4 (60)
3" (80)	ISEP03	19.7 (500)	3.2 (80)
3" (80)	ISEP0339	39.4 (1000)	3.2 (80)
4" (110)	ISEP04	19.7 (500)	4.3 (110)
4" (110)	ISEP0439	39.4 (1000)	4.3 (110)

### Vent Lengths PPs-UV

Allows for the exterior extension of the vent system.

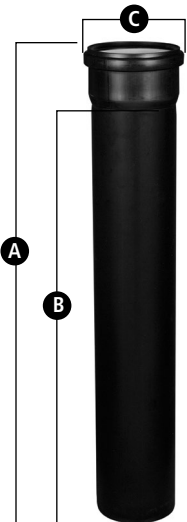

Nominal Diameter	Part #	Overall Length "A"	Effective Length "B"	Max O.D. "C"
2" (60)	ISVL022UV	28.4 (721)	24 (610)	3.0 (75)
3" (80)	ISVL032UV	28.4 (721)	24 (610)	3.8 (97)
4" (110)	ISVL042UV	28.2 (716)	24 (610)	5.1 (129)
5" (125)	ISVL052UV	26.5 (673)	24 (610)	5.8 (146)

### 45° Elbow Long PPS-UV

For exterior offsets or changes in the direction of the vent system.



Nominal Diameter	Part #	Centerline Offset "A"	Effective Length "B"	Max O.D. "C"
2" (60)	ISELL0245UV	2.2 (56)	3.8 (96)	3.0 (76)
3" (80)	ISELL0345UV	2.9 (73)	4.6 (117)	3.8 (97)

### 45° Elbow PPS-UV

For exterior offsets or changes in the direction of the vent system.



Nominal Diameter	Part #	Centerline Offset "A"	Effective Length "B"	Max O.D. "C"
4" (110)	ISEL0445UV	2.2 (63)	4.1 (105)	5.1 (129)



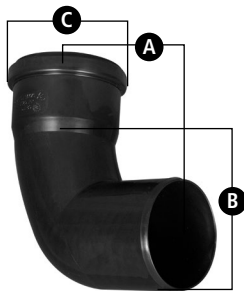

### 87° Elbow Long PPS-UV

For exterior offsets or changes in the direction of the vent system.

Nominal Diameter	Part #	Centerline Offset "A"	Effective Length "B"	Max O.D. "C"
2" (60)	ISELL0287UV	2.5 (63)	4.8 (121)	3.0 (76)
3" (80)	ISELL0387UV	5.3 (133)	5.1 (129)	3.8 (97)



### 87° Elbow PPS-UV

For exterior offsets or changes in the direction of the vent system.

Nominal Diameter	Part #	Centerline Offset "A"	Effective Length "B"	Max O.D. "C"
4" (110)	ISEL0487UV	2.4 (80)	4.6 (118)	5.1 (129)

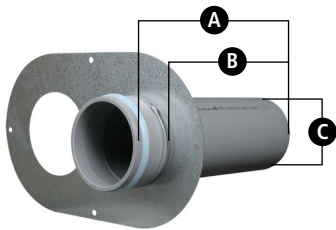

### PPs to PVC Termination Kit

Adapts PPs to PVC Twin Pipe Termination. Comes with replacement wall plate and termination adaptor.

Nominal Diameter	Part #	Overall Length "A"	Effective Length "B"	End O.D. "C"
2" (60)	ISLTK02	12.3 (313)	11.0 (280)	2.4 (61)
3" (80)	ISLTK03	13.0 (330)	11.0 (280)	3.5 (89)
4" (110)	ISLTK04	13.2 (336)	11.0 (280)	4.5 (115)



### Bird Screen PPS-UV

Fits inside InnoFlue® SW and Flex end-pipes at terminations.

Nominal Diameter	Part #
2" (60)	IASPP02
3" (80)	IASPP03
4" (110)	IASPP04



### Bird Screen SS

Fits inside InnoFlue® SW and Flex end-pipes at terminations.

Nominal Diameter	Part #
5" (125)	IASSS05

## Spacers

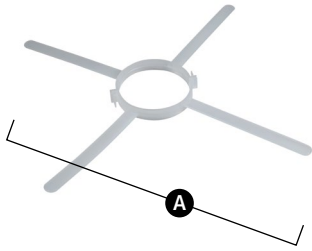

### 2", 3", 4" and 5" Spacers

Self positioning spacers center InnoFlue® SW or Flex in a chase/chimney/B-vent.

Nominal Diameter	Part #	Max Width "A"	Min Width
2" (60)	IASP02	23.5 (596)	3.3 (85)
3" (80)	IASP03	22.8 (580)	4.2 (106)
4" (110)	IASP04	23.9 (606)	5.4 (138)
5" (125)	IASP05	24.6 (625)	6 (151)

## Accessories

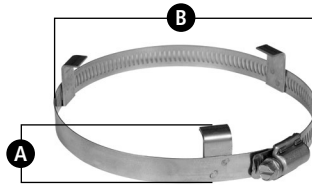

### Flue Clamp

Secures ISAGL appliance adaptors to appliance flue collar.

Nominal Diameter	Part #	Height "A"	Max. I.D. "B"
2" (60)	IAFC02	1.0 (26)	3.0 (77)
3" (80)	IAFC03	1.0 (26)	4.3 (110)
4" (110)	IAFC04	1.0 (26)	5.0 (127)

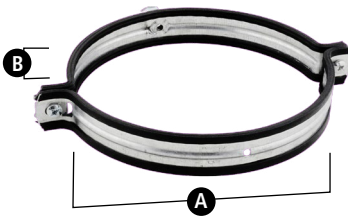

### Support Clamp

Used as vertical or horizontal support. Space 78" in vertical and 39" in horizontal installations.

Uses 3/8" threaded rod.

Nominal Diameter	Part #	Overall Length "A"	Height "B"
2" (60)	IASCM02	3 (76.2)	1.1(28)
3" (80)	IASCM03	3.8 (96.5)	1.1 (28)
4" (110)	IASCM04	5.3 (134.6)	1.1 (28)
5" (125)	IASCM05	5.8 (147.3)	1.1 (28)

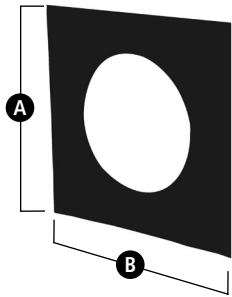

## Wall Plate Square (Plastic)

Used to improve aesthetics and reduce drafts at chimney openings or wall penetrations.

Nominal Diameter	Part #	Length "A"	Length "B"
2" (60)	IAWP02BP	6 (150)	6 (150)
3" (80)	IAWP03BP	6 (150)	6 (150)
4" (110)	IAWP04BP	6 (150)	6 (150)

## Connector Ring

Provides reinforcement at joints to support loads of up to 99 lbs (45Kg).

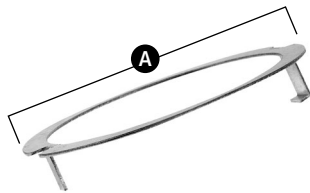

Nominal Diameter	Part #	O.D. "A"
2" (60)	IAN502	3.2 (81)
3" (80)	IAN503	4.1 (103)
4" (110)	IAN504	5.3 (134)
5" (125)	IAN505	5.8 (148)

## EPDM Gaskets

Standard gasket for 2" through 5" diameter InnoFlue® SW. Inserted into the female end of each part, the gaskets keep flue gases and condensates within the vent system.



Nominal Diameter	Part #
2" (60)	ISGE02
3" (80)	ISGE03
4" (110)	ISGE04
5" (125)	ISGE05

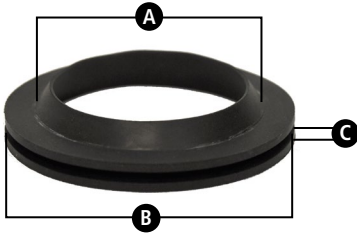

### B-Vent Gasket

Rubber gasket for converting existing B-Vent into a combustion air chase.

Nominal Diameter	Part #	Flange I.D. "A"	Max O.D. "B"	Groove Thickness "C"
2" (60)	IACGE02	2.8 (72)	3.5 (88)	0.1 (2.5)
3" (80)	IACGE03	3.6 (92)	4.3 (108)	0.1 (2.5)
4 (110)	IACGE04	4.8 (122)	5.4 (137)	01 (2.5)



### Centrocerin

A water based lubricant used to ease the assembly of InnoFlue® SW & Flex. Sparingly applied to the gasket or male end.

Package Size	Part #
50 ml	IACE50

# INNOFLUE® FLEX TYPICAL CONFIGURATIONS

Refer to product key on page 8

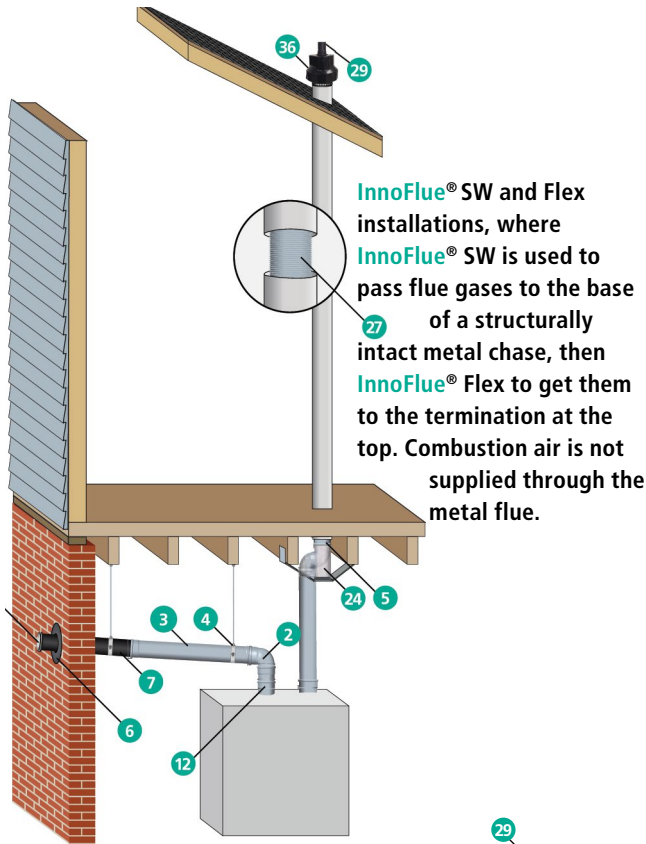

InnoFlue® SW and Flex installations, where InnoFlue® SW is used to pass flue gases to the base of a structurally intact metal chase, then InnoFlue® Flex to get them to the termination at the top. Combustion air is not supplied through the metal flue.

InnoFlue® SW and Flex installations, where InnoFlue® SW is used to pass flue gases to the base of the chimney, then InnoFlue® Flex to get them to the termination at the top.

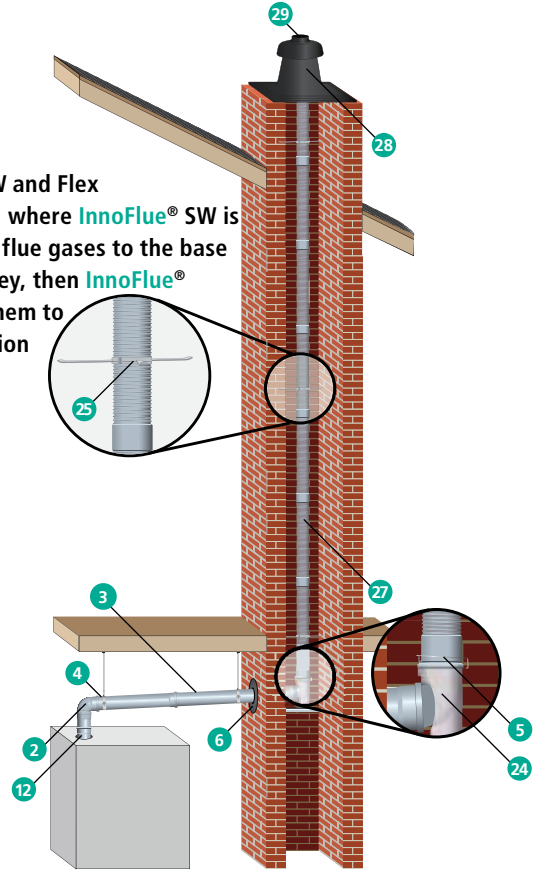

InnoFlue® SW and Flex installations, where InnoFlue® SW is used to pass flue gases to the base of the chimney, then InnoFlue® Flex to get them to the termination at the top. Combustion air is not supplied through the masonry chimney.

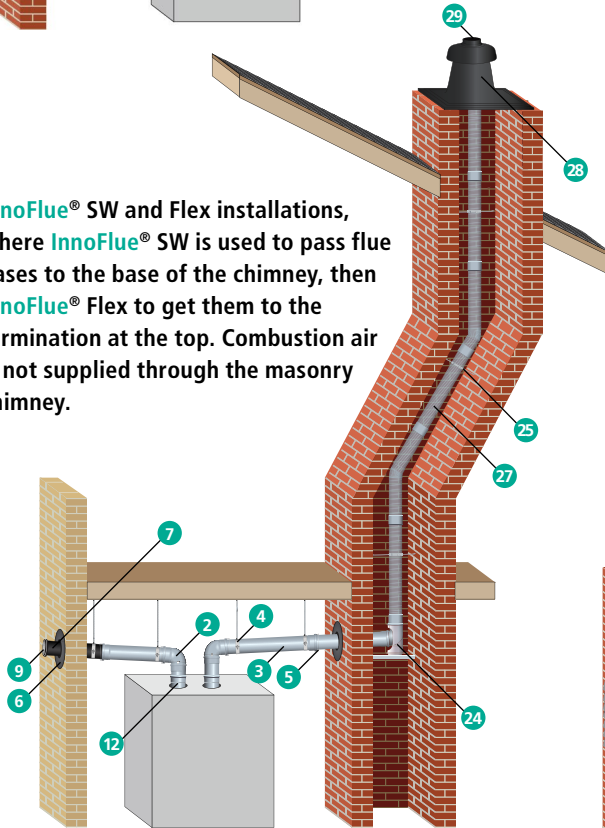

InnoFlue® SW and Flex installations, where InnoFlue® is used to pass flue gases of multiple appliances to the base of a structurally intact masonry chimney or metal flue, then InnoFlue® SW or Flex to get them to the Custom Chimney Cover at top.

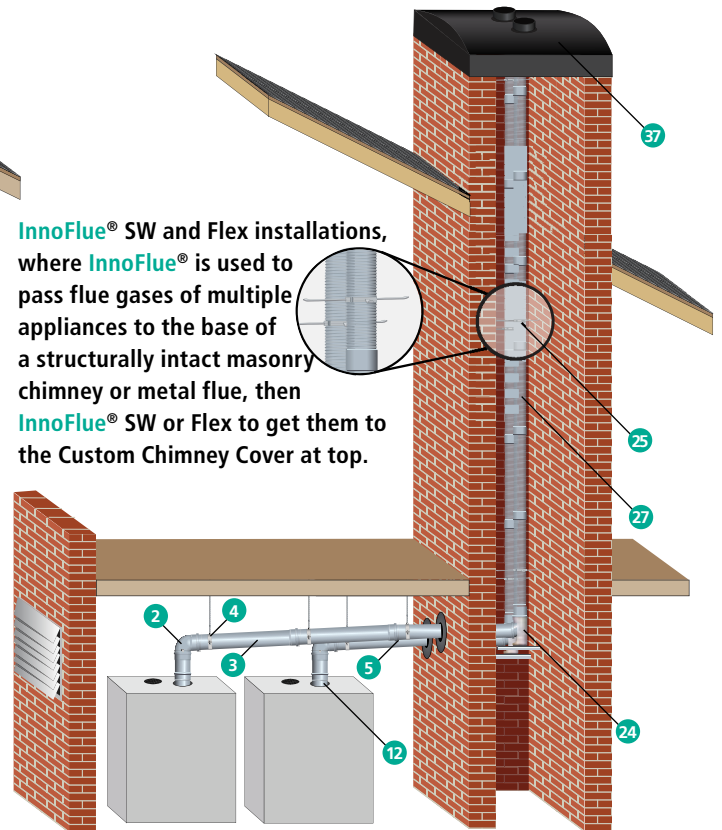



## Flex Vent Lengths

### 2" Flex

Is manufactured from polypropylene. 2" Flex can be field cut and is ideal for use in chimneys with offsets. With couplers, 2" Flex can be connected to 2" Flex or InnoFlue® SW.



Nominal Diameter	Part #	Overall Height "A"	Max O.D. "B"
2" (60)	IFVL02025	25' (7.6m)	2.3 (58)
2" (60)	IFVL02035	35' (10.7m)	2.3 (58)
2" (60)	IFVL02050	50' (15.2m)	2.3 (58)
2" (60)	IFVL02150	150' (45.7m)	2.3 (58)

### 3" and 4" Flex

Are manufactured from polypropylene and feature rigid sections every 2'. 3", and 4" Flex can be field cut and are ideal for use in chimneys with offsets. The base of your 3" and 4" Flex can be connected to InnoFlue® SW at any rigid section without coupler. Flex to Flex couplers available for extended flex runs.



Nominal Diameter	Part #	Overall Height "A"	Max O.D. "B"
3" (80)	IFVL03025	25' (7.6m)	3.3 (84)
3" (80)	IFVL03035	35' (10.7m)	3.3 (84)
3" (80)	IFVL03040	40' (12.2m)	3.3 (84)
3" (80)	IFVL03050	50' (15.2m)	3.3 (84)
3" (80)	IFVL03080	80' (24.4m)	3.3 (84)
3" (80)	IFVL03150	150' (45.7m)	3.3 (84)
4" (110)	IFVL04025	25' (7.6m)	4.3 (110)
4" (110)	IFVL04035	35' (10.7m)	4.3 (110)
4" (110)	IFVL04040	40' (12.2m)	4.3 (110)
4" (110)	IFVL04050	50' (15.2m)	4.3 (110)
4" (110)	IFVL04080	80' (24.4m)	4.3 (110)

## Couplers

Flex



### SW to Flex Coupler

Transitions 2" InnoFlue® Single Wall Rigid to 2" InnoFlue® Flex.

Nominal Diameter	Part #	Overall Length "A"	Effective Length "B"	Max O.D. "C"
2" (60)	IFSFC02	4.2 (107)	3.2 (81)	2.6 (65)

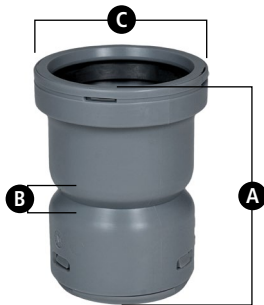

### Flex to SW Coupler

Transitions 2" InnoFlue® Flex to 2" InnoFlue® Single Wall Rigid.

Nominal Diameter	Part #	Overall Length "A"	Effective Length "B"	Max O.D. "C"
2" (60)	IFFSC02	3.9 (99)	1.1 (28)	3.0 (76)

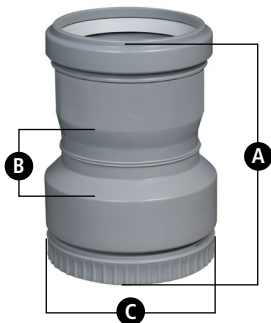

### Flex to SW Coupler

Transitions InnoFlue® Flex to InnoFlue® Single Wall Rigid.

Nominal Diameter	Part #	Overall Length "A"	Effective Length "B"	Max O.D. "C"
3" (80)	IFFSC03	5.5 (138)	4.3 (60)	3.9 (100)
4" (110)	IFFSC04	6.5 (171)	2.64 (67)	5.1 (128)

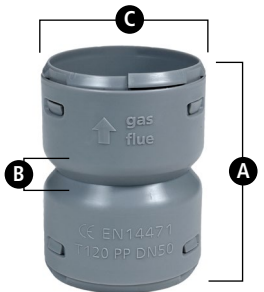

### Flex to Flex Coupler

Connects 2" InnoFlue® Flex to 2" InnoFlue® Flex.

Nominal Diameter	Part #	Overall Length "A"	Effective Length "B"	Max O.D. "C"
2" (60)	IFFFC02	3.4 (87)	1.4 (35)	2.6 (65)

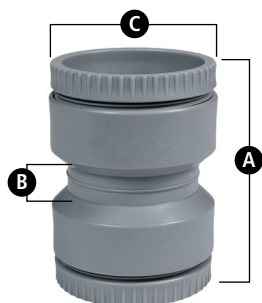

### Flex to Flex Coupler

Connects 3" and 4" InnoFlue® Flex to 3" and 4" InnoFlue® Flex.

Nominal Diameter	Part #	Overall Length "A"	Effective Length "B"	Max O.D. "C"
3" (80)	IFFFC03	5.5 (141)	4.3 (60)	3.9 (100)
4" (110)	IFFFC04	6.7 (166)	4.5 (114)	5.1 (128)

## B-Vent Kits



Kit contains B-Vent Support Bracket, Base Support, Single Wall-To-Flex Coupler, 2" Flex, Flex End Pipe, Universal B-Vent Cap, Connector Ring, Spacers and Centrocerin®.

### 2" B-Vent Kit

Includes all components necessary to line a B-Vent from base to termination. Rigid vent lengths, elbows and adaptors required to connect B-Vent base support to appliance are sold separately.

Nominal Diameter	Part #	Flex Vent Length
2" (60)	IFBK0225	25' (7.6m)
2" (60)	IFBK0235	35' (10.6m)
2" (60)	IFBK0250	50' (15.25m)

Flex



Kit contains B-Vent Support Bracket, Base Support, 3" or 4", Flex End Pipe, Universal B-Vent Cap, Connector Rings, Spacers and Centrocerin.

### 3" and 4" B-Vent Kit

Includes all components necessary to line a B-Vent from base to termination. Rigid vent lengths, elbows and adaptors required to connect B-Vent base support to appliance are sold separately.

Nominal Diameter	Part #	Flex Vent Length	B-Vent Diameter
3" (80)	IFBK0325	25' (7.6m)	4", 5", 6"
3" (80)	IFBK0335	35' (10.6m)	4", 5", 6"
3" (80)	IFBK0350	50' (15.25m)	4", 5", 6"
4" (110)	IFBK0425	25' (7.6m)	5", 6"
4" (110)	IFBK0435	35' (10.6m)	5", 6"
4" (110)	IFBK0440	40' (12.1m)	5", 6"

## Flex Component B-Vent Kits

Flex



Kit includes B-Vent Support Bracket, Base Support, Single Wall-To-Flex Coupler, Flex End Pipe, Universal B-Vent Cap, Connector Ring, Spacers and Centrocerin.

### 2" Flex Component B-Vent Kit

Includes all fittings and accessories required to line a B-Vent excluding 2" flex. 2" flex and rigid vent length, elbows, adaptors required to connect B-Vent Base Support to appliance, and termination are sold separately.

Nominal Diameter	Part #	B-Vent Diameter
2" (60)	IFBKC02	4"

### 3" and 4" Flex Component B-Vent Kit

Includes all fittings and accessories required to line a B-Vent excluding 3" or 4" Flex. 3" or 4" flex and rigid vent length, elbows, adaptors required to connect B-Vent Base Support to appliance, and termination are sold separately.

Nominal Diameter	Part #	B-Vent Diameter
3" (80)	IFBKC03	4"
4" (110)	IFBKC04	5"



Kit includes B-Vent Support Bracket, Base Support, Flex End Pipe, Universal B-Vent Cap, Connector Ring, Spacers and Centrocerin.

## Chimney Kits



Kit contains Base Support, Single Wall to Flex Coupler, Flex Vent Length, Flex End Pipe, Chimney Cover, Connector Rings, Spacers and Centrocerin.

### 2" Chimney Kit

Includes all components necessary to line a chimney from chimney termination to Base Support. Rigid vent lengths, elbows and adaptors required to connect chimney kit base support to appliance are sold separately. Custom flex lengths are available.

Nominal Diameter	Part #	Flex Vent Length
2" (60)	IFCK0225	25' (7.6m)
2" (60)	IFCK0235	35' (10.7m)
2" (60)	IFCK0250	50' (15.2m)

Flex



Kit contains Base Support, Flex Vent Length, Flex End Pipe, Chimney Cover, Connector Rings, Spacers and Centrocerin.

### 3" and 4" Chimney Kit

Includes all components necessary to line a chimney from chimney termination to Base Support. Rigid vent lengths, elbows and adaptors required to connect chimney kit base support to appliance are sold separately. Custom flex lengths are available.

Nominal Diameter	Part #	Flex Vent Length
3" (80)	IFCK0325	25' (7.6m)
3" (80)	IFCK0335	35' (10.7m)
3" (80)	IFCK0350	50' (15.2m)
4" (110)	IFCK0425	25' (7.6m)
4" (110)	IFCK0435	35' (10.7m)
4" (110)	IFCK0440	40' (12.2m)
4" (110)	IFCK0450	50' (15.2m)



Kit contains Base Support, Single Wall to Flex Coupler, Chimney Cover, Flex End Pipe, Connector Ring, Spacers and Centrocerin.

## 2" Flex Component Chimney Kit

Includes all components necessary to line a chimney from chimney termination to Base Support excluding 2" flex. 2" flex and rigid vent lengths, elbows, adaptors required to connect Base Support to appliance, and termination are sold separately.

Nominal Diameter	Part #
2" (60)	IFCKC02



Kit contains Base Support, Chimney Cover, Flex End Pipe, Connector Rings, Spacers and Centrocerin.

## 3" and 4" Flex Component Chimney Kit

Includes all components necessary to line a chimney from chimney termination to Base Support excluding 3" or 4" flex. 3" or 4" flex and rigid vent lengths, elbows, adaptors required to connect Base Support to appliance, and termination are sold separately.

Nominal Diameter	Part #
3" (80)	IFCKC03
4" (110)	IFCKC04

## Terminations

### Chimney Cover PPs-UV

This termination incorporates a combustion air intake and flue gas termination in a single assembly. Cover seals top of the chimney or chase. Use with End Pipe or Flex End Pipe. End Pipes sold separately.

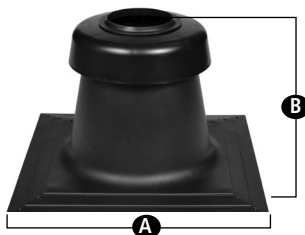

Nominal Diameter	Part #	Length "A"	Height "B"
2" (60)	ISCP02	15.8 (400)	9.6 (245)
3" (80)	ISCP03	15.8 (400)	9.6 (245)
4" (110)	ISCP04	15.8 (400)	9.6 (245)

### Custom Chimney Cover PPs-UV

Custom Chimney Cover sizes available, including multiple flue versions. Call with size requirements for pricing.



### 2" Flex End Pipe

Terminates InnoFlue® Flex at top of chimney. Used in combination with Chimney Cover PPs-UV or B-Vent Cap

Nominal Diameter	Part #	Overall Length "A"	Effective Length "B"	Max O.D. "C"
2" (60)	IFEP02	5.3 (135)	4.1 (105)	3.9 (99)

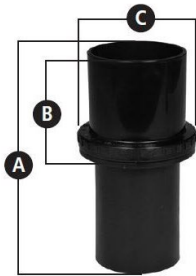

### 3" and 4" Flex End Pipe

Terminates InnoFlue® Flex at top of chimney. Used in combination with Chimney Cover PPs-UV or B-Vent Cap

Nominal Diameter	Part #	Overall Length "A"	Effective Length "B"	Max O.D. "C"
3" (80)	IFEP03	7.1 (180)	3.3 (84)	3.9 (100)
4" (110)	IFEP04	10.0 (253)	3.5 (89)	5.2 (132)



### Universal B-Vent Cap

Allows for multiple flue configurations. Utilize existing B-Vent as a chase. Clean, professional and aesthetically pleasing. Installs quickly and easily.

Part #	Length	Height	Width
IAUBVC	10"	10"	10"

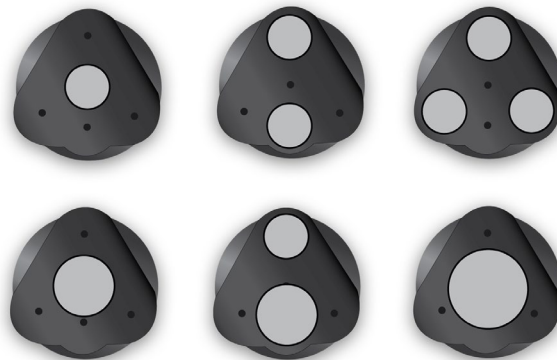

One Part ➦ Multiple Configurations

Flex



## INNOFLUE® CONCENTRIC

### Applications and Limitations

- In order to maintain relevant listings and Centrotherm's warranty, **InnoFlue®** vent systems may not be combined with any polymeric or stainless steel vent components that are not part of Centrotherm's published offerings.
- **InnoFlue®** Concentric must be installed following Centrotherm's published installation instructions.
- **InnoFlue®** Concentric are ETL listed to UL and ULC standards for use with natural gas or propane fired, Cat. II or Cat. IV appliances (US) or BH Gas Class II A, B, and C gas or propane fired appliances (Canada).
- **InnoFlue®** Concentric can also be used for oil fired, condensing appliances with a maximum flue gas temperature that does not exceed 230°F (110°C).
- **InnoFlue®** Concentric is ETL listed to UL 1738 and ULC-S636 at zero clearance to combustibles.
- **InnoFlue®** Concentric may be installed inside a masonry or sheet rocked chase, between floor joists, directly through a wall or if properly supported, can even be left exposed along the interior of a structure.
- **InnoFlue®** Concentric is available in 2"/4", 3"/5" and 4"/6" diameters and offers all necessary components for combining it with **InnoFlue®** SW and **InnoFlue®** Flex to meet specific job requirements.
- Do not install where ambient air temperature can exceed 300°F.



# INNOFLUE® CONCENTRIC TYPICAL CONFIGURATIONS

- 4 IASCM: Support Clamp
- 6 IAWP: Wall Plate
- 15 ICRT: Concentric Roof Termination
- 31 ICTP: Concentric Test Port
- 32 ICCEL45: Concentric 45° Elbow
- 33 ICVL: Concentric Vent Length
- 34 ICCEL87: Concentric 87° Elbow
- 35 ICWT: Concentric Wall Termination PP

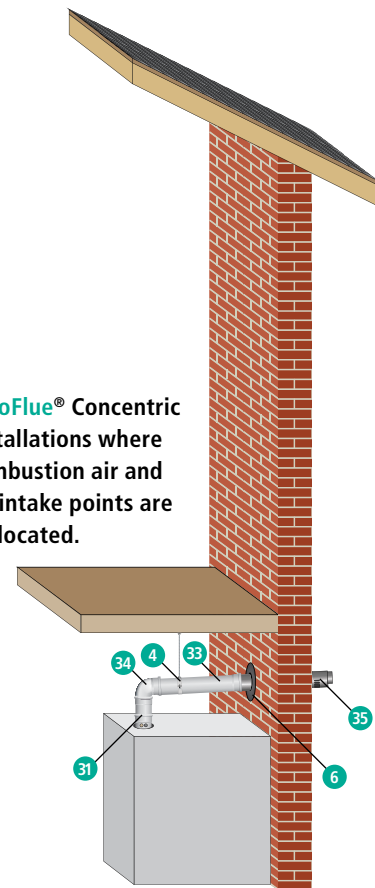
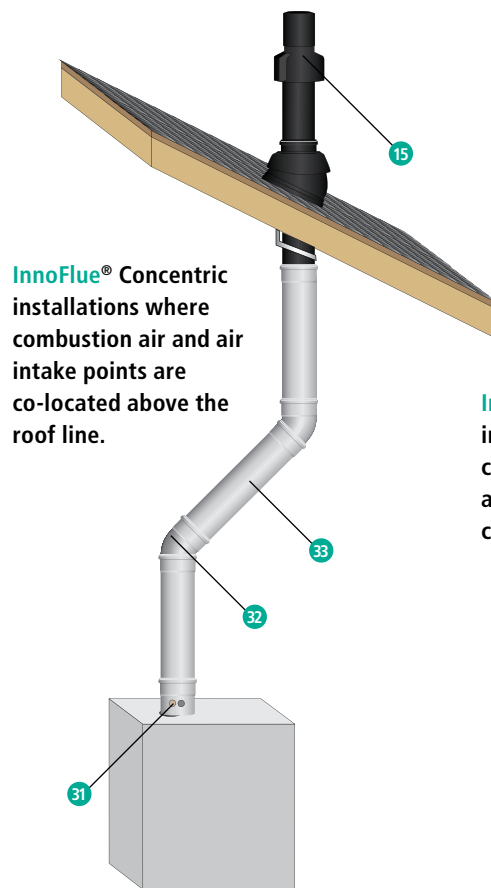

## Concentric Adaptors

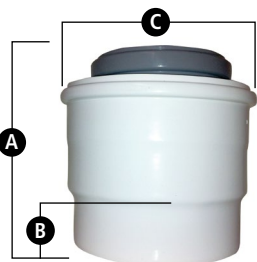

### Concentric Centric Increaser

Transitions from one diameter to a larger diameter. Install in vertical orientation only.

Nominal Diameter	Part #	Overall Length "A"	Effective Length "B"	Max O.D. "C"
4" / 6" (100/150mm)	ICIA10015046	6.0 (163)	4.1 (105)	6.8 (173)
4" / 6" (110/150mm)	ICIA11015046	6.0 (163)	4.1 (105)	6.8 (173)

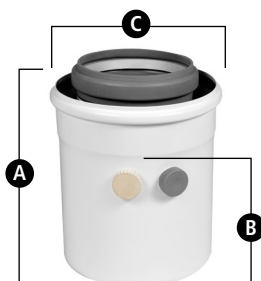

### Concentric Test Port

Installed immediately above the appliance, the test port allows plumbing and heating professionals to sample flue gases and ensure the appliance is operating at optimum efficiency.

Nominal Diameter	Part #	Overall Length "A"	Effective Length "B"	Max O.D. "C"
2" / 4" (60/100)	ICTP24	6.7 (170)	4.3 (110)	4.4 (112)
3" / 5" (80/125)	ICTP35	6.7 (170)	4.3 (110)	5.5 (139)
4" / 6" (110/160)	ICTP46	8.1 (207)	5.6 (143)	6.8 (173)

# INNOFLUE® CONCENTRIC

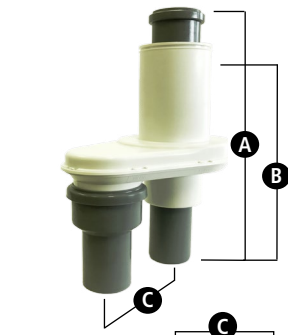

## Twin Pipe/Concentric Reversible Adaptor

Reversible adaptor transitions between InnoFlue® Single Wall and Concentric. Reducer and vent length included.

Nominal Diameter	Part #	Overall Length "A"	Effective Length "B"	Offset "C"
2" / 4" (60/100)	ITCR24	16.4 (411)	12 (305)	4.76 (120)

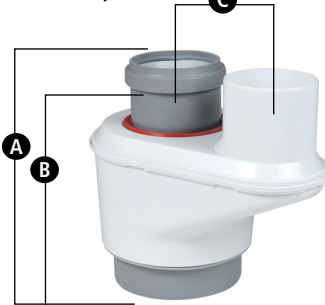

## Concentric to Twin Pipe Adaptor

Transitions Concentric to twin pipe Single Wall.

Nominal Diameter	Part #	Overall Length "A"	Effective Length "B"	Offset "C"
3" / 5" (80/125)	ICCT3503	9.8 (250)	5.9 (150)	4.8 (121)

Concentric

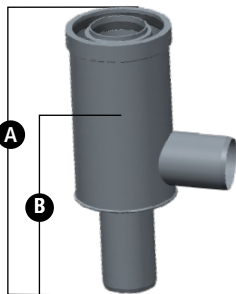

## Twin Pipe to Concentric Adaptor

Transitions twin pipe Single Wall to Concentric.

Nominal Diameter	Part #	Overall Length "A"	Effective Length "B"
4" / 6" (110/160)	ICTC0446	14.5 (316)	10.0 (25.3)

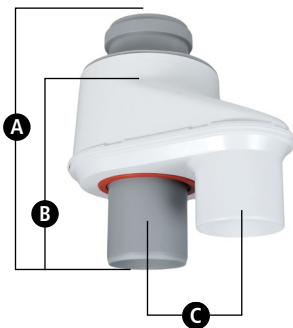

## Twin Pipe to Concentric Adaptor

Transitions twin pipe Single Wall to Concentric.

Nominal Diameter	Part #	Overall Length "A"	Effective Length "B"	Offset "C"
3" / 5" (80/125)	ICTC0335	9.8 (250)	7.9 (200)	4.8 (121)

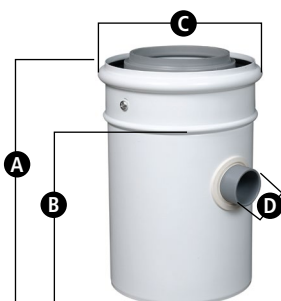

## Concentric Horizontal Drain Tee

Use to drain condensate from the vent system. Install in horizontal section closest to appliance.

Nominal Diameter	Part #	Overall Length "A"	Effective Length "B"	Max O.D. "C"	Drain O.D. "D"
2" / 4" (60/100)	ICHDT24	7.9 (200)	5.9 (150)	4.4 (112)	1.4 (32)
3" / 5" (80/125)	ICHDT35	7.9 (200)	5.9 (150)	5.5 (139)	1.4 (32)
4" / 6" (110/160)	ICHDT46	7.9 (200)	5.9 (150)	6.8 (173)	1.4 (32)

## Concentric Vent Lengths

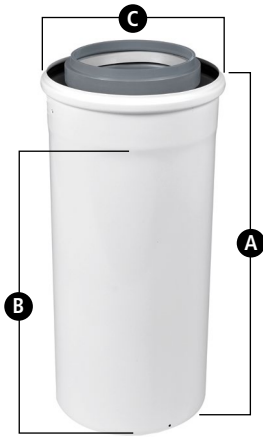

### Concentric Vent Lengths

Rigid polypropylene vent lengths with metal outer and dedicated male and female ends. Female end contains internal gasket and male ends can be field cut and chamfered to desired length.

Nominal Diameter	Part #	Overall Length "A"	Effective Length "B"	Max O.D. "C"
2" / 4" (60/100)	ICVL241	14.5 (368)	12 (305)	4.4 (112)
2" / 4" (60/100)	ICVL242	26.5 (673)	24 (610)	4.4 (112)
2" / 4" (60/100)	ICVL243	38.5 (978)	36 (914)	4.4 (112)
3" / 5" (80/125)	ICVL351	14.5 (368)	12 (305)	5.5 (139)
3" / 5" (80/125)	ICVL352	26.5 (673)	24 (610)	5.5 (139)
3" / 5" (80/125)	ICVL353	38.5 (978)	36 (914)	5.5 (139)
4" / 6" (110/160)	ICVL461	14.5 (368)	12 (305)	6.8 (173)
4" / 6" (110/160)	ICVL462	26.5 (673)	24 (610)	6.8 (173)
4" / 6" (110/160)	ICVL463	38.5 (978)	36 (914)	6.8 (173)

## Elbows

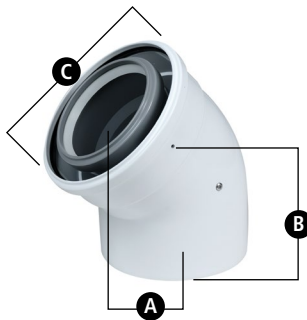

### Concentric 45° Elbow

For offsets or changes in the direction of the vent system.

Nominal Diameter	Part #	Centerline Offset "A"	Effective Length "B"	Max O.D. "C"
2" / 4" (60/100)	ICEL2445	.7 (18)	3.3 (85)	4.4 (112)
3" / 5" (80/125)	ICEL3545	1.3 (34)	4.6 (117)	5.5 (139)
4" / 6" (110/160)	ICEL4645	1.5 (39)	5.2 (133)	6.8 (173)

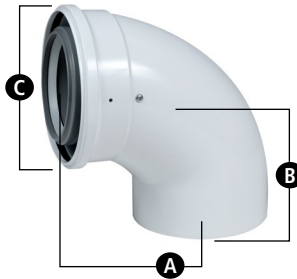

### Concentric 87° Elbow

For offsets or changes in the direction of the vent system.

Nominal Diameter	Part #	Centerline Offset "A"	Effective Length "B"	Max O.D. "C"
2" / 4" (60/100)	ICEL2487	2.0 (50)	4.8 (123)	4.4 (112)
3" / 5" (80/125)	ICEL3587	3.1 (79)	5.1 (129)	5.5 (139)
4" / 6" (110/160)	ICEL4687	4.4 (111)	6.5 (165)	6.8 (173)

## Wall Plates



### Wall Plate

Provides an aesthetically pleasing and water tight finish at wall penetrations when sealed with field-supplied silicone.

Nominal Diameter	Part #	Overall Diameter "A"	Width of Opening "B"
4" (100)	IAWP100B	5.6 (142)	4" (100)
5" (125)	IAWP05B	8.9 (226)	5" (125)

## Terminations

Concentric

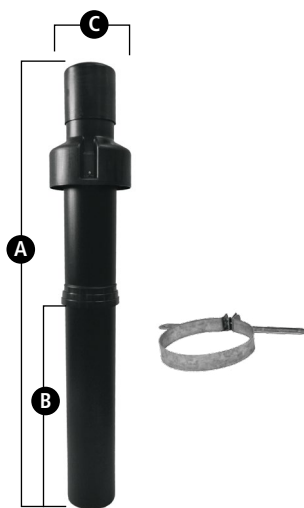

### Concentric Roof Termination

Roof Termination combines flue gas termination and combustion air intake. Use with InnoFlue® Concentric or with InnoFlue® SW by adding an ICTC Adapter. Includes support clamp.

Nominal Diameter	Part #	Overall Length "A"	Roof Line "B"	Max O.D. "C"
2" / 4" (60/100)	ICRT2439	39.4 (1000)	20.5 (520)	6.5 (166)
3" / 5" (80/125)	ICRT3539	39.4 (1000)	20.5 (520)	6.5 (166)
4" / 6" (110/160)	ICRT4679	78.7 (2000)	23.6 (600)	6.5 (166)

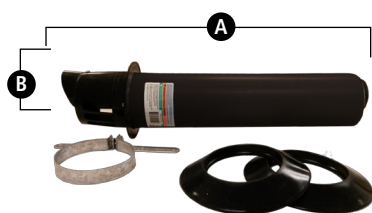

### Concentric Wall Termination

Made from PPs-UV outer and PPs-UV inner, the Concentric Wall termination incorporates flue gas termination and combustion air intake. Use with InnoFlue® Concentric or with InnoFlue® SW by adding an ICTC Adapter. Includes support clamp and wall plates.

Nominal Diameter	Part #	Overall Length "A"	O.D. "B"
2" / 4" (60/100)	ICWT242	21.2 (538)	5.54 (141)
3" / 5" (80/125)	ICWT352	28.3 (719)	5 (125)

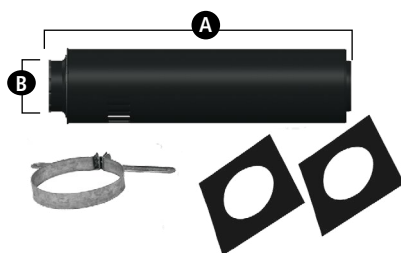

### Concentric Wall Termination

Made from PPs-UV outer and PPs-UV inner, the Concentric Wall termination incorporates flue gas termination and combustion air intake. Use with InnoFlue® Concentric or with InnoFlue® SW by adding an ICTC Adapter. Includes support clamp and wall plates.

Nominal Diameter	Part #	Overall Length "A"	O.D. "B"
4" / 6" (110/160)	ICWT462	32.0 (813)	6.3 (160)

### Support Clamp

Used as vertical or horizontal support. Space 78" in vertical and 39" in horizontal installations. **Uses 3/8" threaded rod.**

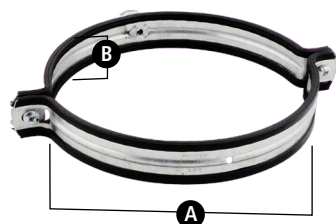

Nominal Diameter	Part#	Overall Length "A"	Height "B"
4" (100)	IASCM100	5.3 (134.6)	1.1 (28)
5" (125)	IASCM05	5.8 (147.3)	1.1 (28)
6" (160)	IASCM06	6.8 (172.7)	1.1 (28)

## Concentric Kits

### Concentric Kit Horizontal

Concentric Side Wall Venting Kit contains components needed to vent wall mounted appliance to wall termination. Additional components may be required for longer runs and are sold separately.



Nominal Diameter	Part #
2" / 4" (60/100)	ICVKH24
3" / 5" (80/125)	ICVKH35
4" / 6" (110/160)	ICVKH46

Kit includes one 3' Concentric Vent Length, Concentric Elbow, Concentric Wall Termination, Wall Plates and Support Clamp.



### Concentric Kit Vertical

Concentric Vertical Venting Kit contains components needed to vent vertically through roof. Additional components may be required for longer runs and are sold separately.

Nominal Diameter	Part #
2" / 4" (60/100)	ICVKV24
3" / 5" (80/125)	ICVKV35
4" / 6" (110/160)	ICVKV46

Kit includes one 2' and one 3' Concentric Vent Length, Concentric Roof Termination, one Wall Plate and Support Clamp.

## Applications and Limitations

- In order to maintain relevant listings and Centrotherm's warranty, **InnoFlue®** vent systems may not be combined with any polymeric or stainless steel vent components that are not part of Centrotherm's published offerings.
- **InnoFlue®** SW must be installed following Centrotherm's published installation instructions.
- **InnoFlue®** SW is ETL listed to UL and ULC standards for use with natural gas or propane fired, Cat. II or Cat. IV appliances (US) or BH Gas Class II A, B, and C gas or propane fired appliances (Canada).
- **InnoFlue®** SW can also be used for oil fired, condensing appliances with a maximum flue gas temperature that does not exceed 230°F (110°C).
- **InnoFlue®** SW is ETL listed to UL 1738 and ULC-S636 at zero clearance to combustibles.

Concentric

- **InnoFlue®** SW may be installed inside a masonry or sheet rocked chase, through an existing structurally intact metal flue, between floor joists, directly through a wall or if properly supported, can even be left exposed along the interior of a structure.

- **InnoFlue®** SW Commercial is available in 6", 8", 10" and 12" diameters and offers all necessary components.

- Single or multiple **InnoFlue®** SW Commercial runs may be installed into an existing masonry chimney or structurally intact metal flue or chase.

- Do not install where ambient air temperature can exceed 300°F.





# INNOFLUE® SW COMMERCIAL TYPICAL CONFIGURATIONS

- 2 ISEL87: 87° Elbow
- 3 ISVL: Vent Length
- 4 IASCM: Support Clamp
- 5 IANS: Connector Ring\*
- 6 IAWP: Wall Plate
- 7 ISEP: End Pipe PPs-UV
- 9 IASPP: Bird Screen PPs-UV
- 12 ISAGL or ISAAL: Appliance Adaptor
- 19 ISTD: Test Port
- 20 ISHDF: Horizontal Drain Fitting
- 21 IALJS: Siphon
- 22 ISBT: Branch Tee
- 23 ISEL0430: 30° Elbow
- 24 ISBS: Base Support
- 25 IASP: Spacer
- 26 ISCM: Chimney Cover SS w/PPs-UV End Pipe

\*where required

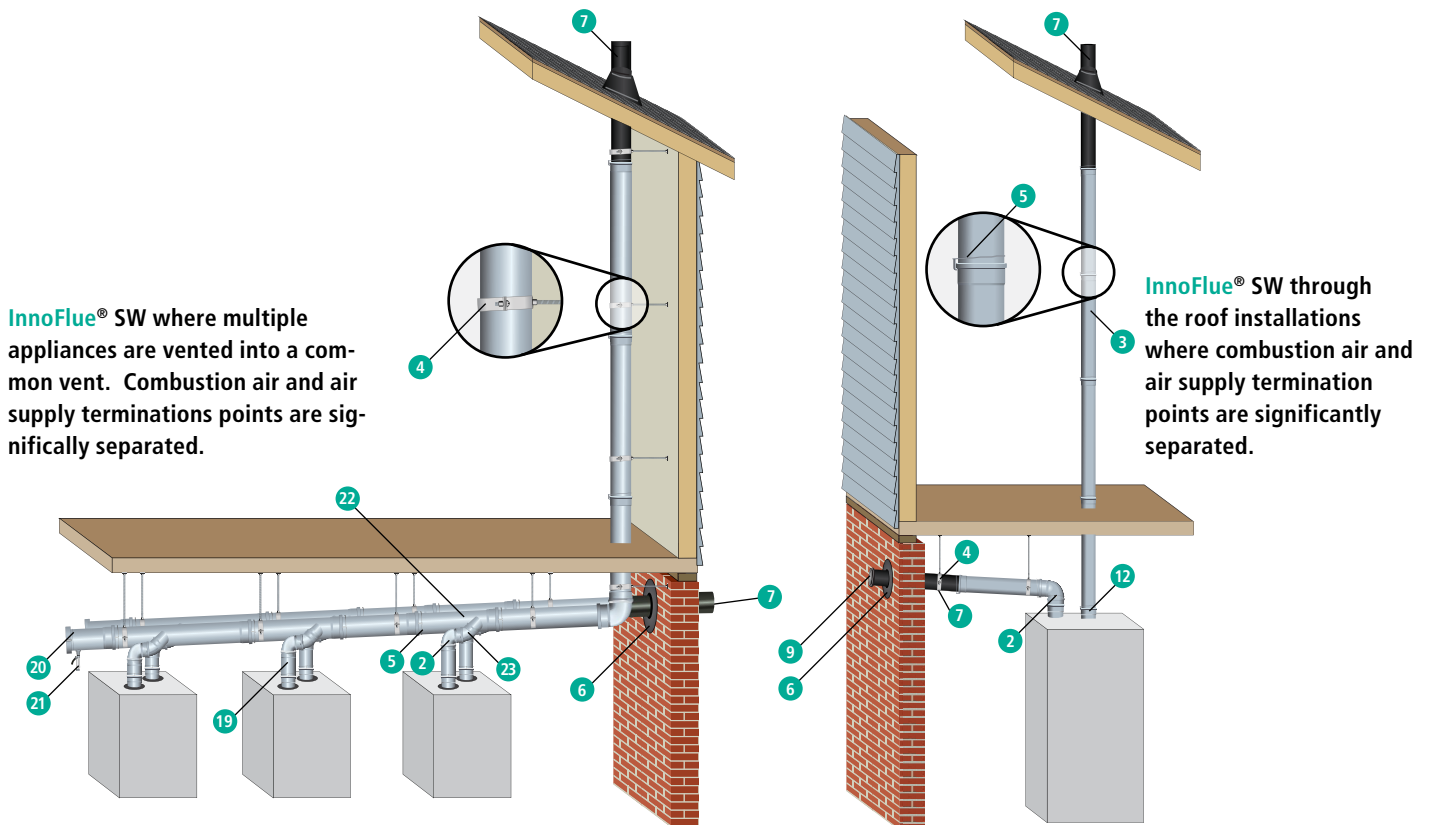
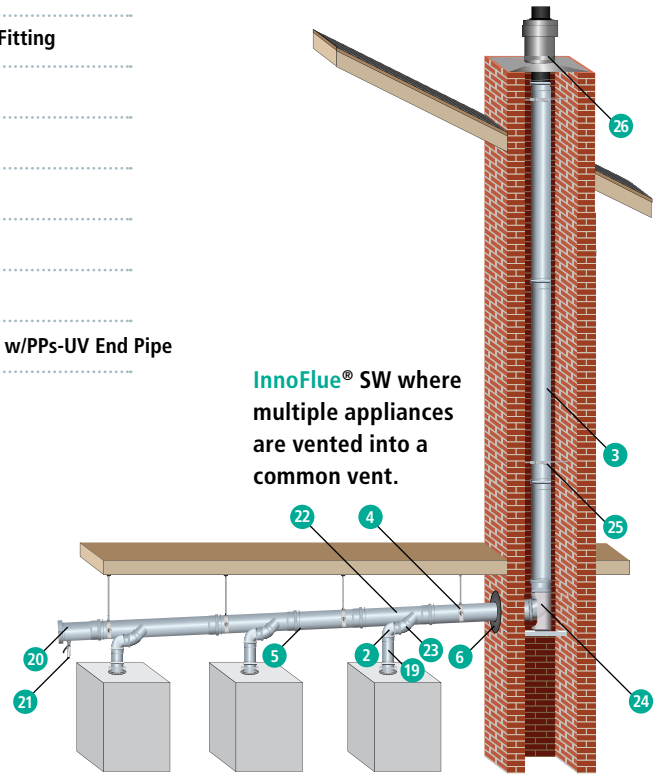

SW  
Commercial

## Appliance Adaptors

Commercial appliance adaptors are made to order. Adaptors can be manufactured to fit any appliance. Call Centrotherm or visit <http://centrotherm.us.com> for a complete list of approved appliances.

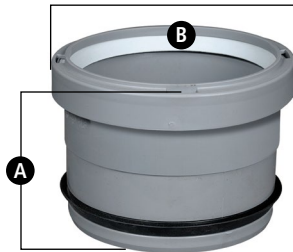

### Commercial Appliance Adaptor for Coupler Style Flue Collar

Adapts a female PVC / CPVC coupler or appliance flue exhaust to InnoFlue® SW diameters.

Nominal Diameter PVC to PP	Part #	Overall Length "A"	Max O.D. "B"
6"/6" (168/160)	ISAGL0606	7.6 (194)	7.0 (178)

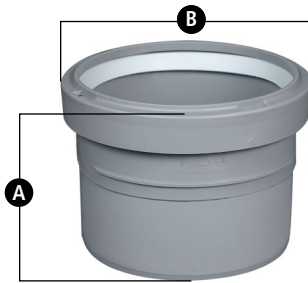

### Commercial Appliance Adaptor for Flue Collar with Hose Clamp

Adapts a female PVC / CPVC diameter appliance flue exhaust (with integrated gasket) to InnoFlue® SW diameters.

Nominal Diameter PVC to PP	Part #	Overall Length "A"	Max O.D. "B"
6"/6" (168/160)	ISAAL0606	7.6 (194)	7.0 (178)

Commercial SW

### Commercial Appliance Adaptor w/ Condensate Drain and Vibration Isolation Boot OEM to InnoFlue®

Adapts boilers to InnoFlue®. Other increasing size combinations available upon request.

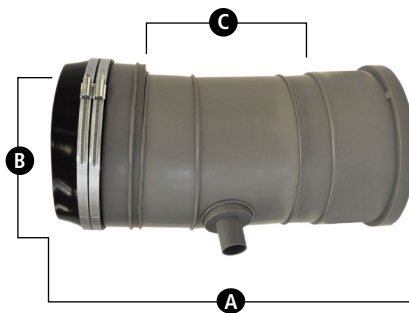

Nominal Diameter	Part #	Overall Length "A"	Maximum OD "B"	Effective Length "C"
4" (110)	ISAACD0404	10.3 (262)	5.9 (150)	3.4 (86)
5" (125)	ISAACD0505	13.6 (345)	6.5 (165)	8.5 (216)
6" (160)	ISAACD0606	12.0 (305)	7.9 (201)	5.4 (137)
7" (180) to 8" (200)	ISAACD0708	16.5 (419)	9.5 (241)	9.7 (246)
8" (200)	ISAACD0808	16.5 (419)	9.5 (241)	9.7 (246)
9" (230) to 10" (250)	ISAACD0910	16.9 (429)	11.4 (290)	10.0 (254)
10" (250)	ISAACD1010	16.9 (429)	11.4 (290)	10.0 (254)
12" (315)	ISAACD1212	23.3 (542)	14.7 (373)	7.6 (191)

**Commercial Appliance Adaptor OEM to InnoFlue®**

Adapts InnoFlue® with bolt down flanged adaptor. Available for purchase through Centrotherm.

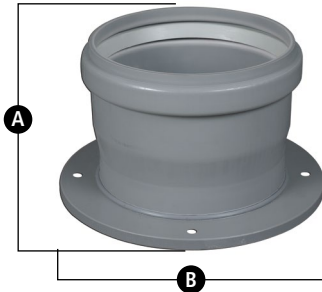

Nominal Diameter	Part #	Overall Length "A"	Maximum OD "B"
3" (80)	ISAF03	3.7 (94)	8.8 (224)
4" (110)	ISAF04	4.7 (119)	8.8 (224)
6" (160)	ISAF06	4.3 (109)	8.8 (224)
8" (200)	ISAF08	6.2 (158)	11.3 (287)
10" (250)	ISAF10	6.2 (157)	15.0 (381)
12" (315)	ISAF12	13.2 (335)	15.0 (381)

**Commercial Appliance Adaptor OEM to InnoFlue®**

Adapts boilers to InnoFlue®.

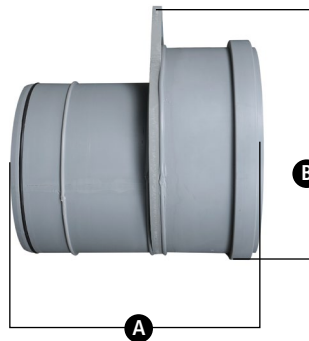

Nominal Diameter	Part #	Overall Length "A"	Max O.D. "B"
7" (180) to 8" (200)	ISAF0708	9.0 (229)	8.8 (224)
8" (200)	ISAF0808	8.0 (204)	8.8 (224)
10" (250)	ISAF1010	8.0 (204)	10.8 (27)

**Commercial Appliance Adaptor SS to InnoFlue®**

Adapts stainless steel flue outlets to InnoFlue®. May require Vibration Isolation Boot.

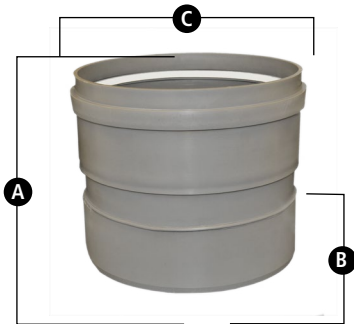

Nominal Diameter SS to PP	Part #	Overall Length "A"	Effective Length "B"	Max O.D. "C"
6"/6" (152/160)	ISSA0606	7.3 (185)	4.2 (107)	7.8 (183)
7" (180) to 8" (200)	ISSA0708	8.7 (221)	6.1 (155)	8.8 (224)
8"/8" 203/200)	ISSA0808	8.9 (226)	5.0 (127)	8.8 (224)
10"/10" (254/250)	ISSA1010	8.9 (226)	5.0 (127)	10.7 (272)
12"/12" (305/315)	ISSA1212	16.9 (429)	4.2 (107)	13.8 (350)

## Vibration Isolation Boot with Clamps

High temperature silicone boot seals InnoFlue® SW Vent Lengths and Fittings to appliance flue outlet.



Nominal Diameter PVC to PP	Part #	Width	I.D
6" (160)	ISVIB06	2.4 (60)	6.3 (160)
8" (200)	ISVIB08	2.4 (60)	7.9 (200)
10" (250)	ISVIB10	2.4 (60)	9.8 (250)
12" (315)	ISVIB12	2.4 (60)	12.4 (315)

## Custom Appliance Adaptors Available

Appliance Adaptors are built to order. Contact your sales representative for pricing and availability. <http://www.centrotherm.us.com/rep-finder/>

## Increasesers & Reducers

Commercial SW

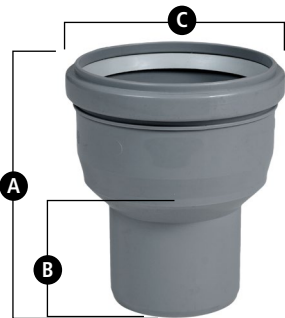

### Centric In increaser

Transitions vent system to a larger diameter. Install in vertical orientation only. Additional configurations available upon request.

Nominal Diameter	Part #	Overall Length "A"	Effective Length "B"	Max O.D. "C"
4"/6" (110/160)	ISIA0406	7.6 (193)	4.8 (122)	7.2 (183)
5"/6" (125/160)	ISIA0506	7.2 (185)	4.3 (110)	7.2 (185)
6"/6" (150/160)	ISIA15006	7.7 (196)	4.9 (124)	7.2 (183)
6"/8" (160/200)	ISIA0608	10.4 (265)	6.5 (165)	8.8 (224)
6"/12" (160/315)	ISIA0612	18.1 (460)	5.4 (137)	13.8 (351)
8"/10" (200/250)	ISIA0810	11.6 (295)	7.7 (195)	10.7 (272)
10"/12" (250/315)	ISIA1012	18.2 (463)	5.5 (141)	13.8 (350)
300mm/12" (300/315)	ISIA30012			

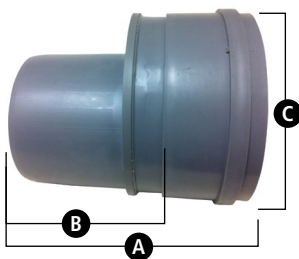

### Eccentric In increaser

Transitions vent system to a larger diameter. Install in horizontal or vertical orientation. Other size combinations available upon request.

Nominal Diameter	Part #	Overall Length "A"	Effective Length "B"	Max O.D. "C"
4"/6" (110/160)	ISEI0406	9.2 (234)	6.4 (163)	7.2 (183)
5"/6" (125/160)	ISEI0506	7.2 (185)	4.3 (108)	7.2 (183)
6"/8" (160/200)	ISEI0608	10.4 (265)	6.5 (165)	8.8 (224)
6"/12" (160/315)	ISEI0612	18.1 (460)	5.4 (137)	13.8 (350)
8"/10" (200/250)	ISEI0810	11.8 (300)	7.8 (200)	10.7 (272)
8"/12" (200/315)	ISEI0812	16.9 (429)	4.2 (107)	13.8 (350)
10"/12" (250/315)	ISEI1012	20.2 (514)	7.8 (200)	13.8 (350)

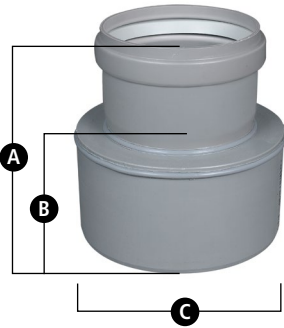

### Reducer

Transitions vent system to a smaller diameter.

Nominal Diameter	Part #	Overall Length "A"	Effective Length "B"	Max O.D. "C"
8"/6" (200/160)	ISRD0806	8.0 (204)	5.2 (133)	7.9 (201)
10"/8" (250/200)	ISRD1008	9.2 (234)	5.2 (133)	9.9 (252)
12"/10" (315/250)	ISRD1210	17.9 (455)	14.0 (356)	12.5 (318)

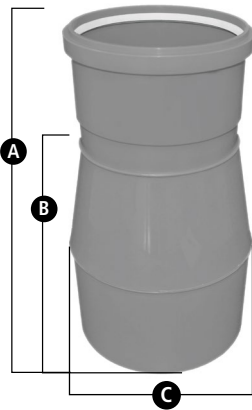

### Tapered Reducer

Transitions vent system to a smaller diameter with minimal back pressure. Other sizes available. Please contact Centrotherm.

Nominal Diameter	Part #	Overall Length "A"	Effective Length "B"	Max O.D. "C"
8"/6" (200/160)	ISTR0806	13.5 (343)	10.7 (272)	7.9 (200)
10"/6" (250/160)	ISTR1006	18.5 (409)	16.3 (414)	9.9 (250)
10"/8" (250/200)	ISTR1008	16.6 (422)	12.6 (320)	9.9 (250)

### Test Ports

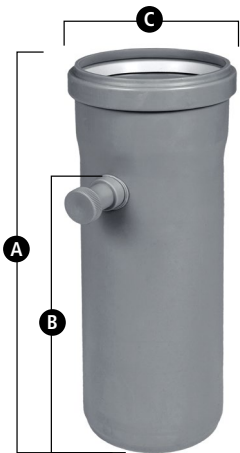

### Test Port

Installed immediately above the appliance, the test port allows plumbing and heating professionals to sample flue gases and ensure the appliance is operating at optimum efficiency.

Nominal Diameter	Part #	Overall Length "A"	Effective Length "B"	Max O.D. "C"
6" (160)	ISTP06	12.7 (323)	9.8 (250)	7.2 (183)
8" (200)	ISTP08	15.9 (405)	12.0 (305)	8.8 (224)
10" (250)	ISTP10	15.9 (405)	12.0 (305)	10.7 (272)
12" (315)	ISTP12	36.7 (932)	24 (610)	13.8 (350)

## Vent Lengths

### Rigid Vent Length

Rigid polypropylene vent lengths with dedicated male and female ends. Female ends contain internal gasket and male ends can be field cut and chamfered to desired length.

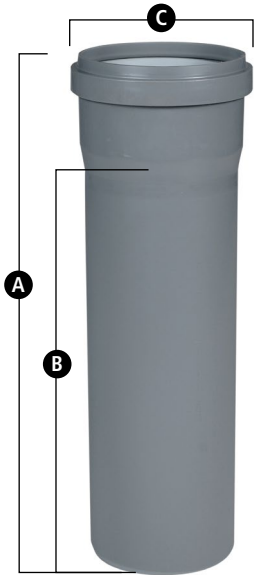

**Now in 10 foot effective lengths!**

Nominal Diameter	Part #	Overall Length "A"	Effective Length "B"	Max O.D. "C"
6" (160)	ISVL061	15.5 (345)	12 (305)	7.2 (183)
6" (160)	ISVL062	27.5 (700)	24 (610)	7.2 (183)
6" (160)	ISVL063	39.5 (1004)	36 (914)	7.2 (183)
6" (160)	ISVL066	75.5 (1919)	72 (1829)	7.2 (183)
6" (160)	ISVL0610	124.25 (3162)	120 (3048)	7.2 (183)
8" (200)	ISVL081	16.2 (412)	12 (305)	8.8 (224)
8" (200)	ISVL082	28.2 (716)	24 (610)	8.8 (224)
8" (200)	ISVL083	40.2 (1021)	36 (914)	8.8 (224)
8" (200)	ISVL086	76.2 (1935)	72 (1829)	8.8 (224)
8" (200)	ISVL0810	124.5 (3162)	120 (3048)	8.8 (224)
10" (250)	ISVL101	16.1 (410)	12 (305)	10.7 (272)
10" (250)	ISVL102	28.1 (715)	24 (610)	10.7 (272)
10" (250)	ISVL103	40.1 (1019)	36 (914)	10.7 (272)
10" (250)	ISVL106	76.1 (1934)	72 (1829)	10.7 (272)
12" (315)	ISVL122	36.7 (932)	24 (610)	13.8 (350)
12" (315)	ISVL123	48.7 (1236)	36 (914)	13.8 (350)
12" (315)	ISVL126	84.7 (2151)	72 (1829)	13.8 (350)

Commercial SW

## Elbows



### 15° Elbow

Segmented Elbows offset or change the direction of the vent system.

Nominal Diameter	Part #	Centerline Offset "A"	Effective Length "B"	Max O.D. "C"
6" (160)	ISEL0615	1.0 (25)	5.1 (130)	7.2 (183)
8" (200)	ISEL0815	1.8 (46)	9.8 (249)	8.8 (224)
10" (250)	ISEL1015	1.9 (48)	10.6 (269)	10.7 (272)
12" (315)	ISEL1215	4.4 (112)	18.7 (475)	13.8 (350)

### 30° Elbow

Segmented elbow for offsets or changes in the direction of the vent system. Commonly used to provide offsets in cascade configurations.

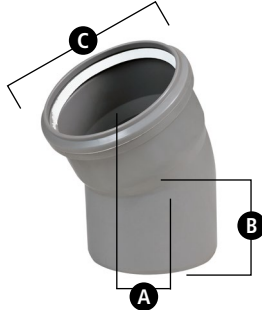

Nominal Diameter	Part #	Centerline Offset "A"	Effective Length "B"	Max O.D. "C"
6" (160)	ISEL0630	2.1 (53)	5.8 (147)	7.2 (183)
8" (200)	ISEL0830	4.1 (104)	11.5 (292)	8.8 (224)
10" (250)	ISEL1030	4.3 (109)	12.6 (320)	10.7 (272)
12" (315)	ISEL1230	9.3 (21.4)	21.4 (544)	13.8 (350)

### 45° Elbow

For offsets or changes in the direction of the vent system.

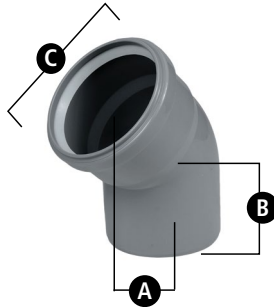

Nominal Diameter	Part #	Centerline Offset "A"	Effective Length "B"	Max O.D. "C"
6" (160)	ISEL0645	3.2 (81)	5.5 (138)	7.2 (183)
8" (200)	ISEL0845	3.8 (96)	13.1 (332)	8.8 (224)
10" (250)	ISEL1045	4.1 (105)	14.3 (364)	10.7 (272)
12" (315)	ISEL1245	5.5 (139)	23.6 (599)	13.8 (350)

### 87° Elbow

For offsets or changes in the direction of the vent system.

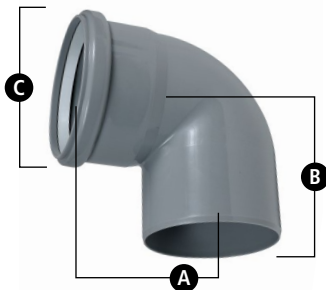

Nominal Diameter	Part #	Centerline Offset "A"	Effective Length "B"	Max O.D. "C"
6" (160)	ISEL0687	3.4 (86)	6.3 (160)	7.2 (183)
8" (200)	ISEL0887	9.5 (242)	14.0 (355)	8.8 (224)
10" (250)	ISEL1087	11.3 (287)	15.7 (399)	10.7 (272)
12" (315)	ISEL1287	14.3 (364)	25.7 (653)	13.8 (350)

### Base Support

Supports vertical sections of rigid (up to 164') vent lengths installed in chimneys and chases.

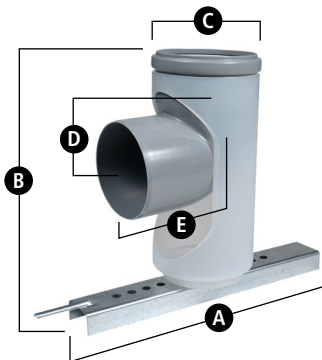

Nominal Diameter	Part #	Base Length "A"	Height "B"	Max O.D. "C"	Effective "D"	Effective "E"
6" (160)	ISBS0687	15.8 (400)	13.2 (335)	7.2 (183)	3.7 (93)	6.1 (156)
8" (200)	ISBS0887	15.8 (400)	22.7 (577)	8.8 (224)	10.2 (260)	13.5 (342)
10" (250)	ISBS1087	27.6 (700)	29.5 (750)	10.7 (272)	12.1 (307)	15.1 (383)
12" (315)	ISBS1287	27.6 (700)	46.9 (1191)	13.8 (350)	15.7 (398)	24.9 (633)



## Branch Tees

42° Y allows for the cascading or common venting of appliances. Other size configuration available upon request.

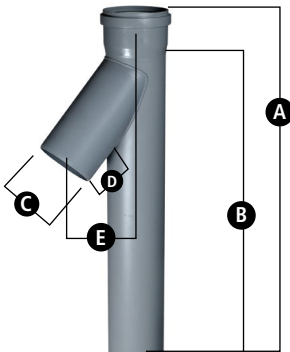

Nominal Diameter	Part #	Overall Length "A"	Effective Length "B"	Feeder Diameter "C"	Feeder Length "D"	Offset "E"
3" (80)	ISBT030236	40.4 (1026)	36 (914)	2" (60)	6 (152)	6.5 (165)
4" (100)	ISBT040236	38.8 (986)	36 (914)	2" (60)	6 (152)	7.3 (185)
4" (100)	ISBT040336	38.8 (986)	36 (914)	3" (80)	6 (152)	7.5 (191)
5" (125)	ISBT050236	39.1 (993)	36 (914)	2" (60)	6 (152)	7.6 (193)
5" (125)	ISBT050336	39.1 (993)	36 (914)	3" (80)	6 (152)	7.9 (201)
5" (125)	ISBT050436	39.1 (993)	36 (914)	4" (100)	6 (152)	8.3 (211)
6" (160)	ISBT060236	40 (1016)	36 (914)	2" (60)	6 (152)	8.3 (211)
6" (160)	ISBT060336	40 (1016)	36 (914)	3" (80)	6 (152)	8.6 (218)
6" (160)	ISBT060436	40 (1016)	36 (914)	4" (100)	6 (152)	9 (229)
6" (160)	ISBT060536	40 (1016)	36 (914)	5" (125)	6 (152)	9.2 (234)
8" (200)	ISBT080236	40 (1016)	36 (914)	2" (60)	6 (152)	9.1 (231)
8" (200)	ISBT080336	40 (1016)	36 (914)	3" (80)	6 (152)	9.4 (239)
8" (200)	ISBT080436	40 (1016)	36 (914)	4" (100)	6 (152)	9.8 (249)
8" (200)	ISBT080536	40 (1016)	36 (914)	5" (125)	6 (152)	10 (254)
8" (200)	ISBT080636	40 (1016)	36 (914)	6" (160)	6 (152)	10.6 (269)
10" (250)	ISBT100236	39.9 (1013)	36 (914)	2" (60)	6 (152)	10.1 (257)
10" (250)	ISBT100336	39.9 (1013)	36 (914)	3" (80)	6 (152)	10.3 (262)
10" (250)	ISBT100436	39.9 (1013)	36 (914)	4" (100)	6 (152)	10.8 (274)
10" (250)	ISBT100536	39.9 (1013)	36 (914)	5" (125)	6 (152)	11 (279)
10" (250)	ISBT100636	39.9 (1013)	36 (914)	6" (160)	6 (152)	11.7 (297)
10" (250)	ISBT100836	39.9 (1013)	36 (914)	8" (200)	6 (152)	12.1 (307)
12" (315)	ISBT120236	49 (1245)	36 (914)	2" (60)	6 (152)	11.1 (282)
12" (315)	ISBT120336	49 (1245)	36 (914)	3" (80)	6 (152)	11.3 (287)
12" (315)	ISBT120436	49 (1245)	36 (914)	4" (100)	6 (152)	11.7 (297)
12" (315)	ISBT120536	49 (1245)	36 (914)	5" (125)	6 (152)	11.8 (300)
12" (315)	ISBT120636	49 (1245)	36 (914)	6" (160)	6 (152)	12.2 (310)
12" (315)	ISBT120836	49 (1245)	36 (914)	8" (200)	6 (152)	12.6 (320)
12" (315)	ISBT121036	49 (1245)	36 (914)	10" (250)	6 (152)	13.1 (333)

## Custom Branch Tees

Branch Tees can be made to order using a variety of diameter manifolds and feeders.

## Cascade Component Kits

Available in various sizes and configurations. Contact your sales representative for more information.



**Pictured:**  
**Back to Back Common Vent Kit**

## Condensate Management

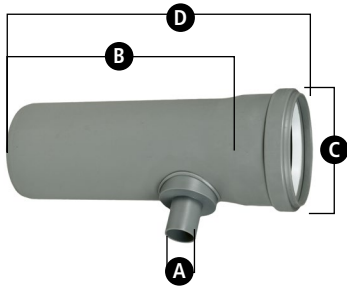

### Horizontal Drain Tee

Use to drain condensate from the vent system. Install in horizontal section closest to appliance. 1.26" (32mm) O.D. drain. Use with any InnoFlue® Siphon.

Nominal Diameter	Part #	Drain O.D. "A"	Effective Length "B"	Max O.D. "C"	Overall Length "D"
2" (60)	ISHDT02	1.3 (32)	7.3 (186)	3 (76)	9.8 (250)
3" (80)	ISHDT03	1.3 (32)	7.3 (186)	3.7 (94)	9.8 (250)
4" (110)	ISHDT04	1.3 (32)	9.8 (250)	4.1 (129)	12.4 (315)
5" (125)	ISHDT05	1.3 (32)	9.8 (250)	5.8 (146)	12.4 (315)
6" (160)	ISHDT06	1.3 (32)	9.8 (250)	7.2 (183)	12.4 (315)
8" (200)	ISHDT08	1.3 (32)	12.0 (305)	8.8 (224)	16.0 (405)
10" (250)	ISHDT10	1.3 (32)	12.0 (305)	10.7 (272)	16.0 (405)
12" (315)	ISHDT12	1.3 (32)	24.0 (1610)	13.8 (350)	36.7 (1932)

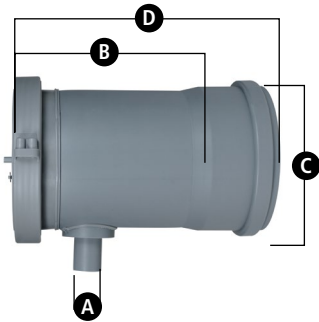

### Horizontal Drain Fitting

Use with any InnoFlue® siphon. Placed at the end of the last Branch Tee in a cascade configuration, the Horizontal Drain Fitting removes condensate from the system and allows for inspections and system clean out. 32mm O.D. drain.

Nominal Diameter	Part #	Drain O.D. "A"	Effective Length "B"	Max O.D. "C"	Overall Length "D"
4" (110)	ISHDF04	1.3 (32)	7.2 (182)	5.1 (129)	9.7
5" (125)	ISHDF05	1.3 (32)	7.4 (187)	5.8 (146)	11.3
6" (160)	ISHDF06	1.3 (32)	8.1 (209)	7.2 (183)	12.1
8" (200)	ISHDF08	1.3 (32)	8.5 (215)	8.8 (224)	12.7
10" (250)	ISHDF10	1.3 (32)	13.8 (350)	10.7 (272)	18.0
12" (315)	ISHDF12	1.3 (32)	6.3 (160)	13.8 (350)	19.0

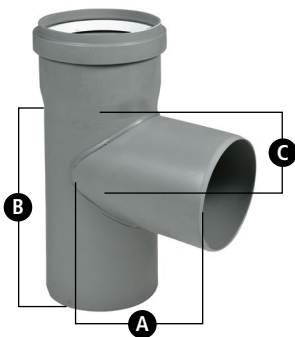

### Tee

Use to change the direction of the vent system, combine multiple appliances, and capture condensates at base of long vertical runs.

Nominal Diameter	Part #	Effective Length "A"	Effective Length "B"	Effective Length "C"
6" (160)	IST06	6.6 (168)	11.2 (284)	4.1 (105)
8" (200)	IST08	8.5 (215)	15.2 (387)	6.5 (165)
10" (250)	IST10	16.5 (419)	16.5 (420)	7.0 (179)
12" (315)	IST12	19.7 (500)	28.7 (728)	7.5 (189.5)



### Tee Cap

Seals non-utilized tees and branch tees.

Nominal Diameter	Part #	Max O.D. "A"
6" (160)	ISTC06	7.3 (185)
8" (200)	ISTC08	8.8 (224)
10" (250)	ISTC10	10.7 (272)
12" (315)	ISTC12	13.8 (350)

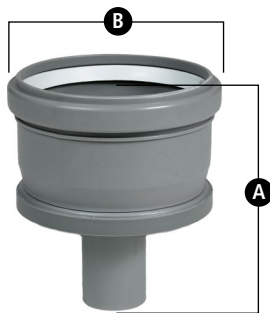

### Tee Cap with Drain

Use with any InnoFlue® siphon to drain condensate from the vent system.

Nominal Diameter	Part #	Overall Length "A"	Max O.D. "B"
6" (160)	ISTCD06	6.9 (175)	7.2 (185)
8" (200)	ISTCD08	8.9 (225)	8.8 (224)
10" (250)	ISTCD10	8.9 (225)	10.7 (273)
12" (315)	ISTCD12	16.0 (407)	13.8 (351)

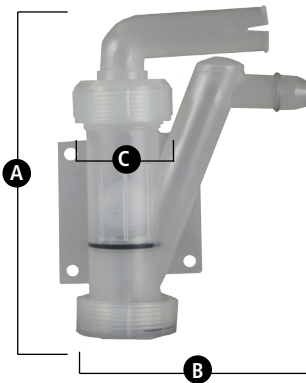

### Universal Ball Valve Siphon

Attaches to any InnoFlue® drain. Allows condensates to flow while unique ball valve assures combustion gases remain contained at higher temperatures. Comes with and can be installed with a barbed or compression fitting. See configuration options below.

Part #	Overall Height "A"	Overall Length "B"	Overall Width "C"
IASJBVS	6.5	4.5	1.9

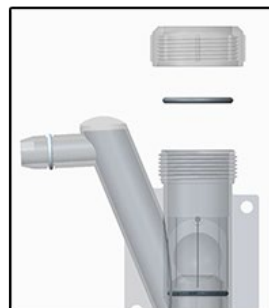

Standard



Barbed



NRV

SW Commercial

## Terminations

**NOTE: Roof Flashings Require a 10 Day Lead Time**

### Pitched Roof Flashing

With field supplied sealant, stainless steel flashing creates water-tight roof penetration when using InnoFlue commercial on a pitched roof.

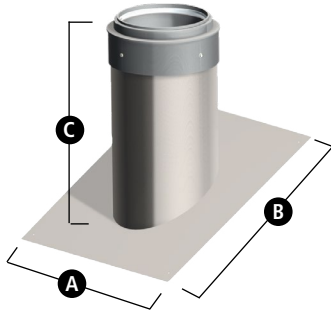

Nominal Diameter	Part #	Length "A"	Width "B"	Height "C"
6"	IAPRF06	18"	*	*
8"	IAPRF08	20"	*	*
10"	IAPRF10	22"	*	*
12"	IAPRF12	24"	*	*

**\*Dimensions vary based on pitch.**

**INDICATE REQUIRED PITCH AT TIME OF ORDER**

### Flat Roof Flashing

With field supplied sealant, stainless steel flashing creates water-tight roof penetration when using InnoFlue commercial on a flat roof.

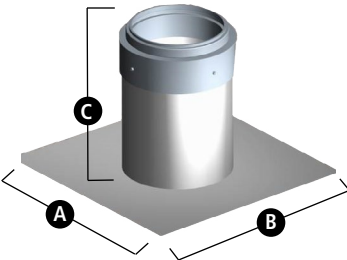

Nominal Diameter	Part #	Length "A"	Width "B"	Height "C"
6"	IAFRF06	18"	18"	13.3"
8"	IAFRF08	20"	20"	13.3"
10"	IAFRF10	22"	22"	13.8"
12"	IAFRF12	24"	24"	14.3"

### Chimney Cover SS with PPs-Gray End Pipe

Stainless steel termination with polypropylene end pipe seals top of the chimney or chase.

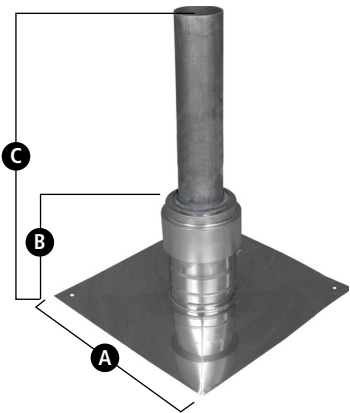

Nominal Diameter	Part #	Length "A"	Width "B"	Height "C"
6"	ISCM06	15.8	15.9	16.7
8"	ISCM08	19.7	19.7	19.7
10"	ISCM10	20	20	20
12"	ISCM12	20	20	39.4

Commercial  
SW

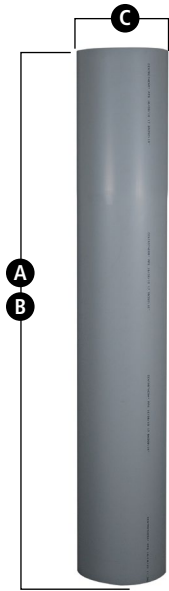

### End Pipe PPs-Gray

PPs End Pipes allow for termination of the vent system through the wall or roof.

Nominal Diameter	Part #	Overall Length "A"	Effective Length "B"	Max O.D. "C"
6" (160)	ISEP0620	20 (508)	20 (508)	6 (160)
6" (160)	ISEP0639	39 (991)	39 (991)	6 (160)
8" (200)	ISEP086	70 (1778)	70 (1778)	8 (200)
10" (250)	ISEP106	70 (1778)	70 (1778)	10 (250)
12" (315)	ISEP126	72 (1829)	72 (1829)	12 (315)

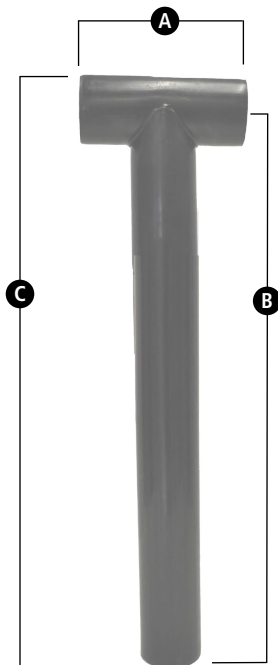

### Termination Tee (long)

Made from black polypropylene. Use where termination is exposed to excessive sunlight, wind or prone to freeze ups.

Nominal Diameter	Part #	Length "A"	Width "B"	Height "C"
6"	ISTT0620	9	6.5	30.8
8"	ISTT0820	16	7.9	32
10"	ISTT1020	20.5	9.9	32.3
12"	ISTT1220	22	12.4	41.5

## Velocity Cone

Made to order. Call for more information.



Nominal Diameter	Part #
3" to 2"	ISVC0302
4" to 3"	ISVC0403
5" to 4"	ISVC0504
6" to 4"	ISVC0604
6" to 5"	ISCV0605
8" to 6"	ISVC0806
10" to 6"	ISVC1006
10" to 8"	ISVC1008

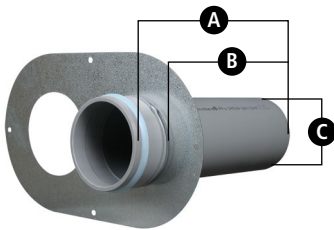

## PPs to PVC Termination Kit

Adapts PPs to PVC Twin Pipe Termination. Comes with replacement wall plate and termination adaptor.

Nominal Diameter	Part #	Overall Length "A"	Effective Length "B"	End O.D. "C"
6" (160)	ISLTK06	14.4 (366)	11.0 (280)	6.5 (166)

## Bird Screen PPs-UV

Fits inside InnoFlue® SW end pipes at terminations.



Nominal Diameter	Part #
6" (160)	IASPP06

## Bird Screen SS

Fits inside InnoFlue® SW end pipes at terminations.



Nominal Diameter	Part #
8" (200)	IASSS08
10" (250)	IASSS10
12" (315)	IASSS12



## Spacers

### 6" Spacers

Self positioning spacers centers InnoFlue® SW in a chase/chimney/B-vent.

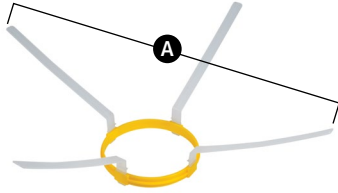

Nominal Diameter	Part #	Max Width "A"	Min Width
6" (160)	IASP06	25.0 (635)	7 (186)

### 8", 10" and 12" Spacers

Self positioning spacers centers InnoFlue® SW in a chase/chimney/B-vent.

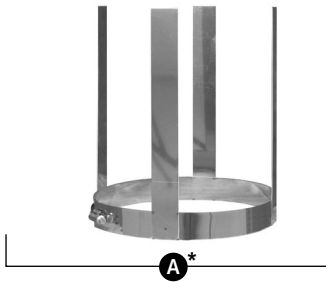

Nominal Diameter	Part #	Max Width "A"	Min Width
8" (200)	IASP08	27.6 (700)	9 (228)
10" (250)	IASP10	29.5 (750)	11 (276)
12" (315)	IASP12	32.1 (815)	13 (341)

\* When bent into place.

### Flue Clamp

Secures ISAG and ISAGL appliance adaptors to appliance flue exhaust.

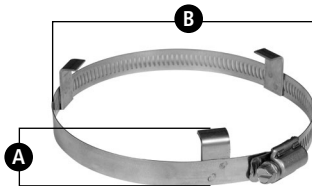

Nominal Diameter	Part #	Height "A"	Max. I.D. "B"
6" (160)	IAFC06	1.0 (26)	8.3 (211)

### Connector Ring

Provides reinforcement at joints to support loads of up to 99 lbs (45Kg). 6" through 12" connector rings are available but not required per UL 1738 and ULC-S636.

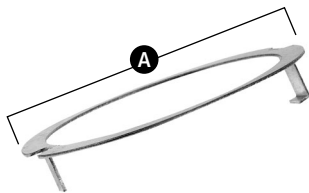

Nominal Diameter	Part #	O.D. "A"
6" (160)	IANS06	7.5 (191)
8" (200)	IANS08	9.4 (239)
10" (250)	IANS10	10.7 (271)
12" (315)	IANS12	14.9 (378.5)

SW Commercial



## Connector Double Hose Clamp

Connection clamps provide mechanical connection as required by O.E.M.

Nominal Diameter	Part #
5" (125)	IADHC0505
6" (160)	IADHC0606
8" (200)	IADHC0808
10" (250)	IADHC1010
12" (315)	IADHC1212

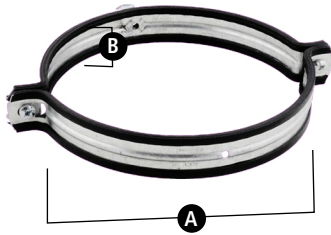

## Support Clamp

Used as vertical or horizontal support. Space 78" in vertical and 39" in horizontal installations. **Uses 3/8" threaded rod.**

Nominal Diameter	Part #	Overall Length "A"	Height "B"
6" (160)	IASCM06	6.8 (172.7)	1.1 (28)
8" (200)	IASCM08	8.4 (213.3)	1.1 (28)
10" (250)	IASCM10	10.3 (261.6)	1.1 (28)
12" (315)	IASCM12	12.8 (325.1)	1.1 (28)

## EPDM Gaskets

Standard gasket for 6" through 12" diameter InnoFlue® SW. Inserted into the female end of each part, the gaskets keep flue gases and condensates within the vent system.



Nominal Diameter	Part #
6" (160)	ISGE06
8" (200)	ISGE08
10" (250)	ISGE10
12" (315)	ISGE12

## Centrocerin

A water based lubricant used to ease the assembly of InnoFlue® SW & Flex. Sparingly applied to the gasket or male end.



Package Size	Part #
50 ml	IACE50



Centrotherm Eco Systems  
Albany, New York



Centrotherm Systemtechnik GmbH  
Brilon, Germany

## About Centrotherm

**For over 20 years**, the Ubbink-Centrotherm group of companies has manufactured the most comprehensive line of polypropylene flue gas systems in the industry including Single Wall, Flexible, and Concentric Vent solutions. In addition to our extensive range of standard vent products, Centrotherm is a full service manufacturer of appliance components for original equipment manufacturers. As the industry leader, Centrotherm is experienced in providing design services, prototyping, testing, and logistics management to its diverse sales channels.



Team up any high efficiency gas or oil fired appliance with InnoFlue<sup>®</sup> the superior performing, environmentally sustainable vent system with an established and solid track record of nearly two decades of field service.

Centrotherm Eco Systems is part of Centrotec Group, a publicly traded diversified manufacturer of sustainable industrial products.

*For more information about Centrotec Sustainable AG, visit [www.centrotec.de](http://www.centrotec.de)*

Part #ILC2017F



Centrotherm Eco Systems, LLC  
400 South Pearl Street  
Albany, NY 12202  
Toll Free: 877 434 3432  
Fax: 518 618 3166  
[info@centrotherm.us.com](mailto:info@centrotherm.us.com)  
[www.centrotherm.us.com](http://www.centrotherm.us.com)