



MODELS **201CRDTM**
& 301CRD
 Advanced Oil Burners
240 VAC

2.5 TO 5.5 GPH
& 3.0 TO 7.0 GPH

Instruction manual



Ratings

Input:	201CRD.....	2.50 to 5.00 GPH
	301CRD (3¼" air cone).....	3.00 to 6.00 GPH
	301CRD (3½" air cone).....	4.00 to 7.00 GPH
Fuels:	U.S.....	No. 1 or No. 2 Fuel oil
	Canada	No. 1 Stove oil or No. 2 Heating oil
Fuel unit:	Suntec
	100 to 150 PSIG nozzle pressure
	Factory set at 150 PSIG
Electrical:	Power	240V, 50/60 Hz, 1-Phase
	Motor.....	Carlin PSC, 1/4 HP, 3450 RPM
	Total current at 240V, 50/60 Hz, 1-Phase:	
	201CRD	Approx. 1.6 amps
	301CRD	Approx. 1.6 amps
Ignition:	Carlin Model 42000 electronic — 14,000 volts
Control:	U.L. primary safety control
Agencies:	UL Listed (US and Canada)

WARNING Installer/servicer — Except where specifically stated otherwise, this manual must be used only by a *qualified service technician*. Failure to comply with this or other requirements in this manual could result in severe personal injury, death or substantial property damage.

WARNING User — Refer only to User care and maintenance on back page for information regarding operation of this burner. The burner Instruction Manual is intended only for your service technician. The burner and heat exchanger must be inspected and started at least annually by your service technician.

© Copyright 2010 — Carlin Combustion Technology, Inc.

Carlin Combustion Technology, Inc.
 70 Maple Street East Longmeadow, MA 01028
 Ph 413-525-7700 Fx 413-525-8306



TECH SUPPORT 800-989-2275

carlincombustion.com

PLEASE read this first . . .

Contents

PLEASE read this first.....2

General information.....3

Codes and standards.....3

1. 201 & 301 Oil nozzles.....3

2. Prepare site • assemble burner • mount burner4

3. Prepare burner.....10

4. Wire burner • start burner –

 50240 primary control.....16

 60240 primary control.....18

5. Adjustment and verification.....20

6. Annual start-up and service21

7. Repair parts.....22

8. Maintenance/service procedures.....24

Warranty.....27

User care and maintenance..... Rear cover

Special attention flags . . .

Please pay particular attention to the following when you see them throughout this manual.

DANGER Notifies you of hazards that *WILL* cause severe personal injury, death or substantial property damage.

WARNING Notifies you of hazards that *CAN* cause severe personal injury, death or substantial property damage.

CAUTION Notifies you of hazards that *WILL or CAN* cause minor personal injury or property damage.

NOTICE Notifies you of special instructions on installation, operation or maintenance that are important, but are not normally related to injury or property damage hazards.

Before installing or servicing . . .

WARNING Should overheating occur:

- (1) Shut off the oil supply to the burner.
- (2) Do not shut off the control switch to the circulator or blower.

WARNING Follow the guidelines below to avoid potential severe personal injury, death or substantial property damage.

Installer/service technician . . .

- Read all instructions before proceeding. Perform all procedures, and in the order given to avoid potential of severe personal injury, death or substantial property damage.
- Before leaving the site after startup or service, review the *User care and maintenance* page with the user. Make the user aware of all potential hazards and perform the training outlined below.

Installer/service technician — Train the user . . .

- To properly operate the burner/appliance per this manual and the appliance instructions. See *User care and maintenance*.
- To keep this manual at or near the burner/appliance for ready access by the user and service technician.
- To contact the service technician or oil dealer if he encounters problems with the burner/appliance.
- To keep the appliance space free of flammable liquids or vapors and other combustible materials.
- To never use laundry products, paints, varnishes or other chemicals in the room occupied by the burner/appliance.
- To contact the service technician at least annually for startup and burner/appliance service.

When servicing the burner . . .

- Disconnect electrical supply to burner before attempting to service to avoid electrical shock or possible injury from moving parts.
- Burner and appliance components can be extremely hot. Allow all parts to cool before attempting to handle or service to avoid potential of severe burns.

General information

Burner applications

Follow all instructions in this manual, the primary control data sheet and the appliance manual.

Verify the burner is correct for the appliance being used and for all applicable codes/standards.

Damage or shortage claims

The consignee of the shipment must file damage or shortage claims immediately against the transportation company.

When calling or writing about the burner:

Please provide us with the UL serial number and burner model number to assist us in locating information. This information can be helpful when troubleshooting or obtaining replacement parts.

Codes and standards

Certification

201CRD and 301CRD burners are U.L. listed for the U.S. and Canada, certified to comply with ANSI/UL 296, for use with #1 or #2 heating oil (per standard ASTM D396).

Burner labels list compliance, when required, with special local, state or provincial approvals.

NOTICE Install this burner in accordance with all local codes and authorities having jurisdiction. Regulations of these authorities take precedence over the general instructions provided in this manual.

United States installations

Burner/appliance installations in the United States must comply with the latest editions of NFPA 31 (Standard for the Installation of Oil-Burning Equipment), ANSI/NFPA 70 (National Electrical Code), and all applicable local codes.

Canadian installations

Burner/appliance installations in Canada must comply with the latest editions of CSA B139 (Installation Code for Oil Burning Equipment), CSA standard C22, Part 1 (Canadian Electrical Code), and all applicable local codes.

1. 201 & 301 Oil nozzles

NOTICE Use the selections in Table 1 ONLY when heating appliance manufacturer specific nozzle selection data is not available, either in the appliance manual or the Carlin OEM Spec Guide. Follow all instructions provided with the appliance.

Table 1 Apply the guidelines below to select a nozzle when appliance-specific nozzle data is not available from the manufacturer or in the Carlin OEM Spec Guide. See notes at end of table for application tips.

201CRD Nozzle recommendations			
Firing rate, GPH	Brand	Spray	Angle / pattern
2.5 to 4.0	Delavan	Solid	60° B
	Hago	Semi-solid	45° SS
4.1 to 5.0	Delavan	Solid	45° B
	Hago	Semi-solid	45° SS

301CRD Nozzle recommendations			
Firing rate, GPH	Brand	Spray	Angle / pattern
3.0 to 5.0	Delavan	Solid	70° B
	Hago	Semi-solid	80° SS
5.1 to 6.0	Delavan	Solid	45° B
	Hago	Semi-solid	60° SS
	Hago	Hollow	60° H
6.1 to 7.0	Delavan	Solid	60° B
	Hago	Semi-solid	45° SS

- In general, all the nozzles shown above will burn well. However, in short combustion chambers, solid nozzles are not recommended because the flame may impinge on the back wall.
- If the nozzle selected for a retrofit application results in a smoky fire, you can sometimes determine the best nozzle to use by observing the flame. To do this, slowly cover the air band slots with your fingers while the burner is firing. The flame will begin to smoke in the area where there is more fuel than air. If the smoke begins on the outer edges, try a narrower or more solid nozzle spray pattern. If the flame begins to smoke at the tips, try a wider or more hollow nozzle spray pattern.
- For a packaged appliance application on which the burner has been tested, use the nozzle given in the appliance manufacturer's instructions or supplement for the best results.

NOTICE The fuel unit is factory-set at 150 psig. The nozzle selected must consider the fuel unit pressure. See nozzle sizing in Table 4, page 13.

2. Prepare site • assemble burner • mount burner

Vent system

General

WARNING

Do not install this burner unless you have verified the entire vent system and the appliance are in good condition and comply with all applicable codes.

- The vent and chimney must be sized and constructed in accordance with all applicable codes.
- Do not install or use an existing manual damper in the breeching (vent connector) or chimney.
- Do not connect the appliance vent connector to a chimney or vent serving a fireplace, incinerator or solid-fuel-burning apparatus.
- In a cold climate, do not vent into a masonry chimney that has one or more sides exposed to the outside. You must install a listed stainless steel liner in the chimney to vent the flue products.
- A defective vent system could result in severe personal injury, death or substantial property damage.

Prepare vent/chimney

- Secure all metal vent joints with screws, following the vent manufacturer's instructions.
- Seal all joints in the vent system and chimney.
- Repair masonry chimney lining and repair all mortar joints as needed.
- Install a double-acting barometric draft regulator in the vent piping if specified in the appliance manual. (The damper must be located in the same space as the appliance.)
- Provide support for the vent piping. Do not rest the weight of any of the vent piping on the appliance flue outlet.

Combustion and ventilation air openings

General

Check appliance manual and applicable codes for required sizing, design and placement of combustion/ventilation air openings. You can use the following general guidelines, taken from NFPA 31, provided they meet all local requirements.

Free area — Louvers and screens

- Air opening sizes are always given in free area. This means after deduction for louver obstruction. If you can't find the louver reduction for the grilles used, assume free area is 20% of total for wood louvers, or 60% of total for metal louvers.
- Screens can be no finer than ¼-inch mesh, and must be accessible for cleaning.

Residential installation air openings

Residential — Unconfined spaces (at least 7,000 cubic feet per GPH)

- An unconfined space means a room with at least 7,000 cubic feet volume for each GPH input (or 50 cubic feet per MBH) of all appliances in the room.
Example: For a boiler room housing a 6.00 GPH input burner/appliance, multiply 6 times 7,000 cubic feet, equals 42,000 cubic feet. The room must have a volume of 42,000 cubic feet to be classified as an unconfined space. (If the boiler room has an 8-foot ceiling height, the room would have to have 5,250 square feet, or about 73 feet square.)
- Most boiler rooms do not provide this much volume, and must be treated as confined spaces, requiring dedicated combustion air openings, sized as in the following.
- Open residential basements and crawl spaces are often large enough, and will generally allow enough air infiltration, so special provisions will seldom be required.
- If the building is tightly constructed, you will have to provide outside air openings into the building regardless of the boiler room volume. The total free area of these openings must be at least 1 square inch per 5,000 Btuh (28 square inches per GPH) of all appliances in the space.
- See Table 2 for a summary.

Residential — Confined spaces (less than 7,000 cubic feet per GPH)

- Air taken from inside building only —
 - Provide two openings — one near the floor, the other near the ceiling. Provide free area of 140 square inches per GPH input.
 - If the building is tightly constructed, provide dedicated air opening(s) into the building with at least 30 square inches free area per GPH.
- Air taken from outside —
 - Direct through outside wall or vertical ducts:
Provide two openings — one near the floor, the other near the ceiling. Provide free area of at least 35 square inches per GPH input.
 - Through horizontal ducts:
Provide two openings — one near the floor, the other near the ceiling. Provide free area of at least 70 square inches per GPH input.
- Ventilation air from inside, with combustion air from outside
 - Size openings to interior to provide 140 square inches free area per GPH input.
 - Size the outside combustion air duct to provide 28 square inches free area per GPH.
- See Table 2 for a summary.

Commercial installation air openings

Commercial — Air openings directly from outside to boiler room

- Provide one opening that provides a free area of at least 28 square inches per GPH input.
Example: For a boiler room housing boilers totalling 10 GPH fuel oil input, the area opening must have a free area of no less than 10 times 28, or 280 square inches. If the opening is wood louvered, divide by 20%, or the opening must be 1400 square inches (about 38 inches by 38 inches). If the opening is metal louvered, divide by 60%, or the opening must be 467 square inches (about 22 inches by 22 inches).

2. Prepare site • assemble burner • mount burner *(continued)*

Table 2 *Minimum combustion/ventilation air openings*

Source of air	Minimum free area of opening(s)	Total grill area, typical (sq. in.) for firing rates of:					
		3 GPH		5 GPH		7 GPH	
		Wood	Metai	Wood	Metai	Wood	Metai
Residential installations — Unconfined spaces (7,000 cu. ft. volume per GPH)							
From inside building, typical construction	No special openings required if natural infiltration is sufficient.						
From inside building, tight construction	1 or more grilles 30 Sq. in./ GPH	450	150	750	250	1050	350
Residential installations — Confined spaces							
From inside building through interior walls	2 openings, each 140 Sq. in./ GPH	2100	700	3500	1167	4900	1634
From outside building direct through outside wall	2 openings, each 35 Sq. In./ GPH	525	175	875	292	1225	409
From outside building through vertical ducts	2 openings, each 35 Sq. In./ GPH	525	175	875	292	1225	409
From outside building through horizontal ducts	2 openings, each 70 Sq. In./ GPH	1050	350	1750	583	2450	817
Ventilation through interior walls, with an opening to outside	2 Int. openings, each 140 Sq. In./ GPH 1 Exterior opening 28 Sq. In./ GPH	2100	700	3500	1167	4900	1634
		520	140	700	234	980	327
Commercial installations							
From outside building direct through adjacent outside wall	One opening through outside wall, providing free area of at least 28 Square inches per GPH input						
Other conditions	Size openings per local codes/jurisdictions						

Combustion/ventilation air checklist

- WARNING** The burner may operate successfully under momentary downdraft conditions, but sustained downdraft is unsafe.
- This can occur with an inadequate or incorrectly installed chimney/vent.
 - It can also occur in rooms/buildings equipped with exhaust fans or unsealed return air ducts.
 - Always check operation of the burner under all conditions to verify vent system operates correctly.
 - You may have to interlock the burner with exhaust fans to shut burner off when fan operates; or provide make-up air to the appliance room sufficient to prevent any negative pressure in the space.
 - Failure to correct downdraft or negative room pressure operation could result in severe personal injury, death or substantial property damage.

- Verify that openings are unobstructed.
- Verify that appliance space and air source spaces are free of:
 - Gasoline or other flammable liquids or vapors.
 - Combustible materials.
 - Air contaminants and chemicals, such as laundry products, paint, thinner, varnish, etc.
- Confirm with the building owner that the area will be kept free of these materials at all times and that air openings will be kept unobstructed.

Verify clearances

- Verify that the burner/appliance will maintain all required clearances:
- Verify clearance from combustible construction, as specified by appliance manufacturer and local codes.
 - Verify clearances for service and maintenance as required in the appliance manual and applicable codes.
 - Vent system components must maintain all necessary clearances to combustible construction, including the correct design of thimbles and insulation where penetrating combustible walls.

2. Prepare site • assemble burner • mount burner (continued)

Verify combustion chamber

Chamber dimensions and construction

- If retrofitting the burner to an appliance, install the burner in accordance with the appliance instruction manual, when available. If no specific application data is available from the appliance manufacturer, read the guidelines below to check whether the burner is likely to work acceptably in the application.
- Illustrations A to E in Figure 1 show different chamber configurations, with and without refractory linings. The chamber dimensions listed in Table 3 depend on whether the chamber is lined or water-backed, as shown.
- Do not attempt to fire the burner in a chamber with dimensions smaller than shown in Table 3 unless the application has been specifically tested and listed by the appliance manufacturer and/or Carlin.
- Chambers with dimensions larger than shown in Table 3 should not have much effect on combustion/performance.

General guidelines

- Clean all appliance flues and heating surfaces thoroughly, removing all soot and scale.
- Seal all joints and gaps using furnace cement to prevent excess air infiltration.

WARNING Read the WARNING on page 26 before handling or applying ceramic fiber materials.

Using chamber linings

- When using refractory liners or lightweight chambers, use insulating-type refractory rated 2600°F minimum, or as specified by the appliance manufacturer.
- You must install a target wall liner if flame length is close to the length of the chamber.
- Use a floor liner when possible. The floor liner will improve firing in most applications. Extend floor liner 3 to 4 inches up the side walls.
- Target wall liners — Extend target wall liners at least 3 to 4 inches above the center of the flame corbel the top 1½ to 2½ inches deep.
- Use preformed chamber liners when available. Lining the floor and target wall water-backed combustion chambers with lightweight insulating refractory will accomplish the same.
- When converting coal-fired units, install a combustion chamber in the ashpit area, or fill the ashpit with sand up to 2 inches above the “mud ring” of the boiler (firing through the door). Install a lightweight refractory liner on the target wall as in Figure 2D.

Figure 1 Combustion chamber configurations, typical

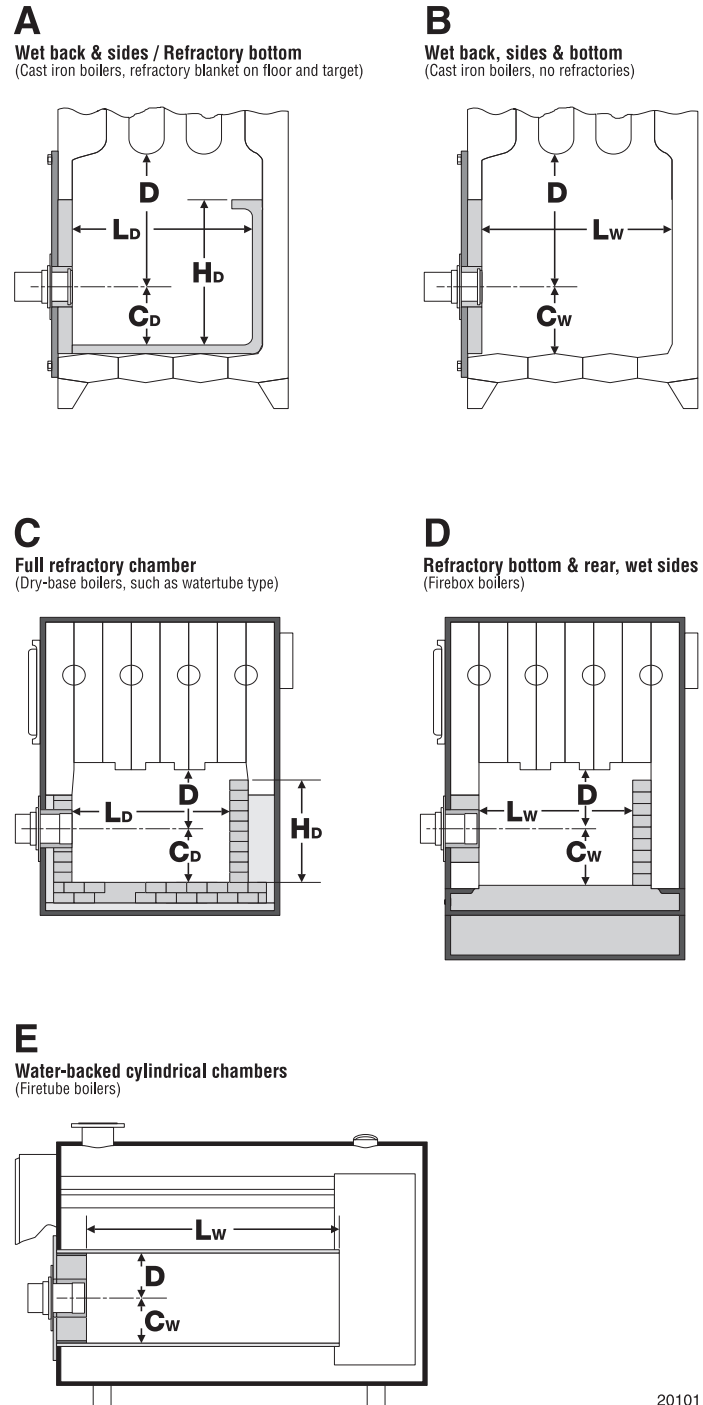

20101

2. Prepare site • assemble burner • mount burner *(continued)*

Table 3 201CRD and 301CRD Minimum combustion chamber dimensions (all dimensions in inches) - See Figure 1 for combustion chamber configurations

Firing rate GPH (Note 1, 2)	Cd	Cw	D	DV	Hd	Ld	Lw	W	W
	Burner center to floor	Burner center to floor	Burner ctr. to crown sheet	Vertical cylinder diam.	Target wall height	Chamber length	Chamber length	Chamber width	Chamber width
	Lined	Unlined		Lined		Lined	Unlined	Lined	Unlined
Notes			3	5	4				
201CRD									
2.50	6.0	6.0	7.0	15	12	17	21	12	14
3.00	6.0	6.0	7.5	17	13	20	24	13	15
3.50	6.5	6.5	8.0	20	14	23	27	14	16
4.00	6.5	6.5	8.0	22	14	25	30	14	16
4.50	7.0	7.0	8.5	24	15	27	32	15	17
5.00	7.5	7.5	8.5	26	15	29	35	15	17
5.50	8.0	8.0	9.0	28	16	31	37	16	18
301CRD with 3/4" air cone									
3.00	6.5	6.5	8.0	14	13	15	19	13	15
3.50	7.5	7.5	9.0	15	15	16	20	15	17
4.00	8.5	8.5	10.0	16	17	18	23	17	19
4.50	9.0	9.0	10.5	17	18	20	25	18	20
5.00	9.5	9.5	11.5	19	19	22	28	19	21
5.50	10.0	10.0	12.0	21	20	24	30	20	22
6.00	10.5	10.5	12.5	23	21	26	32	21	23
301CRD with 3/2" air cone									
4.00	7.5	7.5	9.0	15	15	16	21	15	17
4.50	7.5	7.5	9.0	16	15	18	23	15	17
5.00	8.5	8.5	10.0	21	17	24	30	17	19
5.50	8.5	8.5	10.5	29	17	32	38	17	19
6.00	8.5	8.5	10.5	34	17	37	43	17	19
6.50	9.0	9.0	11.0	35	18	39	45	18	20
7.00	9.0	9.0	11.0	36	18	40	46	18	20

NOTES

1. Some tested appliances operate well with dimensions other than shown below.
2. Generally, applications should be acceptable with dimensions larger than listed.
3. Horizontal cylinder chambers should have a diameter at least as large as the minimum width, **W**, listed. For steel cylinder chambers, increase this dimension by 1 to 4 inches.
4. Corbels can be beneficial to heat distribution in some applications. Wing walls are not recommended.
5. DV is the minimum diameter for vertical cylindrical chambers (refractory or refractory-lined chambers only).

2. Prepare site • assemble burner • mount burner *(continued)*

Inspect burner and components

General

- Check the air tube length. Verify the usable length of the tube UTL will be long enough (see “Mount burner in appliance”).
- Visually inspect all burner components and wiring.
- Verify that wiring is intact and leads are securely connected.
- Verify that all burner components are in good condition.

WARNING Do not install or operate the burner if any component is damaged or if burner does not comply with other guidelines of this manual and the appliance manual.

Install/check burner flange

Welded-flange burners

1. Verify the bolt pattern on the appliance chamber matches the flange pattern.
2. Verify the insertion depth (UTL) matches the depth of the appliance opening (so the end of the air tube is flush with, or slightly short of, the inside surface of the combustion chamber).

Burners with adjustable flanges

1. See Figure 2 for standard adjustable flange (universal flange) dimensions. See Figure 3 for adjustable forced draft flange dimensions. Verify the flange mounting slots line up with the appliance bolts.
2. Slip the adjustable flange onto the air tube.
3. Measure the distance from the inside of the combustion chamber to the outside of the appliance mounting plate.
4. Position the adjustable flange at this distance from the end of the air tube.
5. Tighten the locking screws finger tight.
6. Insert the air tube/flange assembly into the appliance opening and level the air tube with a spirit level (see Figure 4). Adjust flange if needed.
7. The end of the air tube should be flush, or almost flush, with the inside of the combustion chamber wall.
8. Verify the air tube is level and inserted the correct depth. Adjust if necessary. Then tighten the flange locking screws securely.
9. Remove the flange/air tube assembly from the opening.
10. Forced draft adjustable flanges: Use 1/4-inch diameter fiberglass sealing rope, as shown in Figure 3, to seal the flange to the air tube.

WARNING A forced draft adjustable flange must be sealed to the air tube to prevent possible leakage of flue products. Failure to comply could result in severe personal injury, death or substantial property damage.

Figure 2 Standard adjustable flange (universal flange)

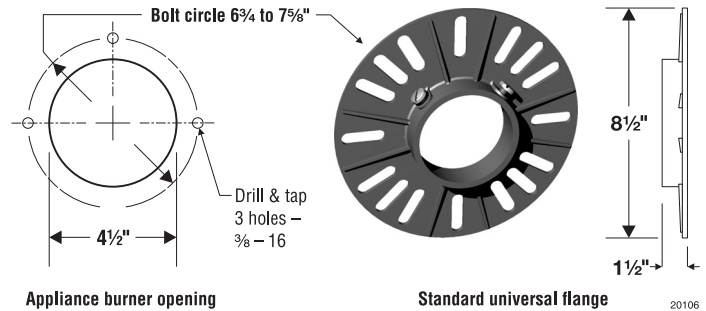

Figure 3 Adjustable forced draft flange

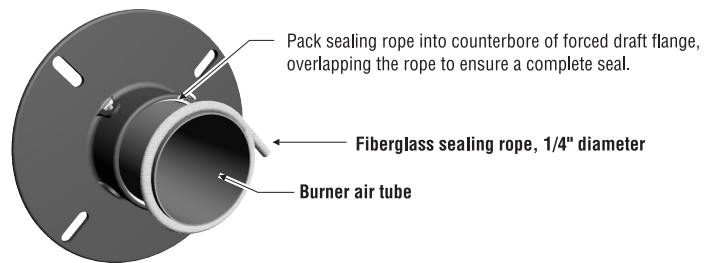
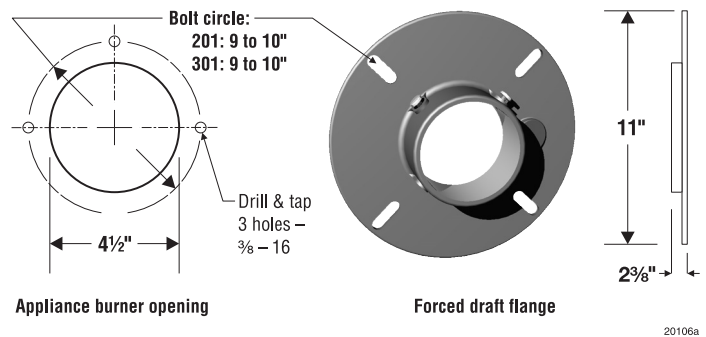
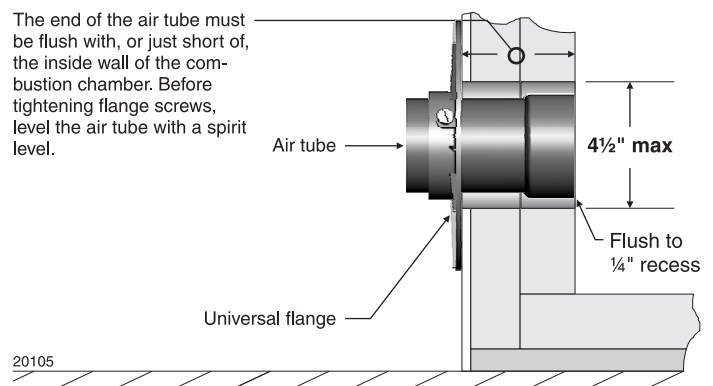

Figure 4 Mark insertion depth on air tube when using universal flange mounting



2. Prepare site • assemble burner • mount burner *(continued)*

Pedestal-mounted burners

1. Check the diameter of the appliance opening. If larger than 4½ inches, rebuild the opening so the open is reduced to 4½ inches maximum.
2. Insert the air tube into the appliance opening as in Figure 4. Do not attach air tube to housing yet.
3. Slide the tube in until the end of the tube is flush with, or up to ¼ inch short of, the inside of the combustion chamber.
4. Level the air tube using a spirit level.
5. Mark the air tube position with a pen or pencil around the circumference of the tube.
6. Remove air tube from the opening

Attach air tube to housing

1. See Figure 5. Loosen the four hex set screws on the top front of the burner chassis.
2. Open the ignitor cover plate by loosening the retainer screw on the left side of the burner housing.
3. Swing the ignitor plate open.
4. Locate the drip hole in the burner air cone (301 burners) or throttle ring (201 burners). Rotate the air tube so the drip hole is at the bottom.
5. Insert the air tube into the housing.
6. Make sure the air tube is inserted completely, butting against the air tube socket ledge. If necessary, tap on the end of the air tube with a block of wood until properly seated.
7. Secure the air tube by tightening the four hex set screws on the top front of the burner housing.

NOTICE On burners with welded flanges, you can bolt the air tube/flange to the appliance first — then attach the housing to air tube.

Figure 5 Attaching air tube to burner housing

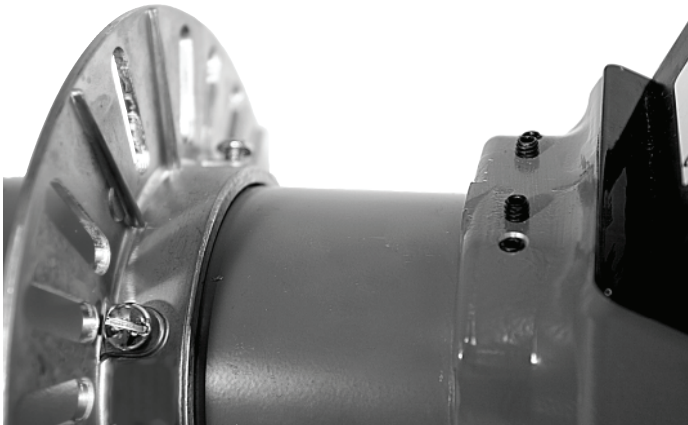

Mount burner in appliance

Welded flange-mounted burner

1. Place gasket over burner air tube and insert burner into appliance opening. Secure in place with hardware supplied with appliance.

WARNING Universal flange or pedestal mount — these insertion methods are intended only for negative overfire pressure. For pressurized firing, you must obtain a burner with a welded flange, designed for use with the specific appliance. Failure to comply could result in severe personal injury, death or substantial property damage.

Adjustable flange-mounted burner

1. Place gasket over burner air tube.
2. Insert burner into appliance.
3. Verify burner is seated level and straight. Adjust flange slightly if necessary.
4. Secure flange to appliance with hardware supplied with appliance.

Pedestal-mounted burner

1. Assemble the pedestal to the burner and tighten the bolt. Insert a screw into each of the two holes in the pedestal feet if needed to level the assembly.
2. Adjust the pedestal so the air tube is level and the center of the tube is at the same height as the center of the appliance opening.
3. Tighten the pedestal bolt.
4. Insert the burner/air tube into the appliance opening until pen/pencil line is even with appliance front (so end of air tube is flush with, or slightly short of, the inside of the chamber).
5. Seal the space around the air tube with furnace cement or equivalent (Figure 6).

Figure 6 Seal opening around burner air tube when pedestal mounting (burner shown with tube attached to housing and installed)

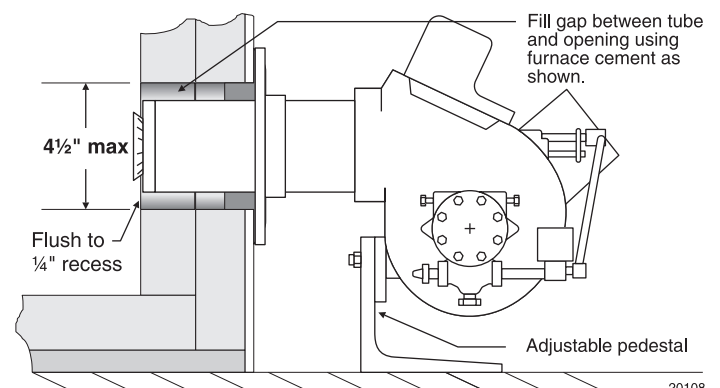

3. Prepare burner

Removing/installing head assembly

WARNING Use care when handling burner components after the burner has been firing. Components can be hot and could cause severe personal injury.

Removing the combustion head assembly

You will need to remove the combustion head assembly for inspection of the assembly, replacement of the oil nozzle or adjustment of electrodes. To remove the assembly:

1. Loosen the screw on the left side of the burner housing that secures the ignitor plate in place. Swing the ignitor plate open.
2. See Figure 7.
3. Unscrew the oil line fitting from the elbow at the end of the oil tube.
4. Remove the combustion head assembly by pulling the assembly up and out of the housing.
7. Handle the assembly with care to avoid bending or moving the electrodes, or damaging the electrode ceramic insulators.
8. Inspect the gasket on the bottom of the ignitor plate. The gasket prevents air from escaping from the housing. Replace the gasket if not in good condition.
9. Inspect the ignitor contact clips. Clean or replace if necessary to ensure reliable contact with the electrodes.

Replacing the combustion head assembly

To replace the combustion head assembly, reverse the sequence above.

- Make sure the oil line bracket seats into the slot on the adjusting screw.
- See Figure 8. You will have to lift the end of the assembly to guide it through the throttle ring or air cone at the end of the air tube. **DO NOT FORCE.**

CAUTION Use care when tightening the oil line fitting to oil tube extension. Tighten securely, but do not cross-thread or over-tighten.

Figure 7 Removing/inserting combustion head assembly

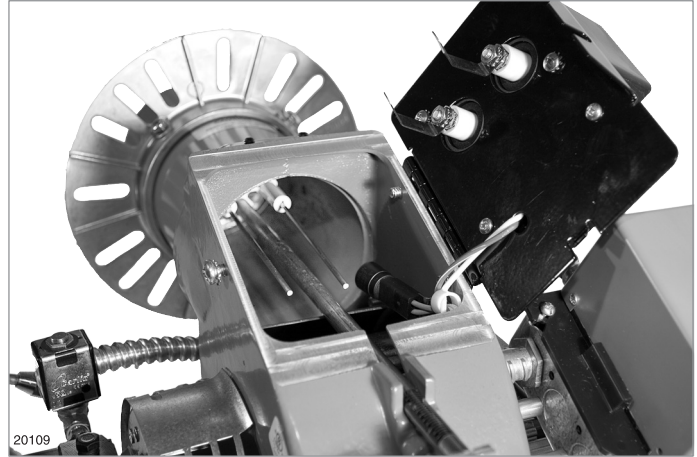
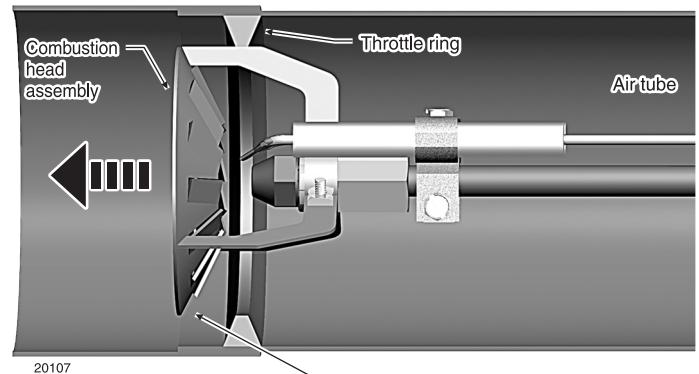
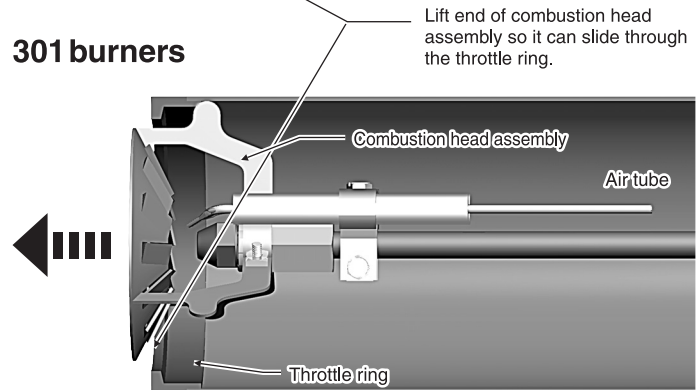

Figure 8 Inserting combustion head assembly

201 burners



301 burners



3. Prepare burner *(continued)*

Install nozzle/check electrodes

1. Loosen the clamp screw on the retention ring assembly (see Figure 9, step 1). Slide the retention ring assembly off of the nozzle adapter.
2. Install and tighten the nozzle listed in the appliance instruction manual or Carlin OEM Spec Guide.
3. If nozzle information is not available, begin with the nozzle listed in Table 1, page 3. (You may have to change the nozzle later if combustion results are not acceptable.)
3. Hold the nozzle adapter securely as shown in Figure 9, steps 2 and 4, when removing or replacing the nozzle. Take care not to damage the electrode insulators or to bend the electrodes in the process.

WARNING Inspect the nozzle adapter before replacing the nozzle. If the threads have been damaged or show score marks, replace the nozzle line/adapter assembly.

4. Install the retention ring assembly by slipping one of the riveted arms through the gap between the electrode tips. Align this arm straight up, with the ring clamp firmly against the nozzle adapter shoulder (see Figure 10). Then tighten the clamping screw.
5. Check the electrodes and reposition if necessary. Position the electrodes as shown in Figure 10. These settings are critical in ensuring a reliable ignition. Once the electrodes are set, check all clamps to be sure they are securely tightened.
6. Insert the combustion head/nozzle assembly into the burner.

Figure 9 Replacing the oil nozzle —
 1 – Remove retention ring from nozzle adapter
 2 – Support the assembly carefully and remove the nozzle using 5/8-inch and 3/4-inch open-end wrenches.
 3 – Insert and finger-tighten the new nozzle.
 4 – Support the assembly and tighten the nozzle using the open-end wrenches.
 NOTE: Do Not over tighten.

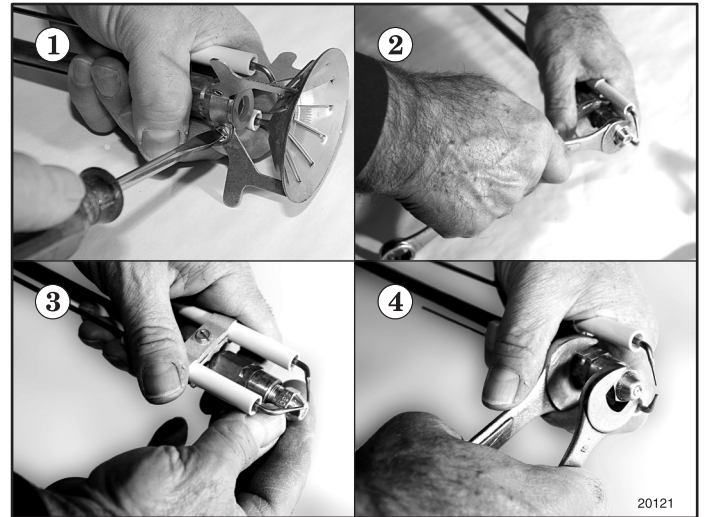
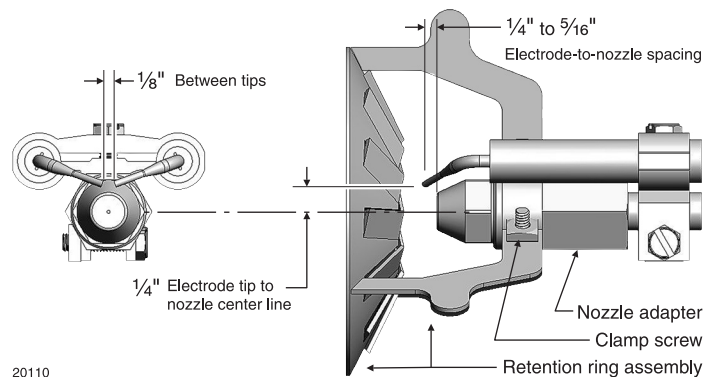

Figure 10 Electrode settings



3. Prepare burner *(continued)*

Set initial burner air settings

Combustion head ("A" dimension)

1. The combustion head adjusting screw is used to set the spacing between the retention ring and throttle ring (or air cone), regulating how much air passes around the retention ring.
2. See Figure 11.
3. Rotate the head adjusting screw until the distance from the housing detent to the beginning of the scale equals the value given in Table 4, page 13 ("A" dimension).

Air band

1. See Figure 12. Loosen the air band locking screw and rotate the air band until the opening equals the percent opening given in Table 4, page 13.

Final adjustments

1. The burner is now adjusted to the approximate air settings for the firing rate chosen.
2. When you check combustion with instruments during start-up or servicing, you may have to adjust the head and/or air band slightly to achieve the desired efficiency.
 - Increase the combustion head setting ("A" dimension) to increase air. If additional adjustment is needed, open the air band slightly.
 - Decrease the combustion head setting ("A" dimension) to decrease air. If additional adjustment is needed, close the air band slightly.
3. See "Adjust burner using test instruments," page 20.
4. Note that positive pressure overfire will reduce air flow, requiring more air opening.

Figure 11 Combustion head setting

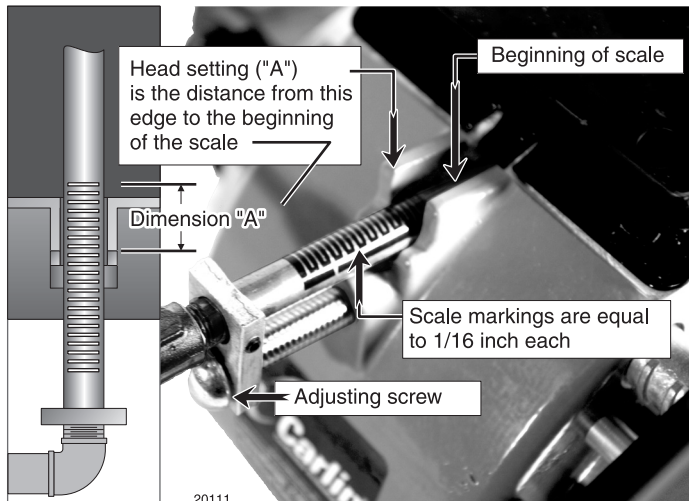

Figure 12 Air band setting

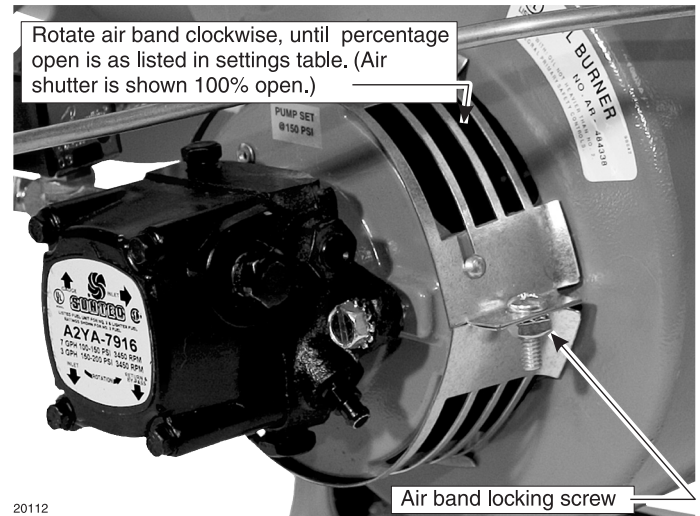
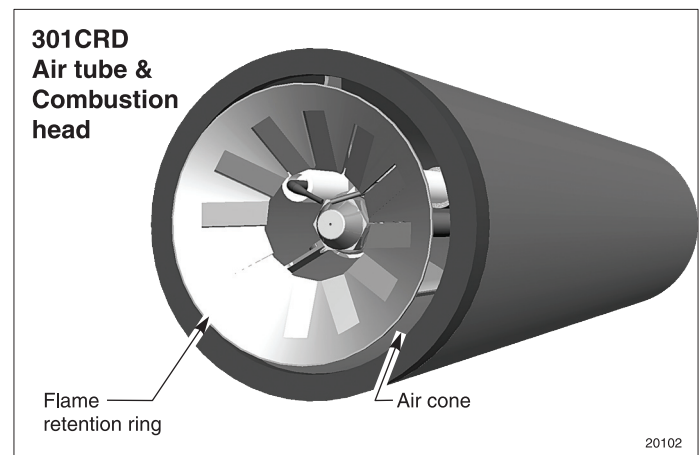
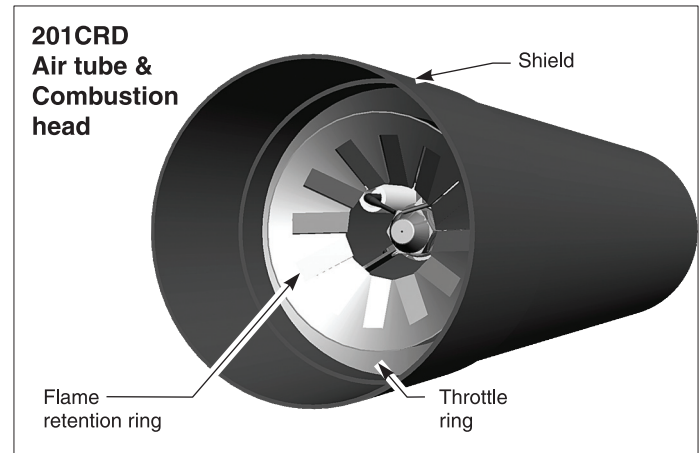

Figure 13 Combustion head/air tube combinations, typical



3. Prepare burner *(continued)*

Table 4 Approximate air band and combustion head settings

Input (approx. GPH @ 150 PSIG)	Nozzle size GPH	Combustion head setting (Dimension "A", inches)	Air band opening (percent)
201CRD burners			
2.50	2.00	1/4 (± 1/16)	20 (± 5)
2.75	2.25	5/16 (± 1/16)	25 (± 5)
3.00	2.50	3/8 (± 1/16)	30 (± 5)
3.25	2.75	7/16 (± 1/16)	40 (± 5)
3.50	3.00	1/2 (± 1/16)	45 (± 5)
4.00	3.25	5/8 (± 1/16)	60 (± 5)
4.50	3.75	11/16 (± 1/16)	85 (± 5)
5.00	4.00	13/16 (± 1/8)	90 (± 5)
5.50	4.50	1 (± 1/8)	95 (± 5)
301CRD burners (3¼" air cone)			
3.00	2.50	3/16	15
3.50	2.75	1/4	40
4.00	3.25	3/8	50
4.50	3.75	7/16	70
5.00	4.00	1/2	80
5.50	4.50	5/8	90
6.00	5.00	13/16	100
301CRD burners (3½" air cone)			
4.00	3.25	0	40
4.50	3.75	1/8	65
5.00	4.00	3/16	80
5.50	4.50	5/16	95
6.00	5.00	7/16	100
6.50	5.50	9/16	100
7.00	6.00	3/4	100

Inspect/install fuel supply

CAUTION

Inspect the oil supply system. Ensure that the fuel lines are correctly sized and installed and that the fuel flow is unobstructed, the oil tank is clean and only # 1 or # 2 heating oil are supplied. Failure to supply a reliable oil flow could result in loss of heat and potential severe equipment damage.

General guidelines:

- When installing oil lines, use continuous runs of heavy-wall copper tubing if possible.
- Check fuel unit (oil pump) data sheet for recommended line sizing, lift limitations and maximum length.

- Check all connections and joints to ensure they are air-tight.
- Use flare fittings. DO NOT use compression fittings.
- Never use pipe sealing tape. Fragments can break off and plug fuel line components.
- Install a shut-off valve at the tank and one near the burner. (Use fusible handle design valves when possible or when required by codes.)
- Install a large capacity fuel filter (rated for 50 microns or less) near the burner.

Fuel supply to multiple burners

- When possible, use separate fuel supply lines for each oil burner. Using manifolded oil supply lines can create problems. If the lines are undersized, operating vacuum will exceed limits. If the lines are oversized, fuel units may have difficulty priming. Because the lines must be sized to handle the capacity of all the burners, the line size will almost always be too large when only a single burner is running.
- If manifolding cannot be avoided, carefully size the lines following the fuel units manufacturer's instructions.

Fuel unit bypass plug

WARNING

The fuel unit is shipped with its bypass plug not installed, intended for a one-line oil system. Install the bypass plug only if connecting to a two-line oil system. Operating with the plug in place on a one-line system will damage the fuel unit and could lead to oil leakage and fire hazard.

WARNING

If the fuel line or fuel supply is above the burner, never exceed 3 PSIG pressure at the fuel unit inlet. Install a suitable OSV to reduce the pressure. Operating the fuel unit with higher inlet pressure could result in fuel unit seal damage, oil leakage and potential fire hazard.

Fuel unit vacuum limitations

- The sizing information in this manual applies only to the fuel units listed. For other fuel units, refer to the manufacturer's installation instructions.
- Attach a vacuum gauge to either of the fuel unit inlet ports, and verify the vacuum does not exceed the limit below for all firing conditions.
- The vacuum at the fuel unit inlet port must not exceed the value below.
 - One-line installations:

Model A2YA pump or B2YA pump	6 in. Hg
Model J pump or H pump	2 in. Hg
 - Two-line installations:

Model A2YA pump or J pump	12 in. Hg
Model B2YA pump or H pump	17 in. Hg

3. Prepare burner *(continued)*

One-line fuel system requirements

- See Figure 14.
- The standard burner fuel unit is a single-stage, 3450-RPM oil pump. Apply this fuel unit only on one-line systems where the fuel supply is on the same level with, or higher than, the burner. This ensures oil flow by gravity.
- Also make sure the total lift does not exceed 8 feet (height difference from bottom of oil tank to fuel unit) when the fuel unit is a Model A2YA or B2YA; or 2 feet when the fuel unit is a Model J or H.
- For other conditions, you must provide a two-line fuel system. You may also have to change the fuel unit to a two-stage type.

WARNING One-line oil systems must be air-tight, to avoid air leaks into the system or loss of prime. Use pipe dope where necessary, but never use tape sealants. Verify the operating vacuum does not exceed the limit given in this manual or the fuel unit manufacturer's instructions. Failure to comply could result in severe personal injury, death or substantial property damage.

Figure 14 One-line fuel system

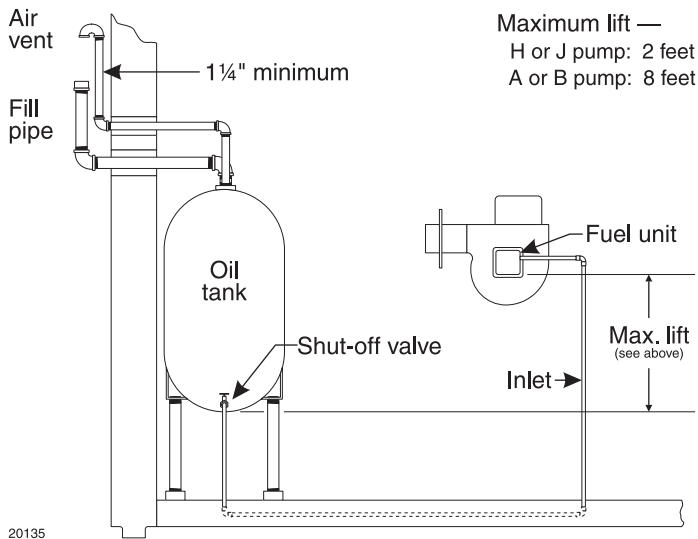

20135

Two-line fuel system requirements

- See Figure 15 and Table 5. Use Table 5 only for burners equipped with the Suntec fuel units listed. For burners using other fuel units, follow the fuel unit manufacturer's instructions for line sizing.
- Follow the guidelines in this manual regarding maximum lift and maximum operating vacuum. If the fuel system exceeds the limits given in this manual or the fuel unit manufacturer's instructions for a single-stage pump (standard), install a two-stage fuel unit. If limits are still exceeded, follow the fuel unit manufacturer's instructions for installation of transfer pump(s) if necessary.
- Always size fuel lines using an oil flow rate based on the fuel unit gearset capacity, not the burner firing rate. See fuel unit data sheet for information.

NOTICE Install the fuel unit bypass plug when connecting to a two-line system. The plug is shipped in a bag attached to the fuel unit, along with a fuel unit data sheet.

Figure 15 Two-line fuel system

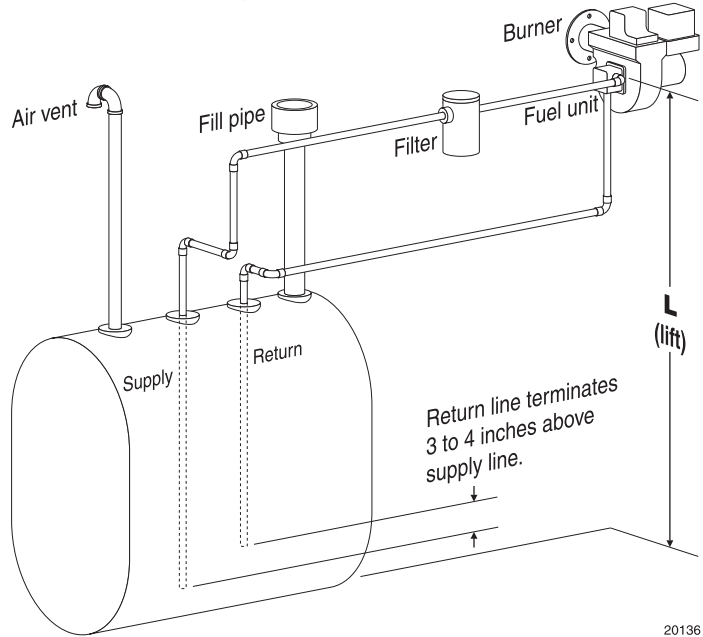

20136

Table 5 Two-line fuel system maximum lengths for copper tubing distribution. Use only for burners equipped with the Suntec fuel units listed. See fuel unit data sheet for any other fuel unit.

Lift (feet)	Maximum total length of tubing, feet (including both horizontal and vertical)							
	Single-stage fuel units				Two-stage fuel units			
	J3BB-100		A2YA-7916		H3BB-100		B2YA-8916	
	38 GPH gearset capacity		20 GPH gearset capacity		61 GPH gearset capacity		25 GPH gearset capacity	
	1/2" tubing	5/8" tubing	3/8" tubing	1/2" tubing	1/2" tubing	5/8" tubing	3/8" tubing	1/2" tubing
0	100	100	70	100	100	100	79	100
2	100	100	61	100	100	100	72	100
4	100	100	52	100	100	100	65	100
6	91	100	44	100	94	100	58	100
8	72	100	35	100	83	100	51	100
10	54	100	26	100	71	100	44	100
12	36	100	17	69	60	100	37	100
14	18	50	—	—	49	100	30	100
16	NOT recommended — use two-stage fuel unit				38	100	23	92
18	NOT recommended — use two-stage fuel unit				26	73	16	64

3. Prepare burner (continued)

Oil flow schematics / fuel unit connections

- Figures 16, 17 and 18 show oil flow for Carlin 201 and 301 burners and show port functions for Suntec Model A, B, J and H pumps.
- Figure 18 applies only for optional NYC-DAR pressure regulation kits.

Figure 16 201/301 burner with Suntec Model J or H fuel unit

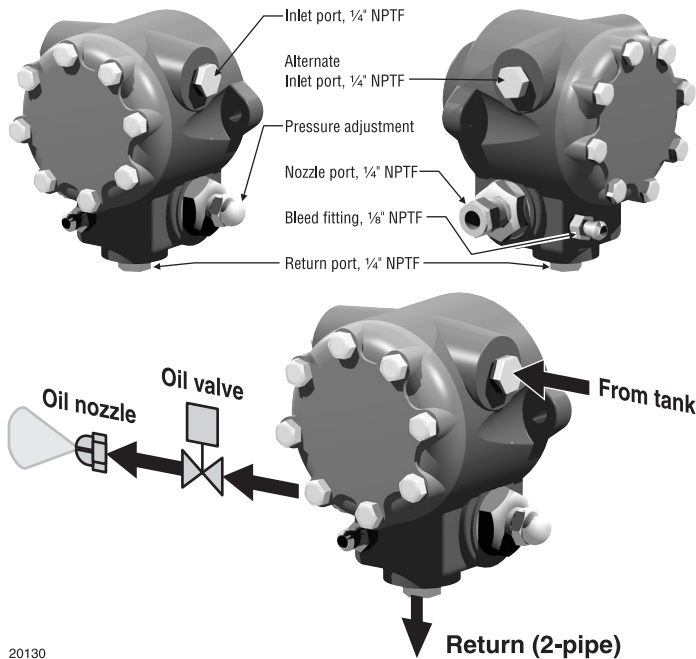

20130

Figure 17 201/301 burner with Suntec Model A or B fuel unit

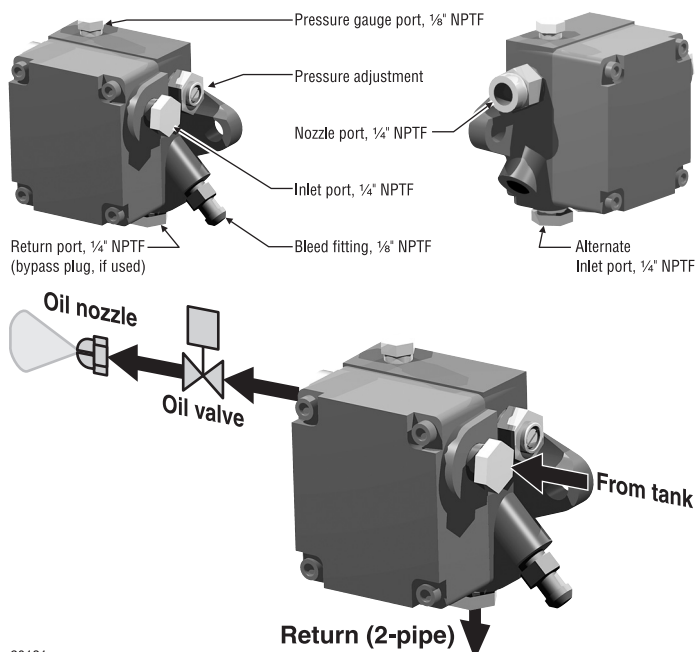

20131

Figure 18 201/301 burner with NYC-DAR pressure regulation kit

NOTICE Obtain pressure regulator kits for New York City Department of Air Resources. Kits must be set for the proper nozzle pressure.

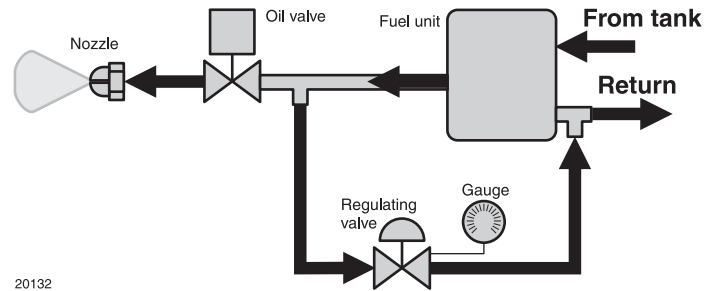

20132

Perform checkout procedures

Verify before starting burner:

- WARNING** Should overheating or an emergency occur, immediately:
- Shut off oil supply line valve.
 - Under some circumstances power should remain on for water pumps or blowers. Determine proper response before attempting start-up.
 - If burner fails ignition on several attempts, use burner blower to purge appliance chamber before restart.

Checklist

- Burner/appliance installed per appliance instruction manual?
- Burner nozzle verified per appliance manufacturer's instructions, Carlin OEM Spec Guide or Table 1, page 3?
- Burner/appliance installed per all applicable codes?
- Installation site has adequate combustion/ventilation air openings and vent system?
- Fuel supply line in good condition and sized/designed correctly?
- Oil tank has oil and oil line valves are open.
- Wiring installed per burner manual and appliance instructions?
- Burner, appliance and all components inspected and in good condition?

4. Wire burner • start burner – 50240 primary control

WARNING Turn off power to appliance when servicing burner. Failure to comply could result in severe personal injury, death or substantial property damage.

Wire burner – 50240 primary control

1. All wiring must comply with:
 - In the U.S — the National Electrical Code, ANSI Z223.1/NFPA 54.
 - In Canada — the Canadian Electrical Code Part 1, CSA standard C22.1.
 - All applicable local codes/standards.
2. Wire the burner following Figure 20 and any special instructions or wiring diagram provided with the appliance, burner or other components.
3. The burner requires a 240 VAC/60 hz/single-phase power supply, with a 5-amp fuse. The current draw (equipped with Carlin PSC motor) will be approximately 1.6 amps.
4. The 50240 thermostat terminals provide a 200ma for thermostat power source. Never apply external power to these terminals under any circumstances. To avoid this problem when using zone valves, disconnect field wires from 50240 thermostat terminals. Then connect a voltmeter across terminals. Operate all zones and verify that there is never a voltage reading at the meter. A voltage reading indicates incorrect wiring that must be corrected before attempting to operate the burner.
5. Alarm terminals provide a 24 vac-rated dry contact, suitable for use with security/fire alarm systems such as Carlin SecureHeat™.
6. Make sure the burner and appliance are correctly wired and the line switch is properly fused for the load.

To start burner

WARNING Do not start the burner if the combustion chamber contains oil or oil vapor.

1. Turn service switch OFF.
2. Perform inspections and checkouts on pages 18 and 19.
3. Slip one end of a 3/16-inch I.D. clear plastic hose over end of bleed valve, the other end into a container. Then open bleed valve.
4. Set thermostat (operating controls) to call for heat.
5. Turn service switch ON.
6. Bleed oil line until plastic line is free of bubbles; then another 15 seconds longer. (Should the primary control timing cause a lockout during purging, restart the burner following the primary control data sheet instructions.)
7. Close bleed valve. The burner should cycle through the sequence given in the primary control data sheet.
8. Perform primary control flame failure lockout and safety timing tests per instructions in primary control data sheet.
9. Should control/burner fail to operate correctly, see page 19 for suggestions in troubleshooting.

Figure 20 201CRD and 301CRD burners wiring using Carlin 50240 primary control (see appliance manual or separate wiring information for burner equipped with a primary control not covered in this manual)

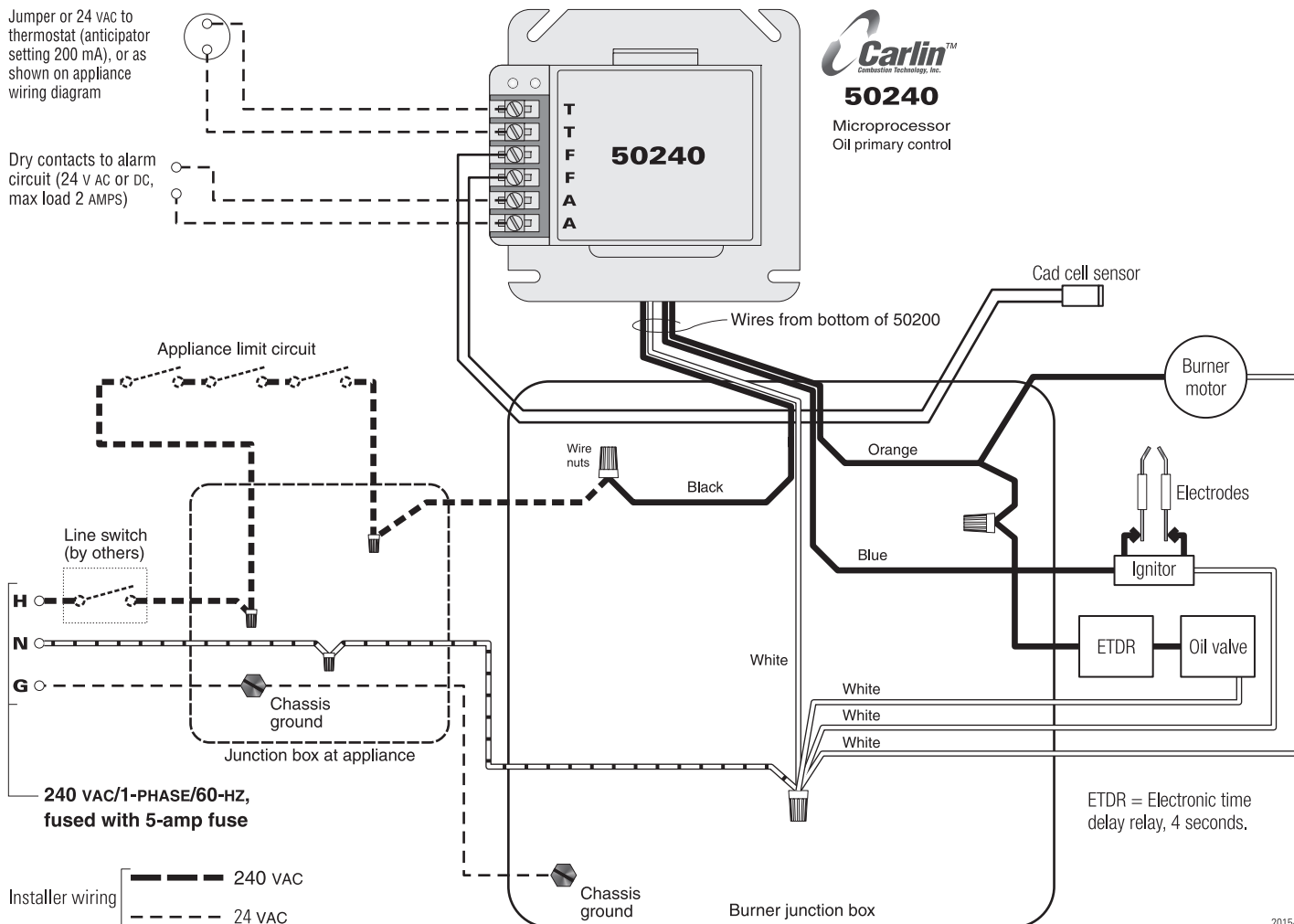





















20154

Start-up & operation



WARNING Do not start the burner if the combustion chamber contains oil or oil vapor.



NOTICE Per UL requirements, the control will not turn on if the cad cell senses flame during the self-test. If the cad cell sees light, the control will remain in self-test mode until the cad cell no longer senses light (flame). The amber LED will remain on, but blink off momentarily  every 3 to 4 seconds.

NOTICE Check 50240 control label for trial for ignition (TFI) timing.







-   **Power ON** Open all manual oil line valves. Close the line switch. (If Red light turns on constant , control is in lockout. See below to reset.)
-   **Self-test 1** Each time the limit circuit sends power to the black wire, the control performs a “boot-up” test to verify internal operation. About 4 seconds after power application, the amber LED turns on. The test continues for about 6 more seconds. If the test fails, the control turns the amber LED off and repeats this test sequence until successful. (This test occurs on every call for heat cycle if burner is operated by a limit control (terminals “T-T” jumpered).
-   **Stand-by** (Thermostat circuit open, limit circuit closed) If Self-test 1 is successful, amber LED turns off and control waits for thermostat circuit to close.
-   **Call for heat** Set thermostat to call for heat. Thermostat circuit must close (and black wire must receive power from the limit circuit).
- Self-test 2** The amber LED turns on. For the first 3 to 4 seconds, the control performs a self-test. If the cad cell senses flame, the control repeats this test until flame is no longer detected. During this time, the amber LED remains on, but blinks off momentarily  every 3 to 4 seconds. If the control detects motor contacts closed, lockout occurs.
-   **Burner on** After the self-test, amber LED turns off. The **ignitor** starts, followed 1 second later by the **motor**. The electronic time delay relay allows the **oil valve** to open 4 seconds later.
-   **TFI** The cad cell must sense flame within the TFI time limit (trial for ignition). After cad cell senses flame, the ignitor stays on another 10 seconds (flame stabilization period).
-   **Run** The burner continues firing during call for heat if the cad cell senses flame. LED's are off during normal running.
-   **Lockout** If cad cell does not sense flame within 15 seconds after burner starts, **lockout** occurs. The control turns the red LED on constant, and closes the **alarm** contact.
- To Reset** Push in and hold reset button for 1 second, then release.
-   **Latch-up** If the control locks out **3 times** during a single call for heat, **latch-up** occurs. The control turns on both the amber and red LED's constant. You must use the special procedure below to reset the control after latch-up.

WARNING **Reset after latch-up — Only a qualified service technician should attempt to reset the control after latch-up. The problem that caused the repeated burner problems must be corrected before returning the burner to normal operation.**







  Push in and hold the reset button for about 10 seconds. The amber and red LED's will begin to flash alternately.

  After the LED's begin flashing, continue holding the reset button for about another 20 seconds. The LED's will turn off. Release the reset button and the control will restart. (Releasing the button before the LED's turn off will cause the control to remain in latch-up.)

NOTICE The 50240 control will not reset from lockout or latch-up if power is interrupted.









-   **Flame failure** If the cad cell loses flame signal during operation (after the TFI), the red LED flashes. The burner shuts off within 2 seconds. **Re-cycle:** Control waits for 65 seconds (with red LED flashing), then begins again at **Self-test 2**. Red LED goes off .
-   **End cycle** Set thermostat (or aquastat) to stop call for heat. The burner shuts off within 2 seconds after end of call for heat.
-   **Stand-by** Control remains in stand-by mode until limit circuit sends power to the black wire (call for heat).

Model 50240 diagnostic LED's

-  — Red **OFF**  — Red **ON**  — Red **FLASHING**
-  — Amber **OFF**  — Amber **ON**  — Amber **FLASHING**
-  — Amber **BLINKING** (blinks off momentarily every 3 to 4 seconds)

Service & Troubleshooting

Burner (control) will not come on

-   **No power to control**
 - Check line voltage to the control (at least 102 vac).
 - Check all electrical connections.
 -   **Control is in lockout**
 - Red LED will be on. Press the reset button for 1 second.
 - If the control returns immediately to lockout, The Safety Monitoring Circuit may have detected an internal control problem. Replace the control.
 -   **CAD cell seeing light**
 - Amber LED blinks off each 3 to 4 seconds. Remove one yellow lead from FF terminal on the control. If the amber **LED remains on**  with a wire detached, the control is defective. If amber **LED goes off** , control is OK, and:
 - light is leaking into the burner housing, OR
 - CAD cell is defective, OR
 - there is a problem with the CAD cell wiring or holder.
 - If appliance was recently shut down, CAD cell may see residual hot spots in chamber.
- To troubleshoot:
- **Check CAD cell** by unplugging it and measuring the resistance across its pins: dark resistance at least 50 KOHMS; room light resistance less than 10 KOHMS. Replace if necessary. If the CAD cell functions properly, reinstall the cell and close the burner housing.
 - **Check for stray light** by measuring the CAD cell resistance looking into the inactive combustion chamber. It should read at least 50 KOHMS.

Repeated flame failures (**flashing red LED**)

Check for:

- CAD cell is defective.
- Air leaking into oil line causing flame out — Check oil line connections and filter gasket.
- Defective nozzle causing flame to be erratic — Change nozzle.
- Excessive airflow or draft causing flame to leave burner head — Check for proper air shutter setting and draft.
- Excessive back pressure causing flame to be erratic — Check appliance and flue for sooting/plugging.

Control locks out after TFI (**red LED on**)

Check for:

- No oil to burner — Check oil supply, filter, lines.
- Shorted electrodes — Inspect for cracked porcelain and replace as needed.
- Poor spark — Check electrode spacing and condition per burner manual. Replace or realign if necessary.
- Nozzle clogged — Replace nozzle.
- Airflow too high — Check air shutter setting.
- Ignitor module defective — Replace if no spark.
- CAD cell defective.
- Oil valve stuck in closed position.
- Check wiring connections.

4. Wire burner • start burner – 60240 primary control

WARNING Turn off power to appliance when servicing burner. Failure to comply could result in severe personal injury, death or substantial property damage.

Wire burner – 60240 primary control

- All wiring must comply with:
 - In the U.S — the National Electrical Code, ANSI Z223.1/NFPA 54.
 - In Canada — the Canadian Electrical Code Part 1, CSA standard C22.1.
 - All applicable local codes/standards.
- Wire the burner following Figure 21 and any special instructions or wiring diagram provided with the appliance, burner or other components.
- The burner requires a 240 VAC/60 hz/single-phase power supply, with a 5-amp fuse. The current draw (equipped with Carlin PSC motor) will be approximately 1.6 amps.
- The 60240 thermostat terminals provide a 200ma for thermostat power source. Never apply external power to these terminals under any circumstances. To avoid this problem when using zone valves, disconnect field wires from 60240 thermostat terminals. Then connect a voltmeter across terminals. Operate all zones and verify that there is never a voltage reading at the meter. A voltage reading indicates incorrect wiring that must be corrected before attempting to operate the burner.
- Alarm terminals provide a 24 vac-rated dry contact, suitable for use with security/fire alarm systems such as Carlin SecureHeat™.
- Make sure the burner and appliance are correctly wired and the line switch is properly fused for the load.

To start burner

WARNING Do not start the burner if the combustion chamber contains oil or oil vapor.

- Turn service switch OFF.
- Perform inspections and checkouts on pages 20 and 21.
- Slip one end of a 3/16-inch I.D. clear plastic hose over end of bleed valve, the other end into a container. Then open bleed valve.
- Set thermostat (operating controls) to call for heat.
- Turn service switch ON.
- Bleed oil line until plastic line is free of bubbles; then another 15 seconds longer. (Should the primary control timing cause a lockout during purging, restart the burner following the primary control data sheet instructions.)
- Close bleed valve. The burner should cycle through the sequence given in the primary control data sheet.
- Perform primary control flame failure lockout and safety timing tests per instructions in primary control data sheet.
- Should control/burner fail to operate correctly, see page 21 for suggestions in troubleshooting.

Figure 21 201CRD and 301CRD burners wiring using Carlin 60240 primary control (see appliance manual or separate wiring information for burner equipped with a primary control not covered in this manual)

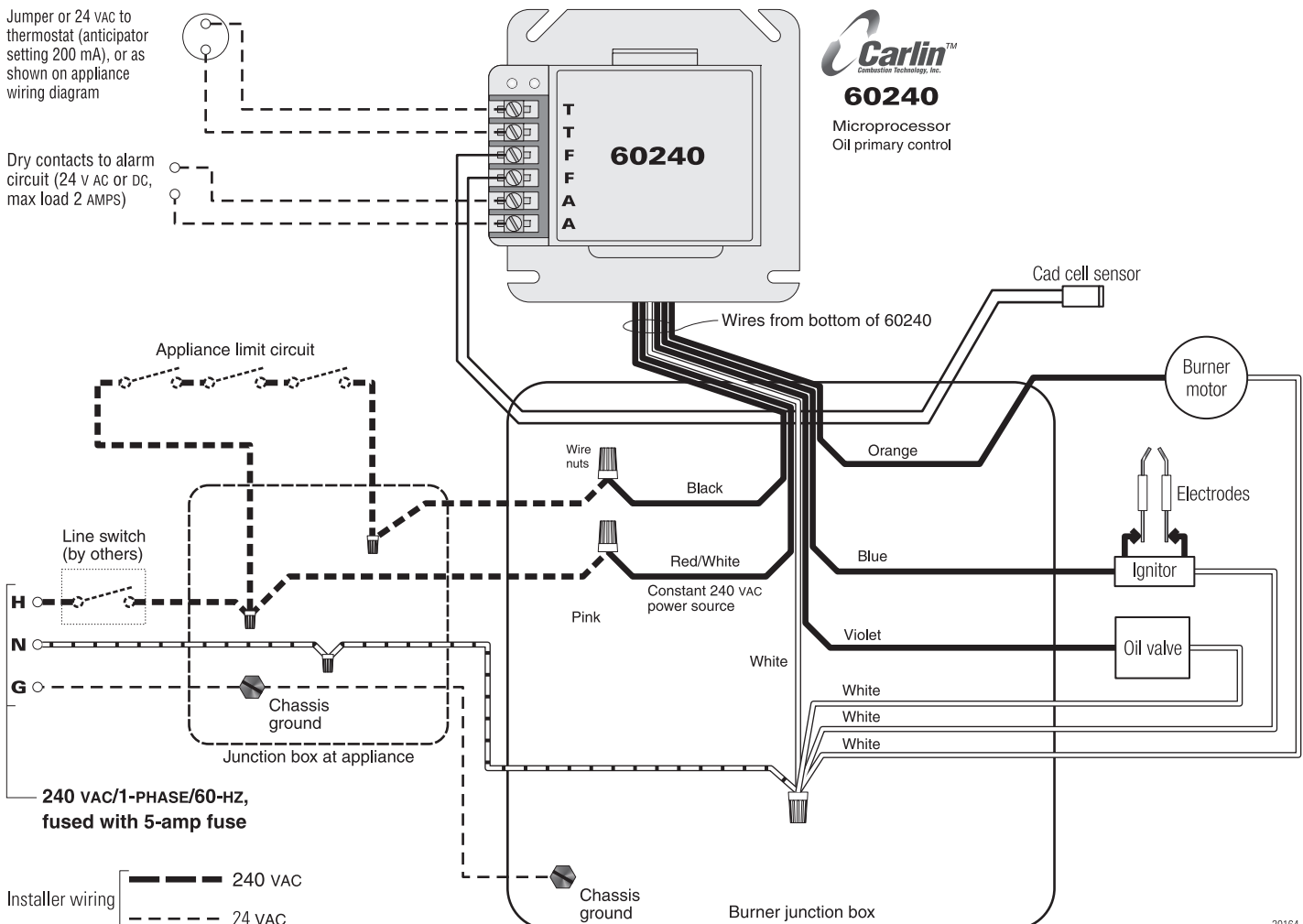













Start-up & operation

WARNING Do not start the burner if the combustion chamber contains oil or oil vapor.

NOTICE Per UL requirements, the control will not turn on if the cad cell senses flame during the self-test. If the cad cell sees light, the control will remain in self-test mode until the cad cell no longer senses light (flame). The amber LED will remain on, but blink off momentarily  every 3 to 4 seconds.

NOTICE Check 60240 control label for trial for ignition (TFI), pre-purge and post-purge timings.





-  **Power ON** Open all manual oil line valves. Close the line switch. (If Red LED turns on constant , control is in lockout. See below to reset.)
-  **Self-test 1** The control performs a “boot-up” test to verify internal operation each time power is applied to the red/white wire. About 4 seconds after power application, the amber LED turns on. The test continues for about 6 more seconds. If the test fails, the control turns the amber LED off and repeats this test sequence until successful.
-  **Stand-by** (No call for heat) If Self-test 1 is successful, amber LED turns off and control waits for heat call.
-  **Call for heat** Set thermostat (or limit) to call for heat. Thermostat circuit must be closed and power coming to black wire from limit circuit.
- Self-test 2** The amber LED turns on. For the first 3 to 4 seconds, the control performs a self-test. If the cad cell senses flame, the control repeats this test until flame is no longer detected. During this time, the amber LED will remain on, but blink off momentarily  every 3 to 4 seconds. If the control detects motor contacts closed, lockout occurs.
-  **Burner on** After the self-test, amber LED turns off. The **ignitor** starts, followed 1 second later by the **motor**.
-  **Pre-purge** The **oil valve** opens after the valve delay-on period (pre-purge).
-  **TFI** The cad cell must sense flame within the TFI time limit (trial for ignition). After cad cell senses flame, the ignitor stays on another 10 seconds (flame stabilization period).
-  **Run** The burner continues firing during call for heat if the cad cell senses flame. Both LED's are off during normal running.
-  **Lockout** If cad cell does not sense flame within the TFI time limit after burner starts, **lockout** occurs. The control turns the red LED on constant, and closes the **alarm** contact.
- To Reset** Push in and hold reset button for 1 second, then release.
-  **Latch-up** If the control locks out **3 times** during a single call for heat, **latch-up** occurs. The control turns on both the amber and red LED's constant. You must use the special procedure below to reset the control after latch-up.

WARNING **Reset after latch-up — Only a qualified service technician should attempt to reset the control after latch-up. The problem that caused the repeated burner problems must be corrected before returning the burner to normal operation.**







 Push in and hold the reset button for about 10 seconds. The amber and red LED's will begin to flash alternately.

 After the LED's begin flashing, continue holding the reset button for about another 20 seconds. The LED's will turn off. Release the reset button and the control will restart. (Releasing the button before the LED's turn off will cause the control to remain in latch-up.)

NOTICE The 60240 control will not reset from lockout or latch-up if power is interrupted.



-  **Flame failure** If the cad cell loses flame signal during operation (after the TFI), the red LED flashes. The **oil valve** closes within 2 seconds. The **motor** remains on for the motor delay off period, then shuts off. (If no oil valve is wired to the control, the burner shuts down within 2 seconds.) **Recycle:** Control waits for 65 seconds (with red LED flashing), then begins again at **Self-test 2**. Red LED goes off .
-  **Post-purge** Set thermostat (or aquastat) to stop call for heat. The **oil valve** (if installed) will turn off within 2 seconds. The **motor** remains on for the motor delay off period (post-purge), then turns off. (If no oil valve is wired to the control, the burner shuts off within 2 seconds after end of call for heat. There is no post-purge.)
-  **Stand-by** Control remains in stand-by mode until limit circuit sends power to the black wire and thermostat circuit closes (call for heat).

Model 60240 diagnostic LED's



-  – Red **OFF**  – Red **ON**  – Red **FLASHING**
-  – Amber **OFF**  – Amber **ON**  – Amber **FLASHING**
-  – Amber **BLINKING** (blinks off momentarily every 3 to 4 seconds)

Service & Troubleshooting

Burner (control) will not come on

-  **No power to control**
 - Check line voltage to the control (at least 102 VAC).
 - Check all electrical connections.
-  **Control is in lockout**
 - Red LED will be on. Press the reset button for 1 second.
 - If the control returns immediately to lockout, the Safety Monitoring Circuit may have detected an internal control problem. Replace the control.

CAD cell seeing light

- Amber LED blinks off each 3 to 4 seconds. Remove one yellow lead from FF terminal on the control. If the amber **LED remains on**  with a wire detached, the control is defective.
- If amber **LED goes off** , control is OK, and:
 - light is leaking into the burner housing, **OR**
 - CAD cell is defective, **OR**
 - there is a problem with the CAD cell wiring or holder.
 - If appliance was recently shut down, CAD cell may see residual hot spots in chamber.

To troubleshoot:

- **Check CAD cell** by unplugging it and measuring the resistance across its pins: dark resistance at least 50 KOHMS; room light resistance less than 10 KOHMS. Replace if necessary. If the CAD cell functions properly, reinstall the cell and close the burner housing.
- **Check for stray light** by measuring the CAD cell resistance looking into the inactive combustion chamber. It should read at least 50 KOHMS.

Repeated flame failures (flashing red LED)

Check for:

- CAD cell is defective.
- Air leaking into oil line causing flame out — Check oil line connections and filter gasket.
- Defective nozzle causing flame to be erratic — Change nozzle.
- Excessive airflow or draft causing flame to leave burner head — Check for proper air shutter setting and draft.
- Excessive back pressure causing flame to be erratic — Check appliance and flue for sooting/plugging.

Control locks out after TFI (red LED on)

Check for:

- No oil to burner — Check oil supply, filter, lines.
- Shorted electrodes — Inspect for cracked porcelain and replace as needed.
- Poor spark — Check electrode spacing and condition per burner manual. Replace or realign if necessary.
- Nozzle clogged — Replace nozzle.
- Airflow too high — Check air shutter setting.
- Ignitor module defective — Replace if no spark.
- CAD cell defective.
- Oil valve stuck in closed position.
- Check wiring connections.

5. Adjustment and verification

Adjust burner using test instruments

1. Operate burner for 15 minutes before making final adjustments using test equipment.
2. Check for leaks in fuel piping.

WARNING Inspect fuel piping system for leaks. Repair any leaks to avoid fire hazard from oil leakage or combustion problems due to air infiltration into oil.

3. Inspect flame
 - Look at flame through appliance combustion chamber observation port. The flame should be well-defined and should not impinge on any appliance surface. (If you make air changes later, inspect the flame again.)

WARNING Do not attempt to confirm combustion simply by inspecting the flame visually. You must use combustion test instruments. Failure to properly verify/adjust combustion could allow unsafe operation of the burner, resulting in severe personal injury, death or substantial property damage.

4. Insert test probe into vent sample opening to sample flue products.
5. With the burner equipped with the correct oil nozzle, combustion head setting and air band setting, the flue products will usually contain between 11% and 12% CO₂ (5.9% and 3.8% O₂) and zero (Bacharach) smoke.
6. Use combustion test equipment to verify that burner is properly set up for your installation, within the range listed in Table 3. Appliances with positive pressure in the chamber may require a wider air opening. See appliance instructions for details. Verify/adjust settings by testing with instruments.
 - a. Check smoke. It should be zero on the Bacharach scale.
 - b. Set the appliance flue damper or barometric draft regulator so the draft or pressure in the vent complies with the appliance manufacturer's instructions.
 - c. If no draft setting information is available, set the draft to -0.01 to -0.02 inches w.c. at the appliance flue outlet.

WARNING Heating units designed for natural draft operation are normally set for a slightly negative pressure, usually -0.01 to -0.02 inches w.c. draft at the combustion chamber test port. Appliances designed for forced draft (positive pressure in the chamber) must be air-tight to prevent exfiltration of harmful combustion products. Failure to properly set draft for the appliance could result in severe personal injury or death.

- d. Check percent of CO₂ (or O₂). Fine tune the burner, if necessary, by slightly adjusting the head position for more or less air.
- e. Each time you change the burner air band or combustion head setting, you will have to check and possibly adjust the draft.
- f. Recheck smoke (should be zero) and flue or chamber pressure/draft (adjust if necessary and retest).

WARNING All installations should be checked after one to two weeks of operation to ensure the appliance/burner units are operating correctly.

Firing against positive overfire pressure

1. Burner rating maximum inputs are based on operation with zero to slightly negative pressure overfire, typically 0.01 to 0.03 inches w.c.
2. When a burner is applied to an appliance that operates with a higher pressure overfire, the maximum firing rate decreases because the maximum available air flow from the burner blower decreases.
3. Read the graph below in Figure 22 to find the maximum burner firing rate at positive overfire pressures.

WARNING Do not apply 201CRD or 301CRD burners at positive overfire pressure higher than shown in Figure 19 unless the application has been factory pretested.

Figure 22 Maximum firing rate decreases as overfire pressure increases

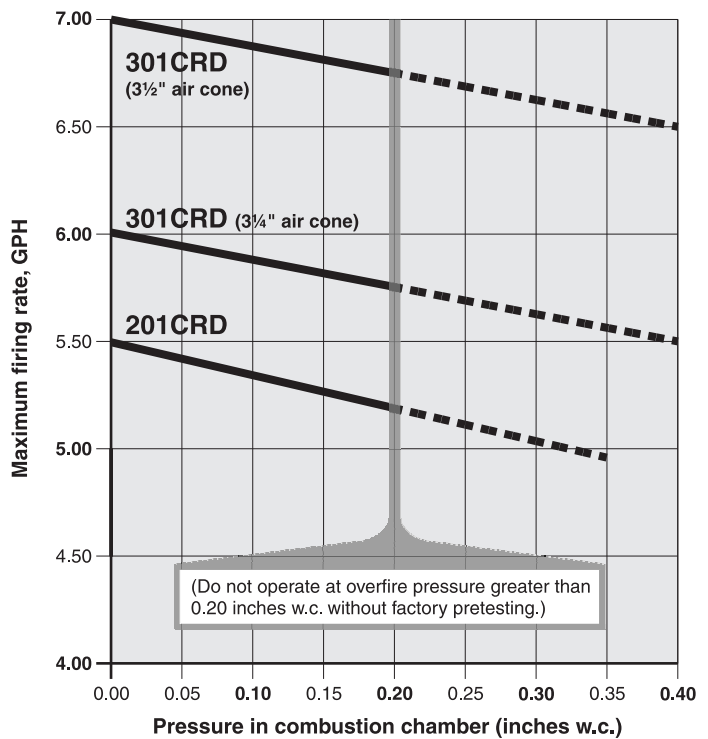

20116

5. Adjustment and verification *(cont.)*

Verify burner/appliance operation

Check burner / appliance / controls operation

- Test operating and limit controls on appliance as specified in appliance instructions.
- Check operation of the primary control by forcing lockout to occur. For primary controls that enter latch-up after multiple lockouts, force latch-up to occur as well. Reset primary control per control data sheet instructions after each test.
- Start and stop the burner several times, allowing the primary control to sequence through normal operation. Verify correct operation of burner and primary control throughout.

Verify vent system operation

- Verify vent is operating correctly and flue products are properly exhausted from building. If the building contains any exhaust fans or conditions that could affect vent performance, check burner/appliance/vent operation with exhaust fans (or other conditions) operating.

Combustion/ventilation air

- Verify combustion/ventilation air openings are not/will not be obstructed.
- Verify air opening louvers are fully open.
- If louvers are motor-operated, verify motor and end switch are interlocked with appliance/burner wiring to prevent operation of the burner if the air louvers are not fully opened.

Prepare burner for normal operation

- Cycle burner off with appliance controls.
- Turn off power to the appliance.
- Seal the appliance flue test opening.
- Verify all components and wires are in place and burner is ready for operation.
- Restore power to the appliance.

Train the user

- Train the user to operate the burner and appliance under normal conditions.
- Explain procedure to shut down burner/appliance when required.
- Review the back cover of this manual (and the appliance manual) with the user.
- Verify the user is aware of all procedures specified in the manuals.
- Verify user will not store or use combustible liquids or materials or contaminants in the vicinity of the burner/appliance.

6. Annual start-up and service

Annual start-up & service

WARNING This burner must be started and serviced at least annually by a qualified service technician. Failure to properly maintain and service the burner could result in severe personal injury, death or substantial property damage.

- Discuss burner/appliance operation with user to determine any problems that may have occurred during the previous season and to verify user is aware of proper operation and care of the burner/appliance.
- Review proper operation of the appliance/burner unit with the user.
- Turn off power to appliance.
- Remove combustion head assembly to clean and adjust if necessary. (See procedure on page 10.)
- If the inside surface of the air tube and/or retention ring need to be cleaned, clean them with a vacuum cleaner with brush attachment while the combustion head assembly is out of the burner.
- Replace the oil nozzle with the correct size specified in this manual or the OEM guide.
- Inspect and adjust the ignition electrodes and insulators per instructions on page 11 of this manual. Replace if proper spacing cannot be achieved or if components are damaged.
- Close the housing cover plate and secure in place.
- Inspect the fuel line oil filter. Replace if necessary.

NOTICE Oil line filters — Use a non-bypassing filter to prevent nozzle plugging caused by poor oil filtration. Non-bypassing filters prevent small foreign particles from bypassing the filter, a common problem with fiber element type filters. Another problem of some filters is the fiber from filter element tears can break away and plug the nozzle or fuel unit.

- Perform the complete checkout procedures of pages 13 to 21, including system inspection and checks.
- Inform the user of any problems found.

7. Repair parts

For parts not shown or listed, contact factory and/or check separate documentation supplied with appliance/burner unit.

Item	Description	Part No.	201 CRD	301 CRD	Item	Description	Part No.	201 CRD	301 CRD	
1	Blower housing	Consult factory				Flame retention ring assemblies				
2	Air band				14	Flame retention ring assembly	55418S	•		
	Air band	47001S	•	•		Flame retention ring assembly	55715S		•	
3	Combustion head assemblies				15	Flanges (mounting)				
	7" nominal, approx. 16-3/4" OAL	54155	•			4" Mounting flange universal 4" ID, 8 1/2" OD	59642	•	•	
	9" nominal, approx. 18-3/4" OAL	54205	•			4" Mounting flange for forced draft 4" ID, 11" OD (not shown)	59444S	•	•	
	11" nominal, approx. 20-3/4" OAL	53975	•			4" Mounting flange for UV scanner (not shown)	59444UV	•	•	
	15" nominal, approx. 24-5/16" OAL	54031	•		16	Gaskets (flange)				
	6" nominal, approx. 16-3/4" OAL	55574		•		Gasket for universal flange	40287	•	•	
	8" nominal, approx. 18-3/4" OAL	55616		•		Gasket for forced draft flange and UV scanner (not shown)	40246	•	•	
	10" nominal, approx. 20-3/4" OAL	55434		•		15 + 16	Flange and gasket combinations			
14" nominal, approx. 24-3/4" OAL	55491		•	4" Universal flange and gasket	23259S		•	•		
3 + 4 or 5	Air tube/combustion head assemblies				17	4" Pressure flange and gasket	23184S	•	•	
	7" Nominal	22046	•			Blower wheels (fans)				
	9" Nominal	22053	•			Blower wheel, 5-3/4" OD x 4" W, 1/2" Bore	28563	•	•	
	11" Nominal	22012	•			18	Fuel units			
	15" Nominal	22020	•		Suntec, 1 stage, J3BB-100		23325S	•	•	
	B-Style 6" Nominal	22293		•	Suntec, 1 stage, NYC, J3BB-100 100PSIG		74435S	•	•	
	B-Style 8" Nominal	22327		•	Suntec, 2 stage, H3BB-100		23341S	•	•	
	B-Style 10" Nominal	22202		•	Suntec, 2 stage, NYC, H3BB-100 100PSIG		74427S	•	•	
	B-Style 14" Nominal	22236		•	Suntec, 2 stage, NYC, H3BB-100 150PSIG		74427HP	•	•	
	C-Style 6" Nominal	22442		•	Suntec, 1 stage, A2YA-7916		23234S	•	•	
	C-Style 8" Nominal	22475		•	Suntec, 1 stage, NYC, A2YA-7916 100PSIG		74443S	•	•	
	C-Style 10" Nominal	22350		•	Suntec, 1 stage, NYC, A2YA-7916 150PSIG		74443HP	•	•	
	C-Style 14" Nominal	22384		•	Suntec, 2 stage, B2YA-8916		23267S	•	•	
	4	Air tubes, 201				Suntec, 2 stage, NYC, BY2A-8916 100PSIG	74459S	•	•	
7" nominal, approx. 8" OAL		46128	•		Suntec, 2 stage, NYC, B2YA-8916 150PSIG	74559HP	•	•		
9" nominal, approx. 10" OAL		46144	•		19	Motor				
11" nominal, approx. 12" OAL		46052	•			220/240 vac, 1/4 hp, 3450 RPM, Carlin PSC	99220	•	•	
15" nominal, approx. 16" OAL	46078	•		20		Nozzle line/adaptor assemblies				
5	Air tubes, 301						147/32" OAL, for nominal 7"-201 / 6"-301	58727S	•	•
	B-Style, 6" nominal, approx. 6-13/16" OAL	46383			•	167/32" OAL, for nominal 9"-201 / 8"-301	58743S	•	•	
	B-Style, 8" nominal, approx. 8-13/16" OAL	46417			•	187/32" OAL, for nominal 11"-201 / 10"-301	58685S	•	•	
	B-Style, 10" nominal, approx. 10-13/16" OAL	46326			•	227/32" OAL, for nominal 15"-201 / 14"-301	58701S	•	•	
	B-Style, 14" nominal, approx. 14-13/16" OAL	46342			•	21	Oil lines			
	C-Style, 6" nominal, approx. 6-13/16" OAL	46490		•	Oil valve to combustion head, A and B pump		34785S	•	•	
C-Style, 8" nominal, approx. 8-13/16" OAL	46573		•	Oil valve to combustion head, H and J pump	75333S		•	•		
C-Style, 10" nominal, approx. 10-13/16" OAL	46433		•	22	Oil valves					
C-Style, 14" nominal, approx. 14-13/16" OAL	46458		•		Carlin oil valve	SVC20FF	•	•		
6	Electrode bracket w/hardware	23135S	•	•	23	Brass nipple, 1/8" PT x 2" long	44529	•	•	
7	Couplings				24	Carrying tube, 2 1/4" Long	34405	•	•	
	1/2" ID x 7/16" ID x 3 1/8" L (H or J pump)	28712	•	•	25	Elbow, male, 1/8" PT x 3/16" tube	29926	•	•	
	1/2" ID x 5/16" ID x 4 9/16" L (A or B pump)	28720	•	•	26	CAD cell assembly	1440700K	•	•	
8	Nozzle (obtain locally)					27	Screw for adjusting combustion head assembly	47167	•	•
9	Pedestal w/hardware	23358S	•	•	28	Ignitor cover plate	9778900	•	•	
10	Terminal for ignition transformer	24471	•	•		29	Ignitor (208 - 240 vac)	40700	•	•
11	Yoke for adjusting combustion head	54916	•	•	30	Ignitor adapter	98061A	•	•	
12	Junction box, 4" square x 1 1/2" deep	33902	•	•	13	Electrode sets				
	Set of 2, 7/6" nominal, approx. 8 1/2" OAL	82776S	•	•		NS	Time delay 4 Sec., solid state	35741	•	•
	Set of 2, 9/8" nominal, approx. 10 3/4" OAL	82784S	•	•		NS	NYC/BAR nozzle pressure regulator kit, 150PSI, field installed	91637	•	•
	Set of 2, 11/10" nominal, approx. 12 1/2" OAL	82792S	•	•						
	Set of 2, 15/14" nominal, approx. 16 1/2" OAL	82818S	•	•						
	Set of 2, 18/17" nominal, approx. 19 1/2" OAL	82826S	•	•						

7. Repair parts *(cont.inued)*

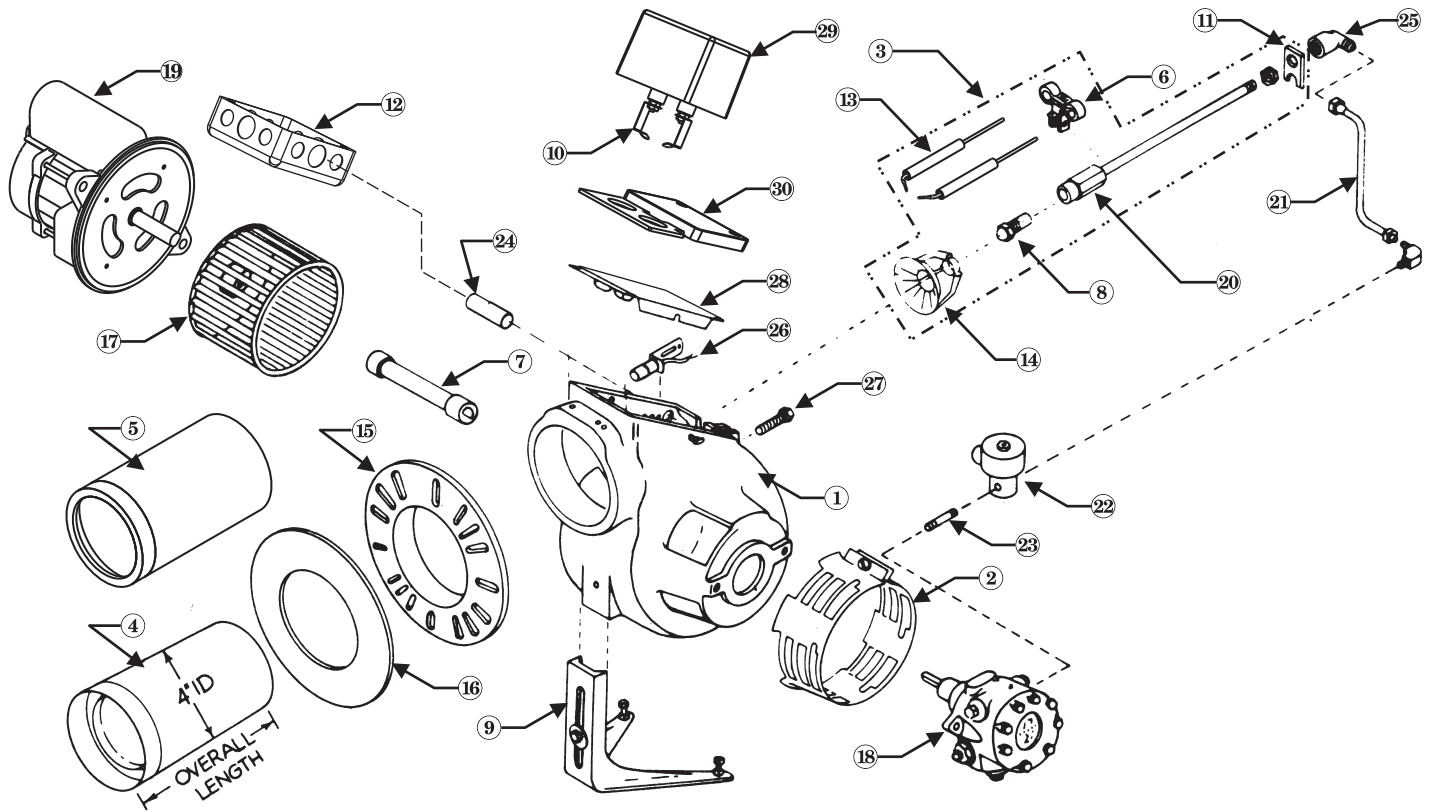

8. Maintenance/service procedures

WARNING Turn off power to appliance when servicing burner. Failure to comply could result in severe personal injury, death or substantial property damage.

Cleaning blower wheel

- The blower wheel accumulates dust and debris from normal operation. You will need to clean the wheel blades periodically to prevent reduction in airflow.
 - Inspect the blower wheel by removing the blower wheel access cover.
 - To remove the cover, open the ignitor plate and loosen the blower wheel access cover screw about three turns.
 - Inspect the blower wheel to see if it needs to be cleaned. Dirt and lint on the wheel reduce air flow, and must be removed if the burner is to operate correctly.
- To clean blades, remove the two bolts securing the motor to blower housing.
 - Slide the motor out and rotate to remove and access blower wheel.
 - Use a brush and vacuum to clean each blade and the blower housing interior.
 - Install motor/wheel in blower housing and secure with the two bolts.
 - Push wire slack back into junction box.

Replacing blower motor or wheel

- If either the blower wheel or motor must be replaced, remove the two bolts securing the motor to housing.
- Disconnect the motor wires in the burner junction box.
- Loosen the Allen screw securing the blower to the motor shaft and remove the wheel.
- When assembling the replacement assembly, slide the wheel onto the motor shaft and use feeler gauges to set space between the blower wheel and the motor face. This space must be:

201CRD – 1/8"	301CRD – 1/8"
---------------	---------------
- Install the motor/wheel assembly in the housing, wire the motor leads and secure the motor with the two bolts.

Motor maintenance

- The Carlin PSC motor is constructed with permanently-lubricated bearings, and requires no oiling. Should you replace the original motor with another type of motor, occasional oiling may be required, depending on motor design and manufacturer's recommendations.
- Any time you replace a component or disassemble any part of the burner for service/maintenance, perform a complete operational test after reassembly to verify the burner operates correctly. Failure to verify operation could result in severe personal injury, death or substantial property damage.

Checking the ignitor

WARNING Never test an ignitor by placing a screwdriver (or other metallic object) across the high voltage clips. Check 40700 ignitors only by observing spark at appliance ignition electrodes, with fuel supply OFF. Using any other method could cause ignitor damage and severe personal injury.

Ceramic fiber materials

WARNING The appliance may contain ceramic fiber and/or fiberglass materials. Ceramic fiber materials, such as chamber liners, may contain carcinogenic particles (chrysothalites) after exposure to heat. Airborne particles from fiberglass or ceramic fiber components have been listed as potentially carcinogenic by the State of California. Take the following precautions when removing, replacing and handling these items.

Avoid breathing dust and avoid contact with skin or eyes. Wear long-sleeved, loose-fitting clothing, gloves and eye protection. Use a NIOSH N95 certified respirator. This respirator meets requirements for protection from chrysothalites. Actual job requirements or NIOSH regulations may require other or additional protection. For information, refer to the NIOSH website, <http://www.cdc.gov/niosh/homepage.html>.

Ceramic fiber removal: To prevent airborne dust, thoroughly wet ceramic fiber with water before handling. Place ceramic fiber materials in a plastic bag and seal to dispose.

Avoid blowing, tearing, sawing or spraying fiberglass or ceramic fiber materials. If such operations are necessary, wear extra protection to prevent breathing dust.

Wash work clothes separately from other laundry. Rinse clothes washer thoroughly afterwards to prevent contamination of other clothing.

NIOSH First aid procedures:

Eye exposure — irrigate immediately

Breathing — fresh air.



Limited Warranty

Carlin Combustion Technology, Inc. (Carlin) warrants its products, to the original purchaser, to be free from defects in material and workmanship, under normal use and service for 36 months from the date of manufacture, except for commercial Products (over 3 GPH) that are warranted for 12 months from the date of manufacture; and except for EZ-Pro™ Burners that are warranted for 36 months from the date of manufacture, plus an extended period of two (2) additional years (total of five (5) years).

This warranty does not extend to equipment subjected to misuse, neglect, accident or water damage; nor does this warranty apply unless the product covered by it is properly installed by a qualified, competent technician, who is licensed where state or local codes require, and who is experienced in making such installations, in accordance with NFPA No. 31 of the National Fire Protection Association and in accordance with all applicable local, state and national codes. Parts that are defective in material or workmanship and within the warranty period will be repaired or replaced as follows:

1. Motors, fuel units, transformers and other non-Carlin products should be sent for repair or replacement to an authorized service point or distributor of the manufacturer of such components when reasonably available in the Customer's locality.
2. Where such local service is not available with respect to the above listed components, or where Carlin components are involved, or for component parts of EZ-Pro Burners that fall within the extended warranty period, such defective parts should be returned, freight prepaid to Carlin. The repaired component or replacement part will be provided to the Customer freight prepaid by Carlin unless the returned part is determined by Carlin to be out of warranty or not to be defective, in which case it will be provided to the customer F.O.B., Carlin, East Longmeadow, Massachusetts.
3. Contact Carlin Customer Service for warranty return procedures.
4. The return of a burner is not covered by this warranty. Contact Carlin Tech Service for assistance before replacing any burner.
5. Carlin is not responsible for any labor cost for removal and replacement of equipment.
6. Equipment that is repaired or replaced will carry the unexpired portion of the original equipment warranty.
7. If inspection by Carlin does not disclose any defect covered by this warranty, the equipment may be repaired or replaced at the expense of the Customer, and Carlin's regular charges will apply.
8. Non-Carlin components are warranted for 12 months from date of installation or 18 months from date of manufacture, whichever date occurs first.

This warranty is limited to the precise terms set forth above, and provides exclusive remedies expressly in lieu of all other remedies and in particular there shall be excluded the implied warranties of merchantability and fitness for a particular purpose. In no event will Carlin Combustion Technology, Inc. be liable for any incidental or consequential damage of any nature. Carlin neither assumes nor authorizes any person to assume for Carlin any other liability or obligations in connection with the sale of this equipment. Carlin's liability and Customer's exclusive remedy being limited to repairs or replacement as set forth above.

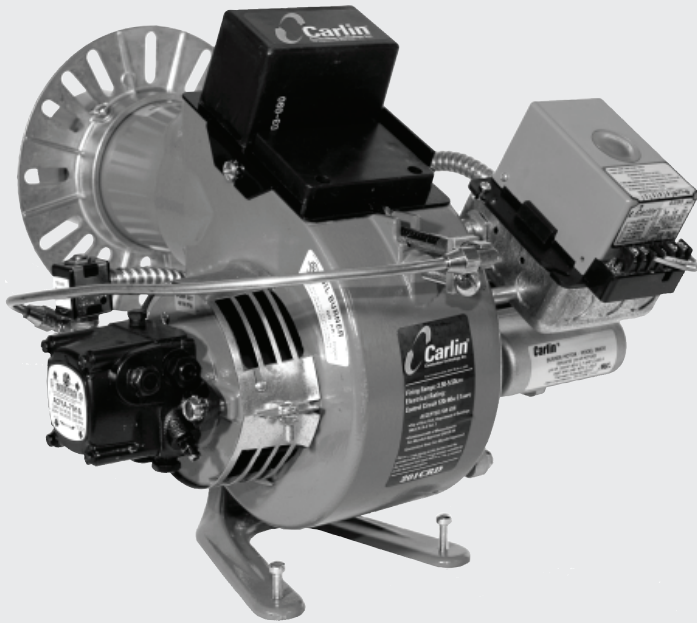

WARNING The burner must be cleaned, tested and adjusted annually by a qualified oil burner service technician.

WARNING **Should overheating occur:**

- (1) Shut off the oil supply to the burner.
- (2) DO NOT shut off the control switch to the circulator or blower.
- (3) Contact your oil dealer or service technician and the fire department (if needed).

201CRD & 301CRD burner

User care and maintenance

WARNING Refer only to the information on this page, intended for your use. The remainder of this manual is intended only for your service technician. Failure to comply could result in severe personal injury, death or substantial property damage.

For other than routine maintenance, contact a qualified service company. Perform the following as needed.

- Keep the area around the burner clear and free from combustible vapors and liquids.
- Do not obstruct the flow of combustion and ventilating air.
- Most motors currently used on residential type burners use permanently-lubricated bearings, and do not require field lubrication. Read the label on the motor to determine oiling needs, if any. Do not over-lubricate. This can cause as much trouble as not lubricating at all.

WARNING Never attempt to use gasoline as a fuel for this burner, as it is more combustible and could result in a serious explosion. Never attempt to burn refuse or use any fuel other than # 1 or # 2 heating oil (ASTM D396).