

We've got it.

# HVAC Product Catalog

Issue 22



Simplify your Work.™

1

PADS

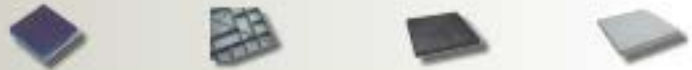

25

MOUNTING SYSTEMS



37

AIR MOVEMENT

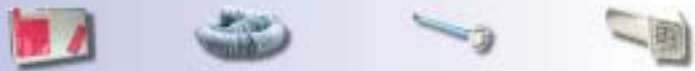

43

HEATING PRODUCTS

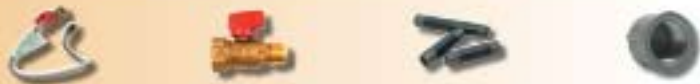

55

CONDENSATE MANAGEMENT



83

GENERAL INDUSTRIAL



95

DEVCO

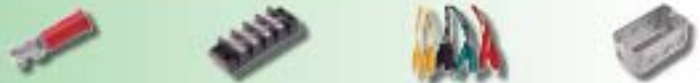

127

ELECTRICAL



167

TOOLS



185

PLUMBING

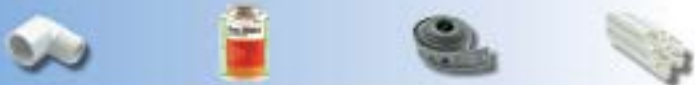

195

DUCTLESS SYSTEMS



205

MAINTENANCE CHEMICALS



231

INLINE COMPONENTS



249

DISTRIBUTOR SUPPORT





# PADS

|  |       |
|--|-------|
| Anti-Vibration Pads.....                           | 24    |
| Cladlite® Lightweight Equipment Pads.....          | 20    |
| E Lite® Plastic Equipment Pads.....                | 19    |
| EcoPad™.....                                       | 23    |
| Heat Pump Pads.....                                | 23    |
| Hef-T-Pad®.....                                    | 22    |
| The Black Pad®.....                                | 22    |
| The Hurricane Pad™.....                            | 21    |
| Ultralite® Lightweight Concrete Equipment Pads.... | 18-19 |

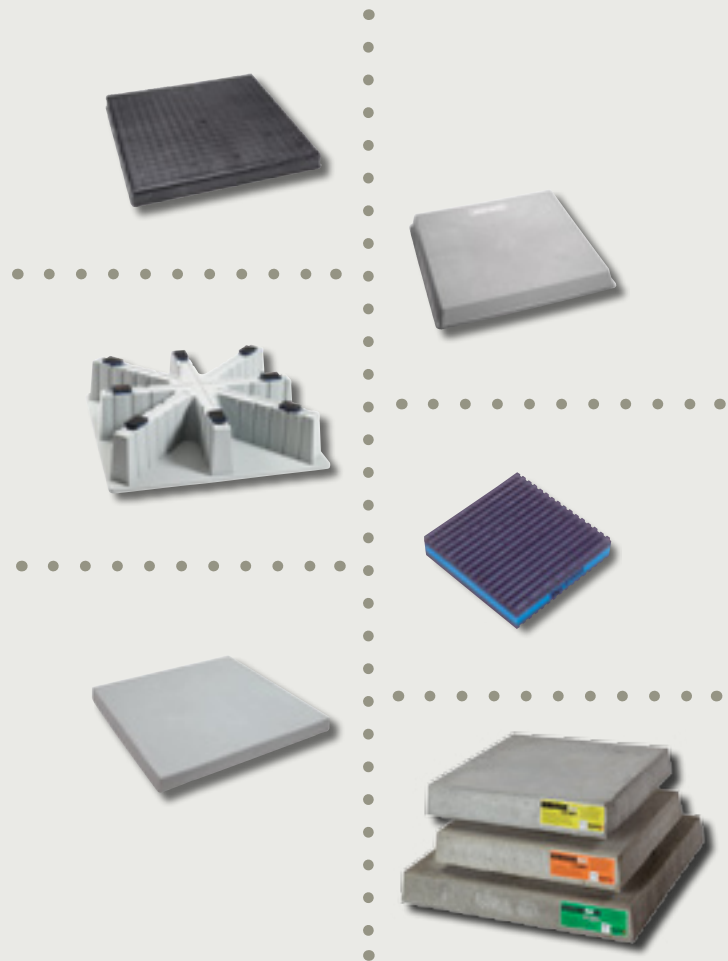

# E Lite® Plastic Equipment Pads

**E** Lite® is a plastic pad designed as a mounting base for equipment. The rugged design provides uniform and generous ribbing for optimum, self-leveling ground support without inserts. E Lite® is injection molded from polypropylene, resulting in a pad that is lightweight, but not too light. A subtle texture prevents unit slide and presents a classic appearance, which is enhanced by rounded edges and a concrete gray color. Each pad is molded with its size in raised letters.





## TECHNICAL DATA

### MATERIAL

Polypropylene

### FREEZE/THAW

Flawless performance under the 25-cycle regimen specified by ASTM C67

### CHEMICAL RESISTANCE

Does not crack, flake, or warp when tested per ASTM D2299 with the following:

- R-22 and R-134a
- Synthetic canine urine
- Compressor oil
- Salt solution, 20% by volume



Each pad is molded with its size in raised letters.

## FEATURES AND BENEFITS

- Lightweight, yet rugged
- Drillable for securing unit
- Uniform ribbing transfers load evenly
- Unaffected by UV or weather
- Subtle texture resists unit slide

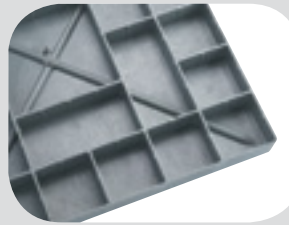

The bottom of an E Lite® pad shows extensive ribbing, plus additional surface support.



E Lite® plastic equipment pads are manufactured at DiversiTech's Conyers, Georgia plant.



# Hef-T-Pad® Equipment Pads

*Hef-T-Pad® is an injection molded equipment pad created from high impact polypropylene with UV inhibitors making it easy to handle, yet durable and strong. It does not require any additional equipment for moving and handling. Hef-T-Pad® is resistant to impact, ultraviolet degradation and weathering and will not crack, flake, or warp. It is virtually impervious to climatic variations. Hef-T-Pad® is drillable to permit installation of refrigerant and electrical lines under and through the pad and to allow equipment to be easily secured to the pad.*



## FEATURES AND BENEFITS OF THE HEF-T-PAD®

Stabilization foot increases the surface area for bearing stabilization on soil; reduces sinking in soft soil under heavy load. Support ribs provide structural support.



STABILIZATION FOOT

Stabilization flange provides a wide perimeter that reduces sinking in soft soil under heavy load. Both the flange and ribbing provide reinforcement for the corners.



STABILIZATION FLANGE

The thick walled polymer is suitable for drilling and screw fastening of equipment, line sets, and electrical connections.



DRILLABLE

Attractive neutral gray color with pad size and branding clearly embossed on pad surface.

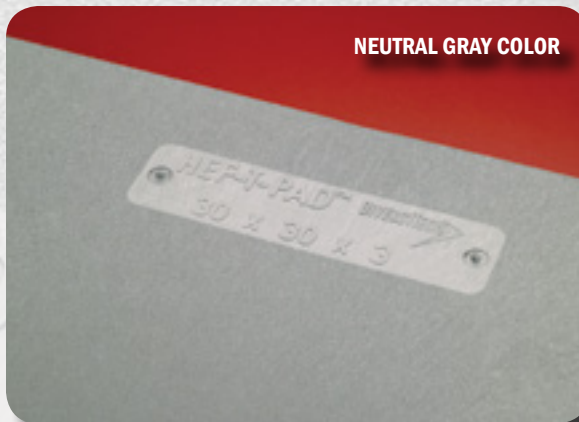

NEUTRAL GRAY COLOR

Textured surface provides good aesthetics and a non-skid surface.

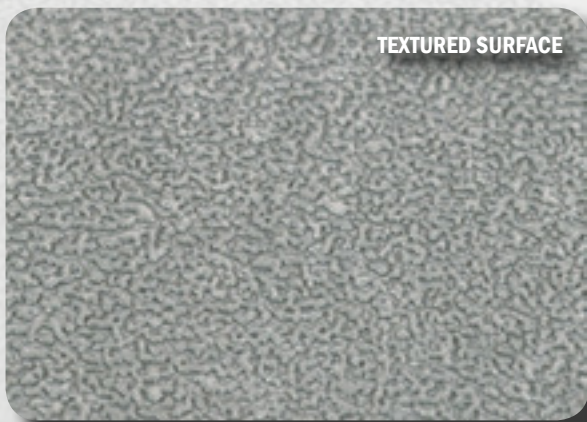

TEXTURED SURFACE

Pad size is molded into the side of the pad as well as the top surface.



PAD SIZE



# The Black Pad<sup>®</sup> replaces Concrete Equipment Bases

## Eco-friendly

**A**n innovative equipment base, The Black Pad<sup>®</sup> uses ground, recycled rubber in a co-injection process. The pad is extremely durable, resistant to ultraviolet light, and heavier than a completely plastic pad. The Black Pad<sup>®</sup> is ideal for pool and spa pumps, filters and heaters. The Black Pad<sup>®</sup> is extremely weather resistant and easy to drill and secure pool and spa equipment.





- No cracking and less breakage than concrete
- Extremely durable, yet lightweight
- UV resistant; unaffected by weather
- Generous ribbing for optimum, self-leveling ground support
- Outer edges have rounded corners with double-thick walls
- Uniform ribbing transfers load evenly
- Textured surface prevents equipment slippage
- Drillable for securing equipment
- Made of recycled material
- ICC Certified to Standard Swimming Pool Code sections 305.2 Mounting and section 405 Equipment Foundations and Enclosures.

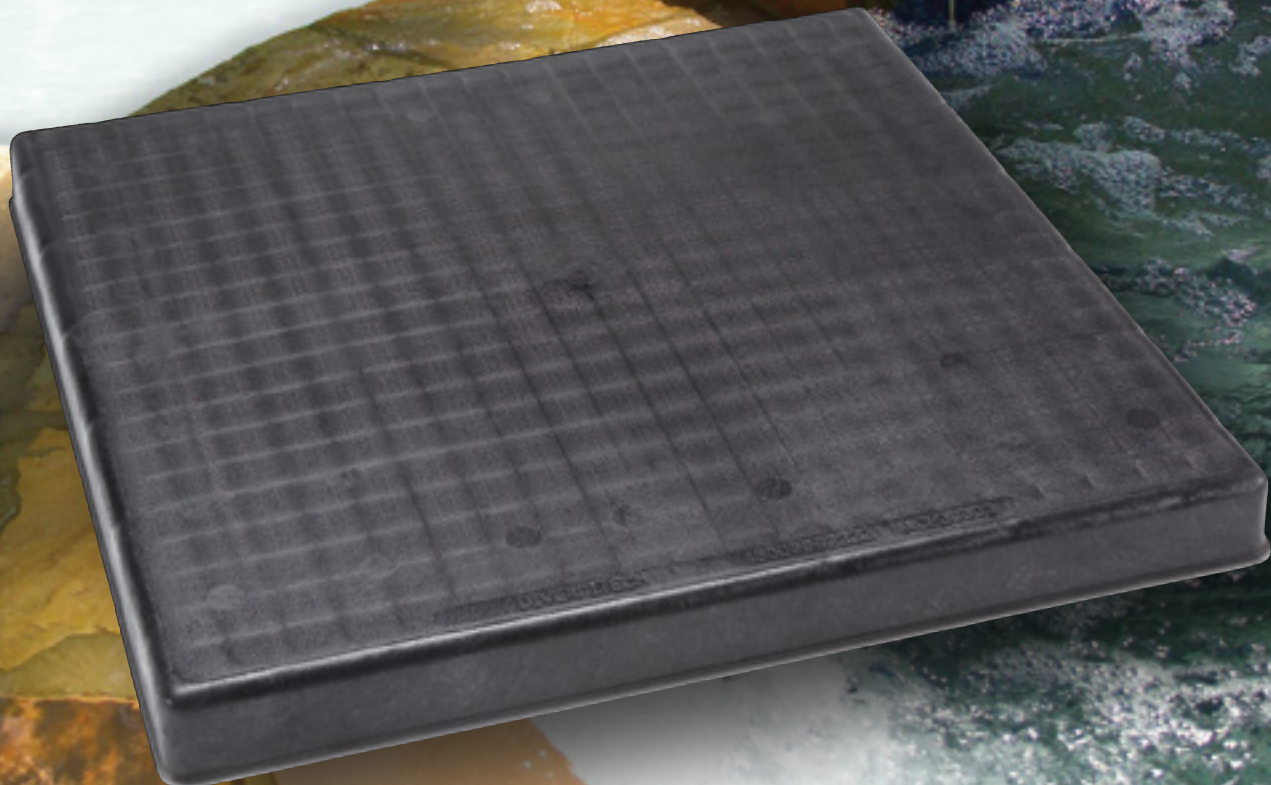
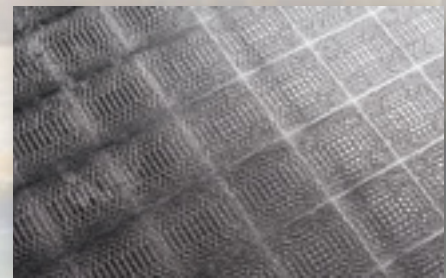
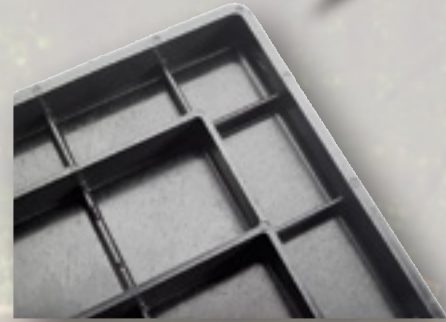



# UltraLite® Equipment Pads



- *Lightweight concrete pad*
- *Installs in seconds - easier and faster than pouring your own pad*
- *Engineered for long term outside weather resistance*
- *Will not degrade or discolor*
- *Freeze/thaw resistant - will not crack*

UltraLite® Pads are made by DiversiTech, North America's largest manufacturer of equipment pads.



## FEATURES AND BENEFITS

**LIGHTWEIGHT** At an average weight of 2-1/2 pounds per square foot (12 kg. per square metre), the UltraLite lightweight concrete pad is one of the lightest equipment mounting products available today. Lightweight products are important for ease of handling on job site.

**DURABLE** The exterior of the UltraLite lightweight concrete pad is specifically engineered for long-term exterior weather resistance.

**DUCTILE** The skin and core of the UltraLite lightweight concrete pad is specifically engineered for flexibility and ductility demanded of job site handling. Additionally, the ductility of the outer skin facilitates conformance to slight ground contours without fracture.

**TIME/LABOR SAVINGS** Time is money, and hence any time savings on site translates into money saved. The UltraLite lightweight concrete pad literally installs in seconds while providing a solid foundation for the condensing unit.

**CONCRETE SURFACE** The concrete external skin of the UltraLite lightweight concrete pad is not subject to ultraviolet degradation or weathering discoloration.

**VIBRATION ABSORBING** The engineered polystyrene core in the UltraLite lightweight concrete pad absorbs and dampens vibration associated with normal operation of a condensing unit.

**FREEZE/THAW RESISTANT** The UltraLite lightweight concrete pad is vapor permeable. Water vapor evaporates through the pad, hence the concrete outer skin is not subject to expansion cracks.

**FLAME RESISTANT** The concrete outer skin of the UltraLite lightweight concrete pad is resistant to heating caused by the compressor. Additionally, the surface is resistant to heat from incidental torch flame during site installation.

**OUTSIDE STORAGE** The UltraLite lightweight concrete pad is intended for life in the outdoors. As such, the pad is suitable for exterior storage prior to site installation.

## TECHNICAL DATA

### LOADING

To achieve the maximum permissible pad load capacity, the earth under the pad must be capable of supporting the transmitted compression load of the UltraLite pad. All values tabulated assume the earth has a bearing capacity of at least 1000 pounds per square foot (48 kPa).

The allowable loads assume a uniformly distributed loading on the pad surface (that is, a relatively flat-bottomed condenser unit in contact with the pad). For condenser units with footpads or other point loads, the maximum concentrated load for any size UltraLite pad is 125 pounds per 2" (56 kg per 50 mm) diameter (or equivalent surface area) footpad.

### CHEMICAL RESISTANCE

In normal usage conditions an equipment pad can be exposed to a variety of chemicals. The UltraLite pad has been fully tested in accordance with ASTM D2299 for resistance against:

- R-22 and R-134a
- Compressor oil
- Salt solution, 20 percent by volume
- Synthetic canine urine

The UltraLite pad performs extraordinarily well under these testing criteria. UltraLite does not craze, soften, delaminate, or spall under exposure in this test.

### FREEZE/THAW TESTING

The UltraLite pad has been independently tested to the rigorous freeze-thaw regimen specified by ASTM C67. This standard dictates a twenty-five cycle freeze-thaw sequence. The freeze portion of the sequence takes place with the top surface of the UltraLite pad under 1/2" (12 mm) of water. Once twenty-five cycles are complete, the pad is examined using visual magnification. No cracks or crazing is permitted. UltraLite has performed flawlessly.





# CladLite® Equipment Pads

CladLite® Equipment Pads provide the strength and durability customers demand in an easy to install pad. CladLite® Pads are up to 80% lighter than solid concrete but still provide rock solid support for equipment. Once it's set, so are you. CladLite® Pads stay in place and can withstand anything mother nature can throw at them. These pads provide superior resistance to sun, moisture, and freeze-thaw conditions. And the vibration dampening EPS foam core is unaffected by water, soil, fungus or bacteria. CladLite® Pads are available in 2" and 3" thickness and more than 70 different sizes so you can get the exact pad you need for the job. Get the concrete pads that homeowners prefer – CladLite®.



***Tough. Durable. Strong.***

CladLite® Equipment Pads provide the strength and durability customers demand in an easy to install pad. CladLite® Pads are up to 80% lighter than solid concrete but still provide rock solid support for equipment. Once it's set, so are you. CladLite® Pads stay in place and can withstand anything mother nature can throw at them. These pads provide superior resistance to sun, moisture, and freeze-thaw conditions. And the vibration dampening EPS foam core is unaffected by water, soil, fungus or bacteria. Cladlite® Pads are available in 2" and 3" thickness and more than 70 different sizes so you can get the exact pad you need for the job. Get the concrete pads that homeowners prefer – Cladlite®.

## CLADLITE® SPECIFICATIONS

Allowable Load: 125 lbs. per 2" diameter foot

Freeze/Thaw: Flawless performance under the 25-cycle regimen specified by ASTM C67

Chemical Resistance: Does not craze, soften, delaminate, or spall when tested per ASTM D2299 with the following:

- R-22 and R-134a
- Compressor oil
- Synthetic canine urine
- Salt solution, 20% by volume

Foam Core: ASTM Type 1 EPS

Flame Resistance:

Cladding resists compressor heat and incidental torch contact.

Not to be used under heating devices.





# Heat Pump Pad™



*Ideal for snowy climates, the new DiversiTech Heat Pump Pad™ is the perfect solution for protecting equipment and ensuring proper operation year round. The Heat Pump Pad™ provides*

*a full 8" clearance from ground level in a compact square footprint. Included with every Heat Pump Pad™ are 8 anti-vibration pads, specifically molded into slots in the pad to reduce vibration and provide quiet operation of your equipment. The base of the pad is also angled to direct melting snow or condensate away from the unit and pad. Heat Pump Pads are made from recycled polypropylene so they are eco-friendly and are built tough to provide many years of service. These pads also nest together for easier transportation and warehousing.*

Each Heat Pump Pad™ includes eight Anti-Vibration pads fitted into special slots in the risers to reduce equipment vibration and noise.

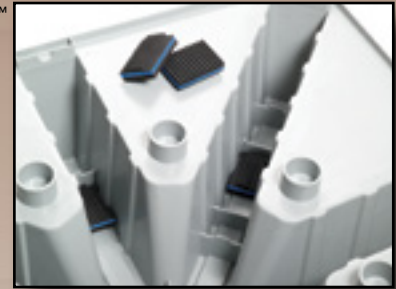

**Stackable!**









# The Hurricane Pad™

## THE HURRICANE PAD™ CONCRETE EQUIPMENT PAD

**Hurricane strength equipment pads designed to Florida's tough standards.**

DiversiTech's family of Hurricane Pads provide complete protection when the weather turns the worst. Three different models and dozens of sizes of The Hurricane Pad™ ensure you have the right pad for any area or need. Each DiversiTech Hurricane Pad™ includes these features:

- Steel reinforced
- 7,000 psi minimum concrete, mandatory to meet strict anchor pullout requirements
- Easier to install
- Will not float (unlike air filled pads)
- Uses standard Tapcon™ brand screws and no inserts are necessary
- Superior screw pullout strength



### FLORIDA BUILDING CODE NOTICE

This product meets the following Florida Building Code requirements:

1. Florida Building Commission (DCA02-DEC-183) declares this pad to be an acceptable alternative material to solid concrete pads.
2. This pad meets Mechanical Volume, Section 304.10 – clearance from grade.
3. Pad weight and wind load requirements have been calculated by Master Consulting Engineers. For up to date calculations and documentation, visit our website: [www.diversitech.com](http://www.diversitech.com).



## THE HURRICANE PAD™

The Hurricane Pad is designed for installations up to 150 MPH. The Hurricane Pad provides a solid base for mounting and protecting equipment threatened by adverse conditions.



## THE HURRICANE PAD™ T CLASS

The Hurricane Pad T-Class is designed for even higher wind loads - up to 175 MPH. Ideal for south Florida counties and other heavily threatened areas, the T Class Hurricane Pads are heavier and provide additional concrete for superior anchor pullout strength.



## THE HURRICANE PAD™ MD

The ultimate in protection, The Hurricane Pad MD is specifically designed for the strict regulations of Miami-Dade county. These solid concrete pads meet the Florida Building Code Notice and can withstand winds up to 175 MPH. This pad is made from a minimum 7000PSI solid concrete.



*Equipment must be properly attached to The Hurricane Pad™ in order to prevent sliding and tipping in high winds.*



# Anti-Vibration Pads

## EVA™ PAD: The BEST Performer

EVA™ (Extreme Vibration Attenuation) is the latest generation in vibration dampening technology. In the most severe vibration extremes, testing shows the EVA™ pad outperforms cork and rubber by greater than 3:1 and outperforms our competitor's "waffle" pad by greater than 8:1! The enhanced performance comes from the special composite foam center which is structurally more sound than cork. EVA™ is not affected by oils or chemicals that can break down cork and is much more effective at vibration dampening than solid rubber. Designed to withstand 50 psi. Choose EVA™ to get the best of both worlds!

ANTI-VIBRATION PAD PERFORMANCE

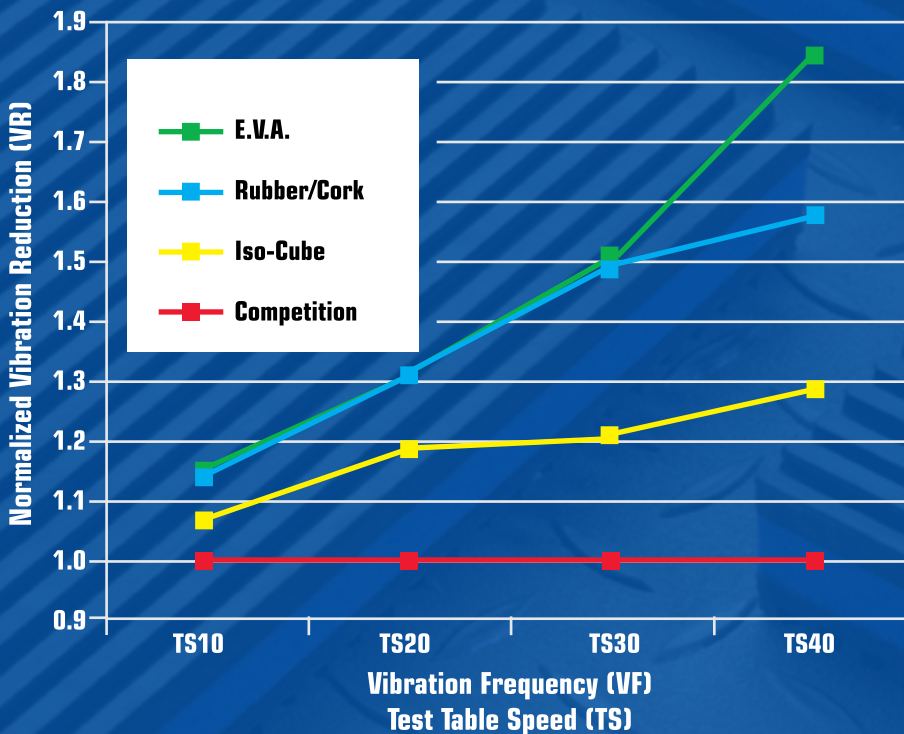



**RUBBER/CORK PAD:  
The Industry Standard**

These pads are made with the highest quality elastomeric oil resistant padding. Designed to withstand 50 psi. The rubber pads are corrugated on both sides and laminated to the cork center.

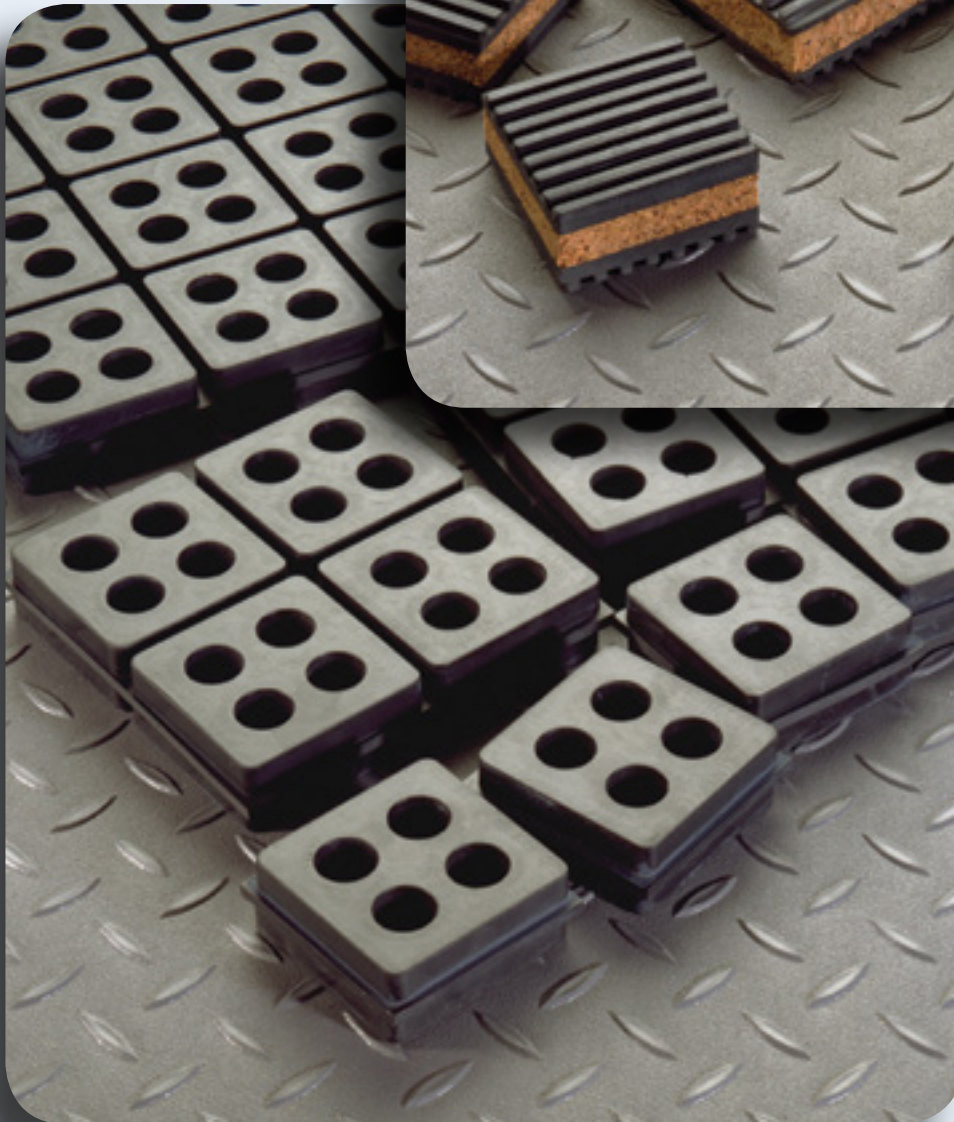
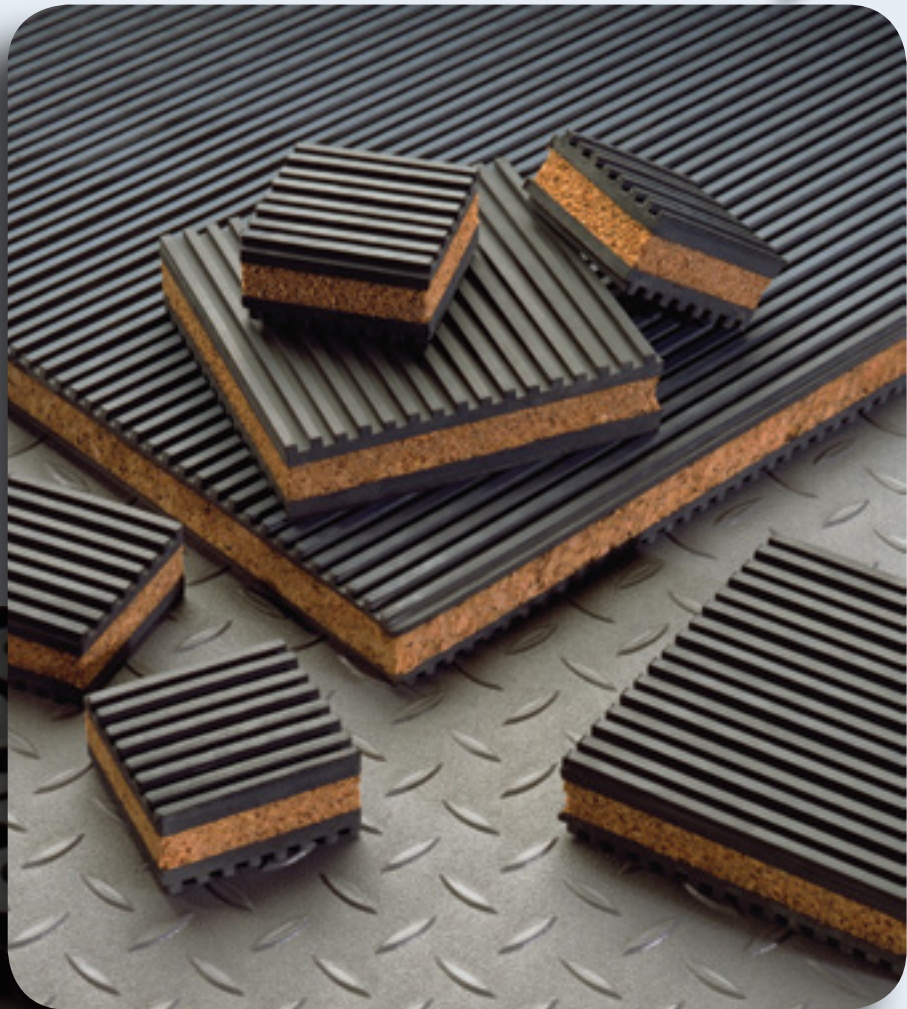

**ISO-CUBE:  
Solid Rubber Tough**

Natural rubber pads designed to reduce vibration and noise emanating from refrigeration or AC equipment. Circular design offers a suction cup effect eliminating the need to bolt the pads down. A standard 18" pad divides into eighty-one 2" segments which may be cut or torn into smaller pads. The 50 durometer pads will withstand a load of 180 psi with great resiliency.

**ULTRALITE® LIGHTWEIGHT CONCRETE EQUIPMENT PADS**

A true concrete equipment pad at the weight of plastic (about 2.5 lbs. per square foot). UltraLite® is strengthened by miles of fiber in each square foot of fiber-cement coating. This fiber allows the pad to flex instead of cracking or breaking. The textured surface prevents the condensing unit or portable generator from sliding, and allows water drainage, while the engineered expanded polystyrene (EPS) core prevents warping and provides a solid bottom to resist settling. Unaffected by soil conditions, ultraviolet (UV) light, temperature extremes, and other weather conditions.



**2" UltraLite® Pads**

The 2" thick UltraLite® pad is the industry standard. Used across a wide variety of applications. Codes have moved toward requiring 3" pads, check local codes for your requirements.

| CATALOG NO. | SIZE    | PAD WT. | PALLET QTY. | PALLET WT. | UOM | ORDER MULTIPLE |
|-------------|---------|---------|-------------|------------|-----|----------------|
| UC1636-2    | 16 X 36 | 11      | 40          | 250        | EA  | 40             |
| UC2424-2    | 24 X 24 | 15      | 20          | 323        | EA  | 20             |
| UC2430-2    | 24 X 30 | 17      | 20          | 361        | EA  | 20             |
| UC2436-2    | 24 X 36 | 22      | 20          | 455        | EA  | 20             |
| UC2448-2    | 24 X 48 | 18      | 20          | 385        | EA  | 20             |
| UC2626-2    | 26 X 26 | 17      | 20          | 365        | EA  | 20             |
| UC2628-2    | 26 X 28 | 19      | 20          | 397        | EA  | 20             |
| UC3030-2    | 30 X 30 | 21      | 20          | 441        | EA  | 20             |
| UC3036-2    | 30 X 36 | 27      | 20          | 571        | EA  | 20             |
| UC3040-2    | 30 X 40 | 30      | 20          | 617        | EA  | 20             |
| UC3143-2    | 31 X 43 | 26      | 20          | 551        | EA  | 20             |
| UC3232-2    | 32 X 32 | 24      | 20          | 501        | EA  | 20             |
| UC3434-2    | 34 X 34 | 23      | 20          | 493        | EA  | 20             |
| UC3445-2    | 34 X 45 | 45      | 20          | 915        | EA  | 20             |
| UC3636-2    | 36 X 36 | 27      | 20          | 555        | EA  | 20             |
| UC3640-2    | 36 X 40 | 29      | 20          | 608        | EA  | 20             |
| UC3648-2    | 36 X 48 | 35      | 20          | 725        | EA  | 20             |
| UC3842-2    | 38 X 42 | 30      | 20          | 625        | EA  | 20             |
| UC4040-2    | 40 X 40 | 32      | 20          | 644        | EA  | 20             |

U.S. Patents 7,334,385; 7,232,589; 6,931,822; 6,927,183; 5,728,458; 5,664,394; 5,268,226; 5,209,968, and patents pending. ICBO PFC-5112.

**3" UltraLite® Pads**

Where codes have moved toward requiring 3" pads, UltraLite® is the solution. Check local codes for your requirements.



| CATALOG NO. | SIZE    | PAD WT. | PALLET QTY. | PALLET WT. | UOM | ORDER MULTIPLE |
|-------------|---------|---------|-------------|------------|-----|----------------|
| UC1636-3    | 16 X 36 | 18      | 30          | 297        | EA  | 30             |
| UC1838-3    | 18 X 38 | 18      | 30          | 297        | EA  | 30             |
| UC2424-3    | 24 X 24 | 18      | 15          | 294        | EA  | 15             |
| UC2430-3    | 24 X 30 | 21      | 15          | 339        | EA  | 15             |
| UC2436-3    | 24 X 36 | 26      | 15          | 412        | EA  | 15             |
| UC2442-3    | 24 X 42 | 28      | 15          | 441        | EA  | 15             |
| UC2448-3    | 24 X 48 | 28      | 15          | 443        | EA  | 15             |
| UC2626-3    | 26 X 26 | 17      | 15          | 279        | EA  | 15             |
| UC3030-3    | 30 X 30 | 23      | 15          | 370        | EA  | 15             |
| UC3036-3    | 30 X 36 | 30      | 15          | 471        | EA  | 15             |
| UC3040-3    | 30 X 40 | 33      | 15          | 517        | EA  | 15             |
| UC3232-3    | 32 X 32 | 26      | 15          | 411        | EA  | 15             |
| UC3237-3    | 32 X 37 | 27      | 15          | 436        | EA  | 15             |
| U3353-3     | 33 X 53 | 68      | 15          | 1,045      | EA  | 15             |
| UC3434-3    | 34 X 34 | 27      | 15          | 427        | EA  | 15             |
| UC3445-3    | 34 X 45 | 39      | 15          | 612        | EA  | 15             |
| UC3636-3    | 36 X 36 | 34      | 15          | 528        | EA  | 15             |
| UC3642-3    | 36 X 42 | 32      | 15          | 510        | EA  | 15             |
| UC3648-3    | 36 X 48 | 37      | 15          | 579        | EA  | 15             |
| U3650-3     | 36 X 50 | 38      | 15          | 595        | EA  | 15             |
| U3654-3     | 36 X 54 | 71      | 15          | 1,096      | EA  | 15             |
| U3660-3     | 36 X 60 | 49      | 15          | 767        | EA  | 15             |
| U3678-3     | 36 X 78 | 99      | 15          | 1,510      | EA  | 15             |
| UC3842-3    | 38 X 42 | 35      | 15          | 550        | EA  | 15             |
| U3865-3     | 38 X 65 | 85      | 15          | 1,300      | EA  | 15             |
| U3870-3     | 38 X 70 | 113     | 15          | 1,720      | EA  | 15             |
| UC4040-3    | 40 X 40 | 34      | 15          | 510        | EA  | 15             |
| UC4042-3    | 40 X 42 | 36      | 15          | 565        | EA  | 15             |
| U4054-3     | 40 X 54 | 81      | 15          | 1,240      | EA  | 15             |
| UC4347-3    | 43 X 47 | 60      | 15          | 925        | EA  | 15             |
| U4550-3     | 45 X 50 | 81      | 15          | 1,240      | EA  | 15             |
| U4558-3     | 45 X 58 | 93      | 15          | 1,420      | EA  | 15             |
| U4848-3     | 48 X 48 | 85      | 15          | 1,300      | EA  | 15             |
| U4854-3     | 48 X 54 | 91      | 15          | 1,390      | EA  | 15             |
| U4866-3     | 48 X 66 | 108     | 15          | 1,645      | EA  | 15             |
| U5053-3     | 50 X 53 | 92      | 15          | 1,405      | EA  | 15             |
| U5056-3     | 50 X 56 | 97      | 15          | 1,480      | EA  | 15             |
| U5075-3     | 50 X 75 | 130     | 15          | 1,975      | EA  | 15             |
| U5079-3     | 50 X 79 | 145     | 15          | 2,200      | EA  | 15             |
| U5252-3     | 52 X 52 | 94      | 15          | 1,435      | EA  | 15             |
| U5260-3     | 52 X 60 | 109     | 15          | 1,660      | EA  | 15             |
| U5557-3     | 55 X 57 | 109     | 15          | 1,660      | EA  | 15             |
| U6067-3     | 60 X 67 | 134     | 15          | 2,035      | EA  | 15             |



### 3" UltraLite® Wedge Pads

The UltraLite® Wedge Pad is designed for Lennox condensing units.



UC3132-3L

| CATALOG NO.      | SIZE    | PAD WT. | PALLET QTY. | PALLET WT. | UOM | ORDER MULTIPLE |
|------------------|---------|---------|-------------|------------|-----|----------------|
| <b>UC3132-3L</b> | 31 X 32 | 23.33   | 15          | 350        | EA  | 15             |
| <b>UC3539-3L</b> | 35 X 39 | 33.46   | 15          | 502        | EA  | 15             |
| <b>UC4044-3L</b> | 40 X 44 | 37.53   | 15          | 563        | EA  | 15             |

### UltraLite® Earthquake Code Compliant Pads

Required nearly exclusively in Southern California, the UltraLite® pad is available for compliance with strict attachment provisions detailed in earthquake prone local building codes. UltraLite® earthquake code compliant pads are only available for sale in regions where local codes mandate installation of pads with these particular characteristics. Currently these locales include most of Southern California, portions of Washington, and portions of Oregon.



UC2424-3CA

| CATALOG NO.       | SIZE     | PAD WT. | PALLET QTY. | PALLET WT. | UOM | ORDER MULTIPLE |
|-------------------|----------|---------|-------------|------------|-----|----------------|
| <b>UC1838-3CA</b> | 18 X 38  | 18      | 15          | 273        | EA  | 15             |
| <b>UC2424-3CA</b> | 24 X 24  | 14      | 15          | 241        | EA  | 15             |
| <b>UC2436-3CA</b> | 24 X 36  | 22      | 15          | 349        | EA  | 15             |
| <b>UC2448-3CA</b> | 24 X 48* | 28      | 15          | 443        | EA  | 15             |
| <b>UC2636-3CA</b> | 26 X 36  | 29      | 15          | 428        | EA  | 15             |
| <b>UC3030-3CA</b> | 30 X 30  | 22      | 15          | 351        | EA  | 15             |
| <b>UC3036-3CA</b> | 30 X 36  | 25      | 15          | 400        | EA  | 15             |
| <b>UC3040-3CA</b> | 30 X 40  | 34      | 15          | 510        | EA  | 15             |
| <b>UC3232-3CA</b> | 32 X 32  | 24      | 15          | 381        | EA  | 15             |
| <b>UC3445-3CA</b> | 34 X 45  | 33      | 15          | 516        | EA  | 15             |
| <b>UC3636-3CA</b> | 36 X 36  | 28      | 15          | 441        | EA  | 15             |
| <b>UC3642-3CA</b> | 36 X 42  | 32      | 15          | 510        | EA  | 15             |
| <b>UC3648-3CA</b> | 36 X 48  | 37      | 15          | 579        | EA  | 15             |
| <b>UC4040-3CA</b> | 40 X 40  | 34      | 15          | 510        | EA  | 15             |

### E LITE® PLASTIC EQUIPMENT PADS

E Lite's rugged design provides uniform and generous ribbing for optimum, self-leveling ground support without inserts. The result is a pad that is lightweight, but not too light. A subtle texture prevents unit slide and presents a classic appearance, which is enhanced by rounded edges and a concrete gray color. Each pad is molded with a size label and a symbol representing content of recycled material.



### 2" E Lite® Pads

The 2" thick E Lite® pad is the choice for plastic pads. Codes have moved toward requiring 3" pads, check local codes for your requirements.

| CATALOG NO.     | SIZE    | PAD WT. | PALLET QTY. | PALLET WT. | UOM | ORDER MULTIPLE |
|-----------------|---------|---------|-------------|------------|-----|----------------|
| <b>EL2424-2</b> | 24 X 24 | 7       | 44          | 333        | EA  | 44             |
| <b>EL2430-2</b> | 24 X 30 | 9       | 22          | 219        | EA  | 22             |
| <b>EL2436-2</b> | 24 X 36 | 11      | 22          | 256        | EA  | 22             |
| <b>EL2626-2</b> | 26 X 26 | 8       | 22          | 205        | EA  | 22             |
| <b>EL3030-2</b> | 30 X 30 | 11      | 22          | 265        | EA  | 22             |
| <b>EL3036-2</b> | 30 X 36 | 13      | 22          | 313        | EA  | 22             |
| <b>EL3040-2</b> | 30 X 40 | 15      | 22          | 346        | EA  | 22             |
| <b>EL3232-2</b> | 32 X 32 | 13      | 22          | 300        | EA  | 22             |
| <b>EL3244-2</b> | 32 X 44 | 17      | 22          | 401        | EA  | 22             |
| <b>EL3434-2</b> | 34 X 34 | 14      | 22          | 350        | EA  | 22             |
| <b>EL3636-2</b> | 36 X 36 | 16      | 22          | 373        | EA  | 22             |
| <b>EL3640-2</b> | 36 X 40 | 18      | 22          | 410        | EA  | 22             |
| <b>EL3648-2</b> | 36 X 48 | 29      | 22          | 663        | EA  | 22             |
| <b>EL3842-2</b> | 38 X 42 | 19      | 22          | 470        | EA  | 22             |

### 3" E Lite® Pads

Codes have moved toward requiring 3" pads, check local codes for your requirements.



EL5658-3

| CATALOG NO.     | SIZE    | PAD WT. | PALLET QTY. | PALLET WT. | UOM | ORDER MULTIPLE |
|-----------------|---------|---------|-------------|------------|-----|----------------|
| <b>EL1838-3</b> | 18 X 38 | 16      | 32          | 300        | EA  | 32             |
| <b>EL2424-3</b> | 24 X 24 | 13      | 16          | 225        | EA  | 16             |
| <b>EL2436-3</b> | 24 X 36 | 19      | 16          | 321        | EA  | 16             |
| <b>EL3030-3</b> | 30 X 30 | 20      | 16          | 345        | EA  | 16             |
| <b>EL3232-3</b> | 32 X 32 | 21      | 16          | 353        | EA  | 16             |
| <b>EL3244-3</b> | 32 X 44 | 30      | 16          | 499        | EA  | 16             |
| <b>EL3636-3</b> | 36 X 36 | 28      | 16          | 471        | EA  | 16             |
| <b>EL3640-3</b> | 36 X 40 | 31      | 16          | 521        | EA  | 16             |
| <b>EL3648-3</b> | 36 X 48 | 36      | 16          | 601        | EA  | 16             |
| <b>EL3842-3</b> | 38 X 42 | 33      | 16          | 575        | EA  | 16             |
| <b>EL3870-3</b> | 38 X 70 | 36      | 16          | 604        | EA  | 16             |
| <b>EL4040-3</b> | 40 X 40 | 31      | 16          | 546        | EA  | 16             |
| <b>EL4558-3</b> | 45 X 58 | 33      | 16          | 545        | EA  | 16             |
| <b>EL4848-3</b> | 48 X 48 | 29      | 16          | 481        | EA  | 16             |
| <b>EL5252-3</b> | 52 X 52 | 48      | 16          | 793        | EA  | 16             |
| <b>EL5658-3</b> | 56 X 58 | 43      | 16          | 715        | EA  | 16             |

**CLADLITE® LIGHTWEIGHT CONCRETE EQUIPMENT PADS**

Concrete surface and superior performance at 20% the weight of conventional concrete pads. The cladding provides superior resistance to sun, moisture and freeze-thaw conditions; the engineered expanded polystyrene (EPS) core is virtually impervious to water, soil conditions, fungus and bacteria. Large CladLite® pads are further strengthened by continuous steel reinforcement throughout the cladding. CladLite® is code approved for installation throughout the U.S.

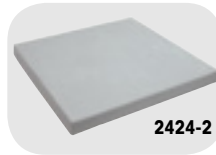

**2" CladLite® Pads**

The 2" thick CladLite® pad is the choice for equipment pads. Codes have moved toward requiring 3" pads, check local codes for your requirements.

| CATALOG NO. | SIZE     | PAD WT. | PALLET QTY. | PALLET WT. | UOM | ORDER MULTIPLE |
|-------------|----------|---------|-------------|------------|-----|----------------|
| 1636-2      | 16 X 36  | 33      | 25          | 850        | EA  | 25             |
| 2424-2      | 24 X 24  | 36      | 25          | 913        | EA  | 25             |
| 2436-2      | 24 X 36  | 50      | 25          | 1,275      | EA  | 25             |
| 2442-2      | 24 X 42  | 57      | 25          | 1,450      | EA  | 25             |
| 2454-2      | 24 X 54  | 84      | 25          | 2,125      | EA  | 25             |
| 26-2        | 26 Round | 31      | 25          | 800        | EA  | 25             |
| 2626-2      | 26 X 26  | 38      | 25          | 975        | EA  | 25             |
| 2660-2      | 26 X 60  | 95      | 25          | 2,400      | EA  | 25             |
| 30-2        | 30 Round | 36      | 25          | 925        | EA  | 25             |
| 3030-2      | 30 X 30  | 48      | 25          | 1,225      | EA  | 25             |
| 3036-2      | 30 X 36  | 60      | 25          | 1,525      | EA  | 25             |
| 3143-2      | 31 X 43  | 83      | 25          | 2,100      | EA  | 25             |
| 32-2        | 32 Round | 44      | 25          | 1,125      | EA  | 25             |
| 3232-2      | 32 X 32  | 54      | 25          | 1,375      | EA  | 25             |
| 3434-2      | 34 X 34  | 63      | 25          | 1,600      | EA  | 25             |
| 3636-2      | 36 X 36  | 76      | 25          | 1,925      | EA  | 25             |
| 3640-2      | 36 X 40  | 81      | 25          | 2,050      | EA  | 25             |
| 3648-2      | 36 X 48  | 115     | 25          | 2,900      | EA  | 25             |
| 3654-2      | 36 X 54  | 93      | 25          | 2,350      | EA  | 25             |

**3" CladLite® Pads**

Used where codes have moved toward requiring 3" pads, check local codes for your requirements.



| CATALOG NO. | SIZE     | PAD WT. | PALLET QTY. | PALLET WT. | UOM | ORDER MULTIPLE |
|-------------|----------|---------|-------------|------------|-----|----------------|
| 1636-3      | 16 X 36  | 46      | 20          | 945        | EA  | 20             |
| 2424-3      | 24 X 24  | 49      | 20          | 995        | EA  | 20             |
| 2436-3      | 24 X 36  | 63      | 20          | 1,285      | EA  | 20             |
| 2448-3      | 24 X 48  | 71      | 20          | 1,445      | EA  | 20             |
| 2460-3      | 24 X 60  | 105     | 20          | 2,125      | EA  | 20             |
| 2626-3      | 26 X 26  | 53      | 20          | 1,085      | EA  | 20             |
| 3030-3      | 30 X 30  | 62      | 20          | 1,265      | EA  | 20             |
| 3036-3      | 30 X 36  | 71      | 20          | 1,445      | EA  | 20             |
| 3060-3      | 30 X 60  | 130     | 15          | 1,975      | EA  | 15             |
| 3143-3      | 31 X 43  | 74      | 20          | 1,505      | EA  | 20             |
| 32-3        | 32 Round | 67      | 20          | 1,365      | EA  | 20             |
| 3232-3      | 32 X 32  | 68      | 20          | 1,385      | EA  | 20             |
| 3237-3      | 32 X 37  | 87      | 20          | 1,765      | EA  | 20             |
| 3345-3      | 33 X 45  | 117     | 20          | 2,365      | EA  | 20             |
| 3636-3      | 36 X 36  | 100     | 20          | 2,025      | EA  | 20             |
| 3640-3      | 36 X 40  | 120     | 20          | 2,425      | EA  | 20             |
| 3648-3      | 36 X 48  | 132     | 20          | 2,665      | EA  | 20             |
| 3650-3      | 36 X 50  | 137     | 15          | 2,080      | EA  | 15             |
| 3660-3      | 36 X 60  | 163     | 15          | 2,470      | EA  | 15             |
| 3678-3      | 36 X 78  | 196     | 10          | 1,985      | EA  | 10             |
| 3842-3      | 38 X 42  | 132     | 20          | 2,700      | EA  | 20             |
| 3870-3      | 38 X 70  | 179     | 10          | 1,815      | EA  | 10             |
| 4042-3      | 40 X 42  | 170     | 10          | 1,700      | EA  | 10             |
| 4054-3      | 40 X 54  | 167     | 15          | 2,530      | EA  | 15             |
| 4062-3      | 40 X 62  | 179     | 10          | 1,815      | EA  | 10             |
| 4147-3      | 41 X 47  | 140     | 15          | 2,125      | EA  | 15             |
| 4183-3      | 41 X 83  | 231     | 10          | 2,335      | EA  | 10             |
| 4550-3      | 45 X 50  | 158     | 15          | 2,395      | EA  | 15             |
| 4558-3      | 45 X 58  | 177     | 15          | 2,680      | EA  | 15             |
| 4766-3      | 47 X 66  | 219     | 10          | 2,215      | EA  | 10             |
| 4848-3      | 48 X 48  | 150     | 15          | 2,275      | EA  | 15             |
| 5053-3      | 50 X 53  | 194     | 15          | 2,935      | EA  | 15             |
| 5056-3      | 50 X 56  | 212     | 10          | 2,145      | EA  | 10             |
| 5058-3      | 50 X 58  | 212     | 10          | 2,145      | EA  | 10             |
| 5070-3      | 50 X 70  | 257     | 10          | 2,595      | EA  | 10             |
| 5252-3      | 52 X 52  | 197     | 10          | 1,995      | EA  | 10             |
| 5557-3      | 55 X 57  | 237     | 10          | 2,395      | EA  | 10             |
| 6067-3      | 60 X 67  | 284     | 10          | 2,865      | EA  | 10             |



**THE HURRICANE PAD™ CONCRETE EQUIPMENT PADS**

**The Hurricane Pad™**

Designed specifically for the hurricane prone regions of Florida and the Gulf Coast, The Hurricane Pad™ meets stringent local code requirements for wind resistance. Heavier than a normal concrete pad, this 4" pad provides sufficient weight to meet code. The Hurricane Pad meets the Florida Building Code Notice and can withstand winds up to 150 MPH. For certain taller equipment, The Hurricane T Class Pad™ is needed. Due to their extra weight, standard freight terms only apply for shipments to Florida. All other shipments are shipped FOB Conyers, GA.

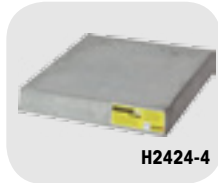

**H2424-4**

**The Hurricane T-Class Pad™**

The Hurricane T Class Pad™ is even heavier than The Hurricane Pad™ and is designed to meet the higher wind loads of taller equipment. The taller the piece of equipment mounted to the pad, the greater the wind load on the pad. These heavier 4" pads provide sufficient weight to meet code for these taller condensing units. The Hurricane T-Class Pad meets the Florida Building Code Notice and can withstand winds up to 175 MPH. Due to their extra weight, standard freight terms for The Hurricane T Class Pad™ only apply for shipments to Florida. All other shipments are shipped FOB Conyers, GA.



**HT2424-4**

| CATALOG NO.    | SIZE    | PALLET QTY. | UOM | ORDER MULTIPLE |
|----------------|---------|-------------|-----|----------------|
| <b>H1840-4</b> | 18 X 40 | 16          | EA  | 16             |
| <b>H2424-4</b> | 24 X 24 | 16          | EA  | 16             |
| <b>H2436-4</b> | 24 X 36 | 16          | EA  | 16             |
| <b>H3030-4</b> | 30 X 30 | 16          | EA  | 16             |
| <b>H3232-4</b> | 32 X 32 | 16          | EA  | 16             |
| <b>H3345-4</b> | 33 X 45 | 16          | EA  | 16             |
| <b>H3636-4</b> | 36 X 36 | 16          | EA  | 16             |
| <b>H3642-4</b> | 36 X 42 | 16          | EA  | 16             |
| <b>H3648-4</b> | 36 X 48 | 16          | EA  | 16             |
| <b>H3652-4</b> | 36 X 52 | 8           | EA  | 8              |
| <b>H3654-4</b> | 36 X 54 | 8           | EA  | 8              |
| <b>H3672-4</b> | 36 X 72 | 8           | EA  | 8              |
| <b>H3842-4</b> | 38 X 42 | 8           | EA  | 8              |
| <b>H3852-4</b> | 38 X 52 | 8           | EA  | 8              |
| <b>H3865-4</b> | 38 X 65 | 8           | EA  | 8              |
| <b>H3872-4</b> | 38 X 72 | 8           | EA  | 8              |
| <b>H4040-4</b> | 40 X 40 | 8           | EA  | 8              |
| <b>H4242-4</b> | 42 X 42 | 8           | EA  | 8              |
| <b>H4558-4</b> | 45 X 58 | 8           | EA  | 8              |
| <b>H5557-4</b> | 55 X 57 | 8           | EA  | 8              |

| CATALOG NO.     | SIZE    | PALLET QTY. | UOM | ORDER MULTIPLE |
|-----------------|---------|-------------|-----|----------------|
| <b>HT1840-4</b> | 18 X 24 | 10          | EA  | 10             |
| <b>HT2424-4</b> | 24 X 24 | 5           | EA  | 5              |
| <b>HT2436-4</b> | 24 X 36 | 5           | EA  | 5              |
| <b>HT3030-4</b> | 30 X 30 | 5           | EA  | 5              |
| <b>HT3232-4</b> | 32 X 32 | 5           | EA  | 5              |
| <b>HT3345-4</b> | 33 X 45 | 5           | EA  | 5              |
| <b>HT3636-4</b> | 36 X 36 | 5           | EA  | 5              |
| <b>HT3648-4</b> | 36 X 48 | 5           | EA  | 5              |
| <b>HT3656-4</b> | 36 X 56 | 5           | EA  | 5              |
| <b>HT3842-4</b> | 38 X 42 | 5           | EA  | 5              |
| <b>HT3852-4</b> | 38 X 52 | 5           | EA  | 5              |
| <b>HT4040-4</b> | 40 X 40 | 5           | EA  | 5              |
| <b>HT4242-4</b> | 42 X 42 | 5           | EA  | 5              |
| <b>HT4558-4</b> | 45 X 58 | 5           | EA  | 5              |

**Potential Hurricane Winds Map**

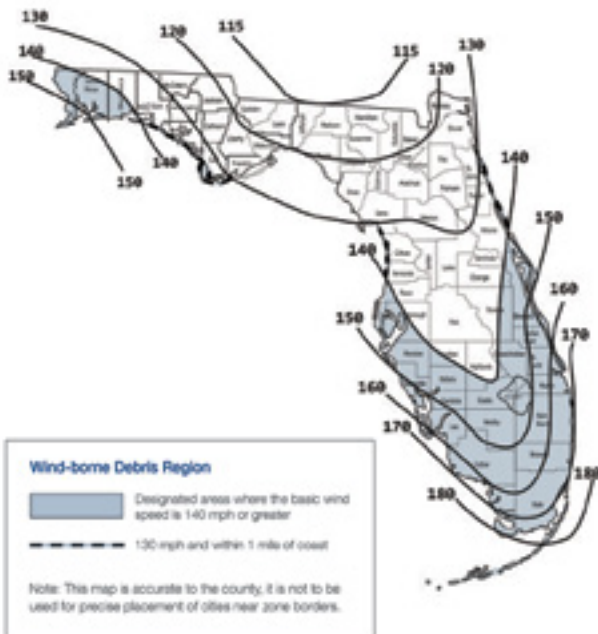

**The Hurricane Pad™ MD**

The new Hurricane Pad™ MD is the newest in concrete pad technology from DiversiTech. The Hurricane Pad MD is a solid concrete pad designed for the strict requirements of Miami Dade county. The Hurricane Pad MD meets the Florida Building Code Notice and can withstand winds up to 175 MPH. This pad is made from a minimum 7000PSI solid concrete. For Florida shipments only.



**HMD3030-4**

| CATALOG NO.      | SIZE        | PALLET QTY. | UOM | ORDER MULTIPLE |
|------------------|-------------|-------------|-----|----------------|
| <b>HMD1844-4</b> | 18 X 40 X 4 | 5           | EA  | 5              |
| <b>HMD2436-4</b> | 24 X 36 X 4 | 5           | EA  | 5              |
| <b>HMD3030-4</b> | 30 X 30 X 4 | 5           | EA  | 5              |
| <b>HMD3636-4</b> | 36 X 36 X 4 | 5           | EA  | 5              |
| <b>HMD3648-4</b> | 36 X 48 X 4 | 5           | EA  | 5              |
| <b>HMD3842-4</b> | 38 X 42 X 4 | 5           | EA  | 5              |
| <b>HMD4040-4</b> | 40 X 40 X 4 | 5           | EA  | 5              |

**The Hurricane Pad Attachment Bracket**

Bracket secures condenser to The Hurricane Pad. Use #8 self drilling or self tapping screws to secure condenser to brackets. Be sure to place brackets according to local building code requirements. Made of 12 gauge ASTM A653 Grade 40 steel with G90 coating.



**HC-1**

| CATALOG NO.     | DESCRIPTION  | UOM | ORDER MULTIPLE |
|-----------------|--|-----|----------------|
| <b>HC-1</b>     | The Hurricane Pad Attachment Bracket, pack of 4 PK   | PK  | 1              |
| <b>HC-1-100</b> | The Hurricane Pad Attachment Bracket, pack of 100 PK | PK  | 1              |

## THE BLACK PAD® BLACK PLASTIC EQUIPMENT PADS

The Black Pad® is an innovative equipment pad. The pad is extremely durable, resistant to ultraviolet light, and heavier than a completely plastic pad. The Black Pad® is suitable for use with pool pumps, filters, and heaters and complies with the 1997 Standard Swimming Pool Code sections 305.2 Mounting and section 405 Equipment Foundations and Enclosures.



ACP24242

### The Black Pad® — 3"

Used where codes have moved toward requiring 3" pads. Check local codes for your requirements.

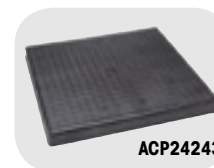

ACP24243

### The Black Pad® — 2"

The 2" thick Black Pad® is the choice for plastic pads. Codes have moved toward requiring 3" pads, check local codes for your requirements.

| CATALOG NO.     | SIZE    | PAD WT. | PALLET QTY. | PALLET WT. | UOM | ORDER MULTIPLE |
|-----------------|---------|---------|-------------|------------|-----|----------------|
| <b>ACP24242</b> | 24 X 24 | 10      | 24          | 240        | EA  | 24             |
| <b>ACP24362</b> | 24 X 36 | 15      | 24          | 360        | EA  | 24             |
| <b>ACP30302</b> | 30 X 30 | 13      | 24          | 312        | EA  | 24             |
| <b>ACP32322</b> | 32 X 32 | 16      | 24          | 384        | EA  | 24             |
| <b>ACP36362</b> | 36 X 36 | 19      | 24          | 456        | EA  | 24             |
| <b>ACP38422</b> | 38 X 42 | 25      | 24          | 600        | EA  | 24             |

| CATALOG NO.     | SIZE    | PAD WT. | PALLET QTY. | PALLET WT. | UOM | ORDER MULTIPLE |
|-----------------|---------|---------|-------------|------------|-----|----------------|
| <b>ACP24243</b> | 24 X 24 | 12      | 16          | 192        | EA  | 16             |
| <b>ACP30303</b> | 30 X 30 | 20      | 16          | 320        | EA  | 16             |
| <b>ACP32323</b> | 32 X 32 | 25      | 16          | 400        | EA  | 16             |
| <b>ACP36363</b> | 36 X 36 | 23      | 16          | 368        | EA  | 16             |
| <b>ACP36483</b> | 36 X 48 | 37      | 16          | 592        | EA  | 16             |

## HEF-T-PAD™ PLASTIC EQUIPMENT PADS

Hef-T-Pad® is an injection molded equipment pad created from high impact polypropylene with UV inhibitors making it easy to handle, yet durable and strong. It does not require any additional equipment for moving and handling. It is resistant to impact, ultra violet degradation and weathering and will not crack, flake, or warp. The Hef-T-Pad® is virtually impervious to climatic variations. It is drillable to permit installation of refrigerant and electrical lines under and through the pad and to allow equipment to be easily secured to the pad.

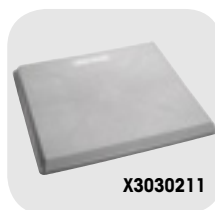

X3030211

### Hef-T-Pad® — 3"

Used where codes have moved toward requiring 3" pads. Check local codes for your requirements.

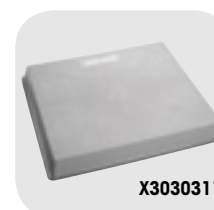

X3030311

### Hef-T-Pad® — 2"

The 2" thick Hef-T-Pad® is the choice for plastic pads. Codes have moved toward requiring 3" pads, check local codes for your requirements.

| CATALOG NO.     | SIZE        | PAD WT. | PALLET QTY. | PALLET WT. | UOM | ORDER MULTIPLE |
|-----------------|-------------|---------|-------------|------------|-----|----------------|
| <b>X2424211</b> | 24 X 24 X 2 | 6       | 24          | 208        | EA  | 24             |
| <b>X2430211</b> | 24 X 30 X 2 | 8       | 24          | 251        | EA  | 24             |
| <b>X2436211</b> | 24 X 36 X 2 | 10      | 24          | 290        | EA  | 24             |
| <b>X3030211</b> | 30 X 30 X 2 | 10      | 24          | 290        | EA  | 24             |
| <b>X3232211</b> | 32 X 32 X 2 | 11      | 24          | 312        | EA  | 24             |
| <b>X3244211</b> | 32 X 44 X 2 | 14      | 24          | 382        | EA  | 24             |
| <b>X3636211</b> | 36 X 36 X 2 | 13      | 24          | 367        | EA  | 24             |
| <b>X3836211</b> | 38 X 36 X 2 | 14      | 24          | 376        | EA  | 24             |
| <b>X3842211</b> | 38 X 42 X 2 | 17      | 24          | 464        | EA  | 24             |

| CATALOG NO.     | SIZE        | PAD WT. | PALLET QTY. | PALLET WT. | UOM | ORDER MULTIPLE |
|-----------------|-------------|---------|-------------|------------|-----|----------------|
| <b>X2424311</b> | 24 X 24 X 3 | 9       | 16          | 200        | EA  | 16             |
| <b>X2436311</b> | 24 X 36 X 3 | 12      | 16          | 242        | EA  | 16             |
| <b>X3030311</b> | 30 X 30 X 3 | 13      | 16          | 264        | EA  | 16             |
| <b>X3232311</b> | 32 X 32 X 3 | 16      | 16          | 300        | EA  | 16             |
| <b>X3636311</b> | 36 X 36 X 3 | 17      | 16          | 319        | EA  | 16             |
| <b>X3848311</b> | 38 X 48 X 3 | 24      | 16          | 400        | EA  | 16             |



## ECOPAD™ BLACK PLASTIC EQUIPMENT PADS

An injection molded equipment pad created from 100% recycled materials to minimize environmental impact. It does not require any additional equipment for moving and handling. EcoPad™ is resistant to impact, ultra-violet degradation and weathering (virtually impervious to climatic variations), and will not crack, flake, or warp. Drillable to permit installation of refrigerant and electrical lines under and through the pad and to allow equipment to easily secure to the pad.



EP2424-2

### EcoPad™ — 3"

Used where codes have moved toward requiring 3" pads, check local codes for your requirements.



EP2424-3

### EcoPad™ — 2"

The 2" thick EcoPad™ is the choice for plastic pads. Codes have moved toward requiring 3" pads, check local codes for your requirements.

| CATALOG NO. | SIZE        | PAD WT. | PALLET QTY. | PALLET WT. | UOM | ORDER MULTIPLE |
|-------------|-------------|---------|-------------|------------|-----|----------------|
| EP2424-2    | 24 X 24 X 2 | 6       | 24          | 208        | EA  | 24             |
| EP2436-2    | 24 X 36 X 2 | 10      | 24          | 240        | EA  | 24             |
| EP3030-2    | 30 X 30 X 2 | 10      | 24          | 290        | EA  | 24             |
| EP3232-2    | 32 X 32 X 2 | 11      | 24          | 312        | EA  | 24             |
| EP3244-2    | 32 X 44 X 2 | 14      | 24          | 382        | EA  | 24             |
| EP3636-2    | 36 X 36 X 2 | 13      | 24          | 367        | EA  | 24             |
| EP3842-2    | 38 X 42 X 2 | 17      | 24          | 450        | EA  | 24             |

| CATALOG NO. | SIZE        | PAD WT. | PALLET QTY. | PALLET WT. | UOM | ORDER MULTIPLE |
|-------------|-------------|---------|-------------|------------|-----|----------------|
| EP1838-3    | 18 X 38 X 3 | 10      | 32          | 166        | EA  | 32             |
| EP2424-3    | 24 X 24 X 3 | 9       | 16          | 200        | EA  | 16             |
| EP3030-3    | 30 X 30 X 3 | 13      | 16          | 264        | EA  | 16             |
| EP3232-3    | 32 X 32 X 3 | 16      | 16          | 300        | EA  | 16             |
| EP3244-3    | 32 X 44 X 3 | 14      | 16          | 273        | EA  | 16             |
| EP3636-3    | 36 X 36 X 3 | 17      | 16          | 319        | EA  | 16             |
| EP3648-3    | 36 X 48 X 3 | 23      | 16          | 368        | EA  | 16             |
| EP3842-3    | 38 X 42 X 3 | 20      | 16          | 323        | EA  | 16             |
| EP4040-3    | 40 X 40 X 3 | 28      | 16          | 496        | EA  | 16             |

## HEAT PUMP PAD™

### Heat Pump Pad™

Provides an effective base for heat pump equipment installed in snowy climates. Rather than a combination of a typical 2" (or 3") equipment pad and 6" heat pump risers, the Heat Pump Pad™ provides a full 8" of elevation in a simple square footprint. The star pattern of the integral risers allows for installation of equipment with different size footprints up to 36" x 36". Also included are eight anti vibration pads uniquely designed to fit into the guide slots on the top of the integral risers. The base is sloped outward to allow for easy drainage of condensate or defrost cycle condensate when the outdoor coil is operating in heat pump mode. Nestable for efficient shipping, transportation, and warehousing. Injection molded from concrete gray, recycled polypropylene material, the Heat Pump Pad™ is environmentally friendly and designed to last longer than the equipment it supports. US Patent Number 7,891,635, and other patent(s) pending.



HP3232-8

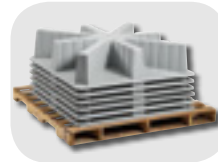

**Stackable!**

| CATALOG NO. | DESCRIPTION    | UOM | ORDER MULTIPLE |
|-------------|----------------|-----|----------------|
| HP3232-8    | 32" x 32" x 8" | EA  | 16             |
| HP3636-8    | 36" x 36" x 8" | EA  | 16             |

ANTI-VIBRATION PADS

**E.V.A. Anti-Vibration Pad**

The latest generation in vibration dampening technology. The most effective vibration dampening pad available on the market. The EVA Pad was tested against other pads at four different vibration settings. In the most severe vibration extremes, the EVA Pad outperforms cork and rubber by a margin of greater than 3:1! This is due to the special composite foam center which is much more structurally sound than cork. It is not affected by oils or chemicals that can break down cork and is much more effective at vibration dampening than solid rubber. All this at a very competitive price. Designed to withstand 50 psi.

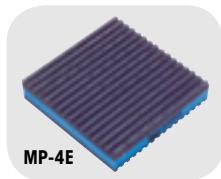

| CATALOG NO.   | DESCRIPTION                 | UOM | ORDER MULTIPLE |
|---------------|-----------------------------|-----|----------------|
| <b>MP-2E</b>  | 2" x 2" x 7/8" E.V.A. Pad   | EA  | 48             |
| <b>MP-3E</b>  | 3" x 3" x 7/8" E.V.A. Pad   | EA  | 36             |
| <b>MP-4E</b>  | 4" x 4" x 7/8" E.V.A. Pad   | EA  | 24             |
| <b>MP-6E</b>  | 6" x 6" x 7/8" E.V.A. Pad   | EA  | 24             |
| <b>MP-12E</b> | 12" x 12" x 7/8" E.V.A. Pad | EA  | 12             |
| <b>MP-18E</b> | 18" x 18" x 7/8" E.V.A. Pad | EA  | 6              |

**Rubber Anti-Vibration Pad**

Highest quality elastomeric oil resistant padding. Designed to withstand 50 lbs. psi. The rubber pads are corrugated on both sides. Ideal for air conditioners, compressors, cooling towers, presses, machines, etc.

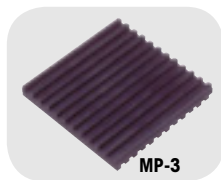

| CATALOG NO.  | DESCRIPTION             | UOM | ORDER MULTIPLE |
|--------------|-------------------------|-----|----------------|
| <b>MP-2</b>  | 2" x 2" x 3/8" Rubber   | EA  | 48             |
| <b>MP-3</b>  | 3" x 3" x 3/8" Rubber   | EA  | 36             |
| <b>MP-4</b>  | 4" x 4" x 3/8" Rubber   | EA  | 24             |
| <b>MP-6</b>  | 6" x 6" x 3/8" Rubber   | EA  | 24             |
| <b>MP-8</b>  | 8" x 8" x 3/8" Rubber   | EA  | 12             |
| <b>MP-12</b> | 12" x 12" x 3/8" Rubber | EA  | 12             |
| <b>MP-18</b> | 18" x 18" x 3/8" Rubber | EA  | 6              |

**Rubber/Cork Anti-Vibration Pad**

Highest quality elastomeric oil resistant padding. Designed to withstand 50 psi. The rubber pads are corrugated on both sides. The cork is laminated between two corrugated pads. Ideal for air conditioners, compressors, cooling towers, presses, machines, etc.

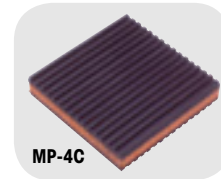

| CATALOG NO.   | DESCRIPTION                  | UOM | ORDER MULTIPLE |
|---------------|------------------------------|-----|----------------|
| <b>MP-2C</b>  | 2" x 2" x 7/8" Rubber/Cork   | EA  | 48             |
| <b>MP-3C</b>  | 3" x 3" x 7/8" Rubber/Cork   | EA  | 36             |
| <b>MP-4C</b>  | 4" x 4" x 7/8" Rubber/Cork   | EA  | 24             |
| <b>MP-6C</b>  | 6" x 6" x 7/8" Rubber/Cork   | EA  | 24             |
| <b>MP-8C</b>  | 8" x 8" x 7/8" Rubber/Cork   | EA  | 12             |
| <b>MP-12C</b> | 12" x 12" x 7/8" Rubber/Cork | EA  | 12             |
| <b>MP-18C</b> | 18" x 18" x 7/8" Rubber/Cork | EA  | 6              |

**Iso-Cube Economy Anti-Vibration Pad**

Natural rubber pads, designed to reduce vibration and noise emanating from refrigeration and air conditioning equipment. The circular design in each pad offers a suction cup effect, which eliminates the need to bolt the pads down. A standard 18" (46cm) pad is divided into eighty-one 2" (5cm) segments, each of which may be cut or torn to provide smaller pads. These 50 durometer pads will withstand a load of 180 psi with greater resiliency.



| CATALOG NO.   | DESCRIPTION               | UOM | ORDER MULTIPLE |
|---------------|---------------------------|-----|----------------|
| <b>ISO-2</b>  | 2" x 2" x 3/4" Iso-Cube   | EA  | 24             |
| <b>ISO-4</b>  | 4" x 4" x 3/4" Iso-Cube   | EA  | 12             |
| <b>ISO-18</b> | 18" x 18" x 3/4" Iso-Cube | EA  | 6              |



# MOUNTING SYSTEMS

|                         |       |
|-------------------------|-------|
| Equipment Stands .....  | 33-34 |
| Hanging Brackets.....   | 35    |
| Heat Pump Risers .....  | 30    |
| Mini-Split Stands ..... | 32    |
| Mounting Blocks.....    | 30-31 |
| Mounting Brackets.....  | 31-32 |

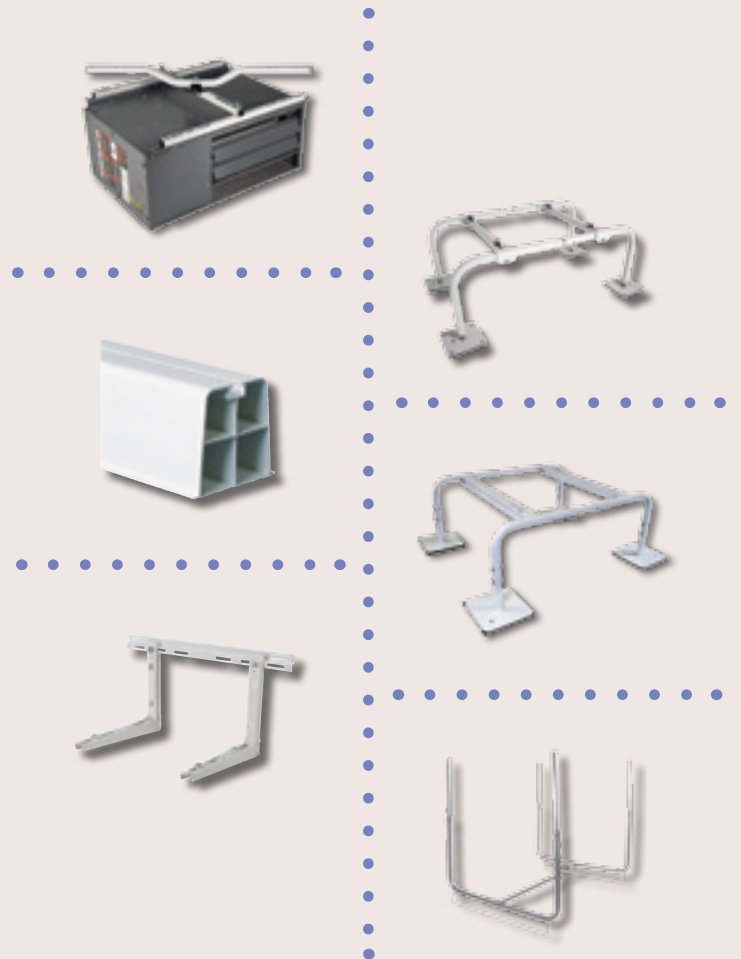



## MINI-SPLIT OUTDOOR UNIT STANDS

QSMS1201

## MINI-SPLIT WALL BRACKETS

QSWB2000



## UNIT HEATER SWIVEL BRACKETS

QSWI4000





**VRF/VRV  
EQUIPMENT STANDS**  
QSSS1019



**UNIT HEATER  
SWIVEL  
BRACKETS**  
QSWI3000

# Hef-T-Foot™

*Recycled rubber condensing unit and accessory mounting blocks.*



## ROOFTOP INSTALLATIONS



*Hef-T-Foot™ —  
Rooftop/Ground Mount  
Installation*



*Hef-T-Foot™ —  
Rooftop/Ground Mount  
Accessory/Pipe Support  
Installation*



## UTILITY ROOM INSTALLATIONS



*Hef-T-Foot™ —  
Utility Room Installation,  
Gravity Drain*

**Condensate management is needed for heat pumps.**



*Hef-T-Foot™ —  
Utility Room Installation,  
Condensate Pump*

## Hef-T-Bracket™ — Wall Mounted Mini-Split Brackets



### HEF-T-BRACKET™ TYPE 2

These brackets feature a cross bar that is attached to a wall and two L-shaped brackets that are hooked and bolted into place on the cross bar.

When operating in heat pump mode, the unit will produce condensate which is easily captured and managed using this snap on drain pan.

## HEAT PUMP RISERS

### One Piece Heat Pump Risers

Sturdy and stable, DiversiTech's Heat Pump Riser provides the desired elevation for condensers, heat pumps, and air handlers. The one piece, heavy duty plastic unit is manufactured in three heights. Butyl mastic on the top and bottom guarantees no slipping and reduced vibration and noise.



| CATALOG NO.   | DESCRIPTION | UOM | ORDER MULTIPLE |
|---------------|-------------|-----|----------------|
| <b>HPR-3</b>  | Riser - 3"  | EA  | 48             |
| <b>HPR-6</b>  | Riser - 6"  | EA  | 36             |
| <b>HPR-12</b> | Riser - 12" | EA  | 16             |

### Adjustable Equipment Risers

Adjustable equipment risers easily adjust up or down as needed to secure equipment at the correct height. The large center barrel twists up from starting height of 5" to a max of 8". A separate top cap allows for raising or lowering the riser even with equipment already on it. Convenient height markings provided for reference.



| CATALOG NO.    | DESCRIPTION                           | UOM | ORDER MULTIPLE |
|----------------|---------------------------------------|-----|----------------|
| <b>AER-8</b>   | Adjustable Equipment Riser - 8"       | EA  | 4              |
| <b>AER-8BL</b> | Adjustable Equipment Riser - 8" Black | EA  | 4              |

### Two Piece Heat Pump Risers

Sturdy and stable, DiversiTech's Heat Pump Riser provides the desired elevation for condensers, heat pumps, and air handlers. The one piece, heavy duty plastic unit is manufactured in two heights and an extension. Butyl mastic on the top and bottom guarantees no slipping and reduced vibration and noise.



| CATALOG NO.      | DESCRIPTION                | UOM | ORDER MULTIPLE |
|------------------|----------------------------|-----|----------------|
| <b>HPR-3-2P</b>  | Two Piece Riser - 3"       | EA  | 32             |
| <b>HPR-6-2P</b>  | Two Piece Riser - 6"       | EA  | 16             |
| <b>HPR-3-2PG</b> | Two Piece Black Riser - 3" | EA  | 32             |
| <b>HPR-6-2PG</b> | Two Piece Black Riser - 6" | EA  | 16             |
| <b>HPR-EXT</b>   | 4" Extension               | EA  | 28             |

## MOUNTING BLOCKS

### Air Handler Block

Lightweight styrofoam block (concrete gray) provides A/C air handler support in attic installations.

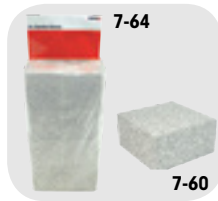

| CATALOG NO. | DESCRIPTION                               | UOM | ORDER MULTIPLE |
|-------------|---|-----|----------------|
| <b>7-60</b> | Air Handler Block 8" x 8" x 4"            | EA  | 144            |
| <b>7-64</b> | Air Handler Block 8" x 8" x 4", pack of 4 | PK  | 4              |

### Base Pad

Used as a mounting base when condensing units must be bolted down. Maximum load capacity is 220 lbs. per pad. Sliding rail design for easy and fast installation. Includes mounting bolts. Available in 14" and 17" lengths. Ivory color.



| CATALOG NO.      | DESCRIPTION             | UOM | ORDER MULTIPLE |
|------------------|-------------------------|-----|----------------|
| <b>230-BP17W</b> | 17" Base Pad, pack of 2 | PK  | 10             |

### Furnace Mounting Blocks

Each furnace mounting block can support 40% more weight than competitive products - over 500 pounds! Easy peel and stick installation.



| CATALOG NO. | DESCRIPTION            | UOM | ORDER MULTIPLE |
|-------------|------------------------|-----|----------------|
| <b>FB-1</b> | Furnace Mounting Block | EA  | 72             |

### Hef-T-Block™

Used as mounting bases when condensing units must be bolted down. Available in three lengths. Furnished complete with end caps and mounting bolts. Maximum load capacity is 440 pounds per mounting block. Installation temperature range from 4F ( 20C) to 140F (60C). Hef T Blocks fit all mini split condensing units with a unique sliding rail feature.



| CATALOG NO.      | DESCRIPTION   | UOM | ORDER MULTIPLE |
|------------------|---|-----|----------------|
| <b>230-MB14W</b> | 14" Hef-T-Block™ (White), pack of 2                 | PK  | 6              |
| <b>230-MB17W</b> | 17" Hef-T-Block™ (White), pack of 2                 | PK  | 6              |
| <b>230-MB36W</b> | 36" Hef-T-Block™ (White), pack of 2                 | PK  | 2              |
| <b>230-MBCW</b>  | Hef-T-Block™ Replacement End Cap (White), pack of 4 | PK  | 25             |

### A/C Riser Block

The A/C Riser Block gives you a fast and easy way to elevate an air handler or furnace 2.5 in. off the floor or drain pan. The unique stacking feature provides variable height adjustment from a single block height of 2.5 in. in increments of .75 in.



| CATALOG NO.  | DESCRIPTION     | UOM | ORDER MULTIPLE |
|--------------|-----------------|-----|----------------|
| <b>ACR-1</b> | A/C Riser Block | EA  | 100            |



**MOUNTING BLOCKS** cont'd

**Hef-T-Foot™**

The Hef-T-Foot™ is used to support small pipework, runs of cable tray, or an alternative to supporting condensing units, air source heat pumps or a variety of outdoor equipment.

The Hef-T-Foot™ with strut comes in four lengths — 9.8", 15.7", 23.6", 39.4". They are manufactured from heavy duty recycled rubber and come complete with .8" x 1.6" galvanized steel strut adhered to the rubber with industrial adhesive. The rubber is strong and durable with drain slots moulded into the underside to allow standing water to flow under the foot.

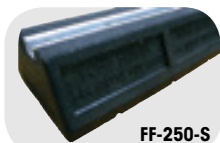

**FF-250-S**



**FF-250-UNI**

| CATALOG NO.       | DESCRIPTION                               | UOM | ORDER MULTIPLE |
|-------------------|---|-----|----------------|
| <b>FF-250-S</b>   | Hef-T-Foot™ – 9.8" with 1.6" x .8" strut  | EA  | 1              |
| <b>FF-400-S</b>   | Hef-T-Foot™ – 15.7" with 1.6" x .8" strut | EA  | 1              |
| <b>FF-600-S</b>   | Hef-T-Foot™ – 23.6" with 1.6" x .8" strut | EA  | 1              |
| <b>FF-1000-S</b>  | Hef-T-Foot™ – 39.4" with 1.6" x .8" strut | EA  | 1              |
| <b>FF-250-UNI</b> | Hef-T-Foot™ – 9.8" Universal              | EA  | 1              |

**Hef-T-Foot™ Installation Variants**

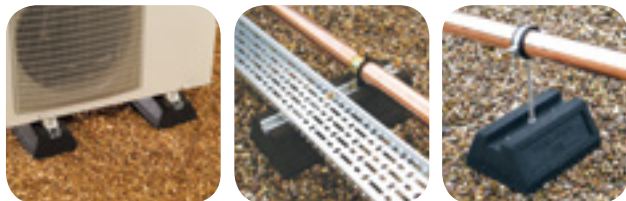

**MOUNTING BRACKETS**

**Boiler Bracket**

Our boiler bracket works well with all wall hung boilers and tankless hot water heaters available.



**QSBB2000**  
**QSBB1000**

**QUICK-SLING™**  
by DiversiTech

| CATALOG NO.     | DESCRIPTION              | UOM | ORDER MULTIPLE |
|-----------------|--------------------------|-----|----------------|
| <b>QSBB1000</b> | Boiler Bracket Wall Hung | EA  | 1              |
| <b>QSBB2000</b> | Boiler Bracket Leg Kit   | EA  | 1              |

**Hef-T-Bracket™ (Type 2)**

Used for supporting condensing units, Hef-T-Brackets (Type 2) feature a cross bar that is attached to a wall, and two L shaped brackets that are hooked and bolted into place on the cross bar. The condensing unit is mounted onto the L shaped brackets, and fastened using the bolts and anti vibration washers provided.

\*Not approved for South Florida.



**230-B2L**

| CATALOG NO.    | DESCRIPTION                      | ARM LENGTH | LOAD RATING PER ARM | UOM | ORDER MULTIPLE |
|----------------|----------------------------------|------------|---------------------|-----|----------------|
| <b>230-B2M</b> | Hef-T-Bracket™ (Type 2) – Medium | 18"        | 165#                | EA  | 1              |
| <b>230-B2L</b> | Hef-T-Bracket™ (Type 2) – Large  | 21"        | 220#                | EA  | 1              |

**Heavy Duty Bracket (Type 1)**

Heavy duty L-shaped brackets for supporting condensing units. Each 20" arm supports up to 350 lbs.



**230-B1HD**

| CATALOG NO.     | DESCRIPTION        | ARM LENGTH | LOAD RATING PER ARM | UOM | ORDER MULTIPLE |
|-----------------|--------------------|------------|---------------------|-----|----------------|
| <b>230-B1HD</b> | Heavy Duty Bracket | 20"        | 350#                | EA  | 1              |

**Hef-T-Bracket™ (Type 3)**

Used for supporting condensing units, Hef-T-Brackets (Type 3), just like Hef-T-Brackets (Type 2), feature a cross bar that is attached to a wall, and two L shaped brackets that are hooked and bolted into place on the cross bar. The condensing unit is mounted onto the L shaped brackets, and fastened using the bolts and anti vibration washers provided. The Hef-T-Bracket™ (Type 3) features an innovative locking mechanism called Easy Fit™. Easy Fit™ enables the arms to be joined to the uprights in a matter of seconds. A spring lock automatically secures the joint, preventing the arms from being dislodged accidentally. All brackets are furnished complete with an integral bubble level to make correct installation of the crossbar easier.



**230-B3L**



| CATALOG NO.    | DESCRIPTION                      | ARM LENGTH | LOAD RATING PER ARM | UOM | ORDER MULTIPLE |
|----------------|----------------------------------|------------|---------------------|-----|----------------|
| <b>230-B3M</b> | Hef-T-Bracket™ (Type 3) – Medium | 19"        | 100#                | EA  | 1              |
| <b>230-B3L</b> | Hef-T-Bracket™ (Type 3) – Large  | 21"        | 150#                | EA  | 1              |

## Hef-T-Bracket™ (Type 2) Extra Duty

Used for supporting condensing units, Type 2 Extra Duty brackets feature a sturdy cross bar that is attached to a wall and two L shaped brackets that slide onto the crossbar and then bolt into place. The condensing unit is mounted onto the L shaped brackets and fastened using the bolts and anti-vibration washers provided. Includes bubble level and adjustable back support. \*Not approved for South Florida.



230-B2XL

| CATALOG NO. | DESCRIPTION                     | ARM LENGTH | LOAD RATING PER ARM | UOM | ORDER MULTIPLE |
|-------------|---------------------------------|------------|---------------------|-----|----------------|
| 230-B2XL    | Hef-T-Bracket™ (Type 2) – Large | 21"        | 240#                | EA  | 1              |

## Wall Brackets

Our Quick-Sling® Wall Bracket provides a quick, safe, and stable way to mount your unit. They allow for easy access during installation, service, and maintenance. Our roof bracket accessory is designed to protect your equipment from snow and freezing rain while maintaining proper air flow around the unit.



QSWB1000



| CATALOG NO. | DESCRIPTION                    | UOM | ORDER MULTIPLE |
|-------------|--------------------------------|-----|----------------|
| QSWB1000    | Mini Split Wall Bracket        | EA  | 1              |
| QSWB2000    | Wall Bracket w/Rails Light Dty | EA  | 1              |
| QSWB3000    | Wall Bracket w/Z Bend          | EA  | 1              |
| QSWB4000    | Wall Bracket w/Rails Heavy Dty | EA  | 1              |
| QSRB1000    | Roof Bracket System            | EA  | 1              |

## MINI-SPLIT STANDS

### Mini-Split Stands

Our Quick-Sling® Mini-Split Stands provide a safe, stable platform to mount your unit on. It keeps unit elevated above lawn mowers, weed whackers, pets, snow, and flooding. The elevated height allows for ease of installation, maintenance and service.



QSMS1200



| CATALOG NO. | DESCRIPTION                 | UOM | ORDER MULTIPLE |
|-------------|-----------------------------|-----|----------------|
| QSMS1200    | Mini-Split Stand Thin - 12" | EA  | 1              |
| QSMS1201    | Mini-Split Stand Wide - 12" | EA  | 1              |
| QSMS1800    | Mini-Split Stand Thin - 18" | EA  | 1              |
| QSMS1801    | Mini-Split Stand Wide - 18" | EA  | 1              |
| QSMS2400    | Mini-Split Stand Thin - 24" | EA  | 1              |
| QSMS2401    | Mini-Split Stand Wide - 24" | EA  | 1              |

### Mini-Split Double Stack Stand

Our Quick-Sling® Mini-Split Double Stack Stand provide a safe, stable platform to mount your unit on. It keeps unit elevated above lawn mowers, weed whackers, pets, snow, and flooding. The elevated height allows for ease of installation, maintenance and service.



QSMS1203



| CATALOG NO. | DESCRIPTION                   | UOM | ORDER MULTIPLE |
|-------------|-------------------------------|-----|----------------|
| QSMS1203    | Mini-Split Double Stack Stand | EA  | 1              |

## Air Conditioner Brackets

These heavy duty 1/8" thick steel AC brackets are perfect for hanging A/C condensers and heat pumps outside the home. Mount at any height to allow for easy maintenance under units. No need to wait for finished grade or landscaping prior to installation of AC unit. Pre punched holes for easy installation. Powder coated gray finish. Load rating 600 lbs. per pair.



ACB-30

| CATALOG NO. | DESCRIPTION                          | UOM | ORDER MULTIPLE |
|-------------|--------------------------------------|-----|----------------|
| ACB-30      | AC Mounting Bracket – 30", pack of 2 | PK  | 1              |
| ACB-36      | AC Mounting Bracket – 36", pack of 2 | PK  | 1              |
| ACB-42      | AC Mounting Bracket – 42", pack of 2 | PK  | 1              |
| ACB-48      | AC Mounting Bracket – 48", pack of 2 | PK  | 1              |

### Mini-Split Dual Fan Stands

Our Quick-Sling® Mini-Split Dual Fan Stands provide a safe, stable platform to mount your unit on. It keeps unit elevated above lawn mowers, weed whackers, pets, snow, and flooding. The elevated height allows for ease of installation, maintenance and service.



QSMS1202



| CATALOG NO. | DESCRIPTION                     | UOM | ORDER MULTIPLE |
|-------------|---------------------------------|-----|----------------|
| QSMS1202    | Mini-Split Dual Fan Stand - 12" | EA  | 1              |
| QSMS1802    | Mini-Split Dual Fan Stand - 18" | EA  | 1              |
| QSMS2402    | Mini-Split Dual Fan Stand - 24" | EA  | 1              |



**EQUIPMENT STANDS**

**Air Handler Base – Heavy Duty Adjustable**

Made of 14 gauge galvanized steel for excellent corrosion resistance and longevity. 22" high x 22" deep. Width is adjustable from 16" – 26". Supports up to 200 lbs.



**6-HAB-BG**

| CATALOG NO.     | DESCRIPTION            | UOM | ORDER MULTIPLE |
|-----------------|------------------------|-----|----------------|
| <b>6-HAB-BG</b> | Steel Air Handler Base | EA  | 1              |

**Quick-Stand**

Our Quick-Stand is made of 14-gauge square tubing. This not only cuts down on vibration but allows the stand to hold up to 500 lbs. Each leg individually extends in 1" increments using thumb screws & wing nuts for speed and versatility. Installs as low as 22" on flat or uneven surfaces.



**QSTD1000**



| CATALOG NO.     | DESCRIPTION            | UOM | ORDER MULTIPLE |
|-----------------|------------------------|-----|----------------|
| <b>QSTD1000</b> | Quick-Stand Heavy Duty | EA  | 1              |
| <b>QSTD2000</b> | Quick-Stand Light Duty | EA  | 1              |

**Quick Heat Pump Stand**

Our 18" Quick-Sling® Heat Pump Stand provides a safe stable platform to mount your unit on. Keep it elevated above lawn mowers, weed whackers, pets, snow, and flooding. Elevated height allows for ease of installation, service, and maintenance.



**QSTD3000**



| CATALOG NO.     | DESCRIPTION                   | UOM | ORDER MULTIPLE |
|-----------------|-------------------------------|-----|----------------|
| <b>QSTD3000</b> | Quick Heat Pump Stand (4 Arm) | EA  | 1              |

**Vertical Air Handler Stand**

Our Quick-Sling® Vertical Air Handler Stand fits all LG, Unico and Mitsubishi Air Handlers. It is adjustable left to right in 1" increments up to 6". 18" and 24" stands include 2 stability arms. 500 lbs Max Capacity.



**QSTD4000**



| CATALOG NO.     | DESCRIPTION                    | UOM | ORDER MULTIPLE |
|-----------------|--------------------------------|-----|----------------|
| <b>QSTD4000</b> | 12" Vert Air Hdler Std 19" Arm | EA  | 1              |
| <b>QSTD4001</b> | 12" Vert Air Hdler Std 23" Arm | EA  | 1              |
| <b>QSTD4002</b> | 12" Vert Air Hdler Std 27" Arm | EA  | 1              |
| <b>QSTD5000</b> | 18" Vert Air Hdler Std 19" Arm | EA  | 1              |
| <b>QSTD5001</b> | 18" Vert Air Hdler Std 23" Arm | EA  | 1              |
| <b>QSTD5002</b> | 18" Vert Air Hdler Std 27" Arm | EA  | 1              |
| <b>QSTD6000</b> | 24" Vert Air Hdler Std 19" Arm | EA  | 1              |
| <b>QSTD6001</b> | 24" Vert Air Hdler Std 23" Arm | EA  | 1              |
| <b>QSTD6002</b> | 24" Vert Air Hdler Std 27" Arm | EA  | 1              |

**EQUIPMENT STANDS cont'd**

**VRF/VRV/HRV Super Stands**

Super Stands come with single and double-sided U Bars to accommodate any multi-unit combination.



**QSSS1003-12**



**U Bar Details:**

- 1.5" x 1.5" - U Bars made from 11 gauge steel square tubing.
- Adjustable width in 1" increments.
- Adjustable height in 1/4" and 1/2" increments.
- Rubber roof friendly.
- 12" x 12" feet made from 7 gauge steel with 3/8" holes for mounting.

| CATALOG NO. | DESCRIPTION                | UOM | ORDER MULTIPLE |
|-------------|----------------------------|-----|----------------|
| QSSS1003-12 | Super Stand 12" Type A     | EA  | 1              |
| QSSS1003-18 | Super Stand 18" Type A     | EA  | 1              |
| QSSS1003-24 | Super Stand 24" Type A     | EA  | 1              |
| QSSS1004-12 | Super Stand 12" Type B     | EA  | 1              |
| QSSS1004-18 | Super Stand 18" Type B     | EA  | 1              |
| QSSS1004-24 | Super Stand 24" Type B     | EA  | 1              |
| QSSS1005-12 | Super Stand 12" Type C     | EA  | 1              |
| QSSS1005-18 | Super Stand 18" Type C     | EA  | 1              |
| QSSS1005-24 | Super Stand 24" Type C     | EA  | 1              |
| QSSS1006-12 | Super Stand 12" Type A+A   | EA  | 1              |
| QSSS1006-18 | Super Stand 18" Type A+A   | EA  | 1              |
| QSSS1006-24 | Super Stand 24" Type A+A   | EA  | 1              |
| QSSS1007-12 | Super Stand 12" Type A+C   | EA  | 1              |
| QSSS1007-18 | Super Stand 18" Type A+C   | EA  | 1              |
| QSSS1007-24 | Super Stand 24" Type A+C   | EA  | 1              |
| QSSS1008-12 | Super Stand 12" Type B+B   | EA  | 1              |
| QSSS1008-18 | Super Stand 18" Type B+B   | EA  | 1              |
| QSSS1008-24 | Super Stand 24" Type B+B   | EA  | 1              |
| QSSS1009-12 | Super Stand 12" Type B+C   | EA  | 1              |
| QSSS1009-18 | Super Stand 18" Type B+C   | EA  | 1              |
| QSSS1009-24 | Super Stand 24" Type B+C   | EA  | 1              |
| QSSS1010-12 | Super Stand 12" Type C+C   | EA  | 1              |
| QSSS1010-18 | Super Stand 18" Type C+C   | EA  | 1              |
| QSSS1010-24 | Super Stand 24" Type C+C   | EA  | 1              |
| QSSS1011-12 | Super Stand 12" Type C+A+A | EA  | 1              |
| QSSS1011-18 | Super Stand 18" Type C+A+A | EA  | 1              |
| QSSS1011-24 | Super Stand 24" Type C+A+A | EA  | 1              |
| QSSS1012-12 | Super Stand 12" Type A+B+C | EA  | 1              |
| QSSS1012-18 | Super Stand 18" Type A+B+C | EA  | 1              |
| QSSS1012-24 | Super Stand 24" Type A+B+C | EA  | 1              |
| QSSS1013-12 | Super Stand 12" Type A+C+C | EA  | 1              |
| QSSS1013-18 | Super Stand 18" Type A+C+C | EA  | 1              |
| QSSS1013-24 | Super Stand 24" Type A+C+C | EA  | 1              |
| QSSS1014-12 | Super Stand 12" Type B+C+C | EA  | 1              |
| QSSS1014-18 | Super Stand 18" Type B+C+C | EA  | 1              |
| QSSS1014-24 | Super Stand 24" Type B+C+C | EA  | 1              |
| QSSS1015-12 | Super Stand 12" Type C+C+C | EA  | 1              |
| QSSS1015-18 | Super Stand 18" Type C+C+C | EA  | 1              |
| QSSS1015-24 | Super Stand 24" Type C+C+C | EA  | 1              |
| QSSS1016-12 | Super Stand 12" Type A+A+A | EA  | 1              |
| QSSS1016-18 | Super Stand 18" Type A+A+A | EA  | 1              |
| QSSS1016-24 | Super Stand 24" Type A+A+A | EA  | 1              |
| QSSS1017-12 | Super Stand 12" Type A+B+B | EA  | 1              |
| QSSS1017-18 | Super Stand 18" Type A+B+B | EA  | 1              |
| QSSS1017-24 | Super Stand 24" Type A+B+B | EA  | 1              |
| QSSS1018-12 | Super Stand 12" Type B+B+B | EA  | 1              |
| QSSS1018-18 | Super Stand 18" Type B+B+B | EA  | 1              |
| QSSS1018-24 | Super Stand 24" Type B+B+B | EA  | 1              |
| QSSS1019-12 | Super Stand 12" Type D     | EA  | 1              |
| QSSS1019-18 | Super Stand 18" Type D     | EA  | 1              |
| QSSS1019-24 | Super Stand 24" Type D     | EA  | 1              |

| CATALOG NO. | DESCRIPTION                     | UOM | ORDER MULTIPLE |
|-------------|---------------------------------|-----|----------------|
| QSSS1020-12 | Super Stand 12" Type D+D        | EA  | 1              |
| QSSS1020-18 | Super Stand 18" Type D+D        | EA  | 1              |
| QSSS1020-24 | Super Stand 24" Type D+D        | EA  | 1              |
| QSSS1021-12 | Super Stand 12" Type D+D+D      | EA  | 1              |
| QSSS1021-18 | Super Stand 18" Type D+D+D      | EA  | 1              |
| QSSS1021-24 | Super Stand 24" Type D+D+D      | EA  | 1              |
| QSSS1022-12 | Super Stand 12" Type A+B        | EA  | 1              |
| QSSS1022-18 | Super Stand 18" Type A+B        | EA  | 1              |
| QSSS1022-24 | Super Stand 24" Type A+B        | EA  | 1              |
| QSSS1023-12 | Super Stand 12" Type A+A+B      | EA  | 1              |
| QSSS1023-18 | Super Stand 18" Type A+A+B      | EA  | 1              |
| QSSS1023-24 | Super Stand 24" Type A+A+B      | EA  | 1              |
| QSSS1024-12 | Super Stand 12" Type A+D        | EA  | 1              |
| QSSS1024-18 | Super Stand 18" Type A+D        | EA  | 1              |
| QSSS1024-24 | Super Stand 24" Type A+D        | EA  | 1              |
| QSSS1025-12 | Super Stand 12" Type A+D+D      | EA  | 1              |
| QSSS1025-18 | Super Stand 18" Type A+D+D      | EA  | 1              |
| QSSS1025-24 | Super Stand 24" Type A+D+D      | EA  | 1              |
| QSSS36      | Super Stand Cross Rail - 36 in. | EA  | 1              |
| QSSS48      | Super Stand Cross Rail - 48 in. | EA  | 1              |
| QSSS55      | Super Stand Cross Rail - 55 in. | EA  | 1              |
| QSSS70      | Super Stand Cross Rail - 70 in. | EA  | 1              |
| QSSS100-12  | Super Stand U Bar - Single      | EA  | 1              |
| QSSS100-12  | Super Stand U Bar - Double      | EA  | 1              |

\*NOTE: Please contact Diversitech for additional configurations.

Cross Rail Types: Type A: 36" Cross Rail; Type B: 48" Cross Rail; Type C: 70" Cross Rail; Type D: 55" Cross Rail



## HANGING BRACKETS

### Quick-Sling

Our Quick-Sling is made of 14-gauge square tubing. This not only cuts down on vibration but allows the stand to hold up to 400 lbs. Extension arms individually adjust in one inch increments using thumb screws & wing nuts for speed & versatility. Installs as high as 24" or as low as 48" on flat or pitched roofs.



**QSLG1000**  
**QUICK-SLING**  
 by DiversiTech

| CATALOG NO.     | DESCRIPTION                    | UOM | ORDER MULTIPLE |
|-----------------|--------------------------------|-----|----------------|
| <b>QSLG1000</b> | Sling Bracket Light Duty 1 Arm | EA  | 1              |
| <b>QSLG2000</b> | Sling Bracket Heavy Duty 2 Arm | EA  | 1              |

### Quick Swivel "U" Mount

Our Quick Swivel is made of 14-gauge steel able to hold 200 lbs. The swivel allows for 360° rotation for setting the perfect direction of air flow.



**QSWI1000**  
**QUICK-SLING**  
 by DiversiTech

| CATALOG NO.     | DESCRIPTION                  | UOM | ORDER MULTIPLE |
|-----------------|------------------------------|-----|----------------|
| <b>QSWI1000</b> | Swivel "U" Mount w/H-Bracket | EA  | 1              |
| <b>QSWI2000</b> | Swivel "U" Mount w/L-Bracket | EA  | 1              |

### Quick Swivel Flush Mount w/"H" Bracket

Our Quick Swivel is made of 14-gauge steel able to hold 200 lbs. The swivel allows for 360° rotation for setting the perfect direction of air flow.



**QSWI3000**  
**QUICK-SLING**  
 by DiversiTech

| CATALOG NO.     | DESCRIPTION                    | UOM | ORDER MULTIPLE |
|-----------------|--------------------------------|-----|----------------|
| <b>QSWI3000</b> | Swivel Flush H Bracket         | EA  | 1              |
| <b>QSWI3001</b> | Swivel Flush H Bracket 36" Spd | EA  | 1              |
| <b>QSWI3002</b> | Swivel Flush H Bracket 17" Spd | EA  | 1              |

### Quick Swivel Flush Mount w/"I" Bracket

Our Quick Swivel is made of 14-gauge steel able to hold 200 lbs. The swivel allows for 360° rotation for setting the perfect direction of air flow.



**QSWI4000**  
**QUICK-SLING**  
 by DiversiTech

| CATALOG NO.     | DESCRIPTION                 | UOM | ORDER MULTIPLE |
|-----------------|-----------------------------|-----|----------------|
| <b>QSWI4000</b> | Swivel Flush w/ I Bracket   | EA  | 1              |
| <b>QSWI5000</b> | Swivel Flush Heavy Duty     | EA  | 1              |
| <b>QSWI6000</b> | Swivel Flush w/2 I Brackets | EA  | 1              |

### Quick-Sling Accessories

- The QSAC1000 (set of 4) & 1100 (set of 2) steel beam adapters are made out of aluminum & able to hold up to 250 lbs each.
- Each QSAC1000 is slotted to receive 3/8 threaded rod or C-clamps for easy mounting.
- The QSAC2000 (set of 4) & 2100 (set of 2) wood beam adapters are made of steel & are 12" long & 2" wide.
- Each of our adapters are able to hold up to 200 lbs.
- They have a 1.5" bend that simply clips over the wood joist. All the necessary hardware is provided.
- QSAC1000 and QSAC2000 adapts: QSLG1000 & QSLG2000
- QSAC1100 and QSAC2100 adapts: QSWI1000 & QSWI2000



**QSAC1000**  
**QUICK-SLING**  
 by DiversiTech

| CATALOG NO.     | DESCRIPTION             | UOM | ORDER MULTIPLE |
|-----------------|-------------------------|-----|----------------|
| <b>QSAC1000</b> | Adapters, Steel Pk of 4 | EA  | 1              |
| <b>QSAC1100</b> | Adapters, Steel Pk of 2 | EA  | 1              |
| <b>QSAC2000</b> | Adapters, Wood Pk of 4  | EA  | 1              |
| <b>QSAC2100</b> | Adapters, Wood Pk of 2  | EA  | 1              |

# Patch It Up!

Item # FP-36

## Repair almost any surface with Flexi-Patch™

- Extremely durable fiberglass reinforced patch
- Flexible and waterproof
- Weather and UV resistant
- Temperature safe from -30°C to 365°C
- Will not shrink or expand during or after application
- Bonds to all surfaces except polypropylene
- Cure quickly – as fast as 5 minutes.

Flexi-Patch™ is an easy to use flexible repair patch ideal for repairing almost any surface. It cures quickly using only UV light from sunlight or a UV flashlight for a long lasting, permanent repair. Flexi-Patch is a fiberglass-reinforced polyester ideal for use on PVC, plastics, metal, wood, concrete and more. It's the easy way to permanently patch almost any surface. It dries hard for permanent repair. Can be drilled, tapped and painted once dry.



**BEFORE**

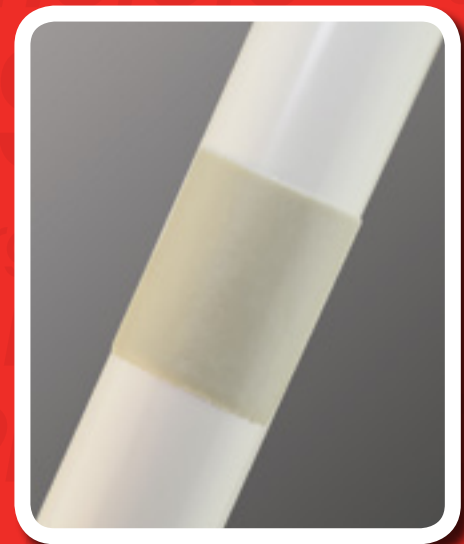

**AFTER**



Display  
box of 20

**DIVERSITECH**®



# AIR MOVEMENT

|  |       |
|--|-------|
| Dryer Duct, Vent Hose, Hose Clamps ..... | 40-41 |
| Duct Strap, Ties, Clamps .....           | 41-42 |
| Pure-Beam™ Ultraviolet Light .....       | 40    |
| Tapes .....                              | 42    |
| Ventilation Products .....               | 39    |



# PURE-BEAM™ Ultraviolet Light

*The Pure-Beam™ ultraviolet light is designed for HVAC air disinfection and surface irradiation. Exposure to Pure-Beam™ significantly reduces air contamination caused by fungus, mold, and viruses and can cleanse surfaces overcome by mold and slime.*

- The Pure-Beam™ ultraviolet light is an excellent way to maintain indoor air quality.
- This UV Light includes a ballast, transformer, and bracket for even more convenience.
- Overall dimensions are small which makes installation easy.
- The included transformer allows operation using 120, 208, and 240/220 VAC power.
- UV lights are unobtrusive and transparent in operation, requiring little maintenance.

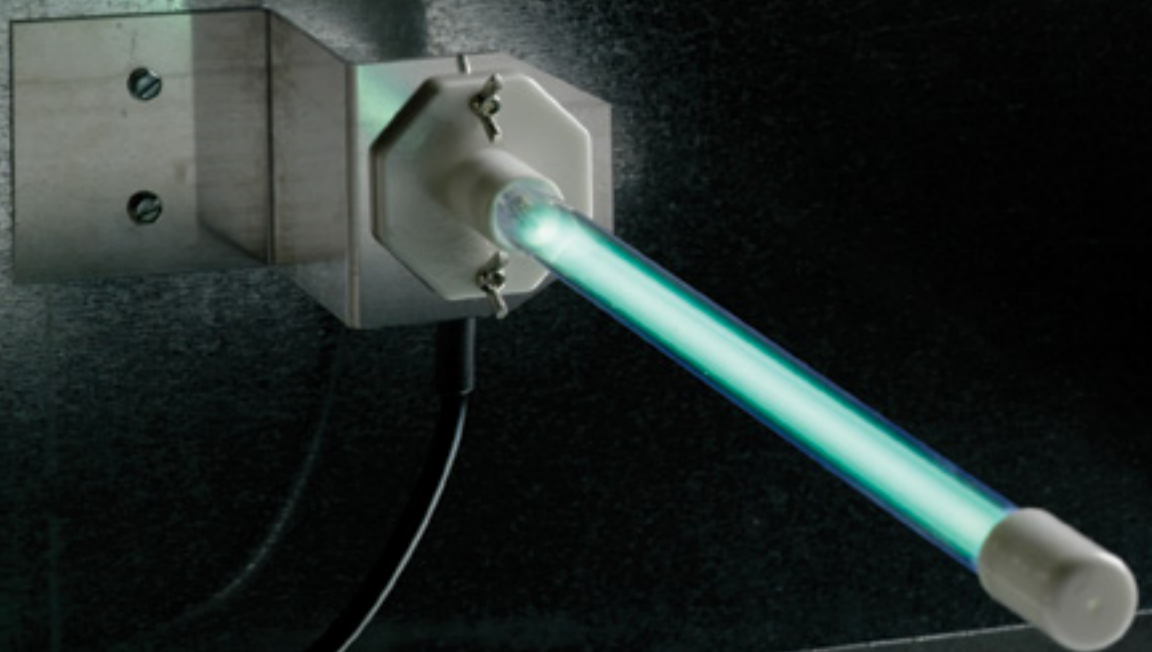



**Duct Fans**

Features electrical junction box for UL and code compliant electrical connection. An efficient way to increase air circulation, keep room temperatures consistent, and lower heating and cooling costs. Metal construction, powerful no-maintenance motors and a one-use thermal fuse mean these fans will be up to the task for years. Straightforward installation into any 120V system with detailed instructions, templates, and diagrams. Available in many sizes. A great way to give slow vents a boost. Conforms to UL STD 507, Certified to CSA STD C22.2 #113

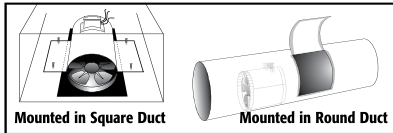

| CATALOG NO. | DESCRIPTION                      | UOM | ORDER MULTIPLE |
|-------------|----------------------------------|-----|----------------|
| 625-AF6     | Duct Fan 6" dia., 240 CFM, 37W   | EA  | 4              |
| 625-AF8     | Duct Fan 8" dia., 420 CFM, 37W   | EA  | 4              |
| 625-AF10    | Duct Fan 10" dia., 650 CFM, 35W  | EA  | 4              |
| 625-AF12    | Duct Fan 12" dia., 975 CFM, 65W  | EA  | 2              |
| 625-AF14    | Duct Fan 14" dia., 1350 CFM, 65W | EA  | 1              |

**Roof Flashing**

Easy to install. The no-caulk flashing slips over vent stack and automatically adjusts to pipe size and roof angle. 24 gauge galvanized steel.



| CATALOG NO. | DESCRIPTION                      | UOM | ORDER MULTIPLE |
|-------------|----------------------------------|-----|----------------|
| 5-11830     | Roof Flashing – 1/2" – 3/4" – 1" | EA  | 12             |
| 5-11840     | Roof Flashing – 1-1/4" – 1-1/2"  | EA  | 12             |
| 5-11853     | Roof Flashing – 2"               | EA  | 12             |
| 5-11866     | Roof Flashing – 3"               | EA  | 12             |
| 5-11879     | Roof Flashing – 4"               | EA  | 12             |

**Roof Louver**

Unique interior louver design, eliminating the need for a screen. The square hood has been designed for maximum air movement. Large nailing flange for easy installation. U.L. Listed.



| CATALOG NO. | DESCRIPTION            | UOM | ORDER MULTIPLE |
|-------------|------------------------|-----|----------------|
| 6-R50A      | Roof Louver – Aluminum | EA  | 10             |

**Flue Caps**

PVC Flue Caps are an affordable way to protect today's high efficiency furnaces from dirt, moisture and other debris.

- Protection for high efficiency furnaces
- Universal flue cap fits 1.5", 2" and 3" PVC pipe
- Reduces draft inducer motor rust
- Helps to eliminate pressure switch service calls
- Resistant to UV radiation and oxidative degradation
- CSA approved for use in 90% AFUE heating applications



| CATALOG NO. | DESCRIPTION    | UOM | ORDER MULTIPLE |
|-------------|----------------|-----|----------------|
| EC-1        | E cap Flue Cap | EA  | 12             |

**Smokeys**

Smoke emitter cartridges provide effective, low cost leak testing of heat exchangers, air ducts, tanks and boilers. Visual air balancing of HVAC systems. Cartridges produce clean, non toxic, oil free smoke through chemical reaction. Use also for fire drills as well as the placement and testing of smoke alarms/ detectors.



| CATALOG NO. | DESCRIPTION                                      | UOM | ORDER MULTIPLE |
|-------------|--|-----|----------------|
| 14145       | 45 second burn time, 150 cu. ft., pack of 10     | PK  | 1              |
| 14175       | 75 second burn time, 600 cu. ft., pack of 10     | PK  | 1              |
| 14250       | 2-1/2 minute burn time, 1,100 cu. ft., pack of 5 | PK  | 1              |
| 14340       | 4 minute burn time, 2,500 cu. ft., pack of 5     | PK  | 1              |

**Versa Cap® Flue and Hot Stack Caps**

Non clogging positive draft design, recommended for flue or hot stack installation. Clamp fitting adjustable for all standard sizes. Aluminum model. U.L. Listed.



| CATALOG NO. | PIPE O.D.       | DOUBLE WALL | SINGLE WALL | J-M TRANS. SITE | HEIGHT/OVERALL DIAMETER | ORDER UOM | ORDER MULTIPLE |
|-------------|-----------------|-------------|-------------|-----------------|-------------------------|-----------|----------------|
| 6-3050      | 2-7/8"-5"       | 3 and 4     | 3 and 4     | 3 and 4         | 4-1/2" x 6-5/8"         | EA        | 12             |
| 6-5070      | 4-7/8"-7"       | 5 and 6     | 5 and 6     | 5 and 6         | 4-3/4" x 9-1/2"         | EA        | 12             |
| 6-7090      | 6-7/8"-9"       | 7 and 8     | 7 and 8     | 7 and 8         | 5-7/8" x 11-5/8"        | EA        | 12             |
| 6-9011      | 8-7/8"-11"      | 9 and 10    | 9 and 10    | 9 and 10        | 6-1/2" x 12-3/4"        | EA        | 6              |
| 6-1200      | 11-7/8"-14-1/2" | 12          | 12 and 14   | 12              | 8-11/16" x 17-9/16"     | EA        | 2              |

**Egg Crate Louvers – Air Return Diffusers**

White polystyrene 1/2 in. open cell grid louvers are beneficial for air return.

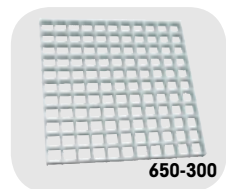

| CATALOG NO. | DESCRIPTION                        | UOM | ORDER MULTIPLE |
|-------------|------------------------------------|-----|----------------|
| 650-300     | Egg Crate Louvers – 2' x 2' x 1/2" | EA  | 20             |
| 650-200     | Egg Crate Louvers – 2' x 4' x 3/8" | EA  | 15             |
| 650-100     | Egg Crate Louvers – 2' x 4' x 1/2" | EA  | 10             |

**PURE BEAM™ ULTRAVIOLET LIGHT**

**Pure-Beam™ Ultraviolet Light**

Pure Beam™ ultraviolet light is designed for HVAC air disinfection and surface irradiation. The 17 watt UV C lamp is a powerful tool for improved indoor air quality. Installs in the HVAC system or ductwork on either the return or supply air side of the furnace or air handler. DiversiTech's Pure Beam™ ultraviolet light provides a healthier environment in your home, thanks to the germicidal qualities of the UV light spectrum present in the Pure Beam™ light. Ultraviolet light deactivates the DNA of dust mites, bacteria, viruses and other pathogens and destroys their ability to multiply and cause disease. Placement of a Pure Beam™ light in an airstream or near a drain pan can help to decrease the air contamination of any home. Exposure to Pure Beam™ significantly reduces air contamination caused by fungus, mold, and viruses and can cleanse surfaces overcome by mold and slime. Overall size is 14 in. L x 2 in. W x 2 in. H for easy placement. Includes the UV lamp, a UL listed ceramic base, and mounting bracket.



**UV-1**

| CATALOG NO.    | DESCRIPTION                                 | UOM | ORDER MULTIPLE |
|----------------|---|-----|----------------|
| <b>UV-1</b>    | Ultraviolet Light with 24 VAC elec. ballast | EA  | 1              |
| <b>UV-BULB</b> | Replacement Bulb – 24V                      | EA  | 1              |

**DRYER DUCT, VENT HOSE, HOSE CLAMPS**

**Aluminum Dryer Vent Hoods, Kits, and Fittings**

Aluminum vent hood with flange plate.

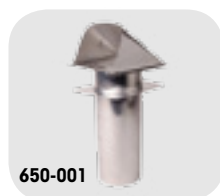

**650-001**

| CATALOG NO.    | DESCRIPTION            | UOM | ORDER MULTIPLE |
|----------------|------------------------|-----|----------------|
| <b>650-001</b> | 4" Aluminum Hood       | EA  | 24             |
| <b>650-002</b> | 3" Aluminum Hood       | EA  | 24             |
| <b>650-003</b> | 4" Hood / 8' Tubing    | EA  | 24             |
| <b>650-038</b> | 4" Aluminum Wide Mouth | EA  | 10             |

**Plastic Wide Mouth Dryer Vent Hood**

Hood, aluminum pipe and collar.



**650-012**

| CATALOG NO.    | DESCRIPTION                 | UOM | ORDER MULTIPLE |
|----------------|-----------------------------|-----|----------------|
| <b>650-031</b> | 3" White Hood – Assembled   | EA  | 12             |
| <b>650-012</b> | 4" White Hood – Assembled   | EA  | 12             |
| <b>650-013</b> | 4" White Hood – Unassembled | EA  | 18             |
| <b>650-023</b> | 4" Brown Hood – Assembled   | EA  | 12             |

**Louvered Dryer Vent Hood**

Louvered vent hoods are available with aluminum pipe and collar or hood only. Ideal for dryer and bathroom fan exhausts.



**650-014**

| CATALOG NO.    | DESCRIPTION                                    | UOM | ORDER MULTIPLE |
|----------------|--|-----|----------------|
| <b>650-014</b> | 4" Hood Only – White                           | EA  | 12             |
| <b>650-015</b> | 4" Hood Only w/Bird Guard – White              | EA  | 12             |
| <b>650-016</b> | 4" Hood, Pipe and Collar – White (Assembled)   | EA  | 12             |
| <b>650-017</b> | 4" Hood, Pipe and Collar – White (Unassembled) | EA  | 18             |
| <b>650-036</b> | 3" Hood, Pipe and Collar – White (Assembled)   | EA  | 12             |

**Dryer Vent Hose**

High quality flexible white vinyl tubing. Available in 3in. or 4in. diameters. One 50ft roll per box.



**650-005**

| CATALOG NO.    | DESCRIPTION                | UOM | ORDER MULTIPLE |
|----------------|----------------------------|-----|----------------|
| <b>650-005</b> | Dryer Vent Hose – 3" x 50' | EA  | 1              |
| <b>650-006</b> | Dryer Vent Hose – 4" x 50' | EA  | 1              |

**Semi-Rigid Aluminum Duct**

8ft. length compressed to 28in.



**650-011**

| CATALOG NO.    | DESCRIPTION                    | UOM | ORDER MULTIPLE |
|----------------|--------------------------------|-----|----------------|
| <b>650-011</b> | 4" x 8' Flexible Aluminum Duct | EA  | 9              |
| <b>650-021</b> | 3" x 8' Flexible Aluminum Duct | EA  | 14             |
| <b>650-074</b> | 6" x 8' Flexible Aluminum Duct | EA  | 3              |

**Metallic Duct – 5 Ply**

Pure aluminum 5 ply multi layered flexible metallic duct. U.L. 181 Listed. Will contain a fire up to 265°F.



**FUL0425**

| CATALOG NO.    | DESCRIPTION                  | UOM | ORDER MULTIPLE |
|----------------|------------------------------|-----|----------------|
| <b>FUL0425</b> | 4" x 25' 5 Ply Metallic Duct | EA  | 4              |
| <b>FUL0625</b> | 6" x 25' 5 Ply Metallic Duct | EA  | 4              |



**DRYER DUCT, VENT HOSE, HOSE CLAMPS cont'd**

**Dryer Hose Clamps**

Available for 3 in. or 4in. dryer vent hose. Steel screw design or convenient spring action design.



| CATALOG NO.    | DESCRIPTION                   | UOM | ORDER MULTIPLE |
|----------------|-------------------------------|-----|----------------|
| <b>650-008</b> | Steel Screw Clamp for 4" Hose | EA  | 50             |
| <b>650-010</b> | Spring Clamp for 4" Hose      | EA  | 500            |

**Periscope Connection Kit**

For tight space duct venting. Contains one male snap lock fitting and one draw band with clamp. Adjustable 17in. to 28in..



| CATALOG NO.    | DESCRIPTION      | UOM | ORDER MULTIPLE |
|----------------|------------------|-----|----------------|
| <b>650-020</b> | 4" Periscope Kit | EA  | 9              |

**Metallic Duct – 2 Ply**

2 ply metallic duct — aluminum outside, polyester inside. Ideal for bath fan ducting and all purpose venting.



| CATALOG NO.   | DESCRIPTION                  | UOM | ORDER MULTIPLE |
|---------------|------------------------------|-----|----------------|
| <b>FM0450</b> | 4" x 50' 2 Ply Metallic Duct | EA  | 1              |

**DUCT STRAP, TIES, CLAMPS**

**Heavy Duty Cable Ties**

6.6 nylon, the heavy duty duct straps feature smooth insertion, and a locking mechanism that gives ductwork a firm hold. Accommodates 7 to 15 inch duct. Tensioning tool for 32 in. plus allows operator to adjust strap to any desired tension.



| CATALOG NO.   | DESCRIPTION  | UOM | ORDER MULTIPLE |
|---------------|--|-----|----------------|
| <b>7-P24</b>  | 24" Long – Fits up to 6" Duct – 175 lb. Tensile          | EA  | 50             |
| <b>7-P36</b>  | 36" Long – Fits up to 10" Duct – 175 lb. Tensile         | EA  | 50             |
| <b>7-P36B</b> | 36" Long – Black – Fits up to 10" Duct – 175 lb. Tensile | EA  | 50             |
| <b>7-P48</b>  | 48" Long – Fits up to 14" Duct – 175 lb. Tensile         | EA  | 50             |
| <b>7-P48B</b> | 48" Long – Black – Fits up to 14" Duct – 175 lb. Tensile | EA  | 25             |
| <b>7-L300</b> | Tensioning Tool for 120-175 lb. Ties                     | EA  | 1              |

**Strapping Hanger Iron**

Galvanized 3/4 in. vent strapping, hanger iron, plumber's tape, pipe hanger tape and many other uses. 1/4 in. centers for bolts or nails.



| CATALOG NO.       | DESCRIPTION                                 | UOM | ORDER MULTIPLE |
|-------------------|---|-----|----------------|
| <b>710-A1710</b>  | Hanger Iron (Galv.) – 10' Rolls – 28 Gauge  | EA  | 50             |
| <b>710-A1650</b>  | Hanger Iron (Galv.) – 50' Rolls – 28 Gauge  | EA  | 10             |
| <b>710-A16100</b> | Hanger Iron (Galv.) – 100' Rolls – 28 Gauge | EA  | 6              |

**Hanging Wire**

The 18 gauge galvanized can be used to hang HVAC duct work.



| CATALOG NO.     | DESCRIPTION                          | UOM | ORDER MULTIPLE |
|-----------------|--------------------------------------|-----|----------------|
| <b>710-182G</b> | 2# Roll – 330' – 18 Gauge Galvanized | EA  | 8              |
| <b>710-185G</b> | 5# Roll – 830' – 18 Gauge Galvanized | EA  | 8              |

**Duct Strap – Metallic – Roll**

Galvanized duct strap in a convenient cardboard dispenser is not only easy to drill or nail, but also solid strapping. Plenum rated.



| CATALOG NO.    | DESCRIPTION                                    | UOM | ORDER MULTIPLE |
|----------------|--|-----|----------------|
| <b>710-001</b> | Metallic Duct Strap – 26 Gauge – 1" x 100'     | EA  | 1              |
| <b>710-002</b> | Metallic Duct Strap – 30 Gauge – 1" x 100'     | EA  | 1              |
| <b>710-003</b> | Metallic Duct Strap – 30 Gauge – 1-1/2" x 100' | EA  | 1              |
| <b>710-004</b> | Metallic Duct Strap – 26 Gauge – 1-1/2" x 100' | EA  | 1              |
| <b>710-005</b> | Metallic Duct Strap – 22 Gauge – 1" x 100'     | EA  | 1              |

**DUCT STRAP, TIES, CLAMPS cont'd**

**Duct Strap – Woven Polypropylene**

Webbed duct strap possessing high tensile and abrasion resistance. This can be used for flex duct as it is easy to cut and staple to joists. The product is chemical resistant and tested to meet UL Standard 2043.



| CATALOG NO.    | DESCRIPTION                              | UOM | ORDER MULTIPLE |
|----------------|--|-----|----------------|
| <b>710-100</b> | Duct Strap – 1-3/4" x 100 Yards – Black  | EA  | 24             |
| <b>710-101</b> | Duct Strap – 1-3/4" x 100 Yards – Silver | EA  | 24             |
| <b>710-102</b> | Duct Strap – 3" x 100 Yards – Black      | EA  | 8              |
| <b>710-103</b> | Duct Strap – 3" x 100 Yards – Silver     | EA  | 8              |

**Plastic Hanger Strap**

Flexible, non-conductive. 3/4 in. wide x .050 in. thick. Load tested to 120 lbs.



| CATALOG NO.     | DESCRIPTION      | UOM | ORDER MULTIPLE |
|-----------------|------------------|-----|----------------|
| <b>710-P100</b> | 3/4" x 100' Roll | EA  | 20             |

**TAPES**

**Stick-E-Tape**

Self adhesive aluminum tape with temperature range of 40 degree F to 200 degree F. Easily painted. Excellent vapor barrier; effective UV and water shield over urethane foam. Preferred duct and pipe wrap.



| CATALOG NO.  | DESCRIPTION                              | UOM | ORDER MULTIPLE |
|--------------|--|-----|----------------|
| <b>50302</b> | Stick-E-Tape – AFT-701-2 – 2" x 50' Roll | EA  | 24             |

**Aluminum Foil Tape**

Prevents heating and cooling losses. Blocks odors and moisture. Easy to handle. Use for HVAC and refrigeration systems. 35 degree F to plus 260 degree F working temperatures. 3-5 year shelf life. Made in USA.

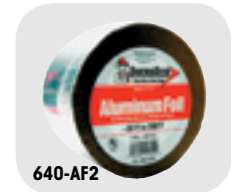

| CATALOG NO.     | DESCRIPTION                         | UOM | ORDER MULTIPLE |
|-----------------|-------------------------------------|-----|----------------|
| <b>640-AF2</b>  | 2" Aluminum Foil Tape – 50 yds.     | EA  | 24             |
| <b>640-AF25</b> | 2-1/2" Aluminum Foil Tape – 50 yds. | EA  | 20             |
| <b>640-AF3</b>  | 3" Aluminum Foil Tape – 50 yds.     | EA  | 16             |

**Flex Duct Tape**

Specially designed to meet new UL181B FX code for flex duct. Higher adhesion and tack than traditional cloth duct tapes. Conformable, hand tearable foil; 3 mil thickness. 2 in. x 120 yds. Code identification printed on the tape. Acrylic adhesive for superior performance in extreme environments. (35°F to 260°F)



| CATALOG NO.     | DESCRIPTION                  | UOM | ORDER MULTIPLE |
|-----------------|------------------------------|-----|----------------|
| <b>640-FD2S</b> | Flex Duct Tape – Silver – 2" | EA  | 24             |
| <b>640-FD2B</b> | Flex Duct Tape – Black – 2"  | EA  | 24             |
| <b>640-FD3S</b> | Flex Duct Tape – Silver – 3" | EA  | 16             |

**Foil Scrim Kraft Tape**

Non tearable, diamond patterned backing with an aggressive rubber based adhesive system for consistently dependable performance. Made in the USA.



| CATALOG NO.     | DESCRIPTION                           | UOM | ORDER MULTIPLE |
|-----------------|---------------------------------------|-----|----------------|
| <b>640-FSK2</b> | Foil Scrim Kraft Tape – 2" – 50 Yards | EA  | 24             |
| <b>640-FSK3</b> | Foil Scrim Kraft Tape – 3" – 50 Yards | EA  | 16             |

**UL Listed Foil Tape**

Unique acrylic adhesive for airtight bonds on joints and seams of fiberglass duct systems. Flexible, easy to use. Meets or exceeds performance standard AFLS 100 73 and UL 181 A P.



| CATALOG NO.     | DESCRIPTION                                 | UOM | ORDER MULTIPLE |
|-----------------|---|-----|----------------|
| <b>640-UL25</b> | UL 181 Listed Foil Tape – 2-1/2" – 60 Yards | EA  | 16             |
| <b>640-UL3</b>  | UL 181 Listed Foil Tape – 3" – 60 Yards     | EA  | 16             |

**Cloth Duct Tapes**

High tack, excellent strength. Superior performance in sealing air handling systems. Heavy cloth content for easier tearing and additional strength. Made in the USA.



| CATALOG NO.     | DESCRIPTION   | UOM | ORDER MULTIPLE |
|-----------------|---|-----|----------------|
| <b>PC-622-S</b> | 2" x 60 Yards – Premium Grade Duct Tape – Silver    | EA  | 24             |
| <b>PC-622-B</b> | 2" x 60 Yards – Premium Grade Duct Tape – Black     | EA  | 24             |
| <b>PC-609-S</b> | 2" x 60 Yards – Industrial Grade Duct Tape – Silver | EA  | 24             |
| <b>PC-609-B</b> | 2" x 60 Yards – Industrial Grade Duct Tape – Black  | EA  | 24             |
| <b>PC-600-S</b> | 2" x 60 Yards – Contractor Grade Duct Tape – Silver | EA  | 24             |
| <b>PC-600-B</b> | 2" x 60 Yards – Contractor Grade Duct Tape – Black  | EA  | 24             |
| <b>PC-857</b>   | 2" x 60 Yards – Metallized UL181B-FX Flex Duct Tape | EA  | 24             |

# HEATING PRODUCTS

Black Steel Welded Nipples..... 51  
 Carbon Monoxide & Smoke Alarms..... 49  
 DiversiTech Gas Connectors..... 50  
 Dormont Gas Valves and Connectors..... 50-51  
 Malleable Black Iron Pipe Fittings..... 52-53  
 TrueStart® Hot Surface Igniters .....48  
 TrueStart® Ignition Accessories.....48-49  
 Vent Termination Kits..... 49

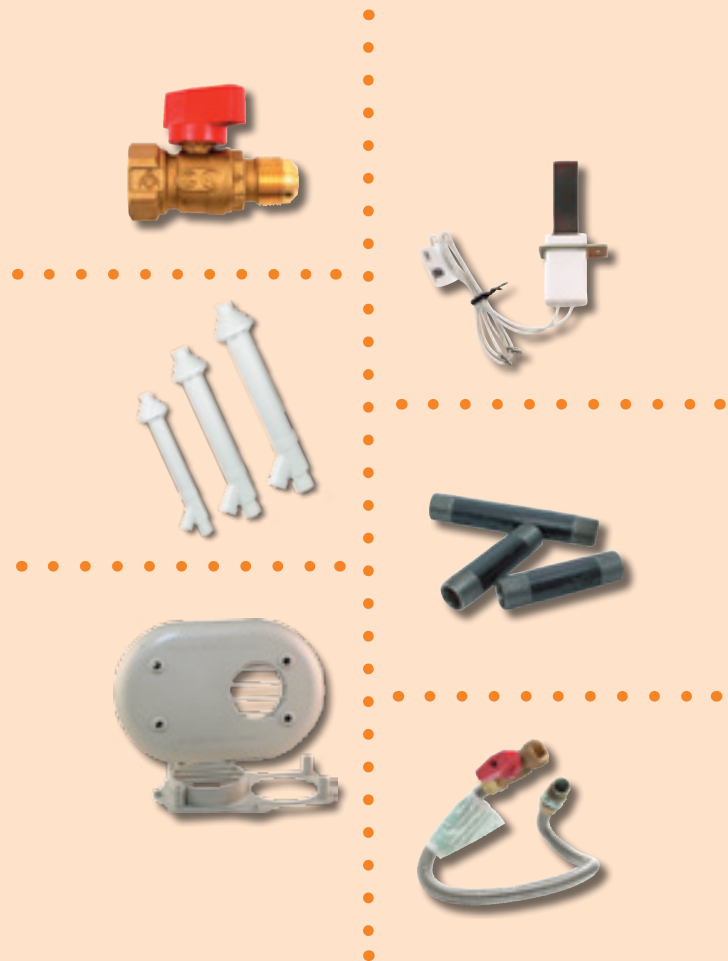



# TrueStart® Hot Surface Igniters



*TrueStart® hot surface igniters have been  
100% tested and approved.*

*TrueStart® hot surface igniters are completely reliable  
right out of the package and are certified by CSA  
for use in electrical equipment.*





TrueStart® universal hot surface igniters by DiversiTech are high quality replacements that fit hundreds of OEM components. TrueStart® universal igniters are durable and are designed to provide years of reliable service.

## BUILT TO LAST

TrueStart® universal igniters are available in silicon nitride and silicon carbide models. Silicon nitride is a very durable ceramic that is high fracture and temperature resistant and has a long life expectancy. Silicon nitride is a longer lasting material that is also more shock resistant. Silicon carbide is a naturally high temperature resistant metal that has been the standard used in heating equipment for years.

## JUST ONE REPLACES HUNDREDS

TrueStart® universal hot surface igniters feature a universal bracket kit that can be used to fit most all OEM furnaces. And TrueStart® hot surface igniters feature a unique universal electrical plug kit. This plug kit includes the most common crimp terminals and connector housings to fit the majority of OEM furnaces.

- ✓ *Durable ceramic material*
- ✓ *High thermal shock and chemical resistance*
- ✓ *Fracture resistant*
- ✓ *Long life*

## LONG WARRANTY

Every TrueStart® universal igniter includes a generous warranty period to ensure your satisfaction. The warranty on silicon nitride models is 3 full years and the warranty for silicon carbide igniters is 18 months.

## 100% TESTED

TrueStart® universal hot surface igniters have been 100% tested and approved. TrueStart® hot surface igniters are completely reliable right out of the package and are certified by CSA for use in electrical equipment.



*Each TrueStart® universal igniter also includes:*



*A universal bracket kit for a fast, easy installation.*



*A universal electrical plug connection kit to simplify installation.*



*Color coded packaging.*



**Made in U.S.A.**



# Vent Termination Kits

**Concentric vents** and termination kits allow both intake for combustion air and the exhaust vent to pass through a standard roof or sidewall. This makes it easier to have a two-pipe installation for high efficiency furnaces. These vents simplify installation and only require one hole through the wall or roof where the pipes terminate. Without using these vents, the installation would require cutting two holes through the home, one for each pipe. These vents save time and money by reducing the amount of work required.

**Horizontal vent kits** for use in venting high efficiency fossil fuel appliances. The low profile kit hides the vent from view.



### All Fittings included

DiversiTech's CVENT series concentric vent kit includes all fittings a contractor will need to install the vent. No additional fittings for outside connections are needed. Only piping from the vent kit to the furnace will need to be provided separately. Models are available for 2", 3" or 4" intake/vent systems.



### Low profile

The low profile of the HVENT series product creates a neat look for the vent connection. The simple and clean looking vent hides both the intake and exhaust pipework. Models are available for 2" or 3" vent systems.





## Flexible installation

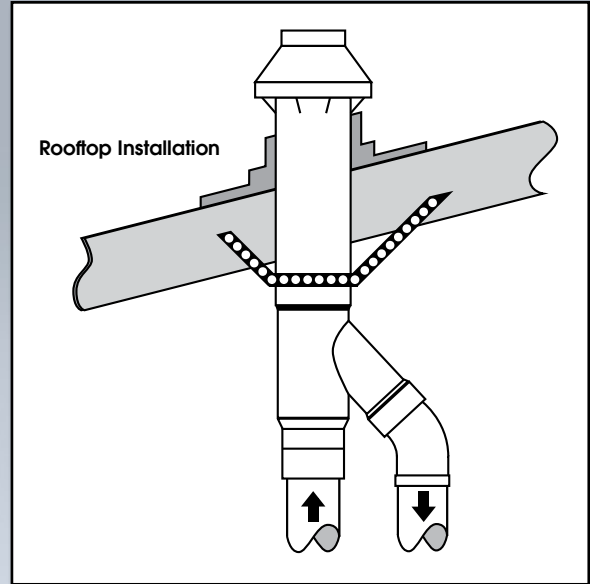
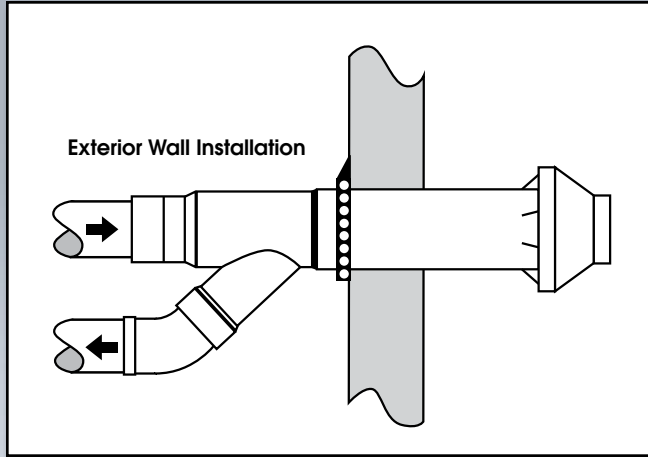

The same CVENT series vent kit can be used in either a horizontal (through the wall) or vertical (through the roof) installation.

**TRUESTART® HOT SURFACE IGNITERS**

**Wolverine® Universal Hot Surface Igniter**

Wolverine® hot surface igniters feature protective, dynamic, and informative packaging. Wolverine® hot surface igniters are 100% tested and completely reliable. They are compatible with all OEM furnaces. Universal hot surface igniters allow a contractor to reduce truck stock and replace hundreds of OEM igniters with just one SKU.



| CATALOG NO.     | DESCRIPTION   | UOM | ORDER MULTIPLE |
|-----------------|---|-----|----------------|
| <b>IGN-2</b>    | Wolverine Hot Surface Igniter by TrueStart, Universal, Silicon Nitride                              | EA  | 6              |
| <b>IGN-2-6P</b> | Wolverine Hot Surface Igniter by TrueStart, Universal, Silicon Nitride – Contractor Pack, pack of 6 | PK  | 1              |

**TrueStart™ Hot Surface Igniters**

TrueStart® hot surface igniters feature protective, dynamic, and informative packaging. TrueStart® hot surface igniters are 100% tested and completely reliable. They are compatible with all OEM furnaces. TrueStart® hot surface igniters are available as direct replacement for OEM (silicon carbide) or as a universal igniter (silicone carbide or silicon nitride). Universal hot surface igniters allow a contractor to reduce truck stock and replace hundreds of OEM igniters with just one SKU



| CATALOG NO.   | DESCRIPTION   | UOM | ORDER MULTIPLE |
|---------------|---|-----|----------------|
| <b>IGN-1R</b> | TrueStart™ Hot Surface Igniter, Universal, Round, Silicon Nitride | EA  | 6              |

**Direct Replacement Igniters**

TrueStart® hot surface igniters feature protective, dynamic, and informative packaging. TrueStart™ hot surface igniters are 100% tested and completely reliable. They are compatible with all OEM furnaces. TrueStart® hot surface igniters are available as direct replacement for OEM silicon carbide igniters.



| CATALOG NO.    | DESCRIPTION   | UOM | ORDER MULTIPLE |
|----------------|---|-----|----------------|
| <b>IGN-401</b> | TrueStart™ Hot Surface Igniter, Direct Replacement, Silicon Carbide | EA  | 6              |
| <b>IGN-402</b> | TrueStart™ Hot Surface Igniter, Direct Replacement, Silicon Carbide | EA  | 6              |
| <b>IGN-403</b> | TrueStart™ Hot Surface Igniter, Direct Replacement, Silicon Carbide | EA  | 6              |
| <b>IGN-409</b> | TrueStart™ Hot Surface Igniter, Direct Replacement, Silicon Carbide | EA  | 6              |

**Universal Silicon Carbide Igniters**

TrueStart® hot surface igniters feature protective, dynamic, and informative packaging. TrueStart™ hot surface igniters are 100% tested and completely reliable. They are compatible with all OEM furnaces. TrueStart® hot surface igniters are available as a universal silicon carbide igniter.

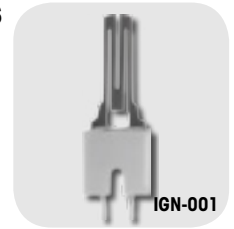

| CATALOG NO.    | DESCRIPTION  | UOM | ORDER MULTIPLE |
|----------------|--|-----|----------------|
| <b>IGN-001</b> | TrueStart™ Hot Surface Igniter, Universal, Silicon Carbide | EA  | 6              |

**TRUESTART® IGNITION ACCESSORIES**

**TrueStart® Pilot Burners**

TrueStart® pilot burners are a direct replacement for Carrier/BDP pilot burners. Available in 2 wire and 3 wire versions. The 3 wire is also field convertible to a 2 wire. TrueStart® pilot burners are not manufactured by Carrier Corporation.



| CATALOG NO.  | DESCRIPTION   | UOM | ORDER MULTIPLE |
|--------------|---|-----|----------------|
| <b>FC-73</b> | 2 Wire Pilot Burner – Replacement for the Carrier® 732 2 wire pilot burner commonly known as Carrier®/BDP part number LH33JZ053 | EA  | 1              |
| <b>FC-74</b> | 3 Wire Pilot Burner – Replacement for the Carrier® 740A 3 wire pilot burner commonly known as Carrier®/BDP part number LH680005 | EA  | 1              |

**TRUESTART® IGNITION ACCESSORIES cont'd**

**TrueStart® Flame Sensors**

TrueStart® flame sensors are a direct replacement for Carrier/BDP flame sensors, cross reference part numbers are detailed in the item descriptions. TrueStart® flame sensors are not manufactured by Carrier Corporation.



**TrueStart® Spark Electrode**

Replacement pilots and accessories for selected Carrier/BDP units. Full 2 year warranty. Made in America.

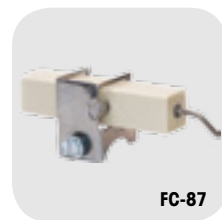

| CATALOG NO.  | DESCRIPTION   | UOM | ORDER MULTIPLE |
|--------------|---|-----|----------------|
| <b>900-3</b> | TrueStart™ FLAME SENSOR replaces Carrier® LH33WZ516 | EA  | 1              |
| <b>900-4</b> | TrueStart™ FLAME SENSOR replaces Carrier® LH33WZ517 | EA  | 1              |
| <b>900-5</b> | TrueStart™ FLAME SENSOR replaces Carrier® LH33WZ518 | EA  | 1              |
| <b>900-6</b> | TrueStart™ FLAME SENSOR replaces Carrier® LH33WZ520 | EA  | 1              |

| CATALOG NO.  | DESCRIPTION  | UOM | ORDER MULTIPLE |
|--------------|--|-----|----------------|
| <b>FC-87</b> | Spark Electrode – Replacement for the Carrier®/BDP 871 Spark Electrode commonly known as Carrier®/BDP part number LH680512 | EA  | 1              |

**VENT TERMINATION KITS**

**Concentric Vents**

Concentric vents make it easier to have a two pipe installation for high efficiency furnaces. These vents simplify installation and only require one hole through the wall or roof where the pipes terminate. Without using these vents, the installation would require cutting two holes through the home, one for each pipe. These vents save time and money by reducing the amount of work required. Available in 2", 3" or 4" intake vent sizes.

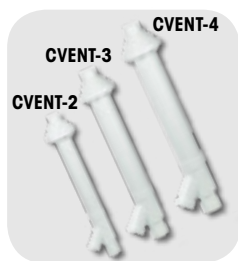

**Horizontal Vent Termination Kits**

Horizontal vent kits for use in venting high efficiency fossil fuel appliances. The low profile kit hides the vent from view.



| CATALOG NO.      | DESCRIPTION                 | UOM | ORDER MULTIPLE |
|------------------|-----------------------------|-----|----------------|
| <b>CVENT-2</b>   | 2" Concentric Vent          | EA  | 1              |
| <b>CVENT-3</b>   | 3" Concentric Vent          | EA  | 1              |
| <b>CVENT-4</b>   | 4" Concentric Vent          | EA  | 1              |
| <b>CVENTCAP2</b> | Replacement cap for CVENT-2 | EA  | 1              |
| <b>CVENTCAP3</b> | Replacement cap for CVENT-3 | EA  | 1              |
| <b>CVENTCAP4</b> | Replacement cap for CVENT-4 | EA  | 1              |
| <b>CVS-2</b>     | Vent screen for CVENT-2     | EA  | 1              |
| <b>CVS-3</b>     | Vent screen for CVENT-3     | EA  | 1              |

| CATALOG NO.    | DESCRIPTION                         | UOM | ORDER MULTIPLE |
|----------------|-------------------------------------|-----|----------------|
| <b>HVENT-2</b> | Horizontal Termination Kit - 2 inch | EA  | 6              |
| <b>HVENT-3</b> | Horizontal Termination Kit - 3 inch | EA  | 6              |

**CARBON MONOXIDE & SMOKE ALARMS**

**Carbon Monoxide Alarms**

- 10 year sealed batteries provide continuous protection
- Microprocessor intelligence combined with electrochemical sensor virtually eliminates nuisance alarms
- Red LED indicates the status of power and CO
- Table top (free standing) or wall mounted. Mounting hardware included.
- Exceeds industry standards, ETL listed to UL Standard UL 2034 and California State Fire Marshal approved.
- 10 year limited warranty on both battery and alarm



**Combination Carbon Monoxide and Smoke Alarms**

- 3-in-1 alarm provides triple the protection with a single installation to protect against fires, carbon monoxide and natural gas
- 120-volt AC/DC hardwired alarm with backup battery is suitable for houses, apartments and mobile homes
- Mount the bracket to any standard wiring junction box and use the large mounting base to cover imperfections in drywall
- Features a quick activation pull-tab and a front-loading battery drawer for replacement without removing the alarm from the bracket
- Comes with a 7 year limited warranty



| CATALOG NO.    | DESCRIPTION                 | UOM | ORDER MULTIPLE |
|----------------|-----------------------------|-----|----------------|
| <b>CM-1000</b> | Carbon Monoxide Smart Alarm | EA  | 1              |

| CATALOG NO.    | DESCRIPTION                                  | UOM | ORDER MULTIPLE |
|----------------|--|-----|----------------|
| <b>MICN109</b> | Smoke, Carbon Monoxide and Natural Gas Alarm | EA  | 6              |



**DIVERSITECH GAS CONNECTORS**

**DiversiTech Gas Connectors 1/2" OD**

Combining flexibility, durability, and functionality, DiversiTech stainless steel gas connectors are CSA design certified and 100% leak tested for quality and security. DiversiTech gas connectors are durable and reliable to give you everything you need. Available in a variety of sizes and lengths.



**D20-3132-18**

| CATALOG NO.        | DESCRIPTION  | UOM | ORDER MULTIPLE |
|--------------------|--|-----|----------------|
| <b>D20-3132-18</b> | Gas Connector – 18" long, 1/2" OD x 3/8" ID, M x F | EA  | 12             |
| <b>D20-3132-24</b> | Gas Connector – 24" long, 1/2" OD x 3/8" ID, M x F | EA  | 12             |
| <b>D20-3132-36</b> | Gas Connector – 36" long, 1/2" OD x 3/8" ID, M x F | EA  | 12             |
| <b>D20-3132-48</b> | Gas Connector – 48" long, 1/2" OD x 3/8" ID, M x F | EA  | 12             |

**Epoxy Coated Gas Connectors**

Yellow coated gas connectors include an epoxy coating for added durability and extra protection from corrosion, chemical stains from common household products and plumbing repairs.



**DC30-3132-18**

| CATALOG NO.         | DESCRIPTION   | UOM | ORDER MULTIPLE |
|---------------------|---|-----|----------------|
| <b>DC30-3132-18</b> | Gas Connector coated – 18" long, 5/8" OD x 1/2" ID, M x F | EA  | 12             |
| <b>DC30-3132-24</b> | Gas Connector coated – 24" long, 5/8" OD x 1/2" ID, M x F | EA  | 12             |
| <b>DC30-3132-36</b> | Gas Connector coated – 36" long, 5/8" OD x 1/2" ID, M x F | EA  | 12             |
| <b>DC30-3132-48</b> | Gas Connector coated – 48" long, 5/8" OD x 1/2" ID, M x F | EA  | 12             |

**DiversiTech Gas Connectors 5/8" OD**

Combining flexibility, durability, and functionality, DiversiTech stainless steel gas connectors are CSA design certified and 100% leak tested for quality and security. DiversiTech gas connectors are durable and reliable to give you everything you need. Available in a variety of sizes and lengths.



**D30-3132-18**

| CATALOG NO.        | DESCRIPTION  | UOM | ORDER MULTIPLE |
|--------------------|--|-----|----------------|
| <b>D30-3131-24</b> | Gas Connector – 24" long, 5/8" OD x 1/2" ID, M x M | EA  | 12             |
| <b>D30-3131-36</b> | Gas Connector – 36" long, 5/8" OD x 1/2" ID, M x M | EA  | 12             |
| <b>D30-3131-48</b> | Gas Connector – 48" long, 5/8" OD x 1/2" ID, M x M | EA  | 12             |
| <b>D30-3132-18</b> | Gas Connector – 18" long, 5/8" OD x 1/2" ID, M x F | EA  | 12             |
| <b>D30-3132-24</b> | Gas Connector – 24" long, 5/8" OD x 1/2" ID, M x F | EA  | 12             |
| <b>D30-3132-36</b> | Gas Connector – 36" long, 5/8" OD x 1/2" ID, M x F | EA  | 12             |
| <b>D30-3132-48</b> | Gas Connector – 48" long, 5/8" OD x 1/2" ID, M x F | EA  | 12             |

**DORMONT GAS CONNECTORS AND VALVES**

**Dormont 20 Series**

1/2" O.D. x 3/8" I.D. 1/2" MIP x 1/2" FIP Connectors



**20-3132-18**

| CATALOG NO.       | DESCRIPTION              | UOM | ORDER MULTIPLE |
|-------------------|--------------------------|-----|----------------|
| <b>20-3132-18</b> | Gas Connector – 18" Long | EA  | 12             |
| <b>20-3132-24</b> | Gas Connector – 24" Long | EA  | 12             |
| <b>20-3132-36</b> | Gas Connector – 36" Long | EA  | 12             |
| <b>20-3132-48</b> | Gas Connector – 48" Long | EA  | 12             |

**Dormont 30 Series**

Corrugated, stainless steel connectors with special Supr Safe® design to increase flexibility. Maximum service and safety, approved for indoor or outdoor use. Perfect for range and furnace connection. AGA and CGA approved. 3131 Series: 5/8" O.D. x 1/2" I.D. 1/2" MIP x 1/2" MIP Connectors. 3132 Series: 5/8" O.D. x 1/2" I.D. 1/2" MIP x 1/2" FIP Connectors.



**30-3132-18**

| CATALOG NO.       | DESCRIPTION              | UOM | ORDER MULTIPLE |
|-------------------|--------------------------|-----|----------------|
| <b>30-3131-24</b> | Gas Connector – 24" Long | EA  | 12             |
| <b>30-3131-36</b> | Gas Connector – 36" Long | EA  | 12             |
| <b>30-3131-48</b> | Gas Connector – 48" Long | EA  | 12             |
| <b>30-3132-12</b> | Gas Connector – 12" Long | EA  | 12             |
| <b>30-3132-18</b> | Gas Connector – 18" Long | EA  | 12             |
| <b>30-3132-24</b> | Gas Connector – 24" Long | EA  | 12             |
| <b>30-3132-30</b> | Gas Connector – 30" Long | EA  | 12             |
| <b>30-3132-36</b> | Gas Connector – 36" Long | EA  | 12             |
| <b>30-3132-48</b> | Gas Connector – 48" Long | EA  | 12             |
| <b>30-3132-60</b> | Gas Connector – 60" Long | EA  | 12             |
| <b>30-3132-72</b> | Gas Connector – 72" Long | EA  | 12             |

**DORMONT GAS CONNECTORS AND VALVES cont'd**

**Dormont 20 Series with Valve**

Corrugated stainless steel connectors with special Supr Safe design to increase flexibility. Maximum service and safety and is approved for both indoor and outdoor use. This is perfect for range and furnace connections. This Series is AA and CGA approved. This connector comes in 20 3135 18 1/2" O.D. x 3/8" I.D. x 1/2" FIP Ball Valve.



20-3135-18

| CATALOG NO.       | DESCRIPTION              | UOM | ORDER MULTIPLE |
|-------------------|--------------------------|-----|----------------|
| <b>20-3135-18</b> | Gas Connector – 18" Long | EA  | 12             |
| <b>20-3135-24</b> | Gas Connector – 24" Long | EA  | 12             |
| <b>20-3135-36</b> | Gas Connector – 36" Long | EA  | 12             |
| <b>20-3135-48</b> | Gas Connector – 48" Long | EA  | 12             |

**Gas Ball Valve**

Gas Ball Valves meet the stringent ISO 9000 quality standard. AGA and CGA certified.



91-3042

| CATALOG NO.    | DESCRIPTION  | UOM | ORDER MULTIPLE |
|----------------|--|-----|----------------|
| <b>91-3042</b> | 5/8" O.D. Flare x 3/4" FIP for "30 Series" Gas Conn. | EA  | 10             |
| <b>91-2032</b> | 1/2" O.D. Flare x 1/2" FIP for "20 Series" Gas Conn. | EA  | 10             |
| <b>92-3232</b> | 1/2" FIP x 1/2" FIP                                  | EA  | 10             |
| <b>92-4242</b> | 3/4" FIP x 3/4" FIP                                  | EA  | 10             |

**BLACK STEEL WELDED NIPPLES**

**Black Steel Welded Nipples**

Welded Steel that withstands 700 PSI test pressure is perfect for everyday use. The specs for this product are ASTM A 120 (Nom B 10) and the thickness is Sch. 40.



BPN-5

| CATALOG NO.   | DESCRIPTION                       | UOM | ORDER MULTIPLE |
|---------------|-----------------------------------|-----|----------------|
| <b>BPN-1</b>  | 1/2" x CL Black Welded Nipple     | EA  | 25             |
| <b>BPN-2</b>  | 1/2" x 1-1/2" Black Welded Nipple | EA  | 25             |
| <b>BPN-3</b>  | 1/2" x 2" Black Welded Nipple     | EA  | 25             |
| <b>BPN-4</b>  | 1/2" x 2-1/2" Black Welded Nipple | EA  | 25             |
| <b>BPN-5</b>  | 1/2" x 3" Black Welded Nipple     | EA  | 25             |
| <b>BPN-6</b>  | 1/2" x 3-1/2" Black Welded Nipple | EA  | 25             |
| <b>BPN-7</b>  | 1/2" x 4" Black Welded Nipple     | EA  | 20             |
| <b>BPN-8</b>  | 1/2" x 4-1/2" Black Welded Nipple | EA  | 15             |
| <b>BPN-9</b>  | 1/2" x 5" Black Welded Nipple     | EA  | 15             |
| <b>BPN-10</b> | 1/2" x 5-1/2" Black Welded Nipple | EA  | 25             |
| <b>BPN-11</b> | 1/2" x 6" Black Welded Nipple     | EA  | 15             |
| <b>BPN-12</b> | 1/2" x 7" Black Welded Nipple     | EA  | 25             |
| <b>BPN-13</b> | 1/2" x 8" Black Welded Nipple     | EA  | 15             |
| <b>BPN-14</b> | 1/2" x 9" Black Welded Nipple     | EA  | 25             |
| <b>BPN-15</b> | 1/2" x 10" Black Welded Nipple    | EA  | 15             |
| <b>BPN-16</b> | 1/2" x 11" Black Welded Nipple    | EA  | 25             |
| <b>BPN-17</b> | 1/2" x 12" Black Welded Nipple    | EA  | 15             |
| <b>BPN-18</b> | 3/4" x CL Black Welded Nipple     | EA  | 25             |
| <b>BPN-19</b> | 3/4" x 1-1/2" Black Welded Nipple | EA  | 25             |
| <b>BPN-20</b> | 3/4" x 2" Black Welded Nipple     | EA  | 25             |
| <b>BPN-21</b> | 3/4" x 2-1/2" Black Welded Nipple | EA  | 25             |
| <b>BPN-22</b> | 3/4" x 3" Black Welded Nipple     | EA  | 15             |
| <b>BPN-23</b> | 3/4" x 3-1/2" Black Welded Nipple | EA  | 15             |
| <b>BPN-24</b> | 3/4" x 4" Black Welded Nipple     | EA  | 15             |
| <b>BPN-25</b> | 3/4" x 4-1/2" Black Welded Nipple | EA  | 20             |

**Black Steel Welded Nipples (cont'd)**

| CATALOG NO.    | DESCRIPTION   | UOM | ORDER MULTIPLE |
|----------------|---|-----|----------------|
| <b>BPN-26</b>  | 3/4" x 5" Black Welded Nipple                             | EA  | 20             |
| <b>BPN-28</b>  | 3/4" x 6" Black Welded Nipple                             | EA  | 15             |
| <b>BPN-29</b>  | 3/4" x 7" Black Welded Nipple                             | EA  | 25             |
| <b>BPN-30</b>  | 3/4" x 8" Black Welded Nipple                             | EA  | 10             |
| <b>BPN-31</b>  | 3/4" x 9" Black Welded Nipple                             | EA  | 25             |
| <b>BPN-32</b>  | 3/4" x 10" Black Welded Nipple                            | EA  | 10             |
| <b>BPN-33</b>  | 3/4" x 11" Black Welded Nipple                            | EA  | 25             |
| <b>BPN-34</b>  | 3/4" x 12" Black Welded Nipple                            | EA  | 15             |
| <b>BPN-35</b>  | 1" x CL Black Welded Nipple                               | EA  | 25             |
| <b>BPN-37</b>  | 1" x 2" Black Welded Nipple                               | EA  | 25             |
| <b>BPN-38</b>  | 1" x 2-1/2" Black Welded Nipple                           | EA  | 25             |
| <b>BPN-39</b>  | 1" x 3" Black Welded Nipple                               | EA  | 5              |
| <b>BPN-40</b>  | 1" x 3-1/2" Black Welded Nipple                           | EA  | 5              |
| <b>BPN-41</b>  | 1" x 4" Black Welded Nipple                               | EA  | 10             |
| <b>BPN-43</b>  | 1" x 5" Black Welded Nipple                               | EA  | 5              |
| <b>BPN-44</b>  | 1" x 5-1/2" Black Welded Nipple                           | EA  | 10             |
| <b>BPN-45</b>  | 1" x 6" Black Welded Nipple                               | EA  | 5              |
| <b>BPN-46</b>  | 1" x 7" Black Welded Nipple                               | EA  | 10             |
| <b>BPN-47</b>  | 1" x 8" Black Welded Nipple                               | EA  | 5              |
| <b>BPN-48</b>  | 1" x 9" Black Welded Nipple                               | EA  | 10             |
| <b>BPN-50</b>  | 1" x 11" Black Welded Nipple                              | EA  | 10             |
| <b>BPN-51</b>  | 1" x 12" Black Welded Nipple                              | EA  | 5              |
| <b>BPN-52</b>  | 1/2" x 18" Black Welded Nipple                            | EA  | 5              |
| <b>BPN-53</b>  | 1/2" x 24" Black Welded Nipple                            | EA  | 3              |
| <b>BPN-54</b>  | 1/2" x 36" Black Welded Nipple                            | EA  | 5              |
| <b>BPN-A12</b> | 1/2" Assortment Pack, 6 each of CL thru 6", pack of 66 PK | PK  | 2              |
| <b>BPN-A34</b> | 3/4" Assortment Pack, 6 each of CL thru 6", pack of 66 PK | PK  | 2              |

**MALLEABLE BLACK IRON PIPE FITTINGS**

**90 Degree Ell**

- Material: ASTM A 197 Cupola Malleable Iron, 150 lb.
- Dimensions:  
ANSI B 16.3 - Malleable Iron Threaded Fittings  
ANSI B 16.14 - Ferrous Pipe Plugs, Bushings etc.  
ANSI B 16.39 - Malleable Iron Threaded Pipe Unions
- Threads: ANSI B 2.1 or BS 21
- Tensile Strength: 28.4 kg/mm.min



| CATALOG NO.   | DESCRIPTION          | UOM | ORDER MULTIPLE |
|---------------|----------------------|-----|----------------|
| <b>BPF-01</b> | 1/2" 90 Degree Elbow | EA  | 50             |
| <b>BPF-02</b> | 3/4" 90 Degree Elbow | EA  | 35             |
| <b>BPF-03</b> | 1" 90 Degree Elbow   | EA  | 20             |

**Coupling**

The Coupling fitting is made of ASTM A 197 Cupola Malleable Iron, 150 LB. The dimensions for this fitting are ANSI B 16.3. The threads are ANSI V 2.1 or BS 21 and the tensile strength is 28.4 kg/mm.min for this fitting.



| CATALOG NO.   | DESCRIPTION   | UOM | ORDER MULTIPLE |
|---------------|---------------|-----|----------------|
| <b>BPF-07</b> | 1/2" Coupling | EA  | 60             |
| <b>BPF-08</b> | 3/4" Coupling | EA  | 50             |
| <b>BPF-09</b> | 1" Coupling   | EA  | 25             |

**90 Degree Street Ell**

The 90 Degree Street Ell fitting is made of ASTM A 197 Cupola Malleable Iron, 150 LB. The dimensions for this fitting are ANSI B 16.3. The threads are ANSI V 2.1 or BS 21 and the tensile strength is 28.4 kg/mm.min for this fitting.



| CATALOG NO.   | DESCRIPTION                 | UOM | ORDER MULTIPLE |
|---------------|-----------------------------|-----|----------------|
| <b>BPF-13</b> | 1/2" 90 Degree Street Elbow | EA  | 60             |
| <b>BPF-14</b> | 3/4" 90 Degree Street Elbow | EA  | 35             |

**Reducing Tee**

The Reducing Tee fitting is made of ASTM A 197 Cupola Malleable Iron, 150 LB. The dimensions for this fitting are ANSI B 16.3. The threads are ANSI V 2.1 or BS 21 and the tensile strength is 28.4 kg/mm.min for this fitting.



| CATALOG NO.   | DESCRIPTION                     | UOM | ORDER MULTIPLE |
|---------------|---------------------------------|-----|----------------|
| <b>BPF-20</b> | 3/4" x 1/2" x 1/2" Reducing Tee | EA  | 25             |
| <b>BPF-21</b> | 3/4" x 1/2" x 3/4" Reducing Tee | EA  | 20             |
| <b>BPF-34</b> | 1" x 1" x 1/2" Reducing Tee     | EA  | 15             |

**45 Degree Ell**

The 45 Degree Ell fitting is made of ASTM A 197 Cupola Malleable Iron, 150 LB. The dimensions for this fitting are ANSI B 16.3. The threads are ANSI V 2.1 or BS 21 and the tensile strength is 28.4 kg/mm.min for this fitting.



| CATALOG NO.   | DESCRIPTION          | UOM | ORDER MULTIPLE |
|---------------|----------------------|-----|----------------|
| <b>BPF-04</b> | 1/2" 45 Degree Elbow | EA  | 50             |
| <b>BPF-05</b> | 3/4" 45 Degree Elbow | EA  | 40             |
| <b>BPF-06</b> | 1" 45 Degree Elbow   | EA  | 15             |

**Reducing Coupling**

The Reducing Coupling fitting is made of ASTM A 197 Cupola Malleable Iron, 150 LB. The dimensions for this fitting are ANSI B 16.3. The threads are ANSI V 2.1 or BS 21 and the tensile strength is 28.4 kg/mm.min for this fitting.



| CATALOG NO.   | DESCRIPTION                   | UOM | ORDER MULTIPLE |
|---------------|-------------------------------|-----|----------------|
| <b>BPF-10</b> | 3/4" x 1/2" Reducing Coupling | EA  | 60             |
| <b>BPF-11</b> | 1" x 1/2" Reducing Coupling   | EA  | 30             |
| <b>BPF-12</b> | 1" x 3/4" Reducing Coupling   | EA  | 25             |

**Tee**

The Tee fitting is made of ASTM A 197 Cupola Malleable Iron, 150 LB. The dimensions for this fitting are ANSI B 16.3. The threads are ANSI V 2.1 or BS 21 and the tensile strength is 28.4 kg/mm.min for this fitting.



| CATALOG NO.   | DESCRIPTION | UOM | ORDER MULTIPLE |
|---------------|-------------|-----|----------------|
| <b>BPF-16</b> | 1/2" Tee    | EA  | 40             |
| <b>BPF-17</b> | 3/4" Tee    | EA  | 35             |
| <b>BPF-18</b> | 1" Tee      | EA  | 20             |

**Bushing**

The Bushing fitting is made of ASTM A 197 Cupola Malleable Iron, 150 LB. The dimensions for this fitting are ANSI B 16.14. The threads are ANSI V 2.1 or BS 21 and the tensile strength is 28.4 kg/mm.min for this fitting.



| CATALOG NO.   | DESCRIPTION             | UOM | ORDER MULTIPLE |
|---------------|-------------------------|-----|----------------|
| <b>BPF-22</b> | 3/4" x 1/2" Hex Bushing | EA  | 75             |
| <b>BPF-23</b> | 1" x 1/2" Hex Bushing   | EA  | 50             |



### Cap

The Cap fitting is made of ASTM A 197 Cupola Malleable Iron, 150 LB. The dimensions for this fitting are ANSI B 16.3. The threads are ANSI V 2.1 or BS 21 and the tensile strength is 28.4 kg/mm.min for this fitting.



| CATALOG NO.   | DESCRIPTION | UOM | ORDER MULTIPLE |
|---------------|-------------|-----|----------------|
| <b>BPF-25</b> | 1/2" Cap    | EA  | 75             |
| <b>BPF-26</b> | 3/4" Cap    | EA  | 40             |
| <b>BPF-27</b> | 1" Cap      | EA  | 35             |

### Plug

The Plug fitting is made of ASTM A 197 Cupola Malleable Iron, 150 LB. The dimensions for this fitting are ANSI B 16.14. The threads are ANSI V 2.1 or BS 21 and the tensile strength is 28.4 kg/mm.min for this fitting.



| CATALOG NO.   | DESCRIPTION | UOM | ORDER MULTIPLE |
|---------------|-------------|-----|----------------|
| <b>BPF-28</b> | 1/2" Plug   | EA  | 50             |
| <b>BPF-29</b> | 3/4" Plug   | EA  | 30             |

### Union

The Union fitting is made of ASTM A 197 Cupola Malleable Iron, 150 LB. The dimensions for this fitting are ANSI B 16.39. The threads are ANSI V 2.1 or BS 21 and the tensile strength is 28.4 kg/mm.min for this fitting.



| CATALOG NO.   | DESCRIPTION | UOM | ORDER MULTIPLE |
|---------------|-------------|-----|----------------|
| <b>BPF-31</b> | 1/2" Union  | EA  | 50             |
| <b>BPF-32</b> | 3/4" Union  | EA  | 35             |
| <b>BPF-33</b> | 1" Union    | EA  | 20             |

In a class by itself.



The **ClearVue™** condensate pump isn't like all the other pumps. It features Floatless Sensor™ technology for super reliable operation without a mechanical float — No Float, No Problems. And ClearVue even has a brain. Built-in Variable Speed and Lift adjusts pump speed and lift as needed so ClearVue can adapt to any conditions. ClearVue even cleans itself to ensure worry-free operation. Learn more about how ClearVue stands out from the crowd at [www.diversitech.com](http://www.diversitech.com)

# CONDENSATE MANAGEMENT

ClearVue™ Tube & Traps.....78  
 Condensate Drain Line Cleaning .....78-79  
 Condensate Drain Line Switches ..... 77  
 Condensate Drain Pans, Fittings, Adapters.....79-81  
 Condensate Pumps.....76-77  
 Drain Line, Tubing .....81  
 Tapes .....82





# ClearVue™ Pump

## About ClearVue™

The new ClearVue™ condensate pump from DiversiTech is unlike any other pump available. ClearVue™ features Variable Speed and Lift which makes ClearVue™ the smartest condensate pump on the market. Variable Speed and Lift provides ClearVue™ the ability to “think” and adapt to changing conditions. It’s not just off or on like a regular pump. ClearVue™ senses the amount of condensate water in the tank and its rate of inflow and adjusts its speed and lift to match the conditions and keep the tank clear. ClearVue™ starts pumping slowly and only accelerates if needed. And since it pumps slowly, ClearVue™ is super quiet and easy to live with.

With its Floatless Sensor™ technology, ClearVue™ doesn’t have the usual problems associated with float switch pumps. No more stuck floats or misaligned contacts to cause problems and potential damage. ClearVue™ uses Floatless Sensor™ technology to detect the condensate level in the tank and make the right decision about what to do next. ClearVue™ pump also features a see-through tank to give the contractor and homeowner a clear view of water, blockage, and buildup in the tank. This clear tank allows for quick troubleshooting due to normal buildup caused by daily condensate generation. ClearVue™ gives you the most improved, user-inspired features on the market.

## What makes ClearVue™ Better?

- The ClearVue™ pump features Variable Speed and Lift which allows ClearVue™ to change pump speed and lift based on condensate flow. Other pumps are simply off or on but ClearVue™ starts pumping slowly, then gradually accelerates its lift if needed.
- Floatless Sensor™ technology means more reliable operation and no problems from stuck or fouled mechanical floats. ClearVue’s Floatless Sensor™ detects the condensate level without a float for reliable, accurate operation. **No float, no problems.**
- World’s only self-cleaning condensate pump. ClearVue™ features a unique self-cleaning mode to maintain itself and help help keep drain lines clear. Also, if ClearVue™ senses a blockage, it will begin self-cleaning and pulse the condensate water to try to remove the blockage.
- ClearVue™ also offers a clear tank that allows the user to see what’s happening inside. This means faster and more accurate troubleshooting.



**FLOATLESS  
SENSOR™**

**ClearVue**  
PUMP™

**0-22'**  
Variable Speed  
and Lift  
Self-Cleaning



Stainless Steel  
Mounting Tabs

Reversible  
Deck

Clear Tank

**FLOATLESS  
SENSOR**™

Silicone  
Rubber Feet

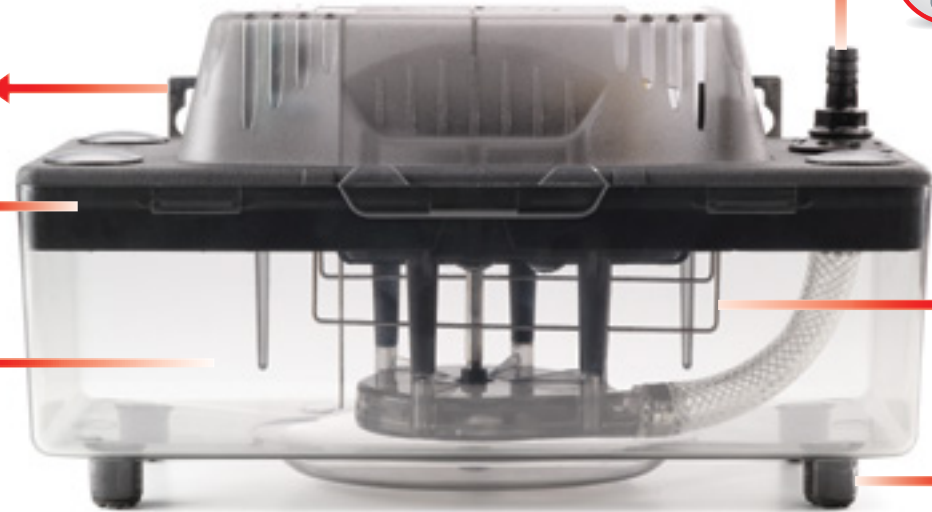

**NO FLOAT, NO PROBLEMS**



**Floatless Sensor™ Technology**  
ClearVue's sensors tell it how high the water is in the tank and how fast the inflow is. It then adjusts pump speed and lift to keep the tank clear and the system running properly. *No float, no problems.*



**Push Button Drain**  
Need to drain the tank quickly? Simply push the DRAIN button and ClearVue™ removes all the water in the tank—fast.



**Clear Tank**  
ClearVue™ also offers a clear tank so you can easily see what's happening inside the tank. The clear tank makes it easy to see the water level and diagnose other issues if needed.



**Check Valve**  
Removable duckbill check valve resists corrosion and wear and is self-cleaning.

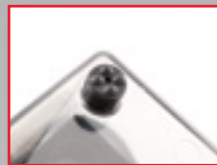

**Molded Silicone Rubber Feet**  
Specially designed rubber feet dampen vibration and noise, making ClearVue™ quiet and easy to live with. And like the feet on all DiversiTech pumps, they are installed at the factory and stay in place.



**Stainless Steel Hang Tabs**  
Two stainless steel hanging tabs offer many installation options. The tabs are sturdy and durable and will last longer than standard plastic mounts.



**LED Indicator Lights**  
4 LED indicator lights – Ready, Pumping, Cleaning, and Alarm. LED lights tell you what mode the pump is in at any given time.

# ClearVue™ Mini Pump

*ClearVue™ Mini is the newest innovation in Ductless System pumps from DiversiTech. It's small, quiet and offers a host of unique features that help it outperform other mini-split pumps. And just like the original ClearVue™ and ClearVueKube™ pumps, ClearVue™ Mini features Variable Speed and Lift and Floatless Sensor™ technology that help the pump think and respond to changing conditions.*





Look at everything ClearVue™ Mini offers:

## NO FLOAT, NO PROBLEMS



### Variable Speed and Lift

ClearVue™ Mini determines how fast condensate is entering the tank and adjusts its speed and lift to match the conditions and keep the tank clear.



### Aluminum Pump Housing

ClearVue™ Mini features an aluminum housing that is built to last. This tough housing protects the pump from physical damage and helps contribute to the super quiet operation of the pump.

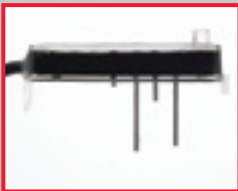

### Floatless Sensor™ Technology

**No float, no problem!** That's what ClearVue™ Mini's Floatless Sensor™ will provide you and your customers. ClearVue™ Mini's Floatless Sensor™ eliminates many of the typical problems associated with conventional condensate pumps. By eliminating the float, ClearVue™ Mini won't fail like conventional float-switch pumps.



### Rubber Mounting Pad

The molded rubber mounting pad can be used to mount ClearVue™ Mini to a vertical or horizontal surface; or to copper refrigerant lines with cable ties. The rubber pad decreases sound and vibration, contributing to a very quiet pump.

ClearVue™ Mini uses Floatless Sensor™ technology in different levels in the tank to provide the most accurate water level information to the pump's brain. And better information means a better pump. ClearVue's Floatless Sensor™ technology tells it how high the water is in the tank and how fast the inflow is. ClearVue™ Mini then uses this information to adjust its pump speed and lift to keep the tank clear and the system running properly.

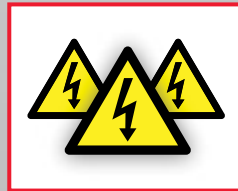

### Multiple Voltages

ClearVue™ Mini can be powered with any voltage from 120 to 240V, 50 or 60 Hz. With one product suitable for multiple voltages, there is no need to stock separate SKUs for different voltages.



### Super Quiet

With Variable Speed and Lift ClearVue™ Mini is nearly inaudible. You literally can hardly hear the pump run. This quiet operation allows maximum installation flexibility, as you can place the pump right in the room where people are.



### LED Lights

ClearVue™ Mini features three LED indicator lights: Ready, Pumping, and Alarm. The LED lights tell you what mode the pump is in at any given time.

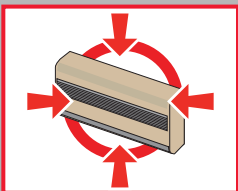

### Flexible Installation

ClearVue™ Mini is compact — only 3-1/2" x 2" x 3". It fits almost anywhere including inside a line set cover, inside the wall cassette unit (on some cassette models), and easily installs in the ceiling or behind a wall. ClearVue™ Mini features suction lift of up to 6.5'.



### Separate Tank

ClearVue™ Mini features a separate tank that can be located away from pump if needed, providing a more flexible installation. This small tank fits inside most indoor cassettes.



### Built-in Overflow Switch

ClearVue™ Mini also include a built-in overflow switch that shuts down the compressor in case of clogged line. This prevents damage to equipment or the environment.



### 2 Year Warranty

ClearVue Mini includes an extended 2 year warranty.

|                              |
|------------------------------|
| QUICK, EASY INSTALLATION     |
| HIGHEST LIFT: 22FT.          |
| SAFETY SWITCH                |
| AVAILABLE WITH TUBING        |
| LOW PROFILE MODELS AVAILABLE |

SAVE INSTALLATION TIME WITH

# CP-22 CONDENSATE PUMPS



# DiversiTech Condensate Pumps



**Metal Hang Tabs**

Shatterproof metal hang tabs have hole-and-slot design for easy mounting. Tabs are located on convenient 8" centers.



**Indicator Lights**

Red, yellow, and green indicator lights show the pump status. Green for power applied, yellow for pump running, and red for high level alarm.



**Overflow Safety Switch**

1/4" quick connect terminals provide easy connection to the built-in overflow switch. Two terminals are provided allowing the installer flexibility to connect air handler shut-down. Switch features SPDT isolated contacts ready for connection to building automation systems.



**Four Inlet Holes**

Four inlets versus two or three on other pumps provide the greatest installation versatility. Inlet holes have a reinforced wall for durability.



**Rubber Feet**

Rubber feet dampen vibration which reduces noise.



**Check Valve**

Removable check valve for easy cleaning.



**Vibration Isolation**

An elastomeric motor mounting gasket dampens vibration.



# High Rise Pan™

The High Rise Pan™ is an innovative new plastic drain pan design which allows placement of an air handler 2-3/4" above the outside lip of the pan without the need for separate, cumbersome mounting blocks. The pan has a molded-in network of risers to give a 5" lift. The risers are positioned to accept a wide variety of air handler sizes. Each riser has a specially shaped area at each end to accommodate a 2" x 2" anti-vibration pad which allows for quiet operation at all times.

Other features include heavy duty reinforcement throughout to give plenty of support as well as rolled edges for durability. One-piece plastic construction ensures no rust, leaks, or seams to split.

Each High Rise Pan™ comes complete with a Condensate Cop™ float switch, six E.V.A. anti-vibration pads, and one 3/4" PVC male adapter. Installation is straightforward and hassle-free.

*Water pushes to the side of the pan preventing stagnant water from building up in inaccessible areas. This helps prevent slime and algae accumulations, eliminating call backs due to foul smells.*

**Now available in a Single Pack box, too!**

**Nestable! High Rise Pans™ take up less space.**

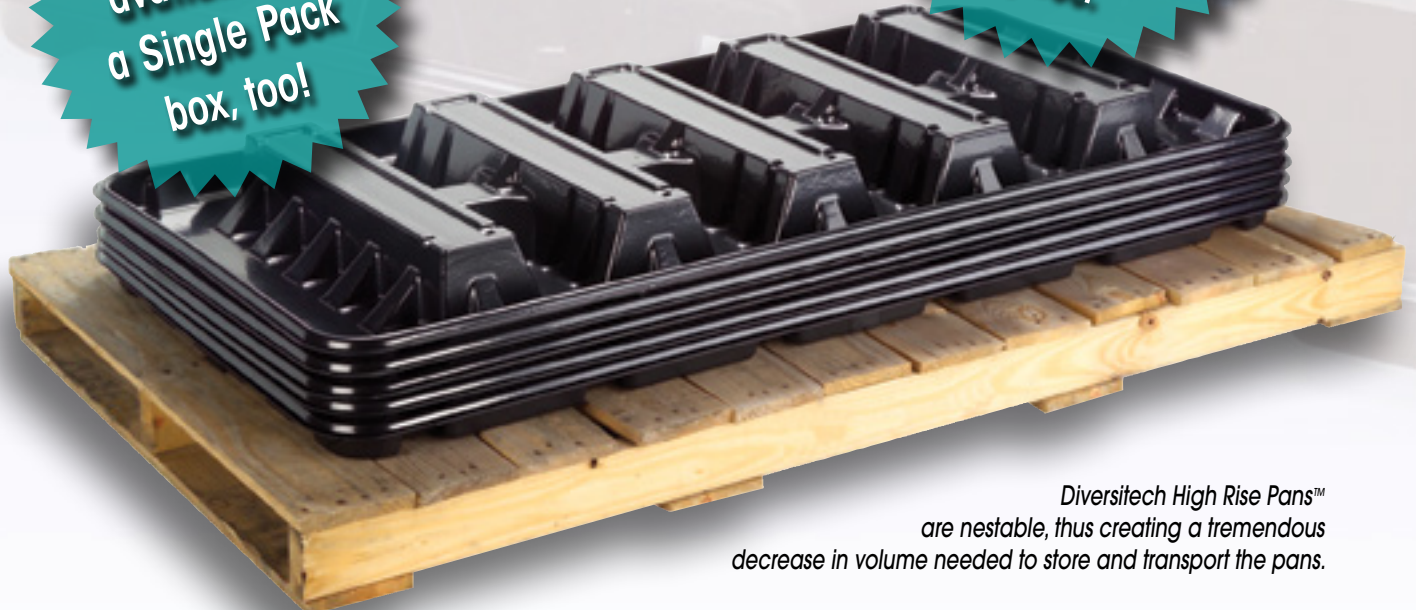

*Diversitech High Rise Pans™ are nestable, thus creating a tremendous decrease in volume needed to store and transport the pans.*

## FEATURE

## BENEFIT

### Nestable

Because DiversiTech High Rise Pans™ are nestable, there is a tremendous decrease in volume needed to store and transport the pans.



### Eliminates a single line vendor

Eliminating a vendor cuts distributor costs and saves warehouse and transportation costs.

### Water pushes to the side of the pan

This prevents stagnant water in inaccessible areas which helps prevent slime and algae buildup, eliminating call backs because of smell.

### Includes EVA™ pads

EVA™ pads increase the overall height of the unit which increases available drain line pitch. EVA™ pads also create better sound and vibration dampening for a quieter installation, meaning less call backs due to noise.

### Standard anti-vibration pad

Uses a standard, easily available anti-vibration pad, eliminating the need to stock extra SKUs of anti-vibration pads. Competitor products use specialized grommets which are not commonly available.



### Installation kit includes six EVA™ pads and Condensate Cop™ float switch

The universal CC-1 can be placed anywhere on the pan. It can also be used on other secondary drain pans (metal or plastic). You will never forget a part because you have a complete kit!

### 80% thicker than the standard drain pan

Stronger and more durable for job site installations; resists work place installation damage, minimizing the need to replace drain pans damaged at job site.



### ABS construction/flexible material

Time-tested material has been used for 15 years in the market. Flexibility allows for easier fit in tight work places and a faster installation. You'll have peace of mind for long term performance.

### Heat/cold resistance

Meets structural and temperature requirements for attic installations.

### 5" riser

5" riser gives additional height needed to assure proper drain line pitch. Stack EVA™ pads for additional height.

### Heavy-duty reinforced construction

Gives support for a wider range of air handler applications, minimizing the need to replace drain pans damaged at the job site.





# Metal Drain Pan

*DiversiTech introduces the ultimate in drain pan design - the seamless, nestable, metal drain pan with rolled edges.*





## FEATURES

## BENEFITS

### Seamless

The seamless design of DiversiTech metal drain pans virtually eliminates leaks from seams and folded corners found in conventional metal drain pans.

### Nestable

Because DiversiTech drain pans are nestable, there is a tremendous decrease in volume needed to store and transport metal drain pans. A stack of seventy DiversiTech metal drain pans is only 12" high. Therefore, seventy DiversiTech pans fit in the same space as six conventional 2" deep non-nesting drain pans!

### Single Piece Design

The DiversiTech metal drain pan is stamped from a single sheet of 26 gauge galvanized steel which prevents leaks.

### Rolled Edge

The rolled edge virtually eliminates hand injuries during handling.

### Two Outlets

Easy, flexible installation with an outlet on both the long and short side of the pan — no need to cut an outlet if you have the wrong pan on the job.

### Fittings Included

Get everything you need for the installation of the pan in a single package. Fittings are included with DiversiTech metal drain pans.

A stack of  
70 DiversiTech  
metal drain pans  
is only  
12" high!

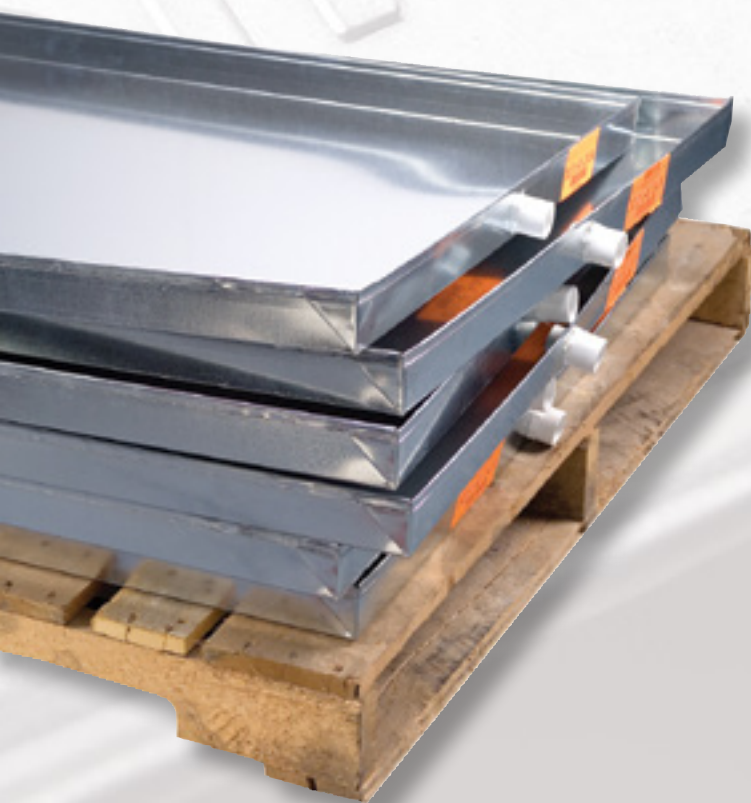

**70 DiversiTech drain pans fit in the same space as 6 conventional 2" deep non-nesting drain pans!**





**Faster Install**

**Hinged Fast Lock Clamp**

Hinged clamp bar self adjusts to angle of pan wall for a level switch. One-step installation with single screw fastener. Single screw fastens switch to pan – no drilling and no fussing with multiple thumb screws.



**Works Everywhere**

**Universal Pan Mount**

Easy twist to adjust to pan walls of 0, 8, 15 or 22 degrees. Fast, simple, easy, and level installation on metal or plastic pans for reliable moisture detection. Angled installation on other switches reduces their ability to detect condensate overflow.

# CS1200 AC Shutoff Switch

The CS1200 Multi-Position AC Shutoff Switch from DiversiTech is a reliable, easy to use float switch that clips on to any pan size. Designed with contractor feedback in mind, the CS1200 features an adjustable housing that twists to match any pan angle for easy installation. The CS1200 detects water in the pan quickly and shuts off the equipment to prevent damage. The CS1200 also includes these great features:

- Hinged fast lock clamp
- LED Indicator light
- Universal pan mount
- Large water openings for fast detection
- Push to test button
- Simple 2 wire installation
- 5 AMP switching, 24 Volt





**LED Indicator Light**

Easy to see visual trip indicator alarm displays red if switch is tripped. CS1200 is the only pan switch with a light for fast troubleshooting.



**Push to Test**

Know instantly with the push of a button that your switch is installed and functioning properly. The bright LED indicator visually confirms proper operation.



**Reliable Mechanical Contact Float Switch**

Trouble free design reduces overflow failures and call backs. All electronics are mounted above the waterline, eliminating the chance of malfunction. The one piece molded float protects switch from water and debris. This is the same design used for safety interlocks because it gives you years of reliable, maintenance free service.



**10x Open Area**

10 times more open area for water to enter the detection chamber with our large open area design. No detection failure from small holes that can get clogged. Prevents switch failure from clogged water holes. No call backs due to clogged switches.



**Simple 2 Wire Installation**

With a simple 2 wire connection, the CS1200 is simple, easy, and fast to install. No checking polarity, just connect the switch in the red or yellow wire. Simple well designed electrical connections using 6 feet of the standard 18AWG wire and high current (5 amp) switching. The CS1200 gives you everything you need in one simple switch.



**Clear Design**

CS1200 is the only pan switch with a clear design for fast troubleshooting. Clear design lets you see the float and switch. Know instantly that the switch is working and components are functioning.



RECOGNIZED COMPONENT



Intertek



# Wet Switch Flood Detector

## WHAT IS THE WET SWITCH?

**T**he Wet Switch is a solid state device designed to detect the presence of condensate water overflow. The Wet Switch is placed into the secondary drain pan — a normally dry pan. If the primary drain pan fails, condensate water will overflow into the secondary drain pan. Upon sensing moisture, the Wet Switch will turn the system off (typically the cause of the condensing water) to help prevent damage to carpets, walls, woodwork, ceilings, and other property.

- Hydrophilic Pad
- Integral Feet
- Stainless Steel Sensor Array
- Solid State Electronics
- Epoxy Encapsulated Electronics
- Double Throw Relay
- Standard 24VAC control
- Multiple Unit Connectivity

The Wet Switch is designed to interrupt the operation of cooling systems. However, it is a water activated switch and can be used in a variety of other applications.

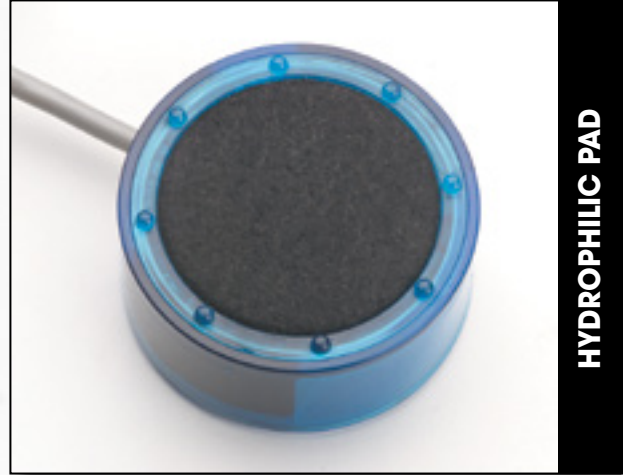

HYDROPHILIC PAD

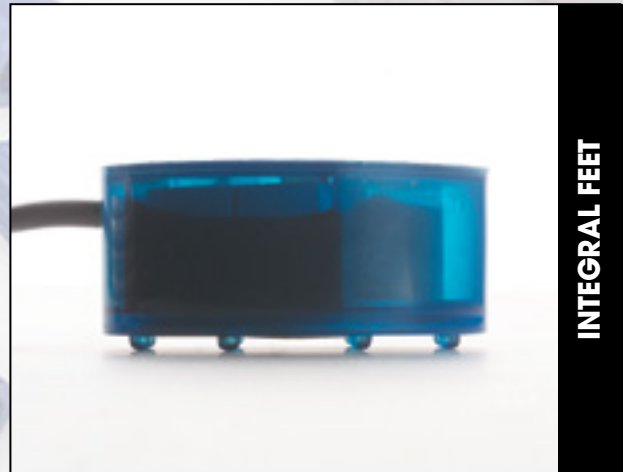

INTEGRAL FEET



STAINLESS STEEL SENSORS





# Drain Gun - Charles Gallo Brand

**T**he Drain Gun - Charles Gallo Brand is a lightweight (3oz.) portable tool designed to blow out condensate drain lines instantly. Simply insert a Swoosh CO<sub>2</sub> cartridge into the Charles Gallo Drain Gun and with a press of the trigger — SWOOSH — 800 psi of oil free air clears the line.

## INSTRUCTIONS:

- Unscrew cup and insert cartridge with the narrow end up.
- Without depressing the trigger, screw the cup slowly into the head until the cartridge contacts the puncture pin.
- Quickly and firmly screw the unit together to puncture and seal the cartridge in the same motion.  
Note: Not completely screwing the unit together may result in escaping gas.
- Release the red safety catch.
- Depress the trigger to discharge the Swoosh CO<sub>2</sub> cartridge. For condensate drains, a quick and full discharge is best.

*The Drain Gun - Charles Gallo Brand is for use with condensate drain and oil burner lines only.*





## SMALL AND LIGHTWEIGHT

The Drain Gun packs cleaning power into a small, lightweight package. This prevents the need for carrying heavy air or nitrogen tanks.

## AIR POWER

The Drain Gun uses CO<sub>2</sub>, eliminating the mess caused by water back flushing drain lines.

## ENVIRONMENTALLY FRIENDLY

The Drain Gun uses carbon dioxide (CO<sub>2</sub>), a common component of air, and is totally safe for use in the environment. The Drain Gun is an excellent alternative to the environmentally unfriendly practice of using refrigerant to clean the drain line.

## FLEXIBLE HOSE ASSEMBLY

The flexible hose assembly enables you to maneuver through cabinets, coils, and hard to reach drains.

## ADAPTER KIT

An adapter kit is available to allow for use on oil burner lines and tighter areas with a 90° fitting.



*Fittings increase the versatility of the innovative Drain Gun and are available from your distributor.*

### 90° FITTING FOR TIGHT AREAS



### FITTING FOR OIL BURNER LINES



### FITTING FOR LARGER DRAINS



# Condensate Drain Line Cleaners

DiversiTech offers a family of products designed to help make condensate drain line cleaning faster and easier. From the super lightweight handheld Charles Gallo Drain Gun to the full power of the DrainDawg, DiversiTech has the right solution for every need. These products also have multiple other uses including operating air power tools, purging and testing copper tubing and more.





## HANDHELD POWER

- Clears condensate drain lines with a SWOOSH!
- Lightweight and portable - goes anywhere
- Environmentally friendly
- Uses CO<sub>2</sub> refill cartridges



## PORTABLE POWER

- Uses Nitrogen or CO<sub>2</sub>
- Lightweight and portable
- Includes boxed fitting kit
- Easy to refill at your truck
- Multiple uses
- Includes inflatable DrainDawg fitting to clear lines fast



## ULTIMATE POWER

- Uses Nitrogen or CO<sub>2</sub>
- Includes 10' flexible hose and blowgun assembly
- Includes boxed fitting kit
- Multiple uses
- Includes inflatable DrainDawg fitting to clear lines fast





# A/C Easy Tee®

*The A/C Easy Tee® from DiversiTech is the easy way to unclog and clean drain lines in just seconds. It installs quickly and provides permanent, fast access for routine drain line maintenance. And with the Service Tool Kit adapters you can use water or compressed gas to quickly clean out the lines to maintain proper flow. Ideal for both commercial and residential systems.*



**Make your service calls faster and simpler with the A/C Easy Tee®.**



## Flexible to Use

The A/C Easy Tee® can be installed in many different ways. There is no designated inlet or outlet. Both connections can be either. The Service Tool Kit allows the technician to close off backflow creating full discharge of water or nitrogen to clean out the drain line. It can also be used with a wet/dry vac to suction dirt, debris, and gunk out of a primary drain pan.



## Code Required

A Service Port – also called a Cleanout – is required by code (IMC - SECTION 307.2.5, IRC-SECTION M1411.3.3). Don't get your jobs red tagged by code inspectors. Install an A/C Easy Tee®.



## Simple Design

The A/C Easy Tee® Service Port is a compact, simple design with no moving parts. Small, fiddly parts can and will fail. The A/C Easy Tee® has a simple cap that screws off for easy access to the condensate drain line.



## No Drainage Block

Featuring a simple, easy design without flappers or ball valves like other products. Flappers and ball valves can fail or be left closed in the drain line.



[www.aceasytee.com](http://www.aceasytee.com)



## CONDENSATE PUMPS

### ClearVue™ Pump

No Float, No Problems! ClearVue's Variable Speed and Lift and Floatless Sensor™ make this the most advanced condensate pump ever. This new pump can provide up to 22' of lift if needed. ClearVue™ runs at the minimum speed needed, saving wear on the pump. The pump selects the lowest effective speed, making it quieter than a regular pump. Its unique self cleaning feature senses problems and automatically enters a self cleaning mode using condensate water to fix the issue. The ClearVue™ pump features a clear bottom tank to easily check the water level. Other features include: stainless steel mounting tabs, silicone rubber feet, reversible deck, four inlet holes, and LED indicator lights. ETL Listed File Number 3190890



IQP-120

| CATALOG NO.     | DESCRIPTION                               | UOM | ORDER MULTIPLE |
|-----------------|---|-----|----------------|
| <b>IQP-120</b>  | ClearVue™ Pump – 120V – 0-22' Lift        | EA  | 6              |
| <b>IQP-120T</b> | ClearVue™ Pump w/Tube – 120V – 0-22' Lift | EA  | 6              |

### FP-22 Furnace Pump



The FP-22 Furnace Pump is a full featured condensate pump designed for condensing furnaces and other hot water applications. It handles hot condensate water up to 190 degrees F. Other features include 22' lift, built-in P traps, steam resistant electronics, and a super tough tank. Available in 120 and 230V models.



FP-22

| CATALOG NO.      | DESCRIPTION                                 | UOM | ORDER MULTIPLE |
|------------------|---|-----|----------------|
| <b>FP-22</b>     | Furnace Pump 120V 22' Lift 190°F Condensate | EA  | 1              |
| <b>FP-22-230</b> | Furnace Pump 230V 22' Lift 190°F Condensate | EA  | 1              |

### BP-46 Boiler Pump



The BP-46 Boiler Pump is a heavy duty, full featured condensate pump for hot water applications up to 212 degrees F. It features a 46' lift, oil resistant tank and impeller, two inlet holes and 1/4 turn check valve. Additional features include high impact construction, large tank and is available in 120 and 230V models.



BP-46

| CATALOG NO.      | DESCRIPTION  | UOM | ORDER MULTIPLE |
|------------------|--|-----|----------------|
| <b>BP-46</b>     | High Temperature Boiler Pump 115V, 46' Lift 212°F Condensate | EA  | 1              |
| <b>BP-46-230</b> | High Temperature Boiler Pump 230V, 46' Lift 212°F Condensate | EA  | 1              |

### ClearVue™ Mini Ductless System Pump

Featuring super quiet operation, specifically designed for ductless system installations, and including Variable Speed and Lift and Floatless Sensor™, ClearVue™ Mini is chock full of innovative features, and priced competitively.



CVMINI

| CATALOG NO.   | DESCRIPTION                          | UOM | ORDER MULTIPLE |
|---------------|--------------------------------------|-----|----------------|
| <b>CVMINI</b> | ClearVue Mini - Ductless System Pump | EA  | 6              |

### CP-22 Pumps

Suitable for use with condensate from HVAC equipment which produce condensate. 22' of lift compared to the typical 20'. Features include vibration dampening feet and motor mounts, metal hang tabs, four inlet holes, a clear indicator display, a float switch and check valve. Integrating the CP-22 into your system is easy. 1/4" quick connect terminals provide easy connection to the built in overflow switch. 2 terminals are provided allowing flexibility to connect air handler shut down. UL Listed File Numbers E253155 and E258186.



CP-22

| CATALOG NO.       | DESCRIPTION                            | UOM | ORDER MULTIPLE |
|-------------------|--|-----|----------------|
| <b>CP-22</b>      | Condensate Pump – 120V                 | EA  | 6              |
| <b>CP-22T</b>     | Condensate Pump – 120V w/20' 3/8" Tube | EA  | 6              |
| <b>CP-22-230</b>  | Condensate Pump – 230V                 | EA  | 6              |
| <b>CP-22-230T</b> | Condensate Pump – 230V w/20' 3/8" Tube | EA  | 6              |

### CP-22 Low Profile Pumps

The new CP-22LP comes packed with all the same great features found in the CP-22, but now in a low profile package. This pump is only 4-3/8" tall so it's a good fit for those instances where space is at a premium. The shorter reservoir holds 1/3 gallon. Suitable for use with condensate up to 160 degree F. UL Listed File Numbers E253155 and E258186.



CP-22LP

| CATALOG NO.        | DESCRIPTION                          | UOM | ORDER MULTIPLE |
|--------------------|--------------------------------------|-----|----------------|
| <b>CP-22LP</b>     | Condensate Pump – 120V – Low Profile | EA  | 6              |
| <b>CP-22LP-230</b> | Condensate Pump – 230V – Low Profile | EA  | 6              |

### General Purpose Pumps

The DiversiTech CP-16 condensate pump is an economical alternative that's based off of the proven CP-22 design. More compact than the CP-22, it's designed to lift to a maximum of 16 feet. The CP-16 shares many of the great features of the CP-22, including hang tabs, four inlet holes, float switch, overflow switch, and a check valve. UL Listed File Numbers E253155 and E258186.



CP-16

| CATALOG NO.      | DESCRIPTION                   | UOM | ORDER MULTIPLE |
|------------------|-------------------------------|-----|----------------|
| <b>CP-16</b>     | Condensate Pump 16' Lift 120V | EA  | 6              |
| <b>CP-16-230</b> | Condensate Pump 16' Lift 230V | EA  | 6              |

### Pump Parts & Accessories

Check valve installs easily and prevents water from travelling backwards into the pump and overflowing.



CP-CV

| CATALOG NO.  | DESCRIPTION                       | UOM | ORDER MULTIPLE |
|--------------|-----------------------------------|-----|----------------|
| <b>CP-CV</b> | Replacement Check Valve for CP-22 | EA  | 1              |



**CONDENSATE PUMPS cont'd**

**CP-MINI-L**



DiversiTech's CP-MINI-L Mini Split Condensate Pump is a quiet, super compact, and feature rich pump that fits almost anywhere. Handles multiple voltages. Pump fits easily in most line set covers.



CP-MINI-L

| CATALOG NO. | DESCRIPTION                                       | UOM | ORDER MULTIPLE |
|-------------|---|-----|----------------|
| CP-MINI-L   | Low Profile Mini-Split Pump 115V-240V 50/60 Hz EA | EA  | 6              |

**Mini-Split Pumps**

DiversiTech's Mini-Split Condensate Pump is a quiet, super compact, and feature rich pump that fits almost anywhere. Compatible with all brands of mini-split units. Provides 24' of lift with 6' suction lift. Pump fits easily in most line set covers and includes all needed accessories. Available in 115V and 230V versions.



CP-M115

| CATALOG NO. | DESCRIPTION                      | UOM | ORDER MULTIPLE |
|-------------|----------------------------------|-----|----------------|
| CP-M115     | Mini-Split Condensate Pump, 115V | EA  | 10             |
| CP-M230     | Mini-Split Condensate Pump, 230V | EA  | 10             |

**CONDENSATE DRAIN LINE SWITCHES**

**PAN MOUNTED SWITCHES**

**Wet Switch Flood Detector**

A solid state control designed to help prevent flooding, damage to carpets, walls, furniture, ceilings, etc. Now has a built in test and reset button for easier installation. Turns system off when detecting moisture due to condensate or drain leaks. One or two drops will cause Wet Switch to turn off a unit, alerting a serviceman to a moisture problem. A lit LED indicates the Wet Switch is activated and has turned the unit off. Reset simply by drying the absorbent pad with a paper towel and pressing the reset switch. Connects to 24 VAC. More than one unit may be connected to the system. 2 amp contact rating. Simple 5 wire installation. Sales displays available. ETL Listed File Number 3146992. UL508 Approved.



WS-1

| CATALOG NO. | DESCRIPTION               | UOM | ORDER MULTIPLE |
|-------------|---------------------------|-----|----------------|
| WS-1        | Wet Switch Flood Detector | EA  | 1              |

**Condensate Cop™**

Condensate Cop™ is a unique clamp on float switch intended for HVAC drain pan installation. The Condensate Cop™ features a large over clamping area that fits easily over the edge of all types of drain pans; including formed plastic and galvanized sheet metal. A separate float/probe assembly swivels to accommodate drain pans having sloped sides. The swivel action allows the installer to position the float switch for best operation and then clamp it into place. The probe features an inlet grill which prevents the float from being blocked or damaged by insulation or other debris. Sealed inside the probe is a magnetically actuated normally closed switch. The switch opens when rising water presents a potential flooding condition. Two wire connection for easy hook up to a thermostat "Y" (compressor) circuit. Provided complete with 5' (1.5 meter) leads, wire nuts, and clamping screws. Small size, 24V/1.5 amp NC reed switch. ETL Listed File Number 3166285. UL508 Approved.

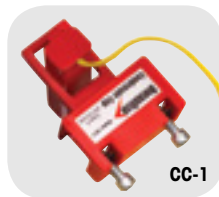

CC-1

| CATALOG NO. | DESCRIPTION                      | UOM | ORDER MULTIPLE |
|-------------|----------------------------------|-----|----------------|
| CC-1        | Condensate Cop™ Drain Pan Switch | EA  | 12             |

**CS1200 AC Shutoff Switch**

The CS1200 is a fast installing, reliable, condensate overflow detection pan switch. Featuring a unique universal pan mount design to assure accurate detection in metal or plastic secondary drain pans. UL508 Approved.



CS1200

| CATALOG NO. | DESCRIPTION              | UOM | ORDER MULTIPLE |
|-------------|--------------------------|-----|----------------|
| CS1200      | CS1200 AC Shutoff Switch | EA  | 12             |

**CS-3 Condensate Pan Switch**

The CS-3 is a clip-on pan switch that use a magnetic reed switch for condensate overflow protection.



CS-3

| CATALOG NO. | DESCRIPTION              | UOM | ORDER MULTIPLE |
|-------------|--------------------------|-----|----------------|
| CS-3        | Condensate Switch – Clip | EA  | 12             |

**Pipe Mounted Switches**

DiversiTech Flood Prevention Switches are simple to install, easy to service and extremely reliable. As water level in the auxiliary or main drain pipe rises due to a clogged air conditioning condensate drain, the switch shuts off the system - thus preventing water from overflowing and causing damage to doors, walls and ceilings. At the heart of the switch is a durable yet precise magnetic reed switch. Constructed of materials that will not rust or stick, the switch operates smoothly every time. UL508 Approved.



CS-1

CS-2

| CATALOG NO. | DESCRIPTION               | UOM | ORDER MULTIPLE |
|-------------|---------------------------|-----|----------------|
| CS-1        | Condensate Switch – Tee   | EA  | 12             |
| CS-2        | Condensate Switch – Elbow | EA  | 12             |

**Universal Alarm**

A universal low voltage alarm that can indicate possible system trouble. Use with the Wet Switch, SOS, Condensate Cop, CP 22 (all types) and all float switches on 24VAC control circuits. If an alarm condition exists, the homeowner can turn the alarm off with a "silence" button until service is obtained, however a red trouble LED will remain lit. Also features: easy 2 wire connection, label to print contractor information, and low current draw. Actuates at greater than 18V to prevent any false alarms due to low voltage. Includes 2 wire nuts, a sheet metal screw, and double sided tape for convenient installation options. Also includes instructions for wiring normally open switch systems (for the CP 22 or other condensate pumps).



UA-1

| CATALOG NO. | DESCRIPTION               | UOM | ORDER MULTIPLE |
|-------------|---------------------------|-----|----------------|
| UA-1        | Universal Alarm for 24VAC | EA  | 12             |

**CLEARVUE™ TUBE & TRAPS**

**ClearVue™ Tube**

Clear, schedule 40 PVC ideal for installing as condensate drain lines in other areas where seeing the inside of the tubing is helpful. ClearVue™ Tube makes it easy to quickly spot build up or obstructions in drain lines for faster troubleshooting. Available in 5ft lengths.

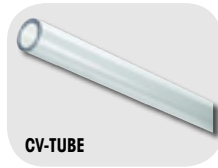

| CATALOG NO.    | DESCRIPTION                 | UOM | ORDER MULTIPLE |
|----------------|-----------------------------|-----|----------------|
| <b>CV-TUBE</b> | ClearVue™ Tube – 5' section | EA  | 50             |

**Drain Trap Kits**

Drain trap kits feature clear PVC traps with multiple cleanouts for easy maintenance. Available in several fitting styles with or without float switch to match any installation need.



| CATALOG NO.    | DESCRIPTION   | UOM | ORDER MULTIPLE |
|----------------|---|-----|----------------|
| <b>DTK113</b>  | Drain Trap Kit, 3/4 in Blow Molded                  | EA  | 1              |
| <b>DTK113B</b> | Drain Trap Kit, 3/4 in, w/Brush                     | EA  | 1              |
| <b>DTK205</b>  | Drain Trap Kit, 3/4 in, Deep w/switch               | EA  | 1              |
| <b>DTK207</b>  | Drain Trap Kit, 3/4 in, Standard w/switch and cross | EA  | 1              |
| <b>DTK210</b>  | Drain Trap Kit, 3/4 in, Standard w/switch           | EA  | 1              |

**ClearVue™ Traps**

DiversiTech introduces new ClearVue™ P and R traps. These traps are made from smooth, clear PVC with no flat spots to restrict flow. With these new ClearVue™ traps its easy to see directly into them to detect blockages and prevent problems before they become severe. Ideal for installation in condensate drain lines.

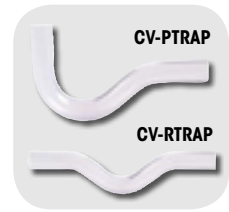

| CATALOG NO.     | DESCRIPTION           | UOM | ORDER MULTIPLE |
|-----------------|-----------------------|-----|----------------|
| <b>CV-PTRAP</b> | ClearVue™ 3/4" P trap | EA  | 25             |
| <b>CV-RTRAP</b> | ClearVue™ 3/4" R trap | EA  | 25             |

**Drain Trap Kit Cross Reference**

| DIVERSITECH CATALOG NO. | RECTORSEAL PART NO. |
|-------------------------|---------------------|
| <b>DTK113</b>           | <b>EZT-113</b>      |
| <b>DTK113B</b>          | <b>EZT-113B</b>     |
| <b>DTK205</b>           | <b>EZT-205</b>      |
| <b>DTK207</b>           | <b>EZT-207</b>      |
| <b>DTK210</b>           | <b>EZT-210</b>      |

**CONDENSATE DRAIN LINE CLEANING**

**Drain Gun™ - SWOOSH CO<sub>2</sub> Cartridges**

Clears condensate drains with a SWOOSH! A lightweight (3 oz.) portable tool designed to blow out drain lines instantly. New larger SWOOSH CO<sub>2</sub> cartridges now deliver 800 PSI of oil free air to clear the line. Each unit comes equipped with a tapered fitting to work on 3/8in. – 3/4in. drain openings. Flexible hose assembly maneuvers through cabinets, coils and hard to reach drains. Cartridges are environmentally safe and recyclable. No need for air or nitrogen tanks. Reduces labor costs and time on service calls.



| CATALOG NO.    | DESCRIPTION                                   | UOM | ORDER MULTIPLE |
|----------------|---|-----|----------------|
| <b>GG-1</b>    | Drain Gun™ for A/C Condensate Lines           | EA  | 6              |
| <b>GGC-12</b>  | SWOOSH CO <sub>2</sub> Cartridges, pack of 12 | PK  | 1              |
| <b>GGC-6</b>   | SWOOSH CO <sub>2</sub> Cartridges, pack of 6  | PK  | 1              |
| <b>GG-1A</b>   | Drain Gun™ Adapter Kit                        | EA  | 1              |
| <b>GG-1H</b>   | Drain Gun™ Hose Assembly                      | EA  | 1              |
| <b>GG-1TF</b>  | Drain Gun™ replacement tip                    | EA  | 1              |
| <b>GG-1BOR</b> | Drain Gun™ bottom o-ring, pack of 5           | PK  | 1              |
| <b>GG-1NHL</b> | Drain Gun™ body, no hose                      | EA  | 1              |

**DrainDawg™**

The DrainDawg™ is a complete condensate drain cleaning kit, including the CT-475M deluxe nitrogen / CO<sub>2</sub> 0-475 psi regulator, the TG-10 & BS-25 ten foot hose and blowgun assembly, and the CW-15 fifteen inch whip hose. Also included is the AP-DD DrainDawg™ Accessory Fitting Kit which contains the DF-75 DrainDawg™ inflatable tip, the CK-141 3/4"-1" cone fitting, the FA-02 CO<sub>2</sub> to nitrogen adapter, the QN-S3 needle tip, and the TC-25 tire chuck. Made in USA.



| CATALOG NO. | DESCRIPTION    | UOM | ORDER MULTIPLE |
|-------------|----------------|-----|----------------|
| <b>CB-2</b> | DrainDawg™ Kit | EA  | 3              |

**DrainKat™**

The DrainKat™ is an over the shoulder refillable, nitrogen or CO<sub>2</sub> mini drain cleaning kit. Featuring a small cylinder that holds 9 cubic feet of nitrogen or 2-1/2 pounds of CO<sub>2</sub>. The cylinder includes an integral mounted regulator for quick and easy adjustment of discharge pressure. Get exactly the amount of pressure you need with a quick adjustment on the regulator. Furnished complete with an 87" hose and drain gun kit, the CW-15 whip hose, and the AP-DK DrainKat™ Accessory Fitting Kit which contains the DF-75 DrainDawg™ inflatable tip, the CB-03 3/4"-1" cone fitting, the FA-01 male to male CO<sub>2</sub> to nitrogen adapter, the FA-03 CO<sub>2</sub> trans-fill adapter, and the the QN-S3 needle tip. Made in the USA.



| CATALOG NO.  | DESCRIPTION   | UOM | ORDER MULTIPLE |
|--------------|---------------|-----|----------------|
| <b>MBK-6</b> | DrainKat™ Kit | EA  | 2              |

CONDENSATE DRAIN LINE CLEANING *cont'd***A/C Easy Tee®**

A/C Easy Tee® is a simple, inexpensive way to comply with the International Mechanical Code M32-12. It provides a Condensate Drain Service Port that is flexible and easy to use with nitrogen, water, or shop vac. A/C Easy Tee® has no valve or moving parts that could fail.

| CATALOG NO.     | DESCRIPTION                         | UOM | ORDER MULTIPLE |
|-----------------|-------------------------------------|-----|----------------|
| <b>ET75</b>     | A/C Easy Tee®                       | EA  | 20             |
| <b>ET75-KIT</b> | A/C Easy Tee® Kit - 2 Tees and ST75 | EA  | 6              |
| <b>ST75</b>     | Service Tool Kit                    | EA  | 6              |

ET75

**Drain Dawg™ and Drain Kat™ Fittings**

The Drain Dawg™ and Drain Kat™ products are compatible with a series of fittings to connect to condensate drain lines and hoses. The fittings are available individually, or as kits for the Drain Dawg™ and Drain Kat™.

| CATALOG NO.   | DESCRIPTION  | UOM | ORDER MULTIPLE |
|---------------|--|-----|----------------|
| <b>AP-DD</b>  | Drain Dawg™ Accessory Pack   | EA  | 1              |
| <b>AP-DK</b>  | Drain Kat™ Accessory Pack  | EA  | 1              |
| <b>BS-25</b>  | Blow gun with safety tip for Drain Dawg™ or Drain Kat™                             | EA  | 1              |
| <b>CB-03</b>  | 3/4 in. cone tip with female thread for Drain Dawg™ or Drain Kat™ blow gun         | EA  | 1              |
| <b>CK-141</b> | 3/4 in. cone with male thread for use with whip hose for Drain Dawg™ or Drain Kat™ | EA  | 1              |
| <b>CW-15</b>  | 15 in. whip hose for Drain Dawg™ or Drain Kat™                                     | EA  | 1              |
| <b>DF-75</b>  | Drain Dawg™ inflatable tip for drain line blowout                                  | EA  | 1              |
| <b>FA-01</b>  | Nitrogen to CO2 adapter, male by male for Drain Kat™                               | EA  | 1              |
| <b>FA-02</b>  | Nitrogen to CO2 adapter, female by female for Drain Dawg™                          | EA  | 1              |
| <b>FA-03</b>  | CO2 transfill adapter for Drain Kat™   | EA  | 1              |
| <b>QN-S3</b>  | Needle tip with female thread for Drain Dawg™ or Drain Kat™ blow gun               | EA  | 1              |
| <b>TC-25</b>  | Tire chuck for Drain Dawg™   | EA  | 1              |
| <b>TG-10</b>  | 120 in. blow gun hose for Drain Dawg™  | EA  | 1              |
| <b>TG-87A</b> | 87 in. blow gun hose for Drain Kat™  | EA  | 1              |

DF-75



## CONDENSATE DRAIN PANS, FITTINGS, ADAPTERS

**A/C Secondary Condensate Drain Pans**

Rolled edges for durability, ribbed bottoms for rigidity, and reinforced corners for strength. 3/4in. PVC fittings are included with each pan. No seams, no rust, and no leakage. ABS materials will not put out toxic smoke. Available in over 20 convenient sizes. Five pans per clip.

| CATALOG NO.        | BOTTOM DIMENSION |          | OVERALL DIMENSION |          | DEPTH |     | UOM | ORDER MULTIPLE |
|--------------------|------------------|----------|-------------------|----------|-------|-----|-----|----------------|
|                    | IN.              | CM.      | IN.               | CM.      | IN.   | CM. |     |                |
| <b>6-1838L</b>     | 18" x 38"        | 46 x 97  | 20" x 40"         | 51 x 102 | 2"    | 5   | EA  | 5              |
| <b>6-1838S</b>     | 18" x 38"        | 46 x 97  | 20" x 40"         | 51 x 102 | 2"    | 5   | EA  | 5              |
| <b>6-1846S</b>     | 18" x 46"        | 46 x 117 | 20" x 48"         | 51 x 122 | 2"    | 5   | EA  | 5              |
| <b>6-2424L</b>     | 24" x 24"        | 61 x 61  | 26" x 26"         | 66 x 66  | 2"    | 5   | EA  | 5              |
| <b>6-2626L</b>     | 26" x 26"        | 66 x 66  | 28" x 28"         | 71 x 71  | 2"    | 5   | EA  | 5              |
| <b>6-2739L</b>     | 27" x 39"        | 69 x 99  | 29" x 41"         | 74 x 104 | 2"    | 5   | EA  | 5              |
| <b>6-2748L</b>     | 27" x 48"        | 69 x 122 | 29" x 50"         | 74 x 127 | 2"    | 5   | EA  | 5              |
| <b>6-2748S</b>     | 27" x 48"        | 69 x 122 | 29" x 50"         | 74 x 127 | 2"    | 5   | EA  | 5              |
| <b>6-2748L-100</b> | 27" x 48"        | 69 x 122 | 29" x 50"         | 74 x 127 | 2"    | 5   | EA  | 100            |
| <b>6-2763L</b>     | 27" x 63"        | 69 x 160 | 29" x 65"         | 74 x 165 | 2"    | 5   | EA  | 5              |
| <b>6-2763S</b>     | 27" x 63"        | 69 x 160 | 29" x 65"         | 74 x 165 | 2"    | 5   | EA  | 5              |
| <b>6-3030L</b>     | 30" x 30"        | 76 x 76  | 32" x 32"         | 81 x 81  | 2"    | 5   | EA  | 5              |
| <b>6-3050L</b>     | 30" x 50"        | 76 x 127 | 32" x 52"         | 81 x 132 | 2"    | 5   | EA  | 5              |
| <b>6-3050S</b>     | 30" x 50"        | 76 x 127 | 32" x 52"         | 81 x 132 | 2"    | 5   | EA  | 5              |
| <b>6-3060L</b>     | 30" x 60"        | 76 x 152 | 32" x 62"         | 81 x 157 | 2"    | 5   | EA  | 5              |
| <b>6-3060S</b>     | 30" x 60"        | 76 x 152 | 32" x 62"         | 81 x 157 | 2"    | 5   | EA  | 5              |
| <b>6-3060L-100</b> | 30" x 60"        | 76 x 152 | 32" x 62"         | 81 x 157 | 2"    | 5   | EA  | 100            |
| <b>6-3263L</b>     | 32" x 63"        | 81 x 160 | 34" x 65"         | 86 x 165 | 2"    | 5   | EA  | 5              |
| <b>6-3263S</b>     | 32" x 63"        | 81 x 160 | 34" x 65"         | 86 x 165 | 2"    | 5   | EA  | 5              |
| <b>6-3636L</b>     | 36" x 36"        | 91 x 91  | 38" x 38"         | 97 x 97  | 2"    | 5   | EA  | 5              |
| <b>6-3660L</b>     | 36" x 60"        | 91 x 152 | 38" x 62"         | 97 x 157 | 2"    | 5   | EA  | 5              |
| <b>6-3660S</b>     | 36" x 60"        | 91 x 152 | 38" x 62"         | 97 x 157 | 2"    | 5   | EA  | 5              |

L = Drain Line Outlets in Long Side    S = Drain Line Outlets in Short Side

6-1838L





**CONDENSATE DRAIN PANS, FITTINGS, ADAPTERS cont'd**

**High Rise Pans™**

The High Rise Pan™ is an innovative new plastic drain pan design which allows placement of an air handler 2 3/4in. above the outside lip of the pan without the need for separate, cumbersome mounting blocks. The pan has a molded in network of risers to give a 5in. lift. The risers are positioned to accept a wide variety of air handler sizes. Each riser has a specially shaped area at each end to accommodate a 2in. x 2in. anti vibration pad which allows for quiet operation at all times. Other features include heavy duty reinforcement throughout to give plenty of support as well as rolled edges for durability. One piece plastic construction ensures no rust, leaks, or seams to split. Each High Rise Pan™ comes complete with a Condensate Cop™ float switch, 6 EVA™ anti vibration pads, and 1 3/4in. PVC male adapter. Installation is straightforward and hassle free.



**6-HK2748**

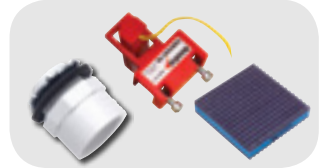

| CATALOG NO.       | DESCRIPTION   | UOM | ORDER MULTIPLE |
|-------------------|---|-----|----------------|
| <b>6-HK2748</b>   | High Rise Pan™ 27" x 48" with Installation Kit including: One CC-1 Condensate Cop, Six MP-2E 2" x 2" EVA™ Pads, One 6-1 3/4" PVC male adapter                   | EA  | 5              |
| <b>6-HK2748-1</b> | Single Pack Kit – High Rise Pan™ 27" x 48" with Installation Kit including: One CC-1 Condensate Cop, Six MP-2E 2" x 2" EVA™ Pads, One 6-1 3/4" PVC male adapter | EA  | 1              |
| <b>6-HK2766</b>   | High Rise Pan™ 27" x 66" with Installation Kit including: One CC-1 Condensate Cop, Six MP-2E 2" x 2" EVA™ Pads, One 6-1 3/4" PVC male adapter                   | EA  | 5              |
| <b>6-HK2766-1</b> | Single Pack Kit – High Rise Pan™ 27" x 66" with Installation Kit including: One CC-1 Condensate Cop, Six MP-2E 2" x 2" EVA™ Pads, One 6-1 3/4" PVC male adapter | EA  | 1              |
| <b>6-HK3050</b>   | High Rise Pan™ 30" x 50" with Installation Kit including: One CC-1 Condensate Cop, Six MP-2E 2" x 2" EVA™ Pads, One 6-1 3/4" PVC male adapter                   | EA  | 5              |
| <b>6-HK3050-1</b> | Single Pack Kit – High Rise Pan™ 30" x 50" with Installation Kit including: One CC-1 Condensate Cop, Six MP-2E 2" x 2" EVA™ Pads, One 6-1 3/4" PVC male adapter | EA  | 1              |
| <b>6-HK3060</b>   | High Rise Pan™ 30" x 60" with Installation Kit including: One CC-1 Condensate Cop, Six MP-2E 2" x 2" EVA™ Pads, One 6-1 3/4" PVC male adapter                   | EA  | 5              |
| <b>6-HK3060-1</b> | Single Pack Kit – High Rise Pan™ 30" x 60" with Installation Kit including: One CC-1 Condensate Cop, Six MP-2E 2" x 2" EVA™ Pads, One 6-1 3/4" PVC male adapter | EA  | 1              |

**Heavy Duty High Rise Pans**

A thicker, tougher version of our regular High Rise Pans. Each pan includes a kit with one CS1200 float switch, six EVA™ anti-vibration pads and one 3/4" PVC male adapter.



**6-HK3060HD**

| CATALOG NO.       | DESCRIPTION                        | UOM | ORDER MULTIPLE |
|-------------------|------------------------------------|-----|----------------|
| <b>6-HK3050HD</b> | Heavy Duty High Rise Pan 30" x 50" | EA  | 5              |
| <b>6-HK3060HD</b> | Heavy Duty High Rise Pan 30" x 60" | EA  | 5              |
| <b>6-HK3070HD</b> | Heavy Duty High Rise Pan 30" x 70" | EA  | 5              |

**Furnace Pans**

DiversiTech furnace pans are designed specifically for furnace installations. Their one piece construction provides strength and durability for any furnace installation.



**6-HK3378FUR**

| CATALOG NO.        | DESCRIPTION                                   | UOM | ORDER MULTIPLE |
|--------------------|---|-----|----------------|
| <b>6-HK3364FUR</b> | Furnace Pan – 33" x 64" with installation kit | EA  |                |
| <b>6-HK3378FUR</b> | Furnace Pan – 33" x 78" with installation kit | EA  |                |

**Metal Drain Pan**

The ultimate in drain pan design — tailored for easy distribution and installation. Full of features to make life easier on both the distributor and the contractor. Seamless, one piece metal construction with rolled edges on all sides for maximum safety and integrity. Nestable as well — a stack of 70 pans is only a foot high! Once on site, you'll never have to return to the distributor for missing parts. The fittings are packaged with the pan for simple and efficient installation. Choose between two possible drain outlet positions and install with confidence.



**6-M2748**

| CATALOG NO.    | DESCRIPTION                          | UOM | ORDER MULTIPLE |
|----------------|--------------------------------------|-----|----------------|
| <b>6-M2748</b> | 26 Gauge Metal Drain Pan – 27" x 48" | EA  | 5              |
| <b>6-M2763</b> | 26 Gauge Metal Drain Pan – 27" x 63" | EA  | 5              |
| <b>6-M3030</b> | 26 Gauge Metal Drain Pan – 30" x 30" | EA  | 5              |
| <b>6-M3050</b> | 26 Gauge Metal Drain Pan – 30" x 50" | EA  | 5              |
| <b>6-M3060</b> | 26 Gauge Metal Drain Pan – 30" x 60" | EA  | 5              |
| <b>6-M3263</b> | 26 Gauge Metal Drain Pan – 32" x 63" | EA  | 5              |

**A/C Condensate Drain Pan Fittings**

The Drain Pan Fittings are designed to be used with our Condensate Drain Pans.



| CATALOG NO. | DESCRIPTION                | UOM | ORDER MULTIPLE |
|-------------|----------------------------|-----|----------------|
| <b>6-1</b>  | 3/4" Slip                  | EA  | 50             |
| <b>6-2</b>  | 1" Slip                    | EA  | 50             |
| <b>6-3</b>  | 3/4" Slip with Plastic Nut | EA  | 50             |
| <b>6-5</b>  | 3/4" Female Pipe Thread    | EA  | 50             |

**Water Heater Pans**

Aluminum water heater pans can be installed under gas or electric water heaters to protect from water damage. Includes a 1" PVC drain fittings to allow for connection to indirect drain. Each pan is manufactured from .032 in. prime aluminum with a pre-cut side opening to accommodate a drain fitting. Pan depth is a minimum 2.5 in.



**6-M22**

| CATALOG NO.  | DESCRIPTION                        | UOM | ORDER MULTIPLE |
|--------------|------------------------------------|-----|----------------|
| <b>6-M22</b> | Aluminum Water Heater Pan - 22 in. | EA  | 6              |
| <b>6-M24</b> | Aluminum Water Heater Pan - 24 in. | EA  | 6              |
| <b>6-M26</b> | Aluminum Water Heater Pan - 26 in. | EA  | 6              |
| <b>6-M30</b> | Aluminum Water Heater Pan - 30 in. | EA  | 6              |

**CONDENSATE DRAIN PANS, FITTINGS, ADAPTERS cont'd**

**Mini-Split Drain Adapters**

Mini Split fan units — either ceiling cassettes or wall cassettes — typically have a unique (metric) drain line fitting. DiversiTech's adapters convert this metric fitting to standard drain line tubing sizes.



| CATALOG NO.      | DESCRIPTION                        | UOM | ORDER MULTIPLE |
|------------------|------------------------------------|-----|----------------|
| <b>230-DLFY</b>  | Mini-Split Drain Line Wye          | EA  | 1              |
| <b>230-DLF16</b> | 16mm Mini-Split Drain Line Adapter | EA  | 1              |
| <b>230-DLF18</b> | 18mm Mini-Split Drain Line Adapter | EA  | 1              |
| <b>230-DLF20</b> | 20mm Mini-Split Drain Line Adapter | EA  | 1              |
| <b>230-DLF25</b> | 25mm Mini-Split Drain Line Adapter | EA  | 1              |
| <b>230-DLF32</b> | 32mm Mini-Split Drain Line Adapter | EA  | 1              |

**Condensate Drain Pans**

When a mini split system operates in heat pump mode, the outdoor coil becomes the evaporator coil. Typically, condensation generates from the evaporator coil. In certain installations, the condenser coil may be mounted overhead on brackets affixed to a wall. In these overhead applications, dripping condensation may be a nuisance. Condensate drain pans bolt onto the condenser mounting brackets, and the drain line can be plumbed to a nearby drain location. Furnished complete with all mounting hardware and drain pan outlet, condensate drain pans are available in either plastic or powder coated steel.



| CATALOG NO.     | DESCRIPTION                        | UOM | ORDER MULTIPLE |
|-----------------|------------------------------------|-----|----------------|
| <b>230-DPPL</b> | Poly Condensate Drain Pan (Large)  | EA  | 1              |
| <b>230-DPPM</b> | Poly Condensate Drain Pan (Medium) | EA  | 1              |

**DRAIN LINE, TUBING**

**Mini-Split Condensate Drain Line**

A unique drain line for mini-split units. This large diameter drain line is typical for mini-split installations. Furnished in 160 feet lengths with cut marks every 3.28 feet. Accommodates 5/8" and 3/4" connections.



| CATALOG NO.        | DESCRIPTION                                 | UOM | ORDER MULTIPLE |
|--------------------|---|-----|----------------|
| <b>230-DL16</b>    | 5/8" ID Mini-Split Drain Line               | EA  | 160'           |
| <b>230-DL16-20</b> | 5/8" ID Mini-Split Drain Line – 20' section | EA  | 1              |

**Clear Vinyl Tubing**

Clear vinyl hose applications include: air conditioning and refrigeration condensate drains, condensate pump discharge lines and humidifier overflows.

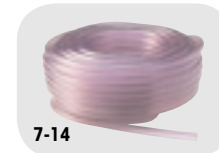

| CATALOG NO.         | DESCRIPTION                                | UOM | ORDER MULTIPLE |
|---------------------|--|-----|----------------|
| <b>7-316</b>        | 3/16" ID Clear Vinyl Tubing – 100' section | EA  | 100'           |
| <b>7-CVMINITUBE</b> | 3/16" ID CVMINI Tubing – 100' section      | EA  | 100'           |
| <b>7-14</b>         | 1/4" ID Clear Vinyl Tubing – 100' section  | EA  | 100'           |
| <b>7-38</b>         | 3/8" ID Clear Vinyl Tubing – 100' section  | EA  | 100'           |
| <b>7-12</b>         | 1/2" ID Clear Vinyl Tubing – 100' section  | EA  | 100'           |
| <b>7-58</b>         | 5/8" ID Clear Vinyl Tubing – 100' section  | EA  | 100'           |
| <b>7-34</b>         | 3/4" ID Clear Vinyl Tubing – 100' section  | EA  | 100'           |
| <b>7-78</b>         | 7/8" ID Clear Vinyl Tubing – 100' section  | EA  | 50'            |
| <b>7-10</b>         | 1" ID Clear Vinyl Tubing – 100' section    | EA  | 50'            |

**Gorilla Tube® Clear Vinyl Tubing**

Applications include: air conditioning and refrigeration condensate drains, condensate pump discharge lines, and humidifier overflows. Several sizes from 1/4" to 1" diameter. Non-toxic clear vinyl chloride.

Select Gorilla Tube® over standard clear vinyl tube because:

- Extra rigid design resists crimping and kinking due to durometer value of 80 (Shore A) and thicker wall
- Maximum service temperature 140°F (60°C)
- Better performance in cold weather climates.



| CATALOG NO.  | DESCRIPTION  | UOM | ORDER MULTIPLE |
|--------------|--|-----|----------------|
| <b>7-14P</b> | 1/4", .250" I.D., .360" O.D., .055 wall thickness  | EA  | 100'           |
| <b>7-38P</b> | 3/8", .375" I.D., .495" O.D., .060 wall thickness  | EA  | 100'           |
| <b>7-12P</b> | 1/2", .500" I.D., .631" O.D., .066 wall thickness  | EA  | 100'           |
| <b>7-58P</b> | 5/8", .625" I.D., .771" O.D., .073 wall thickness  | EA  | 100'           |
| <b>7-34P</b> | 3/4", .750" I.D., .913" O.D., .082 wall thickness  | EA  | 100'           |
| <b>7-78P</b> | 7/8", .875" I.D., 1.050" O.D., .088 wall thickness | EA  | 50'            |
| <b>7-10P</b> | 1", 1.000" I.D., 1.215" O.D., .108 wall thickness  | EA  | 50'            |

**Braided Clear Vinyl Tubing**

Braided clear vinyl offers better strength and sealing than regular clear vinyl tubing and is very kink-resistant.



| CATALOG NO.  | DESCRIPTION                                       | UOM | ORDER MULTIPLE |
|--------------|---|-----|----------------|
| <b>7-14B</b> | 1/4" ID Braided Clear Vinyl Tubing – 100' section | EA  | 100'           |
| <b>7-38B</b> | 3/8" ID Braided Clear Vinyl Tubing – 100' section | EA  | 100'           |
| <b>7-12B</b> | 1/2" ID Braided Clear Vinyl Tubing – 100' section | EA  | 100'           |
| <b>7-58B</b> | 5/8" ID Braided Clear Vinyl Tubing – 100' section | EA  | 100'           |
| <b>7-34B</b> | 3/4" ID Braided Clear Vinyl Tubing – 100' section | EA  | 100'           |

**TAPES**

**Cork Insulation Tape**

Adheres firmly to all metals. Use on hot or cold pipes to stop condensation and drips.



| CATALOG NO.  | DESCRIPTION   | UOM | ORDER MULTIPLE |
|--------------|---|-----|----------------|
| <b>6-330</b> | Cork Insulation Tape – 1/8" x 2" x 30' Roll – Black | EA  | 12             |

**Foam Insulation Tape**

Superior self-adhesive foam tape can be used on hot or cold pipes. Fits well around valves and fittings. Easily cut and molded.



| CATALOG NO.   | DESCRIPTION   | UOM | ORDER MULTIPLE |
|---------------|---|-----|----------------|
| <b>6-9718</b> | Foam Insulation Tape – 1/8" x 2" x 30' Roll – Black | EA  | 12             |

**PTFE Tape**

Made of pure white PTFE. Non toxic. For use with chemicals, solvents, oxygen, and on food lines. Withstands up to 2000 psi of pressure.



| CATALOG NO.  | DESCRIPTION               | UOM | ORDER MULTIPLE |
|--------------|---------------------------|-----|----------------|
| <b>6-733</b> | Teflon Tape – 1/2" x 520" | EA  | 100            |
| <b>6-734</b> | Teflon Tape – 1/2" x 260" | EA  | 100            |
| <b>6-735</b> | Teflon Tape – 3/4" x 520" | EA  | 100            |
| <b>6-736</b> | Teflon Tape – 3/4" x 260" | EA  | 100            |



# GENERAL INDUSTRIAL

|   |       |
|---|-------|
| Abrasive Cloths.....                        | 84    |
| Aerosols.....                               | 84    |
| Batteries By Rayovac®.....                  | 85    |
| Carton Sealing Tape and Dispenser.....      | 85    |
| Contact Cleaners.....                       | 85-86 |
| Degreasers.....                             | 86    |
| Drop Cloths.....                            | 86    |
| Hand Cleaners.....                          | 86    |
| Industrial Towels.....                      | 87    |
| Lubricants.....                             | 87-88 |
| Markers.....                                | 89    |
| Paints and Primers.....                     | 89    |
| Safety Supplies, Devices.....               | 90    |
| Sealant, Epoxy, Glue.....                   | 91    |
| Sealing Compounds, Adhesive.....            | 91-93 |
| Sheet Metal Screws.....                     | 93-94 |
| Wasp, Hornet and Yellow Jacket Killers..... | 94    |



**ABRASIVE CLOTHS**

**All Purpose Cleaning Pads**

For cleaning copper tubes and fittings. Made of nylon and will not rust. Can be used wet or dry. Leaves no residue and is long lasting.



**ACP-10**

| CATALOG NO.   | DESCRIPTION                            | UOM | ORDER MULTIPLE |
|---------------|--|-----|----------------|
| <b>ACP-10</b> | All Purpose Cleaning Pads – pack of 10 | PK  | 1              |

**Abrasive Cloth**

Aluminum oxide, high quality 120 grit, abrasive cloth to thoroughly clean copper and steel tubing. Works wet or dry. Exceeds industry standards for abrasive cloth.



**SC-10**

| CATALOG NO.  | DESCRIPTION                       | UOM | ORDER MULTIPLE |
|--------------|-----------------------------------|-----|----------------|
| <b>SC-10</b> | Abrasive Cloth – 1-1/2" x 10 yds. | EA  | 1              |
| <b>SC-25</b> | Abrasive Cloth – 1-1/2" x 25 yds. | EA  | 1              |

**Grip-Cut™**

Open mesh sand screen cloth. Aluminum oxide grain resin bonded to synthetic nylon cloth. 100% waterproof, but can also be used dry for sanding by hand or with portable tools. Most effective where clogging is a problem, such as soft materials. 180 grit.



**SCM-5**

| CATALOG NO.   | DESCRIPTION                  | UOM | ORDER MULTIPLE |
|---------------|------------------------------|-----|----------------|
| <b>SCM-5</b>  | Grip-Cut™ – 1-1/2" x 5 yds.  | EA  | 1              |
| <b>SCM-10</b> | Grip-Cut™ – 1-1/2" x 10 yds. | EA  | 1              |
| <b>SCM-25</b> | Grip-Cut™ – 1-1/2" x 25 yds. | EA  | 1              |

**AEROSOLS**

**Sure-Stick Heavy Duty Adhesive Spray**

Wide web spray adhesive ideal for both temporary or permanent bonding. Waterproof, transparent and non-staining. Use for the toughest adhesive applications with leather, cardboard, most plastics, polyethylene sheeting and insulation in HVAC applications. Cleans with mineral spirits. Not for use on vinyl.



**315-20**

| CATALOG NO.   | DESCRIPTION                                | UOM | ORDER MULTIPLE |
|---------------|--|-----|----------------|
| <b>315-20</b> | Sure-Stick Adhesive Spray – 12 oz. Aerosol | EA  | 12             |

**CBC II Contact Cleaner**

A plastic safe, non flammable electronic contact and circuit board cleaner. Dries fast, leaves no residue. No harsh fumes or odors.



**362-16**

| CATALOG NO.   | DESCRIPTION                             | UOM | ORDER MULTIPLE |
|---------------|---|-----|----------------|
| <b>362-16</b> | CBC II Contact Cleaner – 10 oz. Aerosol | EA  | 12             |

**Sweat-Free Pipe Insulation Spray**

An aerosol spray on insulation specifically developed for cold water pipes, refrigeration and air conditioning lines. Stops sweating and dripping problems. Dries to a clean, white, flexible and water resistant coating. Adheres to galvanized, black iron, steel, brass, copper and PVC piping.



**770-15**

| CATALOG NO.   | DESCRIPTION                                 | UOM | ORDER MULTIPLE |
|---------------|---|-----|----------------|
| <b>770-15</b> | Sweat-Free Pipe Insulation – 15 oz. Aerosol | EA  | 12             |

**Glass Cleaner**

A foaming premium glass cleaner that powers through the toughest grease and grime on any glass or hard surface. Leaves a streak-free shine.



**325-12**

| CATALOG NO.   | DESCRIPTION                    | UOM | ORDER MULTIPLE |
|---------------|--------------------------------|-----|----------------|
| <b>325-12</b> | Glass Cleaner – 19 oz. Aerosol | EA  | 12             |

## BATTERIES BY RAYOVAC®

**Rayovac is the Industrial Product Leader!** Rayovac is the leader in the industrial battery market and has been for years, with an estimated 50% share of the traditional industrial distribution channel. Rayovac introduced the top-selling industrial flashlight to the market, and set the quality standard by which all other industrial flashlights are measured today. Whether your customer is searching for a toolbox-tough flashlight or high-performance batteries, Rayovac offers a broad range of products to meet your needs.

### Rayovac Industrial Maximum Alkaline Batteries – Shrink Packed

- Same battery performance as the Contractor Packs at a lower cost
- Formulated specifically to exceed the everyday demands of industrial applications
- Outstanding dependability for “must work” applications



| CATALOG NO.    | DESCRIPTION                                     | UOM | ORDER MULTIPLE |
|----------------|---|-----|----------------|
| <b>7-ALAA</b>  | Alkaline AA Battery – Shrink Packed, pack of 8  | EA  | 8              |
| <b>7-ALAAA</b> | Alkaline AAA Battery – Shrink Packed, pack of 8 | EA  | 8              |
| <b>7-ALC</b>   | Alkaline C Battery – Shrink Packed, pack of 6   | EA  | 6              |
| <b>7-ALD</b>   | Alkaline D Battery – Shrink Packed, pack of 6   | EA  | 6              |
| <b>7-AL9V</b>  | Alkaline 9V Battery – Shrink Packed, pack of 6  | EA  | 6              |

### Rayovac Lantern Batteries

- Dependable performance — for “must work” applications
- Available in General Purpose, Heavy Duty, and Alkaline Maximum



| CATALOG NO.  | DESCRIPTION   | UOM | ORDER MULTIPLE |
|--------------|---|-----|----------------|
| <b>7-806</b> | 6 Volt Alkaline Maximum – Spring Terminals, pack of 6 | EA  | 6              |
| <b>7-918</b> | 6 Volt General Purpose – Screw Terminals, pack of 6   | EA  | 6              |
| <b>7-944</b> | 6 Volt Lantern Battery, pack of 6                     | EA  | 6              |

### Rayovac Industrial Maximum Alkaline Batteries — Contractor Packs

- Contractor preferred, clear, re-sealable package
- Greater battery per pack quantities command higher battery sales
- Displays much more readily than other competitive batteries
- In an HVAC test market, the Contractor Packs outsold the standard packs by a greater than 2 to 1 ratio!

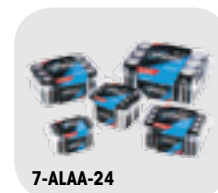

| CATALOG NO.       | DESCRIPTION  | UOM | ORDER MULTIPLE |
|-------------------|--|-----|----------------|
| <b>7-ALAA-24</b>  | Alkaline AA Battery – Contractor Pack, pack of 24  | EA  | 24             |
| <b>7-ALAAA-18</b> | Alkaline AAA Battery – Contractor Pack, pack of 18 | EA  | 18             |
| <b>7-ALC-12</b>   | Alkaline C Battery – Contractor Pack, pack of 12   | EA  | 12             |
| <b>7-ALD-12</b>   | Alkaline D Battery – Contractor Pack, pack of 12   | EA  | 12             |
| <b>7-AL9V-8</b>   | Alkaline 9V Battery – Contractor Pack, pack of 8   | EA  | 8              |

## CARTON SEALING TAPE AND DISPENSER

### Carton Sealing Tape

This Clear 2.4 mil Sealing Tape is 2in. nominal width and is 110 yds. in length



| CATALOG NO.      | DESCRIPTION                                  | UOM | ORDER MULTIPLE |
|------------------|--|-----|----------------|
| <b>540-2110C</b> | Carton Sealing Tape – 2” x 110 Yards – Clear | EA  | 36             |

### Carton Tape Dispenser

A Heavy Duty Tape Dispenser that holds 2in. Tape.



| CATALOG NO.     | DESCRIPTION              | UOM | ORDER MULTIPLE |
|-----------------|--------------------------|-----|----------------|
| <b>540-DISP</b> | 2” Carton Tape Dispenser | EA  | 1              |

## CONTACT CLEANERS

### HF™ Contact Cleaner

A petroleum distillate based precision cleaner with a flash point of 205°F. It can be an alternative to CFCs when applications require higher flashpoints.



| CATALOG NO.      | DESCRIPTION                  | UOM | ORDER MULTIPLE |
|------------------|------------------------------|-----|----------------|
| <b>CRC-4-140</b> | HF™ Contact Cleaner – 11 oz. | EA  | 12             |

### QD® Contact Cleaner

This contact cleaner is suitable for cleaning sensitive electronics and electrical equipment and does not leave any residue. It evaporates quickly and is safe to use on all plastics. This product is more useful where lower flashpoint cleaners are acceptable. The QD® Contact Cleaner is NSF K2 Registered.



| CATALOG NO.    | DESCRIPTION                  | UOM | ORDER MULTIPLE |
|----------------|------------------------------|-----|----------------|
| <b>CRC-4CF</b> | QD® Contact Cleaner – 11 oz. | EA  | 12             |



**CONTACT CLEANERS** cont'd

**Electronic Degreaser**

This Advanced Technology Formula is non-chlorinated, non-conductive, non-corrosive and non-staining. It rapidly dissolves grease, oil and sludge for better efficiency of mechanical equipment. The Electronic Degreaser has no flash or fire point.



| CATALOG NO.    | DESCRIPTION                   | UOM | ORDER MULTIPLE |
|----------------|-------------------------------|-----|----------------|
| <b>CRC-4NU</b> | Electronic Degreaser – 15 oz. | EA  | 12             |

**DEGREASERS**

**Heavy Duty Degreaser**

This degreaser rapidly and effectively removes grease, oil, tar, and other residue to increase operating efficiency of equipment. It has no flash or fire point, making it an excellent alternative to 1,1,1-based cleaners. Please use caution on plastics.



| CATALOG NO.   | DESCRIPTION                   | UOM | ORDER MULTIPLE |
|---------------|-------------------------------|-----|----------------|
| <b>CRC-7X</b> | Heavy Duty Degreaser – 19 oz. | EA  | 12             |

**Heavy Duty Degreaser II**

The Heavy Duty Degreaser II is a non-chlorinated, zero VOC formula for cleaning where chlorinated solvents are prohibited. It has a high flashpoint of 180°F. This degreaser effectively removes soils with no residue build-up. Please exercise caution on plastics.



| CATALOG NO.      | DESCRIPTION                      | UOM | ORDER MULTIPLE |
|------------------|----------------------------------|-----|----------------|
| <b>CRC-7-140</b> | Heavy Duty Degreaser II – 15 oz. | EA  | 12             |

**Chlor-Free® Degreaser**

Non-chlorinated degreasing solvent which is used to remove oil, grease and other contaminants. It is especially useful for applications requiring a quick turnaround and where a low flashpoint solvent can be used.



| CATALOG NO.   | DESCRIPTION                    | UOM | ORDER MULTIPLE |
|---------------|--------------------------------|-----|----------------|
| <b>CRC-7Z</b> | Chlor-Free® Degreaser – 14 oz. | EA  | 12             |

**Citrus Degreaser**

The Citrus Degreaser has a new Low VOC Formula. The product removes grease, oil and lubricants with no water wash-off. It evaporates quickly and leaves no residue. The product gives off a pleasant citrus scent and is NSF C1 Registered.



| CATALOG NO.    | DESCRIPTION               | UOM | ORDER MULTIPLE |
|----------------|---------------------------|-----|----------------|
| <b>CRC-7PS</b> | Citrus Degreaser – 15 oz. | EA  | 12             |

**DROP CLOTHS**

**Canvas Drop Cloths**

Premium grade canvas drop cloths are made of first quality and full piece 100% cotton duck canvas fabric. The industrial grade canvas fabric is durable since it is tightly woven using virgin cotton yarn. The drop cloths are washable and reusable. Double stitched seams with heavy-duty rot resistant thread.



| CATALOG NO.    | DESCRIPTION                  | UOM | ORDER MULTIPLE |
|----------------|------------------------------|-----|----------------|
| <b>DC-4128</b> | Canvas Drop Cloth - 4' x 12' | EA  | 1              |
| <b>DC-9128</b> | Canvas Drop Cloth - 9' x 12' | EA  | 1              |

**HAND CLEANERS**

**Fast Orange® Hand Cleaner**

Three out of five people prefer Fast Orange® over other hand cleaners. The first biodegradable, waterless hand cleaner with aloe, lanolin, and jojoba. Smooth lotion and extra-fine pumice available. USDA Approved.



| CATALOG NO.    | DESCRIPTION  | UOM | ORDER MULTIPLE |
|----------------|--|-----|----------------|
| <b>HCO-7</b>   | Fast Orange® – 7-1/2 fl. oz. Smooth Squeeze Bottle | EA  | 12             |
| <b>HCO-15</b>  | Fast Orange® – 15 oz. Smooth Squeeze Bottle        | EA  | 12             |
| <b>HCO-128</b> | Fast Orange® – 1 Gallon Smooth with Dispenser      | EA  | 4              |
| <b>HCP-7</b>   | Fast Orange® – 7-1/2 fl. oz. Pumice Squeeze Bottle | EA  | 12             |
| <b>HCP-15</b>  | Fast Orange® – 15 oz. Pumice Squeeze Bottle        | EA  | 12             |

**Kimberly-Clark Waterless Hand Wipes**

These wipes go wherever hands go to get dirty. Full sized 12" x 12" wipes for full sized cleaning. Natural cleaning agent is tough on grease, grime, ink, and paint. Dual textured – smooth for wiping on one side and tough for scrubbing on the other. More wipes with our 75 count bucket.



| CATALOG NO.    | DESCRIPTION                                  | UOM | ORDER MULTIPLE |
|----------------|--|-----|----------------|
| <b>5-42272</b> | Kimberly-Clark Waterless Hand Wipes – Bucket | EA  | 1              |

## INDUSTRIAL TOWELS

### WypAll Plus

Absorbs grease, oil, water and solvents from floors, hands, parts, tools and machinery. Tough enough for extra heavy jobs. Comes in a convenient pop-up box of 100 towels.



5-05790

| CATALOG NO. | DESCRIPTION                           | UOM | ORDER MULTIPLE |
|-------------|---------------------------------------|-----|----------------|
| 5-05790     | WypAll Plus Towels—White, pack of 100 | PK  | 1              |

### Kimtex® Towels

Long lasting Kimtex® stands up to oils, chemicals and solvents better than ordinary shop towels. Cloth-like feel and performance. Towel size is 9-3/4" x 16-3/4". 100 towels/box. 5 boxes/case.



5-33570

| CATALOG NO. | DESCRIPTION                     | UOM | ORDER MULTIPLE |
|-------------|---------------------------------|-----|----------------|
| 5-33570     | Kimtex Shop Towels, pack of 100 | PK  | 1              |

### Teri® Towels

The Teri® reinforced towels feature multi-ply tissue reinforced with nylon webbing for added strength on the job. Made from 100% recycled paper. Towel size is 9-3/4" x 16-3/4". Towel color is white. Comes in a convenient pop up box. 126 towels/box. 10 boxes/case.



5-34790

| CATALOG NO. | DESCRIPTION                         | UOM | ORDER MULTIPLE |
|-------------|-------------------------------------|-----|----------------|
| 5-34790     | Teri Reinforced Towels, pack of 126 | PK  | 1              |

### WypAll ShopPro X80 Towels

Like a rental shop towel, only more consistent. Engineered to feel like cloth and work even better. Absorbs more oil and water faster pound for pound than laundered shop towels. The ShopPro X80 is simply the heaviest duty towel in the Kimberly Clark line. 160 towels/box.



5-41041

| CATALOG NO. | DESCRIPTION                            | UOM | ORDER MULTIPLE |
|-------------|--|-----|----------------|
| 5-41041     | WypAll ShopPro X80 Towels, pack of 160 | PK  | 1              |

### Workhorse® Manufactured Rags

The economical alternative to scrap rags. Workhorse® Manufactured Rags is the first product to be made from Kimberly-Clark's advanced new material – Hydroknit®. Durable, rag tough construction stands up to any task. Can be re-used time and time again. Available in white or blue.



5-41455

| CATALOG NO. | DESCRIPTION                         | UOM | ORDER MULTIPLE |
|-------------|-------------------------------------|-----|----------------|
| 5-41455     | 9-3/4" x 16-3/4" White, pack of 100 | PK  | 1              |
| 5-41411     | 9-3/4" x 16-3/4" Blue, pack of 100  | PK  | 1              |

### Terry Towels

100% cotton. Minimum of 14" x 17". Pre-washed for absorbency, fully-hemmed, all-white, and reusable.



DTT-10

| CATALOG NO. | DESCRIPTION              | UOM | ORDER MULTIPLE |
|-------------|--------------------------|-----|----------------|
| DTT-10      | Terry Towels, pack of 10 | PK  | 1              |
| DTT-24      | Terry Towels, pack of 24 | PK  | 8              |

### Shop Towels

Heavy duty reusable towels. For wipe ups of grease, oil, water, etc. 100% cotton material is pre-shrunk and hemmed. Each towel measures 13" x 16".



ST-10

| CATALOG NO. | DESCRIPTION             | UOM | ORDER MULTIPLE |
|-------------|-------------------------|-----|----------------|
| ST-4        | Shop Towels, pack of 4  | PK  | 1              |
| ST-10       | Shop Towels, pack of 10 | PK  | 1              |
| ST-24       | Shop Towels, pack of 24 | PK  | 1              |

## LUBRICANTS

### Knock'er Loose® Penetrating Solvent

An industrial strength, low viscosity penetrant designed to rapidly loosen and free seized, bound or frozen fasteners. This product also quickly permeates rust, scale, gum, grease and corrosion. Independent tests reveal that it outperforms its competition.



CRC-1KB

| CATALOG NO. | DESCRIPTION                                  | UOM | ORDER MULTIPLE |
|-------------|--|-----|----------------|
| CRC-1KB     | Knock'er Loose® Penetrating Solvent – 13 oz. | EA  | 12             |

### Screwloose® Industrial Penetrating Oil

A no compromise penetrant that attacks corrosion to free corroded fasteners and mechanical components. A super fast, powerful, concentrated penetrating solvent that loosens rust scale and corrosion and instantly penetrates minute and tightly fitted crevices.



CRC-8

| CATALOG NO. | DESCRIPTION                                     | UOM | ORDER MULTIPLE |
|-------------|---|-----|----------------|
| CRC-8       | Screwloose® Industrial Penetrating Oil – 11 oz. | EA  | 12             |

LUBRICANTS cont'd

**White Lithium Grease**

White Lithium Grease has superior lubrication and durability in any weather or temperature. It is useful as a break in lubricant for bearings or as a general purpose lubricant and corrosion inhibitor for tools, machinery and equipment.



CRC-9

| CATALOG NO. | DESCRIPTION                   | UOM | ORDER MULTIPLE |
|-------------|-------------------------------|-----|----------------|
| CRC-9       | White Lithium Grease – 10 oz. | EA  | 12             |

**Ultra Lite 3-36® Ultra Thin Non Staining Lubricant**

Ultra thin, non staining lubricant that resists oil, dirt and dust build up. This lubricant also seals out moisture and protects against corrosion. It is excellent for drying out electrical components.



CRC-1

| CATALOG NO. | DESCRIPTION   | UOM | ORDER MULTIPLE |
|-------------|---|-----|----------------|
| CRC-1       | Ultra Lite 3-36® Ultra Thin Non Staining Lubricant – 11 oz. | EA  | 12             |

**3-36® Multi-Purpose Lubricant & Corrosion Inhibitor**

A multi-purpose petroleum based compound that forms a clear, thin film that lubricates and protects against wear and corrosion. The product also displaces moisture and cleans.



CRC-2

| CATALOG NO. | DESCRIPTION  | UOM | ORDER MULTIPLE |
|-------------|--|-----|----------------|
| CRC-2       | 3-36® Multi-Purpose Lubricant & Corrosion Inhibitor – 11 oz. | EA  | 12             |

**SP-400™ Corrosion Inhibitor**

Long-term corrosion inhibitor that protects equipment subject to heat, humidity, chemicals or severely corrosive atmospheres. This product is best to use on machined surfaces and assemblies subjected to long periods of storage.



CRC-3

| CATALOG NO. | DESCRIPTION                          | UOM | ORDER MULTIPLE |
|-------------|--------------------------------------|-----|----------------|
| CRC-3       | SP-400™ Corrosion Inhibitor – 10 oz. | EA  | 12             |

**Zinc-It® Instant Cold Galvanize™ Zinc Rich Galvanize Coating**

High-performance zinc coating that electrochemically bonds with ferrous metals to form a galvanic cell. The product also fights rust and corrosion and can be used as a touch-up for damaged galvanized coatings. Zinc-It® Instant Cold Galvanize™ Zinc Rich Galvanize Coating dries quickly.



CRC-5

| CATALOG NO. | DESCRIPTION   | UOM | ORDER MULTIPLE |
|-------------|---|-----|----------------|
| CRC-5       | Zinc-It® Instant Cold Galvanize™ Zinc Rich Galvanize Coating – 13 oz. | EA  | 12             |
| CRC-5BC     | Bright Zinc-It® Instant Cold Galvanize™ Coating – 13 oz.              | EA  | 12             |

**Sta-Plex™ Extreme Pressure Premium Red Grease**

A superior multi-purpose certified lithium complex based grease which contains extreme pressure, anti-wear, and anti-oxidation additives. The product is very useful in high temperature and performance applications. The drop point is 500°F.



CRC-13

| CATALOG NO. | DESCRIPTION  | UOM | ORDER MULTIPLE |
|-------------|--|-----|----------------|
| CRC-13      | Sta-Plex™ Extreme Pressure Premium Red Grease – 14 oz. | EA  | 10             |

**WD-40®**

Loosens rusted parts. Stops squeaks. Removes tar, grease and adhesives. Displaces moisture. Protects metal. New Smart Straw can.



741-001

| CATALOG NO. | DESCRIPTION                  | UOM | ORDER MULTIPLE |
|-------------|------------------------------|-----|----------------|
| 741-001     | WD-40 – 8 oz.                | EA  | 12             |
| 741-002     | WD-40 – 11 oz.               | EA  | 12             |
| 741-003     | WD-40, 14.4oz with E-Z Reach | EA  | 12             |

**Heavy Duty Silicone Mold Release**

This product provides maximum releases and is useful in difficult to remove parts. The Heavy Duty Silicone Mold Release is colorless, odorless, non-staining and non-corrosive.



CRC-6

| CATALOG NO. | DESCRIPTION                               | UOM | ORDER MULTIPLE |
|-------------|---|-----|----------------|
| CRC-6       | Heavy Duty Silicone Mold Release – 12 oz. | EA  | 12             |

**Cutting Oil**

Cutting Oil is a superior thread cutting lubricant for use on all types of metals, including brass, copper and aluminum. For use on ferrous and non-ferrous metals. Clings to vertical surfaces for improved performance.



CRC-CF2

| CATALOG NO. | DESCRIPTION                  | UOM | ORDER MULTIPLE |
|-------------|------------------------------|-----|----------------|
| CRC-CF2     | Cutting Oil - 16 oz. aerosol | EA  | 1              |

**Pull-A-Spout Oiler**

All purpose oiler with a 14in. telescoping spout. Zooms out for long shots, and in for short shots, even zooms around corners. Squeeze bottle action. Perfect lubricant for general industrial use. Contains four ounces of finest quality carbon free, rust and oxidation inhibited lubricating oil. Plastic container won't short out around electrical connections. No leakage.



CO-1

| CATALOG NO. | DESCRIPTION                            | UOM | ORDER MULTIPLE |
|-------------|--|-----|----------------|
| CO-1        | Pull-A-Spout Oiler – 4 oz. – (Display) | EA  | 12             |
| CR-1        | Lubricant, Rust Breaker – 4 oz.        | EA  | 12             |



**MARKERS**

**Valve Action Marker**

Large ink supply for increased mileage. Fast drying, smear and water resistant. Utilizes a patented valve-activated ink feed mechanism to supply ink as required, down to the last drop.



| CATALOG NO.    | DESCRIPTION                             | UOM | ORDER MULTIPLE |
|----------------|---|-----|----------------|
| <b>540-799</b> | Valve Action Marker-Regular Tip – Red   | EA  | 12             |
| <b>540-800</b> | Valve Action Marker-Regular Tip – Black | EA  | 12             |

**Felt Tip Markers**

Sharpie® King-Sized Permanent Marker for metal, glass, paper and plastic. Durable metal body.



| CATALOG NO.     | DESCRIPTION                | UOM | ORDER MULTIPLE |
|-----------------|----------------------------|-----|----------------|
| <b>540-811B</b> | Sharpie® King-Sized Marker | EA  | 12             |

**Valve Action Paint Marker**

Bright, crisp, opaque colors. The oil-based paint is quick drying and permanent on most surfaces. These markers also feature the patented valve-operated feed mechanism and a medium point.



| CATALOG NO.    | DESCRIPTION                        | UOM | ORDER MULTIPLE |
|----------------|------------------------------------|-----|----------------|
| <b>540-805</b> | Valve Action Paint Marker – Black  | EA  | 12             |
| <b>540-806</b> | Valve Action Paint Marker – Red    | EA  | 12             |
| <b>540-807</b> | Valve Action Paint Marker – White  | EA  | 12             |
| <b>540-808</b> | Valve Action Paint Marker – Yellow | EA  | 12             |

**PAINTS AND PRIMERS**

**General Purpose Spray Paint**

New, more complete line of professional quality fast drying spray paints. Color code compressors or refrigerant recovery cylinders to match standard refrigerant identifying colors. Touch up equipment housings. Product meets most recent VOC legislation and is currently compliant.



| CATALOG NO.    | DESCRIPTION                                | UOM | ORDER MULTIPLE |
|----------------|--|-----|----------------|
| <b>799-001</b> | Spray Paint – Gloss Black – 12 oz.         | EA  | 6              |
| <b>799-002</b> | Spray Paint – Flat Black – 12 oz.          | EA  | 6              |
| <b>799-003</b> | Spray Paint – Gloss White – 12 oz.         | EA  | 6              |
| <b>799-004</b> | Spray Paint – Flat White – 12 oz.          | EA  | 6              |
| <b>799-005</b> | Spray Paint – Dark Machinery Gray – 12 oz. | EA  | 6              |
| <b>799-006</b> | Spray Paint – Gray Primer – 12 oz.         | EA  | 6              |
| <b>799-009</b> | Spray Paint – Astro Blue – 12 oz.          | EA  | 6              |
| <b>799-010</b> | Spray Paint – Orange – 12 oz.              | EA  | 6              |
| <b>799-011</b> | Spray Paint – Aluminum (Silver) – 12 oz.   | EA  | 6              |
| <b>799-012</b> | Spray Paint – Zinc Rich Primer – 14 oz.    | EA  | 6              |
| <b>799-013</b> | Spray Paint – Bright Red – 12 oz.          | EA  | 6              |

**Industrial Enamel**

Finally an aerosol paint that sprays in any direction without clogging. We guarantee it! Dries tack free in 10 to 20 minutes; fully dry in just one hour. Excellent corrosion and solvent resistance. Resists heat up to 250°F. Now in 20 oz. cans. Product meets most recent VOC legislation and is currently compliant.



| CATALOG NO.    | DESCRIPTION                                       | UOM | ORDER MULTIPLE |
|----------------|---|-----|----------------|
| <b>799-021</b> | Industrial Enamel – Flat Black – 12 oz.           | EA  | 6              |
| <b>799-022</b> | Industrial Enamel – Gloss White – 12 oz.          | EA  | 6              |
| <b>799-024</b> | Industrial Enamel – Machinery Light Gray – 12 oz. | EA  | 6              |
| <b>799-025</b> | Industrial Enamel – Aluminum – 12 oz.             | EA  | 6              |

**High Heat Spray Paint**

An ultra high temperature coating formulated to resist temperatures up to 1300°F. Great for use on boilers, furnaces, steam pipes, chimney collars, compressors and engine manifolds. Product meets most recent VOC legislation and is currently compliant.



| CATALOG NO.    | DESCRIPTION                               | UOM | ORDER MULTIPLE |
|----------------|---|-----|----------------|
| <b>799-040</b> | High Heat Spray Paint – Aluminum – 12 oz. | EA  | 6              |
| <b>799-041</b> | High Heat Spray Paint – Black – 12 oz.    | EA  | 6              |

SAFETY SUPPLIES, DEVICES

**Latex Gloves**

Disposable natural latex rubber which provide a natural feel and grip. Powdered.



23010

| CATALOG NO. | DESCRIPTION                    | UOM | ORDER MULTIPLE |
|-------------|--------------------------------|-----|----------------|
| 23010       | Latex Gloves, pack of 50 pairs | PK  | 1              |

**Nitrile Gloves**

Foam control gloves for industrial use that provide a high level of wet and dry grip. Standard in applications where tactile sensitivity is required.



540-1005L

| CATALOG NO. | DESCRIPTION                             | UOM | ORDER MULTIPLE |
|-------------|---|-----|----------------|
| 540-1005L   | Nitrile Gloves - Large, 1 pair per pack | EA  | 1              |

**Heavy Duty Work Gloves**

Your choice of durable work gloves. Washable, breathable, and durable for everyday use.



540-HU1L

| CATALOG NO. | DESCRIPTION                                   | UOM | ORDER MULTIPLE |
|-------------|---|-----|----------------|
| 540-HU1L    | Heavy Utility Gloves - Large, 1 pair per pack | EA  | 1              |
| 540-BH1L    | Box Handler Gloves - Large, 1 pair per pack   | EA  | 1              |
| 540-LG1M    | Leather Gloves - Medium, 1 pair per pack      | EA  | 1              |

**Dust Masks**

Extremely lightweight, disposable, nuisance dust mask for non-toxic particles. Metal noseclips to fit individual facial contours.



5-500

| CATALOG NO. | DESCRIPTION            | UOM | ORDER MULTIPLE |
|-------------|------------------------|-----|----------------|
| 5-500       | Dust Masks, pack of 50 | PK  | 1              |

**Leather Work Gloves**

Versatile leather work gloves ideal for many industrial jobs. These leather work gloves offer: wing thumb pattern, continuous pull patch, seamless full leather index finger, leather knuckle strap, leather finger tips with elastic gather on back. Generously sized for a good working fit.

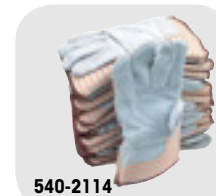

540-2114

| CATALOG NO. | DESCRIPTION  | UOM | ORDER MULTIPLE |
|-------------|--|-----|----------------|
| 540-2114    | Leather Glove w/Safety Cuff, 1 pair per pack                 | EA  | 12             |
| 540-2200    | Renegade® Performance Glove w/Kevlar Thread, 1 pair per pack | EA  | 1              |

**First Aid Kits**

10 and 25-unit first aid kits packaged in economy plastic boxes to assist when industrial accidents occur.



FAK-25

| CATALOG NO. | DESCRIPTION           | UOM | ORDER MULTIPLE |
|-------------|-----------------------|-----|----------------|
| FAK-10      | 10-Unit First Aid Kit | EA  | 1              |
| FAK-25      | 25-Unit First Aid Kit | EA  | 1              |

**Shoe Covers**

Slip these shoe covers on in seconds to protect carpet, tile, or wood from dirt and scuff marks. Customers will appreciate your professional appearance.



SC-1

| CATALOG NO. | DESCRIPTION                              | UOM | ORDER MULTIPLE |
|-------------|--|-----|----------------|
| SC-1        | Navy Blue Shoe Covers, pack of 50 pairs  | PK  | 1              |
| SC-1WP      | Waterproof Shoe Covers, pack of 50 pairs | PK  | 1              |
| SC-1SHU     | Dark Blue Shoe Covers, pack of 50 pairs  | PK  | 1              |

**SEALANT, EPOXY, GLUE**

**Thread Sealant with PTFE**

General purpose sealant with the lubricity of PTFE for metal pipes. Won't shred like PTFE Tape. Allows easy disassembly. Resists common shop fluids. 60° to 400°F temp. resistance. Pressure resistance of 5000 PSI.



| CATALOG NO.    | DESCRIPTION                                     | UOM | ORDER MULTIPLE |
|----------------|---|-----|----------------|
| <b>7-80632</b> | Thread Sealant – 1/4 Pint Brush Can             | EA  | 12             |
| <b>7-80633</b> | Thread Sealant – 1 Pint Brush Can., 12 per pack | EA  | 12             |

**Super Glue**

This adhesive can be used on dirty, greasy surfaces and the medium viscosity penetrates into preassembled and close fitting parts. It can be used on aluminum, metal, rubber, and most plastics for most tough jobs.



| CATALOG NO.   | DESCRIPTION              | UOM | ORDER MULTIPLE |
|---------------|--------------------------|-----|----------------|
| <b>DEP052</b> | Super Glue – 2 Gram Tube | EA  | 12             |

**J-B Weld**

The world's finest cold-weld compound for use when welding or soldering is out of the question due to cost, down time for repairs, or technical or environmental considerations. A remarkably easy, convenient, and inexpensive alternative to welding, soldering, and brazing. Literally pennies per use.



| CATALOG NO.   | DESCRIPTION           | UOM | ORDER MULTIPLE |
|---------------|-----------------------|-----|----------------|
| <b>JB8265</b> | J-B Weld 2 Part Epoxy | EA  | 6              |

**Wagner Adhesive Sealant**

For refrigerant sealing. Eliminates fastener loosening, leakage, and corrosion. Cures between thread flanks to seal against leakage and prevents thread corrosion. Offers sealing with maximum solvent resistance to the action of refrigerant (11, 12 and 22), ammonia and sulfur dioxide. Withstands corrosive liquids used in metal finishings and process industries. Ideal sealant for refrigeration, A/C, and process equipment using corrosive chemicals.



| CATALOG NO.     | DESCRIPTION                            | UOM | ORDER MULTIPLE |
|-----------------|--|-----|----------------|
| <b>CAS-2712</b> | Wagner Adhesive Sealant – 0.34 fl. oz. | EA  | 12             |

**Fast Cure Epoxy**

An easy-to-use, two part putty you simply mix and mold like clay. No complicated weighing or measuring required. Easy 1:1 cut-what-you-need mix ratio. Form it into any shape. It hardens in one hour and makes a final, steel-hard cure in 12 hours and can be sanded, drilled, machined, sawed and painted. Use on metal, wood, brick, stone, concrete, fiberglass, porcelain, tile and most plastics. Cures under water. 1.0 lb.

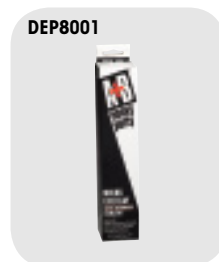

| CATALOG NO.    | DESCRIPTION                   | UOM | ORDER MULTIPLE |
|----------------|-------------------------------|-----|----------------|
| <b>DEP8001</b> | Gray Epoxy Putty – 1 lb. Kit  | EA  | 24             |
| <b>DEP8002</b> | White Epoxy Putty – 1 lb. Kit | EA  | 24             |

**SEALING COMPOUNDS, ADHESIVE**

**Flexi-Patch™**

Flexi-Patch™ is an easy to use flexible repair patch ideal for repairing almost any surface. It cures quickly using only UV light from sunlight or a UV flashlight for a long lasting, permanent repair. Flexi-Patch is a fiberglass-reinforced polyester ideal for use on PVC, plastics, metal, wood, concrete and more. It's the easy way to permanently patch almost any surface. It dries hard for permanent repair. Can be drilled, tapped and painted once dry.



| CATALOG NO.  | DESCRIPTION                  | UOM | ORDER MULTIPLE |
|--------------|------------------------------|-----|----------------|
| <b>FP-36</b> | Flexi-Patch fiberglass patch | EA  | 20             |

**Foam Sealant – One Component**

One component closed-cell expanding polyurethane foam sealant for lineal caulking applications. Air-moisture cure. Tack free in 20 minutes; fully cured in 12 hours. Paintable. Use for insulating and sealing around windows, doors, pipes, ducts and vents. Non-toxic when cured. Paint to protect from UV exposure. "R" value 4.7 (1" thickness). Foam contains fire retarding chemical and is U.L. Listed but not rated as a firestop product. Environmental concerns have led us to replace CFC's and HCFC's with hydrocarbon material in our one component foam products. See instructions on each product to ensure safe use and quality results.



| CATALOG NO.  | DESCRIPTION   | UOM | ORDER MULTIPLE |
|--------------|---|-----|----------------|
| <b>01714</b> | Foam Sealant – 12 oz. Can – Yields 275' (3/8" bead) | EA  | 12             |
| <b>01724</b> | Foam Sealant – 20 oz. Can – Yields 460' (3/8" bead) | EA  | 12             |



**SEALING COMPOUNDS, ADHESIVE cont'd**

**Foam Sealant – Two Component**

Two component closed-cell expanding polyurethane foam sealant for cavity filling, surface coating and insulation applications. Rapid chemical cure (Component A and Component B). Tack free in 2 minutes, fully cured in 20 minutes. Use for insulation repairs in refrigerated enclosures. Spray coat and insulate tanks, pipes, tubs and panels. Non-toxic when cured. Paint to protect from UV exposure. "R" value 5 (1" thickness). Kits include dispensing nozzles, hose and flow control mechanism. Foam contains fire retarding chemicals and is U.L. Listed but is not rated as a firestop product.



| CATALOG NO. | DESCRIPTION                                      | UOM | ORDER MULTIPLE |
|-------------|--|-----|----------------|
| 10012       | Foam – 2 Kit – 15 bd. ft. Kit – Yields 1 cu. ft. | EA  | 12             |

**Firestop Products for Class A Buildings**

U.L. Classified. Code Approved. Seal penetrations of plumbing, refrigeration and AC lines, ducts, vents and electrical cable through fire-rated floors, walls and ceilings. Easy-to-use, non-shrinking, non-toxic and permanently flexible. Blocks fire, gas, smoke, air and water migration. Use ceramic fiber filler together with putty or caulk for thick penetrations. Technical bulletins available.



| CATALOG NO. | DESCRIPTION                                   | UOM | ORDER MULTIPLE |
|-------------|---|-----|----------------|
| 16491       | Firestop Caulk – Red – 10.3 fl. oz. cartridge | EA  | 12             |

**Caulk Gun**

Caulk guns can be used to hold the sealant to seal duct work.



| CATALOG NO. | DESCRIPTION                    | UOM | ORDER MULTIPLE |
|-------------|--------------------------------|-----|----------------|
| 7-100       | Caulk Gun – Super Ratchet Type | EA  | 12             |
| 7-200       | Caulk Gun – Standard Duty      | EA  | 1              |

**High Temp Red Silicone Sealant**

A one part non-slumping paste that cures to a tough, rubbery solid at room temperature. Formulated to perform at temperatures ranging from -85°F to 500°F for continuous operation, and to 600°F for intermittent exposure. Tack free cure time – 15 minutes. Full cure time – 24 hours.



| CATALOG NO. | DESCRIPTION   | UOM | ORDER MULTIPLE |
|-------------|---|-----|----------------|
| 7-4300      | High Temp Red Silicone Sealant – 10.1 oz. Cartridge | EA  | 12             |

**Geocel Caulking Sealant**

Exceptional bonding and sealing caulk for interior and exterior applications involving seams, joints, ductwork, flashing and any similar use. Excellent adhesion to virtually any surface (metals, fiberglass, wood, concrete, brick and most plastics) even if moisture is present. Resealable, paintable, flexible. Will not crack, chip or peel. Specially formulated for the HVACR industry. Not available in California.



| CATALOG NO. | DESCRIPTION                                       | UOM | ORDER MULTIPLE |
|-------------|---|-----|----------------|
| 18001       | Clear Geocel Sealant – 10.3 oz. Cartridge         | EA  | 24             |
| 18002       | White Geocel Sealant – 10.3 oz. Cartridge         | EA  | 24             |
| 18003       | Aluminum/Gray Geocel Sealant – 10.3 oz. Cartridge | EA  | 24             |

**DiversiGum Sealing Compound**

Non-hardening. For plugging openings through foundations or around refrigeration tube entry.



| CATALOG NO. | DESCRIPTION  | UOM | ORDER MULTIPLE |
|-------------|--|-----|----------------|
| 6-202-1     | DiversiGum Sealing Compound – 1 lb. Slug               | EA  | 24             |
| 6-202-2     | DiversiGum Sealing Compound – 2 lb. Slug               | EA  | 20             |
| AG-25       | DiversiGum Sealing Compound – 3/8" x 25' Caulking Cord | EA  | 12             |

**Silicone Sealant**

Food grade 100% RTV Silicone Sealant. Can be used in applications for continuous use to 450°F. UV and water resistant. Long-term flexibility. Non-paintable. Available in 10.3 fl. oz. tube for use in standard caulk gun or in 3 fl. oz. squeeze tube.



| CATALOG NO. | DESCRIPTION                                     | UOM | ORDER MULTIPLE |
|-------------|---|-----|----------------|
| 7-4000      | Clear Silicone Sealant – 10.3 fl. oz. Tube      | EA  | 12             |
| 7-4001      | Clear Silicone Sealant – 3 fl. oz. Squeeze Tube | EA  | 48             |
| 7-4100      | White Silicone Sealant – 10.3 fl. oz. Tube      | EA  | 12             |
| 7-4101      | White Silicone Sealant – 3 fl. oz. Squeeze Tube | EA  | 48             |
| 7-4200      | Aluminum Silicone Sealant – 10.3 fl. oz. Tube   | EA  | 12             |
| 7-80045     | Pipe Joint Compound – 6 fl. oz. Tube            | EA  | 12             |

**SEALING COMPOUNDS, ADHESIVE cont'd**

**25 Year Acrylic Latex Painter's Caulk**

For both interior and exterior use. DiversiTech's 25 Year Acrylic Latex Painter's Caulk forms a tough, paintable resilient bond to all building material surfaces. Excellent resistance to water, weathering and moisture vapor.



| CATALOG NO.   | DESCRIPTION                                    | UOM | ORDER MULTIPLE |
|---------------|--|-----|----------------|
| <b>7-4500</b> | White Acrylic Latex Caulk – 10.1 oz. Cartridge | EA  | 12             |
| <b>7-4400</b> | Clear Acrylic Latex Caulk – 10.1 oz. Cartridge | EA  | 12             |

**Pro-Air Industrial Grade Spray Adhesive**

A clear, pressure sensitive aerosol adhesive with exceptional tack and shear strength characteristics. An excellent choice for most permanent adhesive applications: duct liner and wrap, sheet aluminum, fiberglass insulation board, and much more. The aerosol package offers a specially designed web spray pattern for even, controlled distribution. Flammability meets aerosol flame extension test requirements. Coverage is approximately 90-100 square feet per pound.

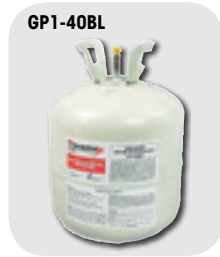

| CATALOG NO.     | DESCRIPTION   | UOM | ORDER MULTIPLE |
|-----------------|---|-----|----------------|
| <b>GP1-40BL</b> | Pro-Air Spray Adhesive – 38 lb. Disposable Cylinder | EA  | 1              |
| <b>GN-23H</b>   | Spray Gun   | EA  | 1              |

**Pro-Air Duct Sealant – UL 181 AM-BM Listed**

Water-based fiber-reinforced duct sealant/mastic formulated for indoor/outdoor use. Meets U.L. Class 1 rating and local codes while featuring long term flexibility and strength. Use on metal heating, ventilating, and A/C duct systems; as well as fiberglass duct board systems and flex duct systems. Recommended for use to 10" of water column pressure without the need for fiberglass mesh reinforcement.



| CATALOG NO.    | DESCRIPTION  | UOM | ORDER MULTIPLE |
|----------------|--|-----|----------------|
| <b>800-008</b> | Pro-Air Duct Sealant – 1/10 Gallon Tube – 10.5 oz. | EA  | 12             |
| <b>800-009</b> | Pro-Air Duct Sealant – 1 Gallon Pail               | EA  | 4              |

**Black Jack® Roof Cement**

Black Jack® All-Weather Roof Cement is an asphalt based patching compound designed to repair cracks, splits, seams and holes in roofing materials. It also works great in new construction and in setting flashings, drip edges and roofing material edges.

- Use in wet or dry conditions
- Seals flashings, and other roof projections
- Fiber reinforced
- Thick trowel grade



| CATALOG NO.  | DESCRIPTION                                      | UOM | ORDER MULTIPLE |
|--------------|--|-----|----------------|
| <b>RM-1G</b> | Black Jack All Weather Roof Cement – 1 gallon    | EA  | 6              |
| <b>RM-10</b> | Black Jack All Weather Roof Cement – 10 oz. tube | EA  | 12             |

**SHEET METAL SCREWS**

**Sheet Metal Screw Assortment Kit**

The 7 most popular sizes in one multi-compartmented, resealable, plastic container. Perfect for the toolbox. Contains:

- 7 x 1/2 Taper Point – 175 pieces
- 8 x 1/2 Drill Point – 100 pieces
- 8 x 1 Taper Point – 50 pieces
- 8 x 2 Taper Point – 40 pieces
- 8 x 1/2 Taper Point – 175 pieces
- 8 x 3/4 Taper Point – 60 pieces
- 8 x 1-1/2 Taper Point – 50 pieces
- 1/4" Nut Setter – 1 each



| CATALOG NO.     | DESCRIPTION                       | UOM | ORDER MULTIPLE |
|-----------------|-----------------------------------|-----|----------------|
| <b>5-SCR-AK</b> | Sheet Metal Screw Assortment Pack | EA  | 1              |

**Masonry Bit**

This bit is suitable for brick, tile, slate, cement, and cinder block. This bit is a nice addition to the toolbox.



| CATALOG NO.    | DESCRIPTION              | UOM | ORDER MULTIPLE |
|----------------|--------------------------|-----|----------------|
| <b>540-DB6</b> | Masonry Bit – 3/16" x 6" | EA  | 1              |

**Masonry Screw**

This product comes in a pack of 250 and is suitable for brick, tile, slate, cement, and cinder block. The screws are a nice addition to the toolbox.

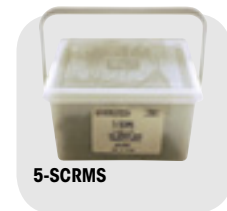

| CATALOG NO.    | DESCRIPTION                                | UOM | ORDER MULTIPLE |
|----------------|--|-----|----------------|
| <b>5-SCRMS</b> | Masonry Screw – 1/4" x 1-1/4", pack of 250 | PK  | 1              |

**Anchor Kit**

Plastic anchor kit for sheet rock applications. Kit includes 100 anchors, screws and 1 masonry bit.



| CATALOG NO.      | DESCRIPTION   | UOM | ORDER MULTIPLE |
|------------------|---|-----|----------------|
| <b>540-AK100</b> | Anchor size 1/4 x 1, Screw Size 10 x 1-1/4 HWH Head Size 5/16 hex | EA  | 1              |

**SHEET METAL SCREWS cont'd**

**Sheet Metal Screws  
– Taper Point**

Hex washer slotted head. Burr-free. Full 1/4" head will not strip out of hex driver opening. Heat treated tapered point will not break or "walk". Packaged in resealable plastic cartons.

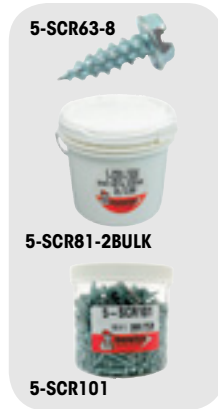

**Sheet Metal Screws  
– Drill Point**

Self-drilling, self-tapping. Hex washer head. Produces the optimum hole size, resulting in a tighter fit. Made from special heat treated steel for extra strength. Packaged in resealable plastic cartons.



| CATALOG NO.            | DESCRIPTION  | UOM | ORDER MULTIPLE |
|------------------------|--|-----|----------------|
| <b>5-SCR63-8</b>       | 6 x 3/8 Taper Point, pack of 1,000                       | PK  | 1              |
| <b>5-SCR63-8BULK</b>   | 6 x 3/8 Taper Point – Bulk, pack of 20,000               | PK  | 1              |
| <b>5-SCR71-2</b>       | 7 x 1/2 Taper Point, pack of 1,000                       | PK  | 1              |
| <b>5-SCR71-2BULK</b>   | 7 x 1/2 Taper Point – Bulk, pack of 15,000               | PK  | 1              |
| <b>5-SCR81-2</b>       | 8 x 1/2 Taper Point, pack of 1,000                       | PK  | 1              |
| <b>5-SCR81-25M</b>     | 8 x 1/2 Taper Point, pack of 5,000                       | PK  | 1              |
| <b>5-SCR81-2BULK</b>   | 8 x 1/2 Taper Point – Bulk, pack of 12,000               | PK  | 1              |
| <b>5-SCR83-4</b>       | 8 x 3/4 Taper Point, pack of 1,000                       | PK  | 1              |
| <b>5-SCR83-4BULK</b>   | 8 x 3/4 Taper Point – Bulk, pack of 10,000               | PK  | 1              |
| <b>5-SCR81</b>         | 8 x 1 Taper Point, pack of 500                           | PK  | 1              |
| <b>5-SCR81BULK</b>     | 8 x 1 Taper Point – Bulk, pack of 7,500                  | PK  | 1              |
| <b>5-SCR81-12-100</b>  | 8 x 1-1/2 Taper Point, pack of 100                       | PK  | 1              |
| <b>5-SCR81-12W</b>     | 8 x 1-1/2 Taper Point w/White Head, pack of 250          | PK  | 1              |
| <b>5-SCR81-12WTBUL</b> | 8 x 1-1/2 Taper Point w/White Head – Bulk, pack of 5,000 | PK  | 1              |
| <b>5-SCR81-12BULK</b>  | 8 x 1-1/2 Taper Point – Bulk, pack of 5,000              | PK  | 1              |
| <b>5-SCR82-100</b>     | 8 x 2 Taper Point, pack of 100                           | PK  | 1              |
| <b>5-SCR82</b>         | 8 x 2 Taper Point, pack of 350                           | PK  | 1              |
| <b>5-SCR82W</b>        | 8 x 2 Taper Point w/White Head, pack of 250              | PK  | 1              |
| <b>5-SCR82BULK</b>     | 8 x 2 Taper Point – Bulk, pack of 3,000                  | PK  | 1              |
| <b>5-SCR101-2BULK</b>  | 10 x 1/2 Taper Point – Bulk, pack of 14,000              | PK  | 1              |
| <b>5-SCR103-4</b>      | 10 x 3/4 Taper Point, pack of 1,000                      | PK  | 1              |
| <b>5-SCR103-4BULK</b>  | 10 x 3/4 Taper Point – Bulk, pack of 10,000              | PK  | 1              |
| <b>5-SCR101</b>        | 10 x 1 Taper Point, pack of 500                          | PK  | 1              |
| <b>5-SCR101BULK</b>    | 10 x 1 Taper Point – Bulk, pack of 7,000                 | PK  | 1              |

| CATALOG NO.              | DESCRIPTION                                  | HEAD SIZE | UOM | ORDER MULTIPLE |
|--------------------------|--|-----------|-----|----------------|
| <b>5-SCR61-2DP</b>       | 6 x 1/2 Drill Point, pack of 1,000           | 1/4"      | PK  | 1              |
| <b>5-SCR61-2DPBULK</b>   | 6 x 1/2 Drill Point – Bulk, pack of 15,000   | 1/4"      | PK  | 1              |
| <b>5-SCR81-2DP</b>       | 8 x 1/2 Drill Point, pack of 1,000           | 1/4"      | PK  | 1              |
| <b>5-SCR81-2DPBULK</b>   | 8 x 1/2 Drill Point – Bulk, pack of 10,000   | 1/4"      | PK  | 1              |
| <b>5-SCR83-4DP</b>       | 8 x 3/4 Drill Point, pack of 500             | 1/4"      | PK  | 1              |
| <b>5-SCR83-4DPBULK</b>   | 8 x 3/4 Drill Point – Bulk, pack of 10,000   | 1/4"      | PK  | 1              |
| <b>5-SCR81DP</b>         | 8 x 1 Drill Point, pack of 500               | 1/4"      | PK  | 1              |
| <b>5-SCR81DPBULK</b>     | 8 x 1 Drill Point – Bulk, pack of 7,500      | 1/4"      | PK  | 1              |
| <b>5-SCR101-2DP</b>      | 10 x 1/2 Drill Point, pack of 500            | 5/16"     | PK  | 1              |
| <b>5-SCR101-2DPBULK</b>  | 10 x 1/2 Drill Point – Bulk, pack of 10,000  | 5/16"     | PK  | 1              |
| <b>5-SCR103-4DP</b>      | 10 x 3/4 Drill Point, pack of 500            | 5/16"     | PK  | 1              |
| <b>5-SCR103-4DPBULK</b>  | 10 x 3/4 Drill Point – Bulk, pack of 5,000   | 5/16"     | PK  | 1              |
| <b>5-SCR101DP</b>        | 10 x 1 Drill Point, pack of 500              | 5/16"     | PK  | 1              |
| <b>5-SCR101DPBULK</b>    | 10 x 1 Drill Point – Bulk, pack of 5,000     | 5/16"     | PK  | 1              |
| <b>5-SCR101-12DP</b>     | 10 x 1-1/2 Drill Point, pack of 250          | 5/16"     | PK  | 1              |
| <b>5-SCR101-12DPBULK</b> | 10 x 1-1/2 Drill Point – Bulk, pack of 3,500 | 5/16"     | PK  | 1              |
| <b>5-SCR102DP</b>        | 10 x 2 Drill Point, pack of 350              | 5/16"     | PK  | 1              |
| <b>5-SCR102DPBULK</b>    | 10 x 2 Drill Point – Bulk, pack of 2,500     | 5/16"     | PK  | 1              |

**WASP, HORNET, AND YELLOW JACKET KILLERS**

**Sting Less Wasp & Hornet Killer**

Kills wasps, hornets and yellow jackets. Very fast-acting when insects are hit directly. Allow approximately 24 hours for those that were not directly hit. This container delivers a 20-foot jet blast to knock down the insects and allow for the user to remain at a safe distance.



| CATALOG NO.   | DESCRIPTION                                     | UOM | ORDER MULTIPLE |
|---------------|---|-----|----------------|
| <b>436-20</b> | Sting Less Wasp & Hornet Spray – 14 oz. Aerosol | EA  | 12             |

**Wasp & Hornet Killer by ENFORCER**

Enforcer's Wasp & Hornet Killer shoots a 20-foot jet blast for instant knockdown of wasps, hornets, and yellow jackets. Enforcer's Wasp & Yellow Jacket Foam is a 20-foot blast of blanketing foam that plugs yellow jacket holes and clings to wasp and hornet nests, preventing their escape.



| CATALOG NO.    | DESCRIPTION   | UOM | ORDER MULTIPLE |
|----------------|---|-----|----------------|
| <b>8-WH16</b>  | Enforcer Wasp & Hornet Killer – 16 oz. Aerosol      | EA  | 12             |
| <b>8-FWH16</b> | Enforcer Wasp & Yellow Jacket Foam – 16 oz. Aerosol | EA  | 12             |





|   |         |
|---|---------|
| Anchors.....                                | 108-109 |
| Boxes, Rings, and Covers.....               | 110-111 |
| Bulbs .....                                 | 111     |
| Cable Connectors .....                      | 112     |
| Cable Ties and Accessories .....            | 113     |
| Conduit Fittings .....                      | 114     |
| General Tools.....                          | 115     |
| High Temperature Solderless Terminals ..... | 106     |
| Nuts and Bolts.....                         | 115-116 |
| Plastic Anchor Kits .....                   | 109     |
| Power Cords and Work Lights .....           | 117     |
| Screws .....                                | 117     |
| Slip-On Solderless Terminals .....          | 102-103 |
| Special Purpose Solderless Terminals .....  | 103-104 |
| Specialty Fasteners.....                    | 118     |
| Specialty Fittings .....                    | 119     |
| Standard Solderless Terminals.....          | 104-105 |
| Storage Containers .....                    | 119     |
| Tapes .....                                 | 119     |
| Terminal Kits .....                         | 107     |
| Testers, Leads, Clips, Fuses .....          | 120     |
| Wire.....                                   | 120-121 |
| Wiring Devices .....                        | 121-126 |

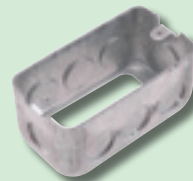
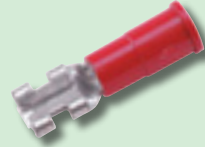

# How to sell DEVCO products

*DEVCO merchandising displays are an easy and attractive way to showcase a variety of DEVCO products in your store. Offered in three different versions, each display rack includes everything you need to create extra sales for your business.*

## Easy to Display

DEVCO provides turnkey merchandising solutions for wholesale distribution. Attractive, easy to set-up merchandising displays provide a great way to highlight DEVCO products and make it easy for customers to find what they need. The point of sale display merchandises the products, enabling the distributor to add additional sales.

The products merchandised on the carousel are impulse buy items. The items are packed so they cost the contractor only a few dollars, and most are less than \$10 each.

## Easy to Profit

DEVCO displays provide a typical distributor branch with easy add-on sales that build profits. Each display can generate significant sales and margins for the store while providing contractors with the parts they need to finish the job. These self-service displays are a great way to increase revenue with minimal effort.

## The Perfect Plan

Each DEVCO Merchandising display comes with a complete plan-o-gram to make merchandising it simple and fast. And there are three different versions available so you can choose the display that's right for your business and customers.

And when you purchase the DEVCO products to fill it up, the merchandising rack is **loaned free of charge.**

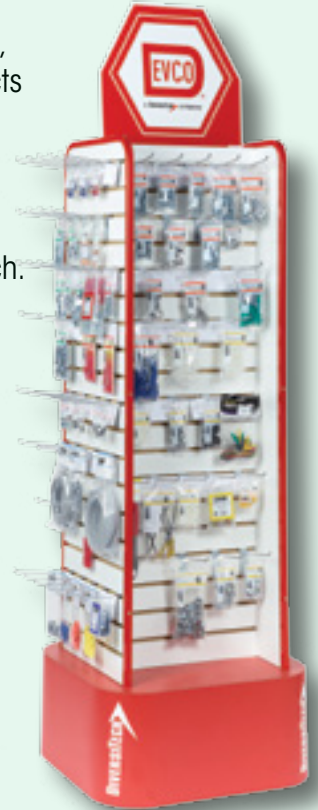

| Display Rack      | Featured Products   |
|-------------------|---|
| <b>EZC</b>        | Solderless terminals, ground connectors, fasteners, anchor kits, cable ties, washers, hex nuts, cable clamps, sheet metal screws and hose clamps                                      |
| <b>Electrical</b> | Ground adaptors, outlets, boxes, bushings, cable connectors, extension rings, indicator lights, plugs and connectors, receptacles, reducing washers, toggle switches and hook up wire |
| <b>Combo</b>      | Solderless terminals, insulated rings, ground adaptors, covers, reducing washers, plugs and connectors, hook up wire, fasteners, hex nuts and self drilling screws                    |



PLAN-O-GRAM FOR DEVCO ELEC RACK (MKT-POP-DEVELEC)

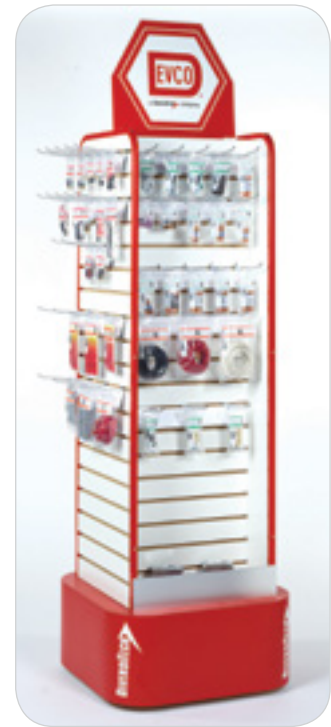
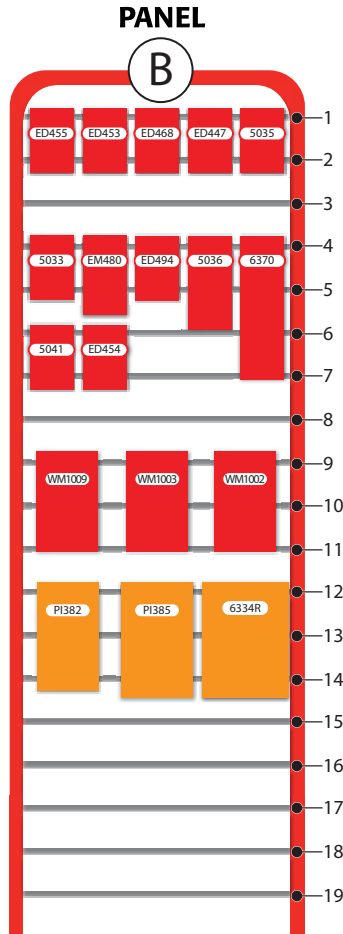
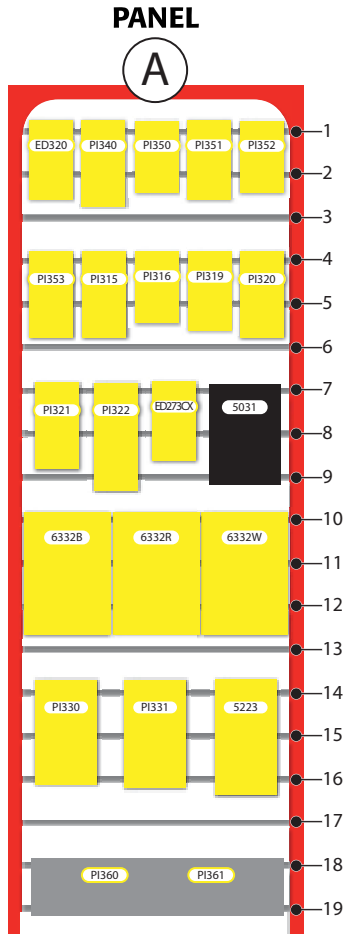

MKT-POP-DEVELEC

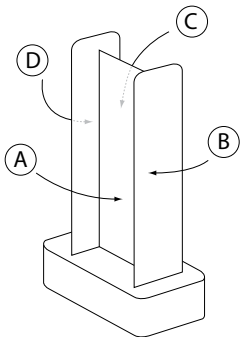
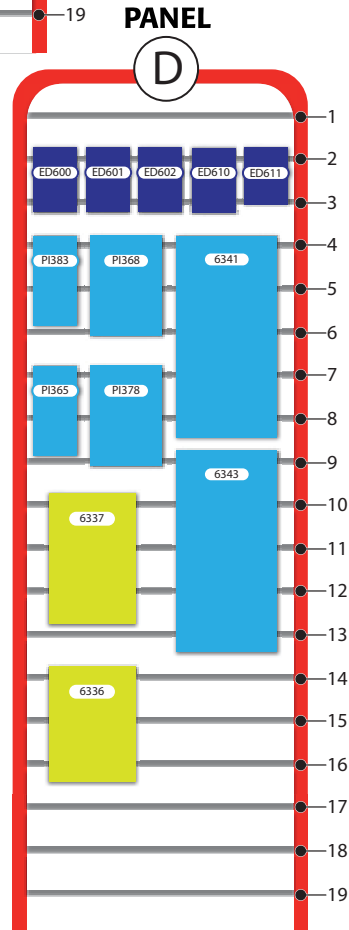
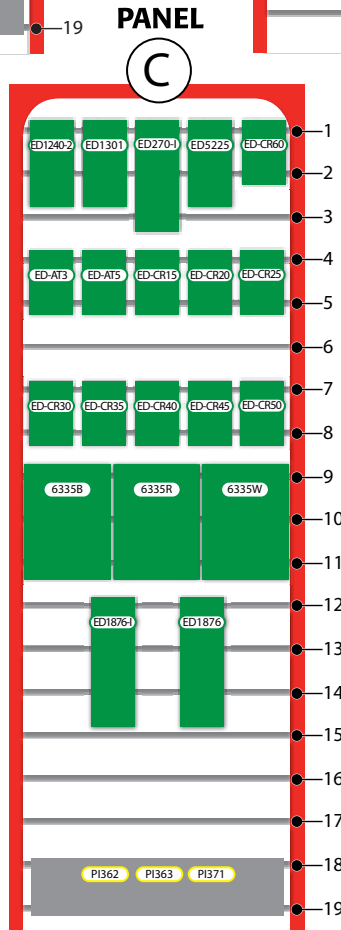

MKT-POP-DEVELEC  
Merchandising Rack  
72" x 22" x 20.5"

NOTE: Item numbers in RED indicate Made in the U.S.A.





# PLAN-O-GRAM FOR DEVCO EZC RACK (MKT-POP-DEVEZC)

DEVCO

## PANEL A

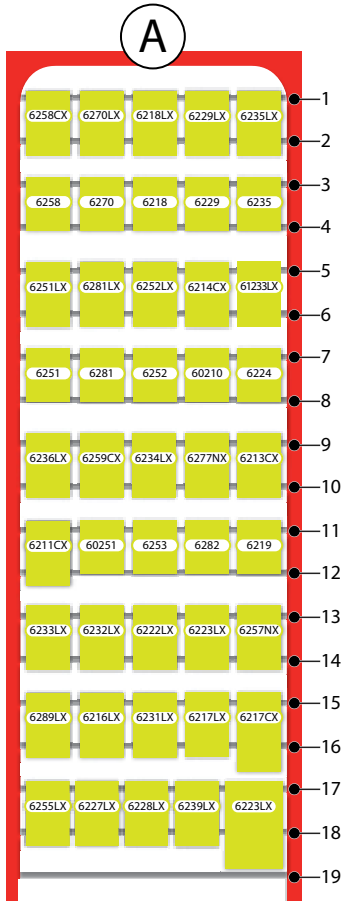

## PANEL B

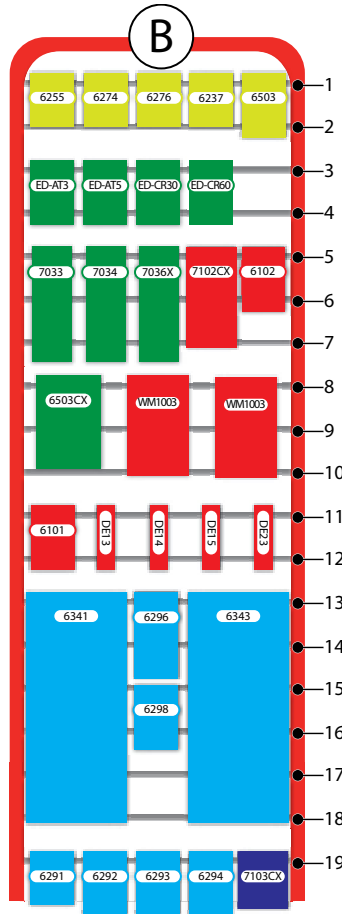

MKT-POP-DEVEZC

## PANEL C

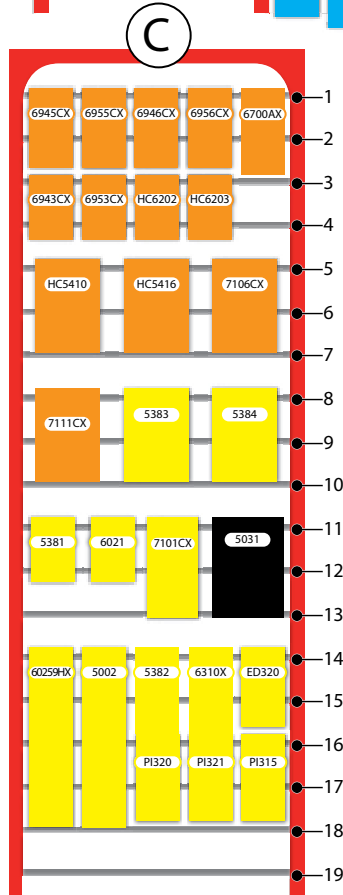

## PANEL D

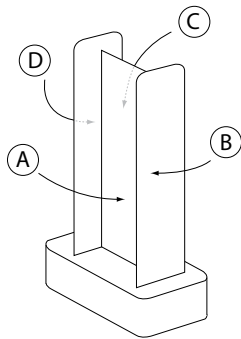
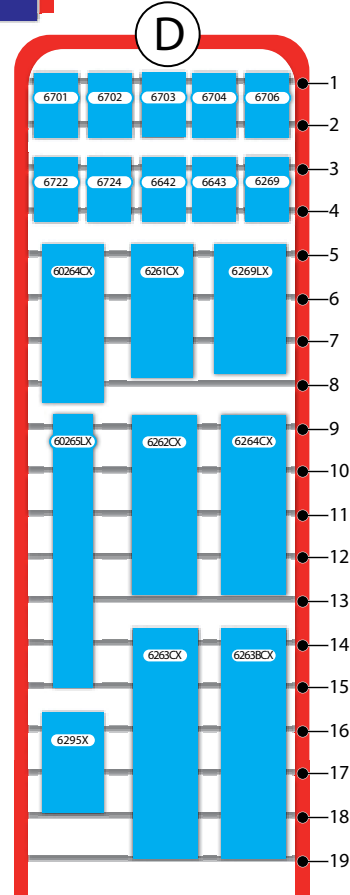

MKT-POP-DEVEZC  
Merchandising Rack  
72" x 22" x 20.5"



PLAN-O-GRAM FOR DEVCO COMBO RACK (MKT-POP-DEVCOMBO)

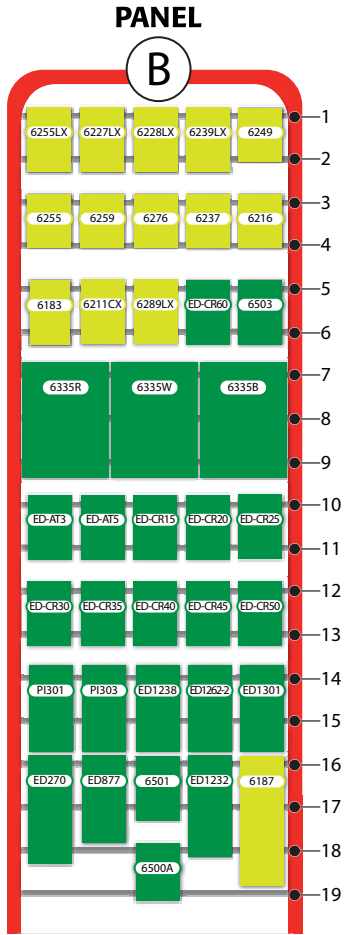
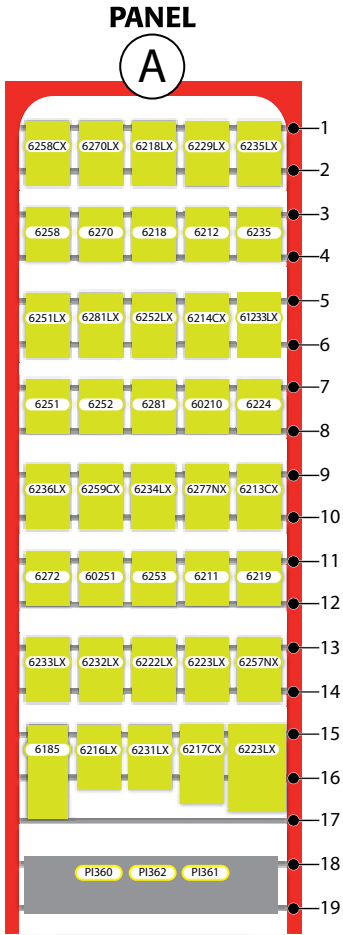

MKT-POP-DEVCOMBO

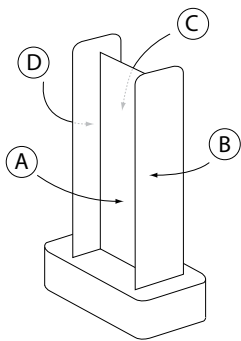
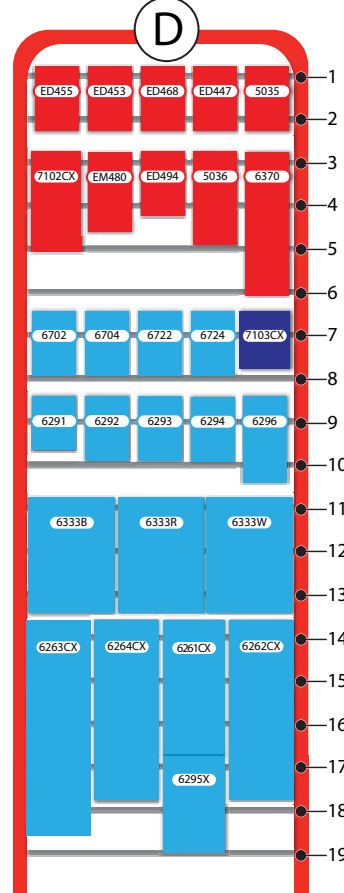
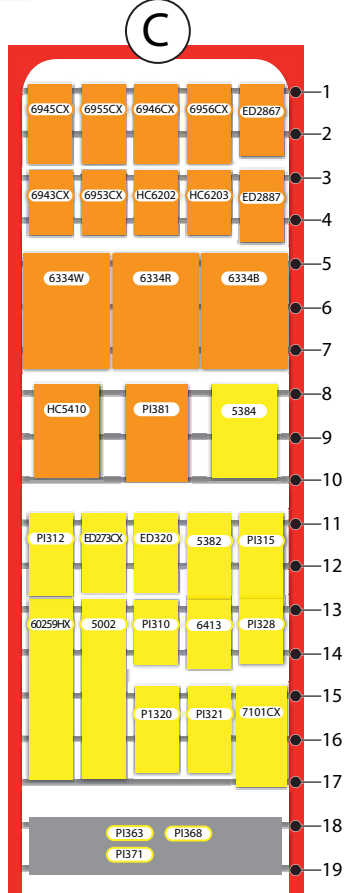

MKT-POP-DEVCOMBO Merchandising Rack 72" x 22" x 20.5"

NOTE: Item numbers in RED indicate Made in the U.S.A.



## DEVCO RACKS MASTER ITEM LIST (BY RACK)

This DEVCO product list includes any DEVCO item that is part of the plan-o-gram display for either the EZC, ELEC or COMBO versions of the DEVCO rack. This cross reference indicates on which display rack each item should be placed.

| ITEM # | ITEM DESCRIPTION  | ELEC | EZC | COMBO | ITEM #  | ITEM DESCRIPTION  | ELEC | EZC | COMBO |
|--------|---|------|-----|-------|---------|---|------|-----|-------|
| 5002   | Crimp Tool w/ Cutter & Stripper Ins.                          |      | X   | X     | 6703    | Flat Washer 5/16in Uss zn Pltd.                         |      | X   |       |
| 5031   | Test Leads (ins. Alligator clips) Low Voltage 22in 8pcs       | X    | X   |       | 6704    | Flat Washer 3/8in Uss zn Pltd.                          |      | X   | X     |
| 5033   | Alligator Clips (steel) 2in long for probes .075in-.08in      | X    |     |       | 6706    | Flat Washer 1/2in Uss zn Pltd.                          |      | X   |       |
| 5035   | Alligator Clips (copper) B&R Ins 2in long                     | X    |     | X     | 6722    | Fender Washer 1/4in zn Pltd.                            |      | X   | X     |
| 5036   | Test Clip (steel 20A) B&R Insulators 2-7/16in long            | X    |     | X     | 6724    | Fender Washer 3/8in zn Pltd.                            |      | X   | X     |
| 5041   | Test Leads Low Voltage Hook Ty22ga 36in red & black           | X    |     |       | 7033    | Toggle Bolt w/wing 3/16inx4inzn Pltd.                   |      | X   |       |
| 5223   | Triple Outlet 2 Pole 3 Wire 15A-125V Polarized plastic        | X    |     |       | 7034    | Toggle Bolt w/wing 1/4inx4in zn Pltd.                   |      | X   |       |
| 5381   | Nylon Cable Clamp 1/8in I.D.                                  |      | X   |       | 60210   | Tab Ad. Ins. .250 16-14 multi stack male & female       |      | X   | X     |
| 5382   | Nylon Cable Clamp 1/4in I.D.                                  |      | X   | X     | 60251   | Slip-On F 12-10 Non-Ins. .250                           |      | X   | X     |
| 5383   | Nylon Cable Clamp 3/8in I.D.                                  |      | X   |       | 60259HX | Comp. Lead Kit 12in 10ga wire                           |      | X   | X     |
| 5384   | Nylon Cable Clamp 1/2in I.D.                                  |      | X   | X     | 60264CX | Cable Tie 6in w/ #8 Hole 30# 1-3/8in B. Dia nat 100/PK  |      | X   |       |
| 6021   | Rnd Head Screw (#6 8 10-32 x 1/2in 1-1/2in) zn Pltd.          |      | X   |       | 60265LX | Cable Tie 14in 50# 4in B. Dia natural 50 pcs            |      | X   |       |
| 6101   | Motor Shaft Keys (1/8in 3/16in 1/4in 3/16in x 1/4in) zn Pltd. |      | X   |       | 61233LX | Slip-on M & F 16-14 .250 Full Ins Nylon 50 pcs          |      | X   | X     |
| 6102   | Motor Shaft Keys (1/4insq 5/16insq 3/8insq) zn Pltd.          |      | X   |       | 6211CX  | Tab Ad. S. F Dbl M Non-Ins. 100 pcs                     |      | X   | X     |
| 6183   | Terminal Block 20A-250V 6 pos                                 |      |     | X     | 6213CX  | Flag F QD 16-14 Non-Ins. .250 100 pcs                   |      | X   | X     |
| 6185   | Terminal Block 20A-250V 10 pos                                |      |     | X     | 6214CX  | Slip-on F 16-14 Non-Ins. .250 100 pcs                   |      | X   | X     |
| 6187   | Terminal Block 20A-250V 14 pos                                |      |     | X     | 6216LX  | Ring 16-14 Ins. #10 Stud 50 pcs                         |      | X   | X     |
| 6211   | Tab Ad. S. F Dbl M .250 Non-Ins.                              |      |     | X     | 6217CX  | Butt Conn. 16-14 Ins. 100 pcs                           |      | X   | X     |
| 6212   | Dbl. M. Tab Ad. S. F . Non-Ins.                               |      |     | X     | 6217LX  | Butt Conn. 16-14 Ins. 50 pcs                            |      | X   | X     |
| 6216   | Ring 16-14 Ins. #10 Stud                                      |      |     | X     | 6218LX  | Slip-on F 16-14 Ins. .250 50 pcs                        |      | X   | X     |
| 6218   | Slip-on F 16-14 Ins. .250                                     |      | X   | X     | 6222LX  | Dead End Conn. 22-14 Fully Ins. 50 pcs                  |      | X   | X     |
| 6219   | Slip-on M 16-14 Ins. .250                                     |      | X   | X     | 6223LX  | Dead End Conn. 18-10 Fully Ins. 50 pcs                  |      | X   | X     |
| 6224   | Flag F QD 12-10 Non-Ins. .250                                 |      | X   | X     | 6227LX  | Spade 16-14 Ins. #8 Stud                                |      | X   | X     |
| 6229   | Slip-on F 16-14 Full Ins. .250                                |      | X   |       | 6228LX  | Spade 16-14 Ins. #10 Stud 50 pcs                        |      | X   | X     |
| 6235   | Slip-on F 22-18 Ins. .250                                     |      | X   | X     | 6229LX  | Slip-on F 16-14 Full Ins. .250                          |      | X   | X     |
| 6237   | Spade 22-18 Ins. #8 Stud                                      |      | X   | X     | 6231LX  | Butt Conn. 12-10 Ins. 50 pcs                            |      | X   | X     |
| 6249   | M Tab 1 pair bent 90 Non-Ins.                                 |      |     | X     | 6232LX  | Butt Conn. 22-18 Ins. 50 pcs                            |      | X   | X     |
| 6251   | Slip-on F 12-10 Ins. .250                                     |      | X   | X     | 6233LX  | Slip-on F 16-14 .250 Full Ins. Nylon 50 pcs             |      | X   | X     |
| 6252   | Ring 12-10 Ins. #10 Stud                                      |      | X   | X     | 6234LX  | Slip-on M 16-14 .250 Full Ins. Nylon 50 pcs             |      | X   | X     |
| 6253   | Ring 12-10 Ins. 1/4in Stud                                    |      | X   | X     | 6235LX  | Slip-on F 22-18 Ins. .250 50 pcs                        |      | X   | X     |
| 6255   | Spade 12-10 Ins. #10 Stud                                     |      | X   | X     | 6236LX  | Ring 22-18 Ins. #8 Stud 50 pcs                          |      | X   | X     |
| 6258   | Comp. Flag F. 16-14 Non-Ins. .250                             |      | X   | X     | 6239LX  | Spr. Spade 16-14 Ins. #8 Stud                           |      | X   | X     |
| 6259   | Comp. Flag F. 12-10 Non-Ins. .250                             |      |     | X     | 6251LX  | Slip-on F 12-10 Ins. .250                               |      | X   | X     |
| 6269   | Cable Tie Mount   |      | X   |       | 6252LX  | Ring 12-10 Ins. #10 Stud                                |      | X   | X     |
| 6270   | Comp. Flag F. 12-8 Non-Ins. .250                              |      | X   | X     | 6255LX  | Spade 12-10 Ins. #10 Stud 50 pcs                        |      | X   | X     |
| 6272   | Ring 16-14 Ins. #6 Stud                                       |      |     | X     | 6257NX  | Ring #8 Ins. 1/4in Stud 25 pc                           |      | X   | X     |
| 6274   | Spade 16-14 Ins. #6 Stud                                      |      | X   |       | 6258CX  | Comp. Flag F. 16-14 Non-Ins. .250 100 pcs               |      | X   | X     |
| 6276   | Spr. Spade 16-14 Ins. #6 Stud                                 |      | X   | X     | 6259CX  | Comp. Flag F. 12-10 Non-Ins. .250 100 pcs               |      | X   | X     |
| 6281   | Slip-on F 16-14 Ins. .187                                     |      | X   | X     | 6261CX  | Cable Tie 6in 18# 1-3/8in B. Dia natural 100 pcs        |      | X   | X     |
| 6282   | Slip-on F 22-18 Ins. .187                                     |      | X   |       | 6262CX  | Cable Tie 7-1/2in 50# 1-3/4in B. Dia natural 100 pcs    |      | X   | X     |
| 6291   | Wire Connector Mini-Gray                                      |      | X   | X     | 6263CX  | Cable Tie 11in 50# 3in B. Dia natural 100 pcs           |      | X   | X     |
| 6292   | Wire Connector Tiny-Blue                                      |      | X   | X     | 6263BCX | Cable Tie 11in 50# 3in B. Dia black 100 pcs             |      | X   |       |
| 6293   | Wire Connector Small-Orange                                   |      | X   | X     | 6264CX  | Cable Tie 7in w/ #10 Hole 50# 1-3/4in B. Dia nat 100/PK |      | X   | X     |
| 6294   | Wire Connector Medium-Yellow                                  |      | X   | X     | 6269LX  | Cable Tie Mount 50 pcs                                  |      | X   |       |
| 6296   | Wire Connector Large-Red                                      |      | X   | X     | 6270LX  | Comp. Flag F. 12-8 Non-Ins. .250 50 pcs                 |      | X   | X     |
| 6298   | Wire Connector XLarge-Gray                                    |      | X   |       | 6277NX  | Flag F QD 16-14 .250 Fully Ins. Nylon 25 pcs            |      | X   | X     |
| 6336   | Thermostat Wire 3 Conduct. 40 ft.                             | X    |     |       | 6281LX  | Slip-on F 16-14 Ins. .187 50 pcs                        |      | X   | X     |
| 6337   | Thermostat Wire 5 Conduct. 40 ft.                             | X    |     |       | 6289LX  | Bullet Plug & Rec. 16-14 Ins. 50 pcs                    |      | X   | X     |
| 6341   | SJTO Service Cord 16 GA 20 ft.                                | X    | X   |       | 6295X   | Assorted Wire Connectors                                |      | X   | X     |
| 6343   | SJTO Service Cord 14 GA 20 ft.                                | X    | X   |       | 6310X   | Grease Fitting Assortment box                           |      | X   |       |
| 6370   | Heat Shrink Tubing Assort. B&W 1/8in & 1/4in supplied 6in     | X    |     | X     | 6332B   | Hook-up Wire 16ga blk. 48 ft                            | X    |     |       |
| 6413   | Fin. Hex Nut 1/4in-20 zn Pltd.                                |      |     | X     | 6332R   | Hook-up Wire 16ga red. 48 ft                            | X    |     |       |
| 6501   | Fin. Hex Nut 1/4in-20 zn Pltd.                                |      | X   | X     | 6332W   | Hook-up Wire 16ga wht. 48 ft                            | X    |     |       |
| 6503   | Fin. Hex Nut 3/8in-16 zn Pltd.                                |      | X   | X     | 6333B   | Hook-up Wire 14ga blk. 48 ft                            |      |     | X     |
| 6642   | HH Cap Screw 3/8in-16 x 1in                                   |      | X   |       | 6333G   | Hook-up Wire 14ga gm. 48 ft                             |      |     |       |
| 6643   | HH Cap Screw 3/8in-16 x 1 1/2in                               |      | X   |       | 6333R   | Hook-up Wire 14ga red. 48 ft                            |      |     | X     |
| 6701   | Flat Washer 3/16in Uss zn Pltd.                               |      | X   |       | 6333W   | Hook-up Wire 14ga wht. 48 ft                            |      |     | X     |
| 6702   | Flat Washer 1/4in Uss zn Pltd.                                |      | X   | X     | 6334B   | Hook-up Wire 12ga blk. 48 ft                            |      |     | X     |

continued





DEVCO RACKS MASTER ITEM LIST (BY RACK) cont'd

| ITEM #   | ITEM DESCRIPTION  | ELEC | EZC | COMBO |
|----------|---|------|-----|-------|
| 6334R    | Hook-up Wire 12ga red 48 ft                                   | X    |     | X     |
| 6334W    | Hook-up Wire 12ga wht. 48 ft                                  |      |     | X     |
| 6335B    | Hook-up Wire 10ga blk. 48 ft                                  | X    |     | X     |
| 6335R    | Hook-up Wire 10ga red 48 ft                                   | X    |     | X     |
| 6335W    | Hook-up Wire 10ga wht. 48 ft                                  | X    |     | X     |
| 6500A    | Asst Mach. Screw Hex Nuts 6-32 8-32 10-32 zn Pltd.            |      |     | X     |
| 6503CX   | Fin. Hex Nut 3/8in-16 zn Pltd. 100 pcs                        |      | X   |       |
| 6700AX   | Flat Washer Assortment Pack 3/16 1/4 5/16 3/8 1/2 5/8 inch    |      | X   |       |
| 6943CX   | Self Drilling Screw #8x1/2in 1/4in Hex Head zn Pltd. 100/PK   |      | X   | X     |
| 6945CX   | Self Drilling Screw #8x3/4in 1/4in Hex Head zn Pltd. 100/PK   |      | X   | X     |
| 6946CX   | Self Drilling Screw #8x1in 1/4in Hex Head zn Pltd. 100/PK     |      | X   | X     |
| 6953CX   | Drill Tip Screw #10x1/2in 5/16in Hex Head 100/PK              |      | X   | X     |
| 6955CX   | Drill Tip Screw #10x3/4in 5/16in Hex Head 100/PK              |      | X   | X     |
| 6956CX   | Self Drilling Screw #10x1in 5/16in Hex Head zn Pltd. 100/PK   |      | X   | X     |
| 7036X    | Toggle Bolt w/wing 3/8inx4in zn Pltd.                         |      | X   |       |
| 7101CX   | Anch Kit Yellow #8x1in w 3/16in bit 100 s + 100 a             |      | X   | X     |
| 7102CX   | Anch Kit Red #10x1-1/4in w 1/4in bit 100 s + 100 a            |      | X   | X     |
| 7103CX   | Anch Kit Blue #4x3/4in w 5/32in bit 100 s + 100 a             |      | X   | X     |
| 7106CX   | Plug Anchor Kit Green #10x1in 1/4in bit 100 s +100 a bag      |      | X   |       |
| 7111CX   | Plug Anchor Kit Blue #14x1in w 5/16in bit 100 s +100 a bag    |      | X   |       |
| DE13     | Magnetic Hex Chuck 1/4in x 1-3/4in                            |      | X   |       |
| DE14     | Magnetic Hex Chuck 5/16in x 1-3/4in                           |      | X   |       |
| DE15     | Magnetic Hex Chuck 3/8in x 1-7/8 in                           |      | X   |       |
| DE23     | Magnetic Hex Chuck 1/4in x 2-9/16 in                          |      | X   |       |
| ED1232   | Toggle Switch D.P. 30A-120/277V brown                         |      |     | X     |
| ED1238   | Toggle Switch S.P. 20A-120/277V brown                         |      |     | X     |
| ED1240-2 | Toggle Switch S.P. 15A-120/277V brown                         | X    |     |       |
| ED1262-2 | Toggle Switch D.P. 15A-120/277V brown                         |      |     | X     |
| ED1301   | Toggle Switch S.P. 15A-120V brown                             | X    |     | X     |
| ED1876   | Single Receptacle 20A-250V 2 pl. 3 wr. brown                  | X    |     |       |
| ED1876-I | Single Receptacle 20A-250V 2 pl. 3 wr. ivory                  | X    |     |       |
| ED270    | Duplex Receptacle 15A-125V 2 pl. 3 wr. brown                  |      |     | X     |
| ED270-I  | Duplex Receptacle 15A-125V 2 pl. 3 wr. ivory                  | X    |     |       |
| ED273CX  | Electrical Staple insul size #5 5/8in x 1/4in 100/PK          | X    |     | X     |
| ED2867   | Armored Plug 15A-125V 2pl.3 wr. vinyl enclosed                |      |     | X     |
| ED2887   | Armored Connector 15A-125V 2pl. 3 wr. vinyl enclosed          |      |     | X     |
| ED320    | Vinyl Grommet Asst. contains: ED300 thru ED316                | X    | X   | X     |
| ED447    | Bat Handle Switch metal SPST on-off 10A/277V-20A/125V AC      | X    |     | X     |
| ED453    | Bat Handle Switch metal DPDT on-on 10A/277V-20A/125V AC       | X    |     | X     |
| ED454    | Bat Handle Switch metal SPDT on-on 10A/277V-20A/125V AC       | X    |     |       |
| ED455    | Bat Handle Switch metal DPST on-off 10A/277V-20A/125V AC      | X    |     | X     |
| ED468    | Bat Handle Switch metal SPDT on-off-on 10A/277V-20A/125V      | X    |     | X     |
| ED494    | Bat Handle Switch metal DPDT on-off-on 10A/277V-20A/125V      | X    |     | X     |
| ED5225   | Switch & Receptacle 2p 3w (sw:15A-120VAC& rec:15A-125VAC) brn | X    |     |       |
| ED600    | Indicator Light 28V red PC lens incandescent bulb             | X    |     |       |
| ED601    | Indicator Light 28V green PC lens incandescent bulb           | X    |     |       |
| ED602    | Indicator Light 28V amber PC lens incandescent bulb           | X    |     |       |
| ED610    | Indicator Light 105-125V AC red nylon lens neon bulb          | X    |     |       |
| ED611    | Indicator Light 105-125V AC gm PC lensneon blb-G2B Imp&resstr | X    |     |       |
| ED877    | Duplex Receptacle 20A-125V 2 pl. 3 wr. brown                  |      |     | X     |
| EM480    | In-Line Fuse Holder 1-1/4 x 1/4in fuses to 20A/32V 14ga       | X    |     | X     |
| ED-AT3   | Blade Fuses - 3 Amp - Purple, Pack of 10                      | X    | X   | X     |
| ED-AT5   | Blade Fuses - 5 Amp - Tan, Pack of 10                         | X    | X   | X     |
| ED-CR15  | Dual Element Fuses - 15 Amp, Pack of 2                        | X    |     | X     |
| ED-CR20  | Dual Element Fuses - 20 Amp, Pack of 2                        | X    |     | X     |
| ED-CR25  | Dual Element Fuses - 25 Amp, Pack of 2                        | X    |     | X     |
| ED-CR30  | Dual Element Fuses - 30 Amp, Pack of 2                        | X    | X   | X     |
| ED-CR35  | Dual Element Fuses - 35 Amp, Pack of 2                        | X    |     | X     |
| ED-CR40  | Dual Element Fuses - 40 Amp, Pack of 2                        | X    |     | X     |
| ED-CR45  | Dual Element Fuses - 45 Amp, Pack of 2                        | X    |     | X     |

| ITEM #  | ITEM DESCRIPTION   | ELEC | EZC | COMBO |
|---------|--|------|-----|-------|
| ED-CR50 | Dual Element Fuses - 50 Amp, Pack of 2                                 | X    |     | X     |
| ED-CR60 | Dual Element Fuses - 60 Amp, Pack of 2                                 | X    | X   | X     |
| HC5410  | Hose Clamp 9/16in-1-1/8in SSHousing&band st hex screw                  |      | X   | X     |
| HC5416  | Hose Clamp 3/4in-1-1/2in SSHousing&band st hex screw                   |      | X   |       |
| HC6202  | Hose Clamp 1/4in-5/8in SS housing&band st hex screw                    |      | X   | X     |
| HC6203  | Hose Clamp 5/16in-7/8in SSHousing&band st hex screw                    |      | X   | X     |
| PI301   | Cond Nip 1/2in offset zn w pltd. stl locknuts insul. bushings          |      |     | X     |
| PI303   | Cond Nip 1/2in strt galv steel w pltd. stl lock insul.                 |      |     | X     |
| PI310   | Reduc. Wash 3/4in to 1/2in Rsd Fin Galv St                             |      |     | X     |
| PI312   | BX Conct set screw 3/8in Tr. 1/2in KO. zn die cast                     |      |     | X     |
| PI315   | BX Connector 90 3/8inTr. 1/2in KO zn die cast                          | X    | X   | X     |
| PI316   | Knockout Seal for 1/2in KO zn Pltd. steel                              | X    |     |       |
| PI319   | Romex Connector 3/4in Tr. 3/4in KO. zn Pltd. die cast                  | X    |     |       |
| PI320   | Romex Connector 3/8in Tr. 1/2in KO. zn Pltd. die cast 25/PK            | X    | X   | X     |
| PI321   | Romex Connector 3/8in Tr. 1/2 in KO. zn Pltd. die cast                 | X    | X   | X     |
| PI322   | BX Conct str sqze 3/8in Tr. 1/2in KO. zn die cast                      | X    |     |       |
| PI328   | Split Bolt Connector Cu use (6 max sol & 7 max strmd)                  |      |     | X     |
| PI330   | Romex Stop plastic 3/8inx1/2in for 2 cond. romex 12/2-14/2             | X    |     |       |
| PI331   | Plastic in Anti-Shortin Bush 14/2 14/3 & 12/2 BX cable                 | X    |     |       |
| PI340   | Combo Cable Connector for romex & BX 3/8in Tr. 1/2in KO                | X    |     |       |
| PI350   | Metal LT Conn straight 1/2in Tr. 1/2in K.O                             | X    |     |       |
| PI351   | Metal LT Conn straight 3/4in Tr. 3/4in K.O.                            | X    |     |       |
| PI352   | Liquid Tight Connector 90 1/2in Tr. 1/2in K.O. zn die cast             | X    |     |       |
| PI353   | Liquid Tight Connector 90 3/4in Tr. 3/4in K.O. zn die cast             | X    |     |       |
| PI360   | Box galv. steel 4in x 2-1/8inx 1-7/8in 1/2in KO 13 in <sup>3</sup>     | X    |     | X     |
| PI361   | Box galv. steel 4in x 2-1/8inx 2-1/8in 1/2in KO 14.5 in <sup>3</sup>   | X    |     | X     |
| PI362   | 1900 Box galv. steel 4X4X1-1/2 1/2&3/4 KO 21 in <sup>3</sup>           | X    |     | X     |
| PI363   | 1900 Box galv. steel 4X4X2-1/8in 1/2&3/4 KO 30.3 in <sup>3</sup>       | X    |     | X     |
| PI365   | Utility Cover Toggle Switch 2-11/32in x 4-1/4in Pltd. steel            | X    |     |       |
| PI368   | 1900 Cover Sw/Dup Rec cad fin. steel 4in x 4in raisd 1/2in             | X    |     | X     |
| PI371   | 1900 Cover Blank Flat galv. steel                                      | X    |     | X     |
| PI378   | 1900 Cover Duplex Recep cadil fin. steel 4X4 raisd 1/2in               | X    |     |       |
| PI381   | Fuse Outlet & Switch w cover 1/2HP-125V AC galv. steel                 |      |     | X     |
| PI382   | Weatherproof Cover Blank Al 1 Gang w gasket anodized                   | X    |     |       |
| PI385   | Wthrprf Box AL2-3/4inx4-1/2inx23 1/2in holes 2 plugs 19in <sup>3</sup> | X    |     |       |
| WM1002  | Cable Marker Book alpha numer  | X    |     |       |
| WM1003  | Cable Marker Book numeric contains 10 each: 1 - 45                     | X    | X   |       |
| WM1009  | Cable Marker Book line & term  | X    |     |       |



## SLIP-ON SOLDERLESS TERMINALS

## Insulated Male Slip-Ons

These male terminals crimp to the wires which relieves the need to solder. A variety of sizes are available and the slip ons are fully insulated in either vinyl or nylon.



| CATALOG NO. | DESCRIPTION                         | WIRE RANGE | TAB SIZE | UOM | ORDER MULTIPLE |
|-------------|-------------------------------------|------------|----------|-----|----------------|
| 60219       | Insulated Male Slip-On, pack of 23  | 22-18      | .250     | PK  | 1              |
| 60220       | Insulated Male Slip-On, pack of 23  | 16-14      | .187     | PK  | 1              |
| 60220LX     | Insulated Male Slip-On, pack of 50  | 16-14      | .187     | PK  | 1              |
| 6219        | Insulated Male Slip-On, pack of 22  | 16-14      | .250     | PK  | 1              |
| 6219LX      | Insulated Male Slip-On, pack of 50  | 16-14      | .250     | PK  | 1              |
| 61221LX     | Insulated Male Slip-On, pack of 50  | 12-10      | .250     | PK  | 1              |
| 61221CX     | Insulated Male Slip-On, pack of 100 | 12-10      | .250     | PK  | 1              |

## Insulated Female Slip-Ons

These female terminals crimp to the wires which relieves the need to solder. A variety of sizes are available and the slip ons are fully insulated in either vinyl or nylon.



| CATALOG NO. | DESCRIPTION                           | WIRE RANGE | TAB SIZE | UOM | ORDER MULTIPLE |
|-------------|---------------------------------------|------------|----------|-----|----------------|
| 6282        | Insulated Female Slip-On, pack of 22  | 22-18      | .187     | PK  | 1              |
| 6282LX      | Insulated Female Slip-On, pack of 50  | 22-18      | .187     | PK  | 1              |
| 6235        | Insulated Female Slip-On, pack of 22  | 22-18      | .250     | PK  | 1              |
| 6235LX      | Insulated Female Slip-On, pack of 50  | 22-18      | .250     | PK  | 1              |
| 6235CX      | Insulated Female Slip-On, pack of 100 | 22-18      | .250     | PK  | 1              |
| 6281        | Insulated Female Slip-On, pack of 22  | 16-14      | .187     | PK  | 1              |
| 6281LX      | Insulated Female Slip-On, pack of 50  | 16-14      | .187     | PK  | 1              |
| 6218        | Insulated Female Slip-On, pack of 22  | 16-14      | .250     | PK  | 1              |
| 6218LX      | Insulated Female Slip-On, pack of 50  | 16-14      | .250     | PK  | 1              |
| 6218CX      | Insulated Female Slip-On, pack of 100 | 16-14      | .250     | PK  | 1              |
| 6251        | Insulated Female Slip-On, pack of 17  | 12-10      | .250     | PK  | 1              |
| 6251LX      | Insulated Female Slip-On, pack of 50  | 12-10      | .250     | PK  | 1              |
| 6251CX      | Insulated Female Slip-On, pack of 100 | 12-10      | .250     | PK  | 1              |
| 61223LX     | Insulated Female Slip-On, pack of 50  | 12-10      | .340     | PK  | 1              |

## Fully Insulated Female Slip-Ons

These female terminals crimp to the wires which relieves the need to solder. A variety of sizes are available and the slip ons are fully insulated in either vinyl or nylon. This terminal features insulation grip. This terminal is usually supplied vinyl and has an insulation grip.



| CATALOG NO. | DESCRIPTION                                 | WIRE RANGE | TAB SIZE | UOM | ORDER MULTIPLE |
|-------------|---|------------|----------|-----|----------------|
| 6229**      | Fully Insulated Female Slip-On, pack of 11  | 16-14      | .250     | PK  | 1              |
| 6229LX**    | Fully Insulated Female Slip-On, pack of 50  | 16-14      | .250     | PK  | 1              |
| 6233        | Fully Insulated Female Slip-On, pack of 14  | 16-14      | .250     | PK  | 1              |
| 6233LX      | Fully Insulated Female Slip-On, pack of 50  | 16-14      | .250     | PK  | 1              |
| 6233CX      | Fully Insulated Female Slip-On, pack of 100 | 16-14      | .250     | PK  | 1              |
| 61234LX     | Fully Insulated Female Slip-On, pack of 50  | 12-10      | .250     | PK  | 1              |

\*This terminal features insulation grip.

\*\*This terminal is usually supplied vinyl and has an insulation grip.

## Non-Insulated Male Slip-Ons

These non insulated male terminals crimp to the wires which relieves the need to solder. A variety of sizes are available



| CATALOG NO. | DESCRIPTION                             | WIRE RANGE | TAB SIZE | UOM | ORDER MULTIPLE |
|-------------|---|------------|----------|-----|----------------|
| 6220        | Non-Insulated Male Slip-On, pack of 38  | 16-14      | .250     | PK  | 1              |
| 6220CX      | Non-Insulated Male Slip-On, pack of 100 | 16-14      | .250     | PK  | 1              |
| 61220       | Non-Insulated Male Slip-On, pack of 37  | 16-14      | .250     | PK  | 1              |

## Non-Insulated Female Slip-Ons

These non insulated female terminals crimp to the wires which relieves the need to solder. A variety of sizes are available. This terminal features insulation grip.



| CATALOG NO. | DESCRIPTION                               | WIRE RANGE | TAB SIZE | UOM | ORDER MULTIPLE |
|-------------|---|------------|----------|-----|----------------|
| 6214        | Non-Insulated Female Slip-On, pack of 35  | 16-14      | .250     | PK  | 1              |
| 6214CX      | Non-Insulated Female Slip-On, pack of 100 | 16-14      | .250     | PK  | 1              |
| 60251       | Non-Insulated Female Slip-On, pack of 26  | 12-10      | .250     | PK  | 1              |
| 60251CX     | Non-Insulated Female Slip-On, pack of 100 | 12-10      | .250     | PK  | 1              |

\*This terminal features insulation grip.

## Fully Insulated Male Slip-Ons

These male terminals crimp to the wires which relieves the need to solder. A variety of sizes are available and the slip ons are fully insulated in either vinyl or nylon.



| CATALOG NO. | DESCRIPTION                              | WIRE RANGE | TAB SIZE | UOM | ORDER MULTIPLE |
|-------------|--|------------|----------|-----|----------------|
| 6234        | Fully Insulated Male Slip-On, pack of 14 | 16-14      | .250     | PK  | 1              |
| 6234LX      | Fully Insulated Male Slip-On, pack of 50 | 16-14      | .250     | PK  | 1              |
| 61235LX     | Fully Insulated Male Slip-On, pack of 50 | 12-10      | .250     | PK  | 1              |

## Non-Insulated Flag Female Slip-Ons

These non insulated female terminals crimp to the wires which relieves the need to solder. A variety of sizes are available. Part 6213 features insulation grip.



| CATALOG NO. | DESCRIPTION                                    | WIRE RANGE | TAB SIZE | UOM | ORDER MULTIPLE |
|-------------|--|------------|----------|-----|----------------|
| 6213        | Non-Insulated Flag Female Slip-On, pack of 34  | 16-14      | .250     | PK  | 1              |
| 6213CX      | Non-Insulated Flag Female Slip-On, pack of 100 | 16-14      | .250     | PK  | 1              |
| 6224        | Non-Insulated Flag Female Slip-On, pack of 20  | 12-10      | .250     | PK  | 1              |
| 6224CX      | Non-Insulated Flag Female Slip-On, pack of 100 | 12-10      | .250     | PK  | 1              |

## SLIP-ON SOLDERLESS TERMINALS cont'd

### Fully Insulated Flag Female Slip-Ons

These female terminals crimp to the wires which relieves the need to solder. A variety of sizes are available and the slip-ons are fully insulated in either vinyl or nylon.



| CATALOG NO.   | DESCRIPTION                                     | WIRE RANGE | TAB SIZE | UOM | ORDER MULTIPLE |
|---------------|---|------------|----------|-----|----------------|
| <b>6277</b>   | Fully Insulated Flag Female Slip-On, pack of 9  | 16-14      | .250     | PK  | 1              |
| <b>6277NX</b> | Fully Insulated Flag Female Slip-On, pack of 25 | 16-14      | .250     | PK  | 1              |

### Combination Pack: Set of 6233 and 6234

Our Combination pack holds both a Fully Insulated Male and Female Slip On.



| CATALOG NO.    | DESCRIPTION   | WIRE RANGE | TAB SIZE | UOM | ORDER MULTIPLE |
|----------------|---|------------|----------|-----|----------------|
| <b>61233LX</b> | Set of Fully Insulated M/F Slip-Ons, pack of 25 pairs | 16-14      | .250     | PK  | 1              |

### Flag Female Compressor Terminal Kit

Parts 6258, 6271, 6259, 6273, 6270 in a four compartment, clear plastic box. Parts 6270 and 6273 are put in the same compartment.



| CATALOG NO.   | DESCRIPTION                         | UOM | ORDER MULTIPLE |
|---------------|-------------------------------------|-----|----------------|
| <b>6200HX</b> | Flag Female Compressor Terminal Kit | EA  | 1              |

### Flag Female Compressor Terminals

Also known as hermetic header terminals, these non-insulated terminals are designed with a larger distance between the "rolls" to allow for the rod in hermetic header applications. The increased distance allows the rod to slip in between them. Parts 6258 and 6259 are notched for bending. The notches are cut between the slip-on portion and the conductor barrel and enable the back of the slip-on portion to be folded against the conductor barrel after the wire connection is made. This terminal features insulation grip.



| CATALOG NO.    | DESCRIPTION                                  | WIRE RANGE | FITS     | UOM | ORDER MULTIPLE |
|----------------|--|------------|----------|-----|----------------|
| <b>6270</b>    | Flag Female Compressor Terminal, pack of 9   | 12-8       | .250 tab | PK  | 1              |
| <b>6270LX</b>  | Flag Female Compressor Terminal, pack of 50  | 12-8       | .250 tab | PK  | 1              |
| <b>6258*</b>   | Flag Female Compressor Terminal, pack of 17  | 16-14      | .250 tab | PK  | 1              |
| <b>6258CX*</b> | Flag Female Compressor Terminal, pack of 100 | 16-14      | .250 tab | PK  | 1              |
| <b>6259</b>    | Flag Female Compressor Terminal, pack of 14  | 12-10      | .250 tab | PK  | 1              |
| <b>6259CX</b>  | Flag Female Compressor Terminal, pack of 100 | 12-10      | .250 tab | PK  | 1              |

\* This terminal features insulation grip.

### Compressor Lead Kit

Our Compressor Lead kit includes the following products: a flag female compressor terminal (.250 tab; part 62589), a waterproof butt connector (12 10 wire range; part 62231), and a piece of 10 gauge wire.



| CATALOG NO.    | DESCRIPTION                       | UOM | ORDER MULTIPLE |
|----------------|-----------------------------------|-----|----------------|
| <b>60259HX</b> | Compressor Lead Kit with 12" wire | EA  | 1              |

## SPECIAL PURPOSE SOLDERLESS TERMINALS

### Insulated Plugs

These insulated terminals crimp to the wires which relieves the need to solder.



| CATALOG NO.   | DESCRIPTION                 | WIRE RANGE | UOM | ORDER MULTIPLE |
|---------------|-----------------------------|------------|-----|----------------|
| <b>6283</b>   | Insulated Plugs, pack of 17 | 22-18      | PK  | 1              |
| <b>6283LX</b> | Insulated Plugs, pack of 50 | 22-18      | PK  | 1              |
| <b>6285</b>   | Insulated Plugs, pack of 17 | 16-14      | PK  | 1              |
| <b>6285LX</b> | Insulated Plugs, pack of 50 | 16-14      | PK  | 1              |

### Combination Packs

These insulated terminals crimp to the wires which relieves the need to solder.



| CATALOG NO.   | DESCRIPTION   | UOM | ORDER MULTIPLE |
|---------------|---|-----|----------------|
| <b>6288</b>   | Combination Pack with parts 6283 and 6284, pack of 7 pairs  | PK  | 1              |
| <b>6288LX</b> | Combination Pack with parts 6283 and 6284, pack of 25 pairs | PK  | 1              |
| <b>6289</b>   | Combination Pack with parts 6285 and 6286, pack of 7 pairs  | PK  | 1              |
| <b>6289LX</b> | Combination Pack with parts 6285 and 6286, pack of 25 pairs | PK  | 1              |

### Fully Insulated Receptacles

These insulated terminals crimp to the wires which relieves the need to solder.

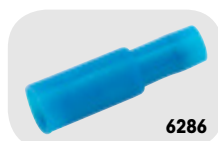

| CATALOG NO. | DESCRIPTION                             | WIRE RANGE | UOM | ORDER MULTIPLE |
|-------------|---|------------|-----|----------------|
| <b>6286</b> | Fully Insulated Receptacles, pack of 12 | 16-14      | PK  | 1              |



**SPECIAL PURPOSE SOLDERLESS TERMINALS cont'd****Tab Adapters – Quick Disconnect with Screw**

These insulated terminals crimp to the wires which relieves the need to solder.



| CATALOG NO.   | DESCRIPTION                                   | UOM | ORDER MULTIPLE |
|---------------|---|-----|----------------|
| <b>6209</b>   | Fits .250 Tab, #6-32 x 1/4" Screw, pack of 5  | PK  | 1              |
| <b>6209LX</b> | Fits .250 Tab, #6-32 x 1/4" Screw, pack of 50 | PK  | 1              |

**Tab Adapters – Single Female Double Male Tabs**

These insulated terminals crimp to the wires which relieves the need to solder. .250 male, .250 female.



| CATALOG NO.   | DESCRIPTION   | TAB SIZE | UOM | ORDER MULTIPLE |
|---------------|---|----------|-----|----------------|
| <b>6208</b>   | Tab Adapter; 1 female, 2 male; Bent 90°, pack of 12 | .250     | PK  | 1              |
| <b>6208LX</b> | Tab Adapter; 1 female, 2 male; Bent 90°, pack of 50 | .250     | PK  | 1              |
| <b>6211</b>   | Tab Adapter; 1 female, 2 male; Wye, pack of 27      | .250     | PK  | 1              |
| <b>6211CX</b> | Tab Adapter; 1 female, 2 male; Wye, pack of 100     | .250     | PK  | 1              |
| <b>6212</b>   | Tab Adapter; 1 female, 2 male; Stacked, pack of 16  | .250     | PK  | 1              |
| <b>6212CX</b> | Tab Adapter; 1 female, 2 male; Stacked, pack of 100 | .250     | PK  | 1              |

**Tap Connectors**

These insulated terminals crimp to the wires which relieves the need to solder. Designed to make tap splices.



| CATALOG NO. | DESCRIPTION                   | WIRE RANGE | UOM | ORDER MULTIPLE |
|-------------|-------------------------------|------------|-----|----------------|
| <b>6241</b> | Tap Splice – blue, pack of 15 | 16-14      | PK  | 1              |

**Tab Adapters – Piggy Back Slip-Ons**

These insulated terminals crimp to the wires which relieves the need to solder. Multi-stack, .250 male tab, .250 female slip-on.



| CATALOG NO.   | DESCRIPTION                                   | WIRE RANGE | UOM | ORDER MULTIPLE |
|---------------|---|------------|-----|----------------|
| <b>6210</b>   | Non-Insulated Piggy Back Slip-Ons, pack of 20 | 16-14      | PK  | 1              |
| <b>6210LX</b> | Insulated Piggy Back Slip-Ons, pack of 11     | 16-14      | PK  | 1              |
| <b>6210LX</b> | Insulated Piggy Back Slip-Ons, pack of 50     | 16-14      | PK  | 1              |
| <b>6210CX</b> | Insulated Piggy Back Slip-Ons, pack of 100    | 16-14      | PK  | 1              |

**Tab Adapters – Male Tabs**

These insulated terminals crimp to the wires which relieves the need to solder.



| CATALOG NO.   | DESCRIPTION                       | TAB SIZE | STUD | UOM | ORDER MULTIPLE |
|---------------|-----------------------------------|----------|------|-----|----------------|
| <b>6230</b>   | Male Tabs – Straight, pack of 28  | .250     | #8   | PK  | 1              |
| <b>6230CX</b> | Male Tabs – Straight, pack of 100 | .250     | #8   | PK  | 1              |

**Fully Insulated Dead End Connectors**

These insulated terminals crimp to the wires which relieves the need to solder.



| CATALOG NO.   | DESCRIPTION                                     | WIRE RANGE | UOM | ORDER MULTIPLE |
|---------------|---|------------|-----|----------------|
| <b>6222</b>   | Fully Insulated Dead End Connectors, pack of 27 | 22-14      | PK  | 1              |
| <b>6222LX</b> | Fully Insulated Dead End Connectors, pack of 50 | 22-14      | PK  | 1              |
| <b>6223</b>   | Fully Insulated Dead End Connectors, pack of 21 | 18-10      | PK  | 1              |
| <b>6223LX</b> | Fully Insulated Dead End Connectors, pack of 50 | 18-10      | PK  | 1              |

**STANDARD SOLDERLESS TERMINALS****Insulated Hooks**

These insulated terminals crimp to the wires which relieves the need to solder.



| CATALOG NO.   | DESCRIPTION                 | WIRE RANGE | STUD | UOM | ORDER MULTIPLE |
|---------------|-----------------------------|------------|------|-----|----------------|
| <b>6242</b>   | Insulated Hooks, pack of 22 | 22-18      | #8   | PK  | 1              |
| <b>6242LX</b> | Insulated Hooks, pack of 50 | 22-18      | #8   | PK  | 1              |
| <b>6244</b>   | Insulated Hooks, pack of 20 | 16-14      | #8   | PK  | 1              |
| <b>6244LX</b> | Insulated Hooks, pack of 50 | 16-14      | #8   | PK  | 1              |

**Insulated Butt Connectors**

These insulated terminals crimp to the wires which relieves the need to solder.



| CATALOG NO.   | DESCRIPTION                           | WIRE RANGE | UOM | ORDER MULTIPLE |
|---------------|---------------------------------------|------------|-----|----------------|
| <b>6232</b>   | Insulated Butt Connector, pack of 26  | 22-18      | PK  | 1              |
| <b>6232LX</b> | Insulated Butt Connector, pack of 50  | 22-18      | PK  | 1              |
| <b>6232CX</b> | Insulated Butt Connector, pack of 100 | 22-18      | PK  | 1              |
| <b>6217</b>   | Insulated Butt Connector, pack of 27  | 16-14      | PK  | 1              |
| <b>6217LX</b> | Insulated Butt Connector, pack of 50  | 16-14      | PK  | 1              |
| <b>6217CX</b> | Insulated Butt Connector, pack of 100 | 16-14      | PK  | 1              |
| <b>6231</b>   | Insulated Butt Connector, pack of 16  | 12-10      | PK  | 1              |
| <b>6231LX</b> | Insulated Butt Connector, pack of 50  | 12-10      | PK  | 1              |
| <b>6231CX</b> | Insulated Butt Connector, pack of 100 | 12-10      | PK  | 1              |
| <b>6287</b>   | Insulated Butt Connector, pack of 5   | 22-18      | PK  | 1              |
| <b>6287XX</b> | Insulated Butt Connector, pack of 10  | 8          | PK  | 1              |
| <b>6287NX</b> | Insulated Butt Connector, pack of 25  | 8          | PK  | 1              |
| <b>6287CX</b> | Insulated Butt Connector, pack of 100 | 8          | PK  | 1              |

## STANDARD SOLDERLESS TERMINALS cont'd

### Butt Connector Assortment Kit

This Assortment is a perfect addition to the HVAC kit. It includes an Insulated Butt Connector, a Non Insulated Butt Connector, and a Nylon Insulated Butt Connector. Includes parts 6217, 6231, and 6232.



6200BSX

| CATALOG NO. | DESCRIPTION                   | UOM | ORDER MULTIPLE |
|-------------|-------------------------------|-----|----------------|
| 6200BSX     | Butt Connector Assortment Kit | EA  | 1              |

### Insulated Spades

These insulated terminals crimp to the wires which relieves the need to solder.



61214

| CATALOG NO. | DESCRIPTION                   | WIRE RANGE | STUD | UOM | ORDER MULTIPLE |
|-------------|-------------------------------|------------|------|-----|----------------|
| 61214       | Insulated Spades, pack of 23  | 22-18      | #6   | PK  | 1              |
| 6237        | Insulated Spades, pack of 22  | 22-18      | #8   | PK  | 1              |
| 6237LX      | Insulated Spades, pack of 50  | 22-18      | #8   | PK  | 1              |
| 61256LX     | Insulated Spades, pack of 50  | 22-18      | #10  | PK  | 1              |
| 6274        | Insulated Spades, pack of 22  | 16-14      | #6   | PK  | 1              |
| 6274LX      | Insulated Spades, pack of 50  | 16-14      | #6   | PK  | 1              |
| 6227        | Insulated Spades, pack of 22  | 16-14      | #8   | PK  | 1              |
| 6227LX      | Insulated Spades, pack of 50  | 16-14      | #8   | PK  | 1              |
| 6228        | Insulated Spades, pack of 22  | 16-14      | #10  | PK  | 1              |
| 6228LX      | Insulated Spades, pack of 50  | 16-14      | #10  | PK  | 1              |
| 60254       | Insulated Spades, pack of 18  | 12-10      | #8   | PK  | 1              |
| 60254LX     | Insulated Spades, pack of 50  | 12-10      | #8   | PK  | 1              |
| 60254CX     | Insulated Spades, pack of 100 | 12-10      | #8   | PK  | 1              |
| 6255        | Insulated Spades, pack of 17  | 12-10      | #10  | PK  | 1              |
| 6255LX      | Insulated Spades, pack of 50  | 12-10      | #10  | PK  | 1              |
| 6255CX      | Insulated Spades, pack of 100 | 12-10      | #10  | PK  | 1              |

### Insulated Flange Spades

These insulated terminals crimp to the wires which relieves the need to solder.



61255

| CATALOG NO. | DESCRIPTION                         | WIRE RANGE | STUD | UOM | ORDER MULTIPLE |
|-------------|-------------------------------------|------------|------|-----|----------------|
| 61255       | Insulated Flange Spades, pack of 16 | 12-10      | #10  | PK  | 1              |
| 61255LX     | Insulated Flange Spades, pack of 50 | 12-10      | #10  | PK  | 1              |

### Non-Insulated Rings

These non insulated terminals crimp to the wires which relieves the need to solder.



60206

| CATALOG NO. | DESCRIPTION                      | WIRE RANGE | STUD | UOM | ORDER MULTIPLE |
|-------------|----------------------------------|------------|------|-----|----------------|
| 60206       | Non-Insulated Rings, pack of 25  | 22-18      | #10  | PK  | 1              |
| 6215        | Non-Insulated Rings, pack of 27  | 16-14      | #8   | PK  | 1              |
| 60205       | Non-Insulated Rings, pack of 21  | 16-14      | 1/4" | PK  | 1              |
| 60205CX     | Non-Insulated Rings, pack of 100 | 16-14      | 1/4" | PK  | 1              |

### Non-Insulated Spades

These non insulated terminals crimp to the wires which relieves the need to solder.



6226

| CATALOG NO. | DESCRIPTION                       | WIRE RANGE | STUD | UOM | ORDER MULTIPLE |
|-------------|-----------------------------------|------------|------|-----|----------------|
| 6226        | Non-Insulated Spades, pack of 23  | 16-14      | #10  | PK  | 1              |
| 6226CX      | Non-Insulated Spades, pack of 100 | 16-14      | #10  | PK  | 1              |

### Insulated Spring Spades

These insulated terminals crimp to the wires which relieves the need to solder.



6238

| CATALOG NO. | DESCRIPTION                          | WIRE RANGE | STUD | UOM | ORDER MULTIPLE |
|-------------|--------------------------------------|------------|------|-----|----------------|
| 6238        | Insulated Spring Spades, pack of 22  | 22-18      | #8   | PK  | 1              |
| 6238LX      | Insulated Spring Spades, pack of 50  | 22-18      | #8   | PK  | 1              |
| 6276        | Insulated Spring Spades, pack of 21  | 16-14      | #6   | PK  | 1              |
| 6276LX      | Insulated Spring Spades, pack of 50  | 16-14      | #6   | PK  | 1              |
| 6239        | Insulated Spring Spades, pack of 22  | 16-14      | #8   | PK  | 1              |
| 6239LX      | Insulated Spring Spades, pack of 50  | 16-14      | #8   | PK  | 1              |
| 60256       | Insulated Spring Spades, pack of 17  | 12-10      | #8   | PK  | 1              |
| 60256CX     | Insulated Spring Spades, pack of 100 | 12-10      | #8   | PK  | 1              |

### Insulated Rings

These insulated terminals crimp to the wires which relieves the need to solder.



61202

| CATALOG NO. | DESCRIPTION                  | WIRE RANGE | STUD  | UOM | ORDER MULTIPLE |
|-------------|------------------------------|------------|-------|-----|----------------|
| 61202       | Insulated Rings, pack of 22  | 22-18      | #6    | PK  | 1              |
| 6236LX      | Insulated Rings, pack of 50  | 22-18      | #8    | PK  | 1              |
| 6272        | Insulated Rings, pack of 22  | 16-14      | #6    | PK  | 1              |
| 6216        | Insulated Rings, pack of 23  | 16-14      | #10   | PK  | 1              |
| 6216LX      | Insulated Rings, pack of 50  | 16-14      | #10   | PK  | 1              |
| 6216CX      | Insulated Rings, pack of 100 | 16-14      | #10   | PK  | 1              |
| 60247       | Insulated Rings, pack of 17  | 12-10      | #6    | PK  | 1              |
| 60252CX     | Insulated Rings, pack of 100 | 12-10      | #8    | PK  | 1              |
| 6252        | Insulated Rings, pack of 17  | 12-10      | #10   | PK  | 1              |
| 6252LX      | Insulated Rings, pack of 50  | 12-10      | #10   | PK  | 1              |
| 6253LX      | Insulated Rings, pack of 50  | 12-10      | 1/4"  | PK  | 1              |
| 6253CX      | Insulated Rings, pack of 100 | 12-10      | 1/4"  | PK  | 1              |
| 6257        | Insulated Rings, pack of 6   | 8          | 1/4"  | PK  | 1              |
| 6257NX      | Insulated Rings, pack of 25  | 8          | 1/4"  | PK  | 1              |
| 61252       | Insulated Rings, pack of 5   | 6          | 5/16" | PK  | 1              |
| 61252NX     | Insulated Rings, pack of 25  | 6          | 5/16" | PK  | 1              |

**HIGH TEMPERATURE SOLDERLESS TERMINALS****High Temperature Male Slip-Ons**

The High Temperature Male Slip Ons are constructed of nickel plated steel. These non insulated terminals are rated at 900 degree F (482 degree C).



| CATALOG NO.   | DESCRIPTION                           | WIRE RANGE | TAB SIZE | UOM | ORDER MULTIPLE |
|---------------|---------------------------------------|------------|----------|-----|----------------|
| <b>4220</b>   | High Temp. Male Slip-Ons, pack of 21  | 16-14      | .250     | PK  | 1              |
| <b>4220CX</b> | High Temp. Male Slip-Ons, pack of 100 | 16-14      | .250     | PK  | 1              |
| <b>4219</b>   | High Temp. Male Slip-Ons, pack of 21  | 12-10      | .250     | PK  | 1              |

**High Temperature Flag Female Slip-Ons**

The High Temperature Flag Female Slip Ons are constructed of nickel plated steel. These non insulated terminals are rated at 900 degree F (482 degree C).



| CATALOG NO.   | DESCRIPTION                                  | WIRE RANGE | TAB SIZE | UOM | ORDER MULTIPLE |
|---------------|--|------------|----------|-----|----------------|
| <b>4213</b>   | High Temp. Flag Female Slip-Ons, pack of 16  | 16-14      | .250     | PK  | 1              |
| <b>4213CX</b> | High Temp. Flag Female Slip-Ons, pack of 100 | 16-14      | .250     | PK  | 1              |
| <b>4224</b>   | High Temp. Flag Female Slip-Ons, pack of 11  | 12-10      | .250     | PK  | 1              |
| <b>4224NX</b> | High Temp. Flag Female Slip-Ons, pack of 25  | 12-10      | .250     | PK  | 1              |
| <b>4224CX</b> | High Temp. Flag Female Slip-Ons, pack of 100 | 12-10      | .250     | PK  | 1              |

**High Temperature Rings**

The High Temperature Rings are constructed of nickel plated steel. These non insulated terminals are rated at 900 degree F (482 degree C).



| CATALOG NO.   | DESCRIPTION                   | WIRE RANGE | STUD | UOM | ORDER MULTIPLE |
|---------------|-------------------------------|------------|------|-----|----------------|
| <b>4215</b>   | High Temp. Rings, pack of 21  | 16-14      | #10  | PK  | 1              |
| <b>4215CX</b> | High Temp. Rings, pack of 100 | 16-14      | #10  | PK  | 1              |
| <b>4205CX</b> | High Temp. Rings, pack of 100 | 16-14      | 1/4" | PK  | 1              |
| <b>4252</b>   | High Temp. Rings, pack of 14  | 12-10      | #10  | PK  | 1              |
| <b>4252CX</b> | High Temp. Rings, pack of 100 | 12-10      | #10  | PK  | 1              |
| <b>4253</b>   | High Temp. Rings, pack of 14  | 12-10      | 1/4" | PK  | 1              |
| <b>4253CX</b> | High Temp. Rings, pack of 100 | 12-10      | 1/4" | PK  | 1              |

**High Temperature Female Slip-Ons**

The High Temperature Female Slip Ons are constructed of nickel plated steel. These non insulated terminals are rated at 900 degree F (482 degree C).



| CATALOG NO.   | DESCRIPTION                             | WIRE RANGE | TAB SIZE | UOM | ORDER MULTIPLE |
|---------------|---|------------|----------|-----|----------------|
| <b>4221</b>   | High Temp. Female Slip-Ons, pack of 20  | 16-14      | .187     | PK  | 1              |
| <b>4221CX</b> | High Temp. Female Slip-Ons, pack of 100 | 16-14      | .187     | PK  | 1              |
| <b>4214</b>   | High Temp. Female Slip-Ons, pack of 21  | 16-14      | .250     | PK  | 1              |
| <b>4214CX</b> | High Temp. Female Slip-Ons, pack of 100 | 16-14      | .250     | PK  | 1              |
| <b>4204</b>   | High Temp. Female Slip-Ons, pack of 17  | 12-10      | .250     | PK  | 1              |
| <b>4204CX</b> | High Temp. Female Slip-Ons, pack of 100 | 12-10      | .250     | PK  | 1              |

**High Temperature Spades**

The High Temperature Spades Slip Ons are constructed of nickel plated steel. These non insulated terminals are rated at 900 degree F (482 degree C).



| CATALOG NO.   | DESCRIPTION                    | WIRE RANGE | STUD | UOM | ORDER MULTIPLE |
|---------------|--------------------------------|------------|------|-----|----------------|
| <b>4226</b>   | High Temp. Spades, pack of 23  | 16-14      | #10  | PK  | 1              |
| <b>4226CX</b> | High Temp. Spades, pack of 100 | 16-14      | #10  | PK  | 1              |
| <b>4254CX</b> | High Temp. Spades, pack of 100 | 12-10      | #10  | PK  | 1              |

**High Temperature Butt Connectors**

The High Temperature Butt Connectors are constructed of nickel plated steel. These non insulated terminals are rated at 900 degree F (482 degree C).



| CATALOG NO. | DESCRIPTION                            | WIRE RANGE | UOM | ORDER MULTIPLE |
|-------------|--|------------|-----|----------------|
| <b>4231</b> | High Temp. Butt Connectors, pack of 17 | 12-10      | PK  | 1              |

**High Temperature Assortment**

The High Temperature Assortment Pack holds terminals that are constructed of nickel plated steel. These non insulated terminals are rated at 900 degree F (482 degree C). Includes parts 4213, 4215, and 4204, and 4254.



| CATALOG NO.   | DESCRIPTION           | UOM | ORDER MULTIPLE |
|---------------|-----------------------|-----|----------------|
| <b>4200AX</b> | High Temp. Assortment | EA  | 1              |







## ANCHORS

## Metal Drive Anchors

The anchors offer a Quick and Easy Solution for Light Duty Anchoring Jobs in Concrete and Masonry and Easy through type fastening, even when used in bottomless holes

7236RLX



| CATALOG NO. | DESCRIPTION              | SIZE          | EMBEDMENT | PULLOUT LOAD | UOM | ORDER MULTIPLE |
|-------------|--------------------------|---------------|-----------|--------------|-----|----------------|
| 7233RLX     | Drive Anchor, pack of 50 | 1/4" X 3/4"   | 5/8"      | 500 lb.      | PK  | 1              |
| 7234RLX     | Drive Anchor, pack of 50 | 1/4" X 1"     | 7/8"      | 944 lb.      | PK  | 1              |
| 7235RLX     | Drive Anchor, pack of 50 | 1/4" X 1-1/4" | 1-1/8"    | 1,146 lb.    | PK  | 1              |
| 7236RLX     | Drive Anchor, pack of 50 | 1/4" X 1-1/2" | 1-3/8"    | 854 lb.      | PK  | 1              |

## Drop-In Expansion Anchor Setting Tool

This tool is great for use while setting an anchor.

7146



| CATALOG NO. | DESCRIPTION                          | UOM | ORDER MULTIPLE |
|-------------|--------------------------------------|-----|----------------|
| 7146        | For use with anchor part number 7142 | EA  | 1              |

## Self-Drilling Gypsum Wallboard Anchors

These anchors pre drill precise holes in gypsum wallboard with no special tools required. The anchors are easily installed with a #2 or #3 Phillips screwdriver, slotted driver, or power driver. Plastic plugs toggles and toggles are easily replaced with the deep threaded products. There is a full range to cover all wall fastening applications and are available in corrosion resistant and non conductive white nylon. The product has a low profile head and can easily be backed out. They provide and strong engagement in 3/4in., 1/2in., and 5/8in. gypsum wallboard and are supplied with combo head screws.

7321X



| CATALOG NO. | DESCRIPTION  | SCREW SIZE  | MAX. FIXTURE | UOM | ORDER MULTIPLE |
|-------------|--|-------------|--------------|-----|----------------|
| 7316X       | E-Z Ancor®; nylon, pack of 10                      | #8 x 1-1/4" | 3/4"         | PK  | 1              |
| 7316L       | E-Z Ancor®; nylon, pack of 50                      | #8 x 1-1/4" | 3/4"         | PK  | 1              |
| 7311L       | E-Z Ancor®; zinc die cast*, pack of 50             | #6 x 1-1/4" | 3/4"         | PK  | 1              |
| 7317X       | E-Z Ancor Lite™; nylon, pack of 10                 | #6 x 1-1/4" | 3/4"         | PK  | 1              |
| 7317L       | E-Z Ancor Lite™; nylon, pack of 50                 | #6 x 1-1/4" | 3/4"         | PK  | 1              |
| 7321X       | E-Z Toggle™; zinc die cast; heavy-duty, pack of 10 | #8 x 2-1/8" | 5/8"         | PK  | 1              |

\*Smaller version of the E-Z Ancor® with a versatile core that can use #6 or #8 sheet metal screws or #6, #7, #8 drywall screws.

## Drive Fasteners

These steel fasteners can be driven into dry wall like a nail and are secured by turning the screw down completely to expand the ribs.

7303



| CATALOG NO. | DESCRIPTION               | HOLE SIZE | GRIP RANGE    | UOM | ORDER MULTIPLE |
|-------------|---------------------------|-----------|---------------|-----|----------------|
| 7301        | Drive Fastener, pack of 6 | 1/4"      | 3/16" to 3/8" | PK  | 1              |
| 7302        | Drive Fastener, pack of 6 | 1/4"      | 1/8" to 1/2"  | PK  | 1              |
| 7303        | Drive Fastener, pack of 6 | 1/4"      | 1/8" to 3/16" | PK  | 1              |

## Drop-In Expansion Anchors

These heavy duty anchors are made of carbon steel. They are set by means of an internal plug and setting tool.































7142



| CATALOG NO. | DESCRIPTION        | BOLT SIZE | THREADS PER INCH | HOLE DEPTH | THREAD DEPTH | DRILL BIT SIZE | UOM | ORDER MULTIPLE |
|-------------|--------------------|-----------|------------------|------------|--------------|----------------|-----|----------------|
| 7142        | Anchor, pack of 4  | 3/8"      | 18               | 1-5/8"     | 1/2"         | 1/2"           | PK  | 1              |
| 7142LX      | Anchor, pack of 50 | 3/8"      | 18               | 1-5/8"     | 1/2"         | 1/2"           | PK  | 1              |



# DEVCO PLASTIC ANCHOR KITS

| CATALOG NO. |          | ANCHOR  | DRILL SIZE  | DRILL BIT INCLUDED   | SCREW   | SCREW SIZE   |
|-------------|----------|---|---|--|---|--------------|
| SMALL PACK* | 100 PACK |   |   |  |   |              |
|             | 7103CX   |  | <u>5/32</u>  |  |  | #4 x 3/4"    |
|             | 7101CX   |  | <u>3/16</u>  |  |  | #8 x 1"      |
|             | 7101HCX  |   |   |  |  | #8 x 1"      |
|             | 7102CX   |  | <u>1/4</u>   |  |  | #10 x 1-1/4" |
|             | 7102HCX  |   |   |  |  | #10 x 1"     |
|             | 7106CX   |  | <u>1/4</u>   |  |  | #10 x 1      |
| 7106        |          |  | <u>1/4</u>   | None   |  | #10 x 1"     |
| 7105LX      |          |  | <u>5/16</u>  |  |  | #14 x 1-1/2" |
| 7111X       | 7111CX   |  | <u>5/16</u>  |  |  | #14 x 1"     |
|             | 7111HCX  |   |   |  |  | #14 x 1"     |

| *SMALL PACK | COUNT |
|-------------|-------|
| 7106        | 28    |
| 7111X       | 40    |
| 7105LX      | 50    |



**BOXES, RINGS, AND COVERS****Steel Utility Boxes\***

Steel Utility Boxes are used for convenience outlets, switch boxes and small junction boxes. Galvanized steel.

**PI360**

| CATALOG NO.      | LENGTH | WIDTH  | DEPTH  | CAPACITY (cubic in.) | KNOCKOUT (in.) | UOM | ORDER MULTIPLE |
|------------------|--------|--------|--------|----------------------|----------------|-----|----------------|
| <b>PI360</b>     | 4"     | 2-1/8" | 1-7/8" | 13.0                 | 1/2            | EA  | 1              |
| <b>PI361</b>     | 4"     | 2-1/8" | 2-1/8" | 14.5                 | 1/2            | EA  | 1              |
| <b>PI361-3/4</b> | 4"     | 2-1/8" | 2-1/8" | 14.5                 | 3/4 & 1/2      | EA  | 1              |

**Steel Octagon Box\***

Steel Utility Boxes are used for convenience outlets, switch boxes and small junction boxes. Galvanized steel.

**PI364**

| CATALOG NO.  | LENGTH | WIDTH | DEPTH  | CAPACITY (cubic in.) | KNOCKOUT (in.) | UOM | ORDER MULTIPLE |
|--------------|--------|-------|--------|----------------------|----------------|-----|----------------|
| <b>PI364</b> | 4"     | 4"    | 1-1/2" | 15.5                 | 3/4 & 1/2      | EA  | 1              |

**Device Rings\***

Device rings are designed for projects of preexisting locations. They can help narrow an opening for a box in the sheet rock. They are also known as Plaster Rings. Galvanized steel.

**PI387**

| CATALOG NO.  | DESCRIPTION      | NUMBER DEVICES | RAISED | UOM | ORDER MULTIPLE |
|--------------|------------------|----------------|--------|-----|----------------|
| <b>PI387</b> | 1900 Device Ring | 1              | 1/2"   | EA  | 1              |

**Utility Covers\***

These covers are 4 1/4in. x 2 11/32in. and are designed for appliances or emergency oil burners.

**PI383**

| CATALOG NO.  | DESCRIPTION   | UOM | ORDER MULTIPLE |
|--------------|---|-----|----------------|
| <b>PI383</b> | Appliance Switch, .4687" dia. hole, baked cadilite finish | EA  | 1              |
| <b>PI374</b> | Red finish, "Emergency Gas Burner" in white letters       | EA  | 1              |

**Steel 1900 Boxes\***

Steel Utility Boxes are used for convenience outlets, switch boxes and small junction boxes. Galvanized steel.

**PI362**

| CATALOG NO.  | LENGTH | WIDTH | DEPTH  | CAPACITY (cubic in.) | KNOCKOUT (in.) | UOM | ORDER MULTIPLE |
|--------------|--------|-------|--------|----------------------|----------------|-----|----------------|
| <b>PI362</b> | 4"     | 4"    | 1-1/2" | 21.0                 | 3/4 & 1/2      | EA  | 1              |
| <b>PI363</b> | 4"     | 4"    | 2-1/8" | 30.3                 | 3/4 & 1/2      | EA  | 1              |

**Extension Rings\***

Extension rings are used when extra cubic inch capacity is needed for additional wiring. Galvanized steel.

**PI390**

| CATALOG NO.  | LENGTH | WIDTH  | DEPTH  | CAPACITY (cubic in.) | KNOCKOUT (in.) | UOM | ORDER MULTIPLE |
|--------------|--------|--------|--------|----------------------|----------------|-----|----------------|
| <b>PI390</b> | 4"     | 2-1/8" | 1-7/8" | 13.0                 | 1/2            | EA  | 1              |
| <b>PI391</b> | 4"     | 4"     | 1-1/2" | 21.0                 | 3/4 & 1/2      | EA  | 1              |

**Plated Steel Utility Covers\***

Ideal for exposed work applications, providing an easy method for the installation of electrical devices (switches, receptacles, fans, lights, etc.)

**PI365**

| CATALOG NO.  | DESCRIPTION                | WIDTH    | LENGTH | UOM | ORDER MULTIPLE |
|--------------|----------------------------|----------|--------|-----|----------------|
| <b>PI365</b> | Toggle Switch              | 2-11/32" | 4-1/4" | EA  | 1              |
| <b>PI366</b> | Duplex Receptacle          | 2-11/32" | 4-1/4" | EA  | 1              |
| <b>PI367</b> | Blank Cover                | 2-11/32" | 4-1/4" | EA  | 1              |
| <b>PI375</b> | Standard Single Receptacle | 2-11/32" | 4-1/4" | EA  | 1              |

**Utility Plates\***

These plates are 4 1/4in. x 2 11/32in. and are designed for emergency oil burners.

**PI393**

| CATALOG NO.  | DESCRIPTION   | UOM | ORDER MULTIPLE |
|--------------|---|-----|----------------|
| <b>PI393</b> | Red finish, "Emergency Oil Burner" in white letters | EA  | 1              |
| <b>PI394</b> | Red finish, "Emergency Gas Burner" in white letters | EA  | 1              |

\*Items in this section are Underwriter's Laboratories listed or recognized under the prime manufacturer's name.

## BOXES, RINGS, AND COVERS cont'd

### Steel 1900 Covers\*

The covers are baked in a cadilite finished steel and are raised 1/2in. with fully depressed corners. Size: 4" x 4".



| CATALOG NO. | DESCRIPTION   | UOM | ORDER MULTIPLE |
|-------------|---|-----|----------------|
| PI377       | Single Toggle   | EA  | 1              |
| PI378       | Single Duplex Receptacle                              | EA  | 1              |
| PI379       | One Standard Single Receptacle                        | EA  | 1              |
| PI368       | Toggle Switch and Duplex Receptacle                   | EA  | 1              |
| PI370       | Toggle Switch and Standard Single Receptacle          | EA  | 1              |
| PI371       | Flat, Blank, Galvanized steel (not Cadilite finished) | EA  | 1              |

### Weatherproof Covers\*

These covers can be used with item PI385 and come with gaskets.

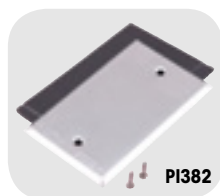

| CATALOG NO. | DESCRIPTION  | UOM | ORDER MULTIPLE |
|-------------|--|-----|----------------|
| PI382       | Blank Cover  | EA  | 1              |
| PI386       | Lever Switch Cover for standard toggle type switches | EA  | 1              |
| PI389       | Duplex Receptacle Cover                              | EA  | 1              |
| PI389-GFI   | GFI Receptacle Cover                                 | EA  | 1              |

### Weatherproof Boxes\*

Heavy duty die cast aluminum with baked aluminum finish. Boxes have two closure plugs and three holes. Item is Underwriter's Laboratories listed or recognized under the prime manufacturer's name.



| CATALOG NO. | LENGTH | WIDTH  | DEPTH | CAPACITY (cubic in.) | HOLE SIZE (in.) | UOM | ORDER MULTIPLE |
|-------------|--------|--------|-------|----------------------|-----------------|-----|----------------|
| PI385       | 4-1/2" | 2-3/4" | 2"    | 19.0                 | 1/2             | EA  | 1              |
| PI385-34    | 4-1/2" | 2-3/4" | 2"    | 19.0                 | 3/4             | EA  | 1              |

### Weatherproof Box with Lever Switch Cover\*

The box is heavy duty die cast aluminum with baked aluminum finish and has two closure plugs and three holes. The cover comes with the gaskets. Includes parts PI385 and PI386.



| CATALOG NO. | DESCRIPTION                             | UOM | ORDER MULTIPLE |
|-------------|---|-----|----------------|
| PI384       | Weatherproof Box and Lever Switch Cover | EA  | 1              |

### Safety Plates\*

Safety plates, also called nail in plates, or nail plates, install quickly and protect wire, cable and pipes that may be installed in upright wood stud walls.



| CATALOG NO. | DESCRIPTION                     | UOM | ORDER MULTIPLE |
|-------------|---------------------------------|-----|----------------|
| PI232CX     | Safety Plate – approximately 6" | EA  | 100            |

## BULBS

### Incandescent Light Bulbs

Multi-filaments support increased bulb light. Filaments have solid nickel leads. Brass base is rust and freeze resistant. Bulbs are designed for 130 volts. Rough Service bulbs are designed for maximum vibration resistance. Toughcoat helps prevent shattering on impact for superior safety. Comes in standard pack of six.



| CATALOG NO. | DESCRIPTION                    | WATTS | UOM | ORDER MULTIPLE |
|-------------|--------------------------------|-------|-----|----------------|
| 5231        | Rough Service Bulbs, pack of 6 | 75    | PK  | 1              |
| 5232        | Rough Service Bulbs, pack of 6 | 100   | PK  | 1              |

\*Items in this section are Underwriter's Laboratories listed or recognized under the prime manufacturer's name.



## CABLE CONNECTORS

**Zinc Plated Die Cast Steel Romex Connectors\***

These zinc plated die cast connectors are for use with Romex, Service, and UF Cables.

PI319



| CATALOG NO. | DESCRIPTION                                       | TRADE SIZE | KNOCKOUT | UOM | ORDER MULTIPLE |
|-------------|---|------------|----------|-----|----------------|
| PI321       | Zinc plated die cast Romex Connector, pack of 8   | 3/8"       | 1/2"     | PK  | 1              |
| PI320       | Zinc plated die cast Romex Connector, pack of 25  | 3/8"       | 1/2"     | PK  | 1              |
| PI319       | Zinc plated die cast Romex Connector, pack of 4   | 3/4"       | 3/4"     | PK  | 1              |
| PI319CX     | Zinc plated die cast Romex Connector, pack of 100 | 3/4"       | 3/4"     | PK  | 1              |

**BX and Greenfield Connectors\***

These connectors are used to terminate Flexible Metal Conduit to a knock out in a dry location box or enclosure. Zinc die cast.



| CATALOG NO. | DESCRIPTION  | TRADE SIZE | KNOCKOUT | UOM | ORDER MULTIPLE |
|-------------|--|------------|----------|-----|----------------|
| PI311       | Set Screw Type Connector, 25 per pack  | 3/8"       | 1/2"     | PK  | 1              |
| PI312       | Set Screw Type Connector, 8 per pack   | 3/8"       | 1/2"     | PK  | 1              |
| PI322       | Straight Connector, squeeze type, for armored cable and flexible conduit, 8 per pack | 3/8"       | 1/2"     | PK  | 1              |
| PI315       | 90° Connector, 3 per pack  | 3/8"       | 1/2"     | PK  | 1              |
| PI341       | 90° Connector, 4 per pack  | 1/2"       | 1/2"     | PK  | 1              |
| PI340       | Combination Cable Connector suitable for Romex or BX and Greenfield, 8 per pack      | 3/8"       | 1/2"     | PK  | 1              |
| PI318       | Duplex Connector with single screw, clamp type, 2 per pack                           | 3/8"       | 1/2"     | PK  | 1              |

**Thinwall E.M.T. Connectors\***

These are used to join EMT conduit to boxes on enclosures. Zinc die cast.

PI411



| CATALOG NO. | DESCRIPTION  | TRADE SIZE | KNOCKOUT | UOM | ORDER MULTIPLE |
|-------------|--|------------|----------|-----|----------------|
| PI411       | Compression Type Connectors, 8 per pack  | 1/2"       | 1/2"     | PK  | 1              |
| PI412       | Compression Type Connectors, 8 per pack  | 3/4"       | 3/4"     | PK  | 1              |
| PI416       | Compression Type Couplings, 8 per pack   | 3/4"       |          | PK  | 1              |
| PI426       | Compression Type Straight Connectors for connecting E.M.T. to Liquid-Tight, 8 per pack | 3/4"       |          | PK  | 1              |
| PI419       | Set Screw Type Connectors, 8 per pack  | 1/2"       | 1/2"     | PK  | 1              |

**Rigid Conduit Bodies\***

These bodies are Aluminum and can be use indoor or outdoor. Use to gain access to the interior of a raceway for wire pulling, splicing (with limitations as specified by the NEC), and maintenance. This item comes with cover and gasket.



| CATALOG NO. | DESCRIPTION                          | TRADE SIZE | BODY TYPE | UOM | ORDER MULTIPLE |
|-------------|--------------------------------------|------------|-----------|-----|----------------|
| PI458       | Includes steel cover, screws, gasket | 1/2"       | Back (LB) | EA  | 1              |
| PI459       | Includes steel cover, screws, gasket | 3/4"       | Back (LB) | EA  | 1              |

**Liquid-Tite Connectors\***

These connectors are made of zinc die cast and can be used with Flexible Metal Conduits and non metallic conduits. Zinc die cast.



| CATALOG NO. | DESCRIPTION                                | TRADE SIZE | KNOCKOUT | UOM | ORDER MULTIPLE |
|-------------|--|------------|----------|-----|----------------|
| PI350       | Straight Liquid-Tite Connector, 2 per pack | 1/2"       | 1/2"     | PK  | 1              |
| PI351       | Straight Liquid-Tite Connector, 2 per pack | 3/4"       | 3/4"     | PK  | 1              |
| PI352       | 90° Liquid-Tite Connector                  | 1/2"       | 1/2"     | EA  | 1              |
| PI353       | 90° Liquid-Tite Connector                  | 3/4"       | 3/4"     | EA  | 1              |



## CABLE TIES AND ACCESSORIES

### Heavy Duty Nylon Cable Ties

Black ties are weather and UV resistant. Items in this section are Underwriters' Laboratories listed or recognized under the prime manufacturer's name.

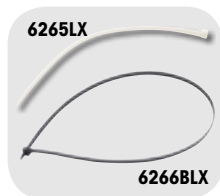

| CATALOG NO.    | DESCRIPTION                    | LENGTH | COLOR | MAX. BUNDLE DIAMETER | TENSILE STRENGTH | UOM | ORDER MULTIPLE |
|----------------|--------------------------------|--------|-------|----------------------|------------------|-----|----------------|
| <b>6265BLX</b> | Nylon; Heavy-duty, pack of 50  | 14"    | Black | 4"                   | 175 lb.          | PK  | 1              |
| <b>6265BCX</b> | Nylon; Heavy-duty, pack of 100 | 14"    | Black | 4"                   | 175 lb.          | PK  | 1              |
| <b>6266BLX</b> | Nylon; Heavy-duty, pack of 50  | 36"    | Black | 11"                  | 175 lb.          | PK  | 1              |

### Nylon Cable Ties

Black ties are weather and UV resistant. Items in this section are Underwriters' Laboratories listed or recognized under the prime manufacturer's name.



| CATALOG NO.     | DESCRIPTION                     | LENGTH | COLOR   | MAX. BUNDLE DIAMETER | TENSILE STRENGTH | UOM | ORDER MULTIPLE |
|-----------------|---------------------------------|--------|---------|----------------------|------------------|-----|----------------|
| <b>6267MX</b>   | Nylon Cable Ties, pack of 1,000 | 4"     | Natural | 13/16"               | 18 lb.           | PK  | 1              |
| <b>6261CX</b>   | Nylon Cable Ties, pack of 100   | 6"     | Natural | 1-3/8"               | 18 lb.           | PK  | 1              |
| <b>6261BCX</b>  | Nylon Cable Ties, pack of 100   | 6"     | Black   | 1-3/8"               | 18 lb.           | PK  | 1              |
| <b>6268BMX</b>  | Nylon Cable Ties, pack of 1,000 | 6"     | Black   | 1-3/8"               | 30 lb.           | PK  | 1              |
| <b>6262LX</b>   | Nylon Cable Ties, pack of 50    | 7-1/2" | Natural | 1-3/4"               | 50 lb.           | PK  | 1              |
| <b>6262CX</b>   | Nylon Cable Ties, pack of 100   | 7-1/2" | Natural | 1-3/4"               | 50 lb.           | PK  | 1              |
| <b>6262MX</b>   | Nylon Cable Ties, pack of 1,000 | 7-1/2" | Natural | 1-3/4"               | 50 lb.           | PK  | 1              |
| <b>6262BLX</b>  | Nylon Cable Ties, pack of 50    | 7-1/2" | Black   | 1-3/4"               | 50 lb.           | PK  | 1              |
| <b>6262BCX</b>  | Nylon Cable Ties, pack of 100   | 7-1/2" | Black   | 1-3/4"               | 50 lb.           | PK  | 1              |
| <b>6262BMX</b>  | Nylon Cable Ties, pack of 1,000 | 7-1/2" | Black   | 1-3/4"               | 50 lb.           | PK  | 1              |
| <b>6263NX</b>   | Nylon Cable Ties, pack of 25    | 11"    | Natural | 3"                   | 50 lb.           | PK  | 1              |
| <b>6263LX</b>   | Nylon Cable Ties, pack of 50    | 11"    | Natural | 3"                   | 50 lb.           | PK  | 1              |
| <b>6263CX</b>   | Nylon Cable Ties, pack of 100   | 11"    | Natural | 3"                   | 50 lb.           | PK  | 1              |
| <b>6263DX</b>   | Nylon Cable Ties, pack of 500   | 11"    | Natural | 3"                   | 50 lb.           | PK  | 1              |
| <b>6263BNX</b>  | Nylon Cable Ties, pack of 25    | 11"    | Black   | 3"                   | 50 lb.           | PK  | 1              |
| <b>6263BLX</b>  | Nylon Cable Ties, pack of 50    | 11"    | Black   | 3"                   | 50 lb.           | PK  | 1              |
| <b>6263BCX</b>  | Nylon Cable Ties, pack of 100   | 11"    | Black   | 3"                   | 50 lb.           | PK  | 1              |
| <b>6263BDX</b>  | Nylon Cable Ties, pack of 500   | 11"    | Black   | 3"                   | 50 lb.           | PK  | 1              |
| <b>60265LX</b>  | Nylon Cable Ties, pack of 50    | 14"    | Natural | 4"                   | 50 lb.           | PK  | 1              |
| <b>60265BLX</b> | Nylon Cable Ties, pack of 50    | 14"    | Black   | 4"                   | 50 lb.           | PK  | 1              |

### Nylon Cable Ties with Mounting Hole

Black ties are weather and UV resistant. Items in this section are Underwriters' Laboratories listed or recognized under the prime manufacturer's name.

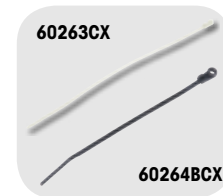

| CATALOG NO.     | DESCRIPTION                    | MOUNTING HOLE | LENGTH | COLOR   | MAX. BUNDLE DIAMETER | TENSILE STRENGTH | UOM | ORDER MULTIPLE |
|-----------------|--------------------------------|---------------|--------|---------|----------------------|------------------|-----|----------------|
| <b>60264CX</b>  | Tie w/mtg. hole, pack of 100   | #8            | 6"     | Natural | 1-3/8"               | 30 lb.           | PK  | 1              |
| <b>60264BCX</b> | Tie w/mtg. hole, pack of 100   | #8            | 6"     | Black   | 1-3/8"               | 30 lb.           | PK  | 1              |
| <b>6264LX</b>   | Tie w/mtg. hole, pack of 50    | #10           | 7"     | Natural | 1-3/4"               | 50 lb.           | PK  | 1              |
| <b>6264CX</b>   | Tie w/mtg. hole, pack of 100   | #10           | 7"     | Natural | 1-3/4"               | 50 lb.           | PK  | 1              |
| <b>6264BLX</b>  | Tie w/mtg. hole, pack of 50    | #10           | 7"     | Black   | 1-3/4"               | 50 lb.           | PK  | 1              |
| <b>6264BCX</b>  | Tie w/mtg. hole, pack of 100   | #10           | 7"     | Black   | 1-3/4"               | 50 lb.           | PK  | 1              |
| <b>6264BMX</b>  | Tie w/mtg. hole, pack of 1,000 | #10           | 7"     | Black   | 1-3/4"               | 50 lb.           | PK  | 1              |
| <b>60263CX</b>  | Tie w/mtg. hole, pack of 100   | #10           | 11"    | Natural | 3"                   | 50 lb.           | PK  | 1              |
| <b>60263BLX</b> | Tie w/mtg. hole, pack of 50    | #10           | 11"    | Black   | 3"                   | 50 lb.           | PK  | 1              |
| <b>60263BCX</b> | Tie w/mtg. hole, pack of 100   | #10           | 11"    | Black   | 3"                   | 50 lb.           | PK  | 1              |

### Black Nylon Cable Tie Assortment

Black ties are weather and UV resistant. Items in this section are Underwriters' Laboratories listed or recognized under the prime manufacturer's name.

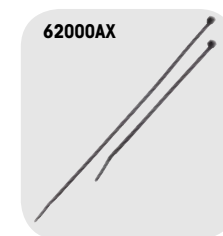

| CATALOG NO.    | DESCRIPTION | LENGTH        | COLOR          | MAX. BUNDLE DIAMETER | TENSILE STRENGTH | UOM | ORDER MULTIPLE |
|----------------|-------------|---------------|----------------|----------------------|------------------|-----|----------------|
| <b>62000AX</b> | Assortment  | 7-1/2"<br>11" | Black<br>Black | 1-3/4"<br>3"         | 50 lb.<br>50 lb. | PK  | 1              |

### Cable Tie Mounts

Approximately 1in. square adhesive backed. These mounts can be mounted with a screw and will accept up to 75 lb. ties.



| CATALOG NO.   | DESCRIPTION   | UOM | ORDER MULTIPLE |
|---------------|---|-----|----------------|
| <b>6269</b>   | Cable Tie Mounts; 1" square; adhesive backed, pack of 11    | PK  | 1              |
| <b>6269LX</b> | Cable Tie Mounts; 1" square; adhesive backed, pack of 50    | PK  | 1              |
| <b>6269CX</b> | Cable Tie Mounts; 1" square; adhesive backed, pack of 100   | PK  | 1              |
| <b>6269MX</b> | Cable Tie Mounts; 1" square; adhesive backed, pack of 1,000 | PK  | 1              |

**CONDUIT FITTINGS****Straps**

Our zinc plated steel straps are designed to hold conduit pipe.



| CATALOG NO.    | DESCRIPTION                                  | UOM | ORDER MULTIPLE |
|----------------|--|-----|----------------|
| <b>PI306</b>   | Straps fit 1/2" E.M.T. Conduit, pack of 20   | PK  | 1              |
| <b>PI306CX</b> | Straps fit 1/2" E.M.T. Conduit, pack of 100  | PK  | 1              |
| <b>PI307</b>   | Straps fit 3/4" E.M.T. Conduit, pack of 12   | PK  | 1              |
| <b>PI307CX</b> | Straps fit 3/4" E.M.T. Conduit, pack of 100  | PK  | 1              |
| <b>PI908</b>   | Straps fit 1" E.M.T. Conduit, pack of 10     | PK  | 1              |
| <b>PI908CX</b> | Straps fit 1" E.M.T. Conduit, pack of 100    | PK  | 1              |
| <b>PI909LX</b> | Straps fit 1-1/4" E.M.T. Conduit, pack of 50 | PK  | 1              |
| <b>PI206</b>   | Straps for 14-2 Romex, pack of 20            | PK  | 1              |

**Knockout Seals and Hole Plug**

| CATALOG NO.  | DESCRIPTION                                       | UOM | ORDER MULTIPLE |
|--------------|---|-----|----------------|
| <b>PI316</b> | For 1/2" knockouts, zinc plated steel, pack of 10 | PK  | 1              |
| <b>PI317</b> | For 3/4" knockouts, zinc plated steel, pack of 10 | PK  | 1              |
| <b>ED406</b> | Nylon Hole Plug for 3/8" hole, pack of 28         | PK  | 1              |

**Conduit Nipples\***

PI301 is zinc die cast steel. PI303 is galvanized steel. All come with plated steel locknuts and plastic insulating bushings.



| CATALOG NO.  | DESCRIPTION               | SIZE      | CONNECTION | UOM | ORDER MULTIPLE |
|--------------|---------------------------|-----------|------------|-----|----------------|
| <b>PI301</b> | Conduit Nipple, pack of 2 | 1/2"      | Offset     | PK  | 1              |
| <b>PI303</b> | Conduit Nipple, pack of 2 | 1/2" x 2" | Straight   | PK  | 1              |

**Electrical Staples**

We have steel, insulated copper finish, and plastic electrical staples available.



| CATALOG NO.    | DESCRIPTION  | SIZE        | UOM | ORDER MULTIPLE |
|----------------|--|-------------|-----|----------------|
| <b>PI330</b>   | Plastic; for 2 conductor Romex and other NM cable conductor; 12/2-14/2 range; UV protected, pack of 50 | 3/8" x 1/2" | PK  | 1              |
| <b>PI332</b>   | Plastic; for 3 conductor Romex and other NM cable conductor; 12/3-14/3 range; UV protected, pack of 50 | 3/8" x 3/4" | PK  | 1              |
| <b>PI309</b>   | Steel; non-insulated for Romex and NM cable; 14/2-10/3 range, pack of 154                              | 1" x 1/2"   | PK  | 1              |
| <b>ED273</b>   | Insulated coppered finish; size #5, pack of 50   | 5/8" x 1/4" | PK  | 1              |
| <b>ED273CX</b> | Insulated coppered finish; size #5, pack of 100  | 5/8" x 1/4" | PK  | 1              |

**Reducing Washers**

Reducing washers are for reducing knockout holes. These washers have raised flanges for a tight fit and are made of galvanized steel. PI308 reduces hole to fit appliance switch.



| CATALOG NO.    | DESCRIPTION   | UOM | ORDER MULTIPLE |
|----------------|---|-----|----------------|
| <b>PI304</b>   | Reducing Washer - reduces hole from 1" to 1/2", pack of 10    | PK  | 1              |
| <b>PI305</b>   | Reducing Washer - reduces hole from 1" to 3/4", pack of 10    | PK  | 1              |
| <b>PI310</b>   | Reducing Washer - reduces hole from 3/4" to 1/2", pack of 28  | PK  | 1              |
| <b>PI310LX</b> | Reducing Washer - reduces hole from 3/4" to 1/2", pack of 50  | PK  | 1              |
| <b>PI912</b>   | Reducing Washer - reduces hole from 2" to 3/4", pack of 5     | PK  | 1              |
| <b>PI912LX</b> | Reducing Washer - reduces hole from 2" to 3/4", pack of 50    | PK  | 1              |
| <b>PI913</b>   | Reducing Washer - reduces hole from 1-1/2" to 1/2", pack of 4 | PK  | 1              |
| <b>PI914</b>   | Reducing Washer - reduces hole from 1-1/2" to 3/4", pack of 4 | PK  | 1              |

**Conduit Nipples\***

Used to connect two electrical utility boxes where room is limited. Zinc die cast steel. Comes with plated steel locknuts.



| CATALOG NO.  | DESCRIPTION               | SIZE | CONNECTION | UOM | ORDER MULTIPLE |
|--------------|---------------------------|------|------------|-----|----------------|
| <b>PI203</b> | Conduit Nipple, pack of 6 | 1/2" | Straight   | PK  | 1              |

**Bushings and Locknuts**

The locknuts and bushing are straight connectors provide excellent pullout strength and can be installed without disassembly. The compression nut ratchet prevents unintentional loosening.



| CATALOG NO.  | DESCRIPTION   | UOM | ORDER MULTIPLE |
|--------------|---|-----|----------------|
| <b>PI331</b> | Plastic "Anti-Short" Bushings for 14/2, 14/3, 12/2 BX cable, pack of 35 | PK  | 1              |

## GENERAL TOOLS

### Devco Crimpers

Crimps insulated and non insulated terminals 22 to 10 AWG, cuts bolts #4 40 through #10 24, and strips stranded wire 22 to 10 AWG and solid wire 18 to 8 AWG. Features two precision ground wire cutters, one on the nose and the other behind the pivot point. Plastic cushion handle.



5002

| CATALOG NO. | DESCRIPTION                           | UOM | ORDER MULTIPLE |
|-------------|---------------------------------------|-----|----------------|
| 5002        | Devco Crimpers; plastic coated handle | EA  | 1              |

### Blind Rivet Tools

Heavy duty hand rivet tool that offers long handles to increase leverage and to secure the rivet in the nosepiece while the tool is in use. Powerful riveting capacity with 4 standard nosepieces to set 3/32", 1/8", 5/32", and 3/16" blind rivets.



5107

| CATALOG NO. | DESCRIPTION  | UOM | ORDER MULTIPLE |
|-------------|--|-----|----------------|
| 5107        | Heavy-duty tool; 4 interchangeable nose pieces to accommodate 3/32", 1/8", 5/32", 3/16" steel or aluminum rivets | EA  | 1              |

### Magnetic Hex Chucks

Magnetic Hex Chucks may be used with an electric drill to drive hex washer head screws.



DE15

| CATALOG NO. | DESCRIPTION        | HEX HEAD SIZE | HEX HEAD DIAMETER | LENGTH  | UOM | ORDER MULTIPLE |
|-------------|--------------------|---------------|-------------------|---------|-----|----------------|
| DE13        | Magnetic Hex Chuck | 1/4"          | 7/16"             | 1-3/4"  | EA  | 1              |
| DE14        | Magnetic Hex Chuck | 5/16"         | 1/2"              | 1-3/4"  | EA  | 1              |
| DE15        | Magnetic Hex Chuck | 3/8"          | 9/16"             | 1-7/8"  | EA  | 1              |
| DE23        | Magnetic Hex Chuck | 1/4"          | 7/16"             | 2-9/16" | EA  | 1              |
| DE24        | Magnetic Hex Chuck | 5/16"         | 1/2"              | 2-9/16" | EA  | 1              |
| DE33**      | Magnetic Hex Chuck | 1/4"          | 7/16"             | 3"      | EA  | 1              |

\*\*Magnetic insert bit holder with a "C" ring retainer

## NUTS AND BOLTS

### Finished Hex Nuts

The hex nuts are zinc plated steel.



6501

| CATALOG NO. | DESCRIPTION                    | SIZE       | UOM | ORDER MULTIPLE |
|-------------|--------------------------------|------------|-----|----------------|
| 6501        | Finished Hex Nuts, pack of 60  | 1/4" - 20  | PK  | 1              |
| 6501CX      | Finished Hex Nuts, pack of 100 | 1/4" - 20  | PK  | 1              |
| 6502        | Finished Hex Nuts, pack of 38  | 5/16" - 18 | PK  | 1              |
| 6503        | Finished Hex Nuts, pack of 25  | 3/8" - 16  | PK  | 1              |
| 6503CX      | Finished Hex Nuts, pack of 100 | 3/8" - 16  | PK  | 1              |
| 6505        | Finished Hex Nuts, pack of 11  | 1/2" - 13  | PK  | 1              |
| 6505LX      | Finished Hex Nuts, pack of 50  | 1/2" - 13  | PK  | 1              |

### Machine Screw Hex Nuts

The hex nuts are zinc plated steel.



6526

| CATALOG NO. | DESCRIPTION                        | SIZE                 | UOM | ORDER MULTIPLE |
|-------------|------------------------------------|----------------------|-----|----------------|
| 6526        | Machine Screw Hex Nuts, pack of 49 | #8 - 32              | PK  | 1              |
| 6528        | Machine Screw Hex Nuts, pack of 44 | #10 - 24             | PK  | 1              |
| 6500A       | Assortment, 23 of each             | #6-32, #8-32, #10-32 | EA  | 1              |

### Toggle Bolts

The toggle bolts are slotted round head machine screws with spring wings and are made of zinc plated steel.

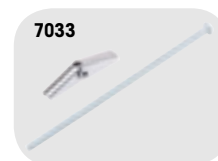

7033

| CATALOG NO. | DESCRIPTION             | LENGTH | BOLT SIZE | HOLE SIZE | UOM | ORDER MULTIPLE |
|-------------|-------------------------|--------|-----------|-----------|-----|----------------|
| 7033        | Toggle Bolts, pack of 6 | 4"     | 3/16"     | 1/2"      | PK  | 1              |
| 7034        | Toggle Bolts, pack of 5 | 4"     | 1/4"      | 5/8"      | PK  | 1              |
| 7036X       | Toggle Bolts, pack of 4 | 4"     | 3/8"      | 1"        | PK  | 1              |
| 7066X       | Toggle Bolts, pack of 4 | 6"     | 3/8"      | 1"        | PK  | 1              |



**NUTS AND BOLTS cont'd****Stove Bolts**

Stove Bolts are a combination of slotted round head machine screws and finished hex nuts. They are made of zinc plated steel.



| CATALOG NO. | DESCRIPTION             | SIZE      | LENGTH | UOM | ORDER MULTIPLE |
|-------------|-------------------------|-----------|--------|-----|----------------|
| 6401        | Stove Bolts, pack of 42 | #10 - 24  | 1/2"   | PK  | 1              |
| 6402        | Stove Bolts, pack of 38 | #10 - 24  | 3/4"   | PK  | 1              |
| 6403        | Stove Bolts, pack of 34 | #10 - 24  | 1"     | PK  | 1              |
| 6404        | Stove Bolts, pack of 27 | #10 - 24  | 1-1/2" | PK  | 1              |
| 6411        | Stove Bolts, pack of 22 | 1/4" - 20 | 1/2"   | PK  | 1              |
| 6412        | Stove Bolts, pack of 20 | 1/4" - 20 | 3/4"   | PK  | 1              |
| 6413        | Stove Bolts, pack of 18 | 1/4" - 20 | 1"     | PK  | 1              |
| 6414        | Stove Bolts, pack of 15 | 1/4" - 20 | 1-1/2" | PK  | 1              |
| 6415        | Stove Bolts, pack of 13 | 1/4" - 20 | 2"     | PK  | 1              |
| 6416        | Stove Bolts, pack of 11 | 1/4" - 20 | 2-1/2" | PK  | 1              |

**Flat Washers**

These washers are zinc plated steel with a USS Classification.

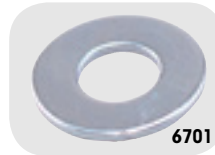

| CATALOG NO. | DESCRIPTION                     | SIZE               | INNER DIAMETER | OUTER DIAMETER | UOM | ORDER MULTIPLE |
|-------------|---------------------------------|--------------------|----------------|----------------|-----|----------------|
| 6701        | Flat Washers (USS), pack of 160 | 3/16"              | 1/4"           | 9/16"          | PK  | 1              |
| 6702        | Flat Washers (USS), pack of 72  | 1/4"               | 5/16"          | 3/4"           | PK  | 1              |
| 6703        | Flat Washers (USS), pack of 33  | 5/16"              | 3/8"           | 7/8"           | PK  | 1              |
| 6704        | Flat Washers (USS), pack of 37  | 3/8"               | 7/16"          | 1"             | PK  | 1              |
| 6704-2X     | Flat Washers (USS), pack of 134 | 3/8"               | 7/16"          | 1"             | PK  | 1              |
| 6706        | Flat Washers (USS), pack of 11  | 1/2"               | 9/16"          | 1-3/8"         | PK  | 1              |
| 6706-2X     | Flat Washers (USS), pack of 52  | 1/2"               | 9/16"          | 1-3/8"         | PK  | 1              |
| 6700AX      | Assortment                      | All sizes included |                |                | EA  | 1              |

**Fender Washers**

These washers are made of zinc plated steel.

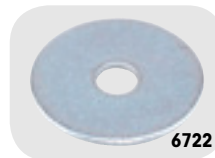

| CATALOG NO. | DESCRIPTION                | SIZE | INNER DIAMETER | OUTER DIAMETER | UOM | ORDER MULTIPLE |
|-------------|----------------------------|------|----------------|----------------|-----|----------------|
| 6722        | Fender Washers, pack of 20 | 1/4" | 9/32"          | 1-1/4"         | PK  | 1              |
| 6722-2X     | Fender Washers, pack of 92 | 1/4" | 9/32"          | 1-1/4"         | PK  | 1              |
| 6724        | Fender Washers, pack of 12 | 3/8" | 13/32"         | 1-1/2"         | PK  | 1              |
| 6724-2X     | Fender Washers, pack of 66 | 3/8" | 13/32"         | 1-1/2"         | PK  | 1              |

**Motor Bolts**

Motor Bolts are all thread rods made of zinc metal steel. Each Bolt includes four machine screw hex nuts.



| CATALOG NO. | DESCRIPTION             | SIZE     | LENGTH | UOM | ORDER MULTIPLE |
|-------------|-------------------------|----------|--------|-----|----------------|
| 6108        | Motor Bolts, pack of 16 | #8 - 32  | 1-1/2" | PK  | 1              |
| 6109        | Motor Bolts, pack of 16 | #10 - 32 | 1-1/2" | PK  | 1              |

**Hex Head Cap Screws**

Hex Screw Cap Screws are made of low carbon, grade 2 steel and are USS Classified. The total thread length on these screws equal 2x diameter + 1/4in.



| CATALOG NO. | DESCRIPTION                     | SIZE       | LENGTH | UOM | ORDER MULTIPLE |
|-------------|---------------------------------|------------|--------|-----|----------------|
| 6601        | Hex Head Cap Screws, pack of 28 | 1/4" - 20  | 3/4"   | PK  | 1              |
| 6602        | Hex Head Cap Screws, pack of 25 | 1/4" - 20  | 1"     | PK  | 1              |
| 6603        | Hex Head Cap Screws, pack of 18 | 1/4" - 20  | 1-1/2" | PK  | 1              |
| 6622        | Hex Head Cap Screws, pack of 15 | 5/16" - 18 | 1"     | PK  | 1              |
| 6623        | Hex Head Cap Screws, pack of 12 | 5/16" - 18 | 1-1/2" | PK  | 1              |
| 6641        | Hex Head Cap Screws, pack of 14 | 3/8" - 16  | 3/4"   | PK  | 1              |
| 6642        | Hex Head Cap Screws, pack of 12 | 3/8" - 16  | 1"     | PK  | 1              |
| 6643        | Hex Head Cap Screws, pack of 8  | 3/8" - 16  | 1-1/2" | PK  | 1              |
| 6644        | Hex Head Cap Screws, pack of 7  | 3/8" - 16  | 2"     | PK  | 1              |
| 6645        | Hex Head Cap Screws, pack of 5  | 3/8" - 16  | 2-1/2" | PK  | 1              |
| 6685        | Hex Head Cap Screws, pack of 3  | 1/2" - 13  | 2-1/2" | PK  | 1              |
| 6683        | Hex Head Cap Screws, pack of 5  | 1/2" - 13  | 1-1/2" | PK  | 1              |

**Medium Split Lock Washers**

Spring type. These washers are made of zinc plated steel.



| CATALOG NO. | DESCRIPTION                           | SIZE  | UOM | ORDER MULTIPLE |
|-------------|---------------------------------------|-------|-----|----------------|
| 6730        | Medium Split Lock Washers, pack of 95 | 3/16" | PK  | 1              |
| 6731        | Medium Split Lock Washers, pack of 72 | 1/4"  | PK  | 1              |
| 6732        | Medium Split Lock Washers, pack of 59 | 5/16" | PK  | 1              |
| 6733        | Medium Split Lock Washers, pack of 38 | 3/8"  | PK  | 1              |
| 6735        | Medium Split Lock Washers, pack of 18 | 1/2"  | PK  | 1              |

## POWER CORDS AND WORK LIGHTS

### Round Extension Cords\*

Comes in bright orange or yellow, depending upon availability.



| CATALOG NO. | DESCRIPTION          | WIRE | LENGTH | RATING   | UOM | ORDER MULTIPLE |
|-------------|----------------------|------|--------|----------|-----|----------------|
| <b>5225</b> | Round Extension Cord | 16/3 | 25'    | 13A/125V | EA  | 1              |
| <b>5230</b> | Round Extension Cord | 14/3 | 100'   | 13A/125V | EA  | 1              |

### Trouble Lights\*

These all weather lights are extra flexible with metal guards.



| CATALOG NO. | DESCRIPTION   | WIRE | CORD LENGTH | RATING   | UOM | ORDER MULTIPLE |
|-------------|---------------|------|-------------|----------|-----|----------------|
| <b>5200</b> | Trouble Light | 16/3 | 25'         | 13A/125V | EA  | 1              |
| <b>5201</b> | Trouble Light | 16/3 | 50'         | 13A/125V | EA  | 1              |

## SCREWS

### Combo Head Sheet Metal Screws

These screws are used on sheet metal items.



| CATALOG NO. | DESCRIPTION                   | LENGTH | SCREW SIZE | UOM | ORDER MULTIPLE |
|-------------|-------------------------------|--------|------------|-----|----------------|
| <b>6853</b> | Combo Head Screws, pack of 48 | 1/2"   | #10        | PK  | 1              |
| <b>6855</b> | Combo Head Screws, pack of 46 | 3/4"   | #10        | PK  | 1              |
| <b>6858</b> | Combo Head Screws, pack of 26 | 1-1/2" | #10        | PK  | 1              |
| <b>6859</b> | Combo Head Screws, pack of 19 | 2"     | #10        | PK  | 1              |
| <b>6865</b> | Combo Head Screws, pack of 32 | 3/4"   | #12        | PK  | 1              |
| <b>6866</b> | Combo Head Screws, pack of 26 | 1"     | #12        | PK  | 1              |
| <b>6868</b> | Combo Head Screws, pack of 18 | 1-1/2" | #12        | PK  | 1              |
| <b>6876</b> | Combo Head Screws, pack of 20 | 1"     | #14        | PK  | 1              |
| <b>6878</b> | Combo Head Screws, pack of 15 | 1-1/2" | #14        | PK  | 1              |

### Sheet Metal Screw Assortments

6800BX and 6800HX come in a four compartment, clear plastic box.



| CATALOG NO.   | DESCRIPTION   | UOM | ORDER MULTIPLE |
|---------------|---|-----|----------------|
| <b>6800HX</b> | Slotted Hex Washer Head Screws: #6 x 3/8", #8 x 1/2", #8 x 3/4", #10 x 3/4", #10 x 1" | EA  | 1              |

### Self-Drilling Screw Repair Kit

These screws are used for replacements in striped holes.



| CATALOG NO.   | DESCRIPTION  | UOM | ORDER MULTIPLE |
|---------------|--|-----|----------------|
| <b>6900AX</b> | Contains: #12 x 3/4", #12 x 1", #14 x 3/4", #14 x 1" | EA  | 1              |

### Self-Drilling Screws

Zinc plated steel. Self drilling screws drill and tap holes in one step. Hex washer heads. #8 and #10 screws are designed for use with material thickness of .035" to .110"; #12 and #14 screws are designed for use with .110" to .220" material thickness.



| CATALOG NO.   | DESCRIPTION   | UOM | ORDER MULTIPLE |
|---------------|---|-----|----------------|
| <b>6943CX</b> | Hex Head Self Drilling Screw, 1/4in. Head #8 x 1/2in., 100 pcs        | EA  | 1              |
| <b>6945CX</b> | Hex Head Self Drilling Screw, Zinc Plated, #8 x 3/4in., 100 pcs       | EA  | 1              |
| <b>6946CX</b> | Hex Head Self Drilling Screw, 1/4in. Head #8 x 1in, 100 pcs           | EA  | 1              |
| <b>6953CX</b> | Hex Washer Head Self Drilling Screws 5/16in. Head #10 x 1/2in 100 pcs | EA  | 1              |
| <b>6955CX</b> | Hex Head Self Drilling Screw, 5/16in. Head #10 x 3/4in., 100 pcs      | EA  | 1              |
| <b>6956CX</b> | Hex Washer Head Self Drilling Screws 5/16in. Head #10 x 1in 100 pcs   | EA  | 1              |

\*Items in this section are Underwriter's Laboratories listed or recognized under the prime manufacturer's name.



## SPECIALTY FASTENERS

## Nylon Cable Clamps

These cable clamps are perfect for securing wire or pipes.



| CATALOG NO. | DESCRIPTION                    | FITS PIPE OUTER DIAMETER | THICKNESS | WIDTH | UOM | ORDER MULTIPLE |
|-------------|--------------------------------|--------------------------|-----------|-------|-----|----------------|
| 5381        | Nylon Cable Clamps, pack of 54 | 1/8"                     | .050"     | 3/8"  | PK  | 1              |
| 5382        | Nylon Cable Clamps, pack of 48 | 1/4"                     | .050"     | 3/8"  | PK  | 1              |
| 5383        | Nylon Cable Clamps, pack of 41 | 3/8"                     | .050"     | 3/8"  | PK  | 1              |
| 5384        | Nylon Cable Clamps, pack of 35 | 1/2"                     | .050"     | 3/8"  | PK  | 1              |
| 5385        | Nylon Cable Clamps, pack of 21 | 5/8"                     | .060"     | 1/2"  | PK  | 1              |
| 5380AX      | Assortment                     | 1/8" - 1"                |           |       | EA  | 1              |

## Pipe Hanging Strap

Non plated Steel Pipe hanging Strap is perfect for hanging pipes, fastening faucets and valves, as well as repair jobs.



| CATALOG NO. | DESCRIPTION                      | SIZE       | UOM | ORDER MULTIPLE |
|-------------|----------------------------------|------------|-----|----------------|
| PI335       | Pipe Hanging Strap, 28 gauge AWG | 3/4" x 10' | EA  | 1              |

## Cotter Pins

Cotter Pins provide smooth locking between two parts. This set includes an assortment of regular Cotter Pins with extended prongs.



| CATALOG NO. | DESCRIPTION  | UOM | ORDER MULTIPLE |
|-------------|--|-----|----------------|
| 6011        | Cotter Pins: 1/16" x 1-1/2"; 3/32" x 1-1/2"; 1/8" x 1-1/2", pack of 51 | PK  | 1              |

## Motor Shaft Key Assortments

You can use choose from either a large assortment or a small assortment. The keys are made of cold rolled 1018 steel and are zinc plated.



| CATALOG NO. | DESCRIPTION   | UOM | ORDER MULTIPLE |
|-------------|---|-----|----------------|
| 6101        | Small Assortment includes: 1/8" x 1/8" x 1-3/16"; 3/16" x 3/16" x 1-3/16"; 3/16" x 1/4" x 1-3/16"; 1/4" x 1/4" x 1-3/4" | EA  | 1              |
| 6102        | Large Assortment includes: 1/4" x 1/4" x 1-3/4"; 5/16" x 5/16" x 3"; 3/8" x 3/8" x 3"                                   | EA  | 1              |

## Hose Clamps

Hose Clamps have stainless steel housings and bands. The screws are plated steel and have slotted hex heads allowing a socket wrench, nut driver, or screwdriver to be used.



| CATALOG NO. | DESCRIPTION             | SAE NO. | SAE DIAMETER RANGE (in.) | APPROX. RANGE (in.) | UOM | ORDER MULTIPLE |
|-------------|-------------------------|---------|--------------------------|---------------------|-----|----------------|
| HC6202      | Hose Clamps, pack of 6  | *       | N/A                      | 1/4 to 5/8          | PK  | 1              |
| HC6203      | Hose Clamps, pack of 6  | 6       | .44 - .78                | 5/16 to 7/8         | PK  | 1              |
| HC5410      | Hose Clamps, pack of 6  | 10      | .56 - 1.06               | 9/16 to 1-1/8       | PK  | 1              |
| HC5410X     | Hose Clamps, pack of 10 | 10      | .56 - 1.06               | 9/16 to 1-1/8       | PK  | 1              |
| HC5416      | Hose Clamps, pack of 6  | 16      | .81 - 1.50               | 3/4 to 1-1/2        | PK  | 1              |
| HC5416X     | Hose Clamps, pack of 10 | 16      | .81 - 1.50               | 3/4 to 1-1/2        | PK  | 1              |
| HC5420      | Hose Clamps, pack of 6  | 20      | .81 - 1.75               | 13/16 to 1-3/4      | PK  | 1              |
| HC5424      | Hose Clamps, pack of 6  | 24      | 1.06 - 2.00              | 1-1/16 to 2         | PK  | 1              |
| HC5436      | Hose Clamps, pack of 4  | 36      | 1.81 - 2.75              | 1-1/2 to 2-3/4      | PK  | 1              |
| HC5436X     | Hose Clamps, pack of 10 | 36      | 1.81 - 2.75              | 1-1/2 to 2-3/4      | PK  | 1              |

## Nylon Rods

These nylon rods can be used with load bearing capability. Used for smaller machined parts, such as electrical insulators and food contact parts.

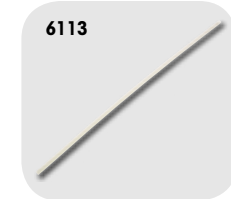

| CATALOG NO. | DESCRIPTION                       | DIAMETER | THREADS (in.) | LENGTH | UOM | ORDER MULTIPLE |
|-------------|-----------------------------------|----------|---------------|--------|-----|----------------|
| 6113        | Nylon Rods; All-Thread, pack of 4 | 3/8"     | 16            | 2'     | PK  | 1              |

## Set Screws

Set Screws have cup points and hex socket heads. Class 3A threads. Made of heat treated alloy steel.



| CATALOG NO. | DESCRIPTION                     | SIZE                       | UOM | ORDER MULTIPLE |
|-------------|---------------------------------|----------------------------|-----|----------------|
| 6002        | Set Screws, pack of 33          | #8-32 x 3/16"              | PK  | 1              |
| 6003        | Set Screws, pack of 25          | #10-32 x 3/16"             | PK  | 1              |
| 6004        | Set Screws, pack of 27          | 1/4"-28 x 1/4"             | PK  | 1              |
| 6006        | Set Screws, pack of 19          | 5/16"-18 x 5/16"           | PK  | 1              |
| 6007        | Set Screws, pack of 14          | 3/8"-16 x 3/8"             | PK  | 1              |
| 6000        | Large Assortment; course thread | 1/4"-20; 5/16"-18; 3/8"-16 | EA  | 1              |
| 6001        | Small Assortment; fine thread   | #8-32; #10-32; 1/4"-28     | EA  | 1              |



## SPECIALTY FITTINGS

### Grease Fittings

Case hardened steel fittings plated with yellow dip chromate and built-in ball checks. Assortment available in clear plastic box.

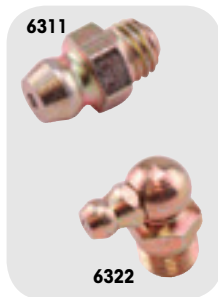

| CATALOG NO.  | DESCRIPTION  | UOM | ORDER MULTIPLE |
|--------------|--|-----|----------------|
| <b>6311</b>  | Grease Fittings: 1/4"-28 Tapered Thread; straight, pack of 8 | PK  | 1              |
| <b>6312</b>  | Grease Fittings: 1/8" Pipe Thread; straight, pack of 5       | PK  | 1              |
| <b>6321</b>  | Grease Fittings: 1/4"-28 Tapered Thread; 90°, pack of 3      | PK  | 1              |
| <b>6322</b>  | Grease Fittings: 1/8" Pipe Thread; 90°, pack of 3            | PK  | 1              |
| <b>6310X</b> | Assortment includes: 6311, 6312, 6321, 6322                  | EA  | 1              |

## STORAGE CONTAINERS

### Metal Parts Boxes

Metal Parts Boxes are prime cold rolled steel with baked gray enamel finish. The finish is rust and acid resistant. Each box comes with high impact plastic tray, positive pull down catch, and stick back parts labels for lid interiors.



| CATALOG NO.  | DESCRIPTION     | NO. OF COMPARTMENTS | DIMENSIONS (L x W x D) | UOM | ORDER MULTIPLE |
|--------------|-----------------|---------------------|------------------------|-----|----------------|
| <b>8200M</b> | Metal Parts Box | 21                  | 13-3/8" x 9-1/4" x 2"  | EA  | 1              |
| <b>8220M</b> | Metal Parts Box | 24                  | 18" x 12" x 3"         | EA  | 1              |

### Satchel Style Case

Parts box made from rugged copolymer material with high impact translucent lid and handle on the side. 15 removable dividers allow up to 24 compartments.



| CATALOG NO. | DESCRIPTION        | NO. OF COMPARTMENTS | DIMENSIONS (L x W x D) | UOM | ORDER MULTIPLE |
|-------------|--------------------|---------------------|------------------------|-----|----------------|
| <b>8233</b> | Satchel Style Case | Up to 24            | 15" x 11-3/4" x 2-1/2" | EA  | 1              |

### Styrene Parts Boxes

This box is ideal for holding your different sized nuts and bolts along with your additional bits. It can be stored in a tool box as well.



| CATALOG NO. | DESCRIPTION       | COLOR | NO. OF COMPARTMENTS | DIMENSIONS (L x W x D)   | UOM | ORDER MULTIPLE |
|-------------|-------------------|-------|---------------------|--------------------------|-----|----------------|
| <b>8207</b> | Styrene Parts Box | Clear | 4                   | 4-7/8" x 3-1/4" x 1-1/8" | EA  | 1              |
| <b>8208</b> | Styrene Parts Box | Clear | 6                   | 4-7/8" x 3-1/4" x 1-1/8" | EA  | 1              |

### Polypropylene Parts Boxes

This box is ideal for holding your different sized nuts and bolts along with your additional bits. It can be stored in a tool box as well.

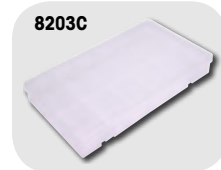

| CATALOG NO.  | DESCRIPTION                         | COLOR  | NO. OF COMPARTMENTS | DIMENSIONS (L x W x D) | UOM | ORDER MULTIPLE |
|--------------|-------------------------------------|--------|---------------------|------------------------|-----|----------------|
| <b>8201</b>  | Polypropylene Parts Box             | Yellow | 13                  | 11" x 6-3/4" x 1-1/4"  | EA  | 1              |
| <b>8201C</b> | Polypropylene Parts Box Translucent |        | 13                  | 11" x 6-3/4" x 1-1/4"  | EA  | 1              |
| <b>8202</b>  | Polypropylene Parts Box             | Yellow | 18                  | 11" x 6-3/4" x 1-1/4"  | EA  | 1              |
| <b>8203</b>  | Polypropylene Parts Box             | Yellow | 24                  | 11" x 6-3/4" x 1-1/4"  | EA  | 1              |
| <b>8203C</b> | Polypropylene Parts Box Translucent |        | 24                  | 13-1/8" x 9" x 2-5/8"  | EA  | 1              |

## TAPES

### Tape

Vinyl electrical tape. Part 5247 holds up to 7 pounds per square inch when attached to steel surface.



| CATALOG NO. | DESCRIPTION           | LENGTH     | UOM | ORDER MULTIPLE |
|-------------|-----------------------|------------|-----|----------------|
| <b>5255</b> | Vinyl Electrical Tape | 3/4" x 60' | EA  | 1              |

### Teflon® Tape

This PTFE Tape is made of non toxic, pure white PTFE. The tape can be used with chemicals, solvents, oxygen, and on food lines. The product can withstand up to 2000 psi of pressure.



| CATALOG NO. | DESCRIPTION              | LENGTH      | UOM | ORDER MULTIPLE |
|-------------|--------------------------|-------------|-----|----------------|
| <b>5246</b> | Teflon® Thread Seal Tape | 1/2" x 520" | EA  | 1              |



## TESTERS, LEADS, CLIPS, FUSES

### Clips

The clips are alligator clips and have vinyl red and black insulators.



| CATALOG NO. | DESCRIPTION  | UOM | ORDER MULTIPLE |
|-------------|--|-----|----------------|
| <b>5033</b> | Steel Alligator Clips for use with test probes (.075"-.080"); 1-31/32" long; jaws open 5/16" max.; pack of 2 red, 2 black, 4 clips | PK  | 1              |
| <b>5035</b> | Copper Alligator Clips; 1-31/32" long; jaws open 5/16" max.; crimper slotted screw connection, pack of 2 red, 2 black, 4 clips     | PK  | 1              |
| <b>5036</b> | Steel Test Clips; 20A, 2-7/16" long; jaws open 5/8" max.; crimper slotted screw connection, pack of 1 red, 1 black, 2 clips        | PK  | 1              |

### Blade (Auto) Fuses

These fuses are used to protect circuits in the wiring harness that are usually found under the hood, in a fuse panel or supplementary panel near the battery. MAX fuses are used in domestic and import vehicles.

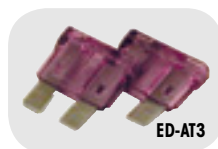

| CATALOG NO.   | DESCRIPTION                             | UOM | ORDER MULTIPLE |
|---------------|---|-----|----------------|
| <b>ED-AT3</b> | Blade Fuse – 3 Amp – Purple, pack of 10 | PK  | 1              |
| <b>ED-AT5</b> | Blade Fuse – 5 Amp – Tan, pack of 10    | PK  | 1              |

### Test Leads

These are replacement leads.



| CATALOG NO. | DESCRIPTION   | UOM | ORDER MULTIPLE |
|-------------|---|-----|----------------|
| <b>5031</b> | Low Voltage Test Leads; eight 22" long, color-coded leads with fully insulated alligator clips                            | EA  | 1              |
| <b>5041</b> | Small Hook Type Low Voltage Test Leads; retractable hooks, 36" thermoplastic 22 gauge wire, nylon body/plunger, red/black | EA  | 1              |
| <b>5042</b> | Large Hook Type Low Voltage Test Leads; retractable hooks, 36" PVC insulated 20 gauge wire, nylon body/plunger, red/black | EA  | 1              |
| <b>5046</b> | Flexible Test Leads; steel alligator clips with vinyl red and black insulators; 36" 20 gauge wire; extremely flexible     | EA  | 1              |

### Dual Element Fuses – 250V

Provides time delay for temporary over-current conditions and motor running protection for heating and air conditioning equipment. Eliminates unnecessary maintenance from harmless overloads.



| CATALOG NO.    | DESCRIPTION                            | UOM | ORDER MULTIPLE |
|----------------|--|-----|----------------|
| <b>ED-CR15</b> | Dual Element Fuse – 15 Amps, pack of 2 | PK  | 1              |
| <b>ED-CR20</b> | Dual Element Fuse – 20 Amps, pack of 2 | PK  | 1              |
| <b>ED-CR25</b> | Dual Element Fuse – 25 Amps, pack of 2 | PK  | 1              |
| <b>ED-CR30</b> | Dual Element Fuse – 30 Amps, pack of 2 | PK  | 1              |
| <b>ED-CR35</b> | Dual Element Fuse – 35 Amps, pack of 2 | PK  | 1              |
| <b>ED-CR40</b> | Dual Element Fuse – 40 Amps, pack of 2 | PK  | 1              |
| <b>ED-CR45</b> | Dual Element Fuse – 45 Amps, pack of 2 | PK  | 1              |
| <b>ED-CR50</b> | Dual Element Fuse – 50 Amps, pack of 2 | PK  | 1              |
| <b>ED-CR60</b> | Dual Element Fuse – 60 Amps, pack of 2 | PK  | 1              |

U.L. Class RK-5, Standard for Safety 198E, Current Limiting Fuses, Interrupting Rating 200,000 Amps. rms. A.C.

## WIRE

### TFFN Stranded Hook-Up Wire\*

Packaged in handy dispenser bag. Polyvinyl chloride insulation. Wire rating: 600V, 90°C. Insulation: oil resistant nylon coating.

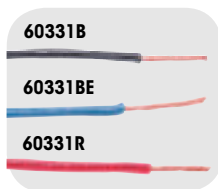

| CATALOG NO.    | COLOR              | GAUGE | STRANDS | O.D. | LENGTH | UOM | ORDER MULTIPLE |
|----------------|--------------------|-------|---------|------|--------|-----|----------------|
| <b>60331B</b>  | Black, pack of 50' | 18    | 16      | .09" | 48'    | PK  | 1              |
| <b>60331BE</b> | Blue, pack of 50'  | 18    | 16      | .09" | 48'    | PK  | 1              |
| <b>60331R</b>  | Red, pack of 50'   | 18    | 16      | .09" | 48'    | PK  | 1              |
| <b>6332B</b>   | Black, pack of 50' | 16    | 26      | .10" | 48'    | PK  | 1              |
| <b>6332G</b>   | Green, pack of 50' | 16    | 26      | .10" | 48'    | PK  | 1              |
| <b>6332R</b>   | Red, pack of 50'   | 16    | 26      | .10" | 48'    | PK  | 1              |
| <b>6332W</b>   | White, pack of 50' | 16    | 26      | .10" | 48'    | PK  | 1              |

### THHN Stranded Hook-Up Wire\*

Packaged in handy dispenser bag. Polyvinyl chloride insulation. Wire rating: 600V, 90°C. Insulation: oil resistant nylon coating.

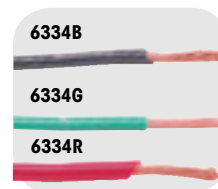

| CATALOG NO.  | COLOR              | GAUGE | STRANDS | O.D. | LENGTH | UOM | ORDER MULTIPLE |
|--------------|--------------------|-------|---------|------|--------|-----|----------------|
| <b>6333B</b> | Black, pack of 50' | 14    | 19      | .11" | 48'    | PK  | 1              |
| <b>6333G</b> | Green, pack of 50' | 14    | 19      | .11" | 48'    | PK  | 1              |
| <b>6333R</b> | Red, pack of 50'   | 14    | 19      | .11" | 48'    | PK  | 1              |
| <b>6333W</b> | White, pack of 50' | 14    | 19      | .11" | 48'    | PK  | 1              |
| <b>6334B</b> | Black, pack of 50' | 12    | 19      | .13" | 48'    | PK  | 1              |
| <b>6334G</b> | Green, pack of 50' | 12    | 19      | .13" | 48'    | PK  | 1              |
| <b>6334R</b> | Red, pack of 50'   | 12    | 19      | .13" | 48'    | PK  | 1              |
| <b>6334W</b> | White, pack of 50' | 12    | 19      | .13" | 48'    | PK  | 1              |
| <b>6335B</b> | Black, pack of 50' | 10    | 19      | .17" | 48'    | PK  | 1              |
| <b>6335G</b> | Green, pack of 50' | 10    | 19      | .17" | 48'    | PK  | 1              |
| <b>6335R</b> | Red, pack of 50'   | 10    | 19      | .17" | 48'    | PK  | 1              |
| <b>6335W</b> | White, pack of 50' | 10    | 19      | .17" | 48'    | PK  | 1              |
| <b>6360B</b> | Black, pack of 50' | 8     | 19      | .22" | 25'    | PK  | 1              |
| <b>6360R</b> | Red, pack of 50'   | 8     | 19      | .22" | 25'    | PK  | 1              |
| <b>6360W</b> | White, pack of 50' | 8     | 19      | .22" | 25'    | PK  | 1              |

## WIRE cont'd

### Thermostat Wire\*

Thermoplastic insulated, jacketed wire for low voltage applications. Conductors are solid copper, individually insulated and color coded.



| CATALOG NO. | DESCRIPTION                  | CONDUCTORS | WIRE GAUGE | LENGTH | UOM | ORDER MULTIPLE |
|-------------|------------------------------|------------|------------|--------|-----|----------------|
| 6331        | Thermostat Wire, pack of 40' | 2          | 20         | 40'    | PK  | 1              |
| 6336        | Thermostat Wire, pack of 40' | 3          | 20         | 40'    | PK  | 1              |
| 6330-4      | Thermostat Wire, pack of 40' | 4          | 20         | 40'    | PK  | 1              |
| 6337        | Thermostat Wire, pack of 40' | 5          | 20         | 40'    | PK  | 1              |
| 6330-6      | Thermostat Wire, pack of 40' | 6          | 20         | 40'    | PK  | 1              |
| 6338        | Thermostat Wire, pack of 40' | 8          | 20         | 40'    | PK  | 1              |
| 6339        | Thermostat Wire, pack of 25' | 10         | 20         | 25'    | PK  | 1              |
| 6339XL      | Thermostat Wire, pack of 40' | 10         | 20         | 40'    | PK  | 1              |

### High Temperature Range Wire\*

200°C glass braided, three conductor twisted wire. 600V; silicone rubber insulated. This product also contains a crimper.



| CATALOG NO. | COLOR                              | WIRE GAUGE | LENGTH | UOM | ORDER MULTIPLE |
|-------------|------------------------------------|------------|--------|-----|----------------|
| 6383-35     | Black, Red, and White, pack of 5'  | 14         | 5'     | PK  | 1              |
| 6383-325    | Black, Red, and White, pack of 25' | 14         | 25'    | PK  | 1              |
| 6384-35     | Black, Red, and White, pack of 5'  | 12         | 5'     | PK  | 1              |
| 6384-325    | Black, Red, and White, pack of 25' | 12         | 25'    | PK  | 1              |

### SJTO Service Cord\*

Features stranded bare copper, PVC insulation; PVC jacket. Cord is oil resistant. Cords have 3 individually insulated conductors. Ratings: 300V; 60°C.

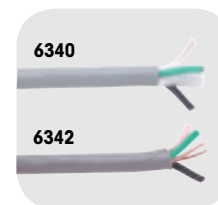

| CATALOG NO. | DESCRIPTION                    | WIRE GAUGE | LENGTH | UOM | ORDER MULTIPLE |
|-------------|--------------------------------|------------|--------|-----|----------------|
| 6340        | SJTO Service Cord, pack of 12' | 16         | 12'    | PK  | 1              |
| 6341        | SJTO Service Cord, pack of 20' | 16         | 20'    | PK  | 1              |
| 6342        | SJTO Service Cord, pack of 12' | 14         | 12'    | PK  | 1              |
| 6343        | SJTO Service Cord, pack of 20' | 14         | 20'    | PK  | 1              |

### Stranded High Temperature Wire\*

Thermoplastic equipment insulated wire. CSA listed at 105°C; 600V. Insulation thickness: .03". MTW/AWM/TEW

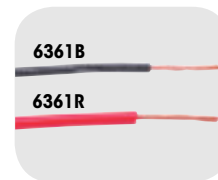

| CATALOG NO. | COLOR              | GAUGE | STRANDS | O.D.  | LENGTH | UOM | ORDER MULTIPLE |
|-------------|--------------------|-------|---------|-------|--------|-----|----------------|
| 6361B       | Black, pack of 48' | 18    | 16      | .113" | 48'    | PK  | 1              |
| 6361R       | Red, pack of 48'   | 18    | 16      | .113" | 48'    | PK  | 1              |
| 6362B       | Black, pack of 48' | 16    | 26      | .125" | 48'    | PK  | 1              |
| 6362R       | Red, pack of 48'   | 16    | 26      | .125" | 48'    | PK  | 1              |
| 6362W       | White, pack of 48' | 16    | 26      | .125" | 48'    | PK  | 1              |
| 6363B       | Black, pack of 48' | 14    | 19      | .139" | 48'    | PK  | 1              |
| 6363R       | Red, pack of 48'   | 14    | 19      | .139" | 48'    | PK  | 1              |
| 6363W       | White, pack of 48' | 14    | 19      | .139" | 48'    | PK  | 1              |
| 6364B       | Black, pack of 48' | 12    | 19      | .158" | 48'    | PK  | 1              |
| 6364R       | Red, pack of 48'   | 12    | 19      | .158" | 48'    | PK  | 1              |
| 6364W       | White, pack of 48' | 12    | 19      | .158" | 48'    | PK  | 1              |
| 6365B       | Black, pack of 48' | 10    | 19      | .182" | 48'    | PK  | 1              |
| 6365R       | Red, pack of 48'   | 10    | 19      | .182" | 48'    | PK  | 1              |
| 6365W       | White, pack of 48' | 10    | 19      | .182" | 48'    | PK  | 1              |

## WIRING DEVICES

### Thermoplastic Handle Plug\*

This plug is a standard grade with flexible spring prongs and is furnished with a face washer. This product's rating is a 15A 125V and also contains a crimper.



| CATALOG NO. | DESCRIPTION | MAX. CORD DIAMETER | POLES | WIRES | MATERIAL      | UOM | ORDER MULTIPLE |
|-------------|-------------|--------------------|-------|-------|---------------|-----|----------------|
| ED179       | Handle Plug | .406"              | 2     | 2     | Thermoplastic | EA  | 1              |

### Grounding Rubber Handle Plug\*

The rubber back design allows for sure grip and protection against dirt and moisture entry. This plug is designed to operate in the widest possible temperature ranges.



| CATALOG NO. | DESCRIPTION           | FITS CORD DIAMETER | POLES | WIRES | RATING   | UOM | ORDER MULTIPLE |
|-------------|-----------------------|--------------------|-------|-------|----------|-----|----------------|
| ED1703      | Grounding Handle Plug | .25"-.60"          | 2     | 3     | 20A-250V | EA  | 1              |
| ED1709      | Grounding Handle Plug | .25"-.60"          | 2     | 3     | 15A-125V | EA  | 1              |

\*Items in this section are Underwriter's Laboratories listed or recognized under the prime manufacturer's name.





## WIRING DEVICES cont'd

**Tandem Grounding Rubber Handle Plug\***

The rubber back design allows for sure grip and protection against dirt and moisture entry. This plug is designed to operate in the widest possible temperature ranges



| CATALOG NO.   | DESCRIPTION        | FITS CORD DIAMETER | POLES | WIRES | RATING   | UOM | ORDER MULTIPLE |
|---------------|--------------------|--------------------|-------|-------|----------|-----|----------------|
| <b>ED1711</b> | Tandem Handle Plug | .25"-.60"          | 2     | 3     | 15A-250V | EA  | 1              |

**Armored Plug\***

This plug has a round dead front and is vinyl enclosed.



| CATALOG NO.   | DESCRIPTION  | FITS CORD DIAMETER | POLES | WIRES | RATING   | UOM | ORDER MULTIPLE |
|---------------|--------------|--------------------|-------|-------|----------|-----|----------------|
| <b>ED2867</b> | Armored Plug | .25"-.625"         | 2     | 3     | 15A-125V | EA  | 1              |

**Right Angle Plug\***

Our right angle plug is ergonomically designed. Its fluted body with radial gripping ridge creates an ideal surface for gripping and pulling.



| CATALOG NO.   | DESCRIPTION      | FITS CORD DIAMETER | POLES | WIRES | RATING   | UOM | ORDER MULTIPLE |
|---------------|------------------|--------------------|-------|-------|----------|-----|----------------|
| <b>ED4409</b> | Right Angle Plug | .25"-.655"         | 2     | 3     | 20A-125V | EA  | 1              |
| <b>ED4509</b> | Right Angle Plug | .25"-.655"         | 2     | 3     | 20A-250V | EA  | 1              |
| <b>ED4867</b> | Right Angle Plug | .25"-.655"         | 2     | 3     | 15A-125V | EA  | 1              |

**Rubber Connector\***

This is a standard grade rubber connector with a 3 pole opening.



| CATALOG NO.  | DESCRIPTION      | FITS CORD DIAMETER | POLES | WIRES | RATING   | UOM | ORDER MULTIPLE |
|--------------|------------------|--------------------|-------|-------|----------|-----|----------------|
| <b>ED252</b> | Rubber Connector | .25"-.60"          | 2     | 3     | 15A-125V | EA  | 1              |

**Armored Connector\***

The Armor Connector is ideal for shops, garages, and heavier duty work areas. Vinyl enclosed.



| CATALOG NO.   | DESCRIPTION       | FITS CORD DIAMETER | POLES | WIRES | RATING   | UOM | ORDER MULTIPLE |
|---------------|-------------------|--------------------|-------|-------|----------|-----|----------------|
| <b>ED2887</b> | Armored Connector | .225"-.60"         | 2     | 3     | 15A-125V | EA  | 1              |

**Ground Adapter\***

This adapter is polarized with 2 pole to 3 wire grounding. The body is made of polypropylene.



| CATALOG NO.  | DESCRIPTION    | RATING   | UOM | ORDER MULTIPLE |
|--------------|----------------|----------|-----|----------------|
| <b>ED419</b> | Ground Adapter | 15A-125V | EA  | 2              |

**Triple Outlets\***

These outlets are polarized and are made of high impact resistant plastic.



| CATALOG NO. | DESCRIPTION                | RATING   | UOM | ORDER MULTIPLE |
|-------------|----------------------------|----------|-----|----------------|
| <b>5223</b> | Heavy duty, 2 pole, 3 wire | 15A-125V | EA  | 1              |

**Power Supply Replacement Cords\***

For power tools or appliances. Black vinyl cord is flexible in very cold environments. Wire type is SJEW-A.



| CATALOG NO. | DESCRIPTION            | WIRE | RATING   | LENGTH | UOM | ORDER MULTIPLE |
|-------------|------------------------|------|----------|--------|-----|----------------|
| <b>5240</b> | Black Replacement Cord | 16/3 | 13A/125V | 10'    | EA  | 1              |
| <b>5242</b> | Black Replacement Cord | 14/3 | 15A/125V | 10'    | EA  | 1              |

\*Items in this section are Underwriter's Laboratories listed or recognized under the prime manufacturer's name.



## WIRING DEVICES cont'd

### Receptacles\*

Our receptacles are available in either singles or duplexes. This is a 2 pole, 3 wire product with ground included. Standard Grade.



| CATALOG NO. | DESCRIPTION       | RATING   | COLOR | UOM | ORDER MULTIPLE |
|-------------|-------------------|----------|-------|-----|----------------|
| ED1876      | Single Receptacle | 20A-250V | Brown | EA  | 1              |
| ED1876-I    | Single Receptacle | 20A-250V | Ivory | EA  | 1              |
| ED1877      | Single Receptacle | 20A-125V | Brown | EA  | 1              |
| ED270**     | Duplex Receptacle | 15A-125V | Brown | EA  | 1              |
| ED270-I**   | Duplex Receptacle | 15A-125V | Ivory | EA  | 1              |
| ED877       | Duplex Receptacle | 20A-125V | Brown | EA  | 1              |

\*\*Standard Grade

### Metal Bat Handle Toggle Switches\*

Features black phenolic plastic case; brass terminals; steel and zinc chromate frame and support; all other external parts are brass/bright nickel. These heavy duty toggle switches have screw terminals. Part ED447 has an "ON-OFF" face plate.

Specifications: 10A/277V-20A/125V AC  
Single Pole: 3/4HP 125-250V AC  
Double Pole: 1-1/2HP 125-250V AC



| CATALOG NO. | DESCRIPTION              | SEQUENCE  | CIRCUIT                   | UOM | ORDER MULTIPLE |
|-------------|--------------------------|-----------|---------------------------|-----|----------------|
| ED447       | Bat Handle Toggle Switch | ON-OFF    | Single Pole, Single Throw | EA  | 1              |
| ED453       | Bat Handle Toggle Switch | ON-ON     | Double Pole, Double Throw | EA  | 1              |
| ED454       | Bat Handle Toggle Switch | ON-ON     | Single Pole, Double Throw | EA  | 1              |
| ED455       | Bat Handle Toggle Switch | ON-OFF    | Double Pole, Single Throw | EA  | 1              |
| ED468       | Bat Handle Toggle Switch | ON-OFF-ON | Single Pole, Double Throw | EA  | 1              |
| ED494       | Bat Handle Toggle Switch | ON-OFF-ON | Double Pole, Double Throw | EA  | 1              |
| ED448B      | Bat Handle Toggle Switch | ON-OFF    | Single Pole, Single Throw | EA  | 1              |

### Toggle Switch with Neon Pilot Light Combination Device\*

Switch: 15A-120V AC  
Neon Pilot Light: 1/25W, 120V AC



| CATALOG NO. | DESCRIPTION                                      | UOM | ORDER MULTIPLE |
|-------------|--|-----|----------------|
| ED277       | Toggle Switch with Neon Pilot Light - Brown Body | EA  | 1              |

### Utility Fuse Outlets\*

This is designed to break up electrical surges on equipment.



| CATALOG NO. | DESCRIPTION  | UOM | ORDER MULTIPLE |
|-------------|--|-----|----------------|
| PI381       | Utility Fuse Outlet and Switch with Cover; 1/2HP-125V AC only; galvanized steel construction | EA  | 1              |

### Toggle Switch and Receptacle Combination Device\*

This device is a single pole switch with 15A 120V AC. The receptacle is 15A 125V AC and it is a 2 pole, three wire grounding.



| CATALOG NO. | DESCRIPTION                               | UOM | ORDER MULTIPLE |
|-------------|---|-----|----------------|
| ED5225      | Toggle Switch and Receptacle - Brown Body | EA  | 1              |

### Toggle Switches\*

Our toggle switch is a silent switch with ground included. Standard Grade.



| CATALOG NO. | DESCRIPTION | RATING          | COLOR | UOM | ORDER MULTIPLE |
|-------------|-------------|-----------------|-------|-----|----------------|
| ED1240-2    | Single Pole | 15A-120/277V AC | Brown | EA  | 1              |
| ED1238      | Single Pole | 20A-120/277V AC | Brown | EA  | 1              |
| ED1301**    | Single Pole | 15A-120V AC     | Brown | EA  | 1              |
| ED1301-I**  | Single Pole | 15A-120V AC     | Ivory | EA  | 1              |
| ED1262-2    | Double Pole | 15A-120/277V AC | Brown | EA  | 1              |
| ED1262-2I   | Double Pole | 15A-120/277V AC | Ivory | EA  | 1              |
| ED1232      | Double Pole | 30A-120/277V AC | Brown | EA  | 1              |

\*\*Standard Grade

### Porcelain Outlet Box Lampholders\*

Features one-piece pull chain. Two screw terminals, 2 pole, 2 wire. 4-1/2" outer diameter. These lamp holders fit 3-1/4" and 4" boxes. Rating: Lampholder: 660W/125V. Outlet: 15A/125V.



| CATALOG NO. | DESCRIPTION                                       | UOM | ORDER MULTIPLE |
|-------------|---|-----|----------------|
| ED9726      | Porcelain Outlet Box Lampholder - U ground outlet | EA  | 1              |

\*Items in this section are Underwriter's Laboratories listed or recognized under the prime manufacturer's name.



## WIRING DEVICES cont'd

## Fuse Holders

Used to mount and protect fuses, fuse holders also enable fuses to be changed quickly and easily. Fuse holders are used in a variety of applications, including consumer electronics, industrial, telecom and datacom, automotive, and many others.



| CATALOG NO.  | DESCRIPTION  | UOM | ORDER MULTIPLE |
|--------------|--|-----|----------------|
| <b>EM480</b> | In-Line Fuse Holder for use with 1-1/4 x 1/4" fuses up to 20 amps, 32 volts, 15" lead; 14 gauge red vinyl insulated wire                             | EA  | 1              |
| <b>EM484</b> | Self-Stripping Fuse Holder mates with blade-type fuse .205 x .025". 18-14 AWG. Size: 1.37" L x .44" H x .95" W Max. Insulation Outer Diameter: .145" | EA  | 2              |

## Vinyl Grommet Assortment Packs

These grommets exhibit high dielectric strength and are oil, ozone, and UV resistant.



| CATALOG NO.  | DESCRIPTION                                     | UOM | ORDER MULTIPLE |
|--------------|---|-----|----------------|
| <b>ED320</b> | General Assortment – contains all grommet sizes | EA  | 1              |

## Heat Shrink Tubing\*

Heat Shrink Tubing is made of flame-retardant polyolefin. Thin walled, all purpose tubing. Rated 600V, 125°C. 2500 volts/mil. dielectric strength. Inert to fungus. Virtually unaffected by corrosives, common fluids, and solvents. Pieces are 6" in length.



| CATALOG NO.   | COLOR             | INNER DIAMETER |                | UOM | ORDER MULTIPLE |
|---------------|-------------------|----------------|----------------|-----|----------------|
|               |                   | MAX SUPPLIED   | MIN. RECOVERED |     |                |
| <b>63076B</b> | Black, pack of 10 | 3/8"           | 3/16"          | PK  | 1              |
| <b>63077B</b> | Black, pack of 10 | 1/2"           | 1/4"           | PK  | 1              |

## Heat Shrink Tubing Assortments\*

Heat Shrink Tubing is made of flame-retardant polyolefin. Thin walled, all purpose tubing. Rated 600V, 125°C. 2500 volts/mil. dielectric strength. Inert to fungus. Virtually unaffected by corrosives, common fluids, and solvents. Pieces are 6" in length.



| CATALOG NO.  | COLOR                     | INNER DIAMETER   |                    | UOM | ORDER MULTIPLE |
|--------------|---------------------------|------------------|--------------------|-----|----------------|
|              |                           | MAX SUPPLIED     | MIN. RECOVERED     |     |                |
| <b>6370</b>  | Black & White, pack of 12 | 1/8", 1/4"       | 1/16", 1/8"        | PK  | 1              |
| <b>6371</b>  | Black & White, pack of 7  | 1/8", 1/4", 3/8" | 1/16", 1/8", 3/16" | PK  | 1              |
| <b>63070</b> | Black, pack of 3          | 3/8" – 1/2"      | 3/16" – 1/4"       | PK  | 1              |

## 6180 Series Terminal Blocks\*

These terminal blocks are constructed of high barrier thermoplastic are rated 20A 250V.

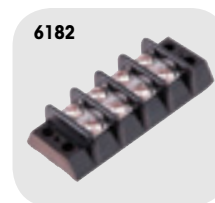

| CATALOG NO. | DESCRIPTION    | NO. OF POSITIONS | LENGTH (in.) | WIDTH (in.) | SCREW SIZE | MAX. WIRE SIZE | UOM | ORDER MULTIPLE |
|-------------|----------------|------------------|--------------|-------------|------------|----------------|-----|----------------|
| <b>6182</b> | Terminal Block | 4                | 2.16         | .88         | 6-32       | 22-14          | EA  | 1              |
| <b>6183</b> | Terminal Block | 6                | 2.91         | .88         | 6-32       | 22-14          | EA  | 1              |
| <b>6184</b> | Terminal Block | 8                | 3.66         | .88         | 6-32       | 22-14          | EA  | 1              |
| <b>6185</b> | Terminal Block | 10               | 4.41         | .88         | 6-32       | 22-14          | EA  | 1              |
| <b>6186</b> | Terminal Block | 12               | 5.16         | .88         | 6-32       | 22-14          | EA  | 1              |
| <b>6187</b> | Terminal Block | 14               | 5.91         | .88         | 6-32       | 22-14          | EA  | 1              |

## 6190 Series Terminal Blocks\*

These terminal blocks are constructed of phenolic 9/16in. centers. They are rated 30A 600V.



| CATALOG NO.  | DESCRIPTION    | NO. OF POSITIONS | LENGTH (in.) | WIDTH (in.) | SCREW SIZE | MAX. WIRE SIZE | UOM | ORDER MULTIPLE |
|--------------|----------------|------------------|--------------|-------------|------------|----------------|-----|----------------|
| <b>6193</b>  | Terminal Block | 6                | 4.34         | 1.31        | 8-32       | 14-12          | EA  | 1              |
| <b>6194</b>  | Terminal Block | 8                | 5.47         | 1.31        | 8-32       | 14-12          | EA  | 1              |
| <b>6195X</b> | Terminal Block | 10               | 6.59         | 1.31        | 8-32       | 14-12          | EA  | 1              |

## Terminal Block Jumpers\*

These jumpers connect two positions on a terminal block and are made of nickel plated brass.



| CATALOG NO.   | DESCRIPTION   | UOM | ORDER MULTIPLE |
|---------------|---|-----|----------------|
| <b>6278CX</b> | Jumpers for Terminal Block 6180 Series, pack of 100 | PK  | 1              |



## WIRING DEVICES cont'd

### Indicator Lights

Terminals are tin plated brass. Wire leads are 22 AWG, 4.4–4.8" long, 1/2" stripped. Mounting will snap-fit into .500–.505 diameter hole in .100–.100" thick panels.



### Indicator Lights\*

Terminals are tin plated brass. Wire leads are 22 AWG, 4.4–4.8" long, 1/2" stripped. .31" minimum diameter mounting.



| CATALOG NO. | LENS COLOR       | LENS MATERIAL | VOLTAGE     | BULB TYPE    | UOM | ORDER MULTIPLE |
|-------------|------------------|---------------|-------------|--------------|-----|----------------|
| ED600       | Red, pack of 2   | Polycarbonate | 28V         | Incandescent | PK  | 1              |
| ED601       | Green, pack of 2 | Polycarbonate | 28V         | Incandescent | PK  | 1              |
| ED602       | Amber, pack of 2 | Polycarbonate | 28V         | Incandescent | PK  | 1              |
| ED603       | Blue, pack of 2  | Polycarbonate | 28V         | Incandescent | PK  | 1              |
| ED610       | Red, pack of 2   | Nylon         | 105–125V AC | Neon         | PK  | 1              |
| ED611       | Green, pack of 2 | Polycarbonate | 105–125V AC | Neon**       | PK  | 1              |
| ED612       | Amber, pack of 2 | Nylon         | 105–125V AC | Neon         | PK  | 1              |
| ED613       | Blue, pack of 2  | Polycarbonate | 105–125V AC | Neon†        | PK  | 1              |
| ED620       | Red, pack of 2   | Polycarbonate | 208–250V AC | Neon         | PK  | 1              |
| ED621       | Green, pack of 2 | Polycarbonate | 208–250V AC | Neon**       | PK  | 1              |

| CATALOG NO. | LENS COLOR     | LENS MATERIAL | VOLTAGE     | BULB TYPE | UOM | ORDER MULTIPLE |
|-------------|----------------|---------------|-------------|-----------|-----|----------------|
| ED710       | Red, pack of 2 | Polycarbonate | 105–125V AC | Neon      | PK  | 1              |

### Standard Wire Connectors\*

Connectors are color coded with spring inserts. Heat resistant (105°C) thermoplastic. Connectors are for copper to copper connections. Parts 6294 and 6296 can connect aluminum to aluminum and copper to aluminum (dry locations only).



### Winged Wire Connectors\*

Durable thermoplastic material. Flame retardant, abrasion resistant, non porous, and non corrosive. Expandable spring grips into the wire and adjusts itself to the wire size and shape so pre twisting is unnecessary. Even during temperature changes, they resist vibrations and retain holding power. Parts 8284 and 8286 are for use with copper to copper, aluminum to aluminum, and copper to aluminum (dry locations only).



| CATALOG NO. | DESCRIPTION   | UOM | ORDER MULTIPLE |
|-------------|---|-----|----------------|
| 6291        | Mini Gray Standard Wire Connectors, pack of 29      | PK  | 1              |
| 6291CX      | Mini Gray Standard Wire Connectors, pack of 100     | PK  | 1              |
| 6292        | Tiny Blue Standard Wire Connectors, pack of 25      | PK  | 1              |
| 6292CX      | Tiny Blue Standard Wire Connectors, pack of 100     | PK  | 1              |
| 6293        | Small Orange Standard Wire Connectors, pack of 20   | PK  | 1              |
| 6293CX      | Small Orange Standard Wire Connectors, pack of 100  | PK  | 1              |
| 6294        | Medium Yellow Standard Wire Connectors, pack of 18  | PK  | 1              |
| 6294CX      | Medium Yellow Standard Wire Connectors, pack of 100 | PK  | 1              |
| 6296        | Large Red Standard Wire Connectors, pack of 12      | PK  | 1              |
| 6296CX      | Large Red Standard Wire Connectors, pack of 100     | PK  | 1              |
| 6298        | X-Large Gray Standard Wire Connectors, pack of 6    | PK  | 1              |
| 6298LX      | X-Large Gray Standard Wire Connectors, pack of 50   | PK  | 1              |
| 6295X       | Assortment: Includes 6291, 6292, 6293, 6294, 6296   | EA  | 1              |

| CATALOG NO. | DESCRIPTION                                      | UOM | ORDER MULTIPLE |
|-------------|--|-----|----------------|
| 8284        | Small Yellow Winged Wire Connectors, pack of 18  | PK  | 1              |
| 8284CX-B    | Small Yellow Winged Wire Connectors, pack of 100 | PK  | 1              |
| 8286        | Medium Red Winged Wire Connectors, pack of 14    | PK  | 1              |
| 8286CX-B    | Medium Red Winged Wire Connectors, pack of 100   | PK  | 1              |
| 8282LX      | X-Large Blue Winged Wire Connectors, pack of 50  | PK  | 1              |

-B indicates boxed product. All other catalog numbers are poly bagged.

### Porcelain Wire Connectors\*

For high temperature applications over 105°C (300 volts maximum). For stranded copper connections only.



### Aluminum Solderless Lugs\*

Our aluminum solder less lug are made from high strength aluminum alloy. These lugs are suitable for use with either copper or aluminum conductors.



| CATALOG NO. | DESCRIPTION                                      | WIRE RANGE | AMP RATING | UOM | ORDER MULTIPLE |
|-------------|--|------------|------------|-----|----------------|
| PI221       | Small Lug for aluminum or copper wire, pack of 6 | 4-14       | 2          | PK  | 1              |
| PI222       | Large Lug for aluminum or copper wire, pack of 6 | 2-14       | 2          | PK  | 1              |

| CATALOG NO. | DESCRIPTION   | UOM | ORDER MULTIPLE |
|-------------|---|-----|----------------|
| 4293        | Small White Porcelain Wire Connectors, pack of 17   | PK  | 1              |
| 4293CX      | Small White Porcelain Wire Connectors, pack of 100  | PK  | 1              |
| 4294        | Medium White Porcelain Wire Connectors, pack of 15  | PK  | 1              |
| 4294CX      | Medium White Porcelain Wire Connectors, pack of 100 | PK  | 1              |
| 4296        | Large White Porcelain Wire Connectors, pack of 13   | PK  | 1              |
| 4296CX      | Large White Porcelain Wire Connectors, pack of 100  | PK  | 1              |

\*Items in this section are Underwriter's Laboratories listed or recognized under the prime manufacturer's name.

\*\*Neon bulb incorporates G2B lamp and resistor.

† Neon bulb incorporates T2B lamp and resistor.



WIRING DEVICES cont'd

### Electrolytic Copper Solderless Lugs\*

Our solder less lugs are manufactured from high strength pure electrolytic copper to insure both maximum strength and conductivity.



| CATALOG NO.  | DESCRIPTION                           | WIRE RANGE | AMP RATING | UOM | ORDER MULTIPLE |
|--------------|---------------------------------------|------------|------------|-----|----------------|
| <b>PI226</b> | Small Lug for copper wire, pack of 6  | 10-14      | 25         | PK  | 1              |
| <b>PI227</b> | Medium Lug for copper wire, pack of 6 | 6-14       | 35-50      | PK  | 1              |
| <b>PI228</b> | Large Lug for copper wire, pack of 6  | 4-14       | 70         | PK  | 1              |

### Pigtails

The wire has a #10 spade on one end and a 10 32 x 3/8in. slotted round head screw on the other. This allows for easy positioning in the outlet box.

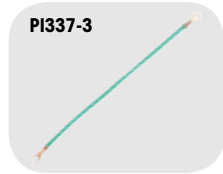

| CATALOG NO.    | DESCRIPTION         | WIRE LENGTH | WIRE GAUGE | WIRE TYPE | UOM | ORDER MULTIPLE |
|----------------|---------------------|-------------|------------|-----------|-----|----------------|
| <b>PI337-3</b> | Pigtails, pack of 5 | 8"          | 14         | Stranded  | PK  | 1              |

### Cable Markers

Cable markers come in books of 450 markers with matching terminal markers. Markers are mounted on dispenser cards in the book. Cable markers are suitable for above and below ground applications. Books are made of vinyl impregnated cloth that resists moderate amounts of dirt, oil and heat. The blank Write-On Markers (WM1014) are made of durable vinyl film that resists water, oils, and fungus. They can also withstand extremes in temperature.



| CATALOG NO.   | DESCRIPTION   | UOM | ORDER MULTIPLE |
|---------------|---|-----|----------------|
| <b>WM1002</b> | Alpha-Numeric Cable Marker Book; contains 10 each: A-Z, 0-15, +, -, /   | EA  | 1              |
| <b>WM1003</b> | Numeric Cable Marker Book; contains 10 each: 1-45   | EA  | 1              |
| <b>WM1009</b> | Line and Terminal Cable Marker Book; contains 45 each: 1, 2, 3, A, B, C; contains 30 each: T1, T2, T3, L1, L2, L3 | EA  | 1              |
| <b>WM1014</b> | 180 Blank Write-On Markers, 1/2" x 1-1/2"   | EA  | 1              |

### Split Bolt Connectors\*

These connectors are made of silicone bronze and are designed for copper use only.



| CATALOG NO.  | DESCRIPTION                     | MAX. SOLID WIRE | MAX. STRANDED WIRE | UOM | ORDER MULTIPLE |
|--------------|---------------------------------|-----------------|--------------------|-----|----------------|
| <b>PI326</b> | Split Bolt Connector, pack of 3 | 10              | 12                 | PK  | 1              |
| <b>PI327</b> | Split Bolt Connector, pack of 3 | 8               | 8                  | PK  | 1              |
| <b>PI328</b> | Split Bolt Connector, pack of 3 | 6               | 7                  | PK  | 1              |
| <b>PI929</b> | Split Bolt Connector, pack of 3 | 4               | 5                  | PK  | 1              |

### Ground Fitting Clamp\*

A ground fitting clamp is ideal for surface mounting small amounts of electrical wiring or communication cables.



| CATALOG NO.  | DESCRIPTION  | UOM | ORDER MULTIPLE |
|--------------|--|-----|----------------|
| <b>PI237</b> | For 8, 6, 4 bare grounding wire; fits 1/2"-1" pipe | EA  | 1              |

\*Items in this section are Underwriter's Laboratories listed or recognized under the prime manufacturer's name.

# ELECTRICAL

|   |         |
|---|---------|
| Bearings.....                           | 142     |
| Capacitors.....                         | 146-147 |
| Conduit, Fittings, Cable .....          | 144-145 |
| Contactors.....                         | 150-151 |
| DiversiTech Electrical Disconnects..... | 143     |
| Eaton Electrical Disconnects.....       | 144     |
| Electrical Supplies .....               | 156-158 |
| Electrical Tapes .....                  | 158     |
| Fan Centers.....                        | 152     |
| Fuses .....                             | 153-154 |
| Hard Start Kits .....                   | 149     |
| Monitors.....                           | 155     |
| Motor Brackets .....                    | 142     |
| Motor Run Capacitors (USA Made).....    | 148-149 |
| Motors .....                            | 138-141 |
| Relays.....                             | 152     |
| Stranded Copper THHN Wire .....         | 162-163 |
| Terminals, Connectors.....              | 159     |
| Thermal Controls .....                  | 160     |
| Thermostat Guards .....                 | 161     |
| Thermostat Wire .....                   | 162     |
| Thermostats .....                       | 161     |
| Time Delays .....                       | 154     |
| Transformers .....                      | 151     |
| Whips .....                             | 142-143 |
| Wire Connectors.....                    | 163-164 |
| Wire/Cable Ties, Mounts, Clamps .....   | 164-165 |





# A/C Disconnect Switches

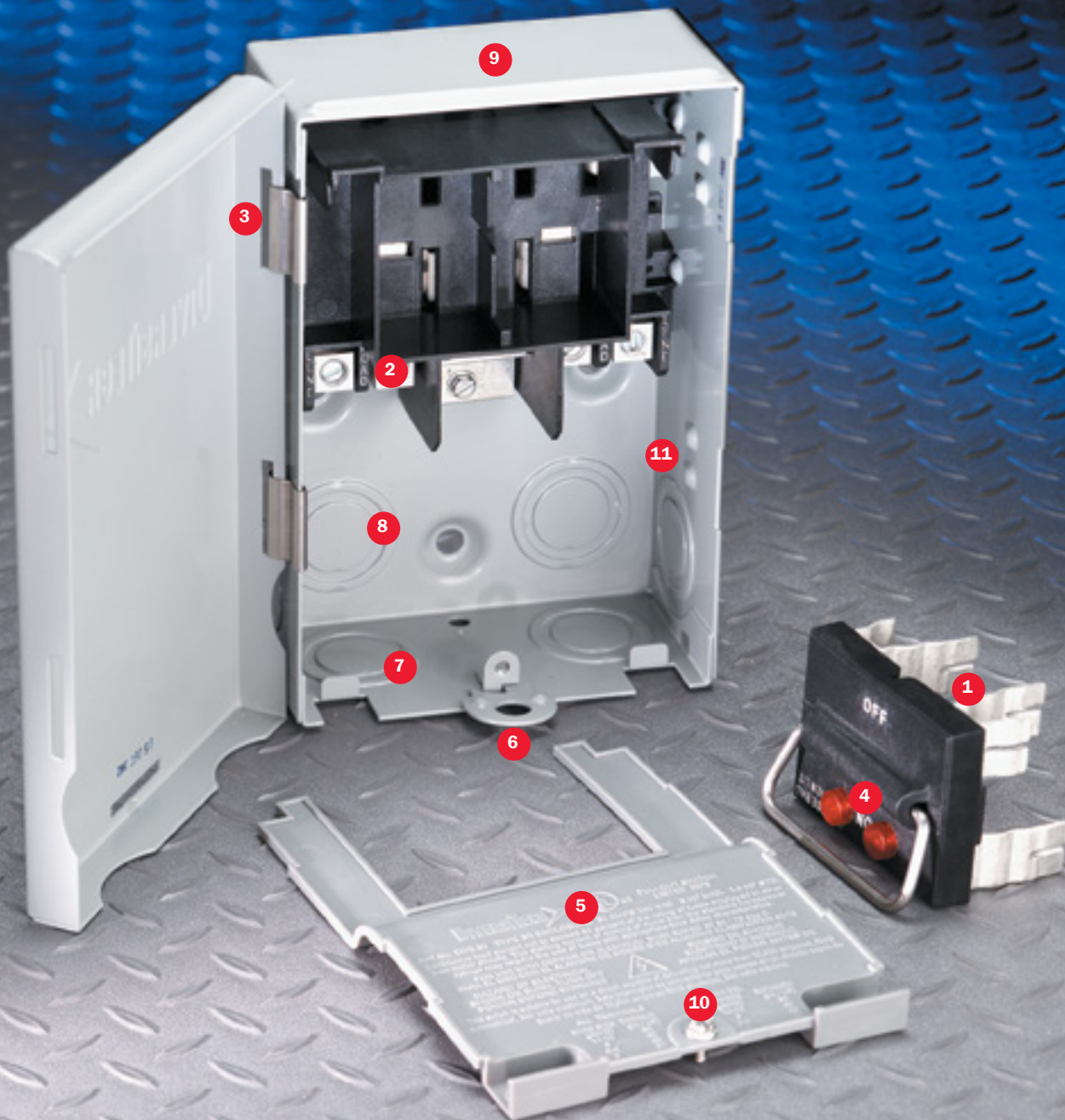

## A/C DISCONNECT FEATURES AND BENEFITS

- 1 Fuses install into pull-out handle
- 2 Line, load, and ground terminals aligned for easy hook up with heavy wires
- 3 Reversible side-opening door
- 4 Indicator lights for blown fuses
- 5 Full dead front
- 6 Folding pivot locking tab
- 7 Knockouts accommodate three sizes (1/2", 3/4", and 1")
- 8 Rear entry knockouts
- 9 Heavy gauge steel case
- 10 Standard 1/4" head screw on dead front
- 11 Large internal wiring space



### FUSES INSTALL INTO PULL-OUT HANDLE

The DiversiTech disconnect switch is available in two versions – fusible and non-fusible. On the fusible configuration, the pull-out handle also functions as a removable fuse holder. This feature permits easy removal and replacement of fuses. Rather than requiring a fuse puller to reach inside the disconnect switch and remove the blown fuses, one can easily change the fuses with the fuse holder removed from the disconnect switch.

### INDICATOR LIGHT FOR BLOWN FUSE

The fusible disconnect switch has an indicator light for fuse condition. When a fuse is blown, the red indicator light illuminates to show not only that a fuse is bad, but specifically, which fuse needs replacement. This feature provides rapid troubleshooting for the contractor inspecting an installation. One can tell instantly (visually) whether a fuse is bad.



### MOUNTING AND INLINE WIRING

A unique feature to the DiversiTech disconnect switch is the design of wiring terminals inline. This straight-line arrangement provides for quick and easy wire connection — no need to cut the connection wires to different lengths. All wires are easily installed without unnecessary bending or twisting.

### REVERSIBLE SIDE OPENING DOOR

The unique reversible side opening door provides for easy field change from left-hand hinge to right-hand hinge. The standard left-hand hinge is adequate for most all installations except for tight, inside, right-hand corners. In these instances, simply remove the two stainless steel hinge clips and move them to the right-hand side. This permits the door to hinge on the right.



# Fractional Horsepower Motors

## FEATURES AND BENEFITS



### COLOR PACKAGING

Bright, colorful, easy to read packaging removes confusion about motors. The distributor can easily identify the stock of motors on the shelf. The application, voltage, and horsepower of a motor are visible at a glance.



### CARTON HANDLE

The motor carton has been designed with an innovative handle to make the motors much easier to carry.



### CAPACITOR SIZE

The appropriate size 370 VAC run capacitor is noted on every motor carton.

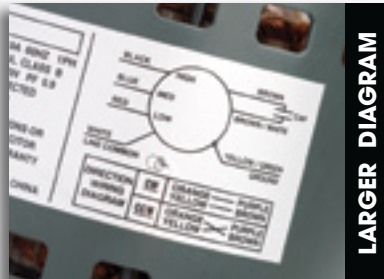

### LARGER DIAGRAM

An extra large wiring diagram is supplied on the motor itself, on the motor carton, and also in the installation and safety instruction sheet. This large wiring diagram makes it very easy to read.

| CROSS REFERENCE GUIDE |          |
|-----------------------|----------|
| WG840728              |          |
| 208-230 VAC           | 1/4 hp   |
| MARS                  | 03728    |
| PACKARD               | 63128    |
| GEMLINE               | EM3728   |
| MARATHON              | X213     |
| AD SMITH              | F3E10295 |
| FASCO                 | D809     |

### CROSS REFERENCE

For your convenience, Wagner provides a complete manufacturer cross-reference on the side of every motor carton.



### EXTENDED BOLTS

Extended mounting bolts provide for easier installation in cramped spaces. With the longer bolts, the installer is able to more easily start the threaded mounting nut.



### BALL BEARINGS

Ball bearing design improves motor performance and reliability. It also increases heat endurance and motor life. Now standard on Condenser Fan Motor models.



### REVERSING PLUG

The electrical reversing plug simplifies rotation direction changes.





**Wagner Motors are available in many different versions to meet motor application needs.**

- Direct Drive Furnace Blower Motors
- Multiple Horsepower Motors
- Condenser Fan Motors
- High Temperature Condenser Fan Motors



**All Wagner Motors have a 2 year warranty.**

## MULTIPLE HORSEPOWER MOTORS

Multiple horsepower motors allow the contractor and distributor to consolidate multiple part codes into a single stocking unit. The multiple horsepower motor allows the contractor to carry one motor that can be used as a replacement for a wide variety of OEM and other replacement motors, saving time and money.



- All the features and benefits of standard motors
- Plus multiple horsepower
- Variety of voltages, applications, and speeds are available.



# Evergreen®

EVER EFFICIENT. EVER RELIABLE. EVER PROFITABLE.



**Upgrade/Replace Indoor PSC Blower motors with Evergreen® IM**



RESIDENTIAL/LIGHT COMMERCIAL HVAC SYSTEMS

- Reduce truck stock
- Increase energy savings
- Increase comfort and home health
- Decrease continuous fan noise and power consumption
- Easy drop-in replacement - connects directly to fan boards or relays
- Two year warranty

**FURNACE AIR HANDLERS**  
INCLUDES PACKAGE SYSTEMS

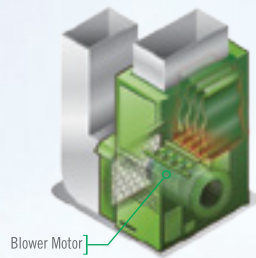

Blower Motor

**Evergreen® IM**

Replace Permanent Split Capacitor (PSC), direct drive, induction motors with the following ratings:

Horsepower: 1/4-1  
RPM Rating: 1075  
Voltage: 120 & 208-230  
Rotation: CW & CCW



[PSC]

**Replace OEM ECM X13 motors with Evergreen® EM**



RESIDENTIAL/LIGHT COMMERCIAL HVAC SYSTEMS

- Replaces X13 and similar Constant Torque ECM
- Maintains system efficiency and performance
- Compatible with OEM harness
- Pre-programmed for truck stock
- No complex wiring or configuration
- Two year warranty

**FURNACE AIR HANDLERS**  
INCLUDES PACKAGE SYSTEMS

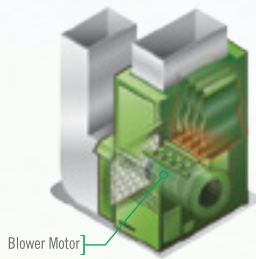

Blower Motor

**Evergreen® EM**

Replaces OEM Constant Torque ECM built with 24v speed taps with the following ratings:

Horsepower: 1/3-1  
RPM Rating: 1070  
Voltage: 115 or 208-230  
Rotation: CW & CCW

[Constant Torque ECM Genteq X13 or Similar Competitors' Models]



**Upgrade/Replace PSC Outdoor Fan motors with Evergreen® OM**



- Drop-in replacement for induction motors
- Easy Retrofit - line voltage connections
- Quiet start and operation
- Dual rotation (CW/CCW)
- Efficiency up to 80%
- Two year warranty

**A/C & HEAT PUMP UNITS**  
INCLUDES PACKAGE SYSTEMS

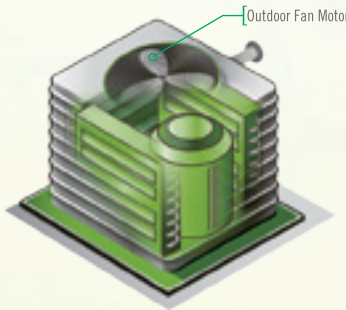

Outdoor Fan Motor

**Evergreen® OM**

[PSC]

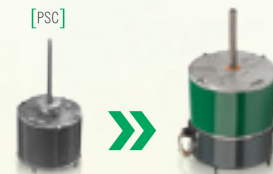



# Digital 3-Phase Line Voltage Monitor

The DTP-3 is an automatic digital voltage monitor and control system.

By continuously measuring the incoming line voltage, the DTP-3 monitor will detect voltages outside of the tolerance that you set.

If these limits are exceeded, the response timer is started. This timer may be set to a long time value to avoid nuisance tripping, or to a short time value to offer a higher level of load protection.

If the voltage remains outside of the selected tolerance after the time has elapsed, the DTP-3 will turn off its output relay and protect your device. While the load is off, an additional lockout timer is activated to avoid rapid restarts.

- Read Line and Load Side Voltage Instantly
- Simple Three Button Access for Easy Monitoring and Set-Up
- Fault Memory Records Problems for Later Display
- Six Digital Voltmeters Built In
- Sequential Start Timer Built In
- Lock Out Timer Built In
- Response Timer Built In

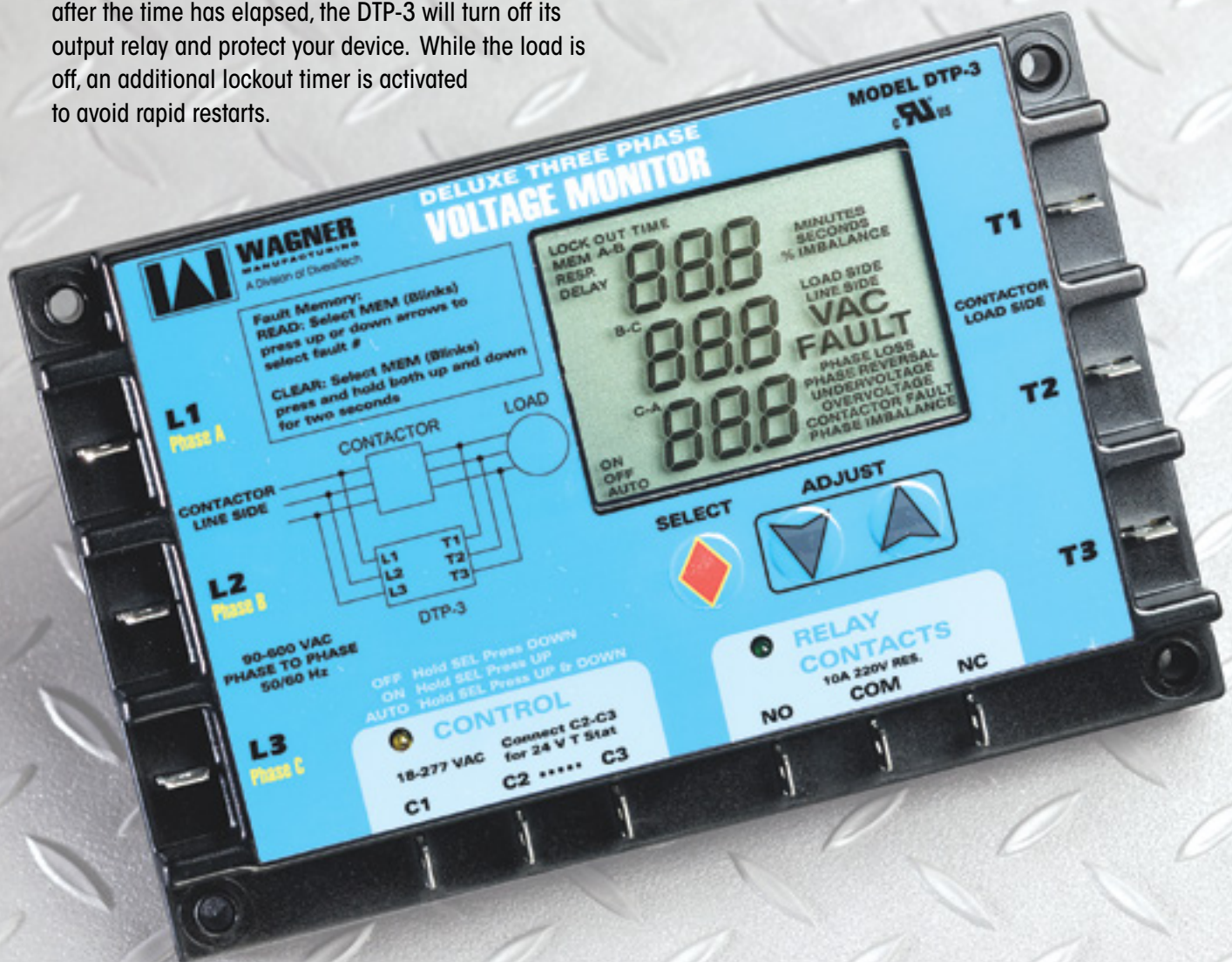

## FEATURES AND BENEFITS

### Large Digital LCD Display

Provides instant display of the system's operating voltage, not just indicator lights. System setup is simplified by using the display to set the exact voltage range you want to monitor. Other controls use dials for system adjustment that can lead to inaccurate settings and motor burnout.

### Super Simple Operation

Just three buttons set up everything. Easy adjustment of voltage tolerance and timers.

### Small Size

Small footprint and low profile fits where other can't.

### 10 Amp Rated Output Relay with Isolated Contacts

Powerful relay can connect to just about any control circuit. Normally-Open and Normally-Closed contacts are provided for connection to any type of system, motor control or alarm.

### 2 LED Indicators

Glowing light-emitting-diodes show applied control voltage and output relay operation at a glance.

### Precision Digital Circuitry

Completely eliminates the ambiguity associated with analog controls and screwdriver adjustments.

### Adjustable Response Time

This timer sets the amount of time between when a voltage outside of the selected tolerance is detected and when the output relay is de-energized. Setting low time values offers faster protection. Setting longer times provides greater resistance to nuisance tripping.

### Adjustable Delay Time

This timer sets the amount of time before the protected system is allowed to restart. Typically this timer is set to a value which allows the protected system to bleed-off high pressures or to cool down to a safe value for restarting.

### Broad Voltage Adjustment Range

User adjustable monitored voltage range from 160 to 650 VAC. This broad adjustment range incorporates voltages for the majority of compressor installation requirements. Therefore, this single unit can be used across a broad range of installations.

## DTP-3 FACTS

### Protection

Loss of Phase, Phase Reversal, Voltage Imbalance, Low Voltage, High Voltage.

### Display

Large custom LCD indicates all operating conditions at a glance. Three large sets of digits provide easy system troubleshooting.

### Voltmeter

Simultaneous display of all three line voltage pairs. One button switches to contactor load side voltage reading.

### Input Voltage Range

90 – 650 VAC at 50 or 60 hertz.

### Voltage Trip Point

Adjustable in 1 percent increments between 6% and 18% of the selected operating voltage. Restart voltage set point fixed at +3%.

### Voltage Symmetry

Adjustable imbalance set point from 2% to 25% of selected operating voltage.

### Lockout Delay Timer

Fully adjustable 0 to 720 seconds (0 to 12 minutes). Digital display shows remaining time and user set points.

### Sequential Start Timer

0 – 30 seconds in 1 second increments.

### Response Timer

0.1 to 20 seconds digital display shows remaining time and user set points.

### Memory

Up to 25 previous fault conditions are recorded for display as desired.



# Monitor Digital Trifasico de Linea de Voltaje

El DTP-3 es un monitor de voltaje y sistema de control automático digital.

Por estar midiendo continuamente la entrada de la línea de voltaje, este monitor detectará voltajes fuera de la tolerancia que se fijó.

Si este limite es excedido arrancará el Regulador de respuesta. Este regulador podrá ser fijado a una mayor escala de tiempo para evitar el ruido molesto del corte y arranque, o a una escala menor de tiempo para ofrecer un mayor nivel de protección de carga.

Si el voltaje permanece fuera de la tolerancia seleccionada después que el tiempo ha transcurrido, el DTP-3 apagará su relevador de rendimiento y protegerá su aparato. Mientras la carga esta apagada un regulador de cierre adicional es activado para evitar arranques inmediatos.

- Lectura de línea y de la carga de voltaje instantáneamente
- Tres simples botones de acceso para fácil monitoreo e instalación
- Registro de problemas en falla de memoria para posterior exhibición
- Seis voltímetros digitales integrados
- Regulador de arranque secuencial integrado
- Regulador de cierre integrado
- Regulador de respuesta integrado

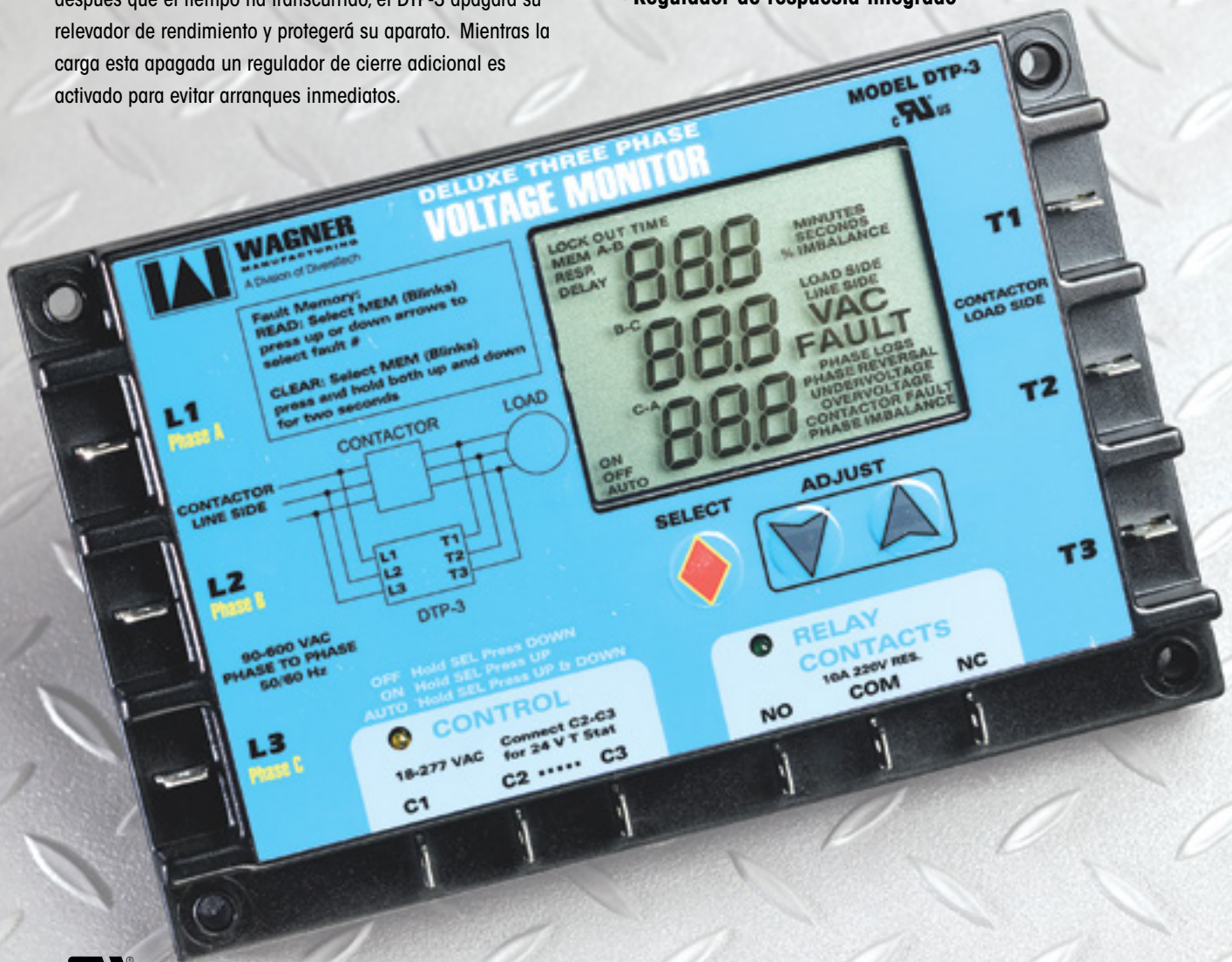



## DTP-3 CARACTERISTICAS Y BENEFICIOS

### La gran pantalla digital LCD

suministra al instante la operación del sistema de voltaje no solo luces indicadoras. El sistema programable es simplificado por usar la pantalla para fijar el rango exacto de voltaje que quiera monitorear. Otros controles usan botones para ajustar el sistema, que pueden dirigir hacia una programación inexacta y falla de motor.

### Operación super simple

solo tres botones operan todo. Fácil ajuste de tolerancia de voltaje y reguladores de tiempo.

### Pequeña medida

y su práctico contorno el cual se ajusta donde otros no pueden.

### Relevador de salida de 10 amps con contactos aislados

Relevador de poder que puede conectarse con cualquier circuito de control. Normalmente-Abierto y Normalmente-Cerrado contactos son suministrados para conectarse a cualquier tipo de sistema, control de motor o alarma.

### 2 indicadores LED

muestran el voltaje de control aplicado y la operación del relevador de salida en un solo vistazo.

### Los circuitos de precisión digital

eliminan completamente la ambigüedad asociada con controles análogos y ajustes de desarmador.

### Regulador de respuesta ajustable

Este regulador fija la cantidad de tiempo cuando un voltaje externo de la tolerancia seleccionada es detectado y cuando el relevador de salida es de-energizado. El fijar valores de tiempo bajos ofrece una más rápida protección. El fijar un tiempo prolongado suministra gran resistencia evitando el ruido molesto del corte y arranque.

### Regulador retardador de tiempo ajustable

Este regulador fija la cantidad de tiempo antes que al sistema de protección se le permita re-iniciar. Típicamente este regulador es fijado a un valor el cual permita al sistema de protección descargar altas presiones o que se enfríe a un valor seguro para re-iniciar.

### Amplio ajuste del rango de voltaje

El usuario monitorea el rango ajustable del voltaje de 160 a 650 VAC. Este amplio rango de ajuste incorpora voltajes para la mayoría de los requerimientos de instalación de compresores. Así mismo, esta unidad puede ser usada a través de un rango amplio de instalaciones.

## DTP-3 HECHOS

### Proteccion

Pérdida de fase, cambio de fase, desequilibrio de voltaje, bajo voltaje, alto voltaje.

### Pantalla

Los LCD hechos a la medida indican todas las condiciones de operación en un vistazo. Tres juegos grandes de dígitos suministran fácilmente los problemas del sistema.

### Voltimetro

Pantalla simultanea de las tres líneas pares de voltaje. Un botón cambia al contactor para la lectura de la carga de voltaje.

### Suministro de voltaje

90-650 VAC a 50 o 60 hertz.

### Margen de error del voltaje

Ajustable en un porcentaje de entre 6% y 18% de la operación del voltaje seleccionado. Re-inicio con un +3% del voltaje establecido.

### Simetria del voltaje

Desequilibrio ajustable establecido de 2% a 25% de la operación del voltaje seleccionado.

### Regulador retardador de cierre

Completamente ajustable de 0 a 720 segundos (0 a 12 minutos) la pantalla digital muestra el tiempo restante y los puntos establecidos por el usuario.

### Arrancador secuencial de tiempo

0 – 30 segundos en incrementos de 1 segundo.

### Regulador de respuesta

0.1 a 20 segundos la pantalla digital muestra el tiempo restante y los puntos establecidos por el usuario.

### Memoria

Hasta 25 condiciones de falla previas son almacenadas para mostrarse según se requiera.

**MOTORS**

**Wagner® Single Speed Condenser Fan Motors**

- Installs with all Standard 48 Frame Mounting Brackets
- Standard Shaft Length, Diameter, and Flats
- Drain Holes with Plugs in both end plates
- Automatic Thermal Overload Protector
- Standard 48 Frame Motor Casing Size
- Low Power Consumption
- 60 C Ambient Design
- Electrically Reversible
- Continuous Air Over
- Class B Insulation
- Quiet Operation
- Extended Studs
- 30" Leads
- 60 HZ



**BALL BEARINGS NOW STANDARD**



| CATALOG NO.     | HP  | VOLTAGE | SPEED  | FLA | UOM | ORDER MULTIPLE |
|-----------------|-----|---------|--------|-----|-----|----------------|
| <b>WG840727</b> | 1/6 | 208-230 | 1075/1 | 1.3 | EA  | 1              |
| <b>WG840728</b> | 1/4 | 208-230 | 1075/1 | 2.2 | EA  | 1              |
| <b>WG840729</b> | 1/3 | 208-230 | 1075/1 | 2.8 | EA  | 1              |
| <b>WG840730</b> | 1/2 | 208-230 | 1075/1 | 4.2 | EA  | 1              |
| <b>WG840731</b> | 3/4 | 208-230 | 1075/1 | 4.5 | EA  | 1              |
| <b>WG840204</b> | 1/4 | 208-230 | 825/1  | 1.5 | EA  | 1              |
| <b>WG840205</b> | 1/3 | 208-230 | 825/1  | 2.2 | EA  | 1              |

**Wagner® High Temperature Condenser Fan Motors**

- 70°C Ambient Temperature
- Installs with all Standard 48 Frame Mounting Brackets
- Standard Shaft Length, Diameter, and Flats
- Drain Holes with Plugs in both end plates
- Automatic Thermal Overload Protector
- Standard 48 Frame Motor Casing Size
- Low Power Consumption
- Electrically Reversible
- Continuous Air Over
- Class B Insulation
- Quiet Operation
- Extended Studs
- 30" Leads
- 60 HZ



**BALL BEARINGS NOW STANDARD**



| CATALOG NO.       | HP  | VOLTAGE | SPEED  | FLA  | UOM | ORDER MULTIPLE |
|-------------------|-----|---------|--------|------|-----|----------------|
| <b>WG840728HT</b> | 1/4 | 208-230 | 1075/1 | 2.2  | EA  | 1              |
| <b>WG840729HT</b> | 1/3 | 208-230 | 1075/1 | 2.8  | EA  | 1              |
| <b>WG840730HT</b> | 1/2 | 208-230 | 1075/1 | 4.2  | EA  | 1              |
| <b>WG840731HT</b> | 3/4 | 208-230 | 1075/1 | 5.3  | EA  | 1              |
| <b>WG840736HT</b> | 1/4 | 460     | 1075/1 | 1.65 | EA  | 1              |
| <b>WG840737HT</b> | 1/3 | 460     | 1075/1 | 2.85 | EA  | 1              |
| <b>WG840738HT</b> | 1/2 | 460     | 1075/1 | 4.3  | EA  | 1              |
| <b>WG840739HT</b> | 3/4 | 460     | 1075/1 | 5.3  | EA  | 1              |
| <b>WG840204HT</b> | 1/4 | 208-230 | 825/1  | 1.5  | EA  | 1              |
| <b>WG840205HT</b> | 1/3 | 208-230 | 825/1  | 2.2  | EA  | 1              |

**Wagner® Multiple Horsepower Condenser Fan Motors**

The Multi-Horsepower motors are specially designed to cover a range of applications. The condenser fan motors range from 1/2 to 1/5; 1/3 to 1/6 both at 1075 rpm; 1/3 to 1/6 at 825rpm. These motors feature reversing plugs, extended thru bolts 36 inch leads and are designed for 370 volt capacitors. Installs with all 48 frame mounting brackets.



**BALL BEARINGS NOW STANDARD**



| CATALOG NO.     | APPLICATION | VOLTAGE | SPEED  | (1) HP-FLA | (2) HP-FLA | (3) HP-FLA | (4) HP-FLA | (5) HP-FLA | UOM | ORDER MULTIPLE |
|-----------------|-------------|---------|--------|------------|------------|------------|------------|------------|-----|----------------|
| <b>WG840465</b> | CF          | 208-230 | 1075/2 | 1/3-2.8    | 1/4-2.0    | 1/5-1.7    | 1/6-1.5    | -          | EA  | 1              |
| <b>WG840468</b> | CF          | 208-230 | 1075/2 | 1/2-3.0    | 1/3-2.5    | 1/4-2.0    | 1/5-1.3    | -          | EA  | 1              |
| <b>WG840469</b> | CF          | 208-230 | 825/2  | 1/3-2.1    | 1/4-1.7    | 1/5-1.5    | 1/6-1.2    | -          | EA  | 1              |

**Wagner® Direct Drive Furnace Blower Motors**

- Installs with all Standard 48 Frame Mounting Brackets
- Standard Shaft Length, Diameter, and Flats
- Uses 370V Capacitors
- Standard 48 Frame Motor Casing Size
- 2.5" Diameter Hub Rings included
- Low Power Consumption
- Automatic Thermal Overload Protector
- Continuous Duty, Air Over
- Electrically Reversible
- Class B Insulation
- Speed: 1075/3
- Quiet Operation
- 60 HZ

| CATALOG NO.     | HP  | VOLTAGE | SPEED  | FLA  | UOM | ORDER MULTIPLE |
|-----------------|-----|---------|--------|------|-----|----------------|
| <b>WG840583</b> | 1/4 | 115     | 1075/3 | 4.6  | EA  | 1              |
| <b>WG840584</b> | 1/4 | 208-230 | 1075/3 | 2.2  | EA  | 1              |
| <b>WG840585</b> | 1/3 | 115     | 1075/3 | 6.7  | EA  | 1              |
| <b>WG840586</b> | 1/3 | 208-230 | 1075/3 | 2.9  | EA  | 1              |
| <b>WG840587</b> | 1/2 | 115     | 1075/3 | 10.2 | EA  | 1              |
| <b>WG840588</b> | 1/2 | 208-230 | 1075/3 | 5.0  | EA  | 1              |
| <b>WG840589</b> | 3/4 | 115     | 1075/3 | 11.3 | EA  | 1              |
| <b>WG840590</b> | 3/4 | 208-230 | 1075/3 | 5.4  | EA  | 1              |
| <b>WG840595</b> | 1   | 115     | 1075/3 | 12.6 | EA  | 1              |
| <b>WG840596</b> | 1   | 208-230 | 1075/3 | 5.59 | EA  | 1              |

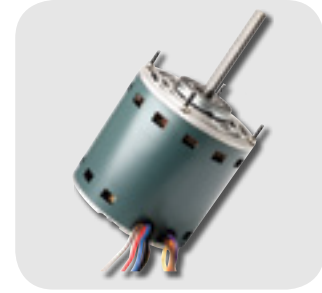

**Wagner® Multiple Horsepower Furnace Blower Motors**

The Multi-Horsepower motors are specially designed to cover a range of applications. The direct drive furnace blower motors range from 1/2 to 1/6 in both 115 and 230 volts and 3/4 to 1/5 in both 115 and 230 volts all at 1075rpm. These motors feature reversing plugs, extended thru bolts 36 inch leads and are designed for 370 volt capacitors. Installs with all 48 frame mounting brackets.

| CATALOG NO.     | APPLICATION | VOLTAGE | SPEED  | (1) HP-FLA | (2) HP-FLA | (3) HP-FLA | (4) HP-FLA | (5) HP-FLA | UOM | ORDER MULTIPLE |
|-----------------|-------------|---------|--------|------------|------------|------------|------------|------------|-----|----------------|
| <b>WG840463</b> | DDFB        | 115     | 1075/4 | 1/2-7.0    | 1/3-6.7    | 1/4-4.4    | 1/5-3.2    | 1/6-2.4    | EA  | 1              |
| <b>WG840464</b> | DDFB        | 208-230 | 1075/4 | 1/2-3.9    | 1/3-3.6    | 1/4-2.5    | 1/5-1.8    | 1/6-1.3    | EA  | 1              |
| <b>WG840466</b> | DDFB        | 115     | 1075/4 | 3/4-8.1    | 1/2-6.6    | 1/3-4.6    | 1/4-3.8    | 1/5-3.1    | EA  | 1              |
| <b>WG840467</b> | DDFB        | 208-230 | 1075/4 | 3/4-3.8    | 1/2-3.7    | 1/3-2.5    | 1/4-1.8    | 1/5-1.7    | EA  | 1              |

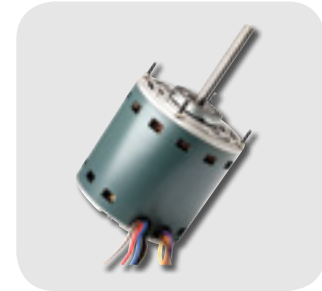

**Genteq® Single Speed Condenser Fan Motors**

- Standard 48 frame size
- Single speed with reversible rotation
- Designed for 370V capacitors with mounting holes
- 26" motor leads
- 6" shaft extension
- Automatic thermal overload protection

| CATALOG NO.  | HP  | VOLTAGE | SPEED  | FLA | UOM | ORDER MULTIPLE |
|--------------|-----|---------|--------|-----|-----|----------------|
| <b>3727</b>  | 1/6 | 208/230 | 1075/1 | 1.0 | EA  | 1              |
| <b>3728</b>  | 1/4 | 208/230 | 1075/1 | 1.8 | EA  | 1              |
| <b>3729</b>  | 1/3 | 208/230 | 1075/1 | 2.3 | EA  | 1              |
| <b>3730</b>  | 1/2 | 208/230 | 1075/1 | 3.5 | EA  | 1              |
| <b>3731</b>  | 3/4 | 208/230 | 1075/1 | 4.7 | EA  | 1              |
| <b>3202*</b> | 1/8 | 208/230 | 825/1  | 0.9 | EA  | 1              |
| <b>3203*</b> | 1/6 | 208/230 | 825/1  | 1.0 | EA  | 1              |
| <b>3205*</b> | 1/3 | 208/230 | 825/1  | 1.9 | EA  | 1              |
| <b>3746</b>  | 1/2 | 208/230 | 825/1  | 3.4 | EA  | 1              |

\*Ball Bearing





**MOTORS cont'd**

**Genteq® High Temperature Condenser Fan Motors**

- Standard 48 frame size
- Designed for 70°C ambient operation
- 48" motor leads
- Extended thru bolts on both ends
- Drain holes in both endshields with plug
- Automatic thermal overload protection
- Ball Bearing

| CATALOG NO.   | HP      | VOLTAGE | SPEED  | FLA | UOM | ORDER MULTIPLE |
|---------------|---------|---------|--------|-----|-----|----------------|
| <b>3726HS</b> | 1/6     | 208/230 | 1075/1 | 1.0 | EA  | 1              |
| <b>3732HS</b> | 1/4     | 208/230 | 1075/1 | 1.7 | EA  | 1              |
| <b>3733HS</b> | 1/3     | 208/230 | 1075/1 | 2.6 | EA  | 1              |
| <b>3734HS</b> | 1/2     | 208/230 | 1075/1 | 3.0 | EA  | 1              |
| <b>3735HS</b> | 3/4     | 208/230 | 1075/1 | 4.1 | EA  | 1              |
| <b>3203HS</b> | 1/6     | 208/230 | 825/1  | 0.9 | EA  | 1              |
| <b>3204HS</b> | 1/4     | 208/230 | 825/1  | 1.3 | EA  | 1              |
| <b>3205HS</b> | 1/3     | 208/230 | 825/1  | 1.8 | EA  | 1              |
| <b>3747HS</b> | 1/2     | 208/230 | 825/1  | 2.8 | EA  | 1              |
| <b>3736HS</b> | 1/4     | 460     | 1075/1 | 0.7 | EA  | 1              |
| <b>3737HS</b> | 1/3     | 460     | 1075/1 | 1.2 | EA  | 1              |
| <b>3738HS</b> | 1/2     | 460     | 1075/1 | 1.7 | EA  | 1              |
| <b>3739HS</b> | 3/4     | 460     | 1075/1 | 2.0 | EA  | 1              |
| <b>3469HS</b> | 1/3-1/6 | 208/230 | 825/2  | 2.0 | EA  | 1              |
| <b>3465HS</b> | 1/3-1/6 | 208/230 | 1075/2 | 2.5 | EA  | 1              |
| <b>3468HS</b> | 1/2-1/5 | 208/230 | 1075/2 | 3.1 | EA  | 1              |
| <b>3459HS</b> | 1/3-1/8 | 208/230 | 825/1  | 1.8 | EA  | 1              |
| <b>3458HS</b> | 1/3-1/6 | 208/230 | 1075/1 | 2.6 | EA  | 1              |



**Genteq® Multiple Horsepower Condenser Fan Motors**

- Standard 48 frame size
- One or two speeds with reversible rotation
- Extended clamp screws and resilient rings with Rheem mounting holes
- Hardware included
- Water slinger on shaft
- Automatic thermal overload protection
- Ball Bearing

| CATALOG NO. | HP      | VOLTAGE | SPEED  | FLA | UOM | ORDER MULTIPLE |
|-------------|---------|---------|--------|-----|-----|----------------|
| <b>3458</b> | 1/3-1/6 | 208/230 | 1075/1 | 2.7 | EA  | 1              |
| <b>3459</b> | 1/3-1/8 | 208/230 | 825/1  | 1.9 | EA  | 1              |
| <b>3465</b> | 1/3-1/6 | 208/230 | 1075/2 | 6.2 | EA  | 1              |
| <b>3468</b> | 1/3-1/6 | 208/230 | 1075/2 | 4.2 | EA  | 1              |
| <b>3469</b> | 1/2-1/5 | 208/230 | 825/2  | 8.4 | EA  | 1              |



**Genteq® Direct Drive Furnace Blower Motors**

- Standard 48 frame size
- 3 speeds at 1075 RPM
- 115V or 208-230V options available
- 4" shaft extension
- Reversible rotation
- Mounting holes for capacitor mounting bracket
- Automatic thermal overload protection

| CATALOG NO.  | HP  | VOLTAGE | SPEED  | FLA  | UOM | ORDER MULTIPLE |
|--------------|-----|---------|--------|------|-----|----------------|
| <b>3583</b>  | 1/4 | 115     | 1075/3 | 4.2  | EA  | 1              |
| <b>3584</b>  | 1/4 | 208/230 | 1075/3 | 2.0  | EA  | 1              |
| <b>3585</b>  | 1/3 | 115     | 1075/3 | 6.1  | EA  | 1              |
| <b>3586</b>  | 1/3 | 208/230 | 1075/3 | 2.7  | EA  | 1              |
| <b>3587</b>  | 1/2 | 115     | 1075/3 | 9.0  | EA  | 1              |
| <b>3588</b>  | 1/2 | 208/230 | 1075/3 | 5.0  | EA  | 1              |
| <b>3589</b>  | 3/4 | 115     | 1075/3 | 11.8 | EA  | 1              |
| <b>3590</b>  | 3/4 | 208/230 | 1075/3 | 5.0  | EA  | 1              |
| <b>3595*</b> | 1   | 115     | 1075/3 | 11.8 | EA  | 1              |
| <b>3596*</b> | 1   | 208/230 | 1075/3 | 5.6  | EA  | 1              |

\*Ball Bearing



**MOTORS cont'd**

**Genteq® Multiple Horsepower Furnace Blower Motors**

- Standard 48 frame size
- Four speeds with reversible rotation
- Extended clamp screws and resilient rings with Rheem mounting holes
- Hardware included
- 115V or 208-230V options available
- Automatic thermal overload protection

| CATALOG NO.  | HP      | VOLTAGE | SPEED  | FLA | UOM | ORDER MULTIPLE |
|--------------|---------|---------|--------|-----|-----|----------------|
| <b>3463</b>  | 1/2-1/6 | 115     | 1075/4 | 6.2 | EA  | 1              |
| <b>3464</b>  | 1/2-1/6 | 208/230 | 1075/4 | 2.7 | EA  | 1              |
| <b>3466*</b> | 3/4-1/5 | 115     | 1075/4 | 8.5 | EA  | 1              |
| <b>3467*</b> | 3/4-1/5 | 208/230 | 1075/4 | 4.2 | EA  | 1              |

\*Ball Bearing

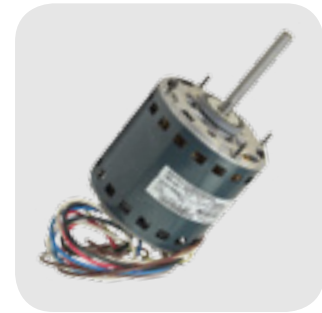

**Evergreen® ECM Motors**

- Standard 48 frame size
- Multi-speed, constant torque, brushless DC motor
- EM series is designed to replace X13 or equivalent ECM motors.
- OM and IM series are designed to replace PSC motors.
- Soft Start and Off Ramp for quiet operation
- Encapsulated electronics
- 4kV surge protection
- Electronic overload protection

| CATALOG NO.  | HP  | VOLTAGE | SPEED     | FLA      | TYPE      | UOM | ORDER MULTIPLE |
|--------------|-----|---------|-----------|----------|-----------|-----|----------------|
| <b>6103E</b> | 1/3 | 115     | 600-1200  | 4.8      | EM SERIES | EA  | 1              |
| <b>6203E</b> | 1/3 | 208/230 | 600-1200  | 2.8      | EM SERIES | EA  | 1              |
| <b>6105E</b> | 1/2 | 115     | 600-1200  | 6.8      | EM SERIES | EA  | 1              |
| <b>6205E</b> | 1/2 | 208/230 | 600-1200  | 4.1      | EM SERIES | EA  | 1              |
| <b>6107E</b> | 3/4 | 115     | 600-1200  | 8.4      | EM SERIES | EA  | 1              |
| <b>6207E</b> | 3/4 | 208/230 | 600-1200  | 6.0      | EM SERIES | EA  | 1              |
| <b>6110E</b> | 1   | 115     | 600-1200  | 10.9     | EM SERIES | EA  | 1              |
| <b>6210E</b> | 1   | 208/230 | 600-1200  | 7.6      | EM SERIES | EA  | 1              |
| <b>6301</b>  | 1/5 | 208/230 | 850-1100  | 2.8      | OM SERIES | EA  | 1              |
| <b>6303</b>  | 1/3 | 208/230 | 850-1100  | 3.5      | OM SERIES | EA  | 1              |
| <b>6005</b>  | 1/2 | 115/230 | 1000-1075 | 6.7/4.0  | IM SERIES | EA  | 1              |
| <b>6010</b>  | 1   | 115/230 | 1000-1075 | 11.0/6.7 | IM SERIES | EA  | 1              |



**Fasco® 3.3 in. Walk-In Cooler/Freezer Refrigeration Motors**

The Fasco 3-in1 motor is a universal replacement motor for walk-in cooler and freezer evaporator applications. This motor replaces 1/12, 1/15 & 1/20hp PSC and Shaded pole motors. Designed for use down to 40°C applications with low temp lubrication.

| CATALOG NO. | HP               | VOLTAGE     | SPEED | FLA     | UOM | ORDER MULTIPLE |
|-------------|------------------|-------------|-------|---------|-----|----------------|
| <b>9721</b> | 1/12, 1/15, 1/20 | 115/208-230 | 1550  | 1.1/0.5 | EA  | 1              |



**Wellington® ECM Refrigeration Motors**

Wellington ECM Refrigeration Motors are electronically commutated brushless DC motors. Top quality electronics and design make these motors extremely efficient, quiet and reliable. Long design life and reliability are the result of Wellington's moisture proof patented design and the use of ball bearings; and allow significant maintenance and cost savings. Wellington motors use the same mounting systems as shaded pole motors and are provided with a plug in connection for easy, fast replacement.

| CATALOG NO.      | WATT | VOLTAGE | SPEED | FLA  | UOM | ORDER MULTIPLE |
|------------------|------|---------|-------|------|-----|----------------|
| <b>ECR01-9W</b>  | 9    | 115     | 1500  | 0.23 | EA  | 1              |
| <b>ECR01-12W</b> | 12   | 115     | 1550  | 0.31 | EA  | 1              |



## MOTOR BRACKETS

### DiversiTech® Motors Bracket

These brackets help hold the motor securely.



| CATALOG NO.  | DESCRIPTION  | UOM | ORDER MULTIPLE |
|--------------|--|-----|----------------|
| <b>DMB-1</b> | Fixed Lug Assembly for 5-1/2" diameter motors      | EA  | 1              |
| <b>DMB-2</b> | Adjustable Lug Assembly for 5-1/2" diameter motors | EA  | 1              |

### Motor Mount – Flex Bracket

Torsion Flex Bracket holds motor securely. Fits 5- 1/2" motors. Typically used for Goodman equipment.



| CATALOG NO.  | DESCRIPTION                             | UOM | ORDER MULTIPLE |
|--------------|---|-----|----------------|
| <b>DMB-3</b> | 5-1/2" Motor Mount Torsion Flex Bracket | EA  | 1              |

### Rheem Motor Bracket

These brackets help hold the motor securely.



| CATALOG NO.    | DESCRIPTION                               | UOM | ORDER MULTIPLE |
|----------------|---|-----|----------------|
| <b>A60306K</b> | Mounting Plate for Rheem Condensing Units | EA  | 1              |

## BEARINGS

### Cushioned Pillow Blocks

These blocks are used to reduce noise from vibration from motors.

| CATALOG NO.    | DESCRIPTION                 | INDUSTRY NO. | LAU NO.    | BEARING SHAFT SIZE | UOM | ORDER MULTIPLE |
|----------------|-----------------------------|--------------|------------|--------------------|-----|----------------|
| <b>535-BB1</b> | Bronze Bearing Pillow Block | NAH8A        |            | 1/2"               | EA  | 1              |
| <b>535-BB2</b> | Bronze Bearing Pillow Block | NAH10A       | 38-2204-01 | 5/8"               | EA  | 1              |
| <b>535-BB3</b> | Bronze Bearing Pillow Block | NAH12A       | 38-2086-01 | 3/4"               | EA  | 1              |
| <b>535-BB4</b> | Bronze Bearing Pillow Block | NAH16A       | 38-2087-01 | 1"                 | EA  | 1              |



### Side Flange Mount Pillow Blocks

These blocks are used to reduce noise from vibration from motors.

| CATALOG NO.    | DESCRIPTION            | INDUSTRY NO. | BEARING SHAFT SIZE | UOM | ORDER MULTIPLE |
|----------------|------------------------|--------------|--------------------|-----|----------------|
| <b>535-BB6</b> | Cushioned Flange Block | NVH10A       | 5/8"               | EA  | 1              |



## WHIPS

### DiversiWhips

Liquid tight flexible conduit system. A labor saving convenience kit for A/C unit hookup. Also use for heat pumps, refrigeration, hot tubs, swimming pools and outdoor lighting. Three distinct wire colors for ease of hook up. 1 straight and 1 90 degree metallic or non metallic connector. 90 degree connector is removable for straight connections. (Second straight connector not included.) U.L. and C.U.L Listed.



| CATALOG NO.     | DESCRIPTION                                      | UOM | ORDER MULTIPLE |
|-----------------|--|-----|----------------|
| <b>6-12-4</b>   | 1/2 x 4' #10 THHN Wire – Metallic Connectors     | EA  | 6              |
| <b>6-12-6</b>   | 1/2 x 6' #10 THHN Wire – Metallic Connectors     | EA  | 6              |
| <b>6-34-4</b>   | 3/4 x 4' #8 THHN Wire – Metallic Connectors      | EA  | 6              |
| <b>6-34-6</b>   | 3/4 x 6' #8 THHN Wire – Metallic Connectors      | EA  | 6              |
| <b>6-34-8</b>   | 3/4 x 8' #8 THHN Wire – Metallic Connectors      | EA  | 3              |
| <b>6-12-4NM</b> | 1/2 x 4' #10 THHN Wire – Non-Metallic Connectors | EA  | 6              |
| <b>6-12-6NM</b> | 1/2 x 6' #10 THHN Wire – Non-Metallic Connectors | EA  | 6              |
| <b>6-34-4NM</b> | 3/4 x 4' #8 THHN Wire – Non-Metallic Connectors  | EA  | 6              |
| <b>6-34-6NM</b> | 3/4 x 6' #8 THHN Wire – Non-Metallic Connectors  | EA  | 6              |
| <b>6-34-8NM</b> | 3/4 x 8' #8 THHN Wire – Non-Metallic Connectors  | EA  | 3              |

### DiversiWhips Pallet Packs

DiversiWhips are now available in a convenient, bulk packaged pallet pack at a discounted price. Pallet pack makes an attractive floor standing display. 1 straight and 1 90 degrees metallic or non metallic connector.



| CATALOG NO.      | DESCRIPTION                                      | UOM | ORDER MULTIPLE |
|------------------|--|-----|----------------|
| <b>B6-12-4</b>   | 1/2 x 4' #10 THHN Wire – Metallic Connectors     | EA  | 90             |
| <b>B6-12-6</b>   | 1/2 x 6' #10 THHN Wire – Metallic Connectors     | EA  | 60             |
| <b>B6-34-6</b>   | 3/4 x 6' #8 THHN Wire – Metallic Connectors      | EA  | 45             |
| <b>B6-12-4NM</b> | 1/2 x 4' #10 THHN Wire – Non-Metallic Connectors | EA  | 90             |
| <b>B6-12-6NM</b> | 1/2 x 6' #10 THHN Wire – Non-Metallic Connectors | EA  | 60             |
| <b>B6-34-4NM</b> | 3/4 x 4' #8 THHN Wire – Non-Metallic Connectors  | EA  | 60             |
| <b>B6-34-6NM</b> | 3/4 x 6' #8 THHN Wire – Non-Metallic Connectors  | EA  | 45             |

\*For DiversiWhips produced with 2 straight connectors, add S to part number (ex: 6-12-4S).



### DiversiWhips for the Swimming Pool Industry

A labor saving kit for hookup of swimming pool motors, pumps, filters, and timers. Three distinct wire colors for ease of hookup. 1 straight and 1 90 degree non-metallic connector included.



6-12-6NMP

| CATALOG NO. | DESCRIPTION                     | UOM | ORDER MULTIPLE |
|-------------|---------------------------------|-----|----------------|
| 6-12-4NMP   | 1/2 x 4' #12 THHN Wire – In Bag | EA  | 6              |
| 6-12-6NMP   | 1/2 x 6' #12 THHN Wire – In Bag | EA  | 6              |
| 6-12-8NMP   | 1/2 x 8' #12 THHN Wire – In Bag | EA  | 6              |
| 6-12-4NMSP  | 1/2 x 4' #10 THHN Wire – In Box | EA  | 6              |
| 6-12-6NMSP  | 1/2 x 6' #10 THHN Wire – In Box | EA  | 6              |
| 6-34-4NMSP  | 3/4 x 4' #8 THHN Wire – In Box  | EA  | 6              |
| 6-34-6NMSP  | 3/4 x 6' #8 THHN Wire – In Box  | EA  | 6              |

#### Solid Wire Whips

|              |  |    |   |
|--------------|--|----|---|
| 6-12-4NMSWP  | 1/2 x 4' #12 Solid 3 Wire – Non-Metallic Conn. | EA | 6 |
| 6-12-6NMSWP  | 1/2 x 6' #12 Solid 3 Wire – Non-Metallic Conn. | EA | 6 |
| 6-12-8NMSWP  | 1/2 x 8' #12 Solid 3 Wire – Non-Metallic Conn. | EA | 3 |
| 6-12-6NM4SWP | 1/2 x 6' #12 Solid 4 Wire – Non-Metallic Conn. | EA | 6 |

### DiversiWhips with Extended Length Wires

DiversiWhips are available with extra long lead wires for those difficult to wire applications. These whips offer 10in. of lead wire on the straight side and 18in. of lead wire on the 90 degree side.



6-12-4R

| CATALOG NO. | DESCRIPTION                                      | UOM | ORDER MULTIPLE |
|-------------|--|-----|----------------|
| 6-12-6R     | 1/2 x 6' #10 THHN Wire – Metallic Connectors     | EA  | 6              |
| 6-34-4R     | 3/4 x 4' #8 THHN Wire – Metallic Connectors      | EA  | 6              |
| 6-34-6R     | 3/4 x 6' #8 THHN Wire – Metallic Connectors      | EA  | 6              |
| 6-12-4NMR   | 1/2 x 4' #10 THHN Wire – Non-Metallic Connectors | EA  | 6              |
| 6-12-6NMR   | 1/2 x 6' #10 THHN Wire – Non-Metallic Connectors | EA  | 6              |
| 6-34-4NMR   | 3/4 x 4' #8 THHN Wire – Non-Metallic Connectors  | EA  | 6              |
| 6-34-6NMR   | 3/4 x 6' #8 THHN Wire – Non-Metallic Connectors  | EA  | 6              |

## DIVERSITECH ELECTRICAL DISCONNECTS

### Disconnects—Metal Case

Fused model designed with fuses in pull out handle for easy replacement. The line, load, and ground terminals are aligned for ease of wiring. This product has a reversible door which opens to either the left or right. The side open door opens more than 180 degrees for maximum access and has a full dead front. The fused models have indicator lights for blown fuses. This is rain tight and sleet resistant. The UL Listed number is IRF9, NEMA Type 3R and the US Patent is 6,630,637.



DDS-60

| CATALOG NO. | DESCRIPTION                       | UOM | ORDER MULTIPLE |
|-------------|-----------------------------------|-----|----------------|
| DDS-30      | 30A Fusible Disconnect Switch     | EA  | 10             |
| DDS-60      | 60A Fusible Disconnect Switch     | EA  | 10             |
| DDS-60U     | 60A Non-Fusible Disconnect Switch | EA  | 10             |

### Disconnects—Non-Metallic Case

This 60 amp non-fusible disconnect is housed in a lightweight, non-metallic case. It features a side opening door with more than 180° access, full dead front, and a locking tab.



750-P60NF

| CATALOG NO. | DESCRIPTION   | UOM | ORDER MULTIPLE |
|-------------|---|-----|----------------|
| 750-P60NF   | 60A Non Fusible Disconnect Switch, Non-Metallic Case, Plastic | EA  | 10             |

### Low Profile Disconnects—Metal Case

This low profile disconnect switch is a slightly smaller design than that of the standard DiversiTech disconnects. This has a side opening door with a full dead front. This is rain tight and sleet resistant. The UL Listed number is IRF9, NEMA Type 3R.



EDS-12-6NM

EDS-60U

| CATALOG NO. | DESCRIPTION                       | UOM | ORDER MULTIPLE |
|-------------|-----------------------------------|-----|----------------|
| EDS-60U     | 60A Non-Fusible Disconnect Switch | EA  | 10             |
| EDS-12-6NM  | Disconnect and Whip Combo Kit     | EA  | 3              |

**EATON ELECTRICAL DISCONNECTS**

**Eaton Switch A/C Disconnect**

This A/C Disconnect is 60 amps switch rated for 10 HP motors at 240VAC. The switch is an on off circuit breaker with no pull out head that could be lost or stolen. It has easy-to-remove front cover with no screws or fasteners to remove.



DPB222R



| CATALOG NO. | DESCRIPTION            | UOM | ORDER MULTIPLE |
|-------------|------------------------|-----|----------------|
| DPB222R     | 60A molded case switch | EA  | 1              |

**Eaton Three Phase Disconnects**

These disconnects are UL listed and meet UL 98 for enclosed switches and NEMA Std. KS-1. They are suitable as service entrance equipment when applied with neutral or ground lug kit. They come with rainproof NEMA 3R enclosure.



DG322NRB



| CATALOG NO. | DESCRIPTION                | UOM | ORDER MULTIPLE |
|-------------|----------------------------|-----|----------------|
| DG321NRB    | Fusible 30 Amp, 240VAC     | EA  | 1              |
| DG322NRB    | Fusible 60 Amp, 240VAC     | EA  | 1              |
| DG322URB    | Non-fusible 60 Amp, 240VAC | EA  | 1              |

**CONDUIT, FITTINGS, CABLE**

**DiversiTite™ Flexible Conduit**

For electrical applications: outside, inside and industrial uses including transformer connections, air conditioning and heating. Joins with metallic or non-metallic connectors, easy to cut. Impact resistant, chemical resistant, and will not kink. U.L. and C.U.L. Listed. For use as indicated in Article 351 of the 1987 NEC.



750-12100

| CATALOG NO. | DESCRIPTION   | UOM | ORDER MULTIPLE |
|-------------|---|-----|----------------|
| 750-38100   | 3/8" x 100' Liquid Tite Conduit – Non-Metallic, 100' per roll   | EA  | 1              |
| 750-12100   | 1/2" x 100' Liquid Tite Conduit – Non-Metallic, 100' per roll   | EA  | 1              |
| 750-500     | 1/2" x 100' Liquid Tite Conduit – Metallic, 100' per roll       | EA  | 1              |
| 750-34100   | 3/4" x 100' Liquid Tite Conduit – Non-Metallic, 100' per roll   | EA  | 1              |
| 750-600     | 3/4" x 100' Liquid Tite Conduit – Metallic, 100' per roll       | EA  | 1              |
| 750-10100   | 1" x 100' Liquid Tite Conduit – Non-Metallic, 100' per roll     | EA  | 1              |
| 750-125100  | 1-1/4" x 100' Liquid Tite Conduit – Non-Metallic, 100' per roll | EA  | 1              |
| 750-1550    | 1-1/2" x 50' Liquid Tite Conduit – Non-Metallic, 50' per roll   | EA  | 1              |
| 750-2050    | 2" x 50' Liquid Tite Conduit – Non-Metallic, 50' per roll       | EA  | 1              |
| 750-10500   | 1" x 500' Liquid Tite Conduit – Non-Metallic, 500' per roll     | EA  | 1              |
| 750-121000  | 1/2" x 1000' Liquid Tite Conduit – Non-Metallic, 1000' per roll | EA  | 1              |
| 750-34800   | 3/4" x 800' Liquid Tite Conduit – Non-Metallic, 800' per roll   | EA  | 1              |

**Single Piece Liquid Tite Fittings**

Conduit threads onto ferrule and up inside the outer body. An inside taper squeezes down on the outside of conduit for a superior liquid tight seal. The cut portion of the conduit does not show, giving a more finished appearance. Easy to use at a lower cost than regular liquid tite fittings.



750-SLTC9050

750-SLTC50

| CATALOG NO.  | DESCRIPTION                    | UOM | ORDER MULTIPLE |
|--------------|--------------------------------|-----|----------------|
| 750-SLTC50   | 1/2" Straight Screw-On Fitting | EA  | 25             |
| 750-SLTC9050 | 1/2" 90° Screw-On Fitting      | EA  | 25             |
| 750-SLTC75   | 3/4" Straight Screw-On Fitting | EA  | 25             |
| 750-SLTC9075 | 3/4" 90° Screw-On Fitting      | EA  | 25             |

**Liquid Tite Connectors**

For use with metallic and non metallic liquid tite conduit, Type B. Provides smooth connection, no sharp edges to strip wire. Wiring easily pulled through. U. L. Listed. C.U.L. Listed.



750-MLT50 750-NMLT50

750-NMLT9050

| CATALOG NO.     | DESCRIPTION                                   | UOM | ORDER MULTIPLE |
|-----------------|---|-----|----------------|
| 750-NMLT50      | 1/2" Non-Metallic Straight Connector          | EA  | 25             |
| 750-NMLT4550    | 1/2" Non-Metallic 45 Degree Elbow Connector   | EA  | 10             |
| 750-NMLT9050    | 1/2" Non-Metallic 90 Degree Elbow Connector   | EA  | 10             |
| 750-NMLT75      | 3/4" Non-Metallic Straight Connector          | EA  | 10             |
| 750-NMLT4575    | 3/4" Non-Metallic 45 Degree Elbow Connector   | EA  | 10             |
| 750-NMLT9075    | 3/4" Non-Metallic 90 Degree Elbow Connector   | EA  | 10             |
| 750-NMLT100     | 1" Non-Metallic Straight Connector            | EA  | 5              |
| 750-NMLT90100   | 1" Non-Metallic 90 Degree Elbow Connector     | EA  | 5              |
| 750-MLT50       | 1/2" Metallic Straight Connector              | EA  | 25             |
| 750-MLT9050     | 1/2" Metallic 90 Degree Elbow Connector       | EA  | 10             |
| 750-MLT75       | 3/4" Metallic Straight Connector              | EA  | 10             |
| 750-MLT9075     | 3/4" Metallic 90 Degree Elbow Connector       | EA  | 10             |
| 750-NMLT125     | 1-1/4" Non-Metallic Straight Connector        | EA  | 1              |
| 750-NMLT90125   | 1-1/4" Non-Metallic 90 Degree Elbow Connector | EA  | 1              |
| 750-NMLT5090-F  | 1/2" Non-Metallic Adjustable Connector        | EA  | 10             |
| 750-NMLT7590-F  | 3/4" Non-Metallic Adjustable Connector        | EA  | 10             |
| 750-TZNMLT200   | 2" NM Topaz                                   | EA  | 2              |
| 750-TZNMLT90200 | 2" NM Topaz 90 Degree                         | EA  | 1              |
| 750-TZNMLT150   | 1-1/2" NM Topaz                               | EA  | 5              |
| 750-TZNMLT90150 | 1-1/2" NM Topaz 90 Degree                     | EA  | 2              |
| 750-TZNMLT125   | 1-1/4" NM Topaz                               | EA  | 5              |
| 750-TZNMLT90125 | 1-1/4" NM Topaz 90 Degree                     | EA  | 2              |
| 750-TZNMLT100   | 1" NM Topaz                                   | EA  | 5              |
| 750-TZNMLT90100 | 1" NM Topaz 90 Degree                         | EA  | 5              |
| 750-TZNMLT38    | 3/8" NM Topaz                                 | EA  | 10             |
| 750-TZNMLT9038  | 3/8" NM Topaz 90 Degree                       | EA  | 25             |
| 750-TZNMLT50    | 1/2" NM Topaz                                 | EA  | 25             |
| 750-TZNMLT9050  | 1/2" NM Topaz 90 Degree                       | EA  | 10             |
| 750-TZNMLT75    | 3/4" NM Topaz                                 | EA  | 10             |
| 750-TZNMLT9075  | 3/4" NM Topaz 90 Degree                       | EA  | 10             |

**CONDUIT, FITTINGS, CABLE cont'd**

**Aluminum Armored MC Cable**

90° C Rated aluminum metal clad cable system. THHN solid copper with specially compounded heat-resistant U.L. Listed insulation and jacket. Flexible interlocked aluminum armor. Extremely durable – withstands severe handling. U.L. Listed #4. Conforms to NEC article 333.



| CATALOG NO.    | DESCRIPTION                                       | UOM | ORDER MULTIPLE |
|----------------|---|-----|----------------|
| <b>640-122</b> | 12-2 Aluminum Armored MC Cable – 100' per roll EA | EA  | 1              |
| <b>640-142</b> | 14-2 Aluminum Armored MC Cable – 100' per roll EA | EA  | 1              |

**Romex Connectors – Metallic**

These Metallic Romex Connectors are made of zinc die cast are cable connectors for Romex wire. U.L. Listed C.S.A. Approved.



| CATALOG NO.      | DESCRIPTION                             | UOM | ORDER MULTIPLE |
|------------------|---|-----|----------------|
| <b>750-RC841</b> | 3/8" Romex Connector for 1/2" Knockouts | EA  | 100            |
| <b>750-RC842</b> | 3/4" Romex Connector for 3/4" Knockouts | EA  | 50             |

U.L. Listed and C.S.A. Approved.

**BX Set Screw Connectors**

These connectors are for BX cable range of .445 to .630 in diameter. This product is UL listed and CSA approved.



| CATALOG NO.    | DESCRIPTION       | UOM | ORDER MULTIPLE |
|----------------|-------------------|-----|----------------|
| <b>640-845</b> | Trade Size – 3/8" | EA  | 100            |

**Non-Metallic Sheathed Cable (Romex Wire)**

600V building wire. Easy to pull and strip, flame and moisture resistant. Saves time, labor and money. Color coded conductors of copper, PVC insulation and outer jacket with ground. U.L. Listed 719 Federal Specifications J C94.



| CATALOG NO.     | DESCRIPTION                                      | UOM | ORDER MULTIPLE |
|-----------------|--|-----|----------------|
| <b>620-6-2</b>  | 6 AWG, 2 Conductors with Ground – 125' per pack  | EA  | 1              |
| <b>620-8-2</b>  | 8 AWG, 2 Conductors with Ground – 125' per pack  | EA  | 1              |
| <b>620-10-2</b> | 10 AWG, 2 Conductors with Ground – 250' per pack | EA  | 1              |
| <b>620-12-2</b> | 12 AWG, 2 Conductors with Ground – 250' per pack | EA  | 1              |
| <b>620-14-2</b> | 14 AWG, 2 Conductors with Ground – 250' per pack | EA  | 1              |

U.L. Listed 719 Federal Specifications J-C94.

**EMT (Thinwall) Fittings**

These are used to join EMT conduit to boxes on enclosures.



| CATALOG NO.    | DESCRIPTION                | UOM | ORDER MULTIPLE |
|----------------|----------------------------|-----|----------------|
| <b>625-800</b> | Set Screw Connector – 1/2" | EA  | 50             |
| <b>625-801</b> | Set Screw Connector – 3/4" | EA  | 25             |
| <b>625-304</b> | Strap – One Hole – 1/2"    | EA  | 100            |
| <b>625-305</b> | Strap – One Hole – 3/4"    | EA  | 100            |
| <b>625-810</b> | Set Screw Coupling – 1/2"  | EA  | 50             |
| <b>625-811</b> | Set Screw Coupling – 3/4"  | EA  | 25             |

**Cable Staples**

Cable Staples for NMB Cable (Romex) and Copper Insulated Staples for thermostat wire.



| CATALOG NO.    | DESCRIPTION                                 | UOM | ORDER MULTIPLE |
|----------------|---|-----|----------------|
| <b>625-183</b> | Romex Staples – 1/2", pack of 100           | PK  | 1              |
| <b>625-IS5</b> | Copper Insulated #5 Staples for T-Stat Wire | EA  | 100            |



**CAPACITORS**

**Motor Run Capacitors—370VAC, Metal, Oval Can**

These single capacitance oval, metal can capacitors are designed for continuous run.



| CATALOG NO. | uf   | UOM | ORDER MULTIPLE |
|-------------|------|-----|----------------|
| 37030H      | 3    | EA  | 1              |
| 37040H      | 4    | EA  | 1              |
| 37050H      | 5    | EA  | 1              |
| 37050HB     | 5    | EA  | 100*           |
| 37060H      | 6    | EA  | 1              |
| 37075H      | 7.5  | EA  | 1              |
| 37075HB     | 7.5  | EA  | 100*           |
| 37100H      | 10   | EA  | 1              |
| 37100HB     | 10   | EA  | 100*           |
| 37125H      | 12.5 | EA  | 1              |
| 37150H      | 15   | EA  | 1              |
| 37175H      | 17.5 | EA  | 1              |
| 37200H      | 20   | EA  | 1              |
| 37250H      | 25   | EA  | 1              |
| 37300H      | 30   | EA  | 1              |
| 37350H      | 35   | EA  | 1              |
| 37400H      | 40   | EA  | 1              |
| 37450H      | 45   | EA  | 1              |
| 37500H      | 50   | EA  | 1              |
| 37600H      | 60   | EA  | 1              |
| 37700H      | 70   | EA  | 1              |
| 37800H      | 80   | EA  | 1              |

\*100 per pack

**Motor Run Capacitors—370VAC**

This single capacitance round, metal can capacitors are designed for continuous run.



| CATALOG NO. | uf   | UOM | ORDER MULTIPLE |
|-------------|------|-----|----------------|
| 37050R      | 5    | EA  | 1              |
| 37075R      | 7.5  | EA  | 1              |
| 37125R      | 12.5 | EA  | 1              |
| 37150R      | 15   | EA  | 1              |
| 37175R      | 17.5 | EA  | 1              |
| 37200R      | 20   | EA  | 1              |
| 37250R      | 25   | EA  | 1              |
| 37300R      | 30   | EA  | 1              |
| 37350R      | 35   | EA  | 1              |
| 37400R      | 40   | EA  | 1              |
| 37450R      | 45   | EA  | 1              |
| 37500R      | 50   | EA  | 1              |
| 37550R      | 55   | EA  | 1              |
| 37600R      | 60   | EA  | 1              |
| 37800R      | 80   | EA  | 1              |

**Motor Run Capacitors—370VAC**

Dual capacitance. Oval, metal can.



| CATALOG NO. | uf     | UOM | ORDER MULTIPLE |
|-------------|--------|-----|----------------|
| 3GJ0515     | 15+5   | EA  | 1              |
| 3GJ0520     | 20+5   | EA  | 1              |
| 3GJ1520     | 20+15  | EA  | 1              |
| 3GJ0525     | 25+5   | EA  | 1              |
| 3GJ1025     | 25+10  | EA  | 1              |
| 3GJ0330     | 30+3   | EA  | 1              |
| 3GJ0530     | 30+5   | EA  | 1              |
| 3GJ7530     | 30+7.5 | EA  | 1              |
| 3GJ0535     | 35+5   | EA  | 1              |
| 3GJ7535     | 35+7.5 | EA  | 1              |
| 3GJ7545     | 45+7.5 | EA  | 1              |
| 3GJ0540     | 40+5   | EA  | 1              |
| 3GJ0545     | 45+5   | EA  | 1              |
| 3GJ0555     | 55+5   | EA  | 1              |
| 3GJ7555     | 55+7.5 | EA  | 1              |
| 3GJ1060     | 60+10  | EA  | 1              |

**Motor Run Capacitors—370VAC**

This dual capacitance round metal can capacitors are designed for continuous run.



| CATALOG NO. | uf     | UOM | ORDER MULTIPLE |
|-------------|--------|-----|----------------|
| 3GR0515     | 15+5   | EA  | 1              |
| 3GR0520     | 20+5   | EA  | 1              |
| 3GR0325     | 25+3   | EA  | 1              |
| 3GR0425     | 25+4   | EA  | 1              |
| 3GR0525     | 25+5   | EA  | 1              |
| 3GR0330     | 30+3   | EA  | 1              |
| 3GR0530     | 30+5   | EA  | 1              |
| 3GR7530     | 30+7.5 | EA  | 1              |
| 3GR0335     | 35+3   | EA  | 1              |
| 3GR0435     | 35+4   | EA  | 1              |
| 3GR0535     | 35+5   | EA  | 1              |
| 3GR1035     | 35+10  | EA  | 1              |
| 3GR0340     | 40+3   | EA  | 1              |
| 3GR0540     | 40+5   | EA  | 1              |
| 3GR7540     | 40+7.5 | EA  | 1              |
| 3GR0545     | 45+5   | EA  | 1              |
| 3GR0550     | 50+5   | EA  | 1              |
| 3GR0555     | 55+5   | EA  | 1              |
| 3GR7555     | 55+7.5 | EA  | 1              |
| 3GR0560     | 60+5   | EA  | 1              |
| 3GR7560     | 60+7.5 | EA  | 1              |
| 3GR0570     | 70+5   | EA  | 1              |
| 3GR0580     | 80+5   | EA  | 1              |
| 3GR7580     | 80+7.5 | EA  | 1              |
| 3GR1080     | 80+10  | EA  | 1              |

**Motor Run Capacitors—440VAC**

These single capacitance oval, metal can capacitors are designed for continuous run.



| CATALOG NO. | uf   | UOM | ORDER MULTIPLE |
|-------------|------|-----|----------------|
| 45020H      | 2    | EA  | 1              |
| 45030H      | 3    | EA  | 1              |
| 45040H      | 4    | EA  | 1              |
| 45050H      | 5    | EA  | 1              |
| 45060H      | 6    | EA  | 1              |
| 45075H      | 7.5  | EA  | 1              |
| 45100H      | 10   | EA  | 1              |
| 45125H      | 12.5 | EA  | 1              |
| 45150H      | 15   | EA  | 1              |
| 45175H      | 17.5 | EA  | 1              |
| 45200H      | 20   | EA  | 1              |
| 45250H      | 25   | EA  | 1              |
| 45300H      | 30   | EA  | 1              |
| 45350H      | 35   | EA  | 1              |
| 45400H      | 40   | EA  | 1              |
| 45450H      | 45   | EA  | 1              |
| 45500H      | 50   | EA  | 1              |
| 45550H      | 55   | EA  | 1              |
| 45600H      | 60   | EA  | 1              |
| 45700H      | 70   | EA  | 1              |
| 45800H      | 80   | EA  | 1              |

**Motor Run Capacitor—440VAC**

Single capacitance. Round, metal can.



| CATALOG NO. | uf   | UOM | ORDER MULTIPLE |
|-------------|------|-----|----------------|
| 45050R      | 5    | EA  | 1              |
| 45075R      | 7.5  | EA  | 1              |
| 45100R      | 10   | EA  | 1              |
| 45125R      | 12.5 | EA  | 1              |
| 45150R      | 15   | EA  | 1              |
| 45200R      | 20   | EA  | 1              |
| 45250R      | 25   | EA  | 1              |
| 45300R      | 30   | EA  | 1              |
| 45350R      | 35   | EA  | 1              |
| 45400R      | 40   | EA  | 1              |
| 45450R      | 45   | EA  | 1              |
| 45500R      | 50   | EA  | 1              |
| 45550R      | 55   | EA  | 1              |
| 45600R      | 60   | EA  | 1              |
| 45700R      | 70   | EA  | 1              |
| 45800R      | 80   | EA  | 1              |

**Motor Run Capacitor—440VAC**

Dual capacitance. Oval, metal can.



| CATALOG NO. | uf     | UOM | ORDER MULTIPLE |
|-------------|--------|-----|----------------|
| 4JJ0525     | 25+5   | EA  | 1              |
| 4JJ0530     | 30+5   | EA  | 1              |
| 4JJ0535     | 35+5   | EA  | 1              |
| 4JJ0540     | 40+5   | EA  | 1              |
| 4JJ0545     | 45+5   | EA  | 1              |
| 4JJ0555     | 55+5   | EA  | 1              |
| 4JJ7535     | 35+7.5 | EA  | 1              |
| 4JJ7540     | 40+7.5 | EA  | 1              |
| 4JJ7545     | 45+7.5 | EA  | 1              |
| 4JJ1055     | 55+10  | EA  | 1              |
| 4JJ0560     | 60+5   | EA  | 1              |

**Motor Run Capacitor—440VAC**

Dual capacitance. Round, metal can.



| CATALOG NO. | uf     | UOM | ORDER MULTIPLE |
|-------------|--------|-----|----------------|
| 4JR0520     | 20+5   | EA  | 1              |
| 4JR0525     | 25+5   | EA  | 1              |
| 4JR7525     | 25+7.5 | EA  | 1              |
| 4JR0530     | 30+5   | EA  | 1              |
| 4JR7530     | 30+7.5 | EA  | 1              |
| 4JR0535     | 35+5   | EA  | 1              |
| 4JR7535     | 35+7.5 | EA  | 1              |
| 4JR0440     | 40+4   | EA  | 1              |
| 4JR0540     | 40+5   | EA  | 1              |
| 4JR7540     | 40+7.5 | EA  | 1              |
| 4JR0545     | 45+5   | EA  | 1              |
| 4JR7545     | 45+7.5 | EA  | 1              |
| 4JR0550     | 50+5   | EA  | 1              |
| 4JR7550     | 50+7.5 | EA  | 1              |
| 4JR0555     | 55+5   | EA  | 1              |
| 4JR1055     | 55+10  | EA  | 1              |
| 4JR7555     | 55+7.5 | EA  | 1              |
| 4JR0560     | 60+5   | EA  | 1              |
| 4JR7560     | 60+7.5 | EA  | 1              |
| 4JR1060     | 60+10  | EA  | 1              |
| 4JR0570     | 70+5   | EA  | 1              |
| 4JR7570     | 70+7.5 | EA  | 1              |
| 4JR0580     | 80+5   | EA  | 1              |
| 4JR7580     | 80+7.5 | EA  | 1              |
| 4JR1080     | 80+10  | EA  | 1              |

**MOTOR RUN CAPACITORS (USA MADE)**

**Made in the U.S.A. Capacitors  
Round Metal Can**

Line of made in the USA capacitors featuring dual voltage for both 370V and 440V applications. Designed specifically for the demands of aftermarket service parts.



| CATALOG NO. | VOLTAGE   | uf     | UOM | ORDER MULTIPLE |
|-------------|-----------|--------|-----|----------------|
| 4JR0525U    | 370V/440V | 25+5   | EA  | 1              |
| 4JR0530U    | 370V/440V | 30+5   | EA  | 1              |
| 4JR7530U    | 370V/440V | 30+7.5 | EA  | 1              |
| 4JR0535U    | 370V/440V | 35+5   | EA  | 1              |
| 4JR7535U    | 370V/440V | 35+7.5 | EA  | 1              |
| 4JR0540U    | 370V/440V | 40+5   | EA  | 1              |
| 4JR7540U    | 370V/440V | 40+7.5 | EA  | 1              |
| 4JR0545U    | 370V/440V | 45+5   | EA  | 1              |
| 4JR7545U    | 370V/440V | 45+7.5 | EA  | 1              |
| 4JR0550U    | 370V/440V | 50+5   | EA  | 1              |
| 4JR7550U    | 370V/440V | 50+7.5 | EA  | 1              |
| 4JR0555U    | 370V/440V | 55+5   | EA  | 1              |
| 4JR7555U    | 370V/440V | 55+7.5 | EA  | 1              |
| 4JR0560U    | 370V/440V | 60+5   | EA  | 1              |
| 4JR7560U    | 370V/440V | 60+7.5 | EA  | 1              |
| 4JR0580U    | 370V/440V | 80+5   | EA  | 1              |

**Motor Start Capacitors –  
110/125 VAC**

Variable capacitance. Round, plastic can.



| CATALOG NO. | uf        | UOM | ORDER MULTIPLE |
|-------------|-----------|-----|----------------|
| 56-72       | 56-72     | EA  | 1              |
| 88-108      | 88-108    | EA  | 1              |
| 108-130     | 108-130   | EA  | 1              |
| 124-156     | 124-156   | EA  | 1              |
| 145-175     | 145-175   | EA  | 1              |
| 161-193     | 161-193   | EA  | 1              |
| 189-227     | 189-227   | EA  | 1              |
| 200-240     | 200-240   | EA  | 1              |
| 216-259     | 216-259   | EA  | 1              |
| 233-292     | 233-292   | EA  | 1              |
| 270-324     | 270-324   | EA  | 1              |
| 324-388     | 324-388   | EA  | 1              |
| 340-408     | 340-408   | EA  | 1              |
| 378-440     | 378-440   | EA  | 1              |
| 400-480     | 400-480   | EA  | 1              |
| 460-552     | 460-552   | EA  | 1              |
| 540-648     | 540-648   | EA  | 1              |
| 590-708     | 590-708   | EA  | 1              |
| 708-850     | 708-850   | EA  | 1              |
| 829-995     | 829-995   | EA  | 1              |
| 1000-1200   | 1000-1200 | EA  | 1              |

**Made in the U.S.A. Capacitors  
Oval Metal Can**

Line of made in the USA capacitors featuring dual voltage for both 370V and 440V applications. Designed specifically for the demands of aftermarket service parts.



| CATALOG NO. | VOLTAGE   | uf   | UOM | ORDER MULTIPLE |
|-------------|-----------|------|-----|----------------|
| 45050HU     | 370V/440V | 5    | EA  | 1              |
| 45075HU     | 370V/440V | 7.5  | EA  | 1              |
| 45100HU     | 370V/440V | 10   | EA  | 1              |
| 45150HU     | 370V/440V | 15   | EA  | 1              |
| 45200HU     | 370V/440V | 20   | EA  | 1              |
| 45250HU     | 370V/440V | 25   | EA  | 1              |
| 45300HU     | 370V/440V | 30   | EA  | 1              |
| 45350HU     | 370V/440V | 35   | EA  | 1              |
| 45400HU     | 370V/440V | 40   | EA  | 1              |
| 45450HU     | 370V/440V | 45   | EA  | 1              |
| 45125HU     | 370V/440V | 12.5 | EA  | 1              |
| 45500HU     | 370V/440V | 50   | EA  | 1              |
| 45600HU     | 370V/440V | 60   | EA  | 1              |
| 45700HU     | 370V/440V | 70   | EA  | 1              |
| 45800HU     | 370V/440V | 80   | EA  | 1              |

**Motor Start Capacitors –  
220/250 VAC**

Variable capacitance. Round, plastic can.



| CATALOG NO. | uf      | UOM | ORDER MULTIPLE |
|-------------|---------|-----|----------------|
| 43-53220    | 43-53   | EA  | 1              |
| 56-72220    | 56-72   | EA  | 1              |
| 72-88220    | 72-88   | EA  | 1              |
| 88-108220   | 88-108  | EA  | 1              |
| 108-130220  | 108-130 | EA  | 1              |
| 124-156220  | 124-156 | EA  | 1              |
| 145-175220  | 145-175 | EA  | 1              |
| 161-193220  | 161-193 | EA  | 1              |
| 189-227220  | 189-227 | EA  | 1              |
| 216-259220  | 216-259 | EA  | 1              |
| 233-292220  | 233-292 | EA  | 1              |
| 270-324220  | 270-324 | EA  | 1              |



**MOTOR RUN CAPACITORS (USA MADE) cont'd**

**Motor Start Capacitors – 330 VAC**

Variable capacitance. Round, plastic can.



| CATALOG NO.       | uf      | UOM | ORDER MULTIPLE |
|-------------------|---------|-----|----------------|
| <b>72-88330</b>   | 72-88   | EA  | 1              |
| <b>88-108330</b>  | 88-108  | EA  | 1              |
| <b>108-130330</b> | 108-130 | EA  | 1              |
| <b>124-156330</b> | 124-156 | EA  | 1              |
| <b>145-175330</b> | 145-175 | EA  | 1              |
| <b>161-193330</b> | 161-193 | EA  | 1              |
| <b>189-227330</b> | 189-227 | EA  | 1              |
| <b>216-259330</b> | 216-259 | EA  | 1              |
| <b>270-324330</b> | 270-324 | EA  | 1              |

**HARD START KITS**

**Torque Plus—Hard Start Kits**

Totally solid state, our DST 5 is just right for all permanent split capacitor (PSC) compressors from 1/2 to 10 H.P. It can be used on units that operate on 120 through 288 Volts. The DST 6 offers a larger capacitor for severely hard to start compressors. The DST 6 can be used on all PSC single phase compressors from 1 1/2 to 10 H.P. A unique combination of relay and safety timer. The capacitor is automatically disconnected in 0.5 seconds if the compressor fails to start.



| CATALOG NO.  | DESCRIPTION                          | UOM | ORDER MULTIPLE |
|--------------|--------------------------------------|-----|----------------|
| <b>DST-5</b> | Torque Plus – 300% Torque Multiplier | EA  | 1              |
| <b>DST-6</b> | Torque Plus – 500% Torque Multiplier | EA  | 1              |

**DiversiTech Hard Start Kits**

DiversiTech hard start kits reduce contractor call backs by boosting the starting capacitor for a compressor. This prevents home brownouts and improves homeowner satisfaction with your service. DiversiTech's hard start kits feature a potential relay that disconnects the start capacitor from the circuit at exactly the moment it is no longer needed to boost the compressor. This results in a precision compressor start even under hard starting conditions. Replaces the Kickstart KS-1 and the 5-n-1 kit.



| CATALOG NO. | DESCRIPTION                              | UOM | ORDER MULTIPLE |
|-------------|--|-----|----------------|
| <b>HSK1</b> | Hard Start Kit for 3.5 to 5HP Compressor | EA  | 1              |
| <b>HSK5</b> | Hard Start Kit for 1 to 3HP Compressor   | EA  | 1              |

**CONTACTORS**

**DiversiTech® Two Pole Definite Purpose Contactors**

Definite purpose contactors can be used for heating, air conditioning, refrigeration, data processing, and food service equipment. Quick connect terminals provide for easy wiring. This contactor comes as a two pole on a small frame.



| CATALOG NO. | FL AMPS | COIL VAC | UOM | ORDER MULTIPLE |
|-------------|---------|----------|-----|----------------|
| EC25224     | 25      | 24       | EA  | 1              |
| EC25120     | 25      | 120      | EA  | 1              |
| EC252240    | 25      | 240      | EA  | 1              |
| EC252277    | 25      | 277      | EA  | 1              |
| EC30224     | 30      | 24       | EA  | 1              |
| EC302120    | 30      | 120      | EA  | 1              |
| EC302240    | 30      | 240      | EA  | 1              |
| EC40224     | 40      | 24       | EA  | 1              |
| EC402120    | 40      | 120      | EA  | 1              |
| EC402240    | 40      | 240      | EA  | 1              |

**Eaton Definite Purpose Contactors - Three and Four Pole**

These are Eaton's standard line of C25 DP contactors. They feature pressure plates with quick connects for 25A and 30A contactors, and lugs and quick connects for 40A to 90A contactors. They are UL recognized and CSA certified components. These contactors are designed for the HVAC and refrigeration applications.



| CATALOG NO. | POLES | FL AMPS | COIL VAC | UOM | ORDER MULTIPLE |
|-------------|-------|---------|----------|-----|----------------|
| DPE253120   | 3     | 25      | 120      | EA  | 1              |
| DPE25324    | 3     | 25      | 24       | EA  | 1              |
| DPE253240   | 3     | 25      | 240      | EA  | 1              |
| DPE303120   | 3     | 30      | 120      | EA  | 1              |
| DPE30324    | 3     | 30      | 24       | EA  | 1              |
| DPE303240   | 3     | 30      | 240      | EA  | 1              |
| DPE303277   | 3     | 30      | 277      | EA  | 1              |
| DPE303480   | 3     | 30      | 480      | EA  | 1              |
| DPE403120   | 3     | 40      | 120      | EA  | 1              |
| DPE40324    | 3     | 40      | 24       | EA  | 1              |
| DPE403240   | 3     | 40      | 240      | EA  | 1              |
| DPE403480   | 3     | 40      | 480      | EA  | 1              |
| DPE503120   | 3     | 50      | 120      | EA  | 1              |
| DPE50324    | 3     | 50      | 24       | EA  | 1              |
| DPE503240   | 3     | 50      | 240      | EA  | 1              |
| DPE603120   | 3     | 60      | 120      | EA  | 1              |
| DPE60324    | 3     | 60      | 24       | EA  | 1              |
| DPE603240   | 3     | 60      | 240      | EA  | 1              |
| DPE753120   | 3     | 75      | 120      | EA  | 1              |
| DPE75324    | 3     | 75      | 24       | EA  | 1              |
| DPE753240   | 3     | 75      | 240      | EA  | 1              |
| DPE903120   | 3     | 90      | 120      | EA  | 1              |
| DPE90324    | 3     | 90      | 24       | EA  | 1              |
| DPE903240   | 3     | 90      | 240      | EA  | 1              |
| DPE304120   | 4     | 30      | 120      | EA  | 1              |
| DPE30424    | 4     | 30      | 24       | EA  | 1              |
| DPE304240   | 4     | 30      | 240      | EA  | 1              |
| DPE304277   | 4     | 30      | 277      | EA  | 1              |
| DPE404120   | 4     | 40      | 120      | EA  | 1              |
| DPE404240   | 4     | 40      | 240      | EA  | 1              |
| DPE404277   | 4     | 40      | 277      | EA  | 1              |

**DiversiTech® Three Pole Definite Purpose Contactors**

Definite purpose contactors can be used for heating, air conditioning, refrigeration, data processing, and food service equipment. Quick connect terminals provide for easy wiring. This contactor comes as a three pole on a large frame.



| CATALOG NO. | FL AMPS | COIL VAC | UOM | ORDER MULTIPLE |
|-------------|---------|----------|-----|----------------|
| EC30324     | 30      | 24       | EA  | 1              |
| EC303120    | 30      | 120      | EA  | 1              |
| EC303240    | 30      | 240      | EA  | 1              |
| EC303277    | 30      | 277      | EA  | 1              |
| EC40324     | 40      | 24       | EA  | 1              |
| EC403120    | 40      | 120      | EA  | 1              |
| EC403240    | 40      | 240      | EA  | 1              |
| EC403277    | 40      | 277      | EA  | 1              |
| EC50324     | 50      | 24       | EA  | 1              |
| EC503120    | 50      | 120      | EA  | 1              |
| EC503240    | 50      | 240      | EA  | 1              |
| EC503277    | 50      | 277      | EA  | 1              |
| EC60324     | 60      | 24       | EA  | 1              |
| EC603120    | 60      | 120      | EA  | 1              |
| EC603240    | 60      | 240      | EA  | 1              |
| EC603277    | 60      | 277      | EA  | 1              |
| EC75324     | 75      | 24       | EA  | 1              |
| EC753120    | 75      | 120      | EA  | 1              |
| EC753240    | 75      | 240      | EA  | 1              |
| EC753277    | 75      | 277      | EA  | 1              |
| EC90324     | 90      | 24       | EA  | 1              |
| EC903120    | 90      | 120      | EA  | 1              |
| EC903240    | 90      | 240      | EA  | 1              |
| EC903277    | 90      | 277      | EA  | 1              |

**Eaton Definite Purpose Contactors - One and Two Pole**

These are single- and two-pole, Type C25 contactors feature a compact, efficient design with a low VA coil and straight-through wiring. Its housing design effectively limits dust and other contaminants from magnet structure—reduces or eliminates noise. They are UL recognized/CSA certified, ampere rated devices are well suited for use in heating/air conditioning, refrigeration, data processing and food service applications.



| CATALOG NO. | POLES | FL AMPS | COIL VAC | UOM | ORDER MULTIPLE |
|-------------|-------|---------|----------|-----|----------------|
| DPE301120   | 1     | 30      | 120      | EA  | 1              |
| DPE30124    | 1     | 30      | 24       | EA  | 1              |
| DPE301240   | 1     | 30      | 240      | EA  | 1              |
| DPE401120   | 1     | 40      | 120      | EA  | 1              |
| DPE40124    | 1     | 40      | 24       | EA  | 1              |
| DPE252120   | 2     | 25      | 120      | EA  | 1              |
| DPE25224    | 2     | 25      | 24       | EA  | 1              |
| DPE252240   | 2     | 25      | 240      | EA  | 1              |
| DPE302120   | 2     | 30      | 120      | EA  | 1              |
| DPE30224    | 2     | 30      | 24       | EA  | 1              |
| DPE302240   | 2     | 30      | 240      | EA  | 1              |
| DPE302277   | 2     | 30      | 277      | EA  | 1              |
| DPE402120   | 2     | 40      | 120      | EA  | 1              |
| DPE40224    | 2     | 40      | 24       | EA  | 1              |
| DPE402240   | 2     | 40      | 240      | EA  | 1              |
| DPE402480   | 2     | 40      | 480      | EA  | 1              |
| DPE602120   | 2     | 60      | 120      | EA  | 1              |

**CONTACTORS cont'd**

**Eaton Contactor Accessories**

These auxiliary contacts are side mounted contact kits for Eaton's definite purpose contactors with contact rating of 15A to 75A.



| CATALOG NO.       | DESCRIPTION                        | UOM | ORDER MULTIPLE |
|-------------------|------------------------------------|-----|----------------|
| <b>DPEAUX10</b>   | 15-75A, 1NO                        | EA  | 1              |
| <b>DPEAUX11</b>   | 15-75A, 1NO-1NC                    | EA  | 1              |
| <b>DPEAUX11QC</b> | 15-75A, 1NO-1NC with Quick Connect | EA  | 1              |
| <b>DPEAUX20</b>   | 15-75A, 2NO                        | EA  | 1              |
| <b>DPEAUX22</b>   | 25-75A, 2NO-2NC                    | EA  | 1              |

**TRANSFORMERS**

**Transformers – Class 2 1585  
UL Recognized**

The transformers provide the power source for heating, air conditioning, or refrigeration systems.

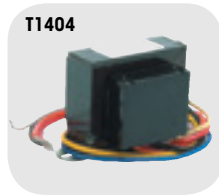

| CATALOG NO.  | VA | PRI         | SEC | UOM | ORDER MULTIPLE |
|--------------|----|-------------|-----|-----|----------------|
| <b>T1401</b> | 40 | 120         | 24  | EA  | 1              |
| <b>T1404</b> | 40 | 120/208/240 | 24  | EA  | 1              |

**Transformers – Class 2 1585  
UL Recognized**

The transformers provide the power source for heating, air conditioning, or refrigeration systems.

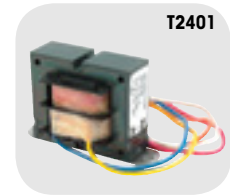

| CATALOG NO.  | VA | PRI         | SEC | UOM | ORDER MULTIPLE |
|--------------|----|-------------|-----|-----|----------------|
| <b>T2401</b> | 40 | 120         | 24  | EA  | 1              |
| <b>T2403</b> | 40 | 208/240     | 24  | EA  | 1              |
| <b>T2404</b> | 40 | 120/208/240 | 24  | EA  | 1              |

**Transformers – Class 2 1585  
UL Recognized**

The transformers provide the power source for heating, air conditioning, or refrigeration systems. These are multi mounted with wire connection secondary.



| CATALOG NO.  | VA        | PRI         | SEC | UOM | ORDER MULTIPLE |
|--------------|-----------|-------------|-----|-----|----------------|
| <b>T3401</b> | <b>40</b> | 120         | 24  | EA  | 1              |
| <b>T3403</b> | <b>40</b> | 120/208/240 | 24  | EA  | 1              |
| <b>T3501</b> | <b>50</b> | 120/208/240 | 24  | EA  | 1              |
| <b>T5401</b> | <b>40</b> | 120         | 24  | EA  | 1              |

**Transformers – Class 2 1585  
UL Recognized**

Heavy duty with external fuse (T67XX) or circuit breaker (T77XX).



| CATALOG NO.  | VA | PRI             | SEC | UOM | ORDER MULTIPLE |
|--------------|----|-----------------|-----|-----|----------------|
| <b>T6752</b> | 75 | 120/208/240     | 24  | EA  | 1              |
| <b>T6753</b> | 75 | 120/208/240/480 | 24  | EA  | 1              |
| <b>T7752</b> | 75 | 120/208/240/480 | 24  | EA  | 1              |

**RELAYS**

**General Purpose Relays – 9400 Series**

This product features quick connect terminals with universal mounting with break away tabs.

| CATALOG NO.    | DESCRIPTION | AMPS RES | FLA/LRA@125V | FLA/LRA@250V | COIL VOLTAGE | UOM | ORDER MULTIPLE |
|----------------|-------------|----------|--------------|--------------|--------------|-----|----------------|
| <b>D90-360</b> | SPST-NO     | 18       | 12/60        | 8/48         | 24 VAC       | EA  | 1              |
| <b>D90-370</b> | SPDT        | 18       | 12/60        | 8/48         | 24 VAC       | EA  | 1              |
| <b>D90-372</b> | SPDT        | 18       | 12/60        | 8/48         | 120 VAC      | EA  | 1              |
| <b>D90-380</b> | SPST NO+NC  | 18       | 12/60        | 8/48         | 24 VAC       | EA  | 1              |
| <b>D90-382</b> | SPST NO+NC  | 18       | 12/60        | 8/48         | 120 VAC      | EA  | 1              |
| <b>D90-384</b> | SPST NO+NC  | 18       | 12/60        | 8/48         | 240 VAC      | EA  | 1              |



**General Purpose Relays – 8400 Series**

This product features quick connect terminals with universal mounting with break away tabs



| CATALOG NO.     | DESCRIPTION | AMPS RES/IND | COIL VOLTAGE | UOM | ORDER MULTIPLE |
|-----------------|-------------|--------------|--------------|-----|----------------|
| <b>D90-290Q</b> | SPST-NO     | 16/8         | 24 VAC       | EA  | 1              |
| <b>D90-291Q</b> | SPST-NO     | 16/8         | 120 VAC      | EA  | 1              |
| <b>D90-292Q</b> | SPST-NO     | 16/8         | 240 VAC      | EA  | 1              |
| <b>D90-293Q</b> | SPDT        | 8/8          | 24 VAC       | EA  | 1              |
| <b>D90-294Q</b> | SPDT        | 8/8          | 120 VAC      | EA  | 1              |
| <b>D90-295Q</b> | SPDT        | 8/8          | 240 VAC      | EA  | 1              |

**Potential Relays**

The Potential Relay has SPST NC configurations and offers a variety of mounting positions.



| CATALOG NO.   | COIL VOLTAGE | PICK-UP MIN | PICK-UP MAX | DROP-OUT MAX | UOM | ORDER MULTIPLE |
|---------------|--------------|-------------|-------------|--------------|-----|----------------|
| <b>DPR063</b> | 168          | 140         | 153         | 45           | EA  | 1              |
| <b>DPR064</b> | 395          | 242         | 272         | 140          | EA  | 1              |
| <b>DPR066</b> | 395          | 223         | 252         | 130          | EA  | 1              |

**General Purpose Switching Relays**

The Switching Relay has quick connect terminals for termination. The base is designed for easy replacement of competitive relays.



| CATALOG NO.    | COIL VOLTAGE | TERMINALS 1-2-3 | TERMINALS 4-5-6 | UOM | ORDER MULTIPLE |
|----------------|--------------|-----------------|-----------------|-----|----------------|
| <b>D-90340</b> | 24           | POWER           | POWER           | EA  | 1              |
| <b>D-90341</b> | 110/120      | POWER           | POWER           | EA  | 1              |
| <b>D-90342</b> | 208/240      | POWER           | POWER           | EA  | 1              |

**FAN CENTERS**

The fan centers offer low voltage for one and two speed fan motors; auxiliary circuits in heating cooling, or heating/ cooling applications. This has a DPDT Relay and is UL rated. There are color coded pre stripped leads on this center. This product has a 24V coil voltage, power, and duty rated contacts. It mounts directly to a 4in. electrical box.



| CATALOG NO.    | VOLTAGE | UOM | ORDER MULTIPLE |
|----------------|---------|-----|----------------|
| <b>D-90113</b> | 120     | EA  | 1              |
| <b>D-90118</b> | 208/240 | EA  | 1              |



**FUSES**

**Dual Element Fuses – 250V**

Provides time delay for temporary over current conditions and motor running protection for heating and air conditioning equipment. Eliminates unnecessary maintenance from harmless overloads. U.L. Class RK 5, Standard for Safety 198E, Current Limiting Fuses, Interrupting Rating 200,000 Amps. rms. A.C.



7-CRNR40

| CATALOG NO. | DESCRIPTION | UOM | ORDER MULTIPLE |
|-------------|-------------|-----|----------------|
| 7-CRNR15    | 15 Amps     | EA  | 10             |
| 7-CRNR20    | 20 Amps     | EA  | 10             |
| 7-CRNR25    | 25 Amps     | EA  | 10             |
| 7-CRNR30    | 30 Amps     | EA  | 10             |
| 7-CRNR35    | 35 Amps     | EA  | 10             |
| 7-CRNR40    | 40 Amps     | EA  | 10             |
| 7-CRNR45    | 45 Amps     | EA  | 10             |
| 7-CRNR50    | 50 Amps     | EA  | 10             |
| 7-CRNR60    | 60 Amps     | EA  | 10             |
| 7-CRNR70    | 70 Amps     | EA  | 5              |
| 7-CRNR80    | 80 Amps     | EA  | 5              |
| 7-CRNR90    | 90 Amps     | EA  | 5              |
| 7-CRNR100   | 100 Amps    | EA  | 5              |

U.L. Class RK-5, Standard for Safety 198E, Current Limiting Fuses, Interrupting Rating 200,000 Amps. rms. A.C.

**Time Delay Fuses – 600V**

These plugs offer safe protection during momentary overload. No adapter necessary. U.L. Listed.



626-HASR15

| CATALOG NO. | DESCRIPTION | UOM | ORDER MULTIPLE |
|-------------|-------------|-----|----------------|
| 626-HASR10  | 10 Amp      | EA  | 10             |
| 626-HASR15  | 15 Amp      | EA  | 10             |
| 626-HASR20  | 20 Amp      | EA  | 10             |
| 626-HASR25  | 25 Amp      | EA  | 10             |
| 626-HASR30  | 30 Amp      | EA  | 10             |
| 626-HASR40  | 40 Amp      | EA  | 10             |
| 626-HASR60  | 60 Amp      | EA  | 10             |

U.L. Listed.

**Plug Fuses**

Expels gases caused by the blowing fuse, but doesn't allow flame to escape. Glass top for safety against shock. Positive visual indication of OK condition or blown condition. Distinguishes between overload and dead short conditions. Magnifying center of face. Shapes of face openings identify ratings. Meets Federal Specification WF 791E/Gen. Type 791/1. Base "W" fuses. U.L. Listed.



626-30

| CATALOG NO. | DESCRIPTION                | UOM | ORDER MULTIPLE |
|-------------|----------------------------|-----|----------------|
| 626-15      | Plug Fuse Type TL – 15 Amp | EA  | 4              |
| 626-20      | Plug Fuse Type TL – 20 Amp | EA  | 4              |
| 626-25      | Plug Fuse Type TL – 25 Amp | EA  | 4              |
| 626-30      | Plug Fuse Type TL – 30 Amp | EA  | 4              |

U.L. Listed.

**One Time Fuses**

Protection to lighting, heating, and other non transient circuits. U.L. Class H, Standard for Safety 1988, One Time Fuse Interrupting Rating 10,000 Amps. rms. A.C



7-10KOTN40

| CATALOG NO. | DESCRIPTION | UOM | ORDER MULTIPLE |
|-------------|-------------|-----|----------------|
| 7-10KOTN30  | 30 Amps     | EA  | 10             |
| 7-10KOTN35  | 35 Amps     | EA  | 10             |
| 7-10KOTN40  | 40 Amps     | EA  | 10             |
| 7-10KOTN45  | 45 Amps     | EA  | 10             |
| 7-10KOTN50  | 50 Amps     | EA  | 10             |
| 7-10KOTN60  | 60 Amps     | EA  | 10             |
| 7-10KOTN70  | 70 Amps     | EA  | 5              |
| 7-10KOTN80  | 80 Amps     | EA  | 5              |
| 7-10KOTN90  | 90 Amps     | EA  | 5              |
| 7-10KOTN100 | 100 Amps    | EA  | 5              |

U.L. Class H, Standard for Safety 1988, One Time Fuse Interrupting Rating 10,000 Amps. rms. A.C.

**Time Delay Plug Fuses**

These plugs offer safe protection during momentary overload. No adapter necessary. U.L. Listed.



626-30T

| CATALOG NO. | DESCRIPTION                 | UOM | ORDER MULTIPLE |
|-------------|-----------------------------|-----|----------------|
| 626-10T     | Type "T" Plug Fuse – 10 Amp | EA  | 4              |
| 626-15T     | Type "T" Plug Fuse – 15 Amp | EA  | 4              |
| 626-20T     | Type "T" Plug Fuse – 20 Amp | EA  | 4              |
| 626-25T     | Type "T" Plug Fuse – 25 Amp | EA  | 4              |
| 626-30T     | Type "T" Plug Fuse – 30 Amp | EA  | 4              |

U.L. Listed.

**Type "S" Non-Tamper Fuses**

Provides specific overcurrent protection. Time delay element protects against premature blowing from motors in air conditioners or compressors. Visual indication of good or blown condition. U.L. Listed. C.S.A. Approved.



626-30S

| CATALOG NO. | DESCRIPTION              | UOM | ORDER MULTIPLE |
|-------------|--------------------------|-----|----------------|
| 626-6S      | Type "S" Fuse – 6.25 Amp | EA  | 4              |
| 626-10S     | Type "S" Fuse – 10 Amp   | EA  | 4              |
| 626-15S     | Type "S" Fuse – 15 Amp   | EA  | 4              |
| 626-20S     | Type "S" Fuse – 20 Amp   | EA  | 4              |
| 626-25S     | Type "S" Fuse – 25 Amp   | EA  | 4              |
| 626-30S     | Type "S" Fuse – 30 Amp   | EA  | 4              |

U.L. Listed. C.S.A. Approved.

**FUSES cont'd**

**In-Line Fuse Holder**

For fusing all control circuits up to 30 amp. Features rigid plastic protective covering for each fuse. Used on AC and DC circuits. U.L. Listed.

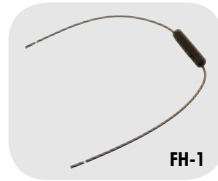

| CATALOG NO. | DESCRIPTION         | UOM | ORDER MULTIPLE |
|-------------|---------------------|-----|----------------|
| <b>FH-1</b> | In-Line Fuse Holder | EA  | 10             |

U.L. Listed.

**Fuse Pullers**

Our fuse pullers are used to safely pull fuses



| CATALOG NO.      | DESCRIPTION                               | UOM | ORDER MULTIPLE |
|------------------|---|-----|----------------|
| <b>626-38071</b> | Fuse Puller – For Fuse Sizes 1/4" to 1/2" | EA  | 1              |
| <b>626-38073</b> | Fuse Puller – For Fuse Sizes 1" to 1-3/4" | EA  | 1              |

**Fuseblocks**

The fuse blocks are designed to allow the fuse to blow or burn out before the component can be damaged.



| CATALOG NO.      | DESCRIPTION                              | UOM | ORDER MULTIPLE |
|------------------|--|-----|----------------|
| <b>626-23133</b> | Fuseblock – 1 Pole Screw Class H, 250V   | EA  | 1              |
| <b>626-23233</b> | Fuseblock – 2 Pole Screw Class H, 250V   | EA  | 1              |
| <b>626-23333</b> | Fuseblock – 3 Pole Screw Class H, 250V   | EA  | 1              |
| <b>626-26311</b> | Fuseblock – 3 Pole Box Lug Class H, 250V | EA  | 1              |

**Blade (Auto) Fuses**

These fuses are fast acting low voltage supplementary fuses, automotive blade style fuse.



| CATALOG NO.       | DESCRIPTION                            | UOM | ORDER MULTIPLE |
|-------------------|--|-----|----------------|
| <b>626-AT0003</b> | Blade Fuse – 3 Amp – Purple, pack of 5 | EA  | 100            |
| <b>626-AT0005</b> | Blade Fuse – 5 Amp – Tan, pack of 5    | EA  | 100            |

**Fuse Adapters**

Fuse adapters are used to retrofit fuses into existing installations.



| CATALOG NO.      | DESCRIPTION                                       | UOM | ORDER MULTIPLE |
|------------------|---|-----|----------------|
| <b>626-38632</b> | Fuse Adapter – 60 to 30 Reducer for Class H, 250V | EA  | 1              |
| <b>626-38636</b> | Fuse Adapter – 60 to 30 Reducer for Class H, 600V | EA  | 1              |

**Box Cover Units**

The maximum amps on this box cover unit are 15 and the maximum AC voltage of 125. These units are designed for use with the Type T plug fuses. U.L. Listed and C.S.A. Certified.



| CATALOG NO.     | DESCRIPTION                     | UOM | ORDER MULTIPLE |
|-----------------|---------------------------------|-----|----------------|
| <b>620-608</b>  | Switch/Fuse Combo (ESSU)        | EA  | 1              |
| <b>620-6081</b> | Plug Fuse Base Only (ESOU)      | EA  | 1              |
| <b>620-6082</b> | Receptacle/Fuse Combo (ESRU)    | EA  | 1              |
| <b>620-6083</b> | Switch/Fuse Combo Square (ESSY) | EA  | 1              |

U.L. Listed and C.S.A. Certified.

**TIME DELAYS**

**Adjustable Delay on Break Timer**

Adjusts from 6 seconds to 8 minutes. Spin-proof knob. Works with 24, 120 or 240 VAC control circuits. Supports up to 1.0 Amps. Two wire hookup for easy installation. Solid state with quick disconnect terminals. Mounts with one self-tapping screw. Conformal coated circuitry protects against moisture and shock. UR recognized for USA and Canada. Works with anticipator type thermostats.

**HOW IT WORKS:** Immediately upon application of power, the Delay on Break timer enables circuit operation. Once power is interrupted, the circuit opens for the time set on the dial. After the time period elapses, the circuit closes, allowing the protected motor or compressor to start. For typical HVAC applications, the operation of the timer is transparent and will go unnoticed.



| CATALOG NO.  | DESCRIPTION                            | UOM | ORDER MULTIPLE |
|--------------|--|-----|----------------|
| <b>ADB-1</b> | Adjustable Delay on Break              | EA  | 1              |
| <b>ADB-2</b> | Adjustable Delay on Break w/Wire Leads | EA  | 1              |

**Adjustable Delay on Make Timer**

Ideal for random starting of multiple units. Adjusts from 6 seconds to 8 minutes. Spin proof knob. Works with 24, 120 or 240 VAC control circuits. Supports up to 1.0 Amps. Two wire hookup for easy installation. Solid state with quick-disconnect terminals. Mounts with one self-tapping screw. Conformal coated circuitry protects against moisture and shock. UR recognized for US and Canada. Works with anticipator type thermostats. **HOW IT WORKS:** These timers delay circuit closure upon application of power. Only after the set time period elapses and power remains ON will the circuit close, allowing the protected motor or compressor to start. For typical HVAC installations, timers are adjusted to random times to prevent power circuit overloads, thus are often called random start timers.



| CATALOG NO.  | DESCRIPTION                           | UOM | ORDER MULTIPLE |
|--------------|---------------------------------------|-----|----------------|
| <b>ADM-1</b> | Adjustable Delay on Make              | EA  | 1              |
| <b>ADM-2</b> | Adjustable Delay on Make w/Wire Leads | EA  | 1              |

**Digital Three Phase Line Voltage Monitor**

Offers continuous protection against voltage anomalies which can damage compressors, motors and other sensitive electrically operated devices.

**PROTECTION:** Loss of Phase, Phase Reversal, Voltage Imbalance, Low Voltage, High Voltage

**DISPLAY:** Large custom LCD display indicates all operating conditions at a glance. Three large sets of digits provide easy system troubleshooting.

**VOLTMETER:** Three independent voltmeters read both line and contactor load (backside) voltages.

**MONITORED VOLTAGE:** 160 to 600 Volts 50-60 Hz.

**POWER SUPPLY:** Power for the WPC-500 is automatically derived from any active phase. System operation is not dependent on the control voltage or a specific phase for power.

**CONTROL VOLTAGE:** 19-277 VAC. Anticipator load is provided for operation with 24 volt electronic and mechanical thermostats.

**OPERATING VOLTAGE SET POINT:** 175 to 650 VAC. Digitally adjustable in one volt increments.

**VOLTAGE TRIP POINT:** Adjustable in 1% increments between 6% and 18% of selected operating voltage. Restart voltage set point (hysteresis) fixed at cutout voltage + 3%.

**VOLTAGE SYMMETRY:** Adjustable imbalance trip point from 2% to 25% of selected operating voltage.

**RESPONSE TIMES:**

Phase Loss/Reversal: 100 mS max.

Imbalance: Adjustable Response Timer

Over or Under Voltage: Adjustable Response Timer

**LOCKOUT DELAY TIMER:** Fully adjustable 0 to 720 Seconds (0 to 12 minutes). Digital display shows re-remaining time and user set points.

**SEQUENTIAL START TIMER:** 0 to 30 seconds in one second increments.

**RESPONSE TIMER:** 0.1 to 20 Seconds. Digital display shows remaining time and user set points.

**MEMORY:** Up to 25 past fault conditions are stored for later retrieval and analysis. The faults may be displayed or cleared by the front panel buttons.



**DTP-3**

**Digital Single Phase Line Voltage Monitor**

Automatic voltage monitor and control system. Continuously measures incoming line voltage, allowing detection of any voltage outside the tolerances that you set. If these limits are exceeded, the response timer begins counting. You may also set response time – a short time for a quick response or a long time to avoid nuisance tripping. If the voltage remains outside the tolerance after the time has elapsed, the DSP-1 will turn off its output relay and protect your device. While output is off, an additional delay timer activates to avoid rapid restarts.

**FEATURES:**

- Digital voltmeter displays instantaneous line voltage;
- Automatic voltage tester adjusts from 90 to 300 volts;
- Adjustable response timer (0.1 to 10 sec.) prevents nuisance tripping;
- Adjustable delay timer (1 to 720 sec.) prevents rapid restarts;
- Digital display makes for easy viewing and operation

**SPECIFICATIONS:**

- Voltmeter: 70 to 325 Volts
- Voltage Set Point: 90 to 300 Volts
- Tolerance Limits: 6 to 18%
- Response Timer: 0.1 to 10 seconds
- Delay Timer: 1 to 720 seconds
- Output Relay: 10 Amps, 250 VAC resistive, single-pole/double-throw
- Control Input: 18 to 250 VAC with anticipator load for 24 volt thermostats



**DSP-1**

| CATALOG NO.  | DESCRIPTION                          | UOM | ORDER MULTIPLE |
|--------------|--------------------------------------|-----|----------------|
| <b>DSP-1</b> | Digital Single Phase Motor Protector | EA  | 1              |

| CATALOG NO.  | DESCRIPTION                     | UOM | ORDER MULTIPLE |
|--------------|---------------------------------|-----|----------------|
| <b>DTP-3</b> | Digital 3-Phase Motor Protector | EA  | 1              |

ELECTRICAL SUPPLIES

### Electrical Toggle Switches

Side wire design with automatic grounding and large binding head terminal screws for fast wiring. Lubricated cam provides smooth lever action. U.L. Listed. C.S.A. Certified. Verified to Federal Spec. WS896E



620-601

| CATALOG NO. | DESCRIPTION                         | UOM | ORDER MULTIPLE |
|-------------|-------------------------------------|-----|----------------|
| 620-600     | 20A-1 HP 120V, Single Pole, Brown   | EA  | 10             |
| 620-601     | 20A-1 HP 120V, Single Pole, Ivory   | EA  | 10             |
| 625-CS120W  | 20A-1HP 120V Single Pole, White     | EA  | 10             |
| 625-1301W   | 15A-1/2HP 120V Single Pole, White   | EA  | 10             |
| 620-604     | 15A-1/2 HP 120V, Single Pole, Brown | EA  | 10             |
| 620-605     | 15A-1/2 HP 120V, Single Pole, Ivory | EA  | 10             |

U.L. Listed. C.S.A. Certified. Verified to Federal Spec. WS896E.

### Electrical Outlet Boxes, Extensions and Covers

We have 4in. steel octagon boxes, extensions, and covers available. Conforms to Article 370 of NEC. U.L. Listed.



620-300 620-303  
620-304 620-306

| CATALOG NO. | DESCRIPTION                      | UOM | ORDER MULTIPLE |
|-------------|----------------------------------|-----|----------------|
| 620-300     | 1-1/2" Deep, 1/2" and 3/4" K.O.s | EA  | 50             |
| 620-303     | Flat Blank Cover                 | EA  | 50             |
| 620-304     | Flat, Duplex Receptacle Cover    | EA  | 50             |
| 620-306     | Flat Cover 1/2" K.O. in Center   | EA  | 50             |

Conforms to Article 370 of NEC. U.L. Listed.

### Electrical Outlet Boxes, Extensions and Covers

We have 4 11/16in. steel square boxes, extensions, and covers available. Conforms to Article 370 of NEC. U.L. Listed.



620-502

| CATALOG NO. | DESCRIPTION                    | UOM | ORDER MULTIPLE |
|-------------|--------------------------------|-----|----------------|
| 620-502     | Raised Cover for Single Device | EA  | 25             |

Conforms to Article 370 of NEC. U.L. Listed.

### Electrical Duplex Receptacles

Automatic grounding for fast installation. Heavy duty mounting strap for additional assembly strength. Copper alloy power/ground contacts for optimum continuity. Side wire design with large binding head terminal screws for fast wiring. U.L. Listed. C.S.A. Certified (NEMA 5 15 Type).

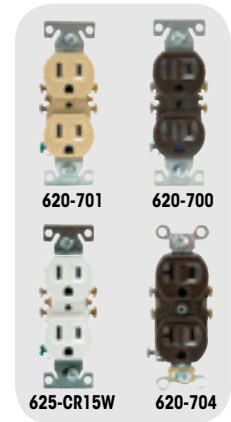

620-701 620-700  
625-CR15W 620-704

| CATALOG NO. | DESCRIPTION                    | UOM | ORDER MULTIPLE |
|-------------|--------------------------------|-----|----------------|
| 620-700     | 15A, 125V, Brown               | EA  | 10             |
| 620-701     | 15A, 125V, Ivory               | EA  | 10             |
| 625-CR15W   | 15A 125V, White                | EA  | 10             |
| 620-702     | 20A, 125V, Brown               | EA  | 10             |
| 620-703     | 20A, 125V, Ivory               | EA  | 10             |
| 625-CR20W   | 20A 125V, White                | EA  | 10             |
| 620-704     | 15A, 125V, Brown – Residential | EA  | 10             |
| 620-705     | 15A, 125V, Ivory – Residential | EA  | 10             |
| 625-270W    | 15A 125V, White – Residential  | EA  | 10             |

U.L. Listed. C.S.A. Certified (NEMA 5-15 Type).

### Electrical Outlet Boxes, Extensions and Covers

We have 4in. steel square boxes, extensions, and covers available. Conforms to Article 370 of NEC. U.L. Listed.



620-400 620-403  
620-404 620-405  
620-406 620-411

| CATALOG NO. | DESCRIPTION                                | UOM | ORDER MULTIPLE |
|-------------|--|-----|----------------|
| 620-400     | 1-1/4" Deep, 1/2" K.O.s                    | EA  | 50             |
| 620-401     | 2-1/8" Deep, 1/2" and 3/4" K.O.s           | EA  | 25             |
| 620-403     | 1-1/2" Deep, 1/2" K.O.s                    | EA  | 50             |
| 620-404     | 1-1/2" Deep, 1/2" and 3/4" K.O.s Extension | EA  | 50             |
| 620-405     | Flat Cover 1/2" K.O. in Center             | EA  | 50             |
| 620-406     | Flat Blank Cover                           | EA  | 50             |
| 620-408     | Flat, One Toggle Switch Cover              | EA  | 50             |
| 620-409     | Flat, One Duplex Receptacle Cover          | EA  | 50             |
| 620-411     | One Switch and One Duplex Receptacle Cover | EA  | 50             |

Conforms to Article 370 of NEC. U.L. Listed.



## Electrical Outlet Boxes, Extensions and Covers

Standard steel utility (Handy) boxes and covers.



| CATALOG NO. | DESCRIPTION                       | UOM | ORDER MULTIPLE |
|-------------|-----------------------------------|-----|----------------|
| 620-200     | 1-1/2" Deep, 1/2" K.O.s           | EA  | 50             |
| 620-201     | 1-7/8" Deep, 1/2" K.O.s           | EA  | 50             |
| 620-202     | 2-1/8" Deep, 1/2" K.O.s           | EA  | 50             |
| 620-20134   | 1-7/8" Deep, 3/4" K.O.s           | EA  | 50             |
| 620-252     | Flat, Two Duplex Receptacle Cover | EA  | 100            |
| 620-253     | Flat, Toggle Switch Cover         | EA  | 100            |
| 620-254     | Flat Blank Cover                  | EA  | 100            |
| 620-255     | Flat Cover 1/2" K.O.              | EA  | 100            |

Conforms to Article 370 of NEC. U.L. Listed.

## Switch/Plug Combo

Use with air handlers and condensate pumps. Touch-A-Matic design, with exclusive spring loaded steel ball mechanism for smooth, positive contact movement. Small neon pilot light ON when switch is ON, is built-in to the switch on switch/receptacle.



| CATALOG NO. | DESCRIPTION                    | UOM | ORDER MULTIPLE |
|-------------|--------------------------------|-----|----------------|
| 620-274W    | White 2P 3W Grounding—15A 120V | EA  | 10             |

U.L. Listed. C.S.A. Approved.

## Eaton Circuit Breakers - Type BR

Type BR Circuit Breakers are 1-inch per pole plug-on circuit breakers designed for Eaton's Type BR Loadcenters. They are 10 kAIC arc fault circuit interrupters rated for 120VAC or 240VAC applications.



| CATALOG NO. | DESCRIPTION      | UOM | ORDER MULTIPLE |
|-------------|------------------|-----|----------------|
| BR115       | Single Pole, 15A | EA  | 10             |
| BR120       | Single Pole, 20A | EA  | 10             |
| BR130       | Single Pole, 30A | EA  | 10             |
| BR140       | Single Pole, 40A | EA  | 10             |
| BR150       | Single Pole, 50A | EA  | 10             |
| BR215       | Two Pole, 15A    | EA  | 5              |
| BR220       | Two Pole, 20A    | EA  | 5              |
| BR230       | Two Pole, 30A    | EA  | 5              |
| BR240       | Two Pole, 40A    | EA  | 5              |
| BR250       | Two Pole, 50A    | EA  | 5              |
| BR260       | Two Pole, 60A    | EA  | 5              |
| BR270       | Two Pole, 70A    | EA  | 5              |
| BR2100      | Two Pole, 100A   | EA  | 5              |

## Plastic Wall Plates

Non flammable thermoplastic, phenolic or urea material. Color matched 1/2in. long steel mounting screws furnished. Smooth surface – no recessed areas to collect dirt, discolor. Easy to clean. Full weight and thickness provide high dielectric strength, minimum moisture absorption, impact resistance. Warp resistant, fit flush to wall. U.L. Listed. C.S.A. Approved.



| CATALOG NO. | DESCRIPTION                     | UOM | ORDER MULTIPLE |
|-------------|---------------------------------|-----|----------------|
| 625-2132B   | Duplex Receptacle Cover – Brown | EA  | 25             |
| 625-2132V   | Duplex Receptacle Cover – Ivory | EA  | 10             |
| 625-2132W   | Duplex Receptacle Cover – White | EA  | 10             |
| 625-2134B   | Single Toggle Cover – Brown     | EA  | 25             |
| 625-2134V   | Single Toggle Cover – Ivory     | EA  | 25             |
| 625-2134W   | Single Toggle Cover – White     | EA  | 25             |

U.L. Listed. C.S.A. Approved.

## Switch Covers

Our switch covers come with gas, oil, or emergency already printed on them.



| CATALOG NO. | SIZE            | TYPE      | DESCRIPTION                                    | UOM | ORDER MULTIPLE |
|-------------|-----------------|-----------|--|-----|----------------|
| 625-S17     | 4" X 4"         | Gas       | 4" Square Box                                  | EA  | 10             |
| 625-S16     | 4-1/4" X 2-3/4" | Gas       | Utility/Handy Box                              | EA  | 1              |
| 625-S15     | 4-1/2" X 2-1/2" | Gas       | Flush Mount                                    | EA  | 25             |
| 625-S14     | 4" X 4"         | Oil       | 4" Square Box                                  | EA  | 1              |
| 625-S13     | 4-1/4" X 2-3/4" | Oil       | Utility/Handy Box                              | EA  | 1              |
| 625-S19     | 4-1/2" X 2-1/2" | Oil       | Flush Mount                                    | EA  | 1              |
| 625-S20     | 4-3/4" X 2-1/2" | Emergency | Switch Plate                                   | EA  | 1              |
| 625-S18     | 3/4"            |           | Switch Guard (Wall plate/ switch not included) | EA  | 1              |

## Eaton Circuit Breakers - Type CH

Type CH Circuit Breakers are 3/4-inch per pole plug-on circuit breakers designed for Eaton's Type CH Loadcenters. They are 10 kAIC arc fault circuit interrupters rated for 120VAC or 240VAC applications.



| CATALOG NO. | DESCRIPTION      | UOM | ORDER MULTIPLE |
|-------------|------------------|-----|----------------|
| CH115       | Single Pole, 15A | EA  | 10             |
| CH120       | Single Pole, 20A | EA  | 10             |
| CH215       | Two Pole, 15A    | EA  | 5              |
| CH220       | Two Pole, 20A    | EA  | 5              |
| CH230       | Two Pole, 30A    | EA  | 5              |
| CH240       | Two Pole, 40A    | EA  | 5              |
| CH250       | Two Pole, 50A    | EA  | 5              |
| CH260       | Two Pole, 60A    | EA  | 5              |

**ELECTRICAL SUPPLIES** cont'd

**Toggle Switches**

These switches are available in single pole double pole. They are UL listed and furnished with screw terminals. The ratings are A:20A 125VAC, 20 250 VAC, 1 HP at 120 240 V and B 15A 125/250 VAC, ¾ HP at 240 V.



| CATALOG NO. | DESCRIPTION                          | RATING | UOM | ORDER MULTIPLE |
|-------------|--------------------------------------|--------|-----|----------------|
| <b>TS-1</b> | Toggle Switch – SP-ST – ON/OFF       | A      | EA  | 1              |
| <b>TS-3</b> | Toggle Switch – SP-DT-CO – ON/OFF/ON | B      | EA  | 1              |
| <b>TS-4</b> | Toggle Switch – DP-ST – ON/OFF       | A      | EA  | 1              |
| <b>TS-5</b> | Toggle Switch – DP-DT – ON/OFF       | A      | EA  | 1              |

**Toggle Switch Cover**

Weatherproof body for toggle switches up to 15/16" long.



| CATALOG NO.   | DESCRIPTION         | UOM | ORDER MULTIPLE |
|---------------|---------------------|-----|----------------|
| <b>625-B1</b> | Toggle Switch Cover | EA  | 5              |

**Power Supply Cord (Pigtails)**

Stranded bare copper conductors. Grounding conductors. PVC jacket. Right and straight angle male plug. 110 Volt. 16 AWG x 6' long. SPT 2.



| CATALOG NO.       | DESCRIPTION                        | UOM | ORDER MULTIPLE |
|-------------------|------------------------------------|-----|----------------|
| <b>625-16-6</b>   | Power Supply Cord – Straight Plug  | EA  | 50             |
| <b>625-16-690</b> | Power Supply Cord – 90 Degree Plug | EA  | 50             |

**ELECTRICAL TAPES**

**Scotch 3M Super 33+ Electrical Tape**

Premium grade, 7 mil thick, all-weather vinyl insulating tape. Performs continuously in a temperature ambient of up to 220°F and as low as 0°F. Resealable plastic case. Made in USA.



| CATALOG NO. | DESCRIPTION                            | UOM | ORDER MULTIPLE |
|-------------|--|-----|----------------|
| <b>ET33</b> | Super 33+ Electrical Tape – 3/4" x 66' | EA  | 10             |

**Scotch 3M Super 88 Electrical Tape**

Premium grade, 8.5 mil thick, all-weather vinyl insulating tape. Performs continuously in a temperature ambient of up to 220°F and as low as 0°F. Excellent resistance to abrasion, moisture, acids and corrosion. Packaged in a resealable plastic case. Made in the USA.



| CATALOG NO. | DESCRIPTION                           | UOM | ORDER MULTIPLE |
|-------------|---------------------------------------|-----|----------------|
| <b>ET44</b> | Super 88 Electrical Tape – 3/4" x 66' | EA  | 10             |

**Scotch 35 Vinyl Electrical Tape**

This 7 mil premium grade electrical vinyl tape stretches to conform to virtually any shape that requires color-coded insulation. Abrasion and weather resistant. Measures 3/4" x 66'.



| CATALOG NO.  | DESCRIPTION                    | UOM | ORDER MULTIPLE |
|--------------|--------------------------------|-----|----------------|
| <b>ET35N</b> | Vinyl Electrical Tape – Orange | EA  | 10             |
| <b>ET35G</b> | Vinyl Electrical Tape – Green  | EA  | 10             |
| <b>ET35R</b> | Vinyl Electrical Tape – Red    | EA  | 10             |
| <b>ET35W</b> | Vinyl Electrical Tape – White  | EA  | 10             |

**Glass Cloth, Moisture Sealing, and Economy Electrical Tapes**

This is a woven glass cloth tape designed to operate in 600 volt dry applications, requiring high mechanical strength and resistance to high temperatures. The glass cloth is specially treated and prepared to provide corrosion free protection. It will not shrink, rot, or burn and has a high tensile strength. It contains pressure sensitive thermosetting adhesive which performs as Class B temperature (266 degrees F / 130 degrees C). Provides heat stable insulation for hot spot applications. Highlight: Color White. Width 1/2in. Length 66 ft. Thickness 7 mil. Tensile Strength (2) 150 lb./in. Material Glass Cloth.



| CATALOG NO.    | DESCRIPTION                                   | UOM | ORDER MULTIPLE |
|----------------|---|-----|----------------|
| <b>GC275</b>   | 1/2" x 66' Glass Cloth Electrical Tape by 3M  | EA  | 10             |
| <b>GC277</b>   | 3/4" x 66' Glass Cloth Electrical Tape by 3M  | EA  | 10             |
| <b>ET130C1</b> | 1" x 30' Moisture Sealing Splicing Tape by 3M | EA  | 24             |
| <b>ET22</b>    | 3/4" x 66' Hiawatha Electrical Tape by 3M     | EA  | 10             |
| <b>AT-1700</b> | 3/4" x 66' TemFlex™ by 3M                     | EA  | 10             |

**Economy Electrical Tape**

This tape is suitable for use up to 175 F (80C) and not more than 600V. The electrical tape is excellent for adhesion and UL listed.



| CATALOG NO.   | DESCRIPTION                        | UOM | ORDER MULTIPLE |
|---------------|------------------------------------|-----|----------------|
| <b>6-3460</b> | 3/4" x 60' Economy Electrical Tape | EA  | 10             |

## TERMINALS, CONNECTORS

### Compressor Repair Kit

Finally, a product that simplifies the repair of burned or damaged spade terminals when reconnecting or replacing a compressor. Fits both non burned and burned terminals. Connects to the compressor via precision brass cylinders that fit over the terminals and connect with stainless steel set screws. Wires are permanently attached. Standard factory 600V, 65 strand machine wire. Easy to install and guaranteed for the life of the compressor.



| CATALOG NO.     | DESCRIPTION                     | UOM | ORDER MULTIPLE |
|-----------------|---------------------------------|-----|----------------|
| <b>TLC-3-8</b>  | 3 Wire, 8 Gauge Connection Kit  | EA  | 1              |
| <b>TLC-3-10</b> | 3 Wire, 10 Gauge Connection Kit | EA  | 1              |
| <b>TLC-3-12</b> | 3 Wire, 12 Gauge Connection Kit | EA  | 1              |

### Replacement Compressor Leads

Extreme heat within compressors typically causes failure of wiring insulation. This can cause corrosion to the inner strands of copper within the wire used for compressor hook up. This reduces the power flow to the compressor causing the unit to overheat and can prevent the compressor from starting. A MINIMUM of 12in. of wire must be removed. The DiversiTech Replacement Compressor Leads are ideal for replacing this corroded wiring. 24in. leads also available for replacing wire all the way to the contactor and capacitor.



| CATALOG NO.    | DESCRIPTION                                 | UOM | ORDER MULTIPLE |
|----------------|---|-----|----------------|
| <b>CC33</b>    | Compressor Leads – 12" with Butt, pack of 3 | PK  | 1              |
| <b>CC33-18</b> | Compressor Leads – 18" with Butt, pack of 3 | PK  | 1              |
| <b>CC33-24</b> | Compressor Leads – 24" with Ring, pack of 3 | PK  | 1              |

### Grommets – Vinyl (By Panel Hole Size)

Grommets safely route cables and wires through sharp edged cutouts.



| CATALOG NO.  | DESCRIPTION   | UOM | ORDER MULTIPLE |
|--------------|---|-----|----------------|
| <b>GV04*</b> | Grommets – 1/4", pack of 18                                   | PK  | 1              |
| <b>GV05*</b> | Grommets – 5/16", pack of 15                                  | PK  | 1              |
| <b>GV06*</b> | Grommets – 3/8", pack of 18                                   | PK  | 1              |
| <b>GV07</b>  | Grommets – 7/16", pack of 12                                  | PK  | 1              |
| <b>GV08*</b> | Grommets – 1/2", pack of 12                                   | PK  | 1              |
| <b>GV10*</b> | Grommets – 5/8", pack of 7                                    | PK  | 1              |
| <b>GV12</b>  | Grommets – 3/4", pack of 3                                    | PK  | 1              |
| <b>GV14*</b> | Grommets – 7/8", pack of 4                                    | PK  | 1              |
| <b>GV16*</b> | Grommets – 1", pack of 4                                      | PK  | 1              |
| <b>GVA1</b>  | Assortment – Small – GV04, GV05, GV06, GV07, GV08, pack of 15 | PK  | 1              |
| <b>GVA2</b>  | Assortment – Large – GV08, GV10, GV12, GV14, GV16, pack of 5  | PK  | 1              |

\*Sizes shown above also available in 100 packs. Replace "\*" with "C" for part number.

### Transparent Plastic Boxes with Terminal Assortments

Boxes are made of soft, pliable, durable K resin with 18 compartments containing the most popular terminals, including hi temp and compressor terminals.



| CATALOG NO.   | DESCRIPTION  | UOM | ORDER MULTIPLE |
|---------------|--|-----|----------------|
| <b>PA10</b>   | 180 Terminals (10 Each Kind)                           | EA  | 1              |
| <b>PA25</b>   | 360 Terminals (20 Each Kind)                           | EA  | 1              |
| <b>PA25AP</b> | Appliance Parts Technician Assortment (mostly Hi-Temp) | EA  | 1              |
| <b>PA18</b>   | "K" Resin Plastic Box Only                             | EA  | 1              |

### Compartmented Storage Boxes

These boxes can be used to store your compressor terminals, nylon ties and clamps.



| CATALOG NO. | DESCRIPTION   | UOM | ORDER MULTIPLE |
|-------------|---|-----|----------------|
| <b>MB21</b> | 21 Compartmented Metal Box  | EA  | 1              |
| <b>MB22</b> | 21 Compartmented Metal Box w/230 popular EA items including hi-temp and compressor terminals, nylon ties and clamps | EA  | 1              |

### Heat Shrink Tubing – Polyolefin 50% Shrink, Black Commercial Grade

Our shrinking tube is economical and mechanically tough heat shrinkable tubing used for insulating, jacketing and identification.



| CATALOG NO.     | DESCRIPTION                                     | UOM | ORDER MULTIPLE |
|-----------------|---|-----|----------------|
| <b>HS03</b>     | 3/16" I.D. Expanded – 4" Long, pack of 8        | PK  | 1*             |
| <b>HS04</b>     | 1/4" I.D. Expanded – 4" Long, pack of 7         | PK  | 1*             |
| <b>HS04-100</b> | 1/4" I.D. Expanded, 100' roll                   | EA  | 1              |
| <b>HS06</b>     | 3/8" I.D. Expanded – 4" Long, pack of 6         | PK  | 1*             |
| <b>HS08</b>     | 1/2" I.D. Expanded – 4" Long, pack of 5         | PK  | 1*             |
| <b>HS16</b>     | 1" I.D. Expanded – 4" Long, pack of 3           | PK  | 1*             |
| <b>HSA1</b>     | Assorted 3/16", 1/4", 3/8" – 4" Long, pack of 7 | PK  | 1              |
| <b>HSA2</b>     | Assorted 1/2", 3/4", 1" – 4" Long, pack of 4    | PK  | 1              |

Available in lengths up to 250 ft.

\*These items are also available in bulk. To order, enter the catalog number followed by the letter "B". For example, HS03B is the bulk part number for HS03. Bulk items are priced and shipped by the foot.

**THERMAL CONTROLS**

**Fusible Links**

Fusible Links are temperature sensitive, one time devices. Engineered as safety links, they open the circuit if the designed limit temperature is reached.

| CATALOG NO.     | FUSIBLE TEMP °F | TYPE       | PRONG TYPE  | QTY/PACK  | UOM | ORDER MULTIPLE |
|-----------------|-----------------|------------|-------------|-----------|-----|----------------|
| <b>HFL-4257</b> | 257°            | In-Line    |             | pack of 4 | PK  | 1              |
| <b>HFL-4300</b> | 300°            | In-Line    |             | pack of 4 | PK  | 1              |
| <b>HFL-4333</b> | 333°            | In-Line    |             | pack of 4 | PK  | 1              |
| <b>HFL-5257</b> | 257°            | Face Plate | Straight    | pack of 2 | PK  | 1              |
| <b>HFL-5258</b> | 257°            | Face Plate | Right Angle | pack of 2 | PK  | 1              |
| <b>HFL-5300</b> | 300°            | Face Plate | Straight    | pack of 2 | PK  | 1              |
| <b>HFL-5301</b> | 300°            | Face Plate | Right Angle | pack of 2 | PK  | 1              |
| <b>HFL-5333</b> | 333°            | Face Plate | Straight    | pack of 2 | PK  | 1              |



**Replacement Element Kits**

Field repair damaged element sections of electric heaters. Each kit contains a specific KW replacement element, two ceramic terminal insulator sets, plated bolts, nuts and washers.

| CATALOG NO.    | WATTAGE AT |      | IN PLACE LENGTH (INCHES) |         | UOM | ORDER MULTIPLE |
|----------------|------------|------|--------------------------|---------|-----|----------------|
|                | 240V       | 208V | MINIMUM                  | MAXIMUM |     |                |
| <b>HEK-400</b> | 4000       | 3000 | 45"                      | 135"    | EA  | 1              |
| <b>HEK-500</b> | 5000       | 3750 | 54"                      | 162"    | EA  | 1              |



**Sequencers**

The sequencers are used in electric heat systems to stage blower motors and heating elements. All sequencers are for 24V control.

| CATALOG NO.    | NO. CIRCUITS  | KILXON NO.  | SWITCH CONFIGURATION | DELAY ON TIME MIN.-MAX. SECONDS | DELAY OFF TIME MIN.-MAX. SECONDS | UOM | ORDER MULTIPLE |
|----------------|---------------|-------------|----------------------|---------------------------------|----------------------------------|-----|----------------|
| <b>HDR-101</b> | 1 Main        | 60000A0211  | SPST-NO              | 1-24                            | 45-75                            | EA  | 1              |
| <b>HDR-102</b> | 1 Main        | 60000A0147  | SPST-NO              | 30-75                           | 1-40                             | EA  | 1              |
| <b>HDR-201</b> | 2 Main        | 60000E0110  | DPST-NO              | 1-24                            | 45-75                            | EA  | 1              |
| <b>HDR-202</b> | 2 Main        | 60000E0109  | DPST-NO              | 30-70                           | 1-40                             | EA  | 1              |
| <b>HDR-211</b> | 2 Main Staged | 60200A0117  | DPST-NO              | 30-110                          | 1-40                             | EA  | 1              |
| <b>HDR-212</b> | 2 Main Staged | 60200A0127  | DPST-NO              | 1-25                            | 50-110                           | EA  | 1              |
| <b>HDR-221</b> | 3 Main Staged | 51172-131-1 | DPST-NO SPST-NO      | 1-25                            | 50-110                           | EA  | 1              |
| <b>HDR-222</b> | 4 Main Staged | 51172-131-2 | 2 DPST-NO            | 1-40                            | 50-110                           | EA  | 1              |

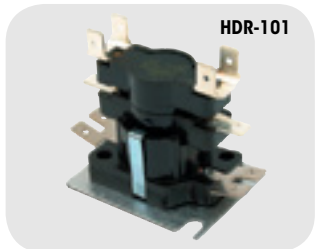

**Manual Reset Fire Stat**

This bi metal switch is used as a manual reset. When temperature condition is met, the device opens. The manual reset can only be reset after proper cool down of the switch. The HMR 130 is a popular fire stat in ducted air distribution systems. Should temperatures in the duct exceed 130 degree F, the switch opens, shutting down the whole system so no fire or smoke can be spread by the fan.

| CATALOG NO.    | DESCRIPTION                     | UOM | ORDER MULTIPLE |
|----------------|---------------------------------|-----|----------------|
| <b>HMR-130</b> | Bi-metal Manual Reset Fire Stat | EA  | 1              |





## THERMOSTATS

### LuxPro Thermostats

LuxPro thermostats are designed to be a reliable, simple solution to in home comfort, so that everyone can enjoy the benefits and comforts of advanced temperature control. Diversitech offers a variety of LuxPro models and options to match any installation need.



675-P521U

| CATALOG NO.         | DESCRIPTION   | UOM | ORDER MULTIPLE |
|---------------------|---|-----|----------------|
| <b>675-P521U</b>    | 5-2 program, 2 H/1 C, Programmable                                    | EA  | 1              |
| <b>675-P621U</b>    | 5-1-1 program, 2 H/1 C, Programmable                                  | EA  | 1              |
| <b>675-P721UT</b>   | 7 Day, 2 H/1 C, Programmable, Touchscreen                             | EA  | 1              |
| <b>675-P722U</b>    | 7 Day, Programmable, 2 H/2 C for Conventional, 2 H/1 C for Heat Pumps | EA  | 1              |
| <b>675-PSD010BF</b> | Digital for Heat Only, with Fan Switch                                | EA  | 1              |
| <b>675-PSD111</b>   | 1 H/1 C, Non-Programmable, Vertical/Horizontal                        | EA  | 1              |
| <b>675-PSDH121</b>  | 1 or 2 H/C, Non-Programmable, Vertical/Horizontal                     | EA  | 1              |
| <b>675-PSM30SA</b>  | Heat Only Mechanical  | EA  | 1              |
| <b>675-PSM40SA</b>  | Heating & Cool Mechanical   | EA  | 1              |
| <b>675-PSP722E</b>  | 3 H/2 C, Programmable for Heat Pumps, 2 H/2 C for Conventional        | EA  | 1              |

## THERMOSTAT GUARDS

### Plastic Thermostat Guards

Use to prevent tampering with thermostats. The covers are clear, allowing complete viewing of the thermostat and current settings. Furnished complete with ring and/or solid base. Includes vent holes for easy airflow across the thermostat. Lockable with universal key. Internal dimensional clearance/sizing for thermostats as noted.



585-TG1

| CATALOG NO.     | DESCRIPTION                | T-STAT CLEARANCE         | UOM | ORDER MULTIPLE |
|-----------------|----------------------------|--------------------------|-----|----------------|
| <b>585-TG</b>   | Clear Plastic w/Two Bases  | 8-1/4" x 4-1/2" x 3-1/4" | EA  | 1              |
| <b>585-TG1</b>  | Clear Plastic w/Two Bases  | 5-3/4" x 3-1/2" x 2-3/4" | EA  | 1              |
| <b>585-TG2</b>  | Clear Plastic w/Two Bases  | 4-3/4" x 4-1/4" x 2-3/4" | EA  | 1              |
| <b>585-TG5</b>  | Clear Plastic w/Solid Base | 3-1/2" x 3-1/4" x 2-1/4" | EA  | 1              |
| <b>585-TG6</b>  | Clear Plastic w/Two Bases  | 6-1/4" x 3-3/4" x 1-3/4" | EA  | 1              |
| <b>585-F336</b> | Key for Thermostat Guard   |                          | EA  | 1              |

### Steel Thermostat Guards

Steel thermostat guards are used to prevent tampering with thermostats. The covers are steel, giving complete tamper protection of the thermostat, and physical impact protection. Great for warehouse and industrial locations. Furnished complete with ring and/or solid base as noted. Includes vent holes for easy airflow across the thermostat. Lockable with universal key. Internal dimensional clearance/sizing for thermostats as noted.



585-TG4

| CATALOG NO.    | DESCRIPTION              | T-STAT CLEARANCE         | UOM | ORDER MULTIPLE |
|----------------|--------------------------|--------------------------|-----|----------------|
| <b>585-TG3</b> | Beige Steel w/Solid Base | 6" x 4" x 3"             | EA  | 1              |
| <b>585-TG4</b> | Beige Steel w/Ring Base  | 6" x 4" x 3"             | EA  | 1              |
| <b>585-TG7</b> | Beige Steel w/Solid Base | 5-1/2" x 3-1/2" x 2-3/4" | EA  | 1              |
| <b>585-TG8</b> | Beige Steel w/Ring Base  | 5" x 3" x 2-3/4"         | EA  | 1              |
| <b>585-TG9</b> | Beige Steel w/Two Bases  | 6" x 4" x 3"             | EA  | 1              |

### Cross Reference

| DIVERSITECH PART NO. | BEKO PART NO. | BRAMEC PART NO. | MARS PART NO. |
|----------------------|---------------|-----------------|---------------|
| <b>585-TG</b>        | BTG-UK2       | 13012           | 70220         |
| <b>585-TG1</b>       | BTG-RK        | 13016           | 70210         |
| <b>585-TG2</b>       | BTG-K         | 13008           | 70205         |
| <b>585-TG3</b>       | BTG-UM        | 13010           | 70223         |
| <b>585-TG4</b>       | BTG-UWM       | 13011           | 70224         |
| <b>585-TG5</b>       | BTG-EK        | 13004           | 70201         |
| <b>585-TG6</b>       | BTG-DK        | 13018           | 70217         |
| <b>585-TG7</b>       | BTG-54VL      | 13002           | 70215         |
| <b>585-TG8</b>       | BTG-54VLW     | 13001           | 70216         |

**THERMOSTAT WIRE**

**Thermostat Wire**

Class 2 thermostat wire for indoor wiring needs. Soft drawn bare copper wire, semi rigid PVC insulation and PVC overall jacket. Packaged on aluminum spool.



620-18-5

| CATALOG NO. | DESCRIPTION                           | UOM | ORDER MULTIPLE |
|-------------|---------------------------------------|-----|----------------|
| 620-18-2    | 18 AWG, 2 Conductors – 500 ft. Spool  | EA  | 4              |
| 620-18-3    | 18 AWG, 3 Conductors – 500 ft. Spool  | EA  | 4              |
| 620-18-4    | 18 AWG, 4 Conductors – 250 ft. Spool  | EA  | 4              |
| 620-18-5    | 18 AWG, 5 Conductors – 250 ft. Spool  | EA  | 4              |
| 620-18-6    | 18 AWG, 6 Conductors – 250 ft. Spool  | EA  | 4              |
| 620-18-7    | 18 AWG, 7 Conductors – 250 ft. Spool  | EA  | 4              |
| 620-18-8    | 18 AWG, 8 Conductors – 250 ft. Spool  | EA  | 4              |
| 620-18-10   | 18 AWG, 10 Conductors – 250 ft. Spool | EA  | 4              |
| 620-18-12   | 18 AWG, 12 Conductors – 250 ft. Spool | EA  | 4              |
| 620-20-2    | 20 AWG, 2 Conductors – 500 ft. Spool  | EA  | 4              |
| 620-20-3    | 20 AWG, 3 Conductors – 500 ft. Spool  | EA  | 4              |
| 620-20-4    | 20 AWG, 4 Conductors – 250 ft. Spool  | EA  | 4              |
| 620-20-5    | 20 AWG, 5 Conductors – 250 ft. Spool  | EA  | 4              |
| 620-20-6    | 20 AWG, 6 Conductors – 250 ft. Spool  | EA  | 4              |
| 620-20-7    | 20 AWG, 7 Conductors – 250 ft. Spool  | EA  | 4              |
| 620-20-8    | 20 AWG, 8 Conductors – 250 ft. Spool  | EA  | 4              |
| 620-20-10   | 20 AWG, 10 Conductors – 250 ft. Spool | EA  | 4              |

U.L. Listed. Meets Subject 13 per Article 725, 1990 NEC.

**Plenum Thermostat Wire**

The Plenum Thermostat Wire is UL Listed type CL2P NEC Article 725 and is designed for use in thermostat control applications.



620-18-3P

| CATALOG NO. | DESCRIPTION                          | UOM | ORDER MULTIPLE |
|-------------|--------------------------------------|-----|----------------|
| 620-18-2P   | 18 AWG, 2 Conductors – 500 ft. Spool | EA  | 4              |
| 620-18-3P   | 18 AWG, 3 Conductors – 500 ft. Spool | EA  | 4              |
| 620-18-6P   | 18 AWG, 6 Conductors – 250 ft. Spool | EA  | 4              |
| 620-18-8P   | 18 AWG, 8 Conductors – 250 ft. Spool | EA  | 4              |

**Wire for Mini-Split Installation**

Wire and cabling specific for mini split installation power supply and control circuits.



230-18-4

| CATALOG NO. | DESCRIPTION                              | UOM | ORDER MULTIPLE |
|-------------|--|-----|----------------|
| 230-18-4    | Stranded Shielded CL3R, 50' per roll     | EA  | 1              |
| 230-16-2    | Stranded Shielded CL3R, 50' per roll     | EA  | 1              |
| 230-14-4    | Stranded Non-Shielded CL3R, 50' per roll | EA  | 1              |
| 230-14-7    | Stranded Non-Shielded CL3R, 50' per roll | EA  | 1              |
| 230-14-4S   | Stranded Shielded CL3R, 50' per roll     | EA  | 1              |

**STRANDED COPPER THHN WIRE**

**Stranded Copper Wire in Clear Dispenser Pack, 194°F**

This copper wire is UL listed and THHN wire. It is 19 strand copper and is 600 V as well as 90C Stranded.



W142

| CATALOG NO. | DESCRIPTION             | UOM | ORDER MULTIPLE |
|-------------|-------------------------|-----|----------------|
| W801        | 08 Gauge, 10 ft., Black | EA  | 1              |
| W802        | 08 Gauge, 10 ft., Red   | EA  | 1              |
| W803        | 08 Gauge, 10 ft., Green | EA  | 1              |
| W804        | 08 Gauge, 10 ft., Blue  | EA  | 1              |
| W805        | 08 Gauge, 10 ft., White | EA  | 1              |
| W101        | 10 Gauge, 10 ft., Black | EA  | 1              |
| W102        | 10 Gauge, 10 ft., Red   | EA  | 1              |
| W103        | 10 Gauge, 10 ft., Green | EA  | 1              |
| W104        | 10 Gauge, 10 ft., Blue  | EA  | 1              |
| W105        | 10 Gauge, 10 ft., White | EA  | 1              |
| W121        | 12 Gauge, 15 ft., Black | EA  | 1              |
| W122        | 12 Gauge, 15 ft., Red   | EA  | 1              |
| W123        | 12 Gauge, 15 ft., Green | EA  | 1              |
| W124        | 12 Gauge, 15 ft., Blue  | EA  | 1              |
| W125        | 12 Gauge, 15 ft., White | EA  | 1              |
| W141        | 14 Gauge, 20 ft., Black | EA  | 1              |
| W142        | 14 Gauge, 20 ft., Red   | EA  | 1              |
| W143        | 14 Gauge, 20 ft., Green | EA  | 1              |
| W144        | 14 Gauge, 20 ft., Blue  | EA  | 1              |
| W145        | 14 Gauge, 20 ft., White | EA  | 1              |

**Stranded Copper Wire on Spool**

This copper wire is UL listed and THHN wire. It is 19 strand copper and is 600 V as well as 90C Stranded. This comes 100 ft. per spool.



W803-100

| CATALOG NO. | DESCRIPTION                    | UOM | ORDER MULTIPLE |
|-------------|--------------------------------|-----|----------------|
| W801-100    | 08 Gauge, 100 ft. Spool, Black | EA  | 1              |
| W802-100    | 08 Gauge, 100 ft. Spool, Red   | EA  | 1              |
| W803-100    | 08 Gauge, 100 ft. Spool, Green | EA  | 1              |
| W804-100    | 08 Gauge, 100 ft. Spool, Blue  | EA  | 1              |
| W805-100    | 08 Gauge, 100 ft. Spool, White | EA  | 1              |
| W101-100    | 10 Gauge, 100 ft. Spool, Black | EA  | 1              |
| W102-100    | 10 Gauge, 100 ft. Spool, Red   | EA  | 1              |
| W103-100    | 10 Gauge, 100 ft. Spool, Green | EA  | 1              |
| W104-100    | 10 Gauge, 100 ft. Spool, Blue  | EA  | 1              |
| W105-100    | 10 Gauge, 100 ft. Spool, White | EA  | 1              |
| W121-100    | 12 Gauge, 100 ft. Spool, Black | EA  | 1              |
| W122-100    | 12 Gauge, 100 ft. Spool, Red   | EA  | 1              |
| W123-100    | 12 Gauge, 100 ft. Spool, Green | EA  | 1              |
| W124-100    | 12 Gauge, 100 ft. Spool, Blue  | EA  | 1              |
| W125-100    | 12 Gauge, 100 ft. Spool, White | EA  | 1              |
| W141-100    | 14 Gauge, 100 ft. Spool, Black | EA  | 1              |
| W142-100    | 14 Gauge, 100 ft. Spool, Red   | EA  | 1              |
| W143-100    | 14 Gauge, 100 ft. Spool, Green | EA  | 1              |
| W144-100    | 14 Gauge, 100 ft. Spool, Blue  | EA  | 1              |
| W145-100    | 14 Gauge, 100 ft. Spool, White | EA  | 1              |

**STRANDED COPPER THHN WIRE** cont'd

**Stranded Copper Wire on Spool**

This copper wire is UL listed and THHN wire. It is 19 strand copper and is 600 V as well as 90C Stranded. This comes 50 ft. per spool.



| CATALOG NO.    | DESCRIPTION                   | UOM | ORDER MULTIPLE |
|----------------|-------------------------------|-----|----------------|
| <b>W801-50</b> | 08 Gauge, 50 ft. Spool, Black | EA  | 1              |
| <b>W802-50</b> | 08 Gauge, 50 ft. Spool, Red   | EA  | 1              |
| <b>W803-50</b> | 08 Gauge, 50 ft. Spool, Green | EA  | 1              |
| <b>W804-50</b> | 08 Gauge, 50 ft. Spool, Blue  | EA  | 1              |
| <b>W101-50</b> | 10 Gauge, 50 ft. Spool, Black | EA  | 1              |
| <b>W102-50</b> | 10 Gauge, 50 ft. Spool, Red   | EA  | 1              |
| <b>W103-50</b> | 10 Gauge, 50 ft. Spool, Green | EA  | 1              |
| <b>W104-50</b> | 10 Gauge, 50 ft. Spool, Blue  | EA  | 1              |
| <b>W105-50</b> | 10 Gauge, 50 ft. Spool, White | EA  | 1              |
| <b>W121-50</b> | 12 Gauge, 50 ft. Spool, Black | EA  | 1              |
| <b>W122-50</b> | 12 Gauge, 50 ft. Spool, Red   | EA  | 1              |
| <b>W123-50</b> | 12 Gauge, 50 ft. Spool, Green | EA  | 1              |
| <b>W124-50</b> | 12 Gauge, 50 ft. Spool, Blue  | EA  | 1              |
| <b>W125-50</b> | 12 Gauge, 50 ft. Spool, White | EA  | 1              |
| <b>W141-50</b> | 14 Gauge, 50 ft. Spool, Black | EA  | 1              |
| <b>W142-50</b> | 14 Gauge, 50 ft. Spool, Red   | EA  | 1              |
| <b>W143-50</b> | 14 Gauge, 50 ft. Spool, Green | EA  | 1              |
| <b>W144-50</b> | 14 Gauge, 50 ft. Spool, Blue  | EA  | 1              |
| <b>W145-50</b> | 14 Gauge, 50 ft. Spool, White | EA  | 1              |

**High Temperature Wire, 400°F (204°C), 600 V.**

7 strand tin coated copper wire with silicone rubber insulation protected by a braided fiberglass jacket. Use on the front of all gas furnaces with spark ignition because of flame roll out on start up. Also on all power feeds to electric strip and duct heaters. Also used on all heat producing food preparation equipment.



| CATALOG NO.      | DESCRIPTION                          | UOM | ORDER MULTIPLE |
|------------------|--------------------------------------|-----|----------------|
| <b>WHT20</b>     | 14 gauge, 10 ft. black, 10 ft. white | EA  | 1              |
| <b>WHTB14-50</b> | 14 gauge, black, 50 ft.              | EA  | 1              |
| <b>WHTR14-50</b> | 14 gauge, red, 50 ft.                | EA  | 1              |
| <b>WHTW14-50</b> | 14 gauge, white, 50 ft.              | EA  | 1              |
| <b>WHTB12-50</b> | 12 gauge, black, 20 ft.              | EA  | 1              |
| <b>WHTB12-20</b> | 12 gauge, black, 50 ft.              | EA  | 1              |
| <b>WHTB10-20</b> | 10 gauge, black, 20 ft.              | EA  | 1              |
| <b>WHTB10-50</b> | 10 gauge, black, 50 ft.              | EA  | 1              |

**WIRE CONNECTORS**

**Wire Connectors—Screw On, U.L. Listed, C.S.A Approved**

Color coded connectors make quick, secure connections for positive continuity. High dielectric thermoplastic shell resists chemical action from hydrocarbons, dilute acid or alkaline solutions. Deep skirt design prevents exposure of bare wire.



| CATALOG NO.    | DESCRIPTION  | UOM | ORDER MULTIPLE |
|----------------|--|-----|----------------|
| <b>623-001</b> | Gray Screw-On – Size 71B, #22 to #16 AWG, 300V Max., pack of 100   | PK  | 1              |
| <b>623-002</b> | Blue Screw-On – Size 72B, #22 to #16 AWG, 300V Max., pack of 100   | PK  | 1              |
| <b>623-003</b> | Orange Screw-On – Size 73B, #22 to #14 AWG, 600V Max., pack of 100 | PK  | 1              |
| <b>623-004</b> | Yellow Screw-On – Size 74B, #18 to #10 AWG, 600V Max., pack of 100 | PK  | 1              |
| <b>623-005</b> | Red Screw-On – Size 76B, #18 to #10 AWG, 600V Max., pack of 100    | PK  | 1              |
| <b>623-MIX</b> | Wire connector assortment, Pack of 570                             | PK  | 1              |

U.L. Listed, CSA Approved.

**Wire Connectors—Winged, U.L. Listed, C.S.A Approved**

Wings give surer grip; offset center design provides great twisting leverage. Expandable square-wire spring instantly adjusts to shape and size to create a strong, vibration-resistant connection. Same tough shell as screw-on type.



| CATALOG NO.    | DESCRIPTION  | UOM | ORDER MULTIPLE |
|----------------|--|-----|----------------|
| <b>623-000</b> | Lg. Gray Winged – Size 78B, #14 to #8 AWG, 600V Max., pack of 50 | PK  | 1              |
| <b>623-006</b> | Yellow Winged – Size 84, #22 to #10 AWG, 600V Max., pack of 100  | PK  | 1              |
| <b>623-007</b> | Red Winged – Size 86, #18 to #10 AWG, 600V Max., pack of 100     | PK  | 1              |
| <b>623-008</b> | Blue Winged – Size 89, #10 to #6, 600V Max., pack of 50          | PK  | 1              |

U.L. Listed, C.S.A. Approved.

**WIRE CONNECTORS cont'd**

**Wire Connectors—Screw On, U.L. Listed, C.S.A Approved**

Color coded connectors make quick, secure connections for positive continuity. High dielectric thermoplastic shell resists chemical action from hydrocarbons, dilute acid or alkaline solutions. Deep skirt design prevents exposure of bare wire. New handy carry handle and grip bottle. U.L. Listed. C.S.A. Approved.



| CATALOG NO.    | DESCRIPTION  | UOM | ORDER MULTIPLE |
|----------------|--|-----|----------------|
| <b>623-012</b> | Blue Screw-On – Size 72B, #22 to #16 AWG, 300V Max., pack of 600   | PK  | 1              |
| <b>623-013</b> | Orange Screw-On – Size 73B, #22 to #14 AWG, 600V Max., pack of 300 | PK  | 1              |
| <b>623-014</b> | Yellow Screw-On – Size 74B, #18 to #10 AWG, 600V Max., pack of 200 | PK  | 1              |

U.L. Listed. CSA Approved.

**Porcelain Wire Connectors**

Porcelain Wire Connectors are used in high temperature applications such as appliances.



| CATALOG NO.  | DESCRIPTION                      | AWG                  | UOM | ORDER MULTIPLE |
|--------------|----------------------------------|----------------------|-----|----------------|
| <b>CPN1</b>  | Porcelain – Small, pack of 15    | 22-16, 2 Strand Wire | PK  | 1              |
| <b>CPN1C</b> | Porcelain – Small, pack of 100   | 22-16, 2 Strand Wire | PK  | 1              |
| <b>CPN2</b>  | Porcelain – Medium, pack of 10   | 18-14, 2 Strand Wire | PK  | 1              |
| <b>CPN2C</b> | Porcelain – Medium, pack of 100  | 18-14, 2 Strand Wire | PK  | 1              |
| <b>CPN3</b>  | Porcelain – Large, pack of 10    | 18-14, 3 Strand Wire | PK  | 1              |
| <b>CPN3C</b> | Porcelain – Large, pack of 100   | 18-14, 3 Strand Wire | PK  | 1              |
| <b>CPN2M</b> | Porcelain – Medium, pack of 1000 | 18-14, 2 Strand Wire | PK  | 1              |

**Wire Connectors—Contractor Packs, U.L. Listed, C.S.A Approved**

These connectors have a high dielectric thermoplastic shell. These are UL listed and CSA approved. This product is great for making quick and secure connections.



| CATALOG NO.  | DESCRIPTION                                | UOM | ORDER MULTIPLE |
|--------------|--|-----|----------------|
| <b>C222</b>  | Closed End Connectors 22-14 W, pack of 18  | PK  | 1              |
| <b>C222C</b> | Closed End Connectors 22-14 W, pack of 100 | PK  | 1              |
| <b>C223</b>  | Closed End Connectors 18-10 W, pack of 15  | PK  | 1              |
| <b>C223C</b> | Closed End Connectors 18-10 W, pack of 100 | PK  | 1              |
| <b>C241</b>  | Blue Wire Connectors 22-16 W, pack of 20   | PK  | 1              |
| <b>C243</b>  | Orange Wire Connectors 22-14 W, pack of 15 | PK  | 1              |
| <b>C245</b>  | Yellow Wire Connectors 18-10 W, pack of 13 | PK  | 1              |
| <b>C247</b>  | Red Wire Connectors 18-10 W, pack of 10    | PK  | 1              |
| <b>C312</b>  | Yellow Winged Wire Connectors, pack of 13  | PK  | 1              |
| <b>C312L</b> | Yellow Winged Wire Connectors, pack of 50  | PK  | 1              |
| <b>C512</b>  | Red Winged Wire Connectors, pack of 10     | PK  | 1              |
| <b>C512L</b> | Red Winged Wire Connectors, pack of 50     | PK  | 1              |

U.L. Listed. CSA Approved.

**WIRE/CABLE TIES, MOUNTS, CLAMPS**

**Cable Tie Assortment Pack**

6.6 nylon, the heavy duty duct straps feature smooth insertion, and a locking mechanism that gives ductwork a firm hold. Accommodates 7 to 15 inch duct. Tensioning tool for 32"+ allows operator to adjust strap to any desired tension.



| CATALOG NO.     | DESCRIPTION   | UOM | ORDER MULTIPLE |
|-----------------|---|-----|----------------|
| <b>7-711</b>    | Natural Cable Tie Assortment – 7" and 11", pack of 150      | PK  | 25             |
| <b>7-711-B</b>  | Black Cable Tie Assortment – 7" and 11", pack of 150        | PK  | 25             |
| <b>7-5811</b>   | Natural Cable Tie Assortment – 5", 8", and 11", pack of 450 | PK  | 30             |
| <b>7-5811-B</b> | Black Cable Tie Assortment – 5", 8", and 11", pack of 450   | PK  | 30             |

**Heavy Duty Cable Ties**

6.6 nylon, the heavy duty duct straps feature smooth insertion, and a locking mechanism that gives ductwork a firm hold. Accommodates 7 to 15 inch duct. Tensioning tool for 32"+ allows operator to adjust strap to any desired tension.

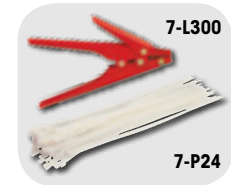

| CATALOG NO.   | DESCRIPTION  | UOM | ORDER MULTIPLE |
|---------------|--|-----|----------------|
| <b>7-P24</b>  | 24" Long – Fits up to 6" Duct – 175 lb. Tensile          | EA  | 50             |
| <b>7-P36</b>  | 36" Long – Fits up to 10" Duct – 175 lb. Tensile         | EA  | 50             |
| <b>7-P36B</b> | 36" Long – Black – Fits up to 10" Duct – 175 lb. Tensile | EA  | 50             |
| <b>7-P48</b>  | 48" Long – Fits up to 14" Duct – 175 lb. Tensile         | EA  | 50             |
| <b>7-P48B</b> | 48" Long – Black – Fits up to 14" Duct – 175 lb. Tensile | EA  | 25             |
| <b>7-L300</b> | Tensioning Tool for 120-175 lb. Ties                     | EA  | 1              |



**WIRE/CABLE TIES, MOUNTS, CLAMPS cont'd**

**White Nylon Ties with Mounting Hole**

These wire ties are perfect for securing wires. You can choose from an assortment of sizes.

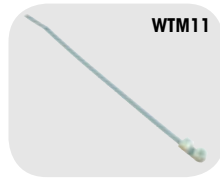

| CATALOG NO. | DESCRIPTION   | TENSILE STRENGTH | UOM | ORDER MULTIPLE |
|-------------|---|------------------|-----|----------------|
| WTM05       | White Wire Ties with Mounting Hole – 5" Nylon, pack of 13   | 18               | PK  | 1              |
| WTM05C      | White Wire Ties with Mounting Hole – 5" Nylon, pack of 100  | 18               | PK  | 1              |
| WTM07       | White Wire Ties with Mounting Hole – 7" Nylon, pack of 11   | 50               | PK  | 1              |
| WTM07C      | White Wire Ties with Mounting Hole – 7" Nylon, pack of 100  | 50               | PK  | 1              |
| WTM11       | White Wire Ties with Mounting Hole – 11" Nylon, pack of 6   | 50               | PK  | 1              |
| WTM11C      | White Wire Ties with Mounting Hole – 11" Nylon, pack of 100 | 50               | PK  | 1              |
| WTM14       | White Wire Ties with Mounting Hole – 14" Nylon, pack of 5   | 50               | PK  | 1              |
| WTM14C      | White Wire Ties with Mounting Hole – 14" Nylon, pack of 100 | 50               | PK  | 1              |

**Black Nylon Ties with Mounting Hole**

These wire ties are perfect for securing wires. You can choose from an assortment of sizes.



| CATALOG NO. | DESCRIPTION   | TENSILE STRENGTH | UOM | ORDER MULTIPLE |
|-------------|---|------------------|-----|----------------|
| WTMB05      | Black Wire Ties with Mounting Hole – 5" Nylon, pack of 12   | 18               | PK  | 1              |
| WTMB05C     | Black Wire Ties with Mounting Hole – 5" Nylon, pack of 100  | 18               | PK  | 1              |
| WTMB07      | Black Wire Ties with Mounting Hole – 7" Nylon, pack of 10   | 50               | PK  | 1              |
| WTMB07C     | Black Wire Ties with Mounting Hole – 7" Nylon, pack of 100  | 50               | PK  | 1              |
| WTMB11      | Black Wire Ties with Mounting Hole – 11" Nylon, pack of 6   | 50               | PK  | 1              |
| WTMB11C     | Black Wire Ties with Mounting Hole – 11" Nylon, pack of 100 | 50               | PK  | 1              |
| WTMB14      | Black Wire Ties with Mounting Hole – 14" Nylon, pack of 5   | 50               | PK  | 1              |
| WTMB14C     | Black Wire Ties with Mounting Hole – 14" Nylon, pack of 100 | 50               | PK  | 1              |

**Wire and Cable Clamps – Nylon**

These wire ties are perfect for securing wires. You can choose from an assortment of diameter sizes.



| CATALOG NO. | DESCRIPTION   | UOM | ORDER MULTIPLE |
|-------------|---|-----|----------------|
| WC02        | Wire and Cable Clamps – 1/8" Diameter, pack of 40         | PK  | 1              |
| WC03        | Wire and Cable Clamps – 3/16" Diameter, pack of 40        | PK  | 1              |
| WC04        | Wire and Cable Clamps – 1/4" Diameter, pack of 35         | PK  | 1              |
| WC05        | Wire and Cable Clamps – 5/16" Diameter, pack of 35        | PK  | 1              |
| WC06        | Wire and Cable Clamps – 3/8" Diameter, pack of 30         | PK  | 1              |
| WC07        | Wire and Cable Clamps – 7/16" Diameter, pack of 30        | PK  | 1              |
| WC08        | Wire and Cable Clamps – 1/2" Diameter, pack of 25         | PK  | 1              |
| WC09        | Wire and Cable Clamps – 9/16" Diameter, pack of 20        | PK  | 1              |
| WC10        | Wire and Cable Clamps – 5/8" Diameter, pack of 20         | PK  | 1              |
| WC12        | Wire and Cable Clamps – 3/4" Diameter, pack of 15         | PK  | 1              |
| WC14        | Wire and Cable Clamps – 7/8" Diameter, pack of 15         | PK  | 1              |
| WC16        | Wire and Cable Clamps – 1" Diameter, pack of 14           | PK  | 1              |
| WCA1        | Wire and Cable Clamps Assortment – 1/8" to 1", pack of 26 | PK  | 1              |

All above sizes are available in 100 packs. Add "C" to the end of the part number.

**White Nylon Wire Ties**

These wire ties are perfect for securing wires. You can choose from an assortment of sizes.

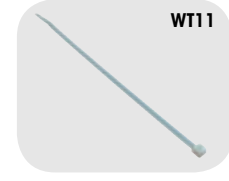

| CATALOG NO. | DESCRIPTION  | TENSILE STRENGTH | UOM | ORDER MULTIPLE |
|-------------|--|------------------|-----|----------------|
| WT04        | White Wire Ties – 4" Nylon, pack of 40                       | 18               | PK  | 1              |
| WT04C       | White Wire Ties – 4" Nylon, pack of 100                      | 18               | PK  | 1              |
| WT05        | White Wire Ties – 5" Nylon, pack of 35                       | 18               | PK  | 1              |
| WT05C       | White Wire Ties – 5" Nylon, pack of 100                      | 18               | PK  | 1              |
| WT07        | White Wire Ties – 7" Nylon, pack of 30                       | 50               | PK  | 1              |
| WT07C       | White Wire Ties – 7" Nylon, pack of 100                      | 50               | PK  | 1              |
| WT07M       | White Wire Ties – 7" Nylon, pack of 1000                     | 50               | PK  | 1              |
| WT11        | White Wire Ties – 11" Nylon, pack of 15                      | 50               | PK  | 1              |
| WT11C       | White Wire Ties – 11" Nylon, pack of 100                     | 50               | PK  | 1              |
| WT11L       | White Wire Ties – 11" Nylon, pack of 50                      | 50               | PK  | 1              |
| WT15        | White Wire Ties – 15" Nylon, pack of 12                      | 50               | PK  | 1              |
| WT15C       | White Wire Ties – 15" Nylon, pack of 100                     | 50               | PK  | 1              |
| WTA1        | White Wire Ties – Assorted 4", 7", and 11" Nylon, pack of 30 |                  | PK  | 1              |

**Black Nylon Wire Ties**

These wire ties are perfect for securing wires. You can choose from an assortment of sizes. Ultraviolet resistant for outdoor use.

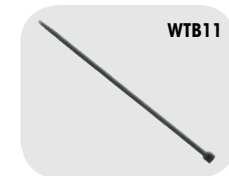

| CATALOG NO. | DESCRIPTION  | TENSILE STRENGTH | UOM | ORDER MULTIPLE |
|-------------|--|------------------|-----|----------------|
| WTB05       | Black Wire Ties – 6" Nylon, pack of 35                       | 18               | PK  | 1              |
| WTB05C      | Black Wire Ties – 6" Nylon, pack of 100                      | 18               | PK  | 1              |
| WTB05M      | Black Wire Ties – 6" Nylon, pack of 1000                     | 18               | PK  | 1              |
| WTB07       | Black Wire Ties – 7" Nylon, pack of 30                       | 50               | PK  | 1              |
| WTB07C      | Black Wire Ties – 7" Nylon, pack of 100                      | 50               | PK  | 1              |
| WTB07M      | Black Wire Ties – 7" Nylon, pack of 1000                     | 50               | PK  | 1              |
| WTB11       | Black Wire Ties – 11" Nylon, pack of 15                      | 50               | PK  | 1              |
| WTB11C      | Black Wire Ties – 11" Nylon, pack of 100                     | 50               | PK  | 1              |
| WTB11CR     | Black Wire Ties, Releasable – 11" Nylon, pack of 100         | 50               | PK  | 25             |
| WTB11D      | Black Wire Ties – 11" Nylon, pack of 500                     | 50               | PK  | 1              |
| WTB11M      | Black Wire Ties – 11" Nylon, pack of 1000                    | 50               | PK  | 1              |
| WTB15       | Black Wire Ties – 14" Nylon, pack of 12                      | 50               | PK  | 1              |
| WTB15C      | Black Wire Ties – 14" Nylon, pack of 100                     | 50               | PK  | 1              |
| WTBA1       | Black Wire Ties – Assorted 4", 7", and 11" Nylon, pack of 28 | 50               | PK  | 1              |

**Wire Tie Mounts**

These mounts are use for mounting wires in electrical work.



| CATALOG NO. | DESCRIPTION  | UOM | ORDER MULTIPLE |
|-------------|--|-----|----------------|
| WTM1        | White Wire Tie Mounts – Adhesive Back, pack of 4   | PK  | 1              |
| WTM1C       | White Wire Tie Mounts – Adhesive Back, pack of 100 | PK  | 1              |
| WTM2        | White Wire Tie Mounts – #8 Screw, pack of 7        | PK  | 1              |
| WTM2C       | White Wire Tie Mounts – #8 Screw, pack of 100      | PK  | 1              |

# Do **MORE** with **DEVCO**®

*DEVCO products help you do even more for your customers. Offering a broad selection of the parts your contractors need to finish the job, DEVCO helps you provide them all the finishing touches they need for any project. So stock up today and do more with DEVCO.*



# TOOLS

|  |         |
|--|---------|
| Allen Wrenches .....                           | 169     |
| Brushes.....                                   | 169-171 |
| Channellock® Products .....                    | 172     |
| Clipboards.....                                | 172     |
| Electrical Supplies .....                      | 172     |
| Fin Tools.....                                 | 173     |
| Flashlights and Lanterns By Rayovac®.....      | 173     |
| Gauges .....                                   | 175     |
| Manometers, Pressure.....                      | 175     |
| Measuring Tapes, Staples and Staple Guns ..... | 176     |
| Meters, Detectors, Alarms .....                | 176     |
| Miscellaneous Tools.....                       | 176-177 |
| Monitors.....                                  | 177     |
| Nut Setters .....                              | 178     |
| Refractometers .....                           | 178     |
| Rehvac Nitrogen Purging Equipment.....         | 168     |
| Rehvac Refillable Gas Cylinders.....           | 168     |
| Retrieving Tool .....                          | 178     |
| Saws and Saw Blades.....                       | 179     |
| Screwdrivers, Driver Sets.....                 | 179     |
| Snips, Notchers, Crimpers, Seamers .....       | 180     |
| Straps, Truck Rope.....                        | 180-181 |
| Test Leads .....                               | 181-182 |
| Testers .....                                  | 182     |
| Thermometers/Probes.....                       | 183     |
| Tube Working Tools .....                       | 183-184 |
| Welding Torches, Supplies .....                | 184     |
| Worklights by Cliplight® .....                 | 174-175 |

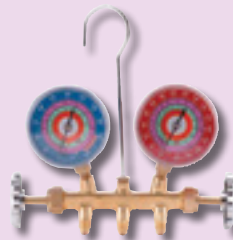

## REHVAC NITROGEN PURGING EQUIPMENT

### Regulators

Rehvac nitrogen and CO<sub>2</sub> regulators feature a machined brass piston with internal bleed-down safety. This design makes the Rehvac regulator long lasting and reliable.



CT-475M

| CATALOG NO. | DESCRIPTION                              | UOM | ORDER MULTIPLE |
|-------------|--|-----|----------------|
| CA-252C     | Rehvac Adjustable Regulator, 0-250psi    | EA  | 1              |
| CT-475M     | Regulator, N/CO <sub>2</sub> – 0-475 psi | EA  | 1              |
| GT-750      | Rehvac Nitrogen Regulator 0-750psi       | EA  | 1              |

### Hoses

Rehvac hoses are designed specifically for air, nitrogen, or CO<sub>2</sub> service. Featuring a 600psi working pressure and a 2200psi burst pressure, Rehvac hoses are abrasion resistant and long lasting.



CW-30

| CATALOG NO. | DESCRIPTION          | UOM | ORDER MULTIPLE |
|-------------|----------------------|-----|----------------|
| CW-30       | Rehvac 30" Whip Hose | EA  | 1              |

### Nitrogen Purge Tool

The Nitrogen Purge Tool is a quick and easy way to purge copper pipes with nitrogen. Then, with a turn of the dial, quickly switch to a very low flow of nitrogen to properly braze the copper. It has a durable aluminum design so you can just throw it into your tool bag when you are done.



DP-1

| CATALOG NO. | DESCRIPTION         | UOM | ORDER MULTIPLE |
|-------------|---------------------|-----|----------------|
| DP-1        | Nitrogen Purge Tool | EA  | 1              |

### Flowmeters

The Rehvac Nitrogen Purge Flow-meter is the perfect tool for purging the line-set before brazing. This flowmeter attaches to the 1/4" flare fitting on a regulator and delivers a metered flow. The flow rate can be increased for the purge process and restricted for the brazing process. Maximum operating pressure is 50 psi. Flowmeter works well with our CT-475M Regulator.



GAU225-PURGE

| CATALOG NO.  | DESCRIPTION                     | UOM | ORDER MULTIPLE |
|--------------|---------------------------------|-----|----------------|
| GAU225-PURGE | Rehvac Nitrogen Purge Flowmeter | EA  | 1              |

### Gauges

Rehvac replacement gauges are reliable and easy to read.



GA-06

| CATALOG NO. | DESCRIPTION                                    | UOM | ORDER MULTIPLE |
|-------------|--|-----|----------------|
| GA-06       | Rehvac 600psi Low Pressure Replacement Gauge   | EA  | 1              |
| GA-30       | Rehvac 3000psi High Pressure Replacement Gauge | EA  | 1              |

## REHVAC REFILLABLE GAS CYLINDERS

### Nitrogen Cylinders

Rehvac aluminum nitrogen cylinders from DiversiTech are commonly used in the HVAC industry for line cleaning and purging, pressure testing and braze purging. Made in the USA.



N20-SD

| CATALOG NO. | DESCRIPTION                       | UOM | ORDER MULTIPLE |
|-------------|-----------------------------------|-----|----------------|
| N20-SD      | Rehvac Nitrogen Cylinder 57 cu ft | EA  | 1              |

### CO<sub>2</sub> Cylinders

Rehvac aluminum CO<sub>2</sub> cylinders from DiversiTech are commonly used in the HVAC industry for condensate line cleaning. Made in the USA.



C10

| CATALOG NO. | DESCRIPTION                              | UOM | ORDER MULTIPLE |
|-------------|--|-----|----------------|
| C10         | Rehvac 10# Aluminum Cylinder             | EA  | 1              |
| C1-2-6      | Rehvac 1.2# Cylinder                     | EA  | 1              |
| C20         | Rehvac 20# Aluminum Cylinder             | EA  | 1              |
| C20-D       | Rehvac 20# Cylinder with Siphon Tube     | EA  | 1              |
| C2-5        | Rehvac Cylinder, 2.5#                    | EA  | 1              |
| C2-5S       | Rehvac 2.5# Cylinder with Straight Valve | EA  | 1              |
| C5          | Rehvac 5# Aluminum Cylinder              | EA  | 1              |



## ALLEN WRENCHES

### Allen Wrenches – Long Arm

Most needed combination of Allen Wrenches packaged in clearly marked vinyl pouches.



| CATALOG NO.   | DESCRIPTION  | UOM | ORDER MULTIPLE |
|---------------|--|-----|----------------|
| <b>AW-712</b> | 7 Keys, 12" long arm series: 5/64", 3/32", 1/8", 5/32", 3/16", 7/32", 1/4"             | EA  | 1              |
| <b>AW-96</b>  | 9 Keys, 6" long arm series: 5/64", 3/32", 1/8", 5/32", 3/16", 7/32", 1/4", 5/16", 3/8" | EA  | 1              |

### Allen Wrenches

The finest quality wrenches available anywhere.

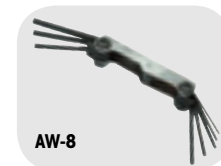

| CATALOG NO. | DESCRIPTION  | UOM | ORDER MULTIPLE |
|-------------|--|-----|----------------|
| <b>AW-8</b> | 3" Handle, 8 Bits, Standard Fold-Ups .050", 1/16", 5/64", 3/32", 7/64", 1/8", 9/64", 5/32"       | EA  | 1              |
| <b>AW-9</b> | 4" Handle, 9 Bits, Standard Fold-Ups 5/64", 3/32", 7/64", 1/8", 9/64", 5/32", 3/16", 7/32", 1/4" | EA  | 1              |

### Allen Wrenches – Individual Sizes

These Allen Wrenches are sold in individual sizes. These are great for specific projects.

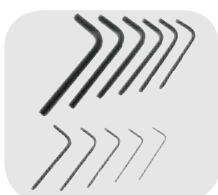

| CATALOG NO.      | DESCRIPTION              | UOM | ORDER MULTIPLE |
|------------------|--------------------------|-----|----------------|
| <b>AW-712-10</b> | Allen Wrench 12" x 5/32" | EA  | 25             |
| <b>AW-712-8</b>  | Allen Wrench 12" x 1/8"  | EA  | 25             |
| <b>AW-96-10</b>  | Allen Wrench 6" x 5/32"  | EA  | 25             |
| <b>AW-96-8</b>   | Allen Wrench 6" x 1/8"   | EA  | 25             |

## BRUSHES

### Chip Brushes

100% pure bristle, wood handle. Poly sleeve over bristles. Inexpensive (use once and throw away). Excellent for applying duct adhesive.



| CATALOG NO.  | DESCRIPTION         | UOM | ORDER MULTIPLE |
|--------------|---------------------|-----|----------------|
| <b>B-501</b> | Chip Brush – 1"     | EA  | 36             |
| <b>B-502</b> | Chip Brush – 1-1/2" | EA  | 36             |
| <b>B-503</b> | Chip Brush – 2"     | EA  | 24             |
| <b>B-504</b> | Chip Brush – 2-1/2" | EA  | 12             |
| <b>B-505</b> | Chip Brush – 3"     | EA  | 12             |

### Welder's Brush

Stainless steel bristles used for cleaning all metals. Great for cleaning aluminum prior to soldering.

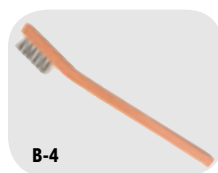

| CATALOG NO. | DESCRIPTION    | UOM | ORDER MULTIPLE |
|-------------|----------------|-----|----------------|
| <b>B-4</b>  | Welder's Brush | EA  | 12             |

### Tin Handle Acid Brushes

Manufactured with electrolyte tin plate and filled with 100% pure stiff horsehair, tied with a steel staple. This combination gives lasting qualities when used with heat and acids or other cleaning agents.

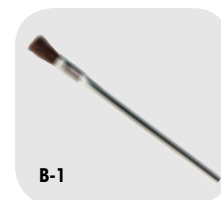

| CATALOG NO. | DESCRIPTION                | UOM | ORDER MULTIPLE |
|-------------|----------------------------|-----|----------------|
| <b>B-1</b>  | Tin Handle Acid Brush 3/8" | EA  | 144            |
| <b>B-2</b>  | Tin Handle Acid Brush 1/2" | EA  | 144            |

### Refrigerator Coil Brush

Clean refrigerator coils, fan blades and areas under and behind appliances. 27-1/2" in length with 11-3/4" brush length. Bristles are 3/4" on the end tapering to 1-1/2" toward the handle.



| CATALOG NO. | DESCRIPTION             | UOM | ORDER MULTIPLE |
|-------------|-------------------------|-----|----------------|
| <b>B-27</b> | Refrigerator Coil Brush | EA  | 1              |

**BRUSHES** cont'd

**Parts Cleaning Brush**

The heavy duty black polypropylene bristles are secured in a strong plastic handle.



| CATALOG NO.      | DESCRIPTION          | UOM | ORDER MULTIPLE |
|------------------|----------------------|-----|----------------|
| <b>542-25015</b> | Parts Cleaning Brush | EA  | 12             |

**Duct Cleaning Brush**

These brushes are made of black fiber bristles twisted in wire. They are 1 1/8in. diameter by 7in. brush x 48in. overall length. These are idea for cleaning hard to reach areas in duct work.

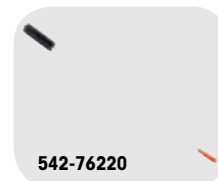

| CATALOG NO.      | DESCRIPTION         | UOM | ORDER MULTIPLE |
|------------------|---------------------|-----|----------------|
| <b>542-76220</b> | Duct Cleaning Brush | EA  | 1              |

**2-in-1 Copper Tube Cleaning Brush**

Easy to hold combination tool that really works. One end cleans the fitting. The other cleans the tube.



| CATALOG NO.  | DESCRIPTION   | UOM | ORDER MULTIPLE |
|--------------|---|-----|----------------|
| <b>B-996</b> | 2-in-1 Copper Tube Cleaning Brush – 1/2" ID (5/8" OD) | EA  | 1              |
| <b>B-998</b> | 2-in-1 Copper Tube Cleaning Brush – 3/4" ID (7/8" OD) | EA  | 1              |

**Outside Tube Cleaning Brushes**

A tough molded plastic holder allows for a comfortable sure grip. The brush has high carbon steel bristles and comes 6 to a box.

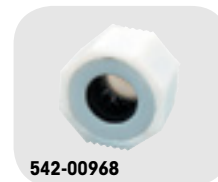

| CATALOG NO.      | DESCRIPTION                                     | UOM | ORDER MULTIPLE |
|------------------|---|-----|----------------|
| <b>542-00968</b> | Outside Tube Cleaning Brush – 3/4" ID (7/8" OD) | EA  | 6              |

**Copper Tube Fitting Brushes**

Highest quality brushes to clean fittings faster, easier and more safely. Made with strong, resilient, rustproof stainless steel bristles secured in a 4-ply wire with easy-to-grip plastic handle. Economy models feature same quality stainless steel, but secured in 2-ply wire.



| CATALOG NO.  | DESCRIPTION  | UOM | ORDER MULTIPLE |
|--------------|--|-----|----------------|
| <b>B-124</b> | Copper Tube Fitting Brush – Economy 1/4" O.D., 9/32" Brush Dia.    | EA  | 6              |
| <b>B-125</b> | Copper Tube Fitting Brush – Economy 3/8" O.D., 13/32" Brush Dia.   | EA  | 6              |
| <b>B-126</b> | Copper Tube Fitting Brush – Economy 1/2" O.D., 17/32" Brush Dia.   | EA  | 6              |
| <b>B-127</b> | Copper Tube Fitting Brush – Economy 5/8" O.D., 11/16" Brush Dia.   | EA  | 6              |
| <b>B-128</b> | Copper Tube Fitting Brush – Economy 3/4" O.D., 13/16" Brush Dia.   | EA  | 6              |
| <b>B-129</b> | Copper Tube Fitting Brush – Economy 7/8" O.D., 15/16" Brush Dia.   | EA  | 6              |
| <b>B-131</b> | Copper Tube Fitting Brush – Economy 1-1/8" O.D., 1-1/4" Brush Dia. | EA  | 6              |
| <b>B-132</b> | Copper Tube Fitting Brush – Economy 1-3/8" O.D., 1-1/2" Brush Dia. | EA  | 6              |
| <b>B-924</b> | Copper Tube Fitting Brush – 1/4" O.D., 9/32" Brush Dia.            | EA  | 1              |
| <b>B-925</b> | Copper Tube Fitting Brush – 3/8" O.D., 13/32" Brush Dia.           | EA  | 1              |
| <b>B-926</b> | Copper Tube Fitting Brush – 1/2" O.D., 17/32" Brush Dia.           | EA  | 1              |
| <b>B-927</b> | Copper Tube Fitting Brush – 5/8" O.D., 11/16" Brush Dia.           | EA  | 1              |
| <b>B-928</b> | Copper Tube Fitting Brush – 3/4" O.D., 13/16" Brush Dia.           | EA  | 1              |
| <b>B-929</b> | Copper Tube Fitting Brush – 7/8" O.D., 15/16" Brush Dia.           | EA  | 1              |
| <b>B-930</b> | Copper Tube Fitting Brush – 1" O.D., 1-1/8" Brush Dia.             | EA  | 1              |
| <b>B-931</b> | Copper Tube Fitting Brush – 1-1/8" O.D., 1-1/4" Brush Dia.         | EA  | 1              |
| <b>B-932</b> | Copper Tube Fitting Brush – 1-3/8" O.D., 1-1/2" Brush Dia.         | EA  | 1              |
| <b>B-934</b> | Copper Tube Fitting Brush – 1-5/8" O.D., 1-3/4" Brush Dia.         | EA  | 1              |
| <b>B-935</b> | Copper Tube Fitting Brush – 2-1/8" O.D., 2-1/4" Brush Dia.         | EA  | 1              |

**BRUSHES** cont'd

**Carbon Steel Curved Handle Scratch Brush**

Carbon Steel Curved Handle Scratch Brushes are used for general purpose cleaning.



| CATALOG NO. | DESCRIPTION                              | UOM | ORDER MULTIPLE |
|-------------|--|-----|----------------|
| <b>B-10</b> | Carbon Steel Curved Handle Scratch Brush | EA  | 1              |

**Fin Whisk**

A plastic handled whisk for cleaning condenser and evaporator fins.



| CATALOG NO. | DESCRIPTION     | UOM | ORDER MULTIPLE |
|-------------|-----------------|-----|----------------|
| <b>B-26</b> | Fin Whisk Brush | EA  | 12             |

**Condenser/Heat Exchanger Brushes**

Ideal for cleaning mineral deposits from inside metal tubes. Especially recommended for use with power tools, although handle for manual use is available.



| CATALOG NO.  | DESCRIPTION   | UOM | ORDER MULTIPLE |
|--------------|---|-----|----------------|
| <b>B-604</b> | Condenser/Heat Exchanger Brush – 3/8" Brass 12-24 Female      | EA  | 1              |
| <b>B-610</b> | Condenser/Heat Exchanger Brush – 1/2" Brass 12-24 Female      | EA  | 1              |
| <b>B-616</b> | Condenser/Heat Exchanger Brush – 5/8" Brass 12-24 Female      | EA  | 1              |
| <b>B-622</b> | Condenser/Heat Exchanger Brush – 3/4" Brass 12-24 Female      | EA  | 1              |
| <b>B-628</b> | Condenser/Heat Exchanger Brush – 7/8" Brass 12-24 Female      | EA  | 1              |
| <b>B-633</b> | Condenser/Heat Exchanger Brush – 7/8" Brass 12-24 Female      | EA  | 1              |
| <b>B-704</b> | Condenser/Heat Exchanger Brush – 1" Nylon 12-24 Female        | EA  | 1              |
| <b>B-716</b> | Condenser/Heat Exchanger Brush – 5/8" Nylon 12-24 Female      | EA  | 1              |
| <b>B-722</b> | Condenser/Heat Exchanger Brush – 3/4" Nylon 12-24 Female      | EA  | 1              |
| <b>B-733</b> | Condenser/Heat Exchanger Brush – 1" Nylon 12-24 Female        | EA  | 1              |
| <b>B-802</b> | Condenser/Heat Exchanger Brush – 1/4" Stainless 8-32 Female   | EA  | 1              |
| <b>B-807</b> | Condenser/Heat Exchanger Brush – 7/16" Stainless 12-24 Female | EA  | 1              |
| <b>B-816</b> | Condenser/Heat Exchanger Brush – 5/8" Stainless 12-24 Female  | EA  | 1              |

**Condenser/Heat Exchanger Brushes for Commercial Tube Cleaning**

For all commercial power tube cleaning machines. 1/4" and 3/8" dia. brushes have 8-32 female threads. 7/16"-1" brushes have 1/4-28 male threads. Use 7/16"-1" brushes for both CW and CCW rotation using a 1/4-28 NF jam locknut.



| CATALOG NO.  | DESCRIPTION   | UOM | ORDER MULTIPLE |
|--------------|---|-----|----------------|
| <b>B-210</b> | Condenser/Heat Exchanger Brush – 1/2" Brass 1/4-28 Male     | EA  | 1              |
| <b>B-216</b> | Condenser/Heat Exchanger Brush – 5/8" Brass 1/4-28 Male     | EA  | 1              |
| <b>B-304</b> | Condenser/Heat Exchanger Brush – 3/8" Nylon 8-32 Female     | EA  | 1              |
| <b>B-307</b> | Condenser/Heat Exchanger Brush – 7/16" Nylon 1/4-28 Male    | EA  | 1              |
| <b>B-316</b> | Condenser/Heat Exchanger Brush – 5/8" Nylon 1/4-28 Male     | EA  | 1              |
| <b>B-319</b> | Condenser/Heat Exchanger Brush – 11/16" Nylon 1/4-28 Male   | EA  | 1              |
| <b>B-322</b> | Condenser/Heat Exchanger Brush – 3/4" Nylon 1/4-28 Male     | EA  | 1              |
| <b>B-328</b> | Condenser/Heat Exchanger Brush – 7/8" Nylon 1/4-28 Male     | EA  | 1              |
| <b>B-333</b> | Condenser/Heat Exchanger Brush – 1" Nylon 1/4-28 Male       | EA  | 1              |
| <b>B-428</b> | Condenser/Heat Exchanger Brush – 7/8" Stainless 1/4-28 Male | EA  | 1              |
| <b>B-433</b> | Condenser/Heat Exchanger Brush – 1" Stainless 1/4-28 Male   | EA  | 1              |

**Extension Rods for Condenser Tube Brushes**

Aluminum rods can be threaded into each other to make an endless length with these extension rods.



| CATALOG NO.  | DESCRIPTION  | UOM | ORDER MULTIPLE |
|--------------|--|-----|----------------|
| <b>BE-24</b> | 24" Rods w/male thread one end, female other 12-24 thread size | EA  | 3              |
| <b>BE-36</b> | 36" Rods w/male thread one end, female other 12-24 thread size | EA  | 3              |
| <b>BE-48</b> | 48" Rods for 1/4" brushes only 8-32 thread size                | EA  | 3              |
| <b>BH-1</b>  | Handgrip – 4" long threads into rods                           | EA  | 1              |

**CHANNELLOCK® PRODUCTS**

**Tongue and Groove Pliers**

These patented design pliers have permalock fasteners and reinforcing edge. The grips are also dipped in plastic for a more comfortable hold.



| CATALOG NO. | DESCRIPTION                                | UOM | ORDER MULTIPLE |
|-------------|--|-----|----------------|
| 545-420     | 9-1/2" Tongue and Groove Pliers            | EA  | 1              |
| 545-422     | 9-1/2" Curved Jaw Tongue and Groove Pliers | EA  | 1              |
| 545-424     | 4-1/2" Tongue and Groove Pliers            | EA  | 1              |
| 545-426     | 6-1/2" Tongue and Groove Pliers            | EA  | 1              |

| CATALOG NO. | DESCRIPTION                             | UOM | ORDER MULTIPLE |
|-------------|---|-----|----------------|
| 545-430     | 10" Tongue and Groove Pliers            | EA  | 1              |
| 545-440     | 12" Tongue and Groove Pliers            | EA  | 1              |
| 545-442     | 12" Curved Jaw Tongue and Groove Pliers | EA  | 1              |
| 545-460     | 16" Tongue and Groove Pliers            | EA  | 1              |

**CLIPBOARDS**

**Clipboards and Form Holders**

Rugged aluminum construction to protect your paperwork and forms. Smooth aluminum surfaces provide excellent writing support.

| CATALOG NO. | DESCRIPTION  | UOM | ORDER MULTIPLE |
|-------------|--|-----|----------------|
| 30306       | SNAPAK Clipboard on Box w/Hinged Back – 8-1/2" x 12" | EA  | 1              |
| 30309       | REDI-RITE Clipboard on Box – 8-1/2" x 12"            | EA  | 1              |
| 30310       | CRUISER MATE 2 Compartment Clipboard – 8-1/2" x 12"  | EA  | 1              |

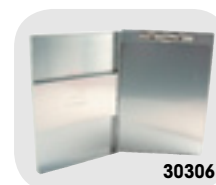

**ELECTRICAL SUPPLIES**

**Outdoor Extension Cord**

Heavy duty, round, vinyl extension cord designed for industrial use. Orange vinyl jacket protects against oil, grease, ozone, and gives added flexibility at below freezing temperatures. Vinyl plugs and connectors are molded on and won't break or pull off cord.



| CATALOG NO. | DESCRIPTION                              | UOM | ORDER MULTIPLE |
|-------------|--|-----|----------------|
| 7-ECC12100  | 100' Extension Cord, 12/3 SJTW-A, 15 AMP | EA  | 3              |
| 7-ECC1225   | 25' Extension Cord, 12/3 SJTW-A, 15 AMP  | EA  | 10             |
| 7-ECC1250   | 50' Extension Cord, 12/3 SJTW-A, 15 AMP  | EA  | 6              |
| 7-ECC16100  | 100' 13 Amp Extension Cord SJTW-A 16/3   | EA  | 6              |
| 7-ECC1625   | 25' 15 Amp Extension Cord SJTW-A 16/3    | EA  | 24             |
| 7-ECC1650   | 50' 15 Amp Extension Cord SJTW-A 16/3    | EA  | 12             |
| 7-ECC50725  | 25' 15 AMP Extension Cord SJTW-A 14/3    | EA  | 14             |
| 7-ECC50730  | 50' 15 AMP Extension Cord SJTW-A 14/3    | EA  | 10             |
| 7-ECC50735  | 100' 13 AMP Extension Cord SJTW-A 14/3   | EA  | 5              |

Type: SJTW-A U.L. Listed, meets OSHA Requirements.

**Power Blocks**

Professional design gives contractors and industrial personnel maximum flexibility in arranging portable power needs at the job site. Vinyl connectors are solid molded for high resistance to breakage and abuse.



| CATALOG NO. | DESCRIPTION  | UOM | ORDER MULTIPLE |
|-------------|--|-----|----------------|
| 7-AD010000  | Triple tap power block adapter converts single 15 AMP 125V U-ground outlet to 3 15A, 125V U-ground outlets | EA  | 10             |

**Metal Guard Trouble Lights**

Designed for rugged use by contractors and industrial. Tough plastic handles are heat and shock resistant, with switch and 15A, 125V grounding side outlet.

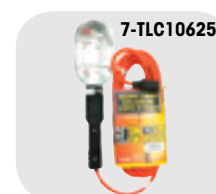

| CATALOG NO. | DESCRIPTION                   | UOM | ORDER MULTIPLE |
|-------------|-------------------------------|-----|----------------|
| 7-TLC10625  | 25' Metal Guard Trouble Light | EA  | 1              |
| 7-TLC10630  | 50' Metal Guard Trouble Light | EA  | 1              |

AWG: 16/3 TYPE: SJTW-A U.L. Listed, meets OSHA Requirements.

**Rough Service Light Bulbs**

Designed to withstand unusual shock and abuse on drop cords, mechanic trouble lights, extension cords and anywhere else severe shocks may be encountered. 4 bulbs per box for 100 watt bulbs. 4 bulbs per box for 75 watt bulbs. 120/case.

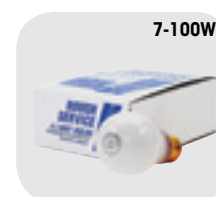

| CATALOG NO. | DESCRIPTION                               | UOM | ORDER MULTIPLE |
|-------------|---|-----|----------------|
| 7-75W       | 75 Watt Rough Service Bulb – Bulk Packed  | EA  | 120            |
| 7-100W      | 100 Watt Rough Service Bulb – Bulk Packed | EA  | 120            |

**Cable Clamp PRO**

The Cable Clamp PRO is the ultimate reusable cable management tool. Featuring a unique push button release and integrally attached carry handle serrated for easy grip. Carry handle also includes built-in lanyard hole allowing for attachment of rope, wire, or hook. Lanyard hole may be used for tethering of Cable Clamp PRO to cords, cable, and other devices. The medium size is for bundles up to 2-inch and the large size is for bundles up to 3-inch.

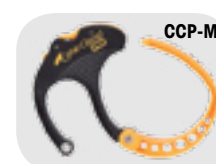

| CATALOG NO. | DESCRIPTION                                | UOM | ORDER MULTIPLE |
|-------------|--|-----|----------------|
| CCP-M       | Cable Clamp PRO Display Box with 34 Medium | EA  | 34             |
| CCP-L       | Cable Clamp PRO Display Box with 24 Large  | EA  | 25             |



**FIN TOOLS**

**Multi-Head Fin-Tool**

Conveniently straightens and cleans condenser and evaporator fins. Each nylon head slides into the master handle and tightens in place. Heads are designed to fit units with fin spacing of 4–24 fins per inch. Each head is engraved with its own size and is color coded for fast identification. Heads are angled so that when inserted in the handle, the hand is a safe distance from the sharp fins. Heads may also be reversed in the handle so that combing with an upward stroke (recommended method) may be done easily with proper leverage. The master handle rests comfortably in a man size grip, is rigid and long lasting.

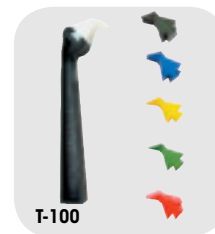

| CATALOG NO. | DESCRIPTION  | UOM | ORDER MULTIPLE |
|-------------|--|-----|----------------|
| T-1         | Handle Only – Black                                | EA  | 1              |
| T-8         | Head 8 FPI – Orange, pack of 3                     | PK  | 1              |
| T-9         | Head 9 FPI – Yellow, pack of 3                     | PK  | 1              |
| T-10        | Head 10 FPI – Natural, pack of 3                   | PK  | 1              |
| T-100       | Kit – 1 Handle and 6 Heads: 8, 9, 10, 11, 12, 14   | EA  | 12             |
| T-101       | Kit – 1 Handle and 6 Heads: 13, 15, 16, 17, 18, 20 | EA  | 12             |
| T-11        | Head 11 FPI – Blue, pack of 3                      | PK  | 1              |
| T-12        | Head 12 FPI – Green, pack of 3                     | PK  | 1              |
| T-14        | Head 14 FPI – Lt. Green, pack of 3                 | PK  | 1              |
| T-13        | Head 13 FPI – Pink, pack of 3                      | PK  | 1              |

**Fin-Tool**

Long lasting metal fin straightener. Straightens and cleans condenser and evaporator fins. One tool for all units. The heavy duty spring wire bristles automatically adjust to ALL fin spacings. An exclusive tension adjustment band is featured to allow maximum rigidity and ease of operation. Straightens most severely damaged fins.



| CATALOG NO. | DESCRIPTION                             | UOM | ORDER MULTIPLE |
|-------------|---|-----|----------------|
| T-200       | Fin-Tool                                | EA  | 1              |
| T-300       | Fin-Tool with heavy duty bicycle handle | EA  | 12             |

| CATALOG NO. | DESCRIPTION   | UOM | ORDER MULTIPLE |
|-------------|---|-----|----------------|
| T-15        | Head 15 FPI – Aqua, pack of 3                         | PK  | 1              |
| T-16        | Head 16 FPI – Brown, pack of 3                        | PK  | 1              |
| T-20        | Head 20 FPI – Purple, pack of 3                       | PK  | 1              |
| T-21        | Head 21 & 22 FPI – Rose (for Carrier unit), pack of 3 | PK  | 1              |

U.S. Patent No. 4,018,076.

**SuperComb**

Easier to grip, easier to use tool for straightening condenser and evaporator fins. Straightens 50% more fins in one stroke. Keeps hands a safe distance from fins. Easy to grip, strong, durable, heavy duty nylon. Color coded for easy identification. Sold individually or 6 per set. Sales display available.



| CATALOG NO. | DESCRIPTION  | UOM | ORDER MULTIPLE |
|-------------|--|-----|----------------|
| T-400       | Set of 6 – 1 Ea.: T-408, T-409, T-411, T-410, T-417, T-418 | EA  | 1              |
| T-408       | 8 and 10 FPI – Orange                                      | EA  | 1              |
| T-409       | 9 and 15 FPI – Yellow                                      | EA  | 1              |
| T-411       | 11 and 13 FPI – Blue                                       | EA  | 1              |
| T-412       | 12 and 14 FPI – Green                                      | EA  | 1              |
| T-417       | 16 and 17 FPI – Lime                                       | EA  | 1              |
| T-418       | 18 and 20 FPI – Red  | EA  | 1              |

**FLASHLIGHTS AND LANTERNS BY RAYOVAC®**

**Rayovac is the Industrial Product Leader!**

Rayovac is the leader in the industrial battery market and has been for years, with an estimated 50% share of the traditional industrial distribution channel. Rayovac introduced the top-selling industrial flashlight to the market, and set the quality standard by which all other industrial flashlights are measured today. Whether your customer is searching for a toolbox-tough flashlight or high-performance batteries, Rayovac offers a broad range of products to meet your needs.

**Rayovac Industrial Flashlights and Lanterns**

Rayovac Industrial Flashlights are made of toolbox tough polypropylene construction which makes them scratch resistant and they have an unbreakable lens. There is a full lifetime warranty on this USA made product.



| CATALOG NO. | DESCRIPTION                           | UOM | ORDER MULTIPLE |
|-------------|---------------------------------------|-----|----------------|
| 7-301K      | Krypton Beam Lantern with 918 Battery | EA  | 1              |

**Rayovac LED Flashlights**

This flashlight is water resistant with a machined aluminum with knurled grip and a bronze finish. There is a full lifetime warranty on this USA made product. A holster is included with this item.



| CATALOG NO.   | DESCRIPTION              | UOM | ORDER MULTIPLE |
|---------------|--------------------------|-----|----------------|
| 7-SE4W3C      | Sportsman Extra 3C Lumen | EA  | 4              |
| 7-SPHW3AAA-BX | Sportsman 3AAA 20 Lumen  | EA  | 6              |

**WORKLIGHTS BY CLIPLIGHT®**

**Clipstrip™ / Clipstrip 2™**

Clipstrip™ is a powerful pocket light with 140 lumens and includes a pivoting magnetic clip. It is available in yellow or camo with three AAA batteries included.



| CATALOG NO. | DESCRIPTION                  | UOM | ORDER MULTIPLE |
|-------------|------------------------------|-----|----------------|
| 111112      | Clipstrip™ Pocket Light      | EA  | 12             |
| 111116      | Clipstrip™ Pocket Camo Light | EA  | 12             |
| 111118      | Clipstrip 2™ Pocket Light    | EA  | 9              |

**PIVOT™**

The PIVOT™ is a light that has a 360° swivel hook with 240 lumens and magnetic base and back. Three AA batteries included.



| CATALOG NO. | DESCRIPTION               | UOM | ORDER MULTIPLE |
|-------------|---------------------------|-----|----------------|
| 111114      | PIVOT™ Pivoting Worklight | EA  | 9              |

**PIVOT™ 33**

The Pivot™ 33 is a light that has a 360° swivel hook with 160 lumens and magnetic back and pivoting base. Lights on front and top with three AA batteries included. Available in yellow or camo.



| CATALOG NO. | DESCRIPTION               | UOM | ORDER MULTIPLE |
|-------------|---------------------------|-----|----------------|
| 24-458      | PIVOT™ 33 Worklight       | EA  | 9              |
| 24-460      | PIVOT™ 33 Worklight, Camo | EA  | 9              |

**Clip-On Zoom Light**

The Clip-On Zoom Light provided 150 lumens, 90° pivoting capability coupled with the ability to zoom from broad to narrow. It includes a magnetic base and includes three AAA batteries.



| CATALOG NO. | DESCRIPTION            | UOM | ORDER MULTIPLE |
|-------------|------------------------|-----|----------------|
| 111128      | Clip-On Zoom Worklight | EA  | 8              |

**HEMImini™**

The HEMImini™ has up to 1000 lumens of power (4 hours - full power) with a 4400 mAh lithium-ion rechargeable battery. It includes a 180 degree swivel hook with an optional magnetic cover (410239).



| CATALOG NO. | DESCRIPTION                            | UOM | ORDER MULTIPLE |
|-------------|--|-----|----------------|
| 114301      | HEMImini™ Worklight                    | EA  | 1              |
| 410239      | Magnetic Cover for HEMImini™ Worklight | EA  | 1              |

**Clipstrip™ Aqua**

Clipstrip™ Aqua is a waterproof light with 180 lumens and includes a magnetic clip and floats. It is available in yellow and comes with a rechargeable 2200 mAh lithium-ion battery. Sold individually.



| CATALOG NO. | DESCRIPTION           | UOM | ORDER MULTIPLE |
|-------------|-----------------------|-----|----------------|
| 111113      | Clipstrip™ Aqua Light | EA  | 1              |

**PIVOT™ mini**

The PIVOT™ mini is a light that has a 360° swivel hook with 120 lumens and magnetic back and base. Lights on front and top with three AAA batteries included. Available in yellow or camo.



| CATALOG NO. | DESCRIPTION                          | UOM | ORDER MULTIPLE |
|-------------|--------------------------------------|-----|----------------|
| 111115      | PIVOT™ mini Pivoting Worklight       | EA  | 12             |
| 111117      | PIVOT™ mini Pivoting Worklight, Camo | EA  | 12             |

**PIVOT™ Tough-Light**

The PIVOT™ Tough Light has 150 lumens with a hanging hook and magnetic base. It also has 180 degree pivoting capability with three AAA batteries included.

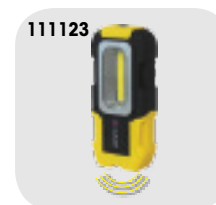

| CATALOG NO. | DESCRIPTION                  | UOM | ORDER MULTIPLE |
|-------------|------------------------------|-----|----------------|
| 111123      | PIVOT™ Tough-Light Worklight | EA  | 8              |

**Cliplight Extends**

The Cliplight Extends has 120 lumens at the top and 140 lumens in the front with a pivoting head. The light comes with a telescopic system and magnetic base. Four AAA batteries included.



| CATALOG NO. | DESCRIPTION                 | UOM | ORDER MULTIPLE |
|-------------|-----------------------------|-----|----------------|
| 111130      | Cliplight Extends Worklight | EA  | 8              |

**HEMIPLUS™ 2**

The HEMIPLUS™ 2 has up to 1200 lumens of power (4 hours - full power) with a 4400 mAh lithium-ion rechargeable battery. It includes a metal hook and removable magnetic cover.



| CATALOG NO. | DESCRIPTION           | UOM | ORDER MULTIPLE |
|-------------|-----------------------|-----|----------------|
| 114302      | HEMIPLUS™ 2 Worklight | EA  | 1              |

**WORKLIGHTS BY CLIPLIGHT® cont'd**

**Spotlight**

The Spotlight is a cordless work light solution with up to 1200 lumens of power (3 hours - full power) with a 4000 mAh lithium-ion rechargeable battery. It includes two adjustable joints on magnetic stand for different angles. It has three power modes including a dimmer.



| CATALOG NO. | DESCRIPTION                  | UOM | ORDER MULTIPLE |
|-------------|------------------------------|-----|----------------|
| 111121      | Spotlight Cordless Worklight | EA  | 1              |

**GAUGES**

**Manifold Gauge**

DiversiTech's MG-1 Manifold Gauge provides the technician with a precision diagnostic and monitoring analog gauge set complete with hoses.

The Manifold Gauge and Hose Set includes:

- 2 valve brass manifold
- 5' long high pressure hose set
- For use with the following refrigerants:
  - R-410A
  - R-22
  - R-407C
- Detailed gauge readings in PSI °F

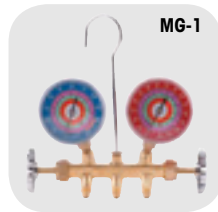

| CATALOG NO. | DESCRIPTION                 | UOM | ORDER MULTIPLE |
|-------------|-----------------------------|-----|----------------|
| MG-1        | Manifold Gauge and Hose Set | EA  | 1              |
| MG-RGB      | Replacement Gauge – blue    | EA  | 1              |
| MG-RGR      | Replacement Gauge – red     | EA  | 1              |

**MANOMETERS, PRESSURE**

**Hydrogauge Manometer**

Economical Pressure measurements.

- Replaces ordinary U-tube manometers
  - Measures gas pressure easily and efficiently
  - Direct reading, no plus or minus readings to add together as in old fashioned U-tubes
  - Fills like a glass of water, no more air bubbles
  - Strong magnet for mounting
  - Heavy-duty construction
  - Made of industrial grade, flexible PVC plastic
  - Lightweight; Easy to use
  - 6-HG15 water column height: 15"
  - Plastic: 30" to 36" of industrial grade flexible plastic
  - Hose fitting: All brass
- Includes: Mounting magnet.

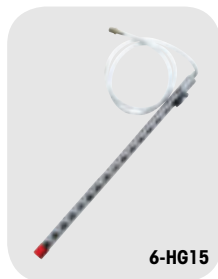

| CATALOG NO. | DESCRIPTION          | UOM | ORDER MULTIPLE |
|-------------|----------------------|-----|----------------|
| 6-HG15      | Hydrogauge Manometer | EA  | 1              |

**Gas Pressure Test Kit**

Rugged, Heavy Duty Field Use.

- Measure Natural gas (methane) or LP gas pressure across appliance manifolds.
  - Test gas stoves, furnaces, dryers and other gas appliances. Can also be used for other non-corrosive gases.
  - Large 2" sensitive diaphragm gauge is calibrated in inches of water column, also shows ounces per square inch
  - Magnified lens
  - Easier to use than a manometer
  - Range: 0 to 35 inches of water column (in. H<sub>2</sub>O) 0 to 20 ounces per square inch (oz./in<sup>2</sup>)
- Includes: 2" sensitive diaphragm gauge; 3' of rubber tubing; brass fitting for quick connection to the appliance manifold 3/8" NPT; molded hard case.



| CATALOG NO. | DESCRIPTION           | UOM | ORDER MULTIPLE |
|-------------|-----------------------|-----|----------------|
| 6-GPK035    | Gas Pressure Test Kit | EA  | 1              |

MEASURING TAPES, STAPLES AND STAPLE GUNS

Power Measuring Tapes

Rust resistant yellow lacquered blade with easy to read inch/foot markings (English). Neon case has belt clips and finger-tip blade lock.

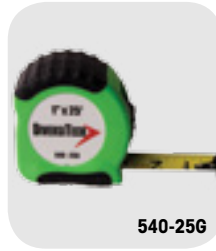

540-25G

| CATALOG NO. | DESCRIPTION                      | UOM | ORDER MULTIPLE |
|-------------|----------------------------------|-----|----------------|
| 540-25G     | Power Tape – Neon Green 1" x 25' | EA  | 6              |

T-50 Series Staples and Staple Guns

The #1 selling staple gun in the world! Used extensively by building contractors, home do-it-yourselfers and specialty trade applications for tacking insulation, ceiling tile, window screening, cornerite, and 1001 other jobs ranging from light to heavy duty work. The T-50 Outward Clinch Staple Gun is ideal for fiberglass ductwork.

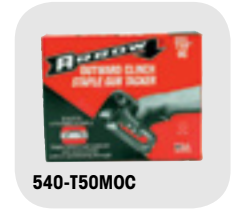

540-T50MOC



| CATALOG NO. | DESCRIPTION                                   | UOM | ORDER MULTIPLE |
|-------------|---|-----|----------------|
| 540-506     | 3/8" Leg Staples for T50 Staple Guns (1,250)  | EA  | 4              |
| 540-508     | 1/2" Leg Staples for T50 Staple Guns (1,250)  | EA  | 4              |
| 540-509     | 9/16" Leg Staples for T50 Staple Guns (1,250) | EA  | 4              |
| 540-T50M    | T50M Heavy Duty Staple Gun Tacker             | EA  | 1              |
| 540-T50MOC  | T50MOC Outward Clinch Staple Gun              | EA  | 1              |

METERS, DETECTORS, ALARMS

Digital UL Listed Multimeter

Economical Electrical Readings.

- 7 Functions – 20 Ranges
- High Impact Thermoplastic Case
- Simple Operation
- Small Pocket Size
- Safety Recessed Test Lead Connections
- Ranges and Accuracy
- AC Voltage: 0-200/600 Vac, ±2.5%
- DC Voltage: 0-200mV/2/20/200/600 Vdc, ±2%
- DCCurrent: 0-2000uA/20m/200mA/10Adc, ±1%
- Resistance: 0-200/2k/20k/200k/2M/20MΩ, ±1.5%

Includes: Battery Test; Diode Test; Continuity Buzzer.

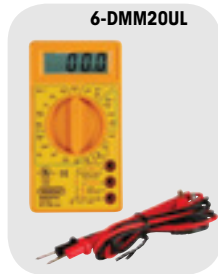

6-DMM20UL

| CATALOG NO. | DESCRIPTION                  | UOM | ORDER MULTIPLE |
|-------------|------------------------------|-----|----------------|
| 6-DMM20UL   | Digital UL Listed Multimeter | EA  | 1              |

MISCELLANEOUS TOOLS

Compressor TOTE

Makes light work of a heavy job. Powder coated, strong steel construction. Recommended for use with all compressors up to 5 tons. Compatible with high efficiency compressors. Pick up a compressor up a ladder. Now with black protective finish.



ACT-6

| CATALOG NO. | DESCRIPTION     | UOM | ORDER MULTIPLE |
|-------------|-----------------|-----|----------------|
| ACT-6       | Compressor Tote | EA  | 6              |

Mechanical Screw Starter

A simple, easy way to end fumbling with hard to position screws. Just insert the screw on the prongs of the screw starter, and a simple twist will lock the screw ready for trouble free starting. Tool automatically releases and resets. Use with ferrous or non-ferrous screws. Nylon handle.



S-3

| CATALOG NO. | DESCRIPTION                                | UOM | ORDER MULTIPLE |
|-------------|--|-----|----------------|
| S-3         | One End Slotted, Phillips on Other, 9-1/4" | EA  | 1              |



MISCELLANEOUS TOOLS cont'd

### Expando Adjustable Condenser Tube Cleaner

Removes mineral scale and sludge from inside water-cooled condenser tubes fast! Saves time-consuming brushing or flushing. Attaches to a threaded rod which fits into an Expando handle or your electric drill. With a reaming action, the stainless steel blades scrape inside the tube, providing an unrestricted flow. Virtually clogproof, it expands or reduces in diameter to fit scale deposits—not just the tube. Use EC-810 couplings for connecting additional rods. Thread size 1/4" x 28.



E-5

| CATALOG NO. | DESCRIPTION                                       | UOM | ORDER MULTIPLE |
|-------------|---|-----|----------------|
| E-10        | Condenser Tube Cleaner – 5/8" to 3/4" I.D. Tubes  | EA  | 1              |
| E-5         | Condenser Tube Cleaner – 5/16" to 3/8" I.D. Tubes | EA  | 1              |
| E-6         | Condenser Tube Cleaner – 3/8" to 1/2" I.D. Tubes  | EA  | 1              |
| E-8         | Condenser Tube Cleaner – 1/2" to 5/8" I.D. Tubes  | EA  | 1              |
| EB-10       | Blades for E-10                                   | EA  | 1              |
| EB-8        | Blades for E-8                                    | EA  | 1              |
| EC-56       | Couplings for E-5 and E-6                         | EA  | 3              |
| EC-810      | Couplings for E-8 and E-10                        | EA  | 3              |

### Telescopic Inspection Mirror

Fast, accurate visual inspection of hidden areas with an almost limitless number of positions. Double ball joint links swivel mirrors for viewing to 360°. Precision engineered links are made from tempered spring steel to withstand the stresses of constant repositioning. Moves freely, holds desired position.



M-1

| CATALOG NO. | DESCRIPTION   | UOM | ORDER MULTIPLE |
|-------------|---|-----|----------------|
| M-1         | Mirror – 1-1/4" Circular – extends 6-1/4" to 18-1/4"              | EA  | 1              |
| M-1R        | Replacement Head for M-1  | EA  | 1              |
| M-2         | Mirror – 2-1/4" Circular – extends 10" to 14"                     | EA  | 1              |
| M-2R        | Replacement Head for M-2  | EA  | 1              |
| M-3         | Mirror – 2-1/8" x 3-1/2" Rectangular – extends 11-1/4" to 15-1/4" | EA  | 1              |
| M-3R        | Replacement Head for M-3  | EA  | 1              |
| M-4         | Mirror – 7/8" Circular – extends 6-1/2"                           | EA  | 1              |
| M-5         | Mirror – 1" x 2" Oval – extends 8-1/2"                            | EA  | 1              |

### 4-Piece Hook and Pick Set

For separating wires, removing small fuses, "O" rings, retrieving washers and loose parts too small to pick up with your fingers. Bright-dipped, anodized hex-shaped aluminum handles with powerful magnet on end. Handy screw-in hook, pick, point and scribe. High carbon polished needle steel. All in a compact zip-lock vinyl pouch that fits in your shirt pocket! Set includes four screw-in tips plus handle.

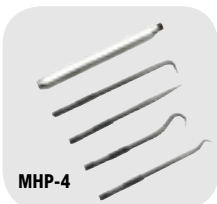

MHP-4

| CATALOG NO. | DESCRIPTION               | UOM | ORDER MULTIPLE |
|-------------|---------------------------|-----|----------------|
| MHP-4       | 4-Piece Hook and Pick Set | EA  | 1              |

MONITORS

### 007 Control Checker

A lifetime tool for monitoring and checking safety controls and operating controls. One unit for all voltages 24-460 VAC or DC without switching dials or meters. Compact, 4 oz, reliable. Saves troubleshooting. For normally closed controls, 007 connects in parallel with safety control. When the safety control opens in response to a problem in the system, 007 red LED turns on and remains on until reset manually. With intermittent problem, the LED remains on indicating the control is open. For operating controls, 007 verifies the status of all types indicating if there is power to the holding coil, the NC contact is open or closed, the thermostat contacts are open or closed, there is power to the contactor or starting holding coil, the overloads are open or closed, or there is a bad connection either on control or power side. NOTE: May use with lockout relays. Features battery check and reset switch. Includes 9-volt battery. 007 may be used over and over.



TC-007

| CATALOG NO. | DESCRIPTION         | UOM | ORDER MULTIPLE |
|-------------|---------------------|-----|----------------|
| TC-007      | 007 Control Checker | EA  | 1              |

U.S. Pat. No. 4,092,625.

### Tattle-Tale Control Monitor

Identifies open controls in seconds. A single use monitoring device for determining which safety control has opened in response to a malfunction. Saves wasted hours tracing a safety control shutdown, even if intermittent. A quick, inexpensive way to visually spot where the problem is. Simply install in parallel with each safety control. When a control opens, the red indicator flag pops up. You will know immediately which area of the system is experiencing problems. Disposable, safe, simple to use, and pocket sized. Monitors safety controls, fuses, overload relays, motor protectors, freeze controls, limit controls, safety switches, fusible links, or steam control. CAUTION: Not to be used with lockout relays, use TC-007.



TT-24

| CATALOG NO. | DESCRIPTION  | UOM | ORDER MULTIPLE |
|-------------|--|-----|----------------|
| TT-120      | Tattle-Tale Control Monitor – 120 Volt AC or DC, pack of 3 | PK  | 1              |
| TT-24       | Tattle-Tale Control Monitor – 24 Volt AC or DC, pack of 3  | PK  | 1              |
| TT-240      | Tattle-Tale Control Monitor – 240 Volt AC or DC, pack of 3 | PK  | 1              |

Tolerance on all voltages shown is ± 20%. U.S. Pat. No. 4,250,480.

**NUT SETTERS**

**Nut Setter – Power**

The Magnetic hex driver nut setter can be used with any 1/4in. power bit and are individually packed.



| CATALOG NO.        | DESCRIPTION                              | UOM | ORDER MULTIPLE |
|--------------------|--|-----|----------------|
| <b>5-MSH1/4MC</b>  | Hex Drive – 1/4", 1-3/4" long, 1/4" nut  | EA  | 30             |
| <b>5-MSH5/16MC</b> | Hex Drive – 1/4", 1-3/4" long, 5/16" nut | EA  | 30             |

**Magnetic Nut Setters – Bulk**

Magnet hex driver setter to be used with any 1/4in. power bit and are package in bulk.



| CATALOG NO.    | DESCRIPTION                              | UOM | ORDER MULTIPLE |
|----------------|--|-----|----------------|
| <b>540-400</b> | Magnetic Nut Setters – 1/4", pack of 30  | EA  | 1              |
| <b>540-500</b> | Magnetic Nut Setters – 5/16", pack of 30 | EA  | 1              |

**REFRACTOMETERS**

**Refractometer**

The Refractometer can measure the freezing point of coolants, glycol and the Charge Condition of Batteries



| CATALOG NO.     | DESCRIPTION   | UOM | ORDER MULTIPLE |
|-----------------|---------------|-----|----------------|
| <b>6-REF401</b> | Refractometer | EA  | 1              |

**RETRIEVING TOOL**

**Reach-It**

Our Reach-It is made of durable chrome plated brass and retracts to 5in. long. A match can quickly be inserted with the Reach-It.



| CATALOG NO. | DESCRIPTION                   | UOM | ORDER MULTIPLE |
|-------------|-------------------------------|-----|----------------|
| <b>R-1</b>  | Reach-It – extends to 26-3/4" | EA  | 12             |

**SAWS AND SAW BLADES**

**Deluxe Hi-Tension Hacksaw**

Hackframe featuring handle and end pieces made of die cast aluminum. Lightweight yet rigid and highly tensioned (up to 25,000 psi) for cleaner, surer cut. Permanent blade pins feature versatile angling (up to 55°) for flush cutting. Blade can be inserted in handle to be used as compass saw. Frame will fit most standard tool boxes.



| CATALOG NO.          | DESCRIPTION                                    | UOM | ORDER MULTIPLE |
|----------------------|--|-----|----------------|
| <b>540-278BM0024</b> | Replacement Blades for Hacksaw Frame 12" x 24T | EA  | 10             |
| <b>540-278HX0002</b> | Hacksaw Frame with Blade                       | EA  | 1              |

**Bi-Metal Reciprocating Saw Blades**

Premium high speed steel with a flexible alloy back. Bi-metal blades fit all reciprocating saws with 1/2" shank.

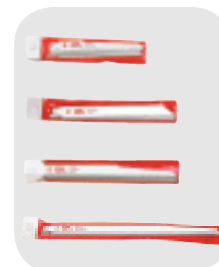

| CATALOG NO.         | DESCRIPTION  | UOM | ORDER MULTIPLE |
|---------------------|--|-----|----------------|
| <b>540-RBCCRF</b>   | Cast Iron-Ceramic Tile Carbide Grit 8" Long        | EA  | 1              |
| <b>540-RB125W</b>   | 12" x 6T Wood and Nail 3/4" x 12" x .050           | EA  | 5              |
| <b>540-RB414M</b>   | 4" x 14T Short Metal Cutting 3/4" x 4" x .035      | EA  | 5              |
| <b>540-RB418M</b>   | 4" x 18T Short Metal Cutting 5/8" x 4" x .035      | EA  | 5              |
| <b>540-RB424M</b>   | 4" x 24T Thin Short Metal Cutting 5/8" x 4" x .035 | EA  | 5              |
| <b>540-RB610HDM</b> | 6" x 10T HD Metal Cutting 3/4" x 6" x .035         | EA  | 5              |
| <b>540-RB614HDM</b> | 6" x 14T HD Metal Cutting 3/4" x 6" x .035         | EA  | 5              |
| <b>540-RB618HDM</b> | 6" x 18T HD Metal Cutting 3/4" x 6" x .035         | EA  | 5              |
| <b>540-RB624HDM</b> | 6" x 24T HD Metal Cutting 3/4" x 6" x .035         | EA  | 5              |
| <b>540-RB636DW</b>  | Drywall Cutting with V Head 5/8" x 6" x .035       | EA  | 5              |
| <b>540-RB636W</b>   | 6" x 6T Wood and Nail Slope 3/4" x 6" x .050       | EA  | 5              |
| <b>540-RB656WS</b>  | 6" x 6T Wood and Nail Scroll 3/4" x 6" x .050      | EA  | 5              |
| <b>540-RB810HDM</b> | 8" x 10T HD Metal Cutting 3/4" x 8" x .035         | EA  | 5              |
| <b>540-RB814HDM</b> | 8" x 14T HD Metal Cutting 3/4" x 8" x .035         | EA  | 5              |
| <b>540-RB956W</b>   | 9" x 6T Wood and Nail 3/4" x 9" x .050             | EA  | 5              |

**SCREWDRIVERS, DRIVER SETS**

**Pocket 4-in-1 Mini Screwdriver**

This screwdriver set is ideal for technicians, hobbyists, and do it yourselfers. There are 2 double-ended vanadium blades. You can change blades instantly and the blades are held in the carrier handled. The dimensions are 1/16in. and 1/8in. slotted tips and #1 and #00 cross point. The Mini Screwdriver comes in with a convenient pocket clip and capped ends.

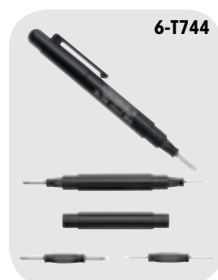

| CATALOG NO.   | DESCRIPTION   | UOM | ORDER MULTIPLE |
|---------------|---|-----|----------------|
| <b>6-T744</b> | Pocket 4-in-1 Mini Screwdriver – Length: 5-1/8" (130mm) | EA  | 1              |

**Combination Screwdrivers**

Multiple bits in one handy screwdriver. No need for a toolbox for those quick jobs. Lifetime guarantee.



| CATALOG NO. | DESCRIPTION   | UOM | ORDER MULTIPLE |
|-------------|---|-----|----------------|
| <b>5-41</b> | 4-in-1 with #1 and #2 Phillips, 3/16 and 5/16 Slotted                                 | EA  | 12             |
| <b>5-61</b> | 6-in-1 with #1 and #2 Phillips, 3/16 and 5/16 Slotted 1/4 Nut Driver, 5/16 Nut Driver | EA  | 12             |

**SNIPS, NOTCHERS, CRIMPERS, SEAMERS**

**Aviation Snips**

Moly alloy tool steel blade is hot drop-forged and scientifically heat-treated to provide a strong, longer lasting cutting edge. Durable serrated blades are designed to grip the metal for cutting ease. The patent pending spring on these snips is guaranteed to last for the life of the tool. Will cut 18 gauge cold-rolled steel.



| CATALOG NO. | DESCRIPTION   | UOM | ORDER MULTIPLE |
|-------------|---|-----|----------------|
| 540-6716B   | Aviation Snip – Bulldog Notching Snip – Blue Handle | EA  | 6              |
| 540-6716L   | Aviation Snip – Cuts Left – Red Handle              | EA  | 6              |
| 540-6716R   | Aviation Snip – Cuts Right – Green Handle           | EA  | 6              |
| 540-6716S   | Aviation Snip – Cuts Straight – Yellow Handle       | EA  | 6              |

**HVAC Tools**

Hot drop-forged carbon steel blades. Compound leverage action handles. Heavy duty plastic grips.



| CATALOG NO. | DESCRIPTION                           | UOM | ORDER MULTIPLE |
|-------------|---------------------------------------|-----|----------------|
| 540-FCTMC5  | 8" Crimper – 22 Ga. Crimping Capacity | EA  | 1              |
| 540-FCTMN1  | 8" Notcher – 31° Cutting Angle        | EA  | 1              |
| 540-FCTMS1  | 3" Straight Seamer – 22 Ga. Capacity  | EA  | 1              |
| 540-FCTMS2  | 3" Offset Seamer – 22 Ga. Capacity    | EA  | 1              |

**Offset Snips**

The same high quality construction as the Aviation Snips with an additional advantage – the Offset Snips allow your hand to stay above metal for cutting ease and comfort.



| CATALOG NO. | DESCRIPTION                             | UOM | ORDER MULTIPLE |
|-------------|---|-----|----------------|
| 540-6510L   | Offset Snip – Cuts Left – Red Handle    | EA  | 6              |
| 540-6510R   | Offset Snip – Cuts Right – Green Handle | EA  | 6              |

**Upright Snips**

This snip significantly improves sheet metal cutting. The ergonomic design allows for easier cutting in tight places, improved safety by elevating hands above metal working surfaces, and increases wrist range motion.



| CATALOG NO. | DESCRIPTION                        | UOM | ORDER MULTIPLE |
|-------------|------------------------------------|-----|----------------|
| 540-6900L   | Upright Snips – Left-handed Model  | EA  | 6              |
| 540-6900R   | Upright Snips – Right-handed Model | EA  | 6              |

**STRAPS, TRUCK ROPE**

**Truck Rope**

All-purpose high strength polypropylene truck rope is C.H.P. approved.



| CATALOG NO. | DESCRIPTION                      | UOM | ORDER MULTIPLE |
|-------------|----------------------------------|-----|----------------|
| 25001       | Truck Rope – 3/8" x 50'          | EA  | 1              |
| CR070       | Truck Rope – 3/8" x 50' (Yellow) | EA  | 1              |

**Lashing Strap**

Quickly lashes and secures refrigerators, air conditioners, washers, driers, etc. Strong nylon webbing rated at 3000 lbs. and end hooks at 1200 lbs. tensile strength. Hand loop for easy tightening. Steel cam lever buckle is easy to adjust and releases quickly. Secures a maximum load of 1000 pounds. 12' long.



| CATALOG NO. | DESCRIPTION          | UOM | ORDER MULTIPLE |
|-------------|----------------------|-----|----------------|
| HS-144      | Lashing Strap – 144" | EA  | 6              |



**STRAPS, TRUCK ROPE cont'd**

**Ratchet Strap**

Easy ratcheting permits tie-down of appliances securely. An innovative latch and a fast release cam reduces socket wear. Cadmium-plated steel buckle has a positive lock that eliminates release due to vibration. When closed, the handle locks the latch into the sprocket to prevent inadvertent release. 16' nylon webbing rated at 3000 PSI tensile. Vinyl coated end hooks rated at 1200 PSI tensile.



| CATALOG NO.   | DESCRIPTION         | UOM | ORDER MULTIPLE |
|---------------|---------------------|-----|----------------|
| <b>HS-192</b> | Ratchet Strap – 16' | EA  | 3              |

**Hanging Strap**

Strong, versatile, easy way to secure loose gear safely. Tie down ladders, tubing, cylinders or almost anything in seconds. Cannot snap back. Strong, durable 1" polypropylene webbing. Reinforced grommet lets you hang it up, tie it up, hook it up or attach it permanently. Spring loaded adjustable buckle. Easy to get firm tension with no slipping. Make an endless length by connecting 2 or more together.



| CATALOG NO.    | DESCRIPTION  | UOM | ORDER MULTIPLE |
|----------------|--|-----|----------------|
| <b>HS-30</b>   | Hanging Strap – 31"                                | EA  | 24             |
| <b>HS-30-2</b> | Hanging Strap – 31", 2 Straps per Card, pack of 12 | PK  | 1              |
| <b>HS-60</b>   | Hanging Strap – 60"                                | EA  | 24             |
| <b>HS-60-2</b> | Hanging Strap – 60", 2 Straps per Card, pack of 12 | PK  | 1              |

**Canopy Strap**

Canopy ties are ideal for stretching or holding tarps and canopies tight. Easy to use and install and won't damage tarps or canopies. Convenient ball design for easy installation and securing. 10" length.



| CATALOG NO.    | DESCRIPTION                      | UOM | ORDER MULTIPLE |
|----------------|----------------------------------|-----|----------------|
| <b>RS-TS10</b> | Canopy Straps, 10 in, pack of 12 | PK  | 1              |

**TEST LEADS**

**Test Leads**

Alligator clips are covered by pure vinyl boots for flexibility at any temperature without cracking.



| CATALOG NO.  | DESCRIPTION                                  | UOM | ORDER MULTIPLE |
|--------------|--|-----|----------------|
| <b>ACK4</b>  | 2 Red and 2 Black Boots w/4 Alligator Clips  | EA  | 1              |
| <b>FTL3</b>  | Pair, Red and Black – 36"                    | EA  | 1              |
| <b>FTL3D</b> | Pair, Red and Black – Super Heavy Duty – 36" | EA  | 1              |

**Rubber Tie Down Strap**

Can stretch to double its length. Quickly ties down ladders, tubing, cylinders or almost anything. Extra heavy steel "S" hooks on each end. Resists cracking and deterioration.



| CATALOG NO.  | DESCRIPTION                 | UOM | ORDER MULTIPLE |
|--------------|-----------------------------|-----|----------------|
| <b>RS-9</b>  | Rubber Tie Down Strap – 10" | EA  | 10             |
| <b>RS-15</b> | Rubber Tie Down Strap – 15" | EA  | 10             |
| <b>RS-20</b> | Rubber Tie Down Strap – 20" | EA  | 10             |
| <b>RS-31</b> | Rubber Tie Down Strap – 31" | EA  | 10             |
| <b>RS-41</b> | Rubber Tie Down Strap – 41" | EA  | 10             |

**Carabiners**

Carabiners come in a 2 piece package and are made of 8 mm anodized aluminum. Great for attaching ropes and clipping to tool belts. For indoor or outdoor use – work or leisure. Various colors.

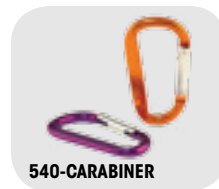

| CATALOG NO.          | DESCRIPTION               | UOM | ORDER MULTIPLE |
|----------------------|---------------------------|-----|----------------|
| <b>540-CARABINER</b> | Carabiner Clip, pack of 2 | PK  | 1              |

**Multi Color Test Leads**

Easy to use multi-colored test leads. 5 colors (white, red, black, yellow, green) with 2 connections each for easy testing on the job. Wire is 18 gauge, 18" long.



| CATALOG NO.  | DESCRIPTION            | UOM | ORDER MULTIPLE |
|--------------|------------------------|-----|----------------|
| <b>CT800</b> | Multi Color Test Leads | EA  | 1              |

TEST LEADS cont'd

**Magjumper**

Magjumper from DiversiTech is a magnetic jumper for low voltage troubleshooting. It features a 20" length with magnetic tips that won't pop off like alligator clips sometimes can. It stays flexible even in cold weather and is perfect for recessed terminals. Magjumper is ideal for use on control boards, zone panels, thermostats, hydronics and automation controllers.



| CATALOG NO.  | DESCRIPTION            | UOM | ORDER MULTIPLE |
|--------------|------------------------|-----|----------------|
| <b>MAG-1</b> | Magjumper Terminal Kit | EA  | 1              |

TESTERS

**Test Cord (Female)**

Heavy duty red and black boots are on this cord. The cord has large clips, 3 wires, and is 24in. With this cord, you can get power in remote areas without an 110V outlet. The voltage is 3 to 20 V and has 125 AMPs. The wire gauge is 16 and the weight is .36 lb.



| CATALOG NO.     | DESCRIPTION        | UOM | ORDER MULTIPLE |
|-----------------|--------------------|-----|----------------|
| <b>6-CT700F</b> | Test Cord (Female) | EA  | 1              |

**LED Screwdriver Continuity Tester**

A Screwdriver/Tester you can see! The tester is a self-test with AC Voltage test of 70 to 250 BAC. You can also check continuity and fuses. There is also a polarity check and the product has bright red LED. When the tip of the tester is in direct contact with the live (HOT) part of the AC voltage, the red LED lights up for an easier read and better accuracy.



| CATALOG NO.       | DESCRIPTION                           | UOM | ORDER MULTIPLE |
|-------------------|---------------------------------------|-----|----------------|
| <b>6-ST600LED</b> | Red LED Screwdriver Continuity Tester | EA  | 1              |

**Leak Test Gauge**

This Gas gauge test is ideal for teasing all new installations of or leaks and passing inspection code. The special sensitive diaphragm gauges for more accurate low pressure readings.



| CATALOG NO.     | DESCRIPTION                               | UOM | ORDER MULTIPLE |
|-----------------|---|-----|----------------|
| <b>TG-05</b>    | Leak Test Gauge – 3/4" FPT., 15 psi       | EA  | 1              |
| <b>TG-30-12</b> | Leak Test Gauge – 1/2" FPT. Conn., 30 psi | EA  | 1              |
| <b>TG-30</b>    | Leak Test Gauge – 3/4" FPT. Conn., 30 psi | EA  | 1              |
| <b>TG-30-1</b>  | Leak Test Gauge – 1" FPT. Conn., 30 psi   | EA  | 1              |

**THERMOMETERS/PROBES**

**Digital Thermometer**

Temperature range from -40° F to 230° F. Packaged on attractive display card.



| CATALOG NO. | DESCRIPTION         | UOM | ORDER MULTIPLE |
|-------------|---------------------|-----|----------------|
| 541-300     | Digital Thermometer | EA  | 1              |

**Deluxe Digital Pocket Thermometer**

Deluxe Digital Pocket Thermometers are water and drop resistant and have a rugged construction. There is an auto power off and an F/C Switch. The probe is 2.5in. and the range is from -40 degrees F to 300 degrees F or -40 degrees C to 150 degrees C. This thermometer comes with a protective cover with clip.



| CATALOG NO. | DESCRIPTION                       | UOM | ORDER MULTIPLE |
|-------------|-----------------------------------|-----|----------------|
| 6-HDT303K   | Deluxe Digital Pocket Thermometer | EA  | 1              |

**Refrigerator/Freezer Analog Thermometer**

This analog thermometer is stainless steel and can be used either hanging or free standing. The easy to read round dial is in F only. There are temperature indicators with a range -20 to 80 F (-29 to 27 C)



| CATALOG NO. | DESCRIPTION                             | UOM | ORDER MULTIPLE |
|-------------|---|-----|----------------|
| 6-FT80R     | Refrigerator/Freezer Analog Thermometer | EA  | 1              |

**Pocket Thermometers**

1" diameter dials with 5" stems (.145 dia.). Adjustable for recalibration. All stainless steel construction. Polycarbonate crystal. 1% accuracy full scale. Plastic pocket sheath included.

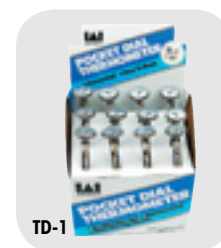

| CATALOG NO. | DESCRIPTION                         | UOM | ORDER MULTIPLE |
|-------------|-------------------------------------|-----|----------------|
| TD-1        | Pocket Thermometer - 0°F to 220°F   | EA  | 12             |
| TD-2        | Pocket Thermometer - -40°F to 160°F | EA  | 12             |

**Horizontal Refrigerator/Freezer Analog Thermometer**

With this analog thermometer, you can use it either hanging or free standing. The easy to ready display can be seen with a horizontal reading. Both F and C scales are reflected on the thermometer and the range is -40 to 80 degrees F (-40 to 27C).



| CATALOG NO. | DESCRIPTION  | UOM | ORDER MULTIPLE |
|-------------|--|-----|----------------|
| 6-FT80H     | Horizontal Refrigerator/Freezer Analog Thermometer | EA  | 1              |

**Analog Pocket Thermometer with Magnifying Lens**

- Range 6-320: -40° to 160°F
- Range 6-321: -0° to 220°F
- Rugged stainless steel probe

Includes: Protective sheath with pocket clip.

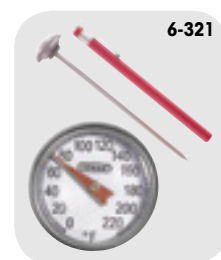

| CATALOG NO. | DESCRIPTION                                   | UOM | ORDER MULTIPLE |
|-------------|---|-----|----------------|
| 6-321       | Analog Pocket Thermometer: Range -0° to 220°F | EA  | 1              |

**TUBE WORKING TOOLS**

**Kut-All Plastic Tube and Hose Cutter**

Tough, durable nylon. Blade closes into its own handle for safe handling. Replaceable high carbon, teflon coated steel blades. Ideal for cutting up to 1-1/8" I.D. plastic tubing, reinforced plastic tubing, rigid plastic pipe, and rubber hose.



| CATALOG NO. | DESCRIPTION                          | UOM | ORDER MULTIPLE |
|-------------|--------------------------------------|-----|----------------|
| PK-2        | Kut-All Plastic Tube and Hose Cutter | EA  | 1              |

**Little Helper™ – All Purpose Cutter**

Cuts up to 1-1/4" polyethylene, thinwall PVC, ABS, rubber hose, NM conduit and clear vinyl tubing. Reversible stainless steel blade, like two blades in one. Sturdy all metal construction.



| CATALOG NO. | DESCRIPTION             | UOM | ORDER MULTIPLE |
|-------------|-------------------------|-----|----------------|
| 548-001     | Little Helper™ – Carded | EA  | 1              |

**TUBE WORKING TOOLS** cont'd

**One-Handed PVC/Hose Cutter**

The ratchet system holds the blade in place while you adjust your grip to increase the pressure. The high carbon steel blade maintains sharpness and resists chipping. These cutters can be used for cutting PVC, CPVC, Polyethylene, PEX, and ABS tubing. The cutters have a quick-blade reset and can be used as a one handed operation. With the handle locking strap for safe storage, the easy replacing blade feature, and the ergonomically designed handle, these cutters are a perfect addition to any tool box.



| CATALOG NO.    | DESCRIPTION   | UOM | ORDER MULTIPLE |
|----------------|---|-----|----------------|
| <b>6-T1191</b> | Capacity: 1/8" to 1-5/8";<br>Length: 8-1/4" (210mm) | EA  | 1              |

**Swivel Head Deburring Tool**

This Swivel head Deburring Tool has the professional quality and the performance of a higher price deburring tool without the price tag. This product has two interchangeable blades.



| CATALOG NO.   | DESCRIPTION                   | UOM | ORDER MULTIPLE |
|---------------|-------------------------------|-----|----------------|
| <b>6-T482</b> | Handle length: 5-1/8" (130mm) | EA  | 1              |

**Big Helper™ PVC Pipe Cutter**

Ratchet style pipe cutters cut up to 2-1/2 in. Sch. 40 PVC Pipe. Ratchet action requires minimal pressure to easily cut through PVC pipe. Molybdenum stainless steel blade won't rust or break and lasts twice as long as most competitor's. The Mega-Cutter is now available – the strongest pipe cutter on the market today!



| CATALOG NO.    | DESCRIPTION                     | UOM | ORDER MULTIPLE |
|----------------|---------------------------------|-----|----------------|
| <b>548-003</b> | 1 in. O.D. Cutting Capacity     | EA  | 1              |
| <b>548-005</b> | 1-1/4 in. O.D. Cutting Capacity | EA  | 1              |
| <b>548-007</b> | 2-1/2 in. O.D. Mega-Cutter      | EA  | 1              |
| <b>548-009</b> | 1-5/8 in. O.D. Cutting Capacity | EA  | 1              |

**WELDING TORCHES, SUPPLIES**

**Heat Resistant Cloth**

This flame barrier drop cloth withstands temperatures to 3,000°F. No asbestos. Protects walls, floors, equipment, components and adjacent surfaces from torch flames when soldering, brazing or welding. All cloths have edges taped and sewn with grommets at each corner. Highly resistant to many chemicals and acids.

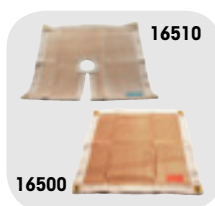

| CATALOG NO.  | DESCRIPTION   | UOM | ORDER MULTIPLE |
|--------------|---|-----|----------------|
| <b>16500</b> | 18" x 18" Plain   | EA  | 1              |
| <b>16510</b> | 18" x 18" Keyhole w/cutout for draping over pipes/tubes | EA  | 1              |
| <b>16520</b> | 36" x 36" Plain   | EA  | 1              |

**Map-Pro and Propane Gas**

Map-Pro and Propane Gas are tanks that can be used to weld products.



| CATALOG NO.    | DESCRIPTION            | UOM | ORDER MULTIPLE |
|----------------|------------------------|-----|----------------|
| <b>525-MT1</b> | Map-Pro Gas – 14 oz.   | EA  | 12             |
| <b>525-PT1</b> | Propane Gas – 14.1 oz. | EA  | 12             |

**Portable Hand Torch**

Self igniting hand torch eliminates the need for a flint lighter. Lightweight and portable, this flame tool can be operated with Propane or MAP-Pro™ (Propylene). Features trigger lock with instant safety release, full size comfort grip and 360° swivel tip. Operates in any position, even upside down. Includes swirl combustion tip end.



| CATALOG NO.      | DESCRIPTION         | UOM | ORDER MULTIPLE |
|------------------|---------------------|-----|----------------|
| <b>525-TORCH</b> | Portable Hand Torch | EA  | 1              |



# PLUMBING

|   |         |
|---|---------|
| CPVC-CTS Pipe and Fittings.....         | 186     |
| Nylon Fittings .....                    | 186-187 |
| Oatey® Products .....                   | 188     |
| PVC Condensate Pipe .....               | 190     |
| PVC DWV Fittings .....                  | 190     |
| PVC Primer and Cement .....             | 189     |
| PVC Schedule 40 Pressure Fittings ..... | 191-193 |
| Supports .....                          | 194     |
| Tubing, Clamps, and Kits .....          | 194     |



**CPVC-CTS PIPE AND FITTINGS**

**CPVC-CTS Pipe by FlowGuard® Gold™**

CTS = Copper Tube Size

| CATALOG NO. | DESCRIPTION                | UOM | ORDER MULTIPLE |
|-------------|----------------------------|-----|----------------|
| 4700-12     | 1/2" x 10' CPVC Pipe, 500' | EA  | 500'           |
| 4700-34     | 3/4" x 10' CPVC Pipe, 250' | EA  | 250'           |



4700-12

**CPVC-CTS Fittings by FlowGuard® Gold™**

CTS = Copper Tube Size

| CATALOG NO. | DESCRIPTION               | UOM | ORDER MULTIPLE |
|-------------|---------------------------|-----|----------------|
| 4701-12     | 1/2" Coupling S x S       | EA  | 20             |
| 4704-12     | 1/2" Adapter M x S        | EA  | 20             |
| 4707-12     | 1/2" 90° Elbow S x S      | EA  | 20             |
| 4711-12     | 1/2" Tee S x S x S        | EA  | 20             |
| 47072-12    | 1/2" 90° Street Ell S x S | EA  | 10             |
| 4718-12     | 3/4" x 1/2" CPVC Bushing  | EA  | 10             |
| 4701-34     | 3/4" Coupling S x S       | EA  | 20             |
| 4703-34     | 3/4" Adapter F x S        | EA  | 25             |
| 4704-34     | 3/4" Adapter M x S        | EA  | 10             |
| 4707-34     | 3/4" 90° Elbow S x S      | EA  | 20             |
| 4711-34     | 3/4" Tee S x S x S        | EA  | 20             |
| 47072-34    | 3/4" 90° Street Ell S x S | EA  | 10             |



4703-34

**NYLON FITTINGS\***

**Male Adapter (Barb x MIPT)**



701-001

| CATALOG NO. | DESCRIPTION                              | UOM | ORDER MULTIPLE |
|-------------|--|-----|----------------|
| 701-001     | Adapter – 1/2 Barb x 1/2 MIPT, pack of 2 | PK  | 1              |
| 701-002     | Adapter – 1/2 Barb x 3/4 MIPT, pack of 2 | PK  | 1              |
| 701-003     | Adapter – 1/2 Barb x 3/8 MIPT, pack of 2 | PK  | 1              |
| 701-007     | Adapter – 3/4 Barb x 3/4 MIPT, pack of 2 | PK  | 1              |
| 701-012     | Adapter – 3/8 Barb x 1/2 MIPT, pack of 2 | PK  | 1              |
| 701-013     | Adapter – 3/8 Barb x 3/8 MIPT, pack of 2 | PK  | 1              |
| 701-014     | Adapter – 5/8 Barb x 3/4 MIPT, pack of 2 | PK  | 1              |
| 701-043     | Adapter – 3/8 Barb x 3/4 MIPT, pack of 2 | PK  | 1              |

**Female Adapter (Barb x FIPT)**



701-006

| CATALOG NO. | DESCRIPTION                             | UOM | ORDER MULTIPLE |
|-------------|---|-----|----------------|
| 701-006     | Adapter – 3/4 Barb x 3/4 NPT, pack of 2 | PK  | 1              |
| 701-041     | Adapter – 1/2 Barb x 1/2 NPT, pack of 2 | PK  | 1              |

**Bushing (MIPT x FIPT)**



701-015

| CATALOG NO. | DESCRIPTION                              | UOM | ORDER MULTIPLE |
|-------------|--|-----|----------------|
| 701-015     | Bushing – 1 MIPT x 3/4 FIPT, pack of 2   | PK  | 1              |
| 701-017     | Bushing – 3/4 MIPT x 1/2 FIPT, pack of 2 | PK  | 1              |

**Garden Hose Adapters**



701-008

| CATALOG NO. | DESCRIPTION                              | UOM | ORDER MULTIPLE |
|-------------|--|-----|----------------|
| 701-008     | Adapter – 3/4 MGHT x 3/4 FGHT, pack of 2 | PK  | 1              |
| 701-009     | Adapter – 3/4 MGHT x 3/4 FIPT, pack of 2 | PK  | 1              |
| 701-011     | Adapter – 3/4 MIPT x 3/4 FGHT, pack of 2 | PK  | 1              |

\*All fittings packaged with identification. To order nylon fittings in bulk, enter catalog number followed by the letter "B." For example, 701-001B is the bulk part number for 701-001. Bulk sold in packs of 100.

**Elbow (Barb x Barb)**



| CATALOG NO.    | DESCRIPTION                 | UOM | ORDER MULTIPLE |
|----------------|-----------------------------|-----|----------------|
| <b>701-018</b> | Elbow – 1/2 Barb, pack of 2 | PK  | 1              |
| <b>701-023</b> | Elbow – 3/4 Barb, pack of 2 | PK  | 1              |
| <b>701-040</b> | Elbow – 5/8 Barb, pack of 2 | PK  | 1              |
| <b>701-046</b> | Elbow – 3/8 Barb, pack of 2 | PK  | 1              |

**Female Adapter Elbow (Barb x FIPT)**



| CATALOG NO.    | DESCRIPTION                           | UOM | ORDER MULTIPLE |
|----------------|---------------------------------------|-----|----------------|
| <b>701-019</b> | Elbow – 1/2 Barb x 3/4 NPT, pack of 2 | PK  | 1              |

**Male Adapter Elbow (Barb x MIPT)**



| CATALOG NO.    | DESCRIPTION                            | UOM | ORDER MULTIPLE |
|----------------|--|-----|----------------|
| <b>701-020</b> | Elbow – 1/2 Barb x 3/4 MIPT, pack of 2 | PK  | 1              |
| <b>701-025</b> | Elbow – 3/4 Barb x 3/4 MIPT, pack of 2 | PK  | 1              |
| <b>701-028</b> | Elbow – 5/8 Barb x 3/4 MIPT, pack of 2 | PK  | 1              |

**Hose Mender (Barb x Barb)**



| CATALOG NO.    | DESCRIPTION                       | UOM | ORDER MULTIPLE |
|----------------|-----------------------------------|-----|----------------|
| <b>701-029</b> | Hose Mender – 1/2 Barb, pack of 2 | PK  | 1              |
| <b>701-030</b> | Hose Mender – 1/4 Barb, pack of 2 | PK  | 1              |
| <b>701-031</b> | Hose Mender – 3/4 Barb, pack of 2 | PK  | 1              |
| <b>701-032</b> | Hose Mender – 3/8 Barb, pack of 2 | PK  | 1              |
| <b>701-033</b> | Hose Mender – 5/8 Barb, pack of 2 | PK  | 1              |

**Tee (Barb x Barb x Barb)**



| CATALOG NO.    | DESCRIPTION                           | UOM | ORDER MULTIPLE |
|----------------|---------------------------------------|-----|----------------|
| <b>701-034</b> | Tee – 1/2 Barb, pack of 2             | PK  | 1              |
| <b>701-035</b> | Tee – 1/2 x 3/4 x 1/2 Barb, pack of 2 | PK  | 1              |
| <b>701-037</b> | Tee – 3/4 Barb, pack of 2             | PK  | 1              |
| <b>701-038</b> | Tee – 3/8 Barb, pack of 2             | PK  | 1              |
| <b>701-039</b> | Tee – 5/8 Barb, pack of 2             | PK  | 1              |

\*All fittings packaged with identification. To order nylon fittings in bulk, enter catalog number followed by the letter "B." For example, 701-001B is the bulk part number for 701-001. Bulk sold in packs of 100.

**OATEY® PRODUCTS**

**PVC Cement – Clear**

PVC Cement is clear. All cans have brushtop applicator.



| CATALOG NO. | DESCRIPTION             | UOM | ORDER MULTIPLE |
|-------------|-------------------------|-----|----------------|
| 5-14        | Oatey #31012 – 1/4 Pint | EA  | 24             |
| 5-12        | Oatey #31013 – 1/2 Pint | EA  | 24             |
| 5-10        | Oatey #31014 – 1 Pint   | EA  | 24             |
| 5-32        | Oatey #31015 – 32 oz.   | EA  | 12             |

**Purple Primer for PVC Pipe and Fittings (Black Label)**

Recommended for all PVC and CPVC installations – all sizes/schedules. Purple tinted primer formulated to remove surface dirt and grease as well as soften the pipe surface to allow for a fast, secure and permanent solvent weld. For use in areas where codes call for primer verification.



| CATALOG NO. | DESCRIPTION            | UOM | ORDER MULTIPLE |
|-------------|------------------------|-----|----------------|
| 530-30755   | Purple Primer – 4 oz.  | EA  | 24             |
| 530-30756   | Purple Primer – 8 oz.  | EA  | 24             |
| 530-30757   | Purple Primer – 16 oz. | EA  | 24             |

NSF and UPC listed. Exceeds ASTM F-656.

**Heavy Duty PVC Cement**

Heavy bodied clear cement recommended for use on PVC pipe and fittings up to 12" in diameter for Sch. 40 and Sch. 80 potable water pressure pipe, gas, conduit, drain waste and vent pipe. Exceeds ASTM D-2564.



| CATALOG NO. | DESCRIPTION                | UOM | ORDER MULTIPLE |
|-------------|----------------------------|-----|----------------|
| 530-30850   | Heavy Duty Cement – 4 oz.  | EA  | 24             |
| 530-30863   | Heavy Duty Cement – 8 oz.  | EA  | 24             |
| 530-30876   | Heavy Duty Cement – 16 oz. | EA  | 24             |

**Rain-R-Shine Blue Cement**

Medium bodied blue colored cement for PVC pipe and fittings up to 6 inches in diameter. A very fast setting cement formulated for wet conditions and/or when quick pressurization and fast installation is needed. Exceeds ASTM D-2564.



| CATALOG NO. | DESCRIPTION                  | UOM | ORDER MULTIPLE |
|-------------|------------------------------|-----|----------------|
| 530-30890   | Rain-R-Shine Cement – 4 oz.  | EA  | 24             |
| 530-30891   | Rain-R-Shine Cement – 8 oz.  | EA  | 24             |
| 530-30893   | Rain-R-Shine Cement – 16 oz. | EA  | 24             |

**PVC Primer – Clear**

Recommended for all PVC and CPVC applications. Can be used on all sizes and schedules. Formulated to remove all surface dirt, grease, and grime as well as soften the pipe in preparation for solvent cement. This primer can be used when you want a cleaner installation. Meets ASTM F-656 and is NSF listed.



| CATALOG NO. | DESCRIPTION                 | UOM | ORDER MULTIPLE |
|-------------|-----------------------------|-----|----------------|
| 530-30752   | PVC Primer – Clear – 16 oz. | EA  | 24             |
| 530-30753   | PVC Primer – Clear – 32 oz. | EA  | 12             |

**All-Purpose Clear Cement for ABS, PVC and CPVC Pipe and Fittings**

Heavy-bodied clear cement recommended for use on ABS, PVC, and CPVC pipe and fittings up to 12" in diameter. Flows freely and provides a thick layer of cement on the pipe. Apply at temperatures 40° to 90°F.



| CATALOG NO. | DESCRIPTION           | UOM | ORDER MULTIPLE |
|-------------|-----------------------|-----|----------------|
| 530-30818   | Clear Cement – 4 oz.  | EA  | 24             |
| 530-30821   | Clear Cement – 8 oz.  | EA  | 24             |
| 530-30834   | Clear Cement – 16 oz. | EA  | 24             |

**PVC Gray Cement for High Efficiency Furnaces, Vent and Make-Up Air**

Medium-bodied gray colored cement for use on Sch. 40 conduit, drain waste, and vent pipe. Flows freely and covers with a thicker layer than regular PVC. Can be applied at temperatures 40° to 100°F.



| CATALOG NO. | DESCRIPTION          | UOM | ORDER MULTIPLE |
|-------------|----------------------|-----|----------------|
| 530-30884   | Gray Cement – 8 oz.  | EA  | 24             |
| 530-30885   | Gray Cement – 16 oz. | EA  | 24             |

NSF and UPC listed. Exceeds ASTM D-2564.

**All Weather PVC Cement**

Medium bodied cement for PVC pipe and fittings up to 6". Formulated for fast initial set-up from -15°F to 100°F. Exceeds ASTM D-2564.



| CATALOG NO. | DESCRIPTION                 | UOM | ORDER MULTIPLE |
|-------------|-----------------------------|-----|----------------|
| 530-31132   | All Weather Cement – 16 oz. | EA  | 24             |
| 530-31133   | All Weather Cement – 32 oz. | EA  | 12             |



**PVC PRIMER AND CEMENT**

**Pro-Weld™ PVC Cement (Regular Body)**

Pro-Weld™ PVC Cement is a clear, regular bodied solvent cement designed to be used on Type I and II PVC pipe and fittings up to and including 4 inch diameter. Pro-Weld™ meets ASTM Standard D-2564.



| CATALOG NO.  | DESCRIPTION   | UOM | ORDER MULTIPLE |
|--------------|---|-----|----------------|
| <b>PW-4</b>  | Pro-Weld™ – 4 oz. Brush-Top Container – Regular Body  | EA  | 24             |
| <b>PW-8</b>  | Pro-Weld™ – 8 oz. Brush-Top Container – Regular Body  | EA  | 24             |
| <b>PW-16</b> | Pro-Weld™ – 16 oz. Brush-Top Container – Regular Body | EA  | 24             |
| <b>PW-32</b> | Pro-Weld™ – 32 oz. Brush-Top Container – Regular Body | EA  | 12             |

**Pro-Weld™ PVC Cement (Heavy Body)**

Pro-Weld™ Heavy Body is a clear, heavy bodied, very high strength industrial grade PVC cement. It has a medium setting time and works with all rigid schedule 40 and 80 pipe diameters up to 12 inches. Complies with ASTM D2564 and NSF.



| CATALOG NO.   | DESCRIPTION   | UOM | ORDER MULTIPLE |
|---------------|---|-----|----------------|
| <b>PWH-4</b>  | Pro-Weld™ – 4 oz. Brush-Top Container – Heavy Body  | EA  | 24             |
| <b>PWH-8</b>  | Pro-Weld™ – 8 oz. Brush-Top Container – Heavy Body  | EA  | 24             |
| <b>PWH-16</b> | Pro-Weld™ – 16 oz. Brush-Top Container – Heavy Body | EA  | 24             |

**Pro-Weld™ PVC Cement (Pool and Turf – Blue)**

Pro-Weld™ Blue Pool and Turf is a blue colored, medium bodied, high strength PVC cement for welding rigid or flexible PVC in wet conditions where the system needs to be pressurized quickly. Pro-Weld Blue Pool and Turf sets up very fast and works with all rigid and flexible schedule 40 and 80 pipe diameters up to 6 inches. Complies with ASTM D2564 and NSF.

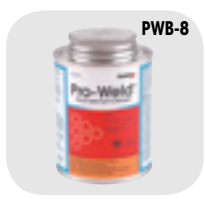

| CATALOG NO.   | DESCRIPTION   | UOM | ORDER MULTIPLE |
|---------------|---|-----|----------------|
| <b>PWB-4</b>  | Pro-Weld™ – 4 oz. Brush-Top Container – Pool and Turf – Blue  | EA  | 24             |
| <b>PWB-8</b>  | Pro-Weld™ – 8 oz. Brush-Top Container – Pool and Turf – Blue  | EA  | 24             |
| <b>PWB-16</b> | Pro-Weld™ – 16 oz. Brush-Top Container – Pool and Turf – Blue | EA  | 24             |
| <b>PWB-32</b> | Pro-Weld™ – 32 oz. Brush-Top Container – Pool and Turf – Blue | EA  | 24             |

**Pro-Weld™ PVC Cement (Universal – PVC/ABS/CPVC)**

Pro-Weld™ Universal Cement is a clear, medium bodied, high strength cement for use on PVC to PVC, CPVC to CPVC, and ABS to ABS connections. Pro-Weld Universal sets up fast and works with all rigid schedule 40 and 80 piping up to 6 inches in diameter. Complies with ASTM D2564, D2235, and F493.

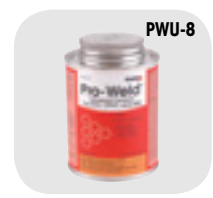

| CATALOG NO.   | DESCRIPTION   | UOM | ORDER MULTIPLE |
|---------------|---|-----|----------------|
| <b>PWU-4</b>  | Pro-Weld™ – 4 oz. Brush-Top Container – Universal – PVC/ABS/CPVC  | EA  | 24             |
| <b>PWU-8</b>  | Pro-Weld™ – 8 oz. Brush-Top Container – Universal – PVC/ABS/CPVC  | EA  | 24             |
| <b>PWU-16</b> | Pro-Weld™ – 16 oz. Brush-Top Container – Universal – PVC/ABS/CPVC | EA  | 24             |

**Pro-Prime™ PVC Primer (Purple)**

A purple-tinted primer formulated to remove dirt and oil from the surface of Type I and II PVC piping, as well as soften the piping in preparation for solvent welding. Pro-Prime™ contains purple pigment which provides verification that the primer has been applied to the pipe surface. Pro-Prime™ meets ASTM Standard F-656.



| CATALOG NO.  | DESCRIPTION                             | UOM | ORDER MULTIPLE |
|--------------|---|-----|----------------|
| <b>PP-4</b>  | Pro-Prime™ – 4 oz. Brush-Top Container  | EA  | 24             |
| <b>PP-8</b>  | Pro-Prime™ – 8 oz. Brush-Top Container  | EA  | 24             |
| <b>PP-16</b> | Pro-Prime™ – 16 oz. Brush-Top Container | EA  | 24             |
| <b>PP-32</b> | Pro-Prime™ – 32 oz. Can                 | EA  | 12             |

**Pro-Prime™ Clear PVC Primer**

Clear primer that removes dirt and oil from the surface of Type I and II PVC piping. Softens the piping to prepare for solvent welding. Pro-Prime Clear primer meets ASTM Standard F-656.



| CATALOG NO.   | DESCRIPTION                                   | UOM | ORDER MULTIPLE |
|---------------|---|-----|----------------|
| <b>PPC-8</b>  | Pro-Prime™ Clear – 8 oz. Brush-Top Container  | EA  | 24             |
| <b>PPC-16</b> | Pro-Prime™ Clear – 16 oz. Brush-Top Container | EA  | 24             |

**Pro-Weld™ Weather-ALL**

Pro-Weld™ PVC Cement is a clear, regular bodied solvent cement designed to be used on Type I and II PVC pipe and fittings up to and including 4 inch diameter. Pro-Weld™ meets ASTM Standard D-2564 and is usable in cold weather to -15°F and hot weather to 110°F.

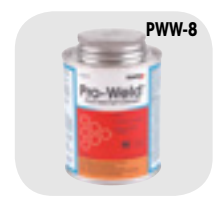

| CATALOG NO.   | DESCRIPTION   | UOM | ORDER MULTIPLE |
|---------------|---|-----|----------------|
| <b>PWW-4</b>  | Pro-Weld™ – 4 oz. Brush-Top Container – All Weather Regular Body  | EA  | 24             |
| <b>PWW-8</b>  | Pro-Weld™ – 8 oz. Brush-Top Container – All Weather Regular Body  | EA  | 24             |
| <b>PWW-16</b> | Pro-Weld™ – 16 oz. Brush-Top Container – All Weather Regular Body | EA  | 24             |

**PVC CONDENSATE PIPE**

**Polyvinyl Chloride, White PVC 1120**



| CATALOG NO. | DESCRIPTION                                      | UOM | ORDER MULTIPLE |
|-------------|--|-----|----------------|
| 5-2002      | 3/4" PVC – PSI 200 – 10' Straight End            | EA  | 500'           |
| 5-2005      | 3/4" PVC – PSI 200 – 20' Belled End              | EA  | 500'           |
| 5-401       | 3/4" PVC – Sch. 40 – 10' Straight End            | EA  | 500'           |
| 5-407       | 3/4" PVC – Sch. 40 – 20' Belled End              | EA  | 500'           |
| 5-404       | 2" PVC – Sch.40/DWW,ASTM 2665 – 10' Straight End | EA  | 100'           |
| 5-405       | 3" PVC – Sch.40/DWW,ASTM 2665 – 10' Straight End | EA  | 50'            |
| 5-416       | 1" PVC – Sch. 40 – 20' Belled End                | EA  | 200'           |
| 5-417       | 1-1/4" PVC – Sch. 40 – 20' Belled End            | EA  | 200'           |
| 5-418       | 1-1/2" PVC – Sch. 40 – 20' Belled End            | EA  | 200'           |

**PVC DWV FITTINGS**

**Couplings (Hub x Hub)**



| CATALOG NO. | DESCRIPTION                       | UOM | ORDER MULTIPLE |
|-------------|-----------------------------------|-----|----------------|
| 5-100020    | 2" Couplings (Hub x Hub)          | EA  | 100            |
| 5-100030    | 3" Couplings (Hub x Hub)          | EA  | 60             |
| 510-D102251 | 2" x 1-1/2" Couplings (Hub x Hub) | EA  | 25             |
| 510-D102338 | 3" x 2" Couplings (Hub x Hub)     | EA  | 20             |

**90 Elbow (Hub x Hub)**



| CATALOG NO. | DESCRIPTION                        | UOM | ORDER MULTIPLE |
|-------------|------------------------------------|-----|----------------|
| 5-300020    | 2" 90 Elbow (Hub x Hub)            | EA  | 50             |
| 5-300030    | 3" 90 Elbow (Hub x Hub)            | EA  | 25             |
| 510-D304020 | 2" Long Sweep 90 Elbow (Hub x Hub) | EA  | 25             |
| 510-D304030 | 3" Long Sweep 90 Elbow (Hub x Hub) | EA  | 10             |

**45 Elbows**



| CATALOG NO. | DESCRIPTION                     | UOM | ORDER MULTIPLE |
|-------------|---------------------------------|-----|----------------|
| 5-321020    | 2" 45 Elbow (Hub x Hub)         | EA  | 50             |
| 5-321030    | 3" 45 Elbow (Hub x Hub)         | EA  | 20             |
| 510-D323020 | 2" 45 Street Elbow (Hub x SPIG) | EA  | 50             |
| 510-D323030 | 3" 45 Street Elbow (Hub x SPIG) | EA  | 20             |

**DWV Bend Fittings**



| CATALOG NO. | DESCRIPTION                | UOM | ORDER MULTIPLE |
|-------------|----------------------------|-----|----------------|
| 510-D309020 | 2" Long Sweep (Hub x SPIG) | EA  | 25             |
| 510-D309030 | 3" Long Sweep (Hub x SPIG) | EA  | 20             |

**DWV Vent Tee**



| CATALOG NO. | DESCRIPTION | UOM | ORDER MULTIPLE |
|-------------|-------------|-----|----------------|
| 510-D441020 | 2" Vent Tee | EA  | 25             |

**DWV Bushings**



| CATALOG NO. | DESCRIPTION                            | UOM | ORDER MULTIPLE |
|-------------|--|-----|----------------|
| 510-437338  | 3" x 2" Reducing Bushing (SPIG x SLIP) | EA  | 10             |
| 510-438338  | 3" x 2" Bushing (SPIG x FIPT)          | EA  | 10             |

**PVC SCHEDULE 40 PRESSURE FITTINGS**

**Tee (Slip x Slip x Slip)**



| CATALOG NO. | DESCRIPTION | UOM | ORDER MULTIPLE |
|-------------|-------------|-----|----------------|
| 5-401005    | 1/2" Tee    | EA  | 50             |
| 5-401007    | 3/4" Tee    | EA  | 50             |
| 5-401010    | 1" Tee      | EA  | 50             |
| 5-401020    | 2" Tee      | EA  | 25             |
| 5-401030    | 3" Tee      | EA  | 10             |

**90 Ell (Slip x Slip)**



| CATALOG NO. | DESCRIPTION | UOM | ORDER MULTIPLE |
|-------------|-------------|-----|----------------|
| 5-406005    | 1/2" 90 Ell | EA  | 50             |
| 5-406007    | 3/4" 90 Ell | EA  | 50             |
| 5-406010    | 1" 90 Ell   | EA  | 50             |
| 5-406020    | 2" 90 Ell   | EA  | 25             |
| 5-406030    | 3" 90 Ell   | EA  | 10             |

**90 Ell (Slip x FIPT)**



| CATALOG NO. | DESCRIPTION                | UOM | ORDER MULTIPLE |
|-------------|----------------------------|-----|----------------|
| 5-407005    | 1/2" 90 Ell                | EA  | 50             |
| 5-407007    | 3/4" 90 Ell                | EA  | 50             |
| 5-407074    | 1/2" x 3/4" 90 Ell Reducer | EA  | 50             |
| 5-407131    | 1" x 3/4" 90 Ell Reducer   | EA  | 50             |

**90 Street Ell (SPIG x Slip)**



| CATALOG NO. | DESCRIPTION        | UOM | ORDER MULTIPLE |
|-------------|--------------------|-----|----------------|
| 5-409005    | 1/2" 90 Street Ell | EA  | 50             |
| 5-409007    | 3/4" 90 Street Ell | EA  | 50             |
| 5-409010    | 1" 90 Street Ell   | EA  | 50             |

**Tee (Slip x FIPT x Slip)**



| CATALOG NO. | DESCRIPTION             | UOM | ORDER MULTIPLE |
|-------------|-------------------------|-----|----------------|
| 5-402007    | 3/4" Tee (S x S x FIPT) | EA  | 50             |

**Traps**

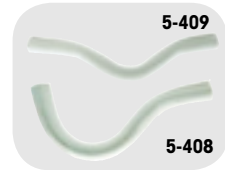

| CATALOG NO. | DESCRIPTION        | UOM | ORDER MULTIPLE |
|-------------|--------------------|-----|----------------|
| 5-408       | 3/4" "P" Trap      | EA  | 100            |
| 5-409       | 3/4" Running Trap  | EA  | 100            |
| 5-410       | 3/4" Mini "P" Trap | EA  | 100            |
| 5-411       | 1" "P" Trap        | EA  | 50             |
| 5-412       | 1/2" "P" Trap      | EA  | 100            |
| 5-414       | 3/4" "J" Trap      | EA  | 100            |

**90 Ell Reducing (Slip x FIPT)**



| CATALOG NO. | DESCRIPTION               | UOM | ORDER MULTIPLE |
|-------------|---------------------------|-----|----------------|
| 5-407131    | 1" x 3/4" 90 Ell Reducing | EA  | 50             |

**45 Ell (Slip x Slip)**



| CATALOG NO. | DESCRIPTION   | UOM | ORDER MULTIPLE |
|-------------|---------------|-----|----------------|
| 5-417005    | 1/2" 45 Ell   | EA  | 50             |
| 5-417007    | 3/4" 45 Ell   | EA  | 50             |
| 5-417010    | 1" 45 Ell     | EA  | 50             |
| 5-417012    | 1-1/4" 45 Ell | EA  | 25             |
| 5-417020    | 2" 45 Ell     | EA  | 25             |
| 5-417030    | 3" 45 Ell     | EA  | 10             |

PVC SCHEDULE 40 PRESSURE FITTINGS cont'd

Plug (Slip)



| CATALOG NO. | DESCRIPTION | UOM | ORDER MULTIPLE |
|-------------|-------------|-----|----------------|
| 5-449005    | 1/2" Plug   | EA  | 50             |
| 5-449007    | 3/4" Plug   | EA  | 50             |
| 5-449030    | 3" Plug     | EA  | 10             |

90 Street Ell (MIPT x Slip)



| CATALOG NO. | DESCRIPTION        | UOM | ORDER MULTIPLE |
|-------------|--------------------|-----|----------------|
| 5-410005    | 1/2" 90 Street Ell | EA  | 50             |
| 5-410007    | 3/4" 90 Street Ell | EA  | 50             |
| 5-410010    | 1" 90 Street Ell   | EA  | 50             |

Female Adapter (Slip x FIPT)



| CATALOG NO. | DESCRIPTION         | UOM | ORDER MULTIPLE |
|-------------|---------------------|-----|----------------|
| 5-435005    | 1/2" Female Adapter | EA  | 100            |
| 5-435007    | 3/4" Female Adapter | EA  | 50             |

Female Adapter Reducing (Slip x FIPT)



| CATALOG NO. | DESCRIPTION                         | UOM | ORDER MULTIPLE |
|-------------|-------------------------------------|-----|----------------|
| 5-435101    | 3/4" x 1/2" Female Adapter Reducing | EA  | 50             |
| 5-435102    | 3/4" x 1" Female Adapter Reducing   | EA  | 50             |

Coupling (Slip x Slip)



| CATALOG NO. | DESCRIPTION     | UOM | ORDER MULTIPLE |
|-------------|-----------------|-----|----------------|
| 5-429005    | 1/2" Coupling   | EA  | 100            |
| 5-429007    | 3/4" Coupling   | EA  | 50             |
| 5-429010    | 1" Coupling     | EA  | 50             |
| 5-429015    | 1-1/2" Coupling | EA  | 25             |
| 5-429020    | 2" Coupling     | EA  | 25             |
| 5-429030    | 3" Coupling     | EA  | 10             |

Cap (Slip)



| CATALOG NO. | DESCRIPTION | UOM | ORDER MULTIPLE |
|-------------|-------------|-----|----------------|
| 5-447007    | 3/4" Cap    | EA  | 100            |

Male Adapter (MIPT x Slip)



| CATALOG NO. | DESCRIPTION       | UOM | ORDER MULTIPLE |
|-------------|-------------------|-----|----------------|
| 5-436005    | 1/2" Male Adapter | EA  | 100            |
| 5-436007    | 3/4" Male Adapter | EA  | 50             |
| 5-436010    | 1" Male Adapter   | EA  | 50             |
| 5-436020    | 2" Male Adapter   | EA  | 25             |
| 5-436030    | 3" Male Adapter   | EA  | 10             |

Plug (MIPT)



| CATALOG NO. | DESCRIPTION | UOM | ORDER MULTIPLE |
|-------------|-------------|-----|----------------|
| 5-450007    | 3/4" Plug   | EA  | 50             |



### Male Adapter Reducing (MIPT x Slip)



| CATALOG NO. | DESCRIPTION                       | UOM | ORDER MULTIPLE |
|-------------|-----------------------------------|-----|----------------|
| 5-436074    | 1/2" x 3/4" Male Adapter Reducing | EA  | 50             |
| 5-436101    | 3/4" x 1/2" Male Adapter Reducing | EA  | 50             |
| 5-436102    | 3/4" x 1" Male Adapter Reducing   | EA  | 50             |
| 5-436131    | 1" x 3/4" Male Adapter Reducing   | EA  | 50             |

### Reducer Bushing (SPIG x Slip)



| CATALOG NO. | DESCRIPTION                   | UOM | ORDER MULTIPLE |
|-------------|-------------------------------|-----|----------------|
| 5-437101    | 3/4" x 1/2" Reducer Bushing   | EA  | 100            |
| 5-437130    | 1" x 1/2" Reducer Bushing     | EA  | 100            |
| 5-437131    | 1" x 3/4" Reducer Bushing     | EA  | 100            |
| 5-437210    | 1-1/2" x 3/4" Reducer Bushing | EA  | 25             |

### Reducer Bushing (SPIG X FIPT)



| CATALOG NO. | DESCRIPTION                 | UOM | ORDER MULTIPLE |
|-------------|-----------------------------|-----|----------------|
| 5-438101    | 3/4" x 1/2" Reducer Bushing | EA  | 100            |
| 5-438131    | 1" x 3/4" Reducer Bushing   | EA  | 100            |

### Cap (FIPT)



| CATALOG NO. | DESCRIPTION | UOM | ORDER MULTIPLE |
|-------------|-------------|-----|----------------|
| 5-448007    | 3/4" Cap    | EA  | 100            |

### Adapter (Insert x Slip)



| CATALOG NO. | DESCRIPTION                  | UOM | ORDER MULTIPLE |
|-------------|------------------------------|-----|----------------|
| 5-474007    | 3/4" Adapter (Insert x Slip) | EA  | 50             |

### Clean Out Tee



| CATALOG NO. | DESCRIPTION        | UOM | ORDER MULTIPLE |
|-------------|--------------------|-----|----------------|
| 510-3400-10 | 3/4" Clean Out Tee | EA  | 10             |
| 510-3400    | 3/4" Clean Out Tee | EA  | 50             |

### 3/4" Rubber Elbow

Allows for quick disconnect and reconnect of drain lines. Made of 60 DURO EPDM.



| CATALOG NO. | DESCRIPTION        | UOM | ORDER MULTIPLE |
|-------------|--------------------|-----|----------------|
| 5-520       | 3/4" Rubber Elbows | EA  | 50             |

**SUPPORTS**

**Plastic DWV J-Hooks**



| CATALOG NO.      | DESCRIPTION                      | UOM | ORDER MULTIPLE |
|------------------|----------------------------------|-----|----------------|
| <b>515-J2000</b> | 2" x 9" DWV Swiveling J-Hook     | EA  | 25             |
| <b>515-J3000</b> | 3" x 7-1/2" DWV Swiveling J-Hook | EA  | 25             |

**TUBING, CLAMPS, AND KITS**

**Polyethylene Tubing**

F.D.A. approved, flexible, non-toxic tubing. Tasteless and odorless, lightweight, low density. Ideal for drinking water lines, evaporative coolers, and radiant heating. I.D.: 11/64", O.D.: 1/4", Wall: 0.040, Max. W/P (in.) 150 PSI @ 70F.



| CATALOG NO.   | DESCRIPTION                                 | UOM | ORDER MULTIPLE |
|---------------|---|-----|----------------|
| <b>PE-104</b> | Polyethylene Tubing - 11/64ID, 1/4OD, 100FT | EA  | 1              |
| <b>PE-014</b> | Polyethylene Tubing - 1/8ID, 1/4OD, 100FT   | EA  | 1              |
| <b>PE-038</b> | Polyethylene Tubing - 1/4ID, 3/8 OD, 100FT  | EA  | 1              |
| <b>PE-058</b> | Polyethylene Tubing - 1/2ID, 5/8OD, 100FT   | EA  | 1              |

**Icemaker Kit**

Supplies water to most refrigerators with automatic icemakers, humidifiers and evaporative coolers. Contains self-tapping valve and all necessary fittings.



| CATALOG NO.    | DESCRIPTION                    | UOM | ORDER MULTIPLE |
|----------------|--------------------------------|-----|----------------|
| <b>750-401</b> | Icemaker Kit - Poly Tube - 25' | EA  | 1              |
| <b>750-402</b> | Icemaker Kit - Copper - 25'    | EA  | 1              |

**Hose Clamps**

Partial stainless, worm drive, adjustable. 300 series stainless steel 1/2" band with plated 5/16" slotted hex head screw and housing, except the B-4H which has a 5/16" band and 1/4" nut. Recommended for most applications. 100% interlock construction features one-piece housing which directly locks into band. Spot weld free design.

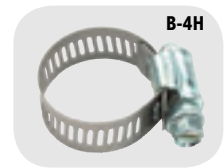

| CATALOG NO.  | DESCRIPTION   | UOM | ORDER MULTIPLE |
|--------------|---|-----|----------------|
| <b>B-4H</b>  | No. 4, 7/32" - 5/8" dia., 3/16" - 5/16" hose I.D.         | EA  | 10             |
| <b>B-6H</b>  | No. 6, 3/8" - 7/8" dia., 1/4" - 3/8" hose I.D.            | EA  | 10             |
| <b>B-8H</b>  | No. 8, 7/16" - 1" dia., 5/16" - 1/2" hose I.D.            | EA  | 10             |
| <b>B-10H</b> | No. 10, 9/16" - 1-1/16" dia., 3/8" - 5/8" hose I.D.       | EA  | 10             |
| <b>B-12H</b> | No. 12, 9/16" - 1-1/4" dia., 5/8" - 3/4" hose I.D.        | EA  | 10             |
| <b>B-16H</b> | No. 16, 11/16" - 1-1/2" dia., 3/4" - 1" hose I.D.         | EA  | 10             |
| <b>B-20H</b> | No. 20, 3/4" - 1-3/4" dia., 1" - 1-1/4" hose I.D.         | EA  | 10             |
| <b>B-24H</b> | No. 24, 1-1/16" - 2" dia., 1-1/4" - 1-1/2" hose I.D.      | EA  | 10             |
| <b>B-28H</b> | No. 28, 1-5/16" - 2-1/4" dia., 1-1/4" - 1-3/4" hose I.D.  | EA  | 10             |
| <b>B-32H</b> | No. 32, 1-9/16" - 2-1/2" dia., 1-1/2" - 2" hose I.D.      | EA  | 10             |
| <b>B-36H</b> | No. 36, 1-13/16" - 2-3/4" dia., 1-3/4" - 2-1/4" hose I.D. | EA  | 10             |

**Self Tapping Water Valve**

Installs on all copper tube lines from 3/8" O.D. to 1-1/8" O.D. without shutting off water. No drilling required. Features 1/4" compression fitting. Stainless steel piercing needle. Special molded gasket seals on both tubing and valve. Will not slip or turn on tubing.



| CATALOG NO.  | DESCRIPTION                  | UOM | ORDER MULTIPLE |
|--------------|------------------------------|-----|----------------|
| <b>QAV-2</b> | Self Tapping Water Tap Valve | EA  | 1              |

# DUCTLESS SYSTEMS

SpeediChannel™ Line Set Cover System ..... 201  
 Fittings..... 201-204  
 Roof Inlets..... 204

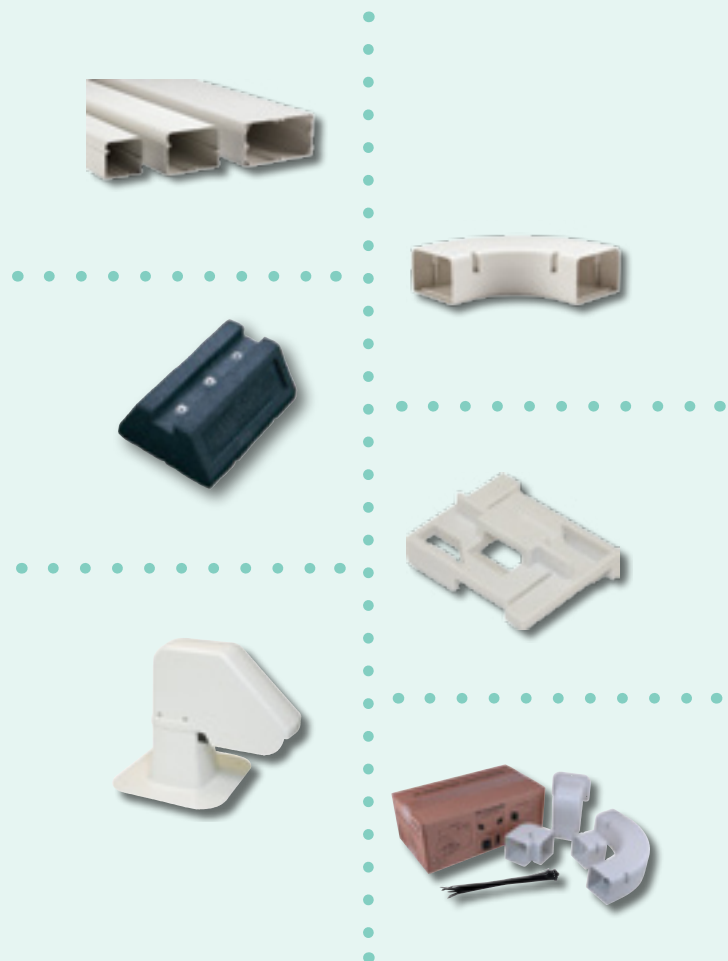

# SpeediChannel™ Line Set Cover System

DiversiTech SpeediChannel™ is an innovative channel system used to cover air conditioning line sets. The two part system has a base and a cover. The base is fastened to a wall or ceiling, then a clever little plastic clip (SpeediClip™) snaps into a channel already molded into the base. Then, using standard cable ties, the line set, cables, control wires, and/or condensate drain line are fastened in place. The cover then snaps simply on top of the base.

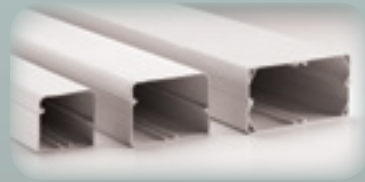

The SpeediChannel™ system is available in three widths – 3", 4", and 6". Each piece of Speedi-Channel™ is 6-1/2 feet long. A complete line of couplings, elbows, and tees are available for the SpeediChannel™ system.

Manufactured from rigid PVC, the SpeediChannel™ system comes in two popular colors. A Natural color that matches most mini-split condensing units or can be painted as desired to match any wall color. Use paint made for plastic only. A brown Terrastone color is also available which is popular with homeowners. The PVC used in the SpeediChannel system is resistant to UV light and is UL rated.



DiversiTech recommends attaching the base to the wall or ceiling and the line sets to the system every 15" to allow for the system to carry the full weight of the line sets.

*The SpeediChannel™ can also be used inside.*



**Now available in Brown**





*Cut your installation time!  
SpeediClip™— fastest  
SpeediChannel™  
installation.*

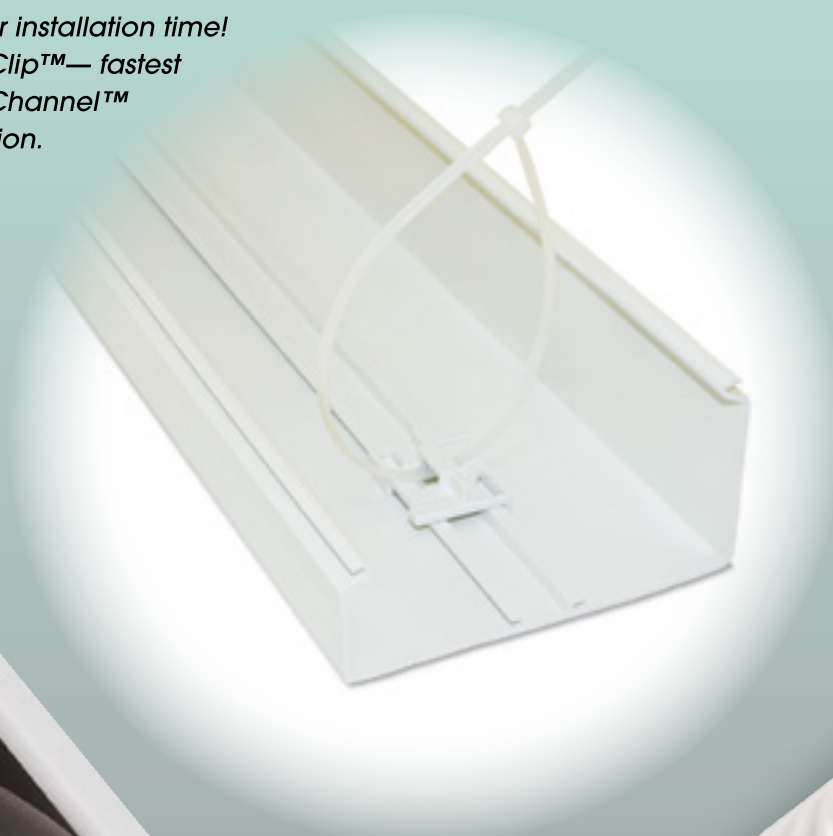

# DiversiTech SpeediChannel™ System

## SIZING CHART AND SELECTION INFORMATION

### Maximum Line Set, Drain Pipe, and Cable Capacity using 3/8" Insulation

| Model      | 230-D3      | 230-D4      | 230-D6  |
|------------|-------------|-------------|---------|
| Dimensions | 3" x 2-1/2" | 4" x 2-3/4" | 6" x 3" |
| Length     | 78"         | 78"         | 78"     |

### Mini-Split Systems – Liquid and Suction Line with 3/8" Insulation

|                 |               |                    |                     |
|-----------------|---------------|--------------------|---------------------|
| Liquid Line     | 3/8"          | 2 x 1/4"           | 1 x 1/4" + 2 x 3/8" |
| Suction Line    | 5/8"          | 2 x 3/8"           | 1 x 1/2" + 2 x 5/8" |
| Drain Hose      | 3/4" OD       | 2 x 3/4" OD        | 3 x 3/4" OD         |
| Power Cable     | 1 x UF 14-3   | 2 x 1/2" SealTite  | 3 x 1/2" SealTite   |
| Control Cable   | 1 Pair 18 AWG | 2 Pairs 18 AWG     | 3 Pairs 18 AWG      |
| Nominal Tonnage | 1–3 Tons      | 1x3 Ton or 2x1 Ton | 1x3 Ton or 2x2 Ton  |

### Conventional Split Systems – Liquid Line Plain, Suction Line with 3/8" Insulation

|                 |                |                   |                   |
|-----------------|----------------|-------------------|-------------------|
| Liquid Line     | 3/8"           | 3/8"              | 3/8"              |
| Suction Line    | 3/4" or 7/8"   | 1-1/8"            | 1-1/8"            |
| Drain Hose      | 3/4" PVC       | 3/4" PVC          | 3/4" PVC          |
| Power Cable     | 1 x UF 14-2    | 1 x 1/2" SealTite | 1 x 1/2" SealTite |
| Control Cable   | 1 Pair 18 AWG  | 1 Pair 18 AWG     | 1 Pair 18 AWG     |
| Nominal Tonnage | Up to 3.5 Tons | 4–5 Tons          | 7.5 Tons and up   |

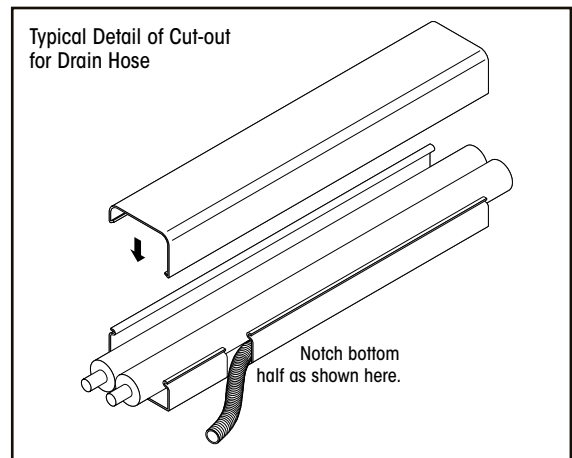
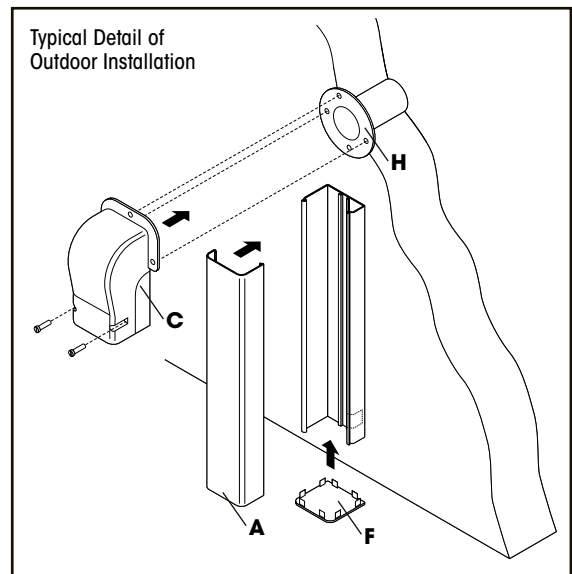
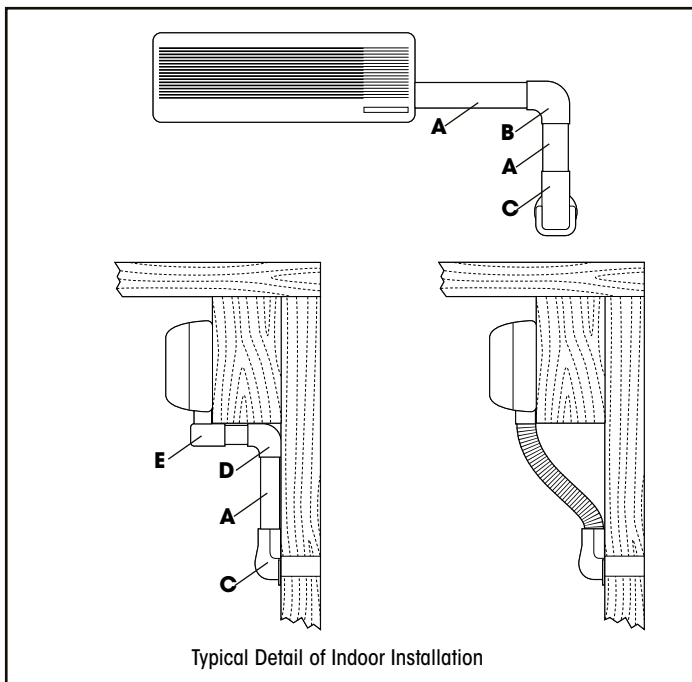

- A - 230-D
- B - 230-FB
- C - 230-WC
- D - 230-EB
- E - 230-EIN
- F - 230-DC
- G - 230-FJ
- H - 230-WS2

NOTE:  
Suffix parts A-G  
with the duct  
size needed  
(3, 4, or 6)

### Typical Detail of Flex Joint Application

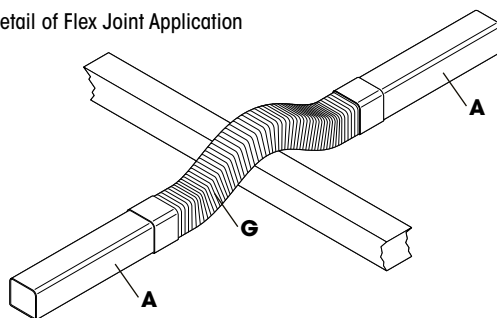

# DiversiTech SpeediChannel™ System

## TECHNICAL SPECIFICATIONS

|                    |   |                        |                        |
|--------------------|---|------------------------|------------------------|
| Color              | Natural or Brown in select 3" & 4" sizes                |                        |                        |
| Size               | 230-D3: 3" x 2-1/2" OD                                  | 230-D4: 4" x 2-3/4" OD | 230-D6: 6" x 3-1/8" OD |
| Material           | Weather Resistant PVC, UV Stabilized and Fire Resistant |                        |                        |
| Fire Rating        | Meets UL 94V-0  |                        |                        |
| Temperature Range  | -4°F TO 140°F   |                        |                        |
| Weather Resistance | Tested to over 2,000 hours                              |                        |                        |
| Fixing Screws      | Stainless Steel   |                        |                        |

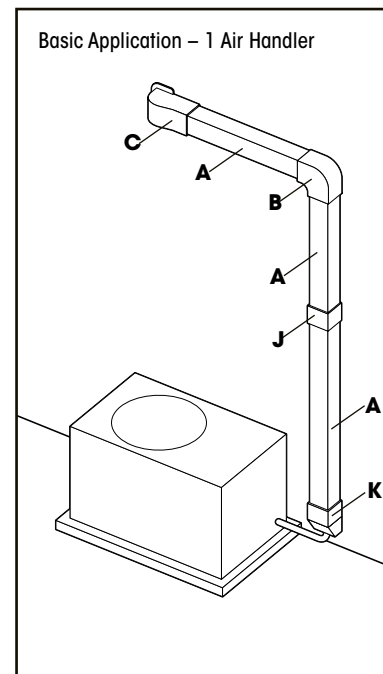
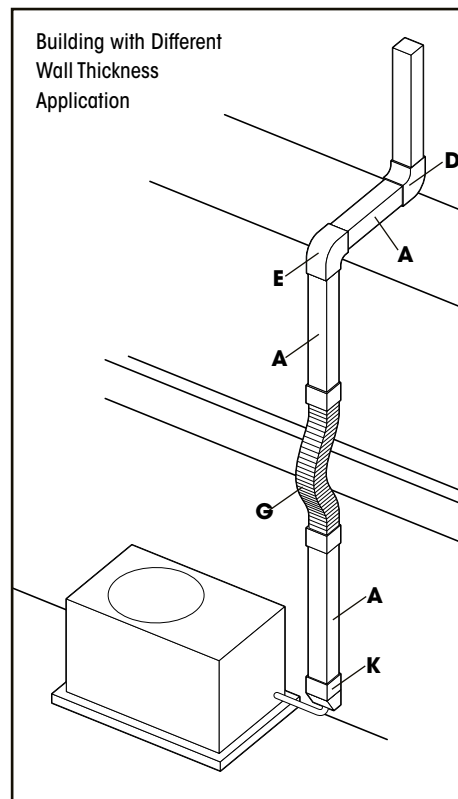
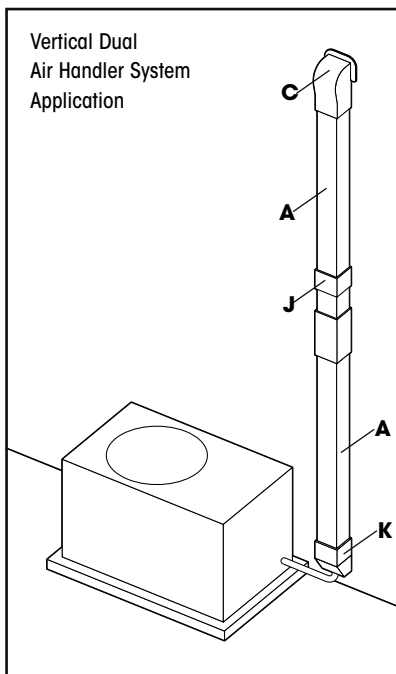
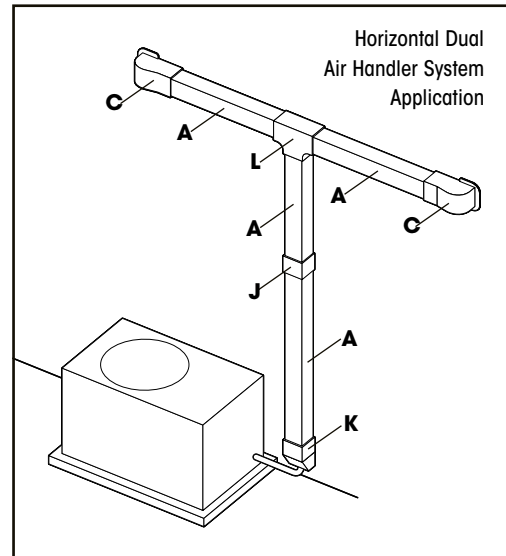
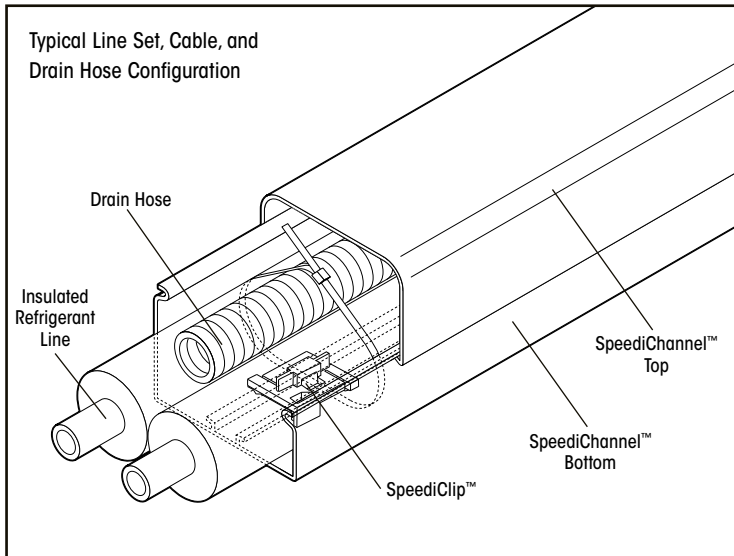

- A - 230-D
- B - 230-FB
- C - 230-WC
- D - 230-EB
- E - 230-EIN
- F - 230-DC
- G - 230-FJ
- H - 230-WS2
- J - 230-CP
- K - 230-DE
- L - 230-TC

NOTE:  
Suffix parts A-G  
with the duct  
size needed  
(3, 4, or 6)

# SpeediChannel™ System Installation

## Step 1

Attach the SpeediChannel™ base to the wall about every 15 inches with screws suitable for the wall construction (siding, stucco, brick, etc.). Screw through the center of the molded rail. Slide the connecting piece (elbow, union, tee, etc.) under the SpeediChannel™ before attaching the end of the channel to the wall. When cutting lengths of SpeediChannel™, allow 1/8" gap between the end of the SpeediChannel™ and the stop inside the fitting to allow for thermal expansion.



## Step 4

Attach the SpeediChannel™ to the base.



## Step 5

Attach the fitting covers with the screws provided.



## Step 2

Attach one SpeediClip™ with cable tie about every 20 inches along the inside sliding rail.



## Step 3

Install the line set, drain line, and wires inside the SpeediChannel™. Test the equipment installation prior to tightening the cable ties. Tighten the cable ties snug, but not so tight they damage the tubing insulation or kink the drain line. Trim excess length from the cable tie.



## Step 6

When complete, paint the SpeediChannel™ to match surface of installation (if desired).

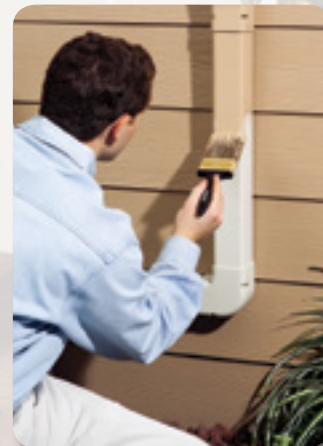



## SPEEDICHANNEL™ LINE SET COVER SYSTEM

### SpeediChannel™

The DiversiTech SpeediChannel™ is available in three widths, all in 6-1/2 feet lengths. Includes pack of SpeediClips™.



| CATALOG NO.    | DESCRIPTION              | UOM | ORDER MULTIPLE |
|----------------|--------------------------|-----|----------------|
| <b>230-D3</b>  | 3" SpeediChannel™        | EA  | 6              |
| <b>230-D3B</b> | 3" SpeediChannel™, Brown | EA  | 6              |
| <b>230-D4</b>  | 4" SpeediChannel™        | EA  | 6              |
| <b>230-D4B</b> | 4" SpeediChannel™, Brown | EA  | 6              |
| <b>230-D6</b>  | 6" SpeediChannel™        | EA  | 5              |

Channel must ship LTL.

## FITTINGS

### Adjustable Flat Bend

Adjustable flat bends flex from 45 to 90 degrees and make it easy to route the SpeediChannel™ around an obstacle. Each adjustable bend is individually packed and includes stainless steel screws.



| CATALOG NO.     | DESCRIPTION               | ORDER UOM | ORDER MULTIPLE |
|-----------------|---------------------------|-----------|----------------|
| <b>230-AFB3</b> | 3in. Adjustable Flat Bend | EA        | 10             |
| <b>230-AFB4</b> | 4in. Adjustable Flat Bend | EA        | 10             |

### Soffit Fittings

Ideal for outdoor applications where the SpeediChannel™ runs up an exterior wall and enters the house vertically through the soffit. Its large flat surface area easily covers the rough opening cut in the soffit. Furnished in two parts, the Soffit Fitting easily snaps onto the SpeediChannel™ for a clean installation.



| CATALOG NO.    | DESCRIPTION       | ORDER UOM | ORDER MULTIPLE |
|----------------|-------------------|-----------|----------------|
| <b>230-SF3</b> | 3" Soffit Fitting | EA        | 10             |
| <b>230-SF4</b> | 4" Soffit Fitting | EA        | 10             |

### Wall Penetration

Wall sleeves and penetration covers are used to transition from the SpeediChannel™ system to a through wall penetration. The wall sleeve creates a neat hole through the wall, and the line set is covered by the wall cover. DiversiTech's wall covers are designed to allow for easy installation - even after the line set has been installed. A unique hooking and fastening arrangement allows for quick and easy installation. Each wall cover is individually packed, and is furnished complete with stainless steel screws to attach the wall cover to the base. Three screws (supplied by others) are needed to fasten the wall cover to whatever type of wall construction the system is being installed on.



| CATALOG NO.     | DESCRIPTION                      | UOM | ORDER MULTIPLE |
|-----------------|----------------------------------|-----|----------------|
| <b>230-WC3</b>  | 3" Wall Penetration Cover        | EA  | 10             |
| <b>230-WC3B</b> | 3" Wall Penetration Cover, Brown | EA  | 10             |
| <b>230-WC4</b>  | 4" Wall Penetration Cover        | EA  | 10             |
| <b>230-WC4B</b> | 4" Wall Penetration Cover, Brown | EA  | 10             |
| <b>230-WC6</b>  | 6" Wall Penetration Cover        | EA  | 10             |
| <b>230-WS2</b>  | 2-1/2" Wall Sleeve               | EA  | 10             |

### 90° Flat Bend

90° flat bends are used to route the SpeediChannel™ around an obstacle. Each bend is individually packed, and is furnished complete with stainless steel screws.



| CATALOG NO.     | DESCRIPTION                   | UOM | ORDER MULTIPLE |
|-----------------|-------------------------------|-----|----------------|
| <b>230-FB3</b>  | 3" 90 degree Flat Bend        | EA  | 10             |
| <b>230-FB3B</b> | 3" 90 degree Flat Bend, Brown | EA  | 10             |
| <b>230-FB4</b>  | 4" 90 degree Flat Bend        | EA  | 10             |
| <b>230-FB4B</b> | 4" 90 degree Flat Bend, Brown | EA  | 10             |
| <b>230-FB6</b>  | 6" 90 degree Flat Bend        | EA  | 10             |

**FITTINGS cont'd**

**90° Long Radius Bend**

90° long radius flat bends are used to route the SpeediChannel™ around an obstacle. The long radius of the elbow allows a gentle bending radius on the copper line set. Each elbow is individually packed, and is furnished complete with stainless steel screws.



**230-LFB4**

| CATALOG NO.      | DESCRIPTION                          | UOM | ORDER MULTIPLE |
|------------------|--------------------------------------|-----|----------------|
| <b>230-LFB3</b>  | 3" 90 degree Long Radius Bend        | EA  | 10             |
| <b>230-LFB3B</b> | 3" 90 degree Long Radius Bend, Brown | EA  | 10             |
| <b>230-LFB4</b>  | 4" 90 degree Long Radius Bend        | EA  | 10             |
| <b>230-LFB4B</b> | 4" 90 degree Long Radius Bend, Brown | EA  | 10             |
| <b>230-LFB6</b>  | 6" 90 degree Long Radius Bend        | EA  | 10             |

**90° Inside Elbow**

90° inside elbows are used to route the SpeediChannel™ around an inside corner. Each elbow is individually packed, and is furnished complete with stainless steel screws.



**230-EB3**



| CATALOG NO.     | DESCRIPTION                      | UOM | ORDER MULTIPLE |
|-----------------|----------------------------------|-----|----------------|
| <b>230-EB3</b>  | 3" 90 degree Inside Elbow        | EA  | 10             |
| <b>230-EB3B</b> | 3" 90 degree Inside Elbow, Brown | EA  | 10             |
| <b>230-EB4</b>  | 4" 90 degree Inside Elbow        | EA  | 10             |
| <b>230-EB4B</b> | 4" 90 degree Inside Elbow, Brown | EA  | 10             |
| <b>230-EB6</b>  | 6" 90 degree Inside Elbow        | EA  | 10             |

**Union Coupling**

Used for joining two pieces of SpeediChannel™ — each cover being the same size. Each coupling is individually packed, and is furnished complete with stainless steel screws.



**230-CP3**



| CATALOG NO.     | DESCRIPTION              | UOM | ORDER MULTIPLE |
|-----------------|--------------------------|-----|----------------|
| <b>230-CP3</b>  | 3" Union Coupling        | EA  | 10             |
| <b>230-CP3B</b> | 3" Union Coupling, Brown | EA  | 10             |
| <b>230-CP4</b>  | 4" Union Coupling        | EA  | 10             |
| <b>230-CP4B</b> | 4" Union Coupling, Brown | EA  | 10             |
| <b>230-CP6</b>  | 6" Union Coupling        | EA  | 10             |

**45° Flat Bend**

45° flat bends are used to route the SpeediChannel™ around an obstacle. Each bend is individually packed, and is furnished complete with stainless steel screws.



**230-FB453**

| CATALOG NO.       | DESCRIPTION                   | UOM | ORDER MULTIPLE |
|-------------------|-------------------------------|-----|----------------|
| <b>230-FB453</b>  | 3" 45 degree Flat Bend        | EA  | 10             |
| <b>230-FB453B</b> | 3" 45 degree Flat Bend, Brown | EA  | 10             |
| <b>230-FB454</b>  | 4" 45 degree Flat Bend        | EA  | 10             |
| <b>230-FB454B</b> | 4" 45 degree Flat Bend, Brown | EA  | 10             |
| <b>230-FB456</b>  | 6" 45 degree Flat Bend        | EA  | 10             |

**90° Outside Elbow**

90° outside elbows are used to route the SpeediChannel™ around an outside corner. Each elbow is individually packed, and is furnished complete with stainless steel screws.



**230-EIN3**



| CATALOG NO.      | DESCRIPTION                       | UOM | ORDER MULTIPLE |
|------------------|-----------------------------------|-----|----------------|
| <b>230-EIN3</b>  | 3" 90 degree Outside Elbow        | EA  | 10             |
| <b>230-EIN3B</b> | 3" 90 degree Outside Elbow, Brown | EA  | 10             |
| <b>230-EIN4</b>  | 4" 90 degree Outside Elbow        | EA  | 10             |
| <b>230-EIN4B</b> | 4" 90 degree Outside Elbow, Brown | EA  | 10             |
| <b>230-EIN6</b>  | 6" 90 degree Outside Elbow        | EA  | 10             |

**T-Joint**

Used for creating a tee connection between three pieces of SpeediChannel™ — all covers being the same size. The tee can be combined with the reducing coupling to join SpeediChannel™s of different sizes. Each tee is individually packed, and is furnished complete with stainless steel screws.



**230-TJ4**



| CATALOG NO.     | DESCRIPTION       | UOM | ORDER MULTIPLE |
|-----------------|-------------------|-----|----------------|
| <b>230-TJ4</b>  | 4" T-Joint        | EA  | 10             |
| <b>230-TJ4B</b> | 4" T-Joint, Brown | EA  | 10             |
| <b>230-TJ6</b>  | 6" T-Joint        | EA  | 10             |

**FITTINGS cont'd**

**Flex Joint**

An accordion style piece of SpeediChannel™, the flex joint can be extremely flexible routing a SpeediChannel™ system around virtually any type of obstacle. Each joint is 20" long and can be combined together for longer flex runs. Unlike competitor systems, the DiversiTech flex joint does NOT require the use of a union coupling. The DiversiTech flex joint slides tightly inside the SpeediChannel™ system.



**230-FJ3**

| CATALOG NO.    | DESCRIPTION   | UOM | ORDER MULTIPLE |
|----------------|---------------|-----|----------------|
| <b>230-FJ3</b> | 3" Flex Joint | EA  | 10             |
| <b>230-FJ4</b> | 4" Flex Joint | EA  | 10             |

**Duct End**

The duct end is used to terminate a run of SpeediChannel™ to a small opening – just large enough for the line set and condensate drain line to pass through. Gives a neat/clean installation.



**230-DE3 230-DE4**



| CATALOG NO.     | DESCRIPTION        | UOM | ORDER MULTIPLE |
|-----------------|--------------------|-----|----------------|
| <b>230-DE3</b>  | 3" Duct End        | EA  | 10             |
| <b>230-DE3B</b> | 3" Duct End, Brown | EA  | 10             |
| <b>230-DE4</b>  | 4" Duct End        | EA  | 10             |
| <b>230-DE4B</b> | 4" Duct End, Brown | EA  | 10             |
| <b>230-DE6</b>  | 6" Duct End        | EA  | 10             |

**Flat Wall Escutcheon**

Typically used to cover a rough opening in a soffit, wall, or ceiling penetration. One side of the escutcheon is flat to allow for a SpeediChannel™ run going along a wall, and penetrating through an adjacent wall or ceiling. This is the most common type of wall penetration. Furnished in two parts, the escutcheon easily snaps onto the SpeediChannel™.



**230-FR3**



| CATALOG NO.    | DESCRIPTION             | UOM | ORDER MULTIPLE |
|----------------|-------------------------|-----|----------------|
| <b>230-FR3</b> | 3" Flat Wall Escutcheon | EA  | 10             |
| <b>230-FR4</b> | 4" Flat Wall Escutcheon | EA  | 10             |
| <b>230-FR6</b> | 6" Flat Wall Escutcheon | EA  | 10             |

**Reducer Coupling**

Used for joining two pieces of SpeediChannel™ — each cover being a different size. Each coupling is individually packed, and is furnished complete with stainless steel screws.



**230-TC34**



| CATALOG NO.     | DESCRIPTION              | UOM | ORDER MULTIPLE |
|-----------------|--------------------------|-----|----------------|
| <b>230-TC34</b> | 3" x 4" Reducer Coupling | EA  | 10             |
| <b>230-TC46</b> | 4" x 6" Reducer Coupling | EA  | 10             |

**Cap**

Used to cap the end of a SpeediChannel™ run. Easily snaps into the end of the SpeediChannel™.



**230-DC3**

| CATALOG NO.    | DESCRIPTION | UOM | ORDER MULTIPLE |
|----------------|-------------|-----|----------------|
| <b>230-DC3</b> | 3" Cap      | EA  | 10             |
| <b>230-DC4</b> | 4" Cap      | EA  | 10             |
| <b>230-DC6</b> | 6" Cap      | EA  | 10             |

**Wall Escutcheon**

Typically used to cover a rough opening in a wall or ceiling penetration. The hole in the escutcheon is centered to allow for a free standing SpeediChannel™ to penetrate through a wall or ceiling. This is the fairly un-common type of wall or ceiling penetration. Check carefully, as you may need the Flat Wall Escutcheon. Furnished in two parts, the escutcheon easily snaps onto the SpeediChannel™.



**230-WR3**

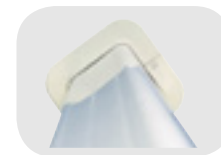

| CATALOG NO.    | DESCRIPTION        | UOM | ORDER MULTIPLE |
|----------------|--------------------|-----|----------------|
| <b>230-WR3</b> | 3" Wall Escutcheon | EA  | 10             |
| <b>230-WR4</b> | 4" Wall Escutcheon | EA  | 10             |
| <b>230-WR6</b> | 6" Wall Escutcheon | EA  | 10             |

**FITTINGS** cont'd

**SpeediChannel™ Accessories**

A variety of accessories that are complementary or required for installing DiversiTech's SpeediChannel™ system.

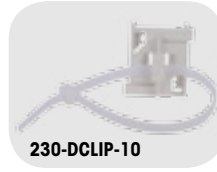

| CATALOG NO.         | DESCRIPTION                                | UOM | ORDER MULTIPLE |
|---------------------|--|-----|----------------|
| <b>230-DCLIP-10</b> | SpeediClip™ and 11" Cable Ties, pack of 10 | PK  | 1              |
| <b>230-DCLIP</b>    | *SpeediClip™, pack of 50                   | PK  | 1              |
| <b>230-DSCREW</b>   | SpeediChannel™ screws, pack of 100         | PK  | 1              |
| <b>WTB11C</b>       | Black Wire Ties – 11", pack of 100         | PK  | 1              |

**Universal Pump Elbow**

The Universal Pump Elbow lets an installer use any mini pump of their choice and install it with SpeediChannel. Includes pump elbow and reservoir mounting brackets to fit most mini-split pumps.



| CATALOG NO.     | DESCRIPTION          | UOM | ORDER MULTIPLE |
|-----------------|----------------------|-----|----------------|
| <b>230-PFB3</b> | Universal Pump Elbow | EA  | 1              |

**SpeediChannel™ Kits**

The SpeediChannel™ Fitting Kit provides a simple mix of the basic fittings used in a typical SpeediChannel™ installation job. Included are one coupling, one wall penetration, one inside elbow, one long radius flat bend, and one pack of ten SpeediClips and 11" cable ties. The 230-IKC3 and 230-IKC4 Installation Kits include three 48" pieces of channel and selected fittings.



| CATALOG NO.     | DESCRIPTION                        | UOM | ORDER MULTIPLE |
|-----------------|------------------------------------|-----|----------------|
| <b>230-IK3</b>  | 3" SpeediChannel™ Fitting Kit      | EA  | 1              |
| <b>230-IK4</b>  | 4" SpeediChannel™ Fitting Kit      | EA  | 1              |
| <b>230-IKC3</b> | 3" SpeediChannel™ Installation Kit | EA  | 1              |
| <b>230-IKC4</b> | 4" SpeediChannel™ Installation Kit | EA  | 1              |

**ROOF INLETS**

**Roof Inlets**

"Roof entrance" adapters for linesets are the ultimate solution for a professional flat roof installation. Manufactured from UV weather resistant plastics, the Roof Inlet combines a series of features:

- The Roof Inlet body part is equipped with a slope avoiding possible damage to the insulation and preventing kinks into the copper tubes.
- The Roof Inlet base holes allow a steady fixation (depending on the roof surface type and composition).
- The Roof Inlet cap is firmly fixed to the body with stainless steel bolts.



| CATALOG NO.       | DESCRIPTION                     | UOM | ORDER MULTIPLE |
|-------------------|---------------------------------|-----|----------------|
| <b>230-INJ462</b> | SpeediChannel™ Roof Inlet – 10" | EA  | 2              |



# MAINTENANCE CHEMICALS

|   |         |
|---|---------|
| Accessories .....                                   | 221     |
| Additives .....                                     | 230     |
| Coil Cleaners .....                                 | 220-221 |
| Coil Cleaning Aerosols .....                        | 222     |
| Drain Pan Disinfectant .....                        | 222     |
| Flushing Products .....                             | 223     |
| Glycols .....                                       | 222-223 |
| Hoses, Sprayers .....                               | 224     |
| Ice Machine Products .....                          | 225     |
| Leak Detectors and Accessories .....                | 225-226 |
| Leak Sealants .....                                 | 226     |
| Maintenance Chemical Quick Reference<br>Guide ..... | 218-219 |
| Odor Neutralizers .....                             | 227     |
| Pan Treatments/Disinfectants .....                  | 227-228 |
| Refrigeration Oils .....                            | 228-229 |
| System Cleaners .....                               | 229     |
| Test Kits .....                                     | 229     |
| Thread Sealants .....                               | 230     |
| Vacuum Pump Oil .....                               | 230     |



# Triple-D® Universal Coil Cleaner

Triple-D is a Universal Coil Cleaner suitable for use on condenser and evaporator coils. It is metal safe and does not attack aluminum or copper coil components, extending equipment life and diminishing potential for refrigerant leaks. Triple-D is a more versatile product than conventional acid or non-acid coil cleaners. One product does it all — truly a Universal Coil Cleaner.

## FEATURES

## BENEFITS

**Universal Coil Cleaner** One product for multiple applications reduces inventory and eliminates potential product mis-application.

**Metal Compatible** Conventional foaming acid coil cleaners actually attack and chemically react with the aluminum coil components. This reaction is exhibited by a foaming action. Conventional foaming non-acid coil cleaners are so strong (because they lack the unique inhibitor in Triple-D) they also attack the aluminum coil components. The attack/reaction dissolves the aluminum, destroying the heat-transfer ability of the coil, and creates the potential for refrigerant leaks. Over time, the reduction in heat transfer ability for the coil increases energy consumption significantly.

**Super Concentrated** Lower cost per mixed gallon. Triple-D is a 6:1 dilution ratio, making 7 gallons of usable product per gallon of concentrate.

**Multiple Packages/Forms** Available as a concentrated liquid, pre-diluted liquid, aerosol, or Granular Coil Cleaner. Same product — different packages.

**NSF Registered** Assurance that Triple-D is an ideal cleaner for restaurants, hospitals, government institutions, and any food preparation area. Rinse thoroughly after use.

**Safe for Rubber Roofs** Does not damage engineered polymeric or rubber roofing.

**Corrosion Inhibited** Conventional foaming acid and non-acid coil cleaners actually attack and chemically react with the aluminum (and sometimes copper) coil components. This reaction is exhibited by a foaming action. The reaction dissolves the aluminum, destroying the heat-transfer ability of the coil, creating the potential for refrigerant leaks.

**Biodegradable** Triple-D is manufactured from chemicals that break down naturally in the environment. When a coil is cleaned, the rinse water is typically washed away.

**Non-Foaming** Foaming of coil cleaners is exhibited when the cleaner chemically reacts with the aluminum (and sometimes the copper) coil components. This reaction is exhibited by a foaming action. The reaction dissolves the aluminum, destroying the heat-transfer ability of the coil, and creates the potential for refrigerant leaks. Additionally, foaming action on foaming coil cleaners is an exothermic (heat generating) chemical reaction. This heat is extreme and can damage coils.

**Non-Toxic** Triple-D is manufactured from chemicals that break down naturally in the environment. When a coil is cleaned, the rinse water is typically washed away. Conventional acid coil cleaners contain dangerous hydrofluoric acid that is extremely toxic to humans and animals.

**Inhibited Non-Acid Formulation** Triple-D contains a unique inhibitor that allows for a very strong alkaline (non-acid) formulation that effectively cleans coils. Other non-acid coil cleaners are either too weak to effectively clean a coil, or are so strong (and hence foaming) that they attack the aluminum coil.

## Aluminum Loss of Foaming Coil Cleaners vs. Triple-D®

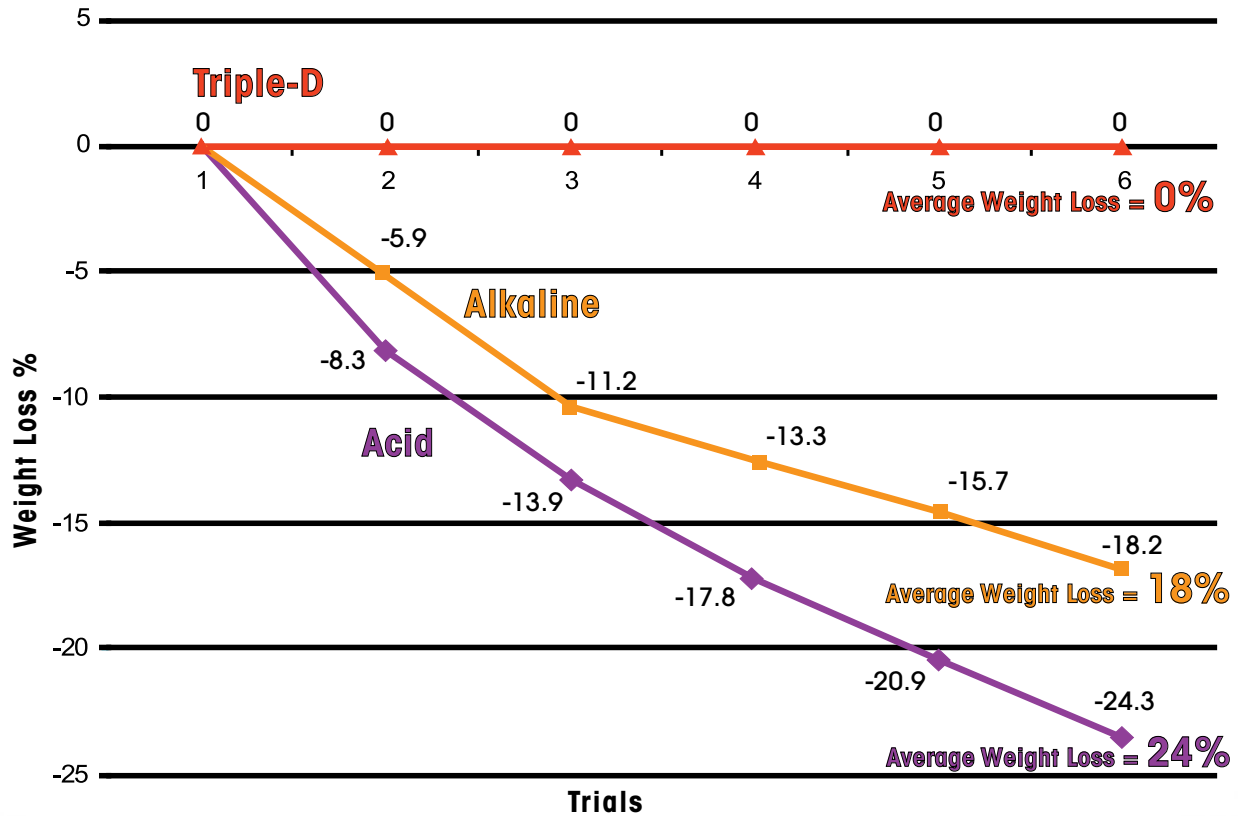

As shown above, conventional foaming acid coil cleaners and foaming non-acid coil cleaners actually attack and chemically react with the aluminum coil components. This reaction is exhibited by a foaming action. The attack/reaction dissolves the aluminum, destroying the heat-transfer ability of the coil creating the potential for refrigerant leaks.





# SUPER SEAL FLEX INJECT<sup>®</sup>

## STOPS LEAKS PERMANENTLY



### FASTEST - EASIEST - PROVEN

DiversiTech introduces Super Seal Flex Inject, a NEW refrigerant leak sealant solution that will save both Contractors and Home Owners time and money!



#### 3X SEALING POWER

Patent pending Flex Inject triple power sealant is the fastest, most effective proven way to permanently seal and prevent air conditioning and refrigeration (HVAC/R) leaks



#### NO TOOLS REQUIRED

Flex Inject installs in seconds - no tools or gauges required. The Flex Inject sealant goes to work immediately traveling through the system with both the oil and refrigerant stopping leaks dead in their tracks.



#### COMPATIBLE WITH ALL OILS & REFRIGERANTS

Works with all compressors, heat pumps, condensers, recovery units, and other system components. Will not plug up manifold gauges, TXVs, pistons or cap tubes.

Compatible with all oils and refrigerants including R-410A requiring no pump down or recovery.



#### POLYMER FREE

The polymer free formula has unique metal bonding properties that create a permanent protective barrier to keep the refrigerant from escaping and is microchannel friendly.

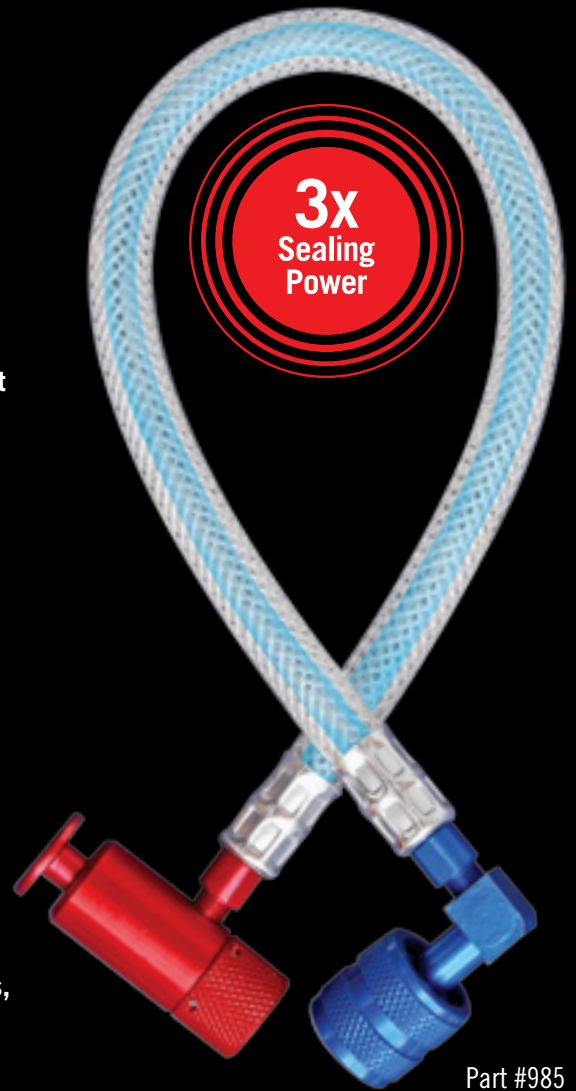

Part #985  
Patent Pending

ALL SYSTEMS | UP TO 20KW

UP TO **6 TONS**

[www.diversitech.com/flexinject](http://www.diversitech.com/flexinject)  
800.995.2222





# Super Seal Flex Inject®



**No manifold gauge  
or hoses needed  
Just Connect HI & LOW -  
PUSH TO GO!**

## QUICK & EASY INSTALLATION: INSTALL INTO FULLY-CHARGED SYSTEM

1. Ensure system is running.
2. Connect the red push button valve to the high side service port.\*
3. Connect the blue low loss fitting to the low side service port.
4. Remove puck and press red button for 3 to 5 seconds to inject sealant.
5. Once sealant is dispensed, disconnect red push button valve from system.
6. Remove blue low loss fitting from system.

### NO SYSTEM RUN TIME REQUIRED AFTER INJECTION

\*IF NO HIGHSIDE PORT IS AVAILABLE - ATTACH RED PUSH BUTTON VALVE TO A REFRIGERANT CYLINDER & FOLLOW STEPS 3-6.

## FREE MERCHANDISER AVAILABLE\*



ITEM# MKT-MERCH-FLEX

## WHY SUPER SEAL FLEX INJECT IS THE OBVIOUS CHOICE

| Feature                         | DiversiTech Super Seal Flex Inject   | Nu-Calgon EasySeal Direct Inject |
|---------------------------------|--|----------------------------------|
| Sealant Power                   | Triple   | Single                           |
| Hose                            | Flexible   | Rigid                            |
| Equipment Required              | None   | Manifold Gauge and Hoses         |
| Sealant-Refrigerant Integration | No Run Time Required   | 60 Minutes with System Running   |
| Valve Protection                | Push Button Valve Allows for a Controlled Refrigerant Flow with Automatic Shut Off | One Way Check Valve              |
| Compressor Protection           | Misting Orifice Prevents Liquid Slugging   | None                             |

## REFRIGERANT LEAK SEALANT SOLUTION PART NUMBER CONVERSION TABLE

| DiversiTech  |        | Nu-Calgon   |         |
|--|--------|---|---------|
| PRODUCT  | PART # | PRODUCT   | PART #  |
| Super Seal Flex Inject with Integrated Hose - Up to 6 tons | 985    | EasySeal-SS Direct Inject – Fractional to 1.5 tons  | 4050-05 |
|  |        | EasySeal Direct Inject – 6 pc. BULK – 1.5 to 5 tons | 4050-07 |
|  |        | EasySeal Direct Inject – 1.5 to 5 tons              | 4050-08 |

\*REQUIRES TWO SIX PACK ORDERS AT TIME OF PURCHASE; LIMITED TO 200

# Pro-Flush® HVAC Flushing Solvent

***Pro-Flush® answers your need for a professional quality flushing solvent with the components to match.***

- Formulated for R-410A retrofits, refrigerant conversions and compressor burnouts
- Lower cost solution than competitive pre-charged kits
- Solvents are non-VOC, conform to EPA SNAP standards, and are non-HAZMAT
- Low toxicity and residue free
- Flash Point: No flash point to boiling (41°C/106°F) - TAG Closed Cup (per ASTM D-56)
- Kit includes reusable tank with a pressure relief valve for added safety, a hose, and an injector trigger nozzle
- Better delivery system



## FREQUENTLY ASKED QUESTIONS

**Q: What refrigerants is Pro-Flush® compatible with?**

**A:** Pro-Flush® is compatible with CFC and HFC refrigerants and compressor oils.

**Q: Is Pro-Flush® safe to use?**

**A:** Pro-Flush® is safe, nontoxic, and residue free. In addition, Pro-Flush® conforms to EPA's Significant New Alternatives Program (SNAP) standards.

**Q: Is Pro-Flush® HAZMAT?**

**A:** Pro-Flush® is not HAZMAT for storage or ground transportation.

**Q: What is the advantage of the reusable injector tank?**

**A:**

1. The reusable tank lowers cost since you only need to buy the Pro-Flush® refill cans.
2. Pre-charged cans include refrigerant propellants which are more expensive to use than nitrogen.
3. The trigger assembly allows for infinite control of dosage insuring more economical use of the solvent.
4. Using nitrogen as the propellant is less expensive and more environmentally friendly than using HFC-134A. HFC-134A is a powerful greenhouse gas. One kilogram of HFC-134A has the same global warming impact as 1,430 kilograms of carbon dioxide (<http://www.epa.gov/cpd/mac/service>).

**Q: Can the injector tank be over pressurized during nitrogen pressurization?**

**A:** Over pressurization is highly unlikely but possible. The injector valve has a reseating pressure relief safety valve set at 200 psi. This helps prevent potential bursting and resultant injury.

**Q: What if I don't require the entire can of Pro-Flush® Solvent to clean a system or line set?**

**A:** The injection nozzle allows you to control the dose rate and any left over solvent can be stored in the injector for future use.

**Q: How does the dose rate for Pro-Flush® for burnouts and retrofits compare with the competitors?**

**A:** For R22 to 410A conversions, we recommend 3-second bursts of solvent. An 8 oz. can of Pro-Flush™ will treat up to 250 feet of liquid line. For burnouts, we recommend 2-3 oz. per ton. Pro-Flush™ uses less solvent per application than Nu-Calgon. Treatment results will vary depending on the application and conditions of the line set when serviced.

**Q: Why do you recommend only charging the injector tank to 50psi, then injecting in 3 second bursts?**

**A:** Tests are conclusive that injecting the solvent at lower pressure assures longer solvent to oil contact time. In addition, the smaller volume delivered in short bursts assists in completely dissolving contaminants. In this case, less is better.

**Q: Is nitrogen necessary for use with Pro-Flush®?**

**A:** Nitrogen is used as the propellant for Pro-Flush®. Nitrogen is required with all flushing systems to purge any residual solvent and contaminants through the system.

**Q: Do pre-charged canister systems dispense 100% of the flushing solvent?**

**A:** In many cases pre-charged canister systems will not fully dispense the flushing solvent depending on temperature. At lower temperatures, the R-134a propellant provides less pressure and may leave solvent in the canister. The Pro-Flush® system allows contractors to add additional nitrogen if there is still solvent left, regardless of temperature.



# SEAL-N-GO<sup>®</sup>

## SELF-SEALING REFRIGERANT<sup>™</sup>

### 410A + SUPER SEAL **ADVANCED**<sup>™</sup>



9410SSR\*

#### HOW DOES SEAL-N-GO WORK?

SEAL-N-GO makes charging 410A systems faster & easier than ever. Portable, easy to handle, self-sealing refrigerant, permanently seals & prevent leaks.

#### ADDED BENEFITS

- Light-weight, compact, portable
- Tops off multiple systems
- Perfect for mini-split installs
- Permanently seals & prevent leaks
- Eliminates moisture

**FAST - EASY - 1 STEP**  
push button application



Reusable charging hose with easy-to-read gauge sold seperately. **20133\***



Self-Sealing Refrigerant



Eliminates Moisture



Time Saver



Equipment Safe



# SUPER CHANGE™

## FAST & EASY R22 SYSTEM RETROFIT

- Eliminates oil change out
- Replaces R22 line set conversion flush
- Ideal for dry charged units, retrofits, & drop-in refrigerants
- Maximizes oil return & heat transfer, including POE charged compressors

### HOW DOES SUPER CHANGE™ WORK?

SUPER CHANGE™ creates a strong compatibility link between all oils to any HFC refrigerants, including POE-based R407C & R410A – eliminating compressor downtime & line set flush. It boosts efficiency plus extends compressor life by maximizing heat transfer & oil return with drop-in refrigerants.



Compatible



Eliminates Moisture



Equipment Safe



Boosts Efficiency

### ADDED BENEFITS

- Reduces oil logging – critical in systems with long line set runs & rises
- Introduces antioxidants to reduce corrosion & restore lubricants
- Rejuvenates O-rings & gaskets – no change out required
- Required hose sold separately



**20122**  
REUSABLE HOSE SOLD SEPARATELY



SOLD AS  
6 PACK  
COUNTER  
DISPLAY



**981\***  
ALL SYSTEMS UP TO 6 TONS

# APPLICATION GUIDE

| SYSTEM TONNAGE                                  | Up to 3 Tons       | 3.5 - 6 Tons       | 6+ Tons        |
|---|--------------------|--------------------|----------------|
| <b>SYSTEM OIL CHARGE</b>                        | <b>Up to 32 oz</b> | <b>Up to 64 oz</b> | <b>128+ oz</b> |
| Conversion not requiring oil change out         | 1 can              | 1 can              | 2 cans/gallon  |
| Conversion requiring oil change out             | 1 can              | 2 cans             | 4 cans/gallon  |
| Conversion to R410A                             | 1 can              | 1 can              | 2 cans/gallon  |
| R22 line set conversion flush                   | 1 can              | 1 can              | 2 cans/gallon  |
| For oil logging or long line set runs and rises | 1 can              | 1 can              | 2 cans/gallon  |

It will take approximately 24 hours of operation for the full effect to be achieved.

# Condensate Pan Treatments – SIMPLIFIED

## THE NEED

Environmental debris, slime, rust, etc. accumulate in condensate drain pans resulting in:

- Indoor Air Quality problems including musty odors and Dirty Sock Syndrome
- Pan overflows caused by plugged drain lines
- Equipment malfunction

## THE SOLUTION

Use pan treatment products as part of a regular preventive maintenance program to:

- Eliminate one of the causes of Sick Building Syndrome
- Stop costly overflow problems that damage floors, ceilings, and furniture
- Reduce unscheduled service calls

## THE PRODUCTS

### EXTENDED RELEASE TREATMENTS

- Several manufacturers produce various time release products
- Highest value — most active ingredient per dollar
- Easiest maintenance program — dose only once every three months or longer
- Only effective solution for equipment larger than six tons

### RAPID RELEASE TREATMENTS

- Lowest cost per tablet
- Shortest time between dosing



Super



Best



Good



Economy

## Flow-Plus™ Condensate Pan Treatment

- A true water activated, time release treatment
- Water soluble polymer leaves no residue or carrier to be removed
- Adheres to drain pans — eliminates product floating and blocking the drain line
- No corrosive vapors — safe for computer rooms
- Recommended dosage — choose size according to equipment tonnage. Each size is designed to last a minimum of three months.

|               |                 |
|---------------|-----------------|
| FLOW-PLUS-25  | — 1/2 to 3 tons |
| FLOW-PLUS-200 | — 1/2 to 3 tons |
| FLOW-PLUS-6   | — 3 to 5 tons   |
| FLOW-PLUS-10  | — 5 to 20 tons  |
| FLOW-PLUS-125 | — 20 to 50 tons |

**STACKABLE!**  
This unique feature increases the time between maintenance visits.

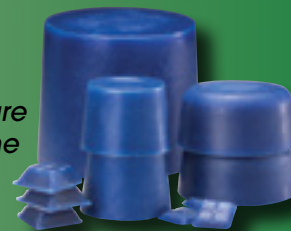

## Pro-Treat® 151 Premium Condensate Drain Pan Treatment

- EPA Registered
- Kills algae and eliminates odors
- Fast acting
- Residual effect of the clean pan lasts for a month
- No corrosive vapors — safe for computer rooms
- Recommended dosage: 1 tablet for every 3 tons each month

## Pro-Treat® 161 Condensate Drain Pan Treatment

- More active ingredient than the economy version
- Fast acting
- Residual effect of the clean pan lasts for about a month
- No corrosive vapors — safe for computer rooms
- Recommended dosage: 2 tablets for every 3 tons each month

## Pro-Treat® 200 Condensate Drain Pan Treatment

- Lowest cost product per tablet
- Sufficient active ingredient to treat the pan
- No corrosive vapors — safe for computer rooms
- Recommended dosage: 3 tablets for every 3 tons each month



# 3-STEP PROCESS for Solving IAQ Problems

1



## STEP 2: DISINFECT

### SANI C-N-D™ Coil and Drain Pan Disinfectant

Disinfect and deodorize the evaporator coil and drain pan with SANI C-N-D™, an EPA registered biocide, fungicide, viricide, and mildewstat. The broad spectrum biocide in SANI C-N-D™ assures control of many airborne pathogens that can be spread via contaminated air handling equipment.

## STEP 1: CLEAN

### TRIPLE-D® Degreaser • Detergent • Deodorant

Clean the evaporator coil and condensate pan with TRIPLE-D, a USDA authorized non-foaming alkaline coil cleaner. Cleaning the dirt from the coil and pan not only improves equipment efficiency, but also removes an important source of contamination that can create slime and sludge in the drain pan and cause pan overflow.



2

*The American Lung Association states that most people spend 90% of their time indoors<sup>1</sup>. DiversiTech offers the 3-STEP PROCESS to help control IAQ problems caused by the micro-organisms in the atmosphere in which we live and work.*

<sup>1</sup>www.lungusa.org



## STEP 3: MAINTAIN

### FLOW-PLUS™ Condensate Pan Treatment

Place FLOW-PLUS™ in the condensate pan (choose size according to equipment tonnage below). FLOW-PLUS™ is a totally soluble long term polymer treatment that keeps the drain pan and condensate lines clean for a minimum of three months. This prevents pan overflow problems.

| PRODUCT NO.   | EQUIPMENT TONNAGE |
|---------------|-------------------|
| FLOW-PLUS-25  | 1/2 to 3 tons     |
| FLOW-PLUS-200 | 1/2 to 3 tons     |
| FLOW-PLUS-6   | 3 to 5 tons       |
| FLOW-PLUS-10  | 5 to 20 tons      |
| FLOW-PLUS-125 | 20 to 50 tons     |

3



### Why clean coils?

#### CONDENSER COIL

Cleaning the condenser coil does one thing — improves the heat transfer efficiency between the refrigerant inside the coil and the ambient air outside. The more efficient this heat transfer, the more efficiently the cooling system operates.

With efficient heat transfer and an efficiently operating condensing unit, the system consumes less energy because it draws less current. By lowering current consumed in the unit, the life of the equipment is extended.

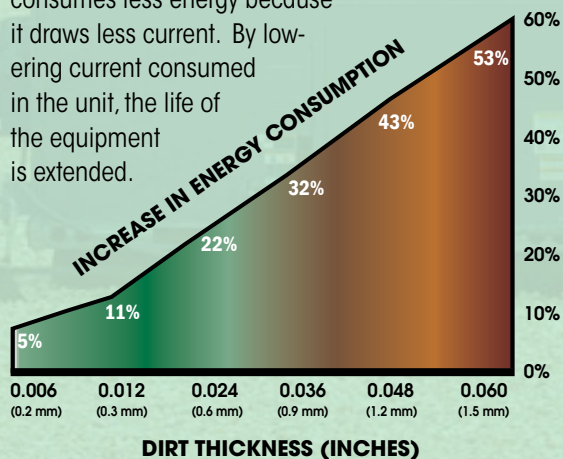

#### EVAPORATOR COIL

Cleaning the evaporator coil improves indoor air quality. It addresses building related illness and sick building syndrome.

### How frequently should coils be cleaned?

We recommend a minimum of twice per year, more frequently if there is dirty ambient air.



# Maintenance Chemical Solution Quick Reference Guide

| EQUIPMENT TYPE  | PRODUCT TYPE                               |              |               |              |
|---|--|--------------|---------------|--------------|
|   | TRIPLE-D                                   | ECO-COIL     | PRO-BROWN     | PRO-BLUE     |
| Condenser Units   | X  | X            | X             | X            |
| (No-Rinse)  |  | X            |               |              |
| Evaporator Units  | X  | X            |               |              |
| (No-Rinse)  | X  | X            |               |              |
| Rubber Roof Tops  | X  |              |               |              |
| Fan Blades, Grilles, Etc.   | X  | X            |               |              |
| Electronic Air Filters  | X  | X            |               |              |
| Permanent Filters   | X  | X            |               |              |
| Microchannel Coils  | X  | X            | X             | X            |
| Small Condenser Coils   | X  | X            | X             | X            |
| Small Evaporator Coils  | X  | X            |               |              |
| Mini-Splits   | X  | X            |               |              |
| <b>APPLICATION SOLUTION</b>   |  |              |               |              |
| Brightener  |  |              | X             | X            |
| Condensate "Gunk"   | X  | X            | X             | X            |
| Degreasing  | X  | X            | X             | X            |
| Deodorizer  | X  | X            |               |              |
| Dirt and Grime  | X  | X            | X             | X            |
| Disinfectant  | USE SANI C-N-D COIL AND DRAIN DISINFECTANT |              |               |              |
| Heresite Coated Coils   |  | X            |               |              |
| Oxide Deposits  |  |              | X             | X            |
| Remove Minerals   |  |              |               |              |
| <b>CHEMICAL TYPE</b>  |  |              |               |              |
| Alkaline  | X  | X            | X             | X            |
| Acidic  |  |              |               |              |
| <b>DILUTION (PRODUCT: H2O)</b>                                      |  |              |               |              |
| Condensers  | 1:6  | 1:3          | 1:3           | 1:3          |
| Evaporators   | 1:10                                       | 1:6          |               |              |
| Evaporators (No-Rinse)  | 1:20                                       | 1:6          |               |              |
| <b>PACKAGING AVAILABLE</b>  |  |              |               |              |
| 19 Ounce Aerosol  | TRIPLE-D-AER                               | ECO-COIL-AER | PRO-BROWN-AER | PRO-BLUE-AER |
| 1 Quart Trigger Sprayer   | TRIPLE-D-RTU                               |              |               |              |
| 32 Oz. Bottle   | TRIPLE-D-32                                | ECO-COIL-32  | PRO-BROWN-32  | PRO-BLUE-32  |
| 1 Gallon  | TRIPLE-D                                   | ECO-COIL     | PRO-BROWN     | PRO-BLUE     |
| 5 Gallon  | TRIPLE-D-5                                 | ECO-COIL-5   | PRO-BROWN-5   | PRO-BLUE-5   |
| 55 Gallon Drum  | TRIPLE-D-55                                | ECO-COIL-55  | PRO-BROWN-55  | PRO-BLUE-55  |
| 1 LB Granular   | TRIPLE-D-GRAN                              |              |               |              |
| <b>ENVIRONMENTAL</b>  |  |              |               |              |
| Biodegradable   | X  | X            | X             | X            |
| Meets EPA's Design for the Environment Alternative Program as Green |  | X            |               |              |
| <b>FOOD COMPLIANCE</b>  |  |              |               |              |
| USDA Approved   | X  | X            |               | X            |
| NSF Registered  | X  | X            |               | X            |

| EQUIPMENT TYPE  | PRODUCT TYPE                               |             |                |              |
|---|--|-------------|----------------|--------------|
|   | PRO-GREEN                                  | PRO-RED+    | PRO-YELLOW     | PRO-KLEEN    |
| Condenser Units<br>(No-Rinse)   | X  | X           | X              | X            |
| Evaporator Units<br>(No-Rinse)  | X  |             |                |              |
| Rubber Roof Tops  |  |             |                |              |
| Fan Blades, Grilles, Etc.   | X  |             |                |              |
| Electronic Air Filters  | X  |             |                |              |
| Permanent Filters   | X  |             |                |              |
| Microchannel Coils  | X  |             |                |              |
| Small Condenser Coils   | X  | X           | X              | X            |
| Small Evaporator Coils  | X  |             |                |              |
| Mini-Splits   | X  |             |                |              |
| <b>APPLICATION SOLUTION</b>   |  |             |                |              |
| Brightener  |  | X           | X              | X            |
| Condensate "Gunk"   | X  | X           | X              | X            |
| Degreasing  |  | X           | X              | X            |
| Deodorizer  |  |             |                |              |
| Dirt and Grime  | X  | X           | X              | X            |
| Disinfectant  | USE SANI C-N-D COIL AND DRAIN DISINFECTANT |             |                |              |
| Heresite Coated Coils   |  |             |                |              |
| Oxide Deposits  |  | X           | X              | X            |
| Remove Minerals   |  |             |                | X            |
| <b>CHEMICAL TYPE</b>  |  |             |                |              |
| Alkaline  | X  | X           | X              |              |
| Acidic  |  |             |                | X            |
| <b>DILUTION (PRODUCT: H2O)</b>  |  |             |                |              |
| Condensers  | 1:3  | 1:3         | 1:2            | 1:3          |
| Evaporators   | 1:3  |             | 1:10           |              |
| Evaporators (No-Rinse)  | 1:3  |             |                |              |
| <b>PACKAGING AVAILABLE</b>  |  |             |                |              |
| 19 Ounce Aerosol  | PRO-GREEN-AER                              | PRO-RED+AER | PRO-YELLOW-AER |              |
| 1 Quart Trigger Sprayer   |  |             |                |              |
| 32 Oz. Bottle   | PRO-GREEN-32                               | PRO-RED+32  | PRO-YELLOW-32  |              |
| 1 Gallon  | PRO-GREEN                                  | PRO-RED+    | PRO-YELLOW     | PRO-KLEEN    |
| 5 Gallon  | PRO-GREEN-5                                | PRO-RED+5   | PRO-YELLOW-5   | PRO-KLEEN-5  |
| 55 Gallon Drum  | PRO-GREEN-55                               | PRO-RED+55  | PRO-YELLOW-55  | PRO-KLEEN-55 |
| 1 LB Granular   |  |             |                |              |
| <b>ENVIRONMENTAL</b>  |  |             |                |              |
| Biodegradable   | X  | X           | X              | X            |
| Meets EPA's Design<br>for the Environment Alternative<br>Program as Green |  |             |                |              |
| <b>FOOD COMPLIANCE</b>  |  |             |                |              |
| USDA Approved   | X  |             |                |              |
| NSF Registered  | X  |             |                |              |

**COIL CLEANERS**

**Triple-D® Universal Coil Cleaner**

Triple-D® is the ultimate universal coil cleaner that can be used on condensers, evaporators, microchannels, roof-top units, and mini-split applications. The triple active synergistic highly effective solution is formulated to remove a broad range of soils while degreasing and deodorizing. It is ideal for cleaning most metals including aluminum and copper while extending equipment life and diminishing the potential for refrigerant leaks. Using 75% less than comparable products, it reduces the amount of solution needed to clean. Triple-D® is biodegradable, NSF approved and available in seven different packaging configurations.

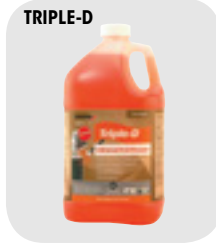

| CATALOG NO.          | DESCRIPTION                                       | UOM | ORDER MULTIPLE |
|----------------------|---|-----|----------------|
| <b>TRIPLE-D</b>      | Triple-D® – 1 gallon concentrate                  | EA  | 4              |
| <b>TRIPLE-D-5</b>    | Triple-D® – 5 gallon concentrate                  | EA  | 1              |
| <b>TRIPLE-D-AER</b>  | Triple-D® – 19 oz. Aerosol                        | EA  | 12             |
| <b>TRIPLE-D-GRAN</b> | Triple-D® – 1 lb. Granular                        | EA  | 12             |
| <b>TRIPLE-D-32</b>   | Triple-D® – 32 oz. bottle – concentrate           | EA  | 12             |
| <b>TRIPLE-D-RTU</b>  | Triple-D® – 1 quart trigger sprayer – pre-diluted | EA  | 12             |
| <b>TRIPLE-D-55</b>   | Triple-D® – 55 gallon drum                        | EA  | 1              |

**Eco-Coil™ Environmentally Friendly Coil Cleaner**

Eco-Coil™ is an environmentally friendly no rinse non-corrosive cleaner ideal for evaporator and condenser coils, electronic and permanent filters, fan blades, grilles, mini-split and microchannel applications. Eco-coil quickly cleans away dirt, dust, and deposits while deodorizing with no harmful risks to animal, aquatic or plant life. Tested to provide the highest level of performance, Eco-Coil not only reduces the number of products required to clean but also has different water mixture ratios to maximize solution usage. Furthermore, it brightens, biodegradable, NSF approved, and meets the EPA's Design for the Environment Alternative Program as a "green" product.



| CATALOG NO.         | DESCRIPTION  | UOM | ORDER MULTIPLE |
|---------------------|--|-----|----------------|
| <b>ECO-COIL-32</b>  | Eco-Coil™ Environmentally Friendly Coil Cleaner – 32 oz. bottle      | EA  | 12             |
| <b>ECO-COIL</b>     | Eco-Coil™ Environmentally Friendly Coil Cleaner – 1 gallon container | EA  | 4              |
| <b>ECO-COIL-5</b>   | Eco-Coil™ Environmentally Friendly Coil Cleaner – 5 gallon pail      | EA  | 1              |
| <b>ECO-COIL-55</b>  | Eco-Coil™ Environmentally Friendly Coil Cleaner – 55 gallon drum     | EA  | 1              |
| <b>ECO-COIL-AER</b> | Eco-Coil™ – 19 oz. Aerosol   | EA  | 1              |

**Pro-Brown™**

Pro-Brown™ is a heavy duty alkaline cleaner that pulls out deeply embedded dirt removing greasy soils and oxidation while brightening and cleaning coils. Ideal for air-cooled condensers, microchannels, and mini-splits thanks to its dual action foaming capabilities. It is biodegradable and NSF approved.



| CATALOG NO.          | DESCRIPTION  | UOM | ORDER MULTIPLE |
|----------------------|--|-----|----------------|
| <b>PRO-BROWN-32</b>  | Pro-Brown™ Foaming Coil Cleaner – 32 oz. bottle      | EA  | 12             |
| <b>PRO-BROWN</b>     | Pro-Brown™ Foaming Coil Cleaner – 1 gallon container | EA  | 4              |
| <b>PRO-BROWN-5</b>   | Pro-Brown™ Foaming Coil Cleaner – 5 gallon pail      | EA  | 1              |
| <b>PRO-BROWN-55</b>  | Pro-Brown™ Foaming Coil Cleaner – 55 gallon drum     | EA  | 1              |
| <b>PRO-BROWN-AER</b> | Pro-Brown™ – 19 oz. Aerosol                          | EA  | 6              |

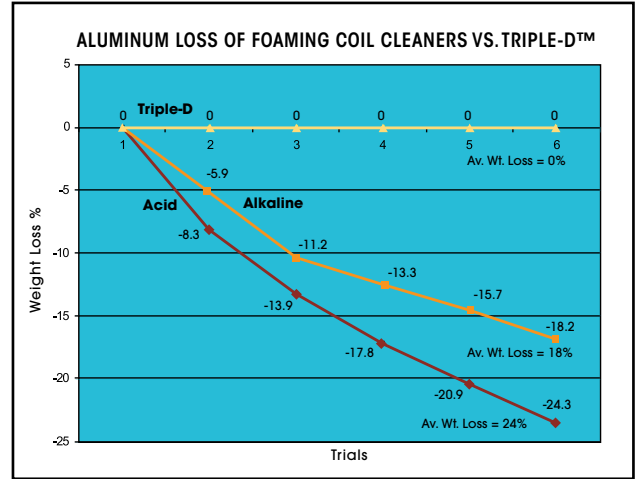

Conventional foaming acid and non-acid coil cleaners attack and chemically react with the aluminum coil components. This reaction is exhibited by a foaming action. The attack/reaction dissolves the aluminum, destroying the heat-transfer ability of the coil and creating the potential for refrigerant leaks.

**Pro-Blue™**

Pro-Blue™ is a heavy foaming alkaline-based solution designed for condensers, microchannels, and mini-splits that penetrates dirt and grease removing deposits resulting in clean and brightened coils. Pro-Blue is biodegradable, NSF approved, and available in numerous packaging configurations.



| CATALOG NO.         | DESCRIPTION   | UOM | ORDER MULTIPLE |
|---------------------|---|-----|----------------|
| <b>PRO-BLUE-32</b>  | Pro-Blue™ Foaming Concentrate (non-acid) – 32 oz. bottle      | EA  | 12             |
| <b>PRO-BLUE</b>     | Pro-Blue™ Foaming Concentrate (non-acid) – 1 gallon container | EA  | 4              |
| <b>PRO-BLUE-5</b>   | Pro-Blue™ Foaming Concentrate (non-acid) – 5 gallon pail      | EA  | 1              |
| <b>PRO-BLUE-55</b>  | Pro-Blue™ Foaming Concentrate (non-acid) – 55 gallon drum     | EA  | 1              |
| <b>PRO-BLUE-AER</b> | Pro-Blue™ – 19 oz. Aerosol                                    | EA  | 6              |

**Pro-Green™**

Pro-Green™ is a no rinse, mild alkaline coil cleaner that can be used on air-cooled condensers, evaporators, electronic and permanent filters, fan blades, grilles, mini-split and microchannel applications. Pro-Green cleans deposits on coils and rids condensate pans of slime. It is NSF approved for use in federally inspected plants and available in numerous packaging configurations.



| CATALOG NO.          | DESCRIPTION  | UOM | ORDER MULTIPLE |
|----------------------|--|-----|----------------|
| <b>PRO-GREEN-32</b>  | Pro-Green™ No Rinse (non-toxic) – 32 oz. bottle      | EA  | 12             |
| <b>PRO-GREEN</b>     | Pro-Green™ No Rinse (non-toxic) – 1 gallon container | EA  | 4              |
| <b>PRO-GREEN-5</b>   | Pro-Green™ No Rinse (non-toxic) – 5 gallon pail      | EA  | 1              |
| <b>PRO-GREEN-55</b>  | Pro-Green™ No Rinse (non-toxic) – 55 gallon drum     | EA  | 1              |
| <b>PRO-GREEN-AER</b> | Pro-Green™ – 19 oz. Aerosol                          | EA  | 6              |



## COIL CLEANERS cont'd

### Pro-Red Plus™

Pro-Red Plus™ is a fast acting cleaning solution for condensers, microchannels, and mini-splits that foams and lifts away stubborn deposits including tarnish and corrosion. Its non-acid formula is as effective as conventional acid cleaners without the use of hydrofluoric acid. The vigorous foaming action eliminates the need for prolonged soaking, steam cleaning or scrubbing coils and without emitting corrosive fumes or rusting ferrous metals. Pro-Red Plus™ is biodegradable, NSF approved, and available in a number of convenient packaging solutions.



| CATALOG NO.        | DESCRIPTION  | UOM | ORDER MULTIPLE |
|--------------------|--|-----|----------------|
| <b>PRO-RED+32</b>  | Pro-Red Plus™ Cleaner and Brightener (non-acid) – 32 oz. bottle      | EA  | 12             |
| <b>PRO-RED+</b>    | Pro-Red Plus™ Cleaner and Brightener (non-acid) – 1 gallon container | EA  | 4              |
| <b>PRO-RED+5</b>   | Pro-Red Plus™ Cleaner and Brightener (non-acid) – 5 gallon pail      | EA  | 1              |
| <b>PRO-RED+55</b>  | Pro-Red Plus™ Cleaner and Brightener (non-acid) – 55 gallon drum     | EA  | 1              |
| <b>PRO-RED+AER</b> | Pro-Red Plus™ – 19 oz. Aerosol                                       | EA  | 6              |

### Pro-Yellow™

Pro-Yellow™ is a powerful cleaner ideal for condensers, microchannels, and mini-splits that targets large concentrations of dirt and grime. With its heavy foaming alkaline-based solution, debris will be removed from the coil while providing excellent brightening. Pro-Yellow is biodegradable, NSF approved and available in a number of packaging solutions.



| CATALOG NO.           | DESCRIPTION                                  | UOM | ORDER MULTIPLE |
|-----------------------|--|-----|----------------|
| <b>PRO-YELLOW-32</b>  | Pro-Yellow™ (non-toxic) – 32 oz. bottle      | EA  | 12             |
| <b>PRO-YELLOW</b>     | Pro-Yellow™ (non-toxic) – 1 gallon container | EA  | 4              |
| <b>PRO-YELLOW-5</b>   | Pro-Yellow™ (non-toxic) – 5 gallon pail      | EA  | 1              |
| <b>PRO-YELLOW-55</b>  | Pro-Yellow™ (non-toxic) – 55 gallon drum     | EA  | 1              |
| <b>PRO-YELLOW-AER</b> | Pro-Yellow™ – 19 oz. Aerosol                 | EA  | 6              |

### Pro-Kleen™

A unique foaming acid coil cleaner designed to replace hazardous hydrofluoric acid coil cleaners. It contains a synergistic combination of mineral acids, corrosion inhibitors, biodegradable surfactants, penetrants, and degreasers that emulsify, solubilize and neutralize soils leaving a clean, bright, efficient coil surface. The easy-rinse formula removes a broad range of soils and does not contain dangerous hydrofluoric or bipotassium phosphate.



| CATALOG NO.         | DESCRIPTION  | UOM | ORDER MULTIPLE |
|---------------------|--|-----|----------------|
| <b>PRO-KLEEN</b>    | Pro-Kleen™ Outdoor Coil Cleaner – 1 gallon container | EA  | 4              |
| <b>PRO-KLEEN-5</b>  | Pro-Kleen™ Outdoor Coil Cleaner – 5 gallon pail      | EA  | 1              |
| <b>PRO-KLEEN-55</b> | Pro-Kleen™ Outdoor Coil Cleaner – 55 gallon drum     | EA  | 1              |

## ACCESSORIES

### Coil Guard™

Ideally used in coastal areas, where salt air accelerates rust and decay. Highly recommended for use in all geographical areas to prolong the life of a unit. When applied properly, Coil Guard™ dries quickly and immediately resists salt spray, alcohol, acids, and soap solutions. Weather will not blacken it. Coil Guard™ has high dielectric properties and has no effect on heat transfer. Our blue tinted product is used to ensure complete coverage of coating.



| CATALOG NO.    | DESCRIPTION                        | UOM | ORDER MULTIPLE |
|----------------|------------------------------------|-----|----------------|
| <b>CG-AER</b>  | Clear Coil Guard™ – 20 oz. Aerosol | EA  | 12             |
| <b>CGB-AER</b> | Blue Coil Guard™ – 20 oz. Aerosol  | EA  | 12             |

### Cool-Weld™ Heat Barrier Spray

Spray on thick gel formula that protects surfaces from heat and damage. Odorless, non-toxic gel coats rubber, plastic, and painted surfaces to shield them during welding or soldering.



| CATALOG NO.        | DESCRIPTION                                      | UOM | ORDER MULTIPLE |
|--------------------|--|-----|----------------|
| <b>COOLWELD-32</b> | Cool-Weld™ Heat Barrier Spray – 32 oz. Container | EA  | 12             |

### Pan-Patch™

Pan-Patch™ is a two part epoxy coating with anti-microbial additives designed for HVAC applications. It is a self leveling formula that is ideal in a damp or wet environment. Pan-Patch™ resists corrosion and stops pan leaks without replacing the pan. Light gray in color, one gallon covers about 160 square feet with 10 mil thickness.



| CATALOG NO.         | DESCRIPTION                              | COVERAGE    | UOM | ORDER MULTIPLE |
|---------------------|--|-------------|-----|----------------|
| <b>PANPATCH-BAG</b> | Pan-Patch™ Pan Sealant – Bag, pack of 10 | 8 sq. ft.   | EA  | 10             |
| <b>PANPATCH</b>     | Pan-Patch™ Pan Sealant – 1 Gallon        | 160 sq. ft. | EA  | 4              |

**COIL CLEANING AEROSOLS**

**Saf-N-Kleen™ Aerosol Solvent Coil Cleaner**

High-solvency formula quickly and easily dissolves dirt, grease, oil or other residue while the blasting nozzle separates the materials from the surface. Non-flammable, non-conductive formula is safe to use on live equipment. Not for use in California.

357-20



| CATALOG NO.   | DESCRIPTION  | UOM | ORDER MULTIPLE |
|---------------|--|-----|----------------|
| <b>357-20</b> | Saf-N-Kleen™ Solvent Coil Cleaner – 18 oz. Aerosol | EA  | 12             |

**Foam-Plus™ Aerosol Foaming Coil Cleaner**

Heavy-duty foaming detergent coil cleaner in an aerosol can. Non-flammable and water-based with no chlorinated solvents. Blasting foam stream reaches into tight areas for maximum cleaning. The foaming alkaline detergent quickly liquifies dirt, grease, oil or other residue and is completely self-rinsing on condensate producing coils.

358-20



| CATALOG NO.    | DESCRIPTION                              | UOM | ORDER MULTIPLE |
|----------------|--|-----|----------------|
| <b>358-20</b>  | Foam-Plus™ Foaming Coil Cleaner – 19 oz. | EA  | 12             |
| <b>358-20S</b> | Foam-Plus™ - Spanish Label - 19 oz.      | EA  | 12             |

**DRAIN PAN DISINFECTANT**

**Sani C-N-D™ Coil and Drain Pan Disinfectant**

Sani C-N-D™ is an EPA registered disinfectant, fungicide, mildewstat and viricide. It is ready-to-use and assures consistent, effective results. Sani C-N-D™ destroys "dirty sock," mildew and other malodors.

SANI-CND



| CATALOG NO.        | DESCRIPTION                                 | UOM | ORDER MULTIPLE |
|--------------------|---|-----|----------------|
| <b>SANI-CND-32</b> | Sani C-N-D™ Disinfectant – 32 oz. Container | EA  | 12             |
| <b>SANI-CND</b>    | Sani C-N-D™ Disinfectant – 1 Gal. Container | EA  | 4              |
| <b>SANI-CND-5</b>  | Sani C-N-D™ Disinfectant – 5 Gallon Pail    | EA  | 1              |
| <b>SANI-CND-55</b> | Sani C-N-D™ Disinfectant – 55 Gallon Drum   | EA  | 1              |

**Pan-Kote Heavy Duty Drain Pan Patch**

A super-durable rubberized coating used to fill-in and patch HVAC drain pans. Seals out rust and corrosion. Stays flexible in variable weather conditions.

641-14



| CATALOG NO.   | DESCRIPTION                               | UOM | ORDER MULTIPLE |
|---------------|---|-----|----------------|
| <b>641-14</b> | Pan-Kote Drain Pan Patch – 14 oz. Aerosol | EA  | 12             |

**GLYCOLS**

DiversiTech produces the most complete line of industrial coolant and heat transfer products in the HVAC/R Industry. Our product line includes ProTek PG propylene glycol products formulated with food-grade corrosion inhibitors and ProTek EG ethylene glycol products for industrial applications. Both product groups are designed to provide freeze and burst protection and are formulated with inhibitors and antifoam agents to provide long-term stability against system corrosion and fouling.

**ProTek EG™**

An inhibited ethylene glycol based heat transfer fluid designed for use in hydronic, chilled and closed water.

| CATALOG NO.  | DESCRIPTION                 | GLYCOL/WATER RATIO | UOM | ORDER MULTIPLE |
|--------------|-----------------------------|--------------------|-----|----------------|
| <b>EG</b>    | ProTek EG™ – 1 Gallon Jug   | 95/5               | EA  | 4              |
| <b>EG-5</b>  | ProTek EG™ – 5 Gallon Pail  | 95/5               | EA  | 1              |
| <b>EG-55</b> | ProTek EG™ – 55 Gallon Drum | 95/5               | EA  | 1              |



**ProTek™ Closed Loop Heat Transfer Fluid**

ProTek™ for closed loop water recirculation systems is a blue liquid. Available in three concentrations: original ProTek-100™, ProTek-50™, and ProTek-Plus™. Each concentration may be further diluted to alter freeze and burst temperatures. Refer to the technical data sheet for specific information.

PG-50



| CATALOG NO.     | DESCRIPTION                 | GLYCOL/WATER RATIO | UOM | ORDER MULTIPLE |
|-----------------|-----------------------------|--------------------|-----|----------------|
| <b>PG-50</b>    | ProTek-50™ – 1 Gallon Jug   | 35/65              | EA  | 4              |
| <b>PG-50-5</b>  | ProTek-50™ – 5 Gallon Pail  | 35/65              | EA  | 1              |
| <b>PG-50-55</b> | ProTek-50™ – 55 Gallon Drum | 35/65              | EA  | 1              |

**ProTek™ PG 100**

ProTek 100™ is an inhibited propylene glycol based industrial heat transfer fluid and antifreeze that contains food grade corrosion inhibitors. It is suitable for use in potable water systems. ProTek 100™ is designed to provide freeze and burst protection, excellent thermal conductance, protection against corrosion and fouling and long term stability in closed recirculating water loops. ProTek 100™ provides burst protection to 100°F. Freeze points and burst points are controlled by the propylene glycol to water ratio.

PG-100



| CATALOG NO.      | DESCRIPTION                  | GLYCOL/WATER RATIO | UOM | ORDER MULTIPLE |
|------------------|------------------------------|--------------------|-----|----------------|
| <b>PG-100</b>    | ProTek-100™ – 1 Gallon Jug   | 70/30              | EA  | 4              |
| <b>PG-100-5</b>  | ProTek-100™ – 5 Gallon Pail  | 70/30              | EA  | 1              |
| <b>PG-100-55</b> | ProTek-100™ – 55 Gallon Drum | 70/30              | EA  | 1              |

### ProTek™ PG Plus

ProTek PLUS™ is an inhibited propylene glycol based industrial heat transfer fluid and anti freeze that contains food grade corrosion inhibitors. It is suitable for use in potable water systems. ProTek PLUS™ is designed to provide freeze and burst protection, excellent thermal conductance, protection against corrosion and fouling and long term stability in closed recirculating water loops. ProTek PLUS™ must be mixed with water to provide freeze and burst protection. Freeze points and burst points are controlled by the propylene glycol to water ratio.



| CATALOG NO.       | DESCRIPTION                   | GLYCOL/<br>WATER RATIO | UOM | ORDER<br>MULTIPLE |
|-------------------|-------------------------------|------------------------|-----|-------------------|
| <b>PG-PLUS</b>    | ProTek-Plus™ – 1 Gallon Jug   | 95/5                   | EA  | 4                 |
| <b>PG-PLUS-5</b>  | ProTek-Plus™ – 5 Gallon Pail  | 95/5                   | EA  | 1                 |
| <b>PG-PLUS-55</b> | ProTek-Plus™ – 55 Gallon Drum | 95/5                   | EA  | 1                 |

### ProTek BG™ for Cast Iron Water Boilers

A red liquid boiler grade product formulated specifically with corrosion inhibitors necessary for use in water boilers.



| CATALOG NO.     | DESCRIPTION                 | GLYCOL/<br>WATER RATIO | UOM | ORDER<br>MULTIPLE |
|-----------------|-----------------------------|------------------------|-----|-------------------|
| <b>PG-BG</b>    | ProTek-BG™ – 1 Gallon Jug   | 70/30                  | EA  | 4                 |
| <b>PG-BG-5</b>  | ProTek-BG™ – 5 Gallon Pail  | 70/30                  | EA  | 1                 |
| <b>PG-BG-55</b> | ProTek-BG™ – 55 Gallon Drum | 70/30                  | EA  | 1                 |

## FLUSHING PRODUCTS

### Pro-Flush® HVAC Flushing Solvent

A flushing solvent for A/C and refrigeration systems formulated for R410A retrofits, refrigerant conversions and compressor burnouts. Compatible with all refrigerants and compressor oils. All solvents in Pro-Flush® are non VOC and conform to EPA SNAP standards: low toxicity and residue free. Available as a kit or in an 8 or 16 oz. solvent refill. The kit makes servicing quick, easy, and safe, as well as assuring you get to the job site with all necessary hardware in hand for 1 stop servicing. The kit includes: 8 oz. container of Pro-Flush® solvent, refillable Pro-Flush® injector tool pressure tank, pressure relief valve for added safety, large rubber adapter that flushes up to 1-1/4" line sets, service hose.



| CATALOG NO.       | DESCRIPTION  | UOM | ORDER<br>MULTIPLE |
|-------------------|--|-----|-------------------|
| <b>PF-KIT</b>     | Pro-Flush® Kit – injector, 8 oz. refill, nozzle adapter and hose | EA  | 3                 |
| <b>PF-08</b>      | Pro-Flush® HVAC Flushing Solvent – 8 oz. Refill                  | EA  | 6                 |
| <b>PF-16</b>      | Pro-Flush® HVAC Flushing Solvent – 16 oz. Refill                 | EA  | 6                 |
| <b>PF-ADAPTER</b> | Pro-Flush® Line Set Adapter                                      | EA  | 1                 |
| <b>PF-IGUN</b>    | Replacement Injector Tool  | EA  | 1                 |
| <b>PF-IHOSE</b>   | 2' Replacement Hose  | EA  | 1                 |

### Super Change™

Super Change eliminates oil change outs replacing R22 line set conversion flushes. Ideal for dry charged units, retrofits, and drop-in refrigerants, Super Change maximizes oil return and heat transfer including POE charged compressors. Reusable hose (20122) sold separately.



| CATALOG NO.  | DESCRIPTION                              | UOM | ORDER<br>MULTIPLE |
|--------------|--|-----|-------------------|
| <b>981</b>   | Super Change™ - Up to 6 Tons             | EA  | 6                 |
| <b>20122</b> | Reusable Charging Hose for Super Change™ | EA  | 1                 |

**HOSES, SPRAYERS**

**Power Sprayer**

DiversiTech's Power Sprayer makes coil cleaning easier and faster! Designed as a backpack sprayer, it holds up to 4 gallons of coil cleaning solution. The battery powered unit will spray continuously for 10 hours on a single charge. Included are three different nozzles to give you the right spray for any situation. It also features: padded backpack straps for a comfortable fit, plug-in charger for fast recharging, a convenient center mount handle, an extra long spray wand with curved tip for accurate application, and a large on/off valve which can lock in position for easier spraying of big jobs. The large tank opening also makes it easy to add coil cleaner and mix to the correct ratio. The Power Sprayer is compatible with all DiversiTech coil cleaners.



| CATALOG NO. | DESCRIPTION   | UOM | ORDER MULTIPLE |
|-------------|---|-----|----------------|
| <b>PS-1</b> | Battery powered/rechargeable backpack sprayer for coil cleaning | EA  | 1              |

**Dial-a-Mix Sprayer**

Save time and money by dialing in the exact mix ratio to properly clean the coil. This sprayer features 5 mix ratios, a 1/2 gallon capacity bottle and a quick disconnect for fast and easy rinsing.



| CATALOG NO.    | DESCRIPTION        | UOM | ORDER MULTIPLE |
|----------------|--------------------|-----|----------------|
| <b>540-GUN</b> | Dial-a-Mix Sprayer | EA  | 6              |

**Garden Hose**

High quality product priced for high volume sales. Soft-Flex formulation makes the 5 ply Hose easy to handle. Withstands 500 psi water pressure. Heavy duty solid brass couplings and collar. Full Lifetime Guarantee!

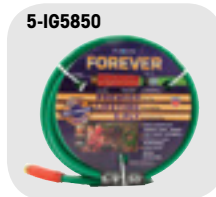

| CATALOG NO.     | DESCRIPTION                            | UOM | ORDER MULTIPLE |
|-----------------|--|-----|----------------|
| <b>5-IG5850</b> | Green Flexon 5-Ply Forever Garden Hose | EA  | 5              |

**All Purpose Sprayers**

Lightweight, versatile gallon size bottle has a 28" flexible hose and easy-to-carry handle. Best for big jobs in hard-to-reach places. Adjustable nozzle will atomize any low viscosity liquid. Adjusts from a mist to a 12" jet stream or anything in between. One pint container has a measured ounce guide. Ideal for water treatment chemicals.



| CATALOG NO.  | DESCRIPTION        | UOM | ORDER MULTIPLE |
|--------------|--------------------|-----|----------------|
| <b>BS-16</b> | Pint Size Sprayer  | EA  | 12             |
| <b>BS-32</b> | Quart Size Sprayer | EA  | 12             |

**Compression Sprayers**

Acid impervious poly design with a 36" (91cm) reinforced hose, shut-off with lock-on feature for continuous spraying, a 2-piece nozzle that's detachable for easy clean up and fits directly to the shut-off or extension wand. The Hand-Held Sprayer has a 48 oz. (1.4 l) capacity, perfect for small areas. All sprayers have a full 5 year warranty.



| CATALOG NO. | DESCRIPTION           | UOM | ORDER MULTIPLE |
|-------------|-----------------------|-----|----------------|
| <b>1002</b> | Hand Held Sprayer     | EA  | 1              |
| <b>2601</b> | 1 Gallon Wand Sprayer | EA  | 1              |
| <b>2602</b> | 2 Gallon Wand Sprayer | EA  | 1              |
| <b>2603</b> | 3 Gallon Wand Sprayer | EA  | 1              |

**Hot Water Hose**

High burst strength. 500 PSI. Withstands hot water up to 160°F. EPDM tube. Heavy duty solid brass couplings.



| CATALOG NO.     | DESCRIPTION               | UOM | ORDER MULTIPLE |
|-----------------|---------------------------|-----|----------------|
| <b>5-HW5850</b> | 5/8" x 50' Hot Water Hose | EA  | 5              |

**Pistol Grips & Water Nozzle**

Pistol Grip – 540-572 Insulated:  
For spraying hot or cold water. Heavy-duty, self adjusting "duck" packing for lifetime proof seal.  
Water Nozzle – 540-573 Un-insulated:  
Heavy-duty and holds open clip for continuous spraying. Self-adjusting "duck" for leak proof seal.



| CATALOG NO.    | DESCRIPTION              | UOM | ORDER MULTIPLE |
|----------------|--------------------------|-----|----------------|
| <b>540-572</b> | Insulated Pistol Grip    | EA  | 12             |
| <b>540-573</b> | Uninsulated Water Nozzle | EA  | 12             |



## ICE MACHINE PRODUCTS

### Super-Kool™ Nickel-Safe and Metal-Safe Ice Machine Cleaner

An economical, fast-acting, non-foaming acid sequestrant formula that quickly removes soil and mineral buildup. This safe, highly-concentrated, inhibited formula will not attack nickel or other metal components. USDA AUTHORIZED



| CATALOG NO.          | DESCRIPTION  | UOM | ORDER MULTIPLE |
|----------------------|--|-----|----------------|
| <b>SUPER-KOOL-16</b> | Super-Kool™ Ice Machine Cleaner – 16 oz. Bottle      | EA  | 12             |
| <b>SUPER-KOOL</b>    | Super-Kool™ Ice Machine Cleaner – 1 Gallon Container | EA  | 4              |

## LEAK DETECTORS AND ACCESSORIES

### Bubble-N-Trouble™ Freeze Protected Spray-On Leak Detector

Non-corrosive, non-toxic, and biodegradable. Does not attack metal or interfere with brazing or soldering. Spray-on application allows easy access for hard to reach places. Tacking agent holds solution on test surface making Bubble-N-Trouble™ very economical. USDA AUTHORIZED



| CATALOG NO.   | DESCRIPTION   | UOM | ORDER MULTIPLE |
|---------------|---|-----|----------------|
| <b>BNT-32</b> | Bubble-N-Trouble™ Freeze Protected Leak Detector – 32 oz. Spray       | EA  | 12             |
| <b>BNT-1</b>  | Bubble-N-Trouble™ Freeze Protected Leak Detector – 1 Gallon Container | EA  | 4              |

### Pro-Bubble™ Leak Detector

Easy-to-use, high-bubbling, viscoelastic blue leak detector. New improved formula.



| CATALOG NO.          | DESCRIPTION  | UOM | ORDER MULTIPLE |
|----------------------|--|-----|----------------|
| <b>PRO-BUBBLE-32</b> | Pro-Bubble™ Leak Detector – 32 oz. Bottle with Spray Top | EA  | 12             |

### Radiant Leak Finder™

Radiant color and viscous clinging formula exposes the smallest leaks. Freeze-protected – remains effective down to 0° F.



| CATALOG NO.  | DESCRIPTION                            | UOM | ORDER MULTIPLE |
|--------------|--|-----|----------------|
| <b>RLF-8</b> | Radiant Leak Finder™ – 8 oz. Container | EA  | 12             |

### Flash™ UV Dye

Flash is an advanced class of highly concentrated dyes that uses DRY R™ instead of POE oil as its carrier. Flash will not react with moisture and travels with the speed of the refrigerant once installed finding leaks within minutes. Using a patented misting orifice (20122 reusable hose sold separately), Flash™ uses the refrigerant as the propellant ensuring a no-mess injection every time.



| CATALOG NO.  | DESCRIPTION                           | UOM | ORDER MULTIPLE |
|--------------|---------------------------------------|-----|----------------|
| <b>980</b>   | Flash Universal UV Dye - Up to 5 Tons | EA  | 12             |
| <b>20122</b> | Reusable Hose, Clear                  | EA  | 1              |

### Flash™ UV Leak Detection Kit

Flash™ UV leak detection kit include 3 cans of Flash dye, a reusable clear hose, heavy-duty storage case, and choice of UV light.



| CATALOG NO.     | DESCRIPTION   | UOM | ORDER MULTIPLE |
|-----------------|---|-----|----------------|
| <b>98084KIT</b> | Flash™ with 3 cans, hose, and SEEKERmini™ Worklight | EA  | 1              |
| <b>98087KIT</b> | Flash™ with 3 cans, hose, and SEEKERmini™ Worklight | EA  | 1              |

### SEEKERmini™

High powered UV light with 3 AAA batteries included with no UV enhancing glasses required.



| CATALOG NO.     | DESCRIPTION                  | UOM | ORDER MULTIPLE |
|-----------------|------------------------------|-----|----------------|
| <b>84DCPLUS</b> | SEEKERmini™ UV LED Worklight | EA  | 1              |

**LEAK DETECTORS AND ACCESSORIES cont'd**

**SEEKERmax™**

High powered UV light with rechargeable 2200 mAh lithium-ion battery with no UV enhancing glasses required.



| CATALOG NO.     | DESCRIPTION                 | UOM | ORDER MULTIPLE |
|-----------------|-----------------------------|-----|----------------|
| <b>87DCPLUS</b> | SEEKERmax™ UV LED Worklight | EA  | 1              |

**UV Pocket Light**

UV Pocket Light with 3 AAA batteries included.



| CATALOG NO. | DESCRIPTION     | UOM | ORDER MULTIPLE |
|-------------|-----------------|-----|----------------|
| <b>89DC</b> | UV Pocket Light | EA  | 12             |

**LEAK SEALANTS**

**Super Seal Flex Inject®**

Super Seal Flex Inject® is the fastest, most effective proven way to permanently seal and prevent minor air conditioning and refrigeration (AC/R) leaks. With no tools or gauges required, the Flex Inject® sealant works by travelling through the system with the oil and refrigerant fixing leaks immediately (up to 300 microns). Flex Inject® works with all compressors, heat pumps, condensers, and other system components and it will not plug up manifold gauges, metering devices, thermostatic expansion valves (TXVs), pistons or cause cap tube blockages. It meets the ASHRAE ARI 700 refrigerant standard and is compatible with any refrigerant including R-410A with no pump downs or recoveries required. Flex Inject® is suitable for use in aluminum and copper coils and is microchannel friendly.



| CATALOG NO. | DESCRIPTION             | UOM | ORDER MULTIPLE |
|-------------|-------------------------|-----|----------------|
| <b>985</b>  | Super Seal Flex Inject® | EA  | 6              |

**Super Seal Total™**

Super Seal Total includes a stop leak sealant, Dry R, and Flash with all the benefits of Super Seal Advanced plus UV dye. Hose included.

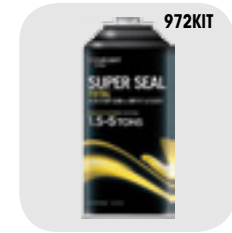

| CATALOG NO.   | DESCRIPTION                            | UOM | ORDER MULTIPLE |
|---------------|--|-----|----------------|
| <b>971KIT</b> | Super Seal Total™ - Up to 1.5 Tons     | EA  | 12             |
| <b>972KIT</b> | Super Seal Total™ - 1.5 Tons to 5 Tons | EA  | 12             |

**Super Seal Advanced™**

Super Seal Advanced includes a stop leak sealant and Dry R. Provides for a fast install with no pump down or recovery even for R410A. Compatible with all oils and refrigerants. Hose included.

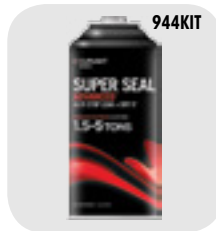

| CATALOG NO.   | DESCRIPTION                           | UOM | ORDER MULTIPLE |
|---------------|---------------------------------------|-----|----------------|
| <b>947KIT</b> | Super Seal Advanced™ - Up to 1.5 Tons | EA  | 12             |
| <b>944KIT</b> | Super Seal Advanced™ - 1.5 to 5 Tons  | EA  | 12             |
| <b>948KIT</b> | Super Seal Advanced™ - 5+ Tons        | EA  | 12             |

**Super Seal Sure Shot™**

Sure Shot includes a stop leak sealant and Eco Boost. Hose and cartridge included.



| CATALOG NO.   | DESCRIPTION  | UOM | ORDER MULTIPLE |
|---------------|--|-----|----------------|
| <b>983KIT</b> | Super Seal Sure Shot™ - Up to 6 Tons                       | EA  | 12             |
| <b>984</b>    | Super Seal Sure Shot™ Replacement Cartridge - Up to 6 Tons | EA  | 12             |
| <b>940</b>    | Super Seal Sure Shot™, 1/4 in. SAE Reusable Hose           | EA  | 1              |

**Seal-N-Go® Self-Sealing Refrigerant**

Seal-N-Go® is an excellent solution for taking R410A refrigerant on job sites and includes Super Seal Advanced™. It allows technicians to fill and stop and prevent leaks simultaneously. With a reusable charging hose (sold separately), the 25.7 ounce lightweight cannister is great for topping off multiple systems and perfect for mini-split installs. Reusable charging hose (20133) sold separately.



| CATALOG NO.    | DESCRIPTION  | UOM | ORDER MULTIPLE |
|----------------|--|-----|----------------|
| <b>9410SSR</b> | Seal-N-Go® 25.7 R410 Refrigerant plus Super Seal Advanced™ | EA  | 6              |
| <b>20133</b>   | Reusable Charging Hose with Gauge                          | EA  | 1              |

**ODOR NEUTRALIZERS**

**Duct-Fresh Gel**

A non-toxic, super-effective odor neutralizer for HVAC ducts, proficient at destroying stubborn odors including pet, smoke, and musty smells in residential, industrial and commercial applications. Effective for up to 6 months.



**DUCT-FRESH-8**

| CATALOG NO.          | DESCRIPTION             | UOM | ORDER MULTIPLE |
|----------------------|-------------------------|-----|----------------|
| <b>DUCT-FRESH-8</b>  | Duct-Fresh Gel – 8 oz.  | EA  | 12             |
| <b>DUCT-FRESH-16</b> | Duct-Fresh Gel – 16 oz. | EA  | 8              |

**The Purifier™**

The Purifier is an electric device that removes stubborn odors like tobacco smoke. It eliminates mold, mildew and bacteria from HVAC systems. The Purifier completes most jobs in just 20 minutes. Includes programmable timer with LCD display.



**170AIR**

| CATALOG NO.      | DESCRIPTION                           | UOM | ORDER MULTIPLE |
|------------------|---------------------------------------|-----|----------------|
| <b>170AIR</b>    | The Purifier™ Fresh Air Ozone Machine | EA  | 1              |
| <b>170AIRFAN</b> | Replacement Fan                       | EA  | 1              |
| <b>170AIRPCB</b> | Replacement Circuit Board             | EA  | 1              |
| <b>UVEC-07G</b>  | 12V Charger for Cigarette Lighter     | EA  | 1              |
| <b>410211</b>    | Replacement AC Adapter                | EA  | 1              |
| <b>410212</b>    | Replacement UV Bulb                   | EA  | 1              |

**Duct-Fresh Spray**

A non-toxic, instantaneous, super-effective odor neutralizer for HVAC ducts. Destroys stubborn pet odors, smoke, and musty smells in residential, industrial and commercial applications. Great for spot-treating malodor problem areas.



**DUCT-FRESH-32**

| CATALOG NO.          | DESCRIPTION                | UOM | ORDER MULTIPLE |
|----------------------|----------------------------|-----|----------------|
| <b>DUCT-FRESH-32</b> | Duct-Fresh Spray – 1 Quart | EA  | 12             |

**Odor-Aid™**

Disinfects and deodorizes with an easy pump spray. Eliminates bacteria, germs and microorganisms that cause offensive odors.



**171AIR**

| CATALOG NO.   | DESCRIPTION                             | UOM | ORDER MULTIPLE |
|---------------|---|-----|----------------|
| <b>171AIR</b> | Odor-Aid™ – 7 oz. Bottle with Spray Top | EA  | 12             |

**PAN TREATMENTS/DISINFECTANTS**

**Flow-Plus™ Condensate Pan Treatment**

A unique polymer formula that maintains condensate flow and prevents drain pan overflow. 100% active. No residue—no waste—nonclogging. Effective, long-term condensate activated release. Environmentally safe, non-toxic, and non-corrosive. Also economical with sizes to meet all tonnage requirements.



**FLOW-PLUS-200**

| CATALOG NO.          | EQUIPMENT TONNAGE |
|----------------------|-------------------|
| <b>FLOW-PLUS-25</b>  | 1/2 to 3 tons     |
| <b>FLOW-PLUS-200</b> | 1/2 to 3 tons     |
| <b>FLOW-PLUS-6</b>   | 3 to 5 tons       |
| <b>FLOW-PLUS-10</b>  | 5 to 20 tons      |
| <b>FLOW-PLUS-125</b> | 20 to 50 tons     |

| CATALOG NO.          | DESCRIPTION  | UOM | ORDER MULTIPLE |
|----------------------|--|-----|----------------|
| <b>FLOW-PLUS-25</b>  | Flow-Plus™ Condensate Pan Treatment – 25 Tabs/Jar      | EA  | 12             |
| <b>FLOW-PLUS-200</b> | Flow-Plus™ Condensate Pan Treatment – 200 Tabs/Jar     | EA  | 4              |
| <b>FLOW-PLUS-6</b>   | Flow-Plus™ Condensate Pan Treatment – 6 - 1 oz. Blocks | EA  | 12             |
| <b>FLOW-PLUS-10</b>  | Flow-Plus™ Condensate Pan Treatment – 10 oz. Tubs      | EA  | 18             |
| <b>FLOW-PLUS-125</b> | Flow-Plus™ Condensate Pan Treatment – 1.25 lb. Tubs    | EA  | 8              |

**Pro-Treat® 350 Condensate Drain Pan Treatment**

Place a Pro-Treat® 350 tablet in a condensate drain pan and condensed moisture will slowly dissolve the tablet, thinly coating the pan surface to give prolonged cleaning action on sludge. Dosage: one or two tablets are recommended in each pan per month. For industrial use only!



**PROTREAT-350**

| CATALOG NO.         | DESCRIPTION   | UOM | ORDER MULTIPLE |
|---------------------|---|-----|----------------|
| <b>PROTREAT-350</b> | Pro-Treat® 350 Condensate Pan Treatment – 100 Tablets per Jar | EA  | 24             |

**Pro-Treat® Pan Strips**

Pro-Treat® Pan Strips kill odor causing bacteria and last up to 6 months. Use in the primary drain pan of cooling units such as air conditioners and refrigerators. Pro-Treat® Pan Strips control foul-smelling odors caused by mildew, fungi, bacteria, algae, and slime. For use in hotels, schools, colleges, hospitals, nursing homes, airports, and many other locations.



**EPA Registered**

**PS-075**

| CATALOG NO.   | DESCRIPTION                               | STRIPS/PACK | UOM | ORDER MULTIPLE |
|---------------|---|-------------|-----|----------------|
| <b>PS-075</b> | Pro-Treat® Pan Strips – for up to 3/4 Ton | 10          | EA  | 12             |
| <b>PS-01</b>  | Pro-Treat® Pan Strips – for 1 to 2 Ton    | 10          | EA  | 12             |
| <b>PS-03</b>  | Pro-Treat® Pan Strips – for 3 to 5 Ton    | 6           | EA  | 24             |
| <b>PS-07</b>  | Pro-Treat® Pan Strips – for 7 to 12 Ton   | 2           | EA  | 24             |
| <b>PS-20</b>  | Pro-Treat® Pan Strips – for 20 to 25 Ton  | 1           | EA  | 24             |
| <b>PS-40</b>  | Pro-Treat® Pan Strips – for 40 to 50 Ton  | 1           | EA  | 12             |

EPA Registration #6836-254-69966

**PAN TREATMENTS/DISINFECTANTS cont'd**

**Pro-Treat® 151 Premium Condensate Drain Pan Treatment**

Pro-Treat® 151 premium tablets penetrate and help remove sludge that can plug drain pans and drain lines and foul humidifier pans. Kills odors associated with slime and sludge, minimizing maintenance problems from overflow and water damage caused by fouled pans, plugged traps, or drain lines. Tablets are 100% soluble, easy-to-use, and do not form any deposits in the pan or drain line. Approved for computer rooms. Dosage: 1 tablet per 3 tons each month. PROTREAT-151 is EPA registered.



| CATALOG NO.         | DESCRIPTION  | UOM | ORDER MULTIPLE |
|---------------------|--|-----|----------------|
| <b>PROTREAT-151</b> | Pro-Treat® 151 Premium Drain Pan Treatment – 100 Tablets/Jar | EA  | 12             |

**Pro-Treat® 161 Condensate Drain Pan Treatment**

Controls odors and eliminates condensate drain pan overflows and the resulting water damage. 100% soluble, easy-to-use, non-corrosive, and non-toxic. Use regularly to assure season-long, trouble-free condensate drain pan performance. Approved for computer rooms. Dosage: 2 tablets per 3 tons each month.



| CATALOG NO.         | DESCRIPTION  | UOM | ORDER MULTIPLE |
|---------------------|--|-----|----------------|
| <b>PROTREAT-161</b> | Pro-Treat® 161 Drain Pan Treatment – 100 Tablets/Jar | EA  | 12             |

**Pro-Treat® 217 Economy Condensate Drain Pan Treatment**

Economical with 200 tablets per jar. Safe, non corrosive, odor free and 100% soluble. Approved for computer rooms. Convenient, easy to use tablet form provides prolonged cleaning action. Dosage 3 tablets per 3 tons per month.



| CATALOG NO.         | DESCRIPTION  | UOM | ORDER MULTIPLE |
|---------------------|--|-----|----------------|
| <b>PROTREAT-217</b> | Pro-Treat® 217 Economy Drain Pan Treatment – 200 Tablets/Jar | EA  | 12             |

**Pro-Treat® 152 King-Size Premium Condensate Drain Pan Treatment**

Economical, safe, effective king-size tablets last three times longer. Safe, non-corrosive, odor-free and 100% soluble. Computer room approved. Keeps drain pans and condensate lines clean and free flowing. Dosage: 1 tablet per 3 tons per 3 months.



| CATALOG NO.         | DESCRIPTION   | UOM | ORDER MULTIPLE |
|---------------------|---|-----|----------------|
| <b>PROTREAT-152</b> | Pro-Treat® 152 King-Size Premium Drain Pan Treatment – 12 Tablets/Jar | EA  | 6              |

**Pro-Treat® 200 Economy Condensate Drain Pan Treatment**

Economical with 200 tablets per jar. Safe, non-corrosive, odor-free and 100% soluble. Approved for computer rooms. Convenient, easy-to-use tablet form provides prolonged cleaning action. Dosage: 3 tablets per 3 tons per month.



| CATALOG NO.         | DESCRIPTION  | UOM | ORDER MULTIPLE |
|---------------------|--|-----|----------------|
| <b>PROTREAT-200</b> | Pro-Treat® 200 Economy Drain Pan Treatment – 200 Tablets/Jar | EA  | 12             |

**REFRIGERATION OILS**

**Pro-Lube™ Mineral Oil**

Specialty Chemical mineral oil (by Calumet) is a superior mineral naphthenic refrigeration oil designed to meet the operating requirements of modern residential and commercial air conditioning and refrigeration compressors. These oils have a low pour point, low wax floc temperature and are chemically and thermally stable in the presence of refrigerants. OEM approved by Copeland, Carlyle, Trane, and other major compressor manufacturers. Always follow compressor manufacturer's oil viscosity recommendations. Mineral oil is specially recommended for lubrication of compressors containing ammonia, R-11, 12, 13, 22, 113, 114, 123, 500 and 502 refrigerants in residential, industrial and commercial service. DO NOT USE WITH HFC REFRIGERANTS SUCH AS R-134A.



| CATALOG NO.   | DESCRIPTION                                       | UOM | ORDER MULTIPLE |
|---------------|---|-----|----------------|
| <b>3WF-01</b> | SUS150 ISO32 Pro-Lube™ Mineral Oil – 1 Gallon Jug | EA  | 4              |
| <b>4WF-01</b> | SUS300 ISO68 Pro-Lube™ Mineral Oil – 1 Gallon Jug | EA  | 4              |

**Pro-Lube-ALK™ Alkylbenzene**

Specialty Chemical alkylbenzene is recommended for refrigeration, air conditioning, and heat pump applications using HCFC and CFC refrigerants. An excellent choice when retrofitting to the new refrigerants which are HCFC based such as R-401A (MP-39), R-401B (MP-66), R-402A (HP-80), R-402B (HP-81). OEM approved by Copeland and other compressor manufacturers.



| CATALOG NO.      | DESCRIPTION   | UOM | ORDER MULTIPLE |
|------------------|---|-----|----------------|
| <b>ALK150-01</b> | SUS150 ISO32 Pro-Lube™ Alkylbenzene – 1 Gallon Jug  | EA  | 4              |
| <b>ALK150-05</b> | SUS150 ISO32 Pro-Lube™ Alkylbenzene – 5 Gallon Drum | EA  | 1              |
| <b>ALK200-01</b> | SUS200 ISO46 Pro-Lube™ Alkylbenzene – 1 Gallon Jug  | EA  | 4              |
| <b>ALK300-01</b> | SUS300 ISO68 Pro-Lube™ Alkylbenzene – 1 Gallon Jug  | EA  | 4              |



**REFRIGERATION OILS cont'd**

**Pro-Lube-POE™ Polyolester**

Specialty Chemical POE is custom formulated for use in refrigeration compressors. This series contains no ozone depleting substances and is compatible with new HFC refrigerants as well as existing CFC and HCFC refrigerants. POE is also compatible with traditional mineral oil lubricants.



**POE32-32**

| CATALOG NO.      | DESCRIPTION  | UOM | ORDER MULTIPLE |
|------------------|--|-----|----------------|
| <b>POE32-32</b>  | SUS150 ISO32 Pro-Lube-POE™ Polyolester – 1 Quart Can   | EA  | 12             |
| <b>POE32-01</b>  | SUS150 ISO32 Pro-Lube-POE™ Polyolester – 1 Gallon Can  | EA  | 6              |
| <b>POE68-32</b>  | SUS300 ISO68 Pro-Lube-POE™ Polyolester – 1 Quart Can   | EA  | 12             |
| <b>POE68-01</b>  | SUS300 ISO68 Pro-Lube-POE™ Polyolester – 1 Gallon Can  | EA  | 6              |
| <b>POE100-32</b> | SUS500 ISO100 Pro-Lube-POE™ Polyolester – 1 Quart Can  | EA  | 12             |
| <b>POE100-01</b> | SUS500 ISO100 Pro-Lube-POE™ Polyolester – 1 Gallon Can | EA  | 6              |

**SYSTEM CLEANERS**

**D'Scale™ Acid Scale Remover for Cooling Towers**

D'Scale™ will not create corrosive acidic foam. D'Scale™ has pH indicating dye. The color changes to yellow when acid has been consumed. Each gallon dissolves 3 pounds of scale.



**D-SCALE**

| CATALOG NO.    | DESCRIPTION                                      | UOM | ORDER MULTIPLE |
|----------------|--|-----|----------------|
| <b>D-SCALE</b> | D'Scale™ Acid Scale Remover – 1 Gallon Container | EA  | 4              |

**TEST KITS**

**Acid Test Kit™**

Detects acid in refrigeration oil. Convenient, one-step test means no chemicals to mix. Easy to evaluate. Color change indicates acidity; color intensity reveals the amount of acid present in the oil sample.



**ATK-4**

**ATK-1**

**ATK-1P**

| CATALOG NO.   | DESCRIPTION                | UOM | ORDER MULTIPLE |
|---------------|----------------------------|-----|----------------|
| <b>ATK-4</b>  | Acid Test Kit™, pack of 4  | EA  | 4              |
| <b>ATK-1</b>  | Acid Test Kit™             | EA  | 1              |
| <b>ATK-1P</b> | Acid Test Kit™ for POE Oil | EA  | 1              |

**THREAD SEALANTS**

**PRO-TITE™ Resin Based Thread Sealant**

Resin based thread sealant that adheres to internal surfaces, fills voids while forming a flexible fluid tight seal. Specifically formulated for use on metals and plastics subject to extreme vibration. Serviceable at temperatures from 100°F ( 73°C) to 400°F (204°C) and from full vacuum to 10,000 PSI. Pro Tite™ is impervious to most chemicals including refrigerants, petroleum products, gases, steam, etc. Alcohol based.



| CATALOG NO.  | DESCRIPTION                                       | UOM | ORDER MULTIPLE |
|--------------|---|-----|----------------|
| <b>CLL-1</b> | Pro-Tite™ Thread Sealant – 1-1/3 oz. Squeeze Tube | EA  | 12             |
| <b>CLL-4</b> | Pro-Tite™ Thread Sealant – 4 oz. Brush Top        | EA  | 12             |

**VACUUM PUMP OIL**

**Pro-Lube-VAC™ Vacuum Pump Oil**

Specialty Chemical VP-68 Premium Vacuum Pump Oil is now based on a highly refined paraffinic based stock. This new improved formulation is lighter in color and provides better viscosity and oxidation stability than the previous formulation. VP-68 provides excellent cold start performance; formulated to meet minimum moisture content specifications.



| CATALOG NO.    | DESCRIPTION                                   | UOM | ORDER MULTIPLE |
|----------------|---|-----|----------------|
| <b>VP68-32</b> | Pro-Lube-VAC™ Vacuum Pump Oil – 1 Quart Jug   | EA  | 12             |
| <b>VP68-01</b> | Pro-Lube-VAC™ Vacuum Pump Oil – 1 Gallon Jug  | EA  | 4              |
| <b>VP68-05</b> | Pro-Lube-VAC™ Vacuum Pump Oil – 5 Gallon Pail | EA  | 1              |

**ADDITIVES**

**Acid Eliminator**

Keeps acid away; compatible with all refrigerants and oils. Chemically neutralizes and prevents acids that are formed in air conditioning and refrigeration systems due to refrigerant and refrigeration oil break-down, moisture, and compressor burnout. Easy-to-use, no complicated charts. Works fast, circulates quickly, and leaves no solids or solid residuals. Will not harm system components. Can prevent system breakdown.



| CATALOG NO.      | DESCRIPTION                            | UOM | ORDER MULTIPLE |
|------------------|--|-----|----------------|
| <b>ACID-ELIM</b> | Acid Eliminator – 4 oz. Plastic Bottle | EA  | 12             |

**Dry R™**

DRY R™ enhances the function of driers and metering devices by removing non-condensables, eliminating ice crystals, and breaking down blockages by removing scale and sludge on moving parts such as TXVs.



| CATALOG NO.   | DESCRIPTION                               | UOM | ORDER MULTIPLE |
|---------------|---|-----|----------------|
| <b>973KIT</b> | Dry R™ Moisture Eliminator - Up to 5 tons | EA  | 12             |

**Pro-Thaw™ Liquid Dryer for Refrigerants**

Chemically dries all refrigerants (R-12, R-22, R-134a, etc.), methyl chloride and methylene chloride. Frees up systems frozen due to moisture contamination in 5 minutes and prevents refreezing. Does not contain any dissolved solids, leaves no residue and works with or without solid dryers.



| CATALOG NO.       | DESCRIPTION                      | UOM | ORDER MULTIPLE |
|-------------------|----------------------------------|-----|----------------|
| <b>PRO-THAW-1</b> | Pro-Thaw™ – 1 oz. Plastic Bottle | EA  | 24             |
| <b>PRO-THAW</b>   | Pro-Thaw™ – 4 oz. Plastic Bottle | EA  | 12             |

# INLINE COMPONENTS

Access Fittings ..... 236  
 Brass Fittings..... 238-240  
 Copper Fittings ..... 233-235  
 Cushion Clamps ..... 240  
 Driers, Sight Glasses ..... 241-242  
 Line Piercing Valves and Tools ..... 237  
 Refrigerant Charging..... 242  
 Refrigerant Labels..... 245  
 Refrigerant Recovery Products ..... 245  
 Refrigerant Tubing ..... 243-244  
 Reversing Valves..... 244  
 Sentry™ Refrigerant Locking Caps ..... 246  
 Tubing Insulation ..... 247





# REFRIGERANT LOCKING CAPS

**Sentry™ Refrigerant Locking Caps** meet the International Residential Code (IRC) and International Mechanical Code (IMC) requirement that all outdoor access ports on A/C and refrigerant equipment must be tamper resistant. Sentry™ Locking Caps safeguard against refrigerant theft and inhalant abuse. These locking caps are anodized in industry color codes for easy identification and prevent accidental mixing of refrigerant gases.

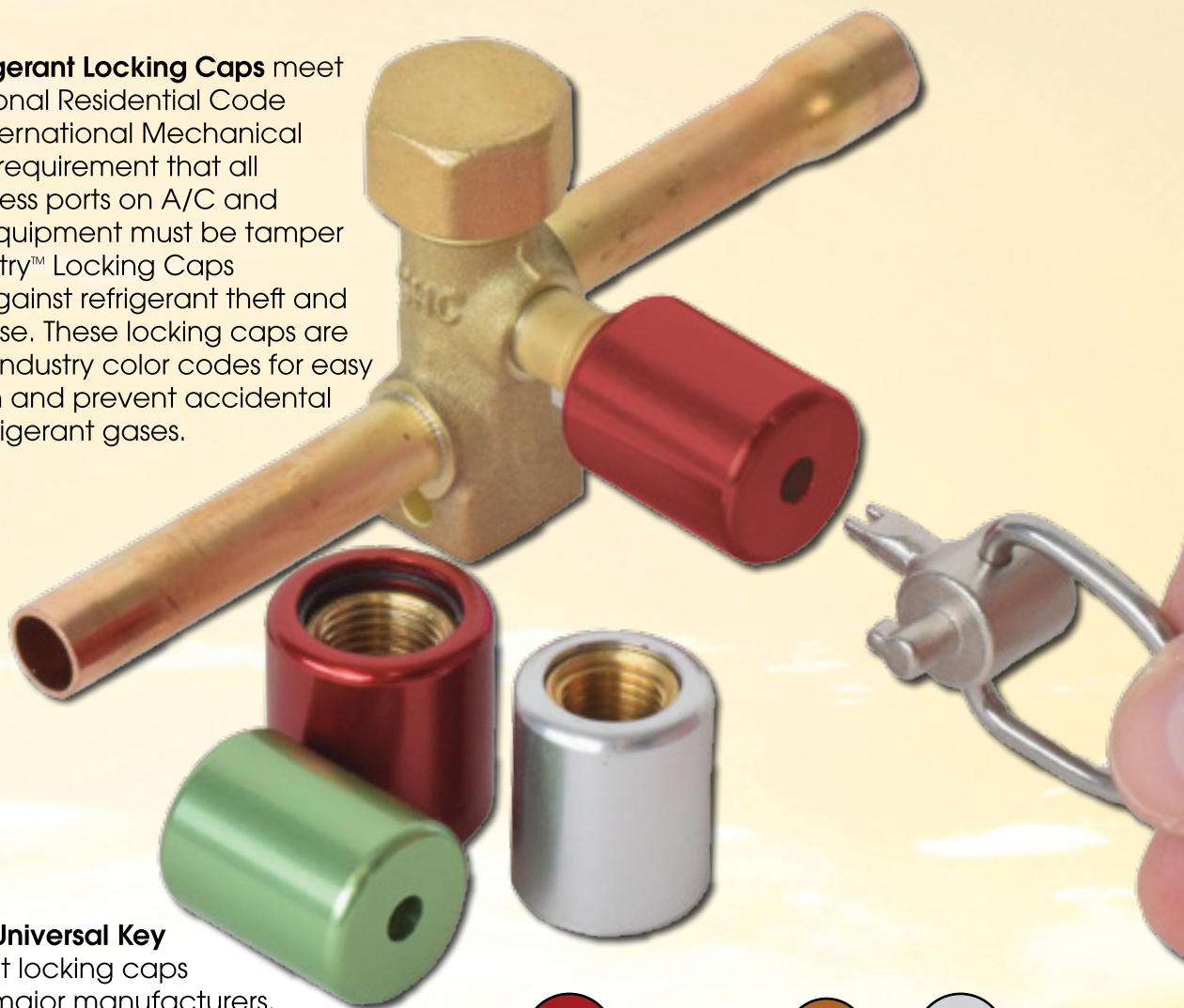

The **Sentry™ Universal Key** fits refrigerant locking caps from all the major manufacturers. It saves time hunting for the right key at the job site. It fits locking caps with these key holes:

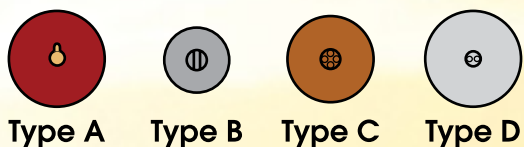

### Code Compliant

Meets the IMC & IRC code requirement.



### Deters Refrigerant Theft

Tamper resistant cap design.



### Weather Proof

Anodized aluminum casing with threaded brass insert.

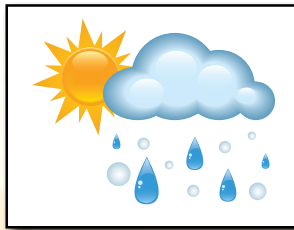

### Universal Key Included

Fits refrigerant locking caps from all major manufacturers.





## COPPER FITTINGS

### Male Adapter C x M



| CATALOG NO. | O.D. SIZE   | I.D. SIZE   | UOM | ORDER MULTIPLE |
|-------------|-------------|-------------|-----|----------------|
| C101-0050   | 5/8" x 1/2" | 1/2" x 1/2" | EA  | 25             |
| C101-0100   | 7/8" x 3/4" | 3/4" x 3/4" | EA  | 25             |
| C101-0150   | 1-1/8" x 1" | 1" x 1"     | EA  | 10             |
| C101-0222   | 1-3/8" x 1" | 1-1/4" x 1" | EA  | 10             |

### Female Adapter C x F



| CATALOG NO. | O.D. SIZE       | I.D. SIZE       | UOM | ORDER MULTIPLE |
|-------------|-----------------|-----------------|-----|----------------|
| C105-0057   | 5/8" x 3/4"     | 1/2" x 3/4"     | EA  | 25             |
| C105-0100   | 7/8" x 3/4"     | 3/4" x 3/4"     | EA  | 25             |
| C105-0150   | 1-1/8" x 1"     | 1" x 1"         | EA  | 10             |
| C105-0215   | 1-3/8" x 1-1/4" | 1-1/4" x 1-1/4" | EA  | 10             |

### Male Adapter Ftg. x M



| CATALOG NO. | O.D. SIZE       | I.D. SIZE       | UOM | ORDER MULTIPLE |
|-------------|-----------------|-----------------|-----|----------------|
| C114-0215   | 1-3/8" x 1-1/4" | 1-1/4" x 1-1/4" | EA  | 10             |

### 90 Degree Long Turn Street Ell Ftg. x C



| CATALOG NO. | O.D. SIZE | I.D. SIZE | UOM | ORDER MULTIPLE |
|-------------|-----------|-----------|-----|----------------|
| C272-0002   | 3/8"      | 1/4"      | EA  | 25             |
| C272-0025   | 1/2"      | 3/8"      | EA  | 25             |
| C272-0050   | 5/8"      | 1/2"      | EA  | 25             |
| C272-0090   | 3/4"      | 5/8"      | EA  | 25             |
| C272-0100   | 7/8"      | 3/4"      | EA  | 10             |
| C272-0150   | 1-1/8"    | 1"        | EA  | 10             |
| C272-0215   | 1-3/8"    | 1-1/4"    | EA  | 10             |

### 90 Degree Ell C x C



| CATALOG NO. | O.D. SIZE | I.D. SIZE | UOM | ORDER MULTIPLE |
|-------------|-----------|-----------|-----|----------------|
| C235-0002   | 3/8"      | 1/4"      | EA  | 25             |
| C235-0025   | 1/2"      | 3/8"      | EA  | 25             |
| C235-0050   | 5/8"      | 1/2"      | EA  | 25             |
| C235-0090   | 3/4"      | 5/8"      | EA  | 25             |
| C235-0100   | 7/8"      | 3/4"      | EA  | 25             |
| C235-0150   | 1-1/8"    | 1"        | EA  | 10             |
| C235-0215   | 1-3/8"    | 1-1/4"    | EA  | 10             |

### 45 Degree Ell C x C



| CATALOG NO. | O.D. SIZE | I.D. SIZE | UOM | ORDER MULTIPLE |
|-------------|-----------|-----------|-----|----------------|
| C290-0002   | 3/8"      | 1/4"      | EA  | 25             |
| C290-0025   | 1/2"      | 3/8"      | EA  | 25             |
| C290-0050   | 5/8"      | 1/2"      | EA  | 25             |
| C290-0090   | 3/4"      | 5/8"      | EA  | 25             |
| C290-0100   | 7/8"      | 3/4"      | EA  | 25             |
| C290-0150   | 1-1/8"    | 1"        | EA  | 10             |
| C290-0215   | 1-3/8"    | 1-1/4"    | EA  | 60             |
| C290-0390   | 2-1/8"    | 2"        | EA  | 18             |

### 90 Degree Street Ell Ftg. x C



| CATALOG NO. | O.D. SIZE | I.D. SIZE | UOM | ORDER MULTIPLE |
|-------------|-----------|-----------|-----|----------------|
| C254-0002   | 3/8"      | 1/4"      | EA  | 25             |
| C254-0100   | 7/8"      | 3/4"      | EA  | 25             |
| C254-0150   | 1-1/8"    | 1"        | EA  | 10             |

**COPPER FITTINGS cont'd**

**90 Degree Long Turn Ell C x C**



| CATALOG NO. | O.D. SIZE | I.D. SIZE | UOM | ORDER MULTIPLE |
|-------------|-----------|-----------|-----|----------------|
| C242-0001   | 1/4"      | 1/8"      | EA  | 25             |
| C242-0002   | 3/8"      | 1/4"      | EA  | 25             |
| C242-0025   | 1/2"      | 3/8"      | EA  | 25             |
| C242-0050   | 5/8"      | 1/2"      | EA  | 25             |
| C242-0090   | 3/4"      | 5/8"      | EA  | 25             |
| C242-0100   | 7/8"      | 3/4"      | EA  | 10             |
| C242-0150   | 1-1/8"    | 1"        | EA  | 10             |
| C242-0215   | 1-3/8"    | 1-1/4"    | EA  | 35             |
| C242-0295   | 1-5/8"    | 1-1/2"    | EA  | 25             |
| C242-0390   | 2-1/8"    | 2"        | EA  | 12             |

**Coupling (Socket) with Rolled Tube Stop C x C**



| CATALOG NO. | O.D. SIZE | I.D. SIZE | UOM | ORDER MULTIPLE |
|-------------|-----------|-----------|-----|----------------|
| C165-0001   | 1/4"      | 1/8"      | EA  | 25             |
| C165-0002   | 3/8"      | 1/4"      | EA  | 25             |
| C165-0025   | 1/2"      | 3/8"      | EA  | 25             |
| C165-0050   | 5/8"      | 1/2"      | EA  | 25             |
| C165-0090   | 3/4"      | 5/8"      | EA  | 25             |
| C165-0100   | 7/8"      | 3/4"      | EA  | 25             |
| C165-0150   | 1-1/8"    | 1"        | EA  | 10             |
| C165-0215   | 1-3/8"    | 1-1/4"    | EA  | 10             |
| C165-0295   | 1-5/8"    | 1-1/2"    | EA  | 60             |
| C165-0390   | 2-1/8"    | 2"        | EA  | 40             |

**Reducer Coupling w/Stop C x C**



| CATALOG NO. | O.D. SIZE       | I.D. SIZE     | UOM | ORDER MULTIPLE |
|-------------|-----------------|---------------|-----|----------------|
| C165-0007   | 3/8" x 1/4"     | 1/4" x 1/8"   | EA  | 25             |
| C165-0032   | 1/2" x 3/8"     | 3/8" x 1/4"   | EA  | 25             |
| C165-0058   | 5/8" x 1/2"     | 1/2" x 3/8"   | EA  | 25             |
| C165-0093   | 3/4" x 5/8"     | 5/8" x 1/2"   | EA  | 25             |
| C165-0094   | 3/4" x 1/2"     | 5/8" x 3/8"   | EA  | 25             |
| C165-0107   | 7/8" x 5/8"     | 3/4" x 1/2"   | EA  | 25             |
| C165-0149   | 7/8" x 3/4"     | 3/4" x 5/8"   | EA  | 25             |
| C165-0159   | 1-1/8" x 7/8"   | 1" x 3/4"     | EA  | 10             |
| C165-1498   | 1-1/8" x 3/4"   | 1" x 5/8"     | EA  | 10             |
| C165-0222   | 1-3/8" x 1-1/8" | 1-1/4" x 1"   | EA  | 10             |
| C165-0223   | 1-3/8" x 7/8"   | 1-1/4" x 3/4" | EA  | 10             |
| C165-0304   | 1-5/8" x 1-1/8" | 1-1/2" x 1"   | EA  | 10             |
| C165-0305   | 1-5/8" x 7/8"   | 1-1/2" x 3/4" | EA  | 10             |
| C165-0399   | 2-1/8" x 1-3/8" | 2" x 1-1/4"   | EA  | 50             |

**45 Degree Street Ell Ftg. x C**



| CATALOG NO. | O.D. SIZE | I.D. SIZE | UOM | ORDER MULTIPLE |
|-------------|-----------|-----------|-----|----------------|
| C295-0002   | 3/8"      | 1/4"      | EA  | 25             |
| C295-0090   | 3/4"      | 5/8"      | EA  | 25             |
| C295-0100   | 7/8"      | 3/4"      | EA  | 25             |
| C295-0150   | 1-1/8"    | 1"        | EA  | 10             |

**Fitting Reducer Coupling Ftg. x C**



| CATALOG NO. | O.D. SIZE       | I.D. SIZE     | UOM | ORDER MULTIPLE |
|-------------|-----------------|---------------|-----|----------------|
| C410-0032   | 1/2" x 3/8"     | 3/8" x 1/4"   | EA  | 25             |
| C410-0058   | 5/8" x 1/2"     | 1/2" x 3/8"   | EA  | 25             |
| C410-0093   | 3/4" x 5/8"     | 5/8" x 1/2"   | EA  | 25             |
| C410-0107   | 7/8" x 5/8"     | 3/4" x 1/2"   | EA  | 25             |
| C410-0149   | 7/8" x 3/4"     | 3/4" x 5/8"   | EA  | 25             |
| C410-0159   | 1-1/8" x 7/8"   | 1" x 3/4"     | EA  | 10             |
| C410-0222   | 1-3/8" x 1-1/8" | 1-1/4" x 1"   | EA  | 10             |
| C410-0306   | 1-5/8" x 5/8"   | 1-1/2" x 1/2" | EA  | 10             |

**Cap**



| CATALOG NO. | O.D. SIZE | I.D. SIZE | UOM | ORDER MULTIPLE |
|-------------|-----------|-----------|-----|----------------|
| C154-0002   | 3/8"      | 1/4"      | EA  | 25             |
| C154-0090   | 3/4"      | 5/8"      | EA  | 25             |
| C154-0100   | 7/8"      | 3/4"      | EA  | 25             |

**Union C x Brass**



| CATALOG NO. | O.D. SIZE | I.D. SIZE | UOM | ORDER MULTIPLE |
|-------------|-----------|-----------|-----|----------------|
| C657-0100   | 7/8"      | 3/4"      | EA  | 100            |

Flush Bushing



C142-0058

| CATALOG NO. | O.D. SIZE   | I.D. SIZE   | UOM | ORDER MULTIPLE |
|-------------|-------------|-------------|-----|----------------|
| C142-0058   | 5/8" x 1/4" | 1/2" x 1/4" | EA  | 25             |

U-Type Strap



| CATALOG NO. | O.D. SIZE | I.D. SIZE | UOM | ORDER MULTIPLE |
|-------------|-----------|-----------|-----|----------------|
| C947-0025   | 1/2"      | 3/8"      | EA  | 25             |
| C947-0050   | 5/8"      | 1/2"      | EA  | 25             |
| C947-0100   | 7/8"      | 3/4"      | EA  | 25             |
| C947-0150   | 1-1/8"    | 1"        | EA  | 25             |
| C947-0215   | 1-3/8"    | 1-1/4"    | EA  | 100            |
| C947-0295   | 1-5/8"    | 1-1/2"    | EA  | 100            |
| C947-0390   | 2-1/8"    | 2"        | EA  | 50             |

Copper Coupling with No Stop



C172-0100

| CATALOG NO. | O.D. SIZE | I.D. SIZE | UOM | ORDER MULTIPLE |
|-------------|-----------|-----------|-----|----------------|
| C172-0090   | 3/4"      | 5/8"      | EA  | 25             |
| C172-0100   | 7/8"      | 3/4"      | EA  | 25             |
| C172-0150   | 1-1/8"    | 1"        | EA  | 10             |
| C172-0215   | 1-3/8"    | 1-1/4"    | EA  | 10             |

P-Traps



C533-0050

| CATALOG NO. | O.D. SIZE | I.D. SIZE | UOM | ORDER MULTIPLE |
|-------------|-----------|-----------|-----|----------------|
| C533-0050   | 5/8       | 1/2       | EA  | 5              |
| C533-0150   | 1-1/8     | 1         | EA  | 3              |

Reducing Tee C x C x C



C460-0305

| CATALOG NO. | O.D. SIZE                | I.D. SIZE              | UOM | ORDER MULTIPLE |
|-------------|--------------------------|------------------------|-----|----------------|
| C460-0222   | 1-3/8" x 1-3/8" x 1-1/8" | 1-1/4" x 1-1/4" x 1"   | EA  | 40             |
| C460-0305   | 1-5/8" x 1-5/8" x 7/8"   | 1-1/2" x 1-1/2" x 3/4" | EA  | 35             |
| C460-0414   | 2-1/8" x 1-5/8" x 1-5/8" | 2" x 1-1/2" x 1-1/2"   | EA  | 10             |
| C460-0429   | 2-1/8" x 1-3/8" x 2-1/8" | 2" x 1-1/4" x 2"       | EA  | 10             |
| C460-0432   | 2-1/8" x 1-3/8" x 1-1/8" | 2" x 1-1/4" x 1"       | EA  | 20             |

Copper Coupling w/Dimple Stop



C170-0003

| CATALOG NO. | O.D. SIZE | I.D. SIZE | UOM | ORDER MULTIPLE |
|-------------|-----------|-----------|-----|----------------|
| C170-0003   | 5/16      | 1/4       | EA  | 25             |

Tee C x C x C



C460-0090

| CATALOG NO. | O.D. SIZE | I.D. SIZE | UOM | ORDER MULTIPLE |
|-------------|-----------|-----------|-----|----------------|
| C460-0002   | 3/8"      | 1/4"      | EA  | 25             |
| C460-0025   | 1/2"      | 3/8"      | EA  | 25             |
| C460-0050   | 5/8"      | 1/2"      | EA  | 25             |
| C460-0090   | 3/4"      | 5/8"      | EA  | 25             |
| C460-0100   | 7/8"      | 3/4"      | EA  | 10             |
| C460-0150   | 1-1/8"    | 1"        | EA  | 10             |
| C460-0215   | 1-3/8"    | 1-1/4"    | EA  | 35             |
| C460-0295   | 1-5/8"    | 1-1/2"    | EA  | 20             |
| C460-0390   | 2-1/8"    | 2"        | EA  | 10             |

**ACCESS FITTINGS**

A convenient low-cost port for refrigeration servicing. May be installed in any position on either high or low side for charging, purging, quick testing or pressure checking. DiversiTech's access fittings have 1/4" SAE male flare access ports and include a quick seal cap and a stainless and brass special refrigerant valve core.

| CATALOG NO.     | DESCRIPTION                                 | CONNECTION   | QTY PER PACK | UOM | ORDER MULT. |
|-----------------|---|--|--------------|-----|-------------|
| <b>VA-3-346</b> | 3 Way Solder Type, pack of 6                | For 3/16" O.D. tube or 1/4" and 3/8" solder fitting                            | 6            | PK  | 1           |
| <b>VA-34</b>    | Straight Solder Type, pack of 6             | 3/16" O.D.S. x 1/4" O.D.F.   | 6            | PK  | 1           |
| <b>VA-46</b>    | Straight Solder Type, pack of 6             | 1/4" O.D.S. x 3/8" O.D.F.  | 6            | PK  | 1           |
| <b>VA-68</b>    | Straight Solder Type, pack of 6             | 3/8" O.D.S. x 1/2" O.D.F.  | 6            | PK  | 1           |
| <b>VAU-24</b>   | Half Union, pack of 6                       | 1/8" MPT   | 6            | PK  | 1           |
| <b>VAU-45</b>   | Half Union, pack of 6                       | 1/4" MPT   | 6            | PK  | 1           |
| <b>VAX-2</b>    | Extended Copper Tube                        | 1/8" O.D. tube   | 6            | PK  | 1           |
| <b>VAX-3</b>    | Extended Copper Tube                        | 3/16" O.D. x 1/8" I.D.   | 6            | PK  | 1           |
| <b>VAX-4</b>    | Extended Copper Tube                        | 1/4" O.D. x 3/16" I.D.   | 6            | PK  | 1           |
| <b>VAX-5</b>    | Extended Copper Tube                        | 5/16" O.D. x 1/4" I.D.   | 3            | PK  | 1           |
| <b>VAX-6</b>    | Extended Copper Tube                        | 3/8" O.D. x 5/16" I.D.   | 3            | PK  | 1           |
| <b>VAX-8</b>    | Extended Copper Tube                        | 1/2" O.D.  | 3            | PK  | 1           |
| <b>VS-4</b>     | Swivel Nut w/Depressor, pack of 6           | 1/4" female flare forged swivel nut  | 6            | PK  | 1           |
| <b>VST-4</b>    | Swivel Tee w/Permanent Depressor, pack of 3 | 1/4" Access on run x 1/4" female flare w/depressor on female swivel branch end | 3            | PK  | 1           |
| <b>VST-44</b>   | Swivel Tee w/Perm. Depressor, pack of 3     | 1/4" Access on run x 1/4" access on "T" - female swivel on run                 | 3            | PK  | 1           |
| <b>VTR-24</b>   | Threaded Tee, pack of 3                     | 1/8" MPT x 1/4" male flare on run x access on branch                           | 3            | PK  | 1           |
| <b>VTS-10</b>   | Solder Tee Type                             | 5/8" O.D. tube   | 1            | EA  | 1           |
| <b>VTS-12</b>   | Solder Tee Type                             | 3/4" O.D. tube   | 1            | EA  | 1           |
| <b>VTS-14</b>   | Solder Tee Type                             | 7/8" O.D. tube   | 1            | EA  | 1           |
| <b>VTS-46</b>   | Solder Tee Type, pack of 3                  | 1/4" O.D.S. x 5/16" O.D.F.   | 3            | PK  | 1           |
| <b>VTS-56</b>   | Solder Tee Type, pack of 3                  | 5/16" O.D.S. x 3/8" O.D.F.   | 3            | PK  | 1           |
| <b>VTS-68</b>   | Solder Tee Type, pack of 3                  | 3/8" O.D.S.  | 3            | PK  | 1           |
| <b>VTS-810</b>  | Solder Tee Type, pack of 3                  | 1/2" O.D.S.  | 3            | PK  | 1           |
| <b>VTS-3-12</b> | Solder Tube Elbow                           | 3/4" O.D.S.  | 1            | EA  | 1           |
| <b>VTS-3-14</b> | Solder Tube Elbow                           | 7/8" O.D.S.  | 1            | EA  | 1           |
| <b>VC-4</b>     | Flare Cap, pack of 12                       | 1/4"   | 12           | PK  | 1           |
| <b>VC-4R</b>    | Flare Cap w/Core Remover, pack of 12        | 1/4"   | 12           | PK  | 1           |
| <b>VVC-1</b>    | Valve Core, pack of 6                       |  | 6            | PK  | 1           |



**Brass Adapters**

The MSA-45 is used on the new R410 Mini Split systems that have the larger unique fitting on the service valve. The description of that fitting is 1/2" acme Male-20 UN. This adapter will screw onto the 1/2" Acme Male-20 UN fitting and allow you to connect a standard 1/4 service hose to it.



| CATALOG NO.   | DESCRIPTION   | UOM | ORDER MULTIPLE |
|---------------|---|-----|----------------|
| <b>MSA-45</b> | 1/4" Male flare x 1/2" - 20 UNF Female                                  | EA  | 1              |
| <b>MSA-44</b> | 1/4" Female flare swivel w/depressor tip and seal x 1/4" MPT, pack of 2 | PK  | 1              |

**Cop-Cap™ Locking Valve Cover**

An effective way to discourage and prevent the removal of refrigerant. COP-CAP™ fits this standard service valve on all central AC units and mini-splits. It helps prevent access by unauthorized persons and can only be removed with the included special tool. Simply thread COP-CAP™ assembly onto existing 1/4" flare connection on system and lock set screw in place with hex wrench provided.

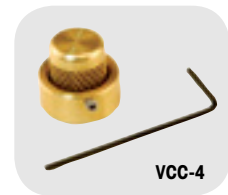

- Seals service valve to prevent leaks
- Prevents illegal venting or theft of refrigerant
- Stops unauthorized access in unsecured areas

| CATALOG NO.   | DESCRIPTION                 | UOM | ORDER MULTIPLE |
|---------------|-----------------------------|-----|----------------|
| <b>VCC-4</b>  | Cop-Cap™, Pack of 2         | PK  | 1              |
| <b>VCC-4B</b> | Cop-Cap™ bulk, 100 per case | EA  | 100            |



**LINE PIERCING VALVES AND TOOLS**

**Quick-Tap**

Features a valve core in the 1/4" male port. Simply pierce the line and back seat the needle. Flow starts when depressor type charging hose is connected. Flow shuts off automatically when hose is removed. If valve core is not desired, it may be removed. Connect hose, pierce line and back seat needle. This method offers full unrestricted flow. Valve core can be removed or changed at any time without loss of refrigerant if needle is front seated.



| CATALOG NO. | DESCRIPTION                                  | UOM | ORDER MULTIPLE |
|-------------|--|-----|----------------|
| QT-1        | Quick-Tap – 1/4", 5/16", 3/8" O.D. Tube Size | EA  | 1              |
| QT-2        | Quick-Tap – 1/2", 5/8" O.D. Tube Size        | EA  | 1              |

**MAC—The Ultimate in Line Piercing Valves**

Install valve. Connect charging hose. Service. That's all there is to it! MAC features uniport: 1 connection for piercing and servicing. Sealed with refrigerant resistant "O" rings. Needle automatically back seats after servicing, leaving line free of restriction. Connect to tubing with 2 socket-head screws. (Hex wrench is included with each valve.) Needle depressor is inserted into head of needle. Wing cap is turned down easily by hand until line is pierced. Wing cap is removed and system may be serviced with any charging hose with built-in depressor. When hose is removed, spring loaded needle back-seats forming a leak proof seal. Needle depressor is discarded and wing cap forms extra precautionary seal.



| CATALOG NO. | DESCRIPTION  | UOM | ORDER MULTIPLE |
|-------------|--|-----|----------------|
| QTM-1       | MAC Line Piercing Valve – 1/4", 5/16", 3/8" O.D. Tube Size | EA  | 36             |
| QTM-2       | MAC Line Piercing Valve – 1/2", 5/8" O.D. Tube Size        | EA  | 36             |

**Copper Saddle Valve**

For copper-to-copper brazing. Penetrates line in one easy operation with no holes to drill. Steel pin with valve core pierces line and is locked into valve body by tightening cap. Teflon ring assures positive seal. Available in sizes from 1/4" to 1-1/8".



| CATALOG NO. | DESCRIPTION  | UOM | ORDER MULTIPLE |
|-------------|--|-----|----------------|
| VLC-4       | Copper Saddle Valve – 1/4" O.D. Tube Size, pack of 6   | PK  | 1              |
| VLC-5       | Copper Saddle Valve – 5/16" O.D. Tube Size, pack of 6  | PK  | 1              |
| VLC-6       | Copper Saddle Valve – 3/8" O.D. Tube Size, pack of 6   | PK  | 1              |
| VLC-8       | Copper Saddle Valve – 1/2" O.D. Tube Size, pack of 4   | PK  | 1              |
| VLC-10      | Copper Saddle Valve – 5/8" O.D. Tube Size, pack of 3   | PK  | 1              |
| VLC-12      | Copper Saddle Valve – 3/4" O.D. Tube Size, pack of 2   | PK  | 1              |
| VLC-18      | Copper Saddle Valve – 1-1/8" O.D. Tube Size, pack of 2 | PK  | 1              |
| VLC-25      | Additional Teflon Rings, pack of 25                    | PK  | 1              |

**Quick-Tap-2**

Identical to Quick-Tap except that a nylon handle replaces the hex wrench. Phillips-head screws are used.



| CATALOG NO. | DESCRIPTION                                    | UOM | ORDER MULTIPLE |
|-------------|--|-----|----------------|
| QTH-1       | Quick-Tap-2 – 1/4", 5/16", 3/8" O.D. Tube Size | EA  | 1              |
| QTH-2       | Quick-Tap-2 – 1/2", 5/8" O.D. Tube Size        | EA  | 1              |

**Insta-Tap Refrigerant Recovery Tool**

The fastest, easiest way to evacuate refrigerant before disposal of a unit. Snaps onto refrigerant line for full and immediate flow. Punctures super large hole for maximum full flow discharge to recovery unit. One tool fits all sizes from 3/16" to 7/8" O.D. hard tubing. Replaceable needle.



| CATALOG NO. | DESCRIPTION                                    | UOM | ORDER MULTIPLE |
|-------------|--|-----|----------------|
| QT-100      | Quick-Tap-2 – 1/4", 5/16", 3/8" O.D. Tube Size | EA  | 1              |
| QT-100N     | Replaceable Hardened Steel Needle and Gasket   | EA  | 1              |
| QT-100G     | Replacement Gasket Only                        | EA  | 3              |

**Core Storer**

All steel valve core remover and storage container. Completely knurled for easier grip, eliminating slippage when using with oily or greasy hands. Core Storer features a compartment for storing extra valve cores. Four replacement cores are included with each tool.



| CATALOG NO. | DESCRIPTION             | UOM | ORDER MULTIPLE |
|-------------|-------------------------|-----|----------------|
| VCR-1       | Core Remover and Storer | EA  | 1              |

**Core Removal Tool**

Designed to remove and replace valve cores without losing the refrigerant charge. Connects to any 1/4" male flare fitting. Saves time, saves refrigerant.



| CATALOG NO. | DESCRIPTION               | UOM | ORDER MULTIPLE |
|-------------|---------------------------|-----|----------------|
| VCRT-1      | Core Removal Tool         | EA  | 1              |
| VCRT-1R     | Replacement Rod Assembly  | EA  | 1              |
| VCRT-1S     | Replacement Shut-off Stem | EA  | 1              |

**BRASS FITTINGS**

**Compression Sleeve**



| CATALOG NO.    | DESCRIPTION             | UOM | ORDER MULTIPLE |
|----------------|-------------------------|-----|----------------|
| <b>D60A-4</b>  | 1/4" Compression Sleeve | EA  | 100            |
| <b>D60A-8</b>  | 1/2" Compression Sleeve | EA  | 100            |
| <b>D60A-10</b> | 5/8" Compression Sleeve | EA  | 100            |

**Compression Nut**



| CATALOG NO.   | DESCRIPTION          | UOM | ORDER MULTIPLE |
|---------------|----------------------|-----|----------------|
| <b>D61A-4</b> | 1/4" Compression Nut | EA  | 10             |
| <b>D61A-8</b> | 1/2" Compression Nut | EA  | 10             |

**Compression Union**



| CATALOG NO.      | DESCRIPTION            | UOM | ORDER MULTIPLE |
|------------------|------------------------|-----|----------------|
| <b>D62A-44</b>   | 1/4" Compression Union | EA  | 10             |
| <b>D62A-66</b>   | 3/8" Compression Union | EA  | 10             |
| <b>D62A-88</b>   | 1/2" Compression Union | EA  | 10             |
| <b>D62A-1010</b> | 5/8" Compression Union | EA  | 10             |

**Flare x MIP Elbow**



| CATALOG NO.    | DESCRIPTION                 | UOM | ORDER MULTIPLE |
|----------------|-----------------------------|-----|----------------|
| <b>DE1-4B</b>  | 1/4" Flare x 1/4" MIP Elbow | EA  | 10             |
| <b>DE1-6C</b>  | 3/8" Flare x 3/8" MIP Elbow | EA  | 10             |
| <b>DE1-8D</b>  | 1/2" Flare x 1/2" MIP Elbow | EA  | 10             |
| <b>DE1-12E</b> | 3/4" Flare x 3/4" MIP Elbow | EA  | 10             |

**Compression Connector**



| CATALOG NO.    | DESCRIPTION                       | UOM | ORDER MULTIPLE |
|----------------|-----------------------------------|-----|----------------|
| <b>D68A-4B</b> | 1/4" x 1/4" Compression Connector | EA  | 10             |
| <b>D68A-6C</b> | 3/8" x 3/8" Compression Connector | EA  | 10             |
| <b>D68A-8D</b> | 1/2" x 1/2" Compression Connector | EA  | 10             |
| <b>D68A-6D</b> | 3/8" x 1/2" Compression Connector | EA  | 10             |

**Compression Elbow**



| CATALOG NO.    | DESCRIPTION                   | UOM | ORDER MULTIPLE |
|----------------|-------------------------------|-----|----------------|
| <b>D69A-4A</b> | 1/4" x 1/8" Compression Elbow | EA  | 10             |
| <b>D69A-8D</b> | 1/2" x 1/2" Compression Elbow | EA  | 10             |

**Compression Tee**



| CATALOG NO.      | DESCRIPTION          | UOM | ORDER MULTIPLE |
|------------------|----------------------|-----|----------------|
| <b>D64A-44</b>   | 1/4" Compression Tee | EA  | 10             |
| <b>D64A-66</b>   | 3/8" Compression Tee | EA  | 10             |
| <b>D64A-88</b>   | 1/2" Compression Tee | EA  | 10             |
| <b>D64A-1010</b> | 5/8" Compression Tee | EA  | 10             |

**Flare x MIP Reducing Elbow**



| CATALOG NO.    | DESCRIPTION                          | UOM | ORDER MULTIPLE |
|----------------|--------------------------------------|-----|----------------|
| <b>DE1-6B</b>  | 3/8" Flare x 1/4" MIP Reducing Elbow | EA  | 10             |
| <b>DE1-6D</b>  | 3/8" Flare x 1/2" MIP Reducing Elbow | EA  | 10             |
| <b>DE1-8E</b>  | 1/2" Flare x 3/4" MIP Reducing Elbow | EA  | 10             |
| <b>DE1-10D</b> | 5/8" Flare x 1/2" MIP Reducing Elbow | EA  | 10             |

### Short Nut



| CATALOG NO. | DESCRIPTION     | UOM | ORDER MULTIPLE |
|-------------|-----------------|-----|----------------|
| DN1-3       | 3/16" Short Nut | EA  | 10             |
| DN1-4       | 1/4" Short Nut  | EA  | 10             |
| DN1-6       | 3/8" Short Nut  | EA  | 10             |
| DN1-10      | 5/8" Short Nut  | EA  | 10             |
| DN1-12      | 3/4" Short Nut  | EA  | 10             |
| DN1-14      | 7/8" Short Nut  | EA  | 5              |

### Cap



| CATALOG NO. | DESCRIPTION | UOM | ORDER MULTIPLE |
|-------------|-------------|-----|----------------|
| DN5-4       | 1/4" Cap    | EA  | 10             |
| DN5-6       | 3/8" Cap    | EA  | 10             |

### Short Forged Flare Nut



| CATALOG NO. | DESCRIPTION                 | UOM | ORDER MULTIPLE |
|-------------|-----------------------------|-----|----------------|
| DNS4-4      | 1/4" Short Forged Flare Nut | EA  | 10             |
| DNS4-6      | 3/8" Short Forged Flare Nut | EA  | 10             |
| DNS4-8      | 1/2" Short Forged Flare Nut | EA  | 10             |
| DNS4-10     | 5/8" Short Forged Flare Nut | EA  | 10             |
| DNS4-12     | 3/4" Short Forged Flare Nut | EA  | 10             |
| DNS4-14     | 7/8" Short Forged Flare Nut | EA  | 5              |

### Plug



| CATALOG NO. | DESCRIPTION | UOM | ORDER MULTIPLE |
|-------------|-------------|-----|----------------|
| DP2-4       | 1/4" Plug   | EA  | 10             |
| DP2-6       | 3/8" Plug   | EA  | 10             |
| DP2-8       | 1/2" Plug   | EA  | 10             |
| DP2-10      | 5/8" Plug   | EA  | 10             |

### Flare Tee



| CATALOG NO. | DESCRIPTION    | UOM | ORDER MULTIPLE |
|-------------|----------------|-----|----------------|
| DT2-4       | 1/4" Flare Tee | EA  | 10             |
| DT2-6       | 3/8" Flare Tee | EA  | 10             |
| DT2-8       | 1/2" Flare Tee | EA  | 10             |
| DT2-10      | 5/8" Flare Tee | EA  | 5              |

### Flare x MIP Union

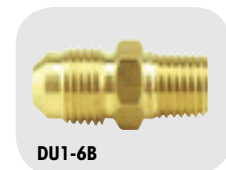

| CATALOG NO. | DESCRIPTION                 | UOM | ORDER MULTIPLE |
|-------------|-----------------------------|-----|----------------|
| DU1-4A      | 1/4" Flare x 1/8" MIP Union | EA  | 10             |
| DU1-4B      | 1/4" Flare x 1/4" MIP Union | EA  | 10             |
| DU1-6B      | 3/8" Flare x 1/4" MIP Union | EA  | 10             |
| DU1-6C      | 3/8" Flare x 3/8" MIP Union | EA  | 10             |
| DU1-6D      | 3/8" Flare x 1/2" MIP Union | EA  | 10             |
| DU1-6E      | 3/8" Flare x 3/4" MIP Union | EA  | 10             |
| DU1-8B      | 1/2" Flare x 1/4" MIP Union | EA  | 10             |
| DU1-8D      | 1/2" Flare x 1/2" MIP Union | EA  | 10             |
| DU1-8E      | 1/2" Flare x 3/4" MIP Union | EA  | 10             |
| DU1-10D     | 5/8" Flare x 1/2" MIP Union | EA  | 10             |
| DU1-10E     | 5/8" Flare x 3/4" MIP Union | EA  | 10             |
| DU1-12D     | 3/4" Flare x 1/2" MIP Union | EA  | 10             |

### Flare Union

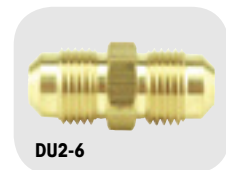

| CATALOG NO. | DESCRIPTION      | UOM | ORDER MULTIPLE |
|-------------|------------------|-----|----------------|
| DU2-4       | 1/4" Flare Union | EA  | 10             |
| DU2-6       | 3/8" Flare Union | EA  | 10             |
| DU2-8       | 1/2" Flare Union | EA  | 10             |
| DU2-10      | 5/8" Flare Union | EA  | 10             |
| DU2-12      | 3/4" Flare Union | EA  | 10             |
| DU2-14      | 7/8" Flare Union | EA  | 5              |

**BRASS FITTINGS cont'd**

**Flare x FIP Union**



| CATALOG NO.    | DESCRIPTION                   | UOM | ORDER MULTIPLE |
|----------------|-------------------------------|-----|----------------|
| <b>DU3-6D</b>  | 3/8" x 1/2" Flare x FIP Union | EA  | 10             |
| <b>DU3-8D</b>  | 1/2" x 1/2" Flare x FIP Union | EA  | 10             |
| <b>DU3-10E</b> | 5/8" x 3/4" Flare x FIP Union | EA  | 10             |

**Flare x Flare Swivel Union**

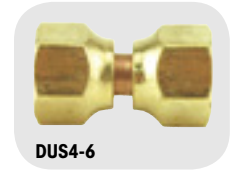

| CATALOG NO.   | DESCRIPTION                          | UOM | ORDER MULTIPLE |
|---------------|--------------------------------------|-----|----------------|
| <b>DUS4-4</b> | 1/4" Flare x 1/4" Flare Swivel Union | EA  | 10             |
| <b>DUS4-6</b> | 3/8" Flare x 3/8" Flare Swivel Union | EA  | 10             |

**CUSHION CLAMPS**

**Cushion Clamps**

An industry standard universal clamp that mounts to standard strut. Steel with electro-dichromate finish to resist corrosion. The lock nut has a nylon insert for a positive lock. The polymeric grommet withstands temperatures from -25°C to 125°C and resists the effects of most oils, chemicals, and industrial cleaning compounds.



| CATALOG NO.      | DESCRIPTION            | UOM | ORDER MULTIPLE |
|------------------|------------------------|-----|----------------|
| <b>538-1/4</b>   | Cushion Clamp – 1/4"   | EA  | 25             |
| <b>538-3/8</b>   | Cushion Clamp – 3/8"   | EA  | 25             |
| <b>538-1/2</b>   | Cushion Clamp – 1/2"   | EA  | 25             |
| <b>538-5/8</b>   | Cushion Clamp – 5/8"   | EA  | 25             |
| <b>538-3/4</b>   | Cushion Clamp – 3/4"   | EA  | 25             |
| <b>538-7/8</b>   | Cushion Clamp – 7/8"   | EA  | 25             |
| <b>538-1-1/8</b> | Cushion Clamp – 1-1/8" | EA  | 10             |
| <b>538-1-3/8</b> | Cushion Clamp – 1-3/8" | EA  | 10             |
| <b>538-1-5/8</b> | Cushion Clamp – 1-5/8" | EA  | 10             |
| <b>538-2-1/8</b> | Cushion Clamp – 2-1/8" | EA  | 10             |
| <b>538-2-5/8</b> | Cushion Clamp – 2-5/8" | EA  | 10             |
| <b>538-3-1/8</b> | Cushion Clamp – 3-1/8" | EA  | 10             |
| <b>538-3-5/8</b> | Cushion Clamp – 3-5/8" | EA  | 10             |
| <b>538-4-1/8</b> | Cushion Clamp – 4-1/8" | EA  | 10             |



### Liquid Line Driers

High moisture and acid capacity. Maximum filtration capacity. Exceptional compatibility with new polyester oils. Compatible with all existing and new refrigerants and blends including 134a, 401A/B, 402A/B, 404A, 407A/B/C, 410A, 502, 507A. Spring loaded, molecular sieve XH-9 dessicant. Solid copper sweat fittings. Powder paint exterior coating surpasses 500 hour ASTM salt spray test and resists corrosion. Eliminates concern of additive stripping.



### Suction Line Driers

The solid-core clean-up dryer was developed for use in a system suction line. The compact design incorporates a large outside diameter shell, which results in a shorter lay-in length, and a larger core, which provides a greater filtration area for maximum operating efficiency. The core material has controlled porosity which effectively removes and holds a maximum amount of contaminants with a minimum of pressure drop. It collects and holds inorganic acids and other harmful contaminants from a motor burnout. This binding process protects the core from acid decomposition. Access valves on both the inlet and outlet sides make it easy to measure pressure accurately. Occasionally, enough contaminant matter may collect in the filter core to cause a slight pressure drop. The access valves on the SLD make it easy to determine if a pressure drop exists and to measure the amount of the drop. The original DSLD, solid core, XH-9 molecular sieve dessicant suction line filter dryer. High acid capacity. Low pressure drop – exceptionally high flow rates. Designed for system clean-up. 500 hours salt spray protection. Shortest system cut-out lengths allow installation in tight areas. Two access valves simplify pressure drop measurement. Flare or solid copper sweat fittings.



| CATALOG NO. | VIRGINIA KMP  | CONNECTION | CUBIC INCH | UOM | ORDER MULTIPLE |
|-------------|---------------|------------|------------|-----|----------------|
| DAD032      | WLD-032 FLARE | 1/4        | 3          | EA  | 1              |
| DAD032S     | WLD-032 SWEAT | 1/4        | 3          | EA  | 1              |
| DAD052      | WLD-052 FLARE | 1/4        | 5          | EA  | 1              |
| DAD052S     | WLD-052 SWEAT | 1/4        | 5          | EA  | 1              |
| DAD053S     | WLD-053 SWEAT | 3/8        | 5          | EA  | 1              |
| DAD082      | WLD-082 FLARE | 1/4        | 8          | EA  | 1              |
| DAD082S     | WLD-082 SWEAT | 1/4        | 8          | EA  | 1              |
| DAD083S     | WLD-083 SWEAT | 3/8        | 8          | EA  | 1              |
| DAD084S     | WLD-084 SWEAT | 1/2        | 8          | EA  | 1              |
| DAD163      | WLD-163 FLARE | 3/8        | 16         | EA  | 1              |
| DAD163S     | WLD-163 SWEAT | 3/8        | 16         | EA  | 1              |
| DAD164S     | WLD-164 SWEAT | 1/2        | 16         | EA  | 1              |
| DAD303      | WLD303 FLARE  | 3/8        | 30         | EA  | 1              |
| DAD303S     | WLD-303 SWEAT | 3/8        | 30         | EA  | 1              |
| DAD304S     | WLD-304 SWEAT | 1/2        | 30         | EA  | 1              |
| DAD305      | WLD-305 FLARE | 5/8        | 30         | EA  | 1              |
| DAD305S     | WLD-305 SWEAT | 5/8        | 30         | EA  | 1              |

| CATALOG NO.  | VIRGINIA KMP     | CONNECTION | CUBIC INCH | UOM | ORDER MULTIPLE |
|--------------|------------------|------------|------------|-----|----------------|
| DSL13-5SVHH  | AL-24-55C Sweat  | 5/8        | 13         | EA  | 1              |
| DSL13-6SVHH  | AL-30-6SC Sweat  | 3/4        | 13         | EA  | 1              |
| DSL27-7SVHH  | AL-30-7SC Sweat  | 7/8        | 27         | EA  | 1              |
| DSL27-9SVHH  | AL-44-9SC Sweat  | 1-1/8      | 27         | EA  | 1              |
| DSL54-11SVHH | AL-75-11SC Sweat | 1-3/8      | 54         | EA  | 1              |
| DSS-SLD306SV | VSD-6 & S Sweat  | 3/4        | 30         | EA  | 1              |
| DSS-SLD307SV | VSD-7 & S Sweat  | 7/8        | 30         | EA  | 1              |

### Universal Spun Copper Driers

Manufactured with the latest generation molecular sieves compatible with more than 20 different types of refrigerants, including R-134A. They can be used in all hermetic and open refrigeration systems using CFC, HCFC and HFC gases and mixes such as commercial and domestic refrigerators, freezers and air conditioners ranging from 1/8 to 2.0 HP. Hermetically sealed with extended ends.

| CATALOG NO. | OUTLET   | INLET | DIAMETER | LENGTH GRAMS | DESSICANT R12 | RECOMM. R22 | TONNAGE QUANTITY | UOM | ORDER MULTIPLE |
|-------------|----------|-------|----------|--------------|---------------|-------------|------------------|-----|----------------|
| DX-3        | 1/4"     | 1/4"  | 3/4"     | 7-11/16"     | 10            | 1/3         | 1/2              | EA  | 24             |
| DX-4        | Multiple | 1/4"  | 1"       | 9"           | 18            | 3/4         | 1-1/2            | EA  | 1              |
| DXA-5       | 1/4"     | 1/4"  | 1"       | 9-1/4"       | 20            | 3/4         | 1-1/2            | EA  | 1              |



**DRIERS, SIGHT GLASSES cont'd**

**Bi Flow Driers**

The "DBF" Series is designed specifically for heat pump or reverse cycle application. External check valves are not required since they are incorporated within the filter dryer shell. The core design filters out contaminant particles down to 25 microns. 100% copper sweat or nickel plated flare fittings. Desiccant core provides reliable and effective, removal of solid contaminants, acid and moisture. Provides three times the filtration as the standard bi-flow. Core is cushioned in fiber gaskets to protect core and to insure trouble-free performance. Powder paint exterior coating surpasses 500 hour ASTM salt spray test and resists corrosion.



**DBF163S**

| CATALOG NO.    | VIRGINIA KMP   | CONNECTION | CUBIC INCH | UOM | ORDER MULTIPLE |
|----------------|----------------|------------|------------|-----|----------------|
| <b>DBF083</b>  | V2A-083 Flare  | 3/8        | 8          | EA  | 1              |
| <b>DBF083S</b> | V2A-083 Sweat  | 3/8        | 8          | EA  | 1              |
| <b>DBF084</b>  | V2A-084 Flare  | 1/2        | 8          | EA  | 1              |
| <b>DBF084S</b> | V2A-084 Sweat  | 1/2        | 8          | EA  | 1              |
| <b>DBF163</b>  | V2A-163 Flare  | 3/8        | 16         | EA  | 1              |
| <b>DBF163S</b> | V2A-163 Sweat  | 3/8        | 16         | EA  | 1              |
| <b>DBF164S</b> | V2A-164 Sweat  | 1/2        | 16         | EA  | 1              |
| <b>DBF165S</b> | V2A-165S Sweat | 5/8        | 16         | EA  | 1              |

**Sight Glasses**

Sight Glass and Moisture Indicator provides a quick visual diagnosis of refrigerant and moisture levels within a system. The sight glass indicates if the system has the proper refrigerant level, a restricted dryer or excessive pressure-drop. The moisture indicator recognizes moisture within the system. Provides early warning that a potential failure exists resulting in corrosion, chemical damage, restricted flow, or even compressor failure. Etch-resistant glass with a simple color comparison provides easy viewing and quick diagnostics. Flare models feature forged brass body and fittings for corrosion resistance. Sweat models feature copper fittings to permit solder installation without disassembly. Leak-proof design is compact and short in length to easily fit within a unit and provide accuracy in performance.



**DPSG-2**

| CATALOG NO.     | VIRGINIA KMP | DESCRIPTION | CONNECTION | UOM | ORDER MULTIPLE |
|-----------------|--------------|-------------|------------|-----|----------------|
| <b>DPSG-2</b>   | LDE-2        | FLARE       | 1/4        | EA  | 1              |
| <b>DPSG-3</b>   | LDE-3        | FLARE       | 3/8        | EA  | 1              |
| <b>DPSG-4</b>   | LDE-4        | FLARE       | 1/2        | EA  | 1              |
| <b>DPSG-2MF</b> | LDE-2-MF     | MALE/FEMALE | 1/4        | EA  | 1              |
| <b>DPSG-3MF</b> | LDE-3-MF     | MALE/FEMALE | 3/8        | EA  | 1              |
| <b>DPSG-4MF</b> | LDE-4-MF     | MALE/FEMALE | 1/2        | EA  | 1              |
| <b>DPSG-2S</b>  | LDE-2-S      | SWEAT       | 1/4        | EA  | 1              |
| <b>DPSG-3S</b>  | LDE-3-S      | SWEAT       | 3/8        | EA  | 1              |

**REFRIGERANT CHARGING**

**Insta-Charge**

Faster, safer and more economical method for charging LIQUID refrigerant through the low pressure side of an air conditioning or refrigeration system, without damaging the compressor. Insta-Charge's unique internal restrictor reduces liquid flow to a level below the capacity of the compressor. Converts liquid refrigerant to a saturated vapor for fast entry. Insta-Charge connects directly to the refrigerant can or cylinder valve. Adds liquid tracing dye faster. Eliminates heating of refrigerant cylinder. Made of light weight aluminum. Sold at a fraction of the cost of other fast charging devices.



**RC-1**

| CATALOG NO. | DESCRIPTION  | UOM | ORDER MULTIPLE |
|-------------|--------------|-----|----------------|
| <b>RC-1</b> | Insta-Charge | EA  | 1              |

### DiversiTech Line Sets

DiversiTech Line Sets are individually packaged in sturdy corrugated cardboard, designed and tested for individual parcel shipment.

Line Sets are designed for air conditioning and refrigeration systems. The copper tube is refrigeration grade tubing to ASTM B280. The suction line is pre-insulated with Armaflex AP pipe insulation. This insulation is a black flexible elastomeric thermal insulation. The expanded closed-cell structure makes it an efficient insulation. It is manufactured without the use of CFC's, HFC's or HCFC's. AP Armaflex contains Microban® antimicrobial product protection for added defense against mold on the

insulation. DiversiTech Min-Split Line Sets are similar to Standard Line Sets but come with additional insulation on the liquid line and flared line ends. Copper tubing complies with ASTM B280 for Seamless Copper Tube for ACR.

AP Armaflex insulation meets ASTM C534, Type I – Tubular Grade 1, ASTM E84, NFPA 255, UL723, CAN/ULC S102, UL94 5V-5A, V-0 (E55798), NFPA 90A/90B, UL181, ASTM G21/C1338, ASTM G22, ASTM D1056 2B1, MIL-P-15280J form T, MIL-C-3133C grade SBE3, MEA 96-85-M, and City of LA RR7642.



D40680250B3B6

#### STANDARD LINE SETS

| CATALOG NO. | LENGTH (FT) | INSULATION WALL | SUCTION LINE | LIQUID LINE | UOM | ORDER MULTIPLE |
|-------------|-------------|-----------------|--------------|-------------|-----|----------------|
| D61220250   | 25          | 1/2             | 3/4          | 3/8         | EA  | 1              |
| D61220300   | 30          | 1/2             | 3/4          | 3/8         | EA  | 1              |
| D61220350   | 35          | 1/2             | 3/4          | 3/8         | EA  | 1              |
| D61220400   | 40          | 1/2             | 3/4          | 3/8         | EA  | 1              |
| D61220500   | 50          | 1/2             | 3/4          | 3/8         | EA  | 1              |
| D61230250   | 25          | 3/4             | 3/4          | 3/8         | EA  | 1              |
| D61230300   | 30          | 3/4             | 3/4          | 3/8         | EA  | 1              |
| D61230350   | 35          | 3/4             | 3/4          | 3/8         | EA  | 1              |
| D61230400   | 40          | 3/4             | 3/4          | 3/8         | EA  | 1              |
| D61230500   | 50          | 3/4             | 3/4          | 3/8         | EA  | 1              |
| D61280250   | 25          | 3/8             | 3/4          | 3/8         | EA  | 1              |
| D61280300   | 30          | 3/8             | 3/4          | 3/8         | EA  | 1              |
| D61280350   | 35          | 3/8             | 3/4          | 3/8         | EA  | 1              |
| D61280400   | 40          | 3/8             | 3/4          | 3/8         | EA  | 1              |
| D61280500   | 50          | 3/8             | 3/4          | 3/8         | EA  | 1              |
| D61420250   | 25          | 1/2             | 7/8          | 3/8         | EA  | 1              |
| D61420300   | 30          | 1/2             | 7/8          | 3/8         | EA  | 1              |
| D61420350   | 35          | 1/2             | 7/8          | 3/8         | EA  | 1              |
| D61420400   | 40          | 1/2             | 7/8          | 3/8         | EA  | 1              |
| D61420500   | 50          | 1/2             | 7/8          | 3/8         | EA  | 1              |
| D61430250   | 25          | 3/4             | 7/8          | 3/8         | EA  | 1              |
| D61430300   | 30          | 3/4             | 7/8          | 3/8         | EA  | 1              |
| D61430350   | 35          | 3/4             | 7/8          | 3/8         | EA  | 1              |
| D61430400   | 40          | 3/4             | 7/8          | 3/8         | EA  | 1              |
| D61430500   | 50          | 3/4             | 7/8          | 3/8         | EA  | 1              |
| D61480250   | 25          | 3/8             | 7/8          | 3/8         | EA  | 1              |
| D61480300   | 30          | 3/8             | 7/8          | 3/8         | EA  | 1              |
| D61480350   | 35          | 3/8             | 7/8          | 3/8         | EA  | 1              |
| D61480400   | 40          | 3/8             | 7/8          | 3/8         | EA  | 1              |
| D61480500   | 50          | 3/8             | 7/8          | 3/8         | EA  | 1              |
| D61820250   | 25          | 3/8             | 1-1/8        | 1/2         | EA  | 1              |
| D61820500   | 50          | 3/8             | 1-1/8        | 1/2         | EA  | 1              |
| D61830250   | 25          | 3/4             | 1-1/8        | 3/8         | EA  | 1              |
| D61830300   | 30          | 3/4             | 1-1/8        | 3/8         | EA  | 1              |
| D61830350   | 35          | 3/4             | 1-1/8        | 3/8         | EA  | 1              |
| D61830400   | 40          | 3/4             | 1-1/8        | 3/8         | EA  | 1              |
| D61830500   | 50          | 3/4             | 1-1/8        | 3/8         | EA  | 1              |
| D61880250   | 25          | 3/8             | 1-1/8        | 3/8         | EA  | 1              |
| D61880300   | 30          | 3/8             | 1-1/8        | 3/8         | EA  | 1              |
| D61880350   | 35          | 3/8             | 1-1/8        | 3/8         | EA  | 1              |
| D61880400   | 40          | 3/8             | 1-1/8        | 3/8         | EA  | 1              |
| D61880500   | 50          | 3/8             | 1-1/8        | 3/8         | EA  | 1              |

#### MINI-SPLIT LINE SETS

| CATALOG NO.   | LENGTH (FT) | INSULATION WALL | SUCTION LINE | LIQUID LINE | UOM | ORDER MULTIPLE |
|---------------|-------------|-----------------|--------------|-------------|-----|----------------|
| D40680250B3B6 | 25          | 3/8             | 3/8          | 1/4         | EA  | 1              |
| D40680350B3B6 | 35          | 3/8             | 3/8          | 1/4         | EA  | 1              |
| D40680500B3B6 | 50          | 3/8             | 3/8          | 1/4         | EA  | 1              |
| D40880250B3B6 | 25          | 3/8             | 1/2          | 1/4         | EA  | 1              |
| D40880350B3B6 | 35          | 3/8             | 1/2          | 1/4         | EA  | 1              |
| D40880500B3B6 | 50          | 3/8             | 1/2          | 1/4         | EA  | 1              |
| D41080250B3B6 | 25          | 3/8             | 5/8          | 1/4         | EA  | 1              |
| D41080350B3B6 | 35          | 3/8             | 5/8          | 1/4         | EA  | 1              |
| D41080500B3B6 | 50          | 3/8             | 5/8          | 1/4         | EA  | 1              |
| D61080250B3B6 | 25          | 3/8             | 5/8          | 3/8         | EA  | 1              |
| D61080350B3B6 | 35          | 3/8             | 5/8          | 3/8         | EA  | 1              |
| D61080500B3B6 | 50          | 3/8             | 5/8          | 3/8         | EA  | 1              |
| D40620250B3B6 | 25          | 1/2             | 3/8          | 1/4         | EA  | 1              |
| D40620350B3B6 | 35          | 1/2             | 3/8          | 1/4         | EA  | 1              |
| D40620500B3B6 | 50          | 1/2             | 3/8          | 1/4         | EA  | 1              |
| D40820250B3B6 | 25          | 1/2             | 1/2          | 1/4         | EA  | 1              |
| D40820350B3B6 | 35          | 1/2             | 1/2          | 1/4         | EA  | 1              |
| D40820500B3B6 | 50          | 1/2             | 1/2          | 1/4         | EA  | 1              |
| D41020250B3B6 | 25          | 1/2             | 5/8          | 1/4         | EA  | 1              |
| D41020350B3B6 | 35          | 1/2             | 5/8          | 1/4         | EA  | 1              |
| D41020500B3B6 | 50          | 1/2             | 5/8          | 1/4         | EA  | 1              |
| D61020250B3B6 | 25          | 1/2             | 5/8          | 3/8         | EA  | 1              |
| D61020350B3B6 | 35          | 1/2             | 5/8          | 3/8         | EA  | 1              |
| D61020500B3B6 | 50          | 1/2             | 5/8          | 3/8         | EA  | 1              |

*If ordering by pallet, 15 line sets are packed per pallet.*

**REFRIGERANT TUBING cont'd**

**White Pipe™**

White Pipe pre-insulated refrigerant line is ideal for a variety of installation jobs and works for every air conditioning application including ductless mini-split, heat pump and centralized air ducted units. Available in a variety of sizes and lengths.



| CATALOG NO. | DESCRIPTION                       | UOM | ORDER MULTIPLE |
|-------------|-----------------------------------|-----|----------------|
| WP1214-50   | White Pipe, 1/4 x 1/2 in x 50 ft  | EA  | 13             |
| WP1238-50   | White Pipe, 3/8 x 1/2 in x 50 ft  | EA  | 11             |
| WP1212-50   | White Pipe, 1/2 x 1/2 in x 50 ft  | EA  | 10             |
| WP1258-50   | White Pipe, 5/8 x 1/2 in x 50 ft  | EA  | 7              |
| WP1234-50   | White Pipe, 3/4 x 1/2 in x 50 ft  | EA  | 5              |
| WP1278-50   | White Pipe, 7/8 x 1/2 in x 50 ft  | EA  | 5              |
| WP1214-164  | White Pipe, 1/4 x 1/2 in x 164 ft | EA  | 5              |
| WP1238-164  | White Pipe, 3/8 x 1/2 in x 164 ft | EA  | 4              |
| WP1212-164  | White Pipe, 1/2 x 1/2 in x 164 ft | EA  | 4              |
| WP1258-164  | White Pipe, 5/8 x 1/2 in x 164 ft | EA  | 3              |
| WP1234-82   | White Pipe, 3/4 x 1/2 in x 82 ft  | EA  | 3              |
| WP1278-82   | White Pipe, 7/8 x 1/2 in x 82 ft  | EA  | 3              |

**Flexible Refrigerant Line**

Flexible Refrigerant Line, with installed flare nut, allows a kink-free connection from the mini-split wall unit to the lineset for easier and faster installation.



| CATALOG NO. | DESCRIPTION                               | UOM | ORDER MULTIPLE |
|-------------|---|-----|----------------|
| FRL14-F     | Flexible Refrigerant Line – 1/4 in. x 36" | EA  | 5              |
| FRL38-F     | Flexible Refrigerant Line – 3/8 in. x 36" | EA  | 5              |
| FRL12-F     | Flexible Refrigerant Line – 1/2 in. x 36" | EA  | 5              |
| FRL58-F     | Flexible Refrigerant Line – 5/8 in. x 36" | EA  | 5              |

**REVERSING VALVES**

**Reversing Valves**

The DiversiTech line of 4-Way Reversing Valves are optimally designed as drop in replacements for the most popular heat pump applications. See the cross reference chart for Sanhua and Ranco Crosses. Solenoid Coils sold separately.



| CATALOG NO.      | DESCRIPTION                                 | UOM | ORDER MULTIPLE |
|------------------|---|-----|----------------|
| DRV2-408060-170  | 4-Way Reversing Valve 3/8" x 1/2" 2 Tons    | EA  | 1              |
| DRV2-408060-270  | 4-Way Reversing Valve 3/8" x 1/2" 2 Tons U  | EA  | 1              |
| DRV3-410080-770  | 4-Way Reversing Valve 1/2" x 5/8" 3 Tons    | EA  | 1              |
| DRV3-412080-870  | 4-Way Reversing Valve 1/2" x 5/8" 3 Tons    | EA  | 1              |
| DRV6-412080-170  | 4-Way Reversing Valve 1/2" x 3/4" 5 Tons    | EA  | 1              |
| DRV6-414080-170  | 4-Way Reversing Valve 1/2" x 7/8" 5 Tons    | EA  | 1              |
| DRV6-414120-170  | 4-Way Reversing Valve 3/4" x 7/8" 5 Tons    | EA  | 1              |
| DRV10-414120-170 | 4-Way Reversing Valve 3/4" x 7/8" 10 Tons   | EA  | 1              |
| DRV10-414080-170 | 4-Way Reversing Valve 1/2" x 7/8" 10 Tons   | EA  | 1              |
| DRV10-418140-170 | 4-Way Reversing Valve 7/8" x 1-1/8" 10 Tons | EA  | 1              |
| SHF-4-10FA4      | 24 Volt Solenoid Coil                       | EA  | 1              |
| SHF-4-10FA2      | 120 Volt Solenoid Coil                      | EA  | 1              |
| SHF-4-10FA5      | 220 Volt Solenoid Coil                      | EA  | 1              |



## REFRIGERANT LABELS

### DiversiTech Refrigerant ID Labels

These 3" x 4" self-adhesive vinyl labels use a high-tack acrylic adhesive and UV cured screen printing. Color coded to conform to refrigerant labeling convention. Each label indicates the type of refrigerant (eg. R-11), the chemical name (eg. Trichloromonofluoromethane) and the UN No. (eg. UN 1078). Avoid costly mistakes by properly identifying the type of refrigerant contained in recovery cylinders and air conditioning and refrigeration equipment.



### DiversiTech Refrigerant ID Labels (cont'd)

| CATALOG NO.   | DESCRIPTION                            | UOM | ORDER MULTIPLE |
|---|--|-----|----------------|
| <b>SYSTEM REFRIGERANT/OIL LABELS (3" x 4")</b>          |  |     |                |
| <b>04850</b>  | Refrigerant Removed Labels, pack of 10 | PK  | 1              |
| <b>SYSTEM LUBRICANT IDENTIFICATION LABELS (2" x 3")</b> |  |     |                |
| <b>04871</b>  | Mineral Oil Labels, pack of 10         | PK  | 1              |
| <b>04872</b>  | Alkylbenzene Oil Labels, pack of 10    | PK  | 1              |

| CATALOG NO.  | DESCRIPTION  | UOM | ORDER MULTIPLE |
|--|--|-----|----------------|
| <b>REFRIGERANT IDENTIFICATION LABELS (3" x 4")</b> |  |     |                |
| <b>04010</b>                                       | R-408A (FX10) Refrigerant ID Labels, pack of 10              | PK  | 1              |
| <b>04011</b>                                       | R-11 Refrigerant ID Labels, pack of 10                       | PK  | 1              |
| <b>04012</b>                                       | R-12 Refrigerant ID Labels, pack of 10                       | PK  | 1              |
| <b>04022</b>                                       | R-22 Refrigerant ID Labels, pack of 10                       | PK  | 1              |
| <b>04134</b>                                       | R-134a Refrigerant ID Labels, pack of 10                     | PK  | 1              |
| <b>04402</b>                                       | R-402A (HP80) Refrigerant ID Labels, pack of 10              | PK  | 1              |
| <b>04404</b>                                       | R-404A (HP62/FX70) Refrigerant ID Labels, pack of 10         | PK  | 1              |
| <b>04407</b>                                       | R-407C (SUVA 9000/KLEA 66) Refrigerant ID Labels, pack of 10 | PK  | 1              |
| <b>04410</b>                                       | R-410A (AZ20) Refrigerant ID Labels, pack of 10              | PK  | 1              |
| <b>04421</b>                                       | R-421A Refrigerant ID Labels, pack of 10                     | PK  | 1              |
| <b>04451</b>                                       | R-401B (MP66) Refrigerant ID Labels, pack of 10              | PK  | 1              |
| <b>04500</b>                                       | R-500 Refrigerant ID Labels, pack of 10                      | PK  | 1              |
| <b>04507</b>                                       | R-507 (AZ50) Refrigerant ID Labels, pack of 10               | PK  | 1              |

## REFRIGERANT RECOVERY PRODUCTS

### Refrigerant Recovery Cylinders

DOT Classified for recovery, recycling, service and reclaim. Liquid and vapor valves ("Y" valve or separate valve configurations) are installed in all cylinders. Painted yellow/gray per ARI guidelines. Float switches have 3-pin Brad Harrison connectors.

| CATALOG NO.  | DESCRIPTION | DOT CLASS | 3/4" NPT PLUG | FLOAT SWITCH | WATER CAP. | TARE WT. | UOM | ORDER MULTIPLE |
|--------------|-------------|-----------|---------------|--------------|------------|----------|-----|----------------|
| <b>02033</b> | 30 lb.      | 4BA400    | YES           | NO           | 26.2 lbs.  | 17 lbs.  | EA  | 1              |
| <b>02053</b> | 50 lb.      | 4BA400    | YES           | NO           | 47.7 lbs.  | 28 lbs.  | EA  | 1              |
| <b>02100</b> | 100 lb.     | 4BW400    | NO            | NO           | 123 lbs.   | 48 lbs.  | EA  | 1              |
| <b>02255</b> | 250 lb.     | 4BW260    | YES           | NO           | 239 lbs.   | 85 lbs.  | EA  | 1              |



**Caution:** Never overfill cylinders. Maximum refrigerant capacity is limited to 80% of the water capacity of the cylinder in lbs. (see table above). DOT requires cylinders to be retested every five years. Some recovery equipment uses weight scales to cut off refrigerant fill at 80% of capacity. Be sure cylinder tare weight is correct for this type of equipment.

**DOT Classification Example:** 4BA400: 400 psi working pressure; 800 psi test pressure (double the working pressure); 1,600 psi minimum burst pressure (double the test pressure). Pressure relief/safety valve is set to release at between 75-100% of the test pressure. For example, in the 4BA400 tanks which have a 800 psi test pressure, the relief valve opens at between 600 psi and 800 psi.

**SENTRY REFRIGERANT LOCKING CAPS**

**Sentry™ Refrigerant Locking Caps - R-410, Red, 1/4"**

The Sentry™ Refrigerant Locking Caps are quick and easy way to comply with the IRC and IMC codes requirement that all outdoor access ports on A/C and refrigerant equipment have to be tamper resistant. This cap is anodized in red color for easy identification of R-410 refrigerant. It is designed for 1/4" access ports. An O-ring seal is also pre-installed to prevent leaks.

**RSC-RED-02**



| CATALOG NO.        | DESCRIPTION   | UOM | ORDER MULTIPLE |
|--------------------|---|-----|----------------|
| <b>RSC-RED-02</b>  | Sentry™ Refrigerant Locking Caps - 1/4", Red, 2 pcs Pack w/ Universal Key   | PK  | 1              |
| <b>RSC-RED-04K</b> | Sentry™ Refrigerant Locking Caps - 1/4", Red, 4 pcs Pack w/ Universal Key   | PK  | 1              |
| <b>RSC-RED-10</b>  | Sentry™ Refrigerant Locking Caps - 1/4", Red, 10 pcs Pack                   | PK  | 1              |
| <b>RSC-RED-50K</b> | Sentry™ Refrigerant Locking Caps - 1/4", Red, 50 pcs Pack w/ Universal Keys | PK  | 1              |

**Sentry™ Refrigerant Locking Caps - R-410, Red, 5/16"**

The Sentry™ Refrigerant Locking Caps are quick and easy way to comply with the IRC and IMC codes requirement that all outdoor access ports on A/C and refrigerant equipment have to be tamper resistant. This cap is anodized in red color for easy identification of R-410 refrigerant. It is designed for 5/16" access ports typically used on mini-splits and European styles of A/C systems. An O-ring seal is also pre-installed to prevent leaks.

**RSC-RED-02-E**



| CATALOG NO.          | DESCRIPTION  | UOM | ORDER MULTIPLE |
|----------------------|--|-----|----------------|
| <b>RSC-RED-02-E</b>  | Sentry™ Refrigerant Locking Caps - 5/16", Red, 2 pcs Pack w/ Universal Key   | PK  | 1              |
| <b>RSC-RED-04K-E</b> | Sentry™ Refrigerant Locking Caps - 5/16", Red, 4 pcs Pack w/ Universal Key   | PK  | 1              |
| <b>RSC-RED-10-E</b>  | Sentry™ Refrigerant Locking Caps - 5/16", Red, 10 pcs Pack                   | PK  | 1              |
| <b>RSC-RED-50K-E</b> | Sentry™ Refrigerant Locking Caps - 5/16", Red, 50 pcs Pack w/ Universal Keys | PK  | 1              |

**Sentry™ Universal Key for Refrigerant Locking Caps**

This Universal Key is not only for DiversiTech's Sentry™ Refrigerant Locking Caps. It has three different keys that is fit to lock and unlock most of the refrigerant locking caps in the market. It is compact and easy to carry. This is the key contractors needed to get the job done!

**RSC-TOOL**



| CATALOG NO.     | DESCRIPTION                                | UOM | ORDER MULTIPLE |
|-----------------|--|-----|----------------|
| <b>RSC-TOOL</b> | Universal Key for Refrigerant Locking Caps | EA  | 1              |

**Sentry™ Refrigerant Locking Caps - R-22, Green, 1/4"**

The Sentry™ Refrigerant Locking Caps are quick and easy way to comply with the IRC and IMC codes requirement that all outdoor access ports on A/C and refrigerant equipment have to be tamper resistant. This cap is anodized in green color for easy identification of R-22 refrigerant. It is designed for 1/4" access ports. An O-ring seal is also pre-installed to prevent leaks.

**RSC-GRN-02**



| CATALOG NO.        | DESCRIPTION   | UOM | ORDER MULTIPLE |
|--------------------|---|-----|----------------|
| <b>RSC-GRN-02</b>  | Sentry™ Refrigerant Locking Caps - 1/4", Green, 2 pcs Pack w/ Universal Key   | PK  | 1              |
| <b>RSC-GRN-04K</b> | Sentry™ Refrigerant Locking Caps - 1/4", Green, 4 pcs Pack w/ Universal Key   | PK  | 1              |
| <b>RSC-GRN-10</b>  | Sentry™ Refrigerant Locking Caps - 1/4", Green, 10 pcs Pack                   | PK  | 1              |
| <b>RSC-GRN-50K</b> | Sentry™ Refrigerant Locking Caps - 1/4", Green, 50 pcs Pack w/ Universal Keys | PK  | 1              |

**Sentry™ Refrigerant Locking Caps - Universal, Silver, 1/4"**

The Sentry™ Refrigerant Locking Caps are quick and easy way to comply with the IRC and IMC codes requirement that all outdoor access ports on A/C and refrigerant equipment have to be tamper resistant. This cap is anodized in silver color and could be used on different types of refrigerants. It is designed for 1/4" access ports. An O-ring seal is also pre-installed to prevent leaks.

**RSC-SLV-02**



| CATALOG NO.        | DESCRIPTION  | UOM | ORDER MULTIPLE |
|--------------------|--|-----|----------------|
| <b>RSC-SLV-02</b>  | Sentry™ Refrigerant Locking Caps - 1/4", Silver, 2 pcs Pack w/ Universal Key   | PK  | 1              |
| <b>RSC-SLV-04K</b> | Sentry™ Refrigerant Locking Caps - 1/4", Silver, 4 pcs Pack w/ Universal Key   | PK  | 1              |
| <b>RSC-SLV-10</b>  | Sentry™ Refrigerant Locking Caps - 1/4", Silver, 10 pcs Pack                   | PK  | 1              |
| <b>RSC-SLV-50K</b> | Sentry™ Refrigerant Locking Caps - 1/4", Silver, 50 pcs Pack w/ Universal Keys | PK  | 1              |
| <b>RSC-SLV-500</b> | Sentry™ Refrigerant Locking Caps - 1/4", Silver, 500 pcs Pack                  | PK  | 1              |



### Tubing Insulation

Highest quality tubing insulation by Armacell. AC Accoflex® tubing insulation is a flexible rubber product from the inventors of elastomeric foam insulation. It is designed exclusively for HVAC, with a tough surface and excellent resistance to ultraviolet damage, condensation and mold.



#### 3/8" WALL

| CATALOG NO. | DESCRIPTION                         | UOM | ORDER MULTIPLE |
|-------------|-------------------------------------|-----|----------------|
| 7-3838      | 3/8" ID x 3/8" Wall, pack of 600'   | PK  | 1              |
| 7-3812      | 1/2" ID x 3/8" Wall, pack of 480'   | PK  | 1              |
| 7-3858      | 5/8" ID x 3/8" Wall, pack of 390'   | PK  | 1              |
| 7-3834      | 3/4" ID x 3/8" Wall, pack of 330'   | PK  | 1              |
| 7-3878      | 7/8" ID x 3/8" Wall, pack of 270'   | PK  | 1              |
| 7-381-18    | 1-1/8" ID x 3/8" Wall, pack of 210' | PK  | 1              |
| 7-381-38    | 1-3/8" ID x 3/8" Wall, pack of 180' | PK  | 1              |
| 7-381-58    | 1-5/8" ID x 3/8" Wall, pack of 120' | PK  | 1              |
| 7-382-18    | 2-1/8" ID x 3/8" Wall, pack of 96'  | PK  | 1              |
| 7-382-58    | 2-5/8" ID x 3/8" Wall, pack of 72'  | PK  | 1              |

#### 1/2" WALL

| CATALOG NO. | DESCRIPTION                         | UOM | ORDER MULTIPLE |
|-------------|-------------------------------------|-----|----------------|
| 7-1238      | 3/8" ID x 1/2" Wall, pack of 450'   | PK  | 1              |
| 7-1212      | 1/2" ID x 1/2" Wall, pack of 396'   | PK  | 1              |
| 7-1258      | 5/8" ID x 1/2" Wall, pack of 300'   | PK  | 1              |
| 7-1234      | 3/4" ID x 1/2" Wall, pack of 240'   | PK  | 1              |
| 7-1278      | 7/8" ID x 1/2" Wall, pack of 210'   | PK  | 1              |
| 7-121-18    | 1-1/8" ID x 1/2" Wall, pack of 150' | PK  | 1              |
| 7-121-38    | 1-3/8" ID x 1/2" Wall, pack of 120' | PK  | 1              |
| 7-121-58    | 1-5/8" ID x 1/2" Wall, pack of 90'  | PK  | 1              |
| 7-122-18    | 2-1/8" ID x 1/2" Wall, pack of 60'  | PK  | 1              |
| 7-122-58    | 2-5/8" ID x 1/2" Wall, pack of 60'  | PK  | 1              |
| 7-123-18    | 3-1/8" ID x 1/2" Wall, pack of 42'  | PK  | 1              |

#### 3/4" WALL

| CATALOG NO. | DESCRIPTION                        | UOM | ORDER MULTIPLE |
|-------------|------------------------------------|-----|----------------|
| 7-3438      | 3/8" ID x 3/4" Wall, pack of 240'  | PK  | 1              |
| 7-3412      | 1/2" ID x 3/4" Wall, pack of 210'  | PK  | 1              |
| 7-3458      | 5/8" ID x 3/4" Wall, pack of 144'  | PK  | 1              |
| 7-3434      | 3/4" ID x 3/4" Wall, pack of 138'  | PK  | 1              |
| 7-3478      | 7/8" ID x 3/4" Wall, pack of 120'  | PK  | 1              |
| 7-341-18    | 1-1/8" ID x 3/4" Wall, pack of 90' | PK  | 1              |
| 7-341-58    | 1-5/8" ID x 3/4" Wall, pack of 60' | PK  | 1              |
| 7-342-18    | 2-1/8" ID x 3/4" Wall, pack of 54' | PK  | 1              |
| 7-342-58    | 2-5/8" ID x 3/4" Wall, pack of 48' | PK  | 1              |

#### 1" WALL

| CATALOG NO. | DESCRIPTION                     | UOM | ORDER MULTIPLE |
|-------------|---------------------------------|-----|----------------|
| 7-1058      | 5/8" ID x 1" Wall, pack of 120' | PK  | 1              |
| 7-1078      | 7/8" ID x 1" Wall, pack of 90'  | PK  | 1              |

# Triple-D®

## Universal Coil Cleaner

Triple-D is a Universal Coil Cleaner suitable for use on condenser and evaporator coils. It is metal safe and does not attack aluminum or copper coil components, extending equipment life and diminishing potential for refrigerant leaks. Triple-D is a safer, more versatile product than conventional acid or non-acid coil cleaners.

All of the organic materials in this product are readily biodegradable

**BIODEGRADABLE**



- Metal Safe
- Biodegradable
- Super Concentrated
- Inhibited Non-Acid Formulation
- Available in Multiple Packages/Forms
- Non-Foaming / Non-Toxic
- Safe for Rubber Roofs
- Corrosion Inhibited
- NSF Registered



**One product does it all - truly a Universal Coil Cleaner**



# DISTRIBUTOR SUPPORT



**LITERATURE**

**Catalogs**

| CATALOG NO.  | DESCRIPTION          | STANDARD PACK |
|--------------|----------------------|---------------|
| LIT-CAT-CD   | HVAC Catalog on CD   | 10            |
| LIT-CAT-HVAC | Issue 21 Catalog     | 10            |
| LIT-CAT-NEW  | New Products Catalog | 10            |
| LIT-CAT-SEAL | Cliplight® Catalog   | 10            |
| LIT-CAT-QS   | Quick-Sling® Catalog | 10            |

**Tri-Folds**

Each DiversiTech tri-fold brochure has a specific product focus. The tri-folds can be used as counter handouts, or mailed to a contractor. Brochure holders are also available. Most tri-folds are 8-1/2" high by 3-5/8" wide.



| CATALOG NO.       | DESCRIPTION                                    | STANDARD PACK |
|-------------------|--|---------------|
| LIT-FLY-3D        | Triple-D™ Brochure                             | 25            |
| LIT-FLY-3D-S      | Triple-D™ Brochure (Spanish)                   | 25            |
| LIT-FLY-BPPPOOL   | The Black Pad® Brochure                        | 25            |
| LIT-FLY-CDLC      | Condensate Drain Line Cleaners Brochure        | 25            |
| LIT-FLY-CLAD      | CladLite® Pad Brochure                         | 25            |
| LIT-FLY-CLRVue    | ClearVue™ Pump Brochure                        | 25            |
| LIT-FLY-COND      | Condensate Monitoring Switches Brochure        | 25            |
| LIT-FLY-CS1200    | CS1200 A/C Shutoff Brochure                    | 25            |
| LIT-FLY-CVKUBE    | ClearVueKube™ Pump Brochure                    | 25            |
| LIT-FLY-CVKUBE-S  | ClearVueKube™ Pump Brochure (Spanish)          | 25            |
| LIT-FLY-CVMINI    | ClearVue™ Mini Pump Brochure                   | 25            |
| LIT-FLY-CVMINI-S  | ClearVue™ Mini Pump Brochure (Spanish)         | 25            |
| LIT-FLY-DISC      | Fusible Disconnect Brochure                    | 25            |
| LIT-FLY-DST10     | Hard Start Kit Brochure                        | 25            |
| LIT-FLY-DTP3      | Three Phase Motor Protector Brochure           | 25            |
| LIT-FLY-DTP3ES    | Three Phase Motor Protector Brochure (Spanish) | 25            |
| LIT-FLY-ELITE     | E Lite® Pad Brochure                           | 25            |
| LIT-FLY-ET        | A/C Easy Tee® Brochure                         | 25            |
| LIT-FLY-FLOW      | Flow Plus™ Brochure                            | 25            |
| LIT-FLY-FOOT      | Hef-T-Foot™ Brochure                           | 25            |
| LIT-FLY-GG        | Drain Gun Brochure                             | 25            |
| LIT-FLY-HEAT      | Heat Pump Pad™ Brochure                        | 25            |
| LIT-FLY-HEF       | Hef-T-Pad Brochure                             | 25            |
| LIT-FLY-HPAD      | Hurricane Pad Brochure                         | 25            |
| LIT-FLY-HRP       | High Rise Pan™ Brochure                        | 25            |
| LIT-FLY-HSI       | Universal Hot Surface Igniter Brochure         | 25            |
| LIT-FLY-MDP       | Metal Drain Pan Brochure                       | 25            |
| LIT-FLY-MOTORS    | Motor Brochure                                 | 25            |
| LIT-FLY-MSPLIT    | SpeediChannel™ Brochure                        | 25            |
| LIT-FLY-PF        | Pro-Flush Brochure                             | 25            |
| LIT-FLY-PF-S      | Pro-Flush Brochure (Spanish)                   | 25            |
| LIT-FLY-PUMP      | Condensate Pump Brochure                       | 25            |
| LIT-FLY-QS        | Quick-Sling® Brochure                          | 25            |
| LIT-FLY-RSC       | Sentry™ Refrigerant Locking Caps Brochure      | 25            |
| LIT-FLY-SEAL      | Cliplight® Brochure                            | 25            |
| LIT-FLY-SPRAYER   | Power Sprayer Brochure                         | 25            |
| LIT-FLY-SPRAYER-S | Power Sprayer Brochure (Spanish)               | 25            |
| LIT-FLY-UC        | UltraLite® Pad Brochure                        | 25            |
| LIT-FLY-UCSTRAP   | UltraLite® Earthquake Pad Brochure             | 25            |
| LIT-FLY-UV        | Pure-Beam™ UV Light Brochure                   | 25            |
| LIT-FLY-VENTS     | Vent Termination Kits Brochure                 | 25            |
| LIT-FLY-WS        | Wet Switch® Brochure                           | 25            |

**Literature Holders**

| CATALOG NO.    | DESCRIPTION                                  | STANDARD PACK |
|----------------|--|---------------|
| MKT-POP-BROCH  | Brochure Holder w/DiversiTech Logo Imprinted | 1             |
| MKT-POP-BROCH4 | 4-Pocket Brochure Holder                     | 1             |
| MKT-POP-EASEL  | Acrylic Tri-Fold Brochure Holder             | 1             |

**Samples/Demos**



| CATALOG NO.     | DESCRIPTION                                      | STANDARD PACK |
|-----------------|--|---------------|
| 6-HK2748-SAM    | High Rise Pan – 27" x 48"                        | 1             |
| 6-M3030-SAM     | Metal Drain Pan – 30" x 30"                      | 1             |
| 6-P3030L-SAM    | Molded Drain Pan – 30" x 30" w/hole              | 1             |
| MKT-POP-DUCTSAM | SpeediChannel Rep Sample Kit (Duct & Flat Elbow) | 1             |
| MKT-POP-WSDEMO  | Wet Switch Demo Kit                              | 1             |
| MKT-SAM-ELEC    | Sample Packet for Electrical                     | 1             |
| MKT-SAM-HSI     | Sample Kit for TrueStart Hot Surface Igniters    | 1             |

**Posters**

| CATALOG NO.              | DESCRIPTION                      | STANDARD PACK |
|--------------------------|----------------------------------|---------------|
| <b>MKT-POSTER-CLRVUE</b> | ClearVue™ Pump Poster            | 1             |
| <b>MKT-POSTER-HPAD</b>   | The Hurricane Pad poster         | 1             |
| <b>MKT-POSTER-MSPLIT</b> | SpeediChannel™ Parts Poster      | 1             |
| <b>MKT-BANNER</b>        | Diversitech Vinyl Banner 2' x 5' | 1             |

**P.O.P. Merchandisers/  
Displays**

| CATALOG NO.                 | DESCRIPTION   | STANDARD PACK |
|-----------------------------|---|---------------|
| <b>MKT-MERCH-USACAPS</b>    | Merchandising kit for USA Capacitors                            | 1             |
| <b>MKT-MERCH-CHEM</b>       | Chemical Display for Gondola                                    | 1             |
| <b>MKT-MERCH-FLEX</b>       | Flex-Inject® Counter Display                                    | 1             |
| <b>MKT-MERCH-RSC</b>        | Sentry™ Wall Display  | 1             |
| <b>MKT-MERCH-SEAL12</b>     | Super Seal Display  | 12            |
| <b>MKT-MERCH-SEAL30</b>     | Super Seal Display  | 30            |
| <b>MKT-POP-CHEM</b>         | DiversiTech/Specialty Chemical Display<br>26" base x 73" height | 1             |
| <b>MKT-POP-CLRGOND</b>      | ClearVue™ Pump Display for Gondola                              | 1             |
| <b>MKT-POP-CLRSHELF</b>     | ClearVue™ Pump Shelf Talker                                     | 1             |
| <b>MKT-POP-CLRSTAND</b>     | ClearVue™ Pump Banner Stand                                     | 1             |
| <b>MKT-POP-CP22</b>         | CP22 Pump Gondola Display                                       | 1             |
| <b>MKT-POP-CVTUBE</b>       | ClearVueTube Display  | 1             |
| <b>MKT-POP-DEVBACKS</b>     | DEVCO Background Graphics for pegboard                          | Set of 2      |
| <b>MKT-POP-DEVBACKSSLAT</b> | DEVCO Background Graphics for Slatwall                          |               |
| <b>MKT-POP-DEVCOMBO</b>     | DEVCO Display Rack – Combo                                      | 1             |
| <b>MKT-POP-DEVELEC</b>      | DEVCO Display Rack – Electrical                                 | 1             |
| <b>MKT-POP-DEVEZC</b>       | DEVCO Display Rack – EZC  | 1             |
| <b>MKT-POP-DTBACKS</b>      | DiversiTech Background Graphics for pegboard                    | Set of 2      |
| <b>MKT-POP-DTBACKSSLAT</b>  | Diversitech Background Graphics for Slatwall                    | 1             |
| <b>MKT-POP-DUCT</b>         | SpeediChannel Merchandising Display                             | 1             |
| <b>MKT-POP-HSI</b>          | Merchandiser Display for TrueStart Hot Surface Igniters         | 1             |
| <b>MKT-POP-PF</b>           | Pro-Flush Display   | 1             |
| <b>MKT-POP-WS</b>           | Wet Switch Counter Display                                      | 1             |
| <b>MKT-POP-CDLC</b>         | Condensate Drain Line Cleaner Display                           | 1             |
| <b>MKT-POP-ET</b>           | A/C Easy Tee Merchandiser                                       | 1             |

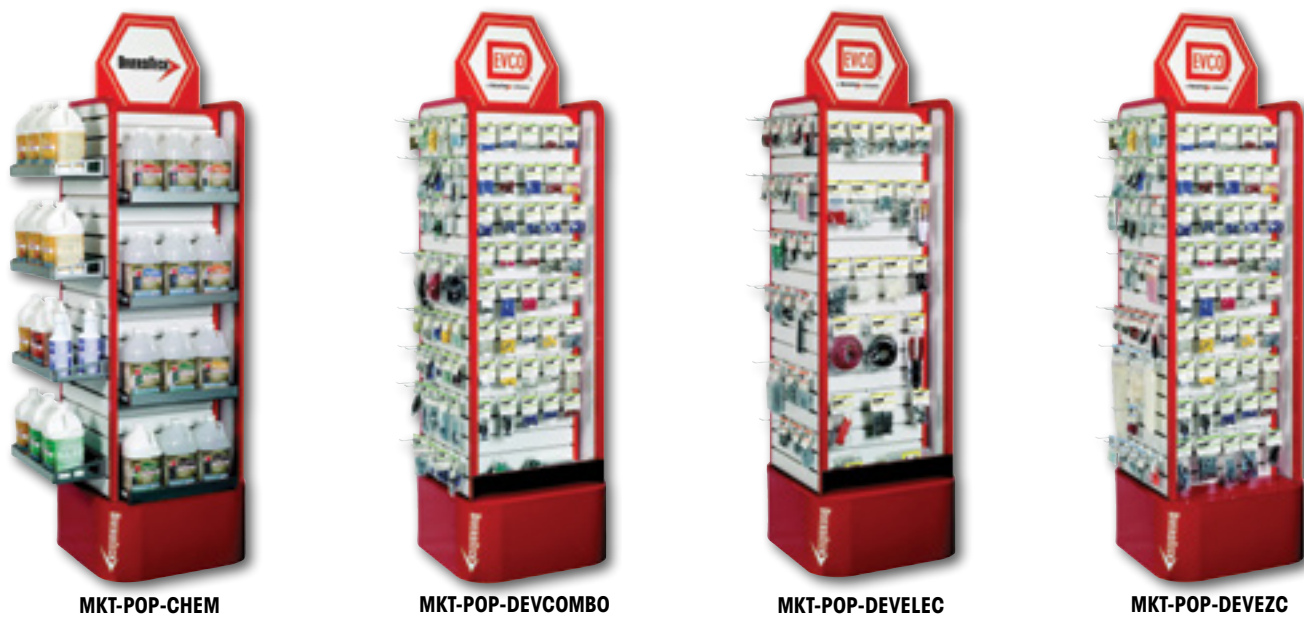
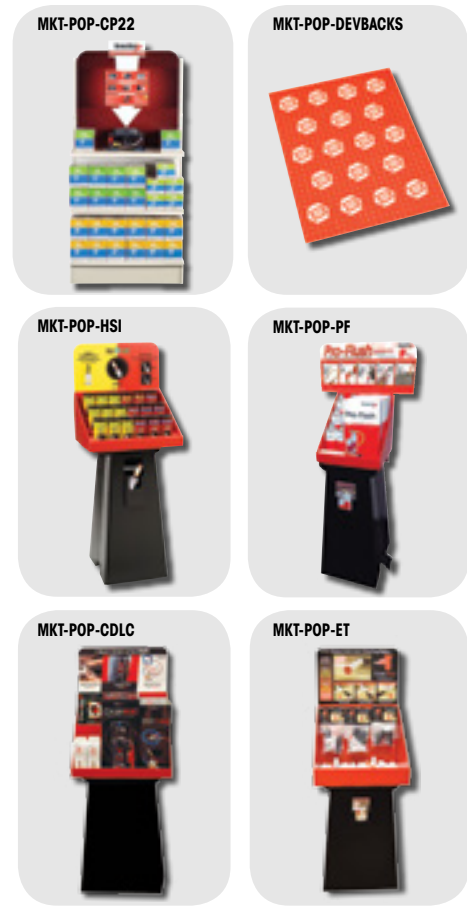

**MKT-POP-CHEM**

**MKT-POP-DEVCOMBO**

**MKT-POP-DEVELEC**

**MKT-POP-DEVEZC**

**U.S. GENERAL TERMS AND CONDITIONS****General Policy****WE ARE COMMITTED TO DO WHAT IT TAKES TO DELIVER WORLD CLASS SERVICE AND PRODUCTS.**

All items not ordered in multiples of standard package quantities will automatically be increased to the next standard package quantity. All purchase orders submitted by our customers are assumed as accepting our general terms and conditions as stated herein, any conflicting terms stated on the purchase order cannot supersede our terms.

**Order Discrepancies:**

All order discrepancies must be reported to us within 5 working days from the date of delivery. Any discrepancies reported after this period cannot be honored.

**Terms:**

1% 15 days. Net 30 days. Late charges of 1-1/2% per month will be charged following the due date of the invoice. Prices subject to change without notice.

**Minimum Order:**

\$100.00 minimum order on all original orders. \$15.00 Broken Pallet Charge will be added for each pad size less than the standard pallet quantities.

**Freight Policy**

CONTINENTAL U.S.: All orders in excess of \$2,000 will ship prepaid. This policy applies to any combination of DiversiTech, Wagner, Specialty Chemical, and Devco products.

**Pick Up Allowance**

3% of net invoice, 24-hour notice requested. Order must qualify for prepaid freight to receive pick up allowance.

**Lost or Damaged Freight**

Although we take special care to insure the safe arrival of your merchandise, our responsibility for damages cease when the customer accepts the shipment. To protect your interest, we suggest that you thoroughly inspect all items before accepting delivery. If your order was damaged in shipment or contains a shortage, report the loss or damage AT ONCE to DiversiTech. Any claims for lost or damaged freight must be noted on the Bill of Lading at the time of delivery. If damage is present, you MUST hold the original carton and merchandise for credit by your Sales Representative – otherwise, no claim can be honored.

**Returns:**

No merchandise will be accepted for return without prior authorization. Call our Customer Service Department to request permission to return goods. Instructions on method of return will be given to you at that time. All returns are subject to a 25% restocking charge.

**Warranty Disclaimer**

DiversiTech has made a diligent effort to illustrate and describe the products in this catalog accurately; however, such illustrations and descriptions are for the sole purpose of identification, and do not express or imply a warranty that the products are merchantable or fit for a particular purpose, or that the products will necessarily conform to the illustrations or descriptions. DiversiTech assumes no liability for typographical or photographic errors.

DiversiTech reserves the right to make changes in design, material or finish in an effort to improve our products without special notification. If necessary, DiversiTech reserves the right to replace any product shown in catalog with another comparable product without special notification. All DiversiTech products include a 1 year standard limited warranty unless otherwise noted.

**DiversiTech's ULTRALITE®, CLADLITE®, and E LITE® Limited Lifetime Warranty**

To the original owner of the ULTRALITE®, CLADLITE®, or E LITE® equipment base, DiversiTech warrants the base to be free of defects in materials and workmanship for the life of the equipment under which it is installed so long as the installing homeowner lives there. All defective merchandise must be returned to the factory, transportation prepaid, and if the same is found to be defective, it will be repaired or replaced free of charge, F.O.B. factory. This warranty does not cover replacement labor cost, or any cost claim incident to the defect, replacement, or reinstallation, nor field repair expenses. This warranty gives you specific legal rights and you may also have other rights which vary from state to state. Some states do not allow the exclusion or limitation of incidental or consequential damages, so the above limitation of exclusion may not apply to you.

**Exclusions and Limitations**

DiversiTech's ULTRALITE®, CLADLITE®, and E LITE® equipment pads are designed and manufactured to be used as bases for light, ground supported equipment such as air conditioning condensers, swimming pool filters and heat pumps. Use of ULTRALITE®, CLADLITE®, and E LITE® pads for purposes other than those listed above or improper installation of ULTRALITE®, CLADLITE®, and E LITE® pads may result in pad failure. DiversiTech Corporation disclaims any liability due to such misuse or improper installation. If you have questions concerning the proper installation or use of DiversiTech's ULTRALITE®, CLADLITE®, and E LITE® equipment pads, you should contact our Customer Service Department at (800)995-2222.

**Made in the U.S.A.**

All item numbers in RED indicate Made in the U.S.A. This information was accurate at time of catalog printing. Visit [www.diversitech.com](http://www.diversitech.com) to verify country of origin for any DiversiTech product.



**DOMESTIC CREDIT APPLICATION**

|                            |  |
|----------------------------|--|
| <b>COMPANY NAME:</b> _____ | For internal use only<br>CUSTOMER #: _____ |
|----------------------------|--|

SHIP TO \_\_\_\_\_ PHONE # \_\_\_\_\_

ADDRESS \_\_\_\_\_ FAX # \_\_\_\_\_

CITY/STATE \_\_\_\_\_ ZIP CODE \_\_\_\_\_

E-MAIL \_\_\_\_\_

BILL TO \_\_\_\_\_

NAME \_\_\_\_\_ PHONE # \_\_\_\_\_

ADDRESS \_\_\_\_\_ FAX # \_\_\_\_\_

CITY/STATE \_\_\_\_\_ ZIP CODE \_\_\_\_\_

E-MAIL \_\_\_\_\_

**PRINCIPALS** \_\_\_\_\_**BUYING GROUP MEMBER** \_\_\_\_\_

BUSINESS STRUCTURE\*: CORPORATION \_\_\_\_\_ PARTNERSHIP \_\_\_\_\_ INDIVIDUAL \_\_\_\_\_ \*Please check one

CREDIT LIMIT REQUESTED \_\_\_\_\_ DUNS # \_\_\_\_\_

ESTIMATED SALES VOLUME \_\_\_\_\_ FEDERAL TAX ID # \_\_\_\_\_

YEARS IN BUSINESS \_\_\_\_\_

**BANK REFERENCE**

NAME \_\_\_\_\_ PHONE # \_\_\_\_\_

ADDRESS \_\_\_\_\_ OFFICER \_\_\_\_\_

CITY/STATE \_\_\_\_\_ ZIP CODE \_\_\_\_\_

ACCOUNT # \_\_\_\_\_

**THREE MAJOR TRADE REFERENCES (U.S. based are preferred)**

NAME \_\_\_\_\_ TITLE \_\_\_\_\_

CONTACT \_\_\_\_\_ PHONE # \_\_\_\_\_

CITY/STATE/ZIP \_\_\_\_\_ FAX # \_\_\_\_\_

E-MAIL \_\_\_\_\_ ACCOUNT NUMBER \_\_\_\_\_

NAME \_\_\_\_\_ TITLE \_\_\_\_\_

CONTACT \_\_\_\_\_ PHONE # \_\_\_\_\_

CITY/STATE/ZIP \_\_\_\_\_ FAX # \_\_\_\_\_

E-MAIL \_\_\_\_\_ ACCOUNT NUMBER \_\_\_\_\_

NAME \_\_\_\_\_ TITLE \_\_\_\_\_

CONTACT \_\_\_\_\_ PHONE # \_\_\_\_\_

CITY/STATE/ZIP \_\_\_\_\_ FAX # \_\_\_\_\_

E-MAIL \_\_\_\_\_ ACCOUNT NUMBER \_\_\_\_\_

## CATEGORY INDEX

|  |     |   |          |   |         |
|--|-----|---|----------|---|---------|
| 007 Control Checker.....                     | 177 | Adjustable Delay on Break Time .....                | 154      | Braided Vinyl Tubing.....                     | 81      |
| 2-in-1 Copper Tube Cleaning Brush .....      | 170 | Adjustable Delay on Make Timer .....                | 154      | Brass Adapters.....                           | 236     |
| 3/4™ Rubber Elbow.....                       | 193 | Adjustable Equipment Risers..                       | 30       | Brass Fittings.....                           | 238-240 |
| 3-36® Multi-Purpose Lubricant                | 88  | Adjustable Flat Bend.....                           | 201      | Brushes.....                                  | 169-171 |
| 45 Degree Ell .....                          | 52  | Aerosols.....                                       | 84       | Bubble-N-Trouble™ Leak Detector .....         | 225     |
| 45 Degree Ell C x C .....                    | 233 | Air Handler Base - Heavy Duty Adjustable .....      | 33       | Bug Spray .....                               | 94      |
| 45 Degree Flat Bend.....                     | 201 | Air Handler Blocks .....                            | 30       | Bulbs .....                                   | 111     |
| 45 Degree Street Ell Ftg. x C.               | 234 | All Purpose Cleaning Pads .....                     | 84       | Bushing .....                                 | 52      |
| 45 Elbows .....                              | 190 | All Purpose Enamel .....                            | 88       | Bushing (MIPT x FIPT) .....                   | 186     |
| 45 Ell (Slip x Slip).....                    | 191 | All Purpose Lubricant.....                          | 88       | Bushings and Locknuts .....                   | 114     |
| 4-Piece Hook and Pick Set ...                | 177 | All Purpose Sprayers.....                           | 223      | Butt Connector Assortment Kit .               | 105     |
| 6180 Series Terminal Blocks                  | 124 | All Weather PVC Cement.....                         | 188      | Butt Connectors – Insulated .                 | 104     |
| 6190 Series Terminal Blocks                  | 124 | Allen Wrenches .....                                | 169      | BX and Greenfield Connectors .....            | 112     |
| 90 Degree Ell .....                          | 52  | All-Purpose Clear Cement ...                        | 188      | BX Set Screw Connectors .....                 | 145     |
| 90 Degree Ell C x C .....                    | 233 | Aluminum Armored MC Cable .....                     | 145      | Cable Connectors.....                         | 112     |
| 90 Degree Flat Bend.....                     | 201 | Aluminum Dryer Vent Hoods, Kits, and Fittings ..... | 40       | Cable Markers .....                           | 126     |
| 90 Degree Inside Elbow.....                  | 202 | Aluminum Foil Tape .....                            | 42       | Cable Staples.....                            | 145     |
| 90 Degree Long Radius Bend                   | 202 | Aluminum Solderless Lugs...                         | 125      | Cable Tie Assortment Pack ...                 | 164     |
| 90 Degree Long Turn Ell C x C.....           | 234 | Anchor Kit .....                                    | 93       | Cable Tie Mounts.....                         | 113     |
| 90 Degree Long Turn Street Ell Ftg. x C..... | 233 | Anchors .....                                       | 108-109  | Cable Ties and Accessories ..                 | 113     |
| 90 Degree Outside Elbow ...                  | 202 | Angle Iron Brackets.....                            | 32       | Canopy Strap .....                            | 181     |
| 90 Degree Street Ell .....                   | 52  | Anti-Vibration Pads .....                           | 24       | Canvas Drop Cloths .....                      | 86      |
| 90 Degree Street Ell Ftg. x C.               | 233 | Armored Connector .....                             | 122      | Cap.....                                      | 234     |
| 90 Elbow (Hub x Hub) .....                   | 190 | Armored Plug .....                                  | 122      | Cap (FIPT) .....                              | 193     |
| 90 Ell (Slip x FIPT) .....                   | 191 | Aviation Snips.....                                 | 180      | Cap (Slip) .....                              | 192     |
| 90 Ell (Slip x Slip).....                    | 191 | Batteries.....                                      | 85       | Capacitors.....                               | 146-147 |
| 90 Ell Reducing (Slip x FIPT)                | 191 | Bearings.....                                       | 142      | Carabiners .....                              | 181     |
| 90 Ell Reducing (Slip x Slip).               | 191 | Bi Flow Driers .....                                | 242      | Carbon Monoxide & Smoke Alarms .....          | 49      |
| 90 Street Ell (MIPT x Slip)....              | 191 | Big Helper™ - PVC Pipe Cutter.                      | 184      | Carbon Steel Curved Handle Scratch Brush..... | 170     |
| 90 Street Ell (SPIG x Slip)....              | 191 | Bi-Metal Reciprocating Saw Blades.....              | 179      | Carton Sealing Tape.....                      | 85      |
| A/C Brackets.....                            | 32  | Black Jack Roof Cement .....                        | 93       | Carton Tape Dispenser.....                    | 85      |
| A/C Condensate Drain Pan Fittings.....       | 80  | Black Nylon Cable Tie Assortment.....               | 113      | Catalogs .....                                | 250     |
| A/C Easy Tee.....                            | 78  | Black Nylon Ties with Mounting Hole.....            | 165      | Caulk Gun.....                                | 92      |
| A/C Riser Blocks .....                       | 30  | Black Nylon Wire Ties....                           | 165, 204 | Caulking Sealant .....                        | 92      |
| A/C Secondary Condensate Drain Pans .....    | 79  | Black Steel Welded Nipples....                      | 51       | CBC II Contact Cleaner .....                  | 84      |
| Abrasive Cloths.....                         | 84  | Blade Auto Fuses .....                              | 120      | Channellock® Products .....                   | 172     |
| Access Fittings .....                        | 235 | Blind Rivet Tools.....                              | 115      | Channels .....                                | 201     |
| Accessories.....                             | 221 | Boiler Bracket .....                                | 31       | Chip Brushes.....                             | 169     |
| Acid Eliminator™ .....                       | 230 | Boiler Pump .....                                   | 76       | Chlor-Free® Degreaser .....                   | 86      |
| Acid Test Kits .....                         | 229 | Box Cover Units .....                               | 154      | Circuit Breakers .....                        | 157     |
| Acrylic Latex Painter's Caulk ...            | 92  | Boxes, Rings, and Covers .                          | 110-111  | Citrus Degreaser.....                         | 86      |
| Adapter (Insert x Slip) .....                | 193 |   |          | CladLite® Pads.....                           | 20      |
| Additives .....                              | 230 |   |          | Clean Out Tee.....                            | 193     |

|   |         |   |         |   |         |
|---|---------|---|---------|---|---------|
| ClearVue™ Pump .....                            | 76      | Brushes.....  | 171     | Digital Single Phase Line Voltage Monitor .....           | 155     |
| ClearVue™ Traps .....                           | 78      | Conduit Fittings .....                              | 114     | Digital Three Phase Line Voltage Monitor .....            | 155     |
| ClearVue™ Tube & Traps .....                    | 78      | Conduit Nipples.....                                | 114     | Digital UL Listed Multimeter..                            | 176     |
| Clipboards.....                                 | 172     | Conduit, Fittings, Cable .                          | 144-145 | Direct Drive Furnace Blower Motors .....                  | 139     |
| Clipboards and Form Holders                     | 172     | Contact Cleaners.....                               | 85-86   | Direct Replacement Igniters ...                           | 48      |
| Cliplight Extends.....                          | 174     | Contacting Accessories.....                         | 151     | Disconnect Switches.....                                  | 143     |
| Clip-On Zoom Light.....                         | 174     | Contactors .....                                    | 150-151 | Disconnects - Metal Case ...                              | 143     |
| Clips .....                                     | 120     | Cool Weld™ Heat Barrier Spray .....                 | 221     | Disconnects - Non-Metallic Case .....                     | 143     |
| Clipstrip™/Clipstrip 2™ .....                   | 174     | .....   | 236     | DiversiGum™ Sealing Compound .....                        | 92      |
| Clipstrip™ Aqua .....                           | 174     | Cop Cap™ Locking Valve Cover .....                  | 236     | Diversitech Flexible Conduit .                            | 144     |
| Cloth Duct Tape .....                           | 44      | .....   | 235     | Diversitech Line Sets.....                                | 243     |
| CO <sub>2</sub> Cylinders .....                 | 168     | Copper Coupling with Dimple Stop.....               | 235     | DiversiTech® Gas Connectors .                             | 50      |
| CO <sub>2</sub> Detectors.....                  | 49      | Copper Coupling with No Stop.....                   | 235     | DiversiTech® Refrigerant ID Labels.....                   | 245     |
| Coil Cleaners.....                              | 220-221 | Copper Fittings .....                               | 233-235 | DiversiTech® Three Pole Definite Purpose Contactors ..... | 150     |
| Coil Cleaning Aerosols.....                     | 222     | Copper Saddle Valve.....                            | 237     | DiversiTech® Two Pole Definite Purpose Contactors .....   | 150     |
| Coil Guard™ .....                               | 221     | Copper Tube Fitting Brushes .                       | 170     | DiversiWhips .....  | 142     |
| Combination CO & Smoke Alarms .....             | 49      | Core Removal Tool .....                             | 237     | DiversiWhips for the Swimming Pool Industry .....         | 142     |
| Combination Couplings .....                     | 112     | Core Storer.....                                    | 237     | DiversiWhips Pallet Packs.....                            | 142     |
| Combination Packs.....                          | 103     | Cork Insulation Tape .....                          | 82      | DiversiWhips with Extended Length Wires .....             | 143     |
| Combination Screwdrivers ...                    | 179     | Cotter Pins .....                                   | 118     | Dormont 20 Series .....                                   | 50      |
| Combo Head Sheet Metal Screws .....             | 117     | Coupling .....                                      | 52      | Dormont 20 Series with Valve                              | 51      |
| Compartmented Storage Boxes.....                | 159     | Coupling (Slip x Slip).....                         | 192     | Dormont 30 Series .....                                   | 50      |
| Compression Connector .....                     | 238     | Coupling (Socket) with Rolled Tube Stop C x C ..... | 234     | Dormont Gas Valves and Connectors .....                   | 50-51   |
| Compression Elbow .....                         | 238     | Couplings (Hub x Hub) .....                         | 190     | Drain Dawg™ and Drain Kat™ Fittings.....                  | 79      |
| Compression Nut.....                            | 238     | CP-22 Low Profile Pumps .....                       | 76      | Drain Gun and Cartridges .....                            | 78      |
| Compression Sleeve .....                        | 238     | CP-22 Pumps .....                                   | 76      | Drain Gun™ .....  | 78      |
| Compression Sprayers .....                      | 224     | CP-MINI-L pump .....                                | 77      | Drain Line, Tubing .....                                  | 81      |
| Compression Tee .....                           | 238     | CPVC-CTS Pipe and Fittings..                        | 186     | Drain Pan Disinfectant, Sealant .....                     | 222     |
| Compression Union .....                         | 238     | CPVC-CTS Pipe by FlowGuard® Gold™ .....             | 186     | Drain Pans .....  | 80      |
| Compressor Lead Kit.....                        | 103     | Cross (Slip x Slip x Slip x Slip) .....             | 192     | Drain Trap Kits .....                                     | 78      |
| Compressor Repair Kit .....                     | 159     | .....   | 192     | DrainDawg™ .....  | 78      |
| Compressor TOTE.....                            | 176     | CS1200 AC Shutoff Switch .....                      | 77      | DrainKat™ .....   | 78      |
| Concentric Vents .....                          | 49      | Cushion Clamps.....                                 | 240     | Driers, Sight Glasses .....                               | 241-242 |
| Condensate Cop™ .....                           | 77      | Cushioned Pillow Blocks .....                       | 142     | Drive Fasteners.....                                      | 108     |
| Condensate Drain Line Cleaning .....            | 78-79   | Cutting Oil.....                                    | 88      | Drop Cloths .....   | 86      |
| Condensate Drain Line Switches .....            | 77      | Cylinder Valves .....                               | 168     |   |         |
| Condensate Drain Pans .....                     | 81      | D'Scale™ Acid Scale Remover                         | 229     |   |         |
| Condensate Drain Pans, Fittings, Adapters ..... | 79-81   | Definite Purpose Contactors .                       | 150     |   |         |
| Condensate Pumps .....                          | 76-77   | Degreasers.....                                     | 86      |   |         |
| Condenser Equipment Mounting .....              | 32      | Deluxe Hi-Tension Hacksaw ..                        | 179     |   |         |
| Condenser Fan Motors.....                       | 138     | Devco® Crimpers .....                               | 115     |   |         |
| Condenser/Heat Exchanger                        |         | Devco® Plastic Anchor Kits ...                      | 109     |   |         |
|   |         | Device Rings .....                                  | 110     |   |         |
|   |         | Dial-a-Mix Sprayer .....                            | 224     |   |         |

|  |         |  |         |   |         |
|--|---------|--|---------|---|---------|
| Drop-In Expansion Anchor Setting Tool.....                   | 108     | Electrical Toggle Switches ....                          | 156     | Flare x MIP Elbow .....                       | 238     |
| Drop-In Expansion Anchors ..                                 | 108     | Electrolytic Copper Solderless Lugs.....                 | 126     | Flare x MIP Reducing Elbow .                  | 238     |
| Dry R.....   | 230     | Electronic Degreaser .....                               | 87      | Flare x MIP Union .....                       | 239     |
| Dryer Duct, Vent Hose, Hose Clamps .....                     | 40-41   | EMT (Thinwall) Fittings.....                             | 145     | Flash UV Dye.....                             | 225     |
| Dryer Hose Clamps .....                                      | 41      | Epoxy Coated Gas Connectors                              | 50      | Flashlights and Lanterns By Rayovac .....     | 173     |
| Dryer Vent Hose.....   | 40      | Equipment Stands .....                                   | 33-34   | Flat Wall Escutcheon .....                    | 203     |
| Dual Element Fuses .....                                     | 120     | EVA Anti-Vibration Pad .....                             | 24      | Flat Washers .....                            | 116     |
| Duct Cleaning Brush.....                                     | 170     | Evergreen® ECM Motors.....                               | 141     | Flex Duct Tape .....                          | 42      |
| Duct End.....  | 203     | Expando Adjustable Condenser Tube Cleaner .....          | 177     | Flex Inject®.....                             | 226     |
| Duct Fans.....   | 39      | Extension Cords.....                                     | 172     | Flex Joint .....                              | 203     |
| Duct Strap - Metallic - Roll ....                            | 41      | Extension Rings .....                                    | 110     | Flexible Refrigerant Line.....                | 244     |
| Duct Strap, Ties, Clamps ....                                | 41-42   | Extension Rods for Condenser Tube Brushes.....           | 171     | Flexi-Patch™ .....                            | 91      |
| Duct Tape .....  | 42      | Fan Centers.....   | 152     | Flow Plus™ Condensate Pan Treatment.....      | 227     |
| Duct-Fresh Gel .....   | 227     | Fasco® 3.3in Walk-In Cooler/Freezer Refrigeration Motors | 141     | Flowmeters .....                              | 168     |
| Duct-Fresh Spray .....                                       | 227     | Fast Cure Epoxy.....                                     | 91      | Flue Caps.....                                | 39      |
| Dust Masks .....   | 90      | Fast Orange® Hand Cleaner ...                            | 86      | Flush Bushing.....                            | 235     |
| DWW Bend Fittings.....                                       | 190     | Felt Tip Markers .....                                   | 89      | Flushing Products.....                        | 223     |
| DWW Bushings.....  | 190     | Female Adapter (Barb x FIPT)                             | 186     | Foam Insulation Tape.....                     | 82      |
| DWW Vent Tee .....   | 190     | Female Adapter (Slip x FIPT)                             | 192     | Foam Sealant - One Component .....            | 91      |
| E Life® Pads .....   | 19      | Female Adapter C x F.....                                | 233     | Foam Sealant - Two Component .....            | 92      |
| Eaton Circuit Breakers, Type BR .....                        | 157     | Female Adapter Elbow (Barb x FIPT).....                  | 187     | Foam-Plus™ Aerosol Foaming Coil Cleaner ..... | 222     |
| Eaton Circuit Breakers, Type CH .....                        | 157     | Female Adapter Reducing (Slip x FIPT).....               | 192     | Foil Scrim Kraft Tape .....                   | 42      |
| Eaton Contactor Accessories                                  | 151     | Fender Washers .....                                     | 116     | Fully Insulated Dead End Connectors .....     | 104     |
| Eaton Definite Purpose Contactors - One and Two Pole.....    | 150     | Fin Tools .....  | 173     | Fully Insulated Female Slip-Ons .....         | 102     |
| Eaton Definite Purpose Contactors - Three and Four Pole..... | 150     | Fin Whisk .....  | 171     | Fully Insulated Flag Female Slip-Ons .....    | 103     |
| Eaton Electrical Disconnects                                 | 144     | Finished Hex Nuts.....                                   | 115     | Fully Insulated Male Slip-Ons                 | 102     |
| Eaton Switch A/C Disconnect                                  | 144     | Fin-Tool .....   | 173     | Fully Insulated Receptacles..                 | 103     |
| Eaton Three Phase Disconnects .....                          | 144     | Firestop Products for Class A Buildings.....             | 92      | Furnace Mounting Blocks.....                  | 30      |
| Eco-Coil™ Environ. Friendly Coil Cleaner .....               | 220     | First Aid Kits.....                                      | 90      | Furnace Pans .....                            | 80      |
| Economy Electrical Tape .....                                | 158     | Fitting Reducer Coupling Ftg. x C.....                   | 234     | Furnace Pump.....                             | 76      |
| EcoPad™ .....  | 23      | Fittings.....  | 201-204 | Fuse Adapters.....                            | 154     |
| Egg Crate Louvers - Air Return                               | 39      | Flag Disconnects.....                                    | 103     | Fuse Holders .....                            | 154     |
| Elbow (Barb x Barb).....                                     | 186     | Flag Female Compressor Terminal Kit .....                | 103     | Fuse Pullers .....                            | 154     |
| Elbow (FIPT x FIPT).....                                     | 187     | Flag Female Compressor Terminals .....                   | 103     | Fuseblocks .....                              | 154     |
| Electrical Duplex Receptacles .....                          | 155     | Flame Sensor .....                                       | 49      | Fuses.....                                    | 153-154 |
| Electrical Outlet Boxes, Extensions and Covers ....          | 156     | Flare Tee.....   | 239     | Fusible Links .....                           | 160     |
| Electrical Staples .....                                     | 114     | Flare Union .....  | 239     | Garden Hose .....                             | 224     |
| Electrical Supplies .....                                    | 156-158 | Flare x FIP Union.....                                   | 240     | Garden Hose Adapters .....                    | 186     |
| Electrical Tapes.....  | 158     | Flare x Flare Swivel Union ....                          | 240     | Gas Ball Valve.....                           | 50      |



|                                  |         |                                  |     |                                     |         |
|----------------------------------|---------|----------------------------------|-----|-------------------------------------|---------|
| Gauges.....                      | 175     | Heavy Duty High Rise Pans ....   | 80  | Incandescent Light Bulbs .....      | 111     |
| General Purpose Pumps .....      | 76      | Heavy Duty Nylon Cable Ties      | 113 | Incandescent Light Bulbs .....      | 111     |
| General Purpose Relays.....      | 152     | Heavy Duty PVC Cement .....      | 188 | Indicator Lights.....               | 125     |
| General Purpose Spray Paint..    | 89      | Heavy Duty Silicone Mold         |     | Industrial Enamel .....             | 89      |
| General Purpose Switching        |         | Release.....                     | 88  | Industrial Towels .....             | 87      |
| Relays.....                      | 152     | Heavy Duty Work Gloves .....     | 90  | In-Line Fuse Holder.....            | 154     |
| General Tools .....              | 115     | Hef-T-Block™ .....               | 30  | Insta-Charge.....                   | 242     |
| Genteq® Direct Drive Furnace     |         | Hef-T-Brackets™ .....            | 31  | Insta-Tap Refrigerant Recovery      |         |
| Blower Motors .....              | 140     | Hef-T-Foot™ .....                | 31  | Tool.....                           | 237     |
| Genteq® High Temperature         |         | Hef-T-Pad™ .....                 | 22  | Insulated Butt Connectors ....      | 104     |
| Condenser Fan Motors.....        | 140     | HEMImini™ .....                  | 174 | Insulated Female Slip-Ons ...       | 102     |
| Genteq® Multiple Horsepower      |         | HEMIPLUS™2 .....                 | 174 | Insulated Flange Spades.....        | 105     |
| Condenser Fan Motors.....        | 140     | Hex Head Cap Screws.....         | 116 | Insulated Hooks.....                | 104     |
| Genteq® Multiple Horsepower      |         | HF™ Contact Cleaner .....        | 85  | Insulated Male Slip-Ons .....       | 102     |
| Furnace Blower Motors .....      | 141     | High Heat Spray Paint .....      | 89  | Insulated Plugs.....                | 103     |
| Genteq® Single Speed Condenser   |         | High Rise Pans™ .....            | 80  | Insulated Rings.....                | 105     |
| Fan Motors.....                  | 139     | High Temp Red Silicone           |     | Insulated Spades.....               | 105     |
| Geocel Caulking Sealant .....    | 92      | Sealant .....                    | 92  | Insulated Spring Spades .....       | 105     |
| Glass Cleaner.....               | 84      | High Temperature Assortment ..   | 106 | Iso-Cube Economy Anti-Vibration     |         |
| Glass Cloth, Economy Electrical  |         | High Temperature Butt Connectors |     | Pad.....                            | 24      |
| Tapes .....                      | 158     | .....                            | 106 | J-B Weld .....                      | 91      |
| Gloves.....                      | 90      | High Temperature Female Slip-Ons |     | Kimberly-Clark Waterless Hand       |         |
| Glycols.....                     | 222-223 | .....                            | 106 | Wipes .....                         | 86      |
| Gorilla Tube™ Clear Vinyl Tubing |         | High Temperature Flag Female     |     | Kimtex® Towels .....                | 87      |
| .....                            | 81      | Slip-Ons .....                   | 106 | Knock'er Loose® Penetrating         |         |
| Grease Fittings .....            | 119     | High Temperature Male Slip-Ons   |     | Solvent.....                        | 87      |
| Grip-Cut™ .....                  | 84      | .....                            | 106 | Knockout Seals and Hole             |         |
| Grommets - Vinyl .....           | 159     | High Temperature Rings .....     | 106 | Plug.....                           | 114     |
| Ground Adapter.....              | 122     | High Temperature Solderless      |     | Kut-All Plastic Tube and Hose       |         |
| Ground Fitting Clamp.....        | 126     | Terminals .....                  | 106 | Cutter.....                         | 183     |
| Grounding Rubber Handle          |         | High Temperature Spades ....     | 106 | Lashing Strap .....                 | 180     |
| Plug.....                        | 121     | High Temperature Wire.....       | 163 | Latex Gloves.....                   | 90      |
| Hand Cleaners .....              | 86      | Horizontal Refrigerator/Freezer  |     | Leak Detectors & Accessories        |         |
| Hanging Brackets .....           | 36      | Analog Therm.....                | 183 | .....                               | 225-226 |
| Hanging Strap .....              | 181     | Horizontal Vent Term Kits.....   | 49  | Leak Test Gauge .....               | 182     |
| Hanging Wire .....               | 41      | Hose Clamps.....                 | 118 | Leather Work Gloves.....            | 90      |
| Hard Start Kits .....            | 149     | Hose Mender (Barb x Barb)..      | 187 | LED Screwdriver Continuity          |         |
| Heat Pump Pad™ .....             | 23      | Hoses .....                      | 168 | Tester.....                         | 182     |
| Heat Pump Risers .....           | 30      | Hoses, Sprayers .....            | 224 | Line Piercing Valves and            |         |
| Heat Resistant Cloth .....       | 184     | Hot Surface Igniters .....       | 48  | Tools.....                          | 237     |
| Heat Shrink Tubing.....          | 124     | Hot Water Hose .....             | 224 | Liquid Line Driers.....             | 241     |
| Heat Shrink Tubing - Polyolefin  |         | Hurricane Pad™ .....             | 23  | Liquid Tite Connectors.....         | 112     |
| 50% Shrink.....                  | 159     | Hurricane Pad™ Attachment        |     | Liquid Tite Connectors.....         | 144     |
| Heat Shrink Tubing Assortments   |         | Bracket.....                     | 21  | Literature.....                     | 250     |
| .....                            | 124     | HVAC Tools .....                 | 180 | Literature Holders .....            | 250     |
| Heavy Duty Bracket.....          | 31      | Hydroguage Manometer .....       | 175 | Little Helper™ - All Purpose Cutter |         |
| Heavy Duty Cable Ties.....       | 41, 164 | Ice Machine Products .....       | 225 | .....                               | 183     |
| Heavy Duty Degreaser .....       | 86      | Icemaker Kit .....               | 194 | Louvered Dryer Vent Hood.....       | 42      |
| Heavy Duty Degreaser II.....     | 86      | Igniters.....                    | 48  |                                     |         |

|   |         |  |          |   |              |
|---|---------|--|----------|---|--------------|
| Low Profile Disconnects - Metal Case .....      | 143     | Mini-Split Stands .....                  | 32       | P.O.P. Merchandisers/Displays .....       | 251          |
| Low Profile Pumps .....                         | 76      | Miscellaneous Tools.....                 | 176-177  | Paints and Primers .....                  | 89           |
| Low Voltage Screwdriver Tester.....             | 182     | Monitors.....                            | 155, 177 | Pan Treatments / Disinfectants .....      | 227-228      |
| Lubricants .....                                | 87-88   | Motor Bolts.....                         | 116      | Pan-Kote Heavy Duty Drain Pan Patch ..... | 222          |
| LuxPro Thermostats.....                         | 161     | Motor Brackets .....                     | 142      | Pan-Patch™ .....                          | 221          |
| Machine Screw Hex Nuts .....                    | 115     | Motor Mount - Flex Bracket... ..         | 142      | Parts Cleaning Brush .....                | 170          |
| MAC-The Ultimate in Line Piercing Valves .....  | 237     | Motor Run Capacitors - 370 VAC .....     | 146      | Periscope Connection Kit .....            | 41           |
| Magjumper .....                                 | 182     | Motor Run Capacitors - 440 VAC .....     | 147      | Pigtails.....                             | 126          |
| Magnetic Hex Chucks .....                       | 115     | Motor Run Capacitors (USA Made) .....    | 148-149  | Pipe Hanging Strap.....                   | 118          |
| Magnetic Nut Setters - Bulk..                   | 178     | Motor Shaft Key Assortments              | 118      | Pipe Mounted Switches .....               | 77           |
| Maintenance Chemical Quick Reference Guide..... | 218-219 | Motor Start Capacitors .....             | 149      | Pistol Grips & Water Nozzle..             | 224          |
| Male Adapter (Barb x MIPT)..                    | 186     | Motors .....                             | 138-141  | Pivot™ .....                              | 174          |
| Male Adapter (MIPT x Slip) ...                  | 192     | Mounting Blocks.....                     | 30-31    | Pivot™ 33 .....                           | 174          |
| Male Adapter C x M .....                        | 233     | Mounting Brackets.....                   | 31-32    | Pivot™ Mini .....                         | 174          |
| Male Adapter Elbow (Barb x MIPT) .....          | 187     | Multi-Color Test Leads .....             | 181      | Pivot™ Tough-Light .....                  | 174          |
| Male Adapter Ftg. x M .....                     | 233     | Multi-Head Fin-Tool.....                 | 173      | Plastic DWV J-Hooks.....                  | 194          |
| Male Adapter Reducing (MIPT x Slip).....        | 193     | Multiple Horsepower Motors.              | 139      | Plastic Hanger Strap .....                | 42           |
| Malleable Black Iron Pipe Fittings.....         | 52-53   | Nitrile Gloves.....                      | 90       | Plastic Thermostat Guards....             | 161          |
| Manometers, Pressure .....                      | 175     | Nitrogen Cylinders.....                  | 168      | Plastic Wall Plates .....                 | 157          |
| Manual Reset Fire Stat.....                     | 160     | Nitrogen Purge Tool .....                | 168      | Plastic Wide Mouth Dryer Vent Head.....   | 40           |
| Map-Pro and Propane Gas... ..                   | 184     | Non-Insulated Female Slip-Ons .....      | 102      | Plated Steel Utility Covers ....          | 110          |
| Markers.....                                    | 89      | Non-Insulated Flag Female Slip-Ons ..... | 102      | Plenum Thermostat Wire .....              | 162          |
| Masonry Bit .....                               | 93      | Non-Insulated Male Slip-Ons              | 102      | Plug .....                                | 53, 192, 239 |
| Masonry Screw.....                              | 93      | Non-Insulated Rings .....                | 105      | Plug (MIPT) .....                         | 192          |
| Measuring Tapes, Staples and Staple Guns .....  | 176     | Non-Insulated Spades.....                | 105      | Plug (Slip).....                          | 192          |
| Mechanical Screw Starter ....                   | 176     | Non-Metallic Sheathed Cable              | 145      | Plug Fuses .....                          | 153          |
| Medium Split Lock Washers .                     | 116     | Nut Setter - Power.....                  | 178      | Pocket 4-in-1 Mini Screwdriver .....      | 179          |
| Merchandising .....                             | 251     | Nut Setters .....                        | 178      | Polyethylene Tubing .....                 | 194          |
| Metal Bat Handle Toggle Switches .....          | 123     | Nuts and Bolts.....                      | 115-116  | Polypropylene Parts Boxes....             | 119          |
| Metal Drain Pan.....                            | 80      | Nylon Cable Clamps.....                  | 118      | Porcelain Outlet Box Lampholders .....    | 123          |
| Metal Drive Anchors.....                        | 108     | Nylon Cable Ties.....                    | 113      | Porcelain Wire Connectors... ..           | 125          |
| Metal Guard Trouble Lights... ..                | 172     | Nylon Cable Ties with Mounting Hole..... | 113      | Portable Hand Torch.....                  | 184          |
| Metal Parts Boxes .....                         | 119     | Nylon Fittings .....                     | 186-187  | Posters.....                              | 251          |
| Metallic Duct - 5 Ply .....                     | 42      | Nylon Rods.....                          | 118      | Potential Relays.....                     | 152          |
| Meters, Detectors, Alarms .....                 | 176     | Oatey® Products .....                    | 188      | Power Blocks .....                        | 172          |
| Mini Split Line Sets .....                      | 243     | Odor Neutralizers .....                  | 227      | Power Cords and Work Lights               | 117          |
| Mini-Split Condensate Drain Line .....          | 81      | Odor-Aid™ .....                          | 227      | Power Measuring Tapes .....               | 176          |
| Mini-Split Drain Adapters.....                  | 81      | Offset Snips.....                        | 180      | Power Sprayer .....                       | 224          |
| Mini-Split Pumps .....                          | 77      | Oils.....                                | 228-230  | Power Supply Cords (Pigtails)             | 158          |
|   |         | One Time Fuses.....                      | 153      | Power Supply Replacement Cords .....      | 122          |
|   |         | Outdoor Extension Cord.....              | 172      | Pro-Air Duct Sealant UL 181 ...           | 93           |
|   |         | Outside Tube Cleaning Brushes.....       | 170      |   |              |

|   |     |  |         |  |         |
|---|-----|--|---------|--|---------|
| Pro-Air Industrial Grade Spray Adhesive .....                         | 93  | Pro-Weld™ PVC Cement (Pool and Turf - Blue) .....                        | 189     | Reach-It .....                               | 178     |
| Pro-Blue™ .....   | 220 | Pro-Weld™ PVC Cement (Regular Body) .....                                | 189     | Receptacles .....                            | 123     |
| Pro-Brown™ .....  | 220 | Pro-Weld™ PVC Cement (Universal) .....                                   | 189     | Reducer Bushing (SPIG X FIPT) .....          | 193     |
| Pro-Bubble™ Leak Detector... ..                                       | 225 | Pro-Weld™ Weather - ALL.....   | 189     | Reducer Bushing (SPIG x Slip) .....          | 193     |
| Pro-Flush® Accessories .....  | 223 | Pro-Yellow™ .....  | 221     | Reducer Coupling.....                        | 203     |
| Pro-Flush® HVAC Flushing Solvent.....                                 | 223 | PTFE Tape .....  | 82      | Reducer Coupling w/Stop C x C .....          | 234     |
| Pro-Green™ .....  | 220 | P-Traps .....  | 235     | Reducing Coupling .....                      | 52      |
| Pro-Kleen™ .....  | 221 | Pull-A-Spout Oiler .....   | 88      | Reducing Tee.....                            | 52      |
| Pro-Lube-ALK™ Alkylbenzene. ....                                      | 228 | Pump Parts & Accessories .....   | 76      | Reducing Tee C x C x C .....                 | 235     |
| Pro-Lube-POE™ Polyolester ... ..                                      | 229 | Pumps .....  | 76-77   | Reducing Washers.....                        | 114     |
| Pro-Lube™ Mineral Oil .....   | 228 | Pure-Beam™ Ultraviolet Light..   | 40      | Refractometer.....                           | 178     |
| Pro-Lube-VAC™ Vacuum Pump Oil .....                                   | 230 | Purple Primer for PVC Pipe and Fittings .....                            | 188     | Refrigerant Charging.....                    | 242     |
| Pro-Prime™ Clear PVC Primer .....                                     | 189 | PVC Cement - Clear.....  | 188     | Refrigerant Labels.....                      | 245     |
| Pro-Prime™ PVC Primer (Purple) .....                                  | 189 | PVC Condensate Pipe .....  | 190     | Refrigerant Recovery Cylinders .....         | 245     |
| Pro-Red Plus™ .....   | 221 | PVC Condensate Pipe - White .....  | 190     | Refrigerant Recovery Products .....          | 245     |
| ProTek BG™ for Cast Iron Water Boilers .....                          | 223 | PVC DWV Fittings.....  | 190     | Refrigerant Safety Caps.....                 | 246     |
| ProTek EG™ .....  | 222 | PVC Gray Cement for High Efficiency Furnaces, Vent and Make-up Air ..... | 188     | Refrigerant Tubing.....                      | 243-244 |
| ProTek™ Closed Loop Heat Transfer Fluid.....                          | 222 | PVC Primer - Clear.....  | 188     | Refrigeration Oils.....                      | 228-229 |
| ProTek™ PG 100 .....  | 222 | PVC Primer and Cement .....  | 189     | Refrigerator Coil Brush .....                | 169     |
| ProTek™ PG Plus .....   | 223 | PVC Schedule 40 Pressure Fittings.....                                   | 191-193 | Refrigerator/Freezer Analog Thermometer..... | 183     |
| Pro-Thaw™ Liquid Dryer for Refrigerants.....                          | 230 | QD® Contact Cleaner.....   | 85      | Regulators.....                              | 168     |
| PRO-TITE™ Resin Based Thread Sealant .....                            | 230 | Quick Heat Pump Stand.....   | 32      | Rehvac Nitrogen Purging Equipment .....      | 168     |
| Pro-Treat® 151 Premium Condensate Drain Pan Treatment .....           | 228 | Quick Stand .....  | 33      | Rehvac Refillable Gas Cylinders .....        | 168     |
| Pro-Treat® 152 King-Size Premium Condensate Drain Pan Treatment ..... | 228 | Quick Swivel "U" Mount.....  | 36      | Relays.....                                  | 152     |
| Pro-Treat® 161 Condensate Drain Pan Treatment .....                   | 228 | Quick Swivel Flush Mount w/"H" Bracket.....                              | 36      | Replacement Compressor Leads .....           | 159     |
| Pro-Treat® 200 Economy Condensate Drain Pan Treatment .....           | 228 | Quick Swivel Flush Mount w/"I" Bracket.....                              | 36      | Replacement Element Kits ...                 | 160     |
| Pro-Treat® 217 Economy Condensate Drain Pan Treatment .....           | 228 | Quick-Sling® .....   | 36      | Rheem Motor Bracket .....                    | 142     |
| Pro-Treat® 350 Condensate Drain Pan Treatment .....                   | 227 | Quick-Sling® Accessories .....   | 36      | Right Angle Plug .....                       | 122     |
| Pro-Treat® Pan Strips .....   | 227 | Quick-Tap .....  | 237     | Rigid Conduit Bodies .....                   | 112     |
| Pro-Weld™ PVC Cement (Heavy Body).....                                | 189 | Quick-Tap-2 .....  | 237     | Romex Connectors - Metallic                  | 145     |
|   |     | Radiant Leak Finder™ .....   | 225     | Roof Flashing .....                          | 39      |
|   |     | Rain-R-Shine Blue Cement ...   | 188     | Roof Inlets.....                             | 204     |
|   |     | Ratchet Strap .....  | 181     | Roof Louver .....                            | 39      |
|   |     | Rayovac Industrial Flashlights and Lanterns .....                        | 173     | Rope.....                                    | 180     |
|   |     | Rayovac Industrial Max Alkaline Batteries.....                           | 85      | Rough Service Light Bulbs....                | 172     |
|   |     | Rayovac Lantern Batteries.....   | 85      | Round Extension Cords.....                   | 117     |
|   |     | Rayovac LED Flashlights .....  | 173     | Rubber / Cork Anti-Vibration Pad .....       | 24      |
|   |     |  |         | Rubber Anti-Vibration Pad .....              | 24      |
|   |     |  |         | Rubber Connector .....                       | 122     |

|                                      |            |                                   |         |                                  |             |
|--------------------------------------|------------|-----------------------------------|---------|----------------------------------|-------------|
| Rubber Tie Down Strap.....           | 181        | Sheet Metal Screw Assortments     | 117     | Steel Thermostat Guards.....     | 161         |
| Safety Plates .....                  | 111        | Sheet Metal Screws .....          | 93-94   | Steel Utility Boxes .....        | 110         |
| Safety Supplies, Devices .....       | 90         | Sheet Metal Screws Drill Point    | 94      | Stick-E-Tape.....                | 44          |
| Saf-N-Kleen™ Aerosol Solvent Coil    | 222        | Sheet Metal Screws Taper          | 94      | Sting Less Wasp & Hornet         | 94          |
| Cleaner.....                         | 222        | Point.....                        | 94      | Killer .....                     | 94          |
| Samples/Demos .....                  | 250        | Shoe Covers.....                  | 90      | Storage Containers.....          | 119         |
| Sani C-N-D™ Coil and Drain Pan       | 222        | Shop Towels .....                 | 87      | Stove Bolts .....                | 116         |
| Disinfectant.....                    | 222        | Short Forged Flare Nut.....       | 239     | Stranded Copper THHN Wire        | 162-163     |
| Satchel Style Case.....              | 119        | Short Nut .....                   | 239     | .....                            | 163         |
| Saws and Saw Blades.....             | 179        | Side Flange Mount Pillow          | 142     | Stranded Copper Wire on Spool    | 163         |
| Scotch 35 Vinyl Electrical Tape      | 158        | Blocks .....                      | 142     | .....                            | 163         |
| .....                                | 158        | Sight Glasses .....               | 242     | Stranded Copper Wire, 194° F.    | 162         |
| Scotch 3M Super 33+ Electrical       | 158        | Silicone Sealant .....            | 92      | Stranded High Temperature Wire   | 121         |
| Tape.....                            | 158        | Single Piece Liquid Tite Fittings | 144     | .....                            | 121         |
| Scotch 3M Super 88 Electrical        | 158        | .....                             | 144     | Strapping Hanger Iron.....       | 41          |
| Tape.....                            | 158        | SJTO Service Cord .....           | 121     | Straps .....                     | 114         |
| Scotch® Electrical Tapes.....        | 158        | Slip-On Solderless Terminals      | 102-103 | Straps, Truck Rope.....          | 180-181     |
| Screwdrivers, Driver Sets .....      | 179        | .....                             | 102-103 | Styrene Parts Boxes .....        | 119         |
| Screwloose® Industrial               | 87         | Smoke Detectors .....             | 49      | Suction Line Driers .....        | 241         |
| Penetrating Oil .....                | 87         | Smokeys .....                     | 39      | Super Change .....               | 223         |
| Screws .....                         | 93-94, 117 | Snips, Notchers, Crimpers,        | 180     | Super Glue.....                  | 91          |
| Sealant, Epoxy, Glue .....           | 91         | Seamers .....                     | 180     | Super Seal Flex-Inject® .....    | 226         |
| Sealing Compounds, Adhesive          | 91-93      | Soffit Fitting .....              | 201     | Super Stands.....                | 34          |
| .....                                | 91-93      | SP-400™ Corrosion Inhibitor... 88 | 201     | SuperComb.....                   | 173         |
| Seal-N-Go® Self-Sealing Refrigerant  | 226        | Spade Terminals .....             | 105     | Super-Kool™ Ice Machine Cleaner  | 225         |
| .....                                | 226        | Spark Electrode .....             | 49      | .....                            | 225         |
| SeekerMax™ .....                     | 226        | Special Purpose Solderless        | 103-104 | Supports .....                   | 194         |
| SeekerMini™ .....                    | 225        | Terminals .....                   | 103-104 | Sure Shot .....                  | 226         |
| Self Tapping Water Valve .....       | 194        | Specialty Fasteners.....          | 118     | Sure-Stick Heavy Duty Adhesive   | 84          |
| Self-Drilling Gypsum Wallboard       | 108        | Specialty Fittings .....          | 119     | .....                            | 84          |
| Anchors .....                        | 108        | SpeediChannel™ .....              | 201     | Sweat-Free Pipe Insulation Spray | 84          |
| Self-Drilling Screw Repair Kit       | 117        | SpeediChannel™ Accessories .      | 204     | .....                            | 84          |
| Self-Drilling Screws.....            | 117        | SpeediChannel™ Kits .....         | 204     | Switch Covers.....               | 157         |
| Semi-Rigid Aluminum Duct ....        | 40         | SpeediChannel™ Line Set Cover     | 201     | Switch/Plug Combo .....          | 157         |
| Sentry Refrigerant Locking Caps      | 246        | System.....                       | 201     | Swivel Head Deburring Tool..     | 184         |
| .....                                | 246        | Split Bolt Connectors .....       | 126     | System Cleaners.....             | 229         |
| Sentry Refrigerant Locking Caps      | 246        | Spotlight .....                   | 175     | T-50 Series Staples and Staple   | 176         |
| R-22, Green, 1/4" .....              | 246        | Sprayers.....                     | 224     | Guns.....                        | 176         |
| Sentry Refrigerant Locking Caps      | 246        | Standard Line Sets.....           | 243     | Tab Adapters - Male Tabs.....    | 104         |
| R-410, Red, 1/4" .....               | 246        | Standard Solderless Terminals     | 104-105 | Tab Adapters - Piggy Back        | 104         |
| Sentry Refrigerant Locking Caps      | 246        | .....                             | 104-105 | Slip-Ons .....                   | 104         |
| R-410, Red, 5/16" .....              | 246        | Standard Wire Connectors ...      | 125     | Tab Adapters - Quick Disconnect  | 104         |
| Sentry Refrigerant Locking Caps      | 246        | Staples.....                      | 145     | with Screw .....                 | 104         |
| Universal, Silver, 1/4" .....        | 246        | Sta-Plex™ Premium Red Grease      | 88      | Tab Adapters - Single Fem Dbl    | 104         |
| Sentry Universal Key for Refrigerant | 246        | .....                             | 88      | Male Tabs.....                   | 104         |
| Locking Caps.....                    | 246        | Steel 1900 Boxes .....            | 110     | Tandem Grounding Rubber          | 122         |
| Sequencers.....                      | 160        | Steel 1900 Covers.....            | 111     | Handle .....                     | 122         |
| Set Screws .....                     | 118        | Steel Octagon Box .....           | 110     | Tap Connectors .....             | 104         |
| Sheet Metal Screw Assortment Kit     | 93         |                                   |         | Tapes .....                      | 42, 82, 119 |



|                                  |          |                                  |                      |                                     |                             |
|----------------------------------|----------|----------------------------------|----------------------|-------------------------------------|-----------------------------|
| Tattle-Tale Control Monitor..... | 177      | Combo Device.....                | 123                  | Versa Cap® Flue and Hot Stack       | ..... 39                    |
| Tee.....                         | 52       | Toggle Switches.....             | 123, 158             | Vinyl Grommet Assortment            | Packs..... 124              |
| Tee (Barb x Barb x Barb) .....   | 187      | Tongue and Groove Pliers ....    | 172                  | Vinyl Grommets.....                 | 124                         |
| Tee (Slip x FIPT x Slip).....    | 191      | Torches .....                    | 184                  | Wagner® Adhesive Sealant ....       | 91                          |
| Tee (Slip x Slip x Slip) .....   | 191      | Torque Plus - Hard Start Kits .  | 149                  | Wagner® Direct Drive Furnace        | Blower Motors .....         |
| Tee C x C x C.....               | 235      | Transformers .....               | 151                  | ..... 139                           |                             |
| Teflon Tape .....                | 119      | Transformers - Class 2.....      | 151                  | Wagner® High Temperature            | Condenser Fan Motors.....   |
| Telescopic Inspection Mirror.    | 177      | Transparent Plastic Boxes with   |                      | ..... 138                           |                             |
| Teri® Towels .....               | 87       | Terminal Asst.....               | 159                  | Wagner® Multiple Horsepower         | Condenser Fan Motors.....   |
| Terminal Block Jumpers.....      | 124      | Traps .....                      | 191                  | ..... 138                           |                             |
| Terminal Kits.....               | 107      | Tri-Fold Brochures .....         | 250                  | Wagner® Multiple Horsepower         | Furnace Blower Motors ..... |
| Terminals, Connectors.....       | 159      | Triple Outlets .....             | 122                  | ..... 139                           |                             |
| Terry Towels .....               | 87       | Triple-D™ Universal Coil Cleaner | ..... 220            | Wagner® Single Speed Condenser      | Fan Motors.....             |
| Test Cord (Female) .....         | 182      | Trouble Lights.....              | 117                  | ..... 138                           |                             |
| Test Kits, Strips, and Prevent . | 229      | Truck Rope .....                 | 180                  | Wall Escutcheon.....                | 203                         |
| Test Leads .....                 | 181-182  | TrueStart® Ignition Accessories  | ..... 48-49          | Wall Penetration.....               | 201                         |
| Testers .....                    | 120, 182 | ..... 48-49                      |                      | Wasp, Hornet, and Yellow Jacket     | Killers.....                |
| Testers, Leads, Clips, Fuses ... | 120      | Truestart® Pilot Burners .....   | 48                   | ..... 94                            |                             |
| TFFN Stranded Hook-Up Wire.      | 120      | Tube Working Tools .....         | 183-184              | Water Heater Pans.....              | 80                          |
| The Black Pad®.....              | 22       | Tubing Insulation .....          | 247                  | Waterless Hand Wipes .....          | 86                          |
| The Hurricane Pad™ .....         | 21       | Tubing, Clamps, and Kits .....   | 194                  | Waterproof Box with Lever Switch    | Cover .....                 |
| The Hurricane Pad™ Bracket...    | 21       | Type "S" Non-Tamper Fuses..      | 153                  | ..... 111                           |                             |
| The Hurricane Pad™ MD.....       | 21       | Type 2 Wall Brackets.....        | 31                   | Waterproof Covers.....              | 111                         |
| The Hurricane T-Class Pad™ ....  | 21       | Type 3 Wall Brackets.....        | 31                   | WD-40® .....                        | 88                          |
| The Purifier™.....               | 227      | UL Listed Foil Tape .....        | 42                   | Weatherproof Boxes .....            | 111                         |
| Thermal Controls .....           | 160      | Ultra Lite 3-36® Lubricant.....  | 88                   | Welder's Brush .....                | 169                         |
| Thermometers .....               | 183      | UltraLite® Earthquake Pads....   | 19                   | Welding Torches, Supplies....       | 184                         |
| Thermometers/Probes.....         | 183      | Ultralite® Lightweight Concrete  | Equipment Pads ..... | Wellington ECM Refrigeration        | Motors .....                |
| Thermoplastic Handle Plug ..     | 121      | ..... 18-19                      |                      | ..... 141                           |                             |
| Thermostat Guards .....          | 161      | UltraLite® Wedge Pads .....      | 19                   | Wet Switch Flood Detector .....     | 77                          |
| Thermostat Wire .....            | 121, 162 | UltraViolet Light .....          | 40                   | Whips .....                         | 142-143                     |
| Thermostats .....                | 161      | Union.....                       | 53                   | White Lithium Grease .....          | 88                          |
| THHN Stranded Hook-Up Wire       | 120      | Union C x Brass .....            | 234                  | White Nylon Ties with Mounting      | Hole.....                   |
| Thinwall E.M.T. Connectors...    | 112      | Union Coupling .....             | 202                  | ..... 165                           |                             |
| Thread Sealant with Teflon ....  | 91       | Universal Alarm .....            | 77                   | White Nylon Wire Ties .....         | 165                         |
| Thread Sealants .....            | 230      | Universal Carbide Igniters ..... | 48                   | White Pipe .....                    | 244                         |
| Three Phase Disconnects.....     | 144      | Universal Pump Elbow .....       | 204                  | Winged Wire Connectors .....        | 125                         |
| Three Pole Definite Purpose      |          | Universal Spun Copper Driers     | 241                  | Wire.....                           | 120-121, 162-163            |
| Contactors .....                 | 150      | Upright Snips.....               | 180                  | Wire and Cable Clamps - Nylon       | ..... 165                   |
| Time Delay Fuses .....           | 153      | Utility Covers .....             | 110                  | Wire Connectors.....                | 163-164                     |
| Time Delay Plug Fuses.....       | 153      | Utility Fuse Outlets.....        | 123                  | Wire for Mini-Split Installation .. | 162                         |
| Time Delays .....                | 154      | Utility Plates .....             | 110                  | Wire Tie Mounts.....                | 165                         |
| Tin Handle Acid Brushes .....    | 169      | U-Type Strap.....                | 235                  | ..... 164-165                       |                             |
| T-Joint.....                     | 202      | Vacuum Pump Oil .....            | 230                  | Wiring Devices .....                | 121-126                     |
| Toggle Bolts.....                | 115      | Valve Action Marker .....        | 89                   | Wolverine® Universal Hot Surface    |                             |
| Toggle Switch and Receptacle     |          | Valve Action Paint Marker.....   | 89                   |                                     |                             |
| Combo Device.....                | 123      | Vent Termination Kits.....       | 49                   |                                     |                             |
| Toggle Switch Cover .....        | 158      | Ventilation Products.....        | 39                   |                                     |                             |
| Toggle Switch Neon Pilot Light   |          |                                  |                      |                                     |                             |

**CATEGORY INDEX** cont'd

|  |         |
|--|---------|
| Igniter .....                                  | 48      |
| Workhorse® Manufactured Rags<br>.....          | 87      |
| Worklights by Cliplight®                       | 174-175 |
| WypAll Plus .....                              | 87      |
| WypAll ShopPro X80 Towels ...                  | 87      |
| Zinc Plated DC Steel Romex<br>Connectors ..... | 112     |
| Zinc-It® Instant Cold Galvanize™               |         |
| Zinc Rich Galvanize Coating ..                 | 88      |

**PART NUMBER INDEX**

|                    |                     |                     |                     |                     |
|--------------------|---------------------|---------------------|---------------------|---------------------|
| 01714 ..... 91     | 14145 ..... 39      | 230-18-4 ..... 162  | 230-EB6..... 202    | 230-WC4B ..... 201  |
| 01724 ..... 91     | 14175 ..... 39      | 230-AFB3 ..... 201  | 230-EIN3 ..... 202  | 230-WC6 ..... 201   |
| 02033 ..... 245    | 14250 ..... 39      | 230-AFB4 ..... 201  | 230-EIN3B ..... 202 | 230-WR3 ..... 203   |
| 02053 ..... 245    | 14340 ..... 39      | 230-B1HD ..... 31   | 230-EIN4 ..... 202  | 230-WR4 ..... 203   |
| 02100 ..... 245    | 145-175 ..... 148   | 230-B2L ..... 31    | 230-EIN4B ..... 202 | 230-WR6 ..... 203   |
| 02255 ..... 245    | 145-175220 .. 148   | 230-B2M ..... 31    | 230-EIN6 ..... 202  | 230-WS2 ..... 201   |
| 04010 ..... 245    | 145-175330 .. 149   | 230-B2XL ..... 32   | 230-FB3 ..... 201   | 233-292 ..... 148   |
| 04011 ..... 245    | 161-193 ..... 148   | 230-B3L ..... 31    | 230-FB3B ..... 201  | 233-292220 ... 148  |
| 04012 ..... 245    | 161-193220 ... 148  | 230-B3M ..... 31    | 230-FB4 ..... 201   | 23559 ..... 30      |
| 04022 ..... 245    | 161-193330 ... 149  | 230-BP17W ..... 30  | 230-FB453 ..... 202 | 2424-2 ..... 20     |
| 04134 ..... 245    | 1636-2 ..... 20     | 230-CP3 ..... 202   | 230-FB453B... 202   | 2424-3 ..... 20     |
| 04402 ..... 245    | 1636-3 ..... 20     | 230-CP3B ..... 202  | 230-FB454 ..... 202 | 2436-2 ..... 20     |
| 04404 ..... 245    | 16491 ..... 92      | 230-CP4 ..... 202   | 230-FB454B ... 202  | 2436-3 ..... 20     |
| 04407 ..... 245    | 16500 ..... 184     | 230-CP4B ..... 202  | 230-FB456..... 202  | 2442-2 ..... 20     |
| 04410 ..... 245    | 16510 ..... 184     | 230-CP6 ..... 202   | 230-FB4B ..... 201  | 24-458 ..... 174    |
| 04421 ..... 245    | 16520 ..... 184     | 230-D3 ..... 201    | 230-FB6 ..... 201   | 24-460 ..... 174    |
| 04451 ..... 245    | 18001 ..... 92      | 230-D3B ..... 201   | 230-FJ3 ..... 203   | 2448-3 ..... 20     |
| 04500 ..... 245    | 18002 ..... 92      | 230-D4 ..... 201    | 230-FJ4 ..... 203   | 2454-2 ..... 20     |
| 04507 ..... 245    | 18003 ..... 92      | 230-D4B ..... 201   | 230-FR3 ..... 203   | 2460-3 ..... 20     |
| 04850 ..... 245    | 18415 ..... 39      | 230-D6 ..... 201    | 230-FR4 ..... 203   | 25001 ..... 180     |
| 04871 ..... 245    | 189-227 ..... 148   | 230-DC3 ..... 203   | 230-FR6..... 203    | 25720 ..... 39      |
| 04872 ..... 245    | 189-227220 .. 148   | 230-DC4 ..... 203   | 230-IK3 ..... 204   | 2601 ..... 224      |
| 1000-1200 .... 148 | 189-227330 ... 149  | 230-DC6 ..... 203   | 230-IK4 ..... 204   | 2602 ..... 224      |
| 10012 ..... 92     | 200-240 ..... 148   | 230-DCLIP ..... 204 | 230-IKC3 ..... 204  | 2603 ..... 224      |
| 1002 ..... 224     | 20122 ..... 223     | 230-DCLIP-10 . 204  | 230-IKC4 ..... 204  | 26-2 ..... 20       |
| 108-130 ..... 148  | 20122 ..... 225     | 230-DE3 ..... 203   | 230-INJ465 ... 204  | 2626-2 ..... 20     |
| 108-130220 ... 148 | 20133 ..... 226     | 230-DE3B ..... 203  | 230-LFB3 ..... 202  | 2626-3 ..... 20     |
| 108-130330 .. 149  | 20-3132-18 ..... 50 | 230-DE4 ..... 203   | 230-LFB3B ..... 202 | 2660-2 ..... 20     |
| 111112 ..... 174   | 20-3132-24 ..... 50 | 230-DE4B ..... 203  | 230-LFB4 ..... 202  | 270-324 ..... 148   |
| 111113 ..... 174   | 20-3132-36 ..... 50 | 230-DE6 ..... 203   | 230-LFB4B ..... 202 | 270-324220 ... 148  |
| 111114 ..... 174   | 20-3132-48 ..... 50 | 230-DL16 ..... 81   | 230-LFB6 ..... 202  | 270-324330 ... 149  |
| 111115 ..... 174   | 20-3135-18 ..... 51 | 230-DL16-20 ... 81  | 230-MB14W ..... 30  | 30-2 ..... 22       |
| 111116 ..... 174   | 20-3135-24 ..... 51 | 230-DLF16 ..... 81  | 230-MB17W..... 30   | 3030-2 ..... 20     |
| 111117 ..... 174   | 20-3135-36 ..... 51 | 230-DLF18 ..... 81  | 230-MB36B ..... 30  | 3030-3 ..... 20     |
| 111118 ..... 174   | 20-3135-48 ..... 51 | 230-DLF20 ..... 81  | 230-MBCW ..... 30   | 30306 ..... 172     |
| 111121 ..... 175   | 21367 ..... 81      | 230-DLF25 ..... 81  | 230-PFB3 ..... 204  | 30309 ..... 172     |
| 111123 ..... 174   | 216-259 ..... 148   | 230-DLF32 ..... 81  | 230-SF3 ..... 201   | 30310 ..... 172     |
| 111128 ..... 174   | 216-259220 ... 148  | 230-DLFY ..... 81   | 230-SF4 ..... 201   | 30-3131-24 ..... 50 |
| 111130 ..... 174   | 216-259330 ... 149  | 230-DPML ..... 81   | 230-TC34 ..... 203  | 30-3131-36 ..... 50 |
| 114301 ..... 174   | 22068 ..... 158     | 230-DPPL ..... 81   | 230-TC46 ..... 203  | 30-3131-48 ..... 50 |
| 114302 ..... 174   | 22098 ..... 30      | 230-DPPM ..... 81   | 230-TJ4 ..... 202   | 30-3132-12 ..... 50 |
| 124-156 ..... 148  | 23010 ..... 90      | 230-DSCREW . 204    | 230-TJ4B ..... 202  | 30-3132-18 ..... 50 |
| 124-156220 ... 148 | 230-14-4 ..... 162  | 230-EB3 ..... 202   | 230-TJ6 ..... 202   | 30-3132-24 ..... 50 |
| 124-156330 ... 149 | 230-14-4S ..... 162 | 230-EB3B ..... 202  | 230-WC3 ..... 201   | 30-3132-30 ..... 50 |
| 12601 ..... 81     | 230-14-7 ..... 162  | 230-EB4 ..... 202   | 230-WC3B ..... 201  | 30-3132-36 ..... 50 |
| 14062 ..... 81     | 230-16-2 ..... 162  | 230-EB4B ..... 202  | 230-WC4 ..... 201   | 30-3132-48 ..... 50 |

## PART NUMBER INDEX cont'd

|                     |                   |                   |                   |                    |
|---------------------|-------------------|-------------------|-------------------|--------------------|
| 30-3132-60 ..... 50 | 3587 ..... 140    | 3732HS ..... 140  | 3GR0340 ..... 146 | 4224CX ..... 106   |
| 30-3132-72 ..... 50 | 3588 ..... 140    | 3733HS ..... 140  | 3GR0425 ..... 146 | 4224NX ..... 106   |
| 3036-2 ..... 20     | 3589 ..... 140    | 3734HS ..... 140  | 3GR0435 ..... 146 | 4226 ..... 106     |
| 3036-3 ..... 20     | 3590 ..... 140    | 37350H ..... 146  | 3GR0515 ..... 146 | 4226CX ..... 106   |
| 3060-3 ..... 20     | 3595 ..... 140    | 37350R ..... 146  | 3GR0520 ..... 146 | 4231 ..... 106     |
| 3143-2 ..... 20     | 3596 ..... 140    | 3735HS ..... 140  | 3GR0525 ..... 146 | 4252 ..... 106     |
| 3143-3 ..... 20     | 362-16 ..... 84   | 3736HS ..... 140  | 3GR0530 ..... 146 | 4252CX ..... 106   |
| 315-20 ..... 84     | 3636-2 ..... 20   | 3737HS ..... 140  | 3GR0535 ..... 146 | 4253 ..... 106     |
| 3202 ..... 139      | 3636-3 ..... 20   | 3738HS ..... 140  | 3GR0540 ..... 146 | 4253CX ..... 106   |
| 3203 ..... 139      | 3640-2 ..... 20   | 3739HS ..... 140  | 3GR0545 ..... 146 | 4254CX ..... 106   |
| 3203HS ..... 140    | 3640-3 ..... 20   | 37400H ..... 146  | 3GR0550 ..... 146 | 42897 ..... 39     |
| 3204HS ..... 140    | 3648-2 ..... 20   | 37400R ..... 146  | 3GR0555 ..... 146 | 4293 ..... 125     |
| 3205 ..... 139      | 3648-3 ..... 20   | 37450H ..... 146  | 3GR0560 ..... 146 | 4293CX ..... 125   |
| 3205HS ..... 140    | 3650-3 ..... 20   | 37450R ..... 146  | 3GR0570 ..... 146 | 4294 ..... 125     |
| 32-2 ..... 20       | 3654-2 ..... 20   | 3746 ..... 139    | 3GR0580 ..... 146 | 4294CX ..... 125   |
| 32-3 ..... 20       | 3660-3 ..... 20   | 3747HS ..... 140  | 3GR1035 ..... 146 | 4296 ..... 125     |
| 3232-2 ..... 20     | 3678-3 ..... 20   | 37500H ..... 146  | 3GR1080 ..... 146 | 4296CX ..... 125   |
| 3232-3 ..... 20     | 37030H ..... 146  | 37500R ..... 146  | 3GR7530 ..... 146 | 43-53220 ..... 148 |
| 3237-3 ..... 20     | 37040H ..... 146  | 37550R ..... 146  | 3GR7540 ..... 146 | 436-20 ..... 94    |
| 324-388 ..... 148   | 37050H ..... 146  | 37600H ..... 146  | 3GR7555 ..... 146 | 45020H ..... 147   |
| 325-12 ..... 84     | 37050HB ..... 146 | 37600R ..... 146  | 3GR7560 ..... 146 | 45030H ..... 147   |
| 33025 ..... 39      | 37050R ..... 146  | 37700H ..... 146  | 3GR7580 ..... 146 | 45040H ..... 147   |
| 3345-3 ..... 20     | 37060H ..... 146  | 37800H ..... 146  | 3WF-01 ..... 228  | 45050H ..... 147   |
| 340-408 ..... 148   | 37075H ..... 146  | 37800R ..... 146  | 400-480 ..... 148 | 45050HU ..... 148  |
| 3434-2 ..... 20     | 37075HB ..... 146 | 378-440 ..... 148 | 4042-3 ..... 20   | 45050R ..... 147   |
| 3458 ..... 140      | 37075R ..... 146  | 3842-3 ..... 20   | 4054-3 ..... 20   | 45060H ..... 147   |
| 3458HS ..... 140    | 37100H ..... 146  | 3870-3 ..... 20   | 4062-3 ..... 20   | 45075H ..... 147   |
| 3459 ..... 140      | 37100HB ..... 146 | 3GJ0330 ..... 146 | 410239 ..... 174  | 45075HU ..... 148  |
| 3459HS ..... 140    | 37125H ..... 146  | 3GJ0515 ..... 146 | 4147-3 ..... 20   | 45075R ..... 147   |
| 3463 ..... 141      | 37125R ..... 146  | 3GJ0520 ..... 146 | 4183-3 ..... 20   | 45100H ..... 147   |
| 3464 ..... 141      | 37150H ..... 146  | 3GJ0525 ..... 146 | 4200AX ..... 106  | 45100HU ..... 148  |
| 3465 ..... 140      | 37150R ..... 146  | 3GJ0530 ..... 146 | 4204 ..... 106    | 45100R ..... 147   |
| 3465HS ..... 140    | 37175H ..... 146  | 3GJ0535 ..... 146 | 4204CX ..... 106  | 45125H ..... 147   |
| 3466 ..... 141      | 37175R ..... 146  | 3GJ0540 ..... 146 | 4205CX ..... 106  | 45125HU ..... 148  |
| 3467 ..... 141      | 37200H ..... 146  | 3GJ0545 ..... 146 | 4213 ..... 106    | 45125R ..... 147   |
| 3468 ..... 140      | 37200R ..... 146  | 3GJ0555 ..... 146 | 4213CX ..... 106  | 45150H ..... 147   |
| 3468HS ..... 140    | 37250H ..... 146  | 3GJ1025 ..... 146 | 4214 ..... 106    | 45150HU ..... 148  |
| 3469 ..... 140      | 37250R ..... 146  | 3GJ1060 ..... 146 | 4214CX ..... 106  | 45150R ..... 147   |
| 3469HS ..... 140    | 3726HS ..... 140  | 3GJ1520 ..... 146 | 4215 ..... 106    | 45175H ..... 147   |
| 357-20 ..... 222    | 3727 ..... 139    | 3GJ7530 ..... 146 | 4215CX ..... 106  | 45200H ..... 147   |
| 358-20 ..... 222    | 3728 ..... 139    | 3GJ7535 ..... 146 | 4219 ..... 106    | 45200HU ..... 148  |
| 358-20S ..... 222   | 3729 ..... 139    | 3GJ7545 ..... 146 | 4220 ..... 106    | 45200R ..... 147   |
| 3583 ..... 140      | 3730 ..... 139    | 3GJ7555 ..... 146 | 4220CX ..... 106  | 45250H ..... 147   |
| 3584 ..... 140      | 37300H ..... 146  | 3GR0325 ..... 146 | 4221 ..... 106    | 45250HU ..... 148  |
| 3585 ..... 140      | 37300R ..... 146  | 3GR0330 ..... 146 | 4221CX ..... 106  | 45250R ..... 147   |
| 3586 ..... 140      | 3731 ..... 139    | 3GR0335 ..... 146 | 4224 ..... 106    | 45300H ..... 147   |



**PART NUMBER INDEX** cont'd

|                    |                    |                     |                     |                     |
|--------------------|--------------------|---------------------|---------------------|---------------------|
| 45300HU ..... 148  | 4JJ0535 ..... 147  | 4JR7560.....147     | 5-2002 ..... 190    | 5380AX..... 118     |
| 45300R ..... 147   | 4JJ0540 ..... 147  | 4JR7560U.....148    | 5-2005 ..... 190    | 5381 ..... 118      |
| 45350H ..... 147   | 4JJ0545 ..... 147  | 4JR7570.....147     | 5201 ..... 117      | 538-1/2 ..... 240   |
| 45350HU ..... 148  | 4JJ0555 ..... 147  | 4JR7580.....147     | 5223 ..... 122      | 538-1/4 ..... 240   |
| 45350R ..... 147   | 4JJ0560 ..... 147  | 4WF-01 ..... 228    | 5225 ..... 117      | 538-1-1/8 ..... 240 |
| 45400H ..... 147   | 4JJ1055 ..... 147  | 5002 ..... 115      | 5230 ..... 117      | 538-1-3/8 ..... 240 |
| 45400HU ..... 148  | 4JJ7535 ..... 147  | 50302 ..... 42      | 5231 ..... 111      | 538-1-5/8 ..... 240 |
| 45400R ..... 147   | 4JJ7540 ..... 147  | 5031 ..... 120      | 5232 ..... 111      | 5382 ..... 118      |
| 45450H ..... 147   | 4JJ7545 ..... 147  | 5033 ..... 120      | 5240 ..... 122      | 538-2-1/8 ..... 240 |
| 45450HU ..... 148  | 4JR0440 ..... 147  | 5035 ..... 120      | 5242 ..... 122      | 538-2-5/8 ..... 240 |
| 45450R ..... 147   | 4JR0520 ..... 147  | 5036 ..... 120      | 5246 ..... 119      | 5383 ..... 118      |
| 45500H ..... 147   | 4JR0525 ..... 147  | 5041 ..... 120      | 5252-3 ..... 20     | 538-3/4 ..... 240   |
| 45500HU ..... 148  | 4JR0525U ..... 148 | 5042 ..... 120      | 5255 ..... 119      | 538-3/8 ..... 240   |
| 45500R ..... 147   | 4JR0530 ..... 147  | 5046 ..... 120      | 525-MT1 ..... 184   | 538-3-1/8 ..... 240 |
| 4550-3 ..... 20    | 4JR0530U ..... 148 | 5053-3 ..... 20     | 525-PT1 ..... 184   | 538-3-5/8 ..... 240 |
| 45550H ..... 147   | 4JR0535 ..... 147  | 5056-3 ..... 20     | 525-TORCH ..... 184 | 5384 ..... 118      |
| 45550R ..... 147   | 4JR0535U ..... 148 | 5-05790 ..... 87    | 5-300020 ..... 190  | 538-4-1/8 ..... 240 |
| 4558-3 ..... 20    | 4JR0540 ..... 147  | 5058-3 ..... 20     | 5-300030 ..... 190  | 5385 ..... 118      |
| 45600H ..... 147   | 4JR0540U ..... 148 | 5070-3 ..... 20     | 530-30752 ..... 188 | 538-5/8 ..... 240   |
| 45600HU ..... 148  | 4JR0545 ..... 147  | 5-10 ..... 188      | 530-30753 ..... 188 | 538-7/8 ..... 240   |
| 45600R ..... 147   | 4JR0545U ..... 148 | 5-100020 ..... 190  | 530-30755 ..... 188 | 5-401 ..... 190     |
| 45700H ..... 147   | 4JR0550 ..... 147  | 5-100030 ..... 190  | 530-30756 ..... 188 | 5-401005 ..... 191  |
| 45700HU ..... 148  | 4JR0550U ..... 148 | 510-3400 ..... 193  | 530-30757 ..... 188 | 540-1005L..... 90   |
| 45700R ..... 147   | 4JR0555 ..... 147  | 510-3400-10 .193    | 530-30818 ..... 188 | 5-401007 ..... 191  |
| 45800H ..... 147   | 4JR0555U ..... 148 | 510-437338 ...190   | 530-30821 ..... 188 | 5-401010 ..... 191  |
| 45800HU ..... 148  | 4JR0560 ..... 147  | 510-438338 ...190   | 530-30834 ..... 188 | 5-401020 ..... 191  |
| 45800R ..... 147   | 4JR0560U ..... 148 | 5107 ..... 115      | 530-30850 ..... 188 | 5-401030 ..... 191  |
| 460-552 ..... 148  | 4JR0570 ..... 147  | 510-D102251 190     | 530-30863 ..... 188 | 5-402007 ..... 191  |
| 4700-12 ..... 186  | 4JR0580 ..... 147  | 510-D102338 .190    | 530-30876 ..... 188 | 540-2110C ..... 85  |
| 4700-34 ..... 186  | 4JR0580U ..... 148 | 510-D304020 .190    | 530-30884 ..... 188 | 540-2114 ..... 90   |
| 4701-12 ..... 186  | 4JR1055 ..... 147  | 510-D304030 .190    | 530-30885 ..... 188 | 540-2200 ..... 90   |
| 4701-34 ..... 186  | 4JR1060 ..... 147  | 510-D309020 .190    | 530-30890 ..... 188 | 540-25G ..... 176   |
| 4703-34 ..... 186  | 4JR1080 ..... 147  | 510-D309030 .190    | 530-30891 ..... 188 | 540-278BM0024       |
| 4704-12 ..... 186  | 4JR7525 ..... 147  | 510-D323020 .190    | 530-30893 ..... 188 | ..... 179           |
| 4704-34 ..... 186  | 4JR7530 ..... 147  | 510-D323030 .190    | 530-31132 ..... 188 | 540-278HX0002       |
| 4707-12 ..... 186  | 4JR7530U ..... 148 | 510-D441020 .190    | 530-31133 ..... 188 | ..... 179           |
| 47072-12 ..... 186 | 4JR7535 ..... 147  | 5-11830 ..... 39    | 5-32 ..... 188      | 5-404 ..... 190     |
| 47072-34 ..... 186 | 4JR7535U ..... 148 | 5-11840 ..... 39    | 5-321020 ..... 190  | 540-400 ..... 178   |
| 4707-34 ..... 186  | 4JR7540 ..... 147  | 5-11853 ..... 39    | 5-321030 ..... 190  | 5-405 ..... 190     |
| 4711-12 ..... 186  | 4JR7540U ..... 148 | 5-11866 ..... 39    | 5-33570 ..... 87    | 540-500 ..... 178   |
| 4711-34 ..... 186  | 4JR7545 ..... 147  | 5-11879 ..... 39    | 5-34790 ..... 87    | 540-506 ..... 176   |
| 4718-12 ..... 186  | 4JR7545U ..... 148 | 5-12 ..... 188      | 535-BB1 ..... 142   | 540-508 ..... 176   |
| 4766-3 ..... 20    | 4JR7550 ..... 147  | 5-14 ..... 188      | 535-BB2 ..... 142   | 540-509 ..... 176   |
| 4848-3 ..... 20    | 4JR7550U ..... 148 | 515-J2000 ..... 194 | 535-BB3 ..... 142   | 540-572 ..... 224   |
| 4JJ0525 ..... 147  | 4JR7555 ..... 147  | 515-J3000 ..... 194 | 535-BB4 ..... 142   | 540-573 ..... 224   |
| 4JJ0530 ..... 147  | 4JR7555U ..... 148 | 5200 ..... 117      | 535-BB6 ..... 142   | 5-406005 ..... 191  |

**PART NUMBER INDEX** cont'd

|                            |                           |                     |                               |                             |
|----------------------------|---------------------------|---------------------|-------------------------------|-----------------------------|
| 5-406007 ..... 191         | 540-RB414M .. 179         | 542-76220 ..... 170 | 5-500 ..... 90                | 5-SCR61-2DPBULK<br>..... 94 |
| 5-406010 ..... 191         | 540-RB418M .. 179         | 5-429005 ..... 192  | 5-520 ..... 193               | 5-SCR63-8 ..... 94          |
| 5-406020 ..... 191         | 540-RB424M .. 179         | 5-429007 ..... 192  | 5557-3 ..... 22               | 5-SCR63-8BULK.94            |
| 5-406030 ..... 191         | 540-RB610HDM<br>..... 179 | 5-429010 ..... 192  | 5-61 ..... 179                | 5-SCR71-2 ..... 94          |
| 540-648 ..... 148          | 540-RB614HDM<br>..... 179 | 5-429015 ..... 192  | 56-72 ..... 148               | 5-SCR71-2BULK.94            |
| 540-6510L ..... 180        | 540-RB618HDM<br>..... 179 | 5-429020 ..... 192  | 56-72220 ..... 148            | 5-SCR81 ..... 94            |
| 540-6510R ..... 180        | 540-RB618HDM<br>..... 179 | 5-429030 ..... 192  | 585-F336..... 161             | 5-SCR81-12-10094            |
| 540-6716B ..... 180        | 540-RB624HDM<br>..... 179 | 5-435005 ..... 192  | 585-TG ..... 161              | 5-SCR81-12BULK<br>..... 94  |
| 540-6716L ..... 180        | 540-RB636DW<br>..... 179  | 5-435007 ..... 192  | 585-TG1 ..... 161             | 5-SCR81-12W ... 94          |
| 540-6716R ..... 180        | 540-RB636W .. 179         | 5-435101 ..... 192  | 585-TG2 ..... 161             | 5-SCR81-12WTBUL<br>..... 94 |
| 540-6716S ..... 180        | 540-RB656WS 179           | 5-435102 ..... 192  | 585-TG3 ..... 161             | 5-SCR81-2 ..... 94          |
| 540-6900L ..... 180        | 540-RB810HDM<br>..... 179 | 5-436005 ..... 192  | 585-TG4 ..... 161             | 5-SCR81-25M ... 94          |
| 540-6900R ..... 180        | 540-RB814HDM<br>..... 179 | 5-436007 ..... 192  | 585-TG5 ..... 161             | 5-SCR81-2BULK.94            |
| 5-407 ..... 190            | 540-RB814HDM<br>..... 179 | 5-436010 ..... 192  | 585-TG6 ..... 161             | 5-SCR81-2DP ... 94          |
| 5-407005 ..... 191         | 540-RB956W .. 179         | 5-436020 ..... 192  | 585-TG7 ..... 161             | 5-SCR81-2DPBULK<br>..... 94 |
| 5-407007 ..... 191         | 540-T50M ..... 176        | 5-436030 ..... 192  | 585-TG8 ..... 161             | 5-SCR81-25M ... 94          |
| 5-407074 ..... 191         | 540-T50MOC .. 176         | 5-436074 ..... 193  | 585-TG9 ..... 161             | 5-SCR81-2BULK.94            |
| 5-407131 ..... 191         | 5-41 ..... 179            | 5-436101 ..... 193  | 590-708 ..... 148             | 5-SCR81-2DP<br>..... 94     |
| 5-407131 ..... 191         | 5-410 ..... 191           | 5-436102 ..... 193  | 5-HW5850 ..... 224            | 5-SCR81-2DPBULK<br>..... 94 |
| 540-799 ..... 89           | 5-410005 ..... 192        | 5-436131 ..... 193  | 5-IG5850 ..... 224            | 5-SCR81BULK.... 94          |
| 5-408 ..... 191            | 5-410007 ..... 192        | 5-437101 ..... 193  | 5-MSH1/4MC... 178             | 5-SCR81DP ..... 94          |
| 540-800 ..... 89           | 5-410010 ..... 192        | 5-437130 ..... 193  | 5-MSH5/16MC. 178              | 5-SCR81DPBULK<br>..... 94   |
| 540-805 ..... 89           | 5-41041 ..... 87          | 5-437131 ..... 193  | 5-SCR101 ..... 94             | 5-SCR81DPBULK<br>..... 94   |
| 540-806 ..... 89           | 5-411 ..... 191           | 5-437210 ..... 193  | 5-SCR101-12DP 94              | 5-SCR82 ..... 94            |
| 540-807 ..... 89           | 5-411 ..... 191           | 5-438101 ..... 193  | 5-SCR101-12DPBULK<br>..... 94 | 5-SCR82-100 ... 94          |
| 540-808 ..... 89           | 5-412 ..... 191           | 5-438131 ..... 193  | 5-SCR101-2BULK<br>..... 94    | 5-SCR82BULK ... 94          |
| 540-811B ..... 89          | 5-414 ..... 191           | 5-447007 ..... 192  | 5-SCR101-2DPBULK<br>..... 94  | 5-SCR82W ..... 94           |
| 5-409 ..... 191            | 5-41411 ..... 87          | 5-448007 ..... 193  | 5-SCR101-2DP .. 94            | 5-SCR83-4 ..... 94          |
| 5-409005 ..... 191         | 5-41455 ..... 87          | 5-449005 ..... 192  | 5-SCR101-2DPBULK<br>..... 94  | 5-SCR83-4BULK.94            |
| 5-409007 ..... 191         | 5-416 ..... 190           | 5-449007 ..... 192  | 5-SCR101-2DPBULK<br>..... 94  | 5-SCR83-4DP ... 94          |
| 5-409010 ..... 191         | 5-417 ..... 190           | 5-449030 ..... 192  | 5-SCR101BULK.. 94             | 5-SCR83-4DPBULK<br>..... 94 |
| 540-AK100..... 93          | 5-417005 ..... 191        | 5-450007 ..... 192  | 5-SCR101DP .... 94            | 5-SCR83-4DPBULK<br>..... 94 |
| 540-BH1L ..... 90          | 5-417007 ..... 191        | 545-420 ..... 172   | 5-SCR101DPBULK<br>..... 94    | 5-SCR-AK..... 93            |
| 540-CARABINER<br>..... 181 | 5-417010 ..... 191        | 545-422 ..... 172   | 5-SCR101DPBULK<br>..... 94    | 5-SCRMS..... 93             |
| 540-DB6 ..... 93           | 5-417012 ..... 191        | 545-424 ..... 172   | 5-SCR102DP .... 94            | 6000 ..... 118              |
| 540-DISP..... 85           | 5-417020 ..... 191        | 545-426 ..... 172   | 5-SCR102DPBULK<br>..... 94    | 6001 ..... 118              |
| 540-FCTMC5 .. 180          | 5-417030 ..... 191        | 545-430 ..... 172   | 5-SCR102DPBULK<br>..... 94    | 6002 ..... 118              |
| 540-FCTMN1 ... 180         | 5-418 ..... 190           | 545-440 ..... 172   | 5-SCR103-4 .... 94            | 6003 ..... 118              |
| 540-FCTMS1 .. 180          | 542-00968 ..... 170       | 545-442 ..... 172   | 5-SCR103-4BULK<br>..... 94    | 6004 ..... 118              |
| 540-FCTMS2 ... 180         | 542-25015 ..... 170       | 545-460 ..... 172   | 5-SCR103-4DP .94              | 6005 ..... 141              |
| 540-GUN..... 224           | 542-272 ..... 86          | 5-474007 ..... 193  | 5-SCR103-4DPBULK<br>..... 94  | 6006 ..... 118              |
| 540-HU1L..... 90           |                           | 548-001 ..... 183   | 5-SCR103-4DPBULK<br>..... 94  | 6007 ..... 118              |
| 540-LG1M..... 90           |                           | 548-003 ..... 184   | 5-SCR61-2DP ... 94            | 6010 ..... 141              |
| 540-R8CCRF ... 179         |                           | 548-005 ..... 184   |                               | 6011 ..... 118              |
| 540-RB125W .. 179          |                           | 548-007 ..... 184   |                               | 60205 ..... 105             |
|                            |                           | 548-009 ..... 184   |                               | 60205CX ..... 105           |

**PART NUMBER INDEX cont'd**

|                    |                     |                     |                    |                   |
|--------------------|---------------------|---------------------|--------------------|-------------------|
| 60206 ..... 105    | 61234LX ..... 102   | 620-18-2P ..... 162 | 620-601 ..... 156  | 6223 ..... 104    |
| 60210 ..... 104    | 61235LX ..... 102   | 620-18-3 ..... 162  | 620-604 ..... 156  | 6223LX ..... 104  |
| 60210CX ..... 104  | 6-12-4 ..... 142    | 620-18-3P ..... 162 | 620-605 ..... 156  | 6224 ..... 102    |
| 60210LX ..... 104  | 6-12-4NM ..... 142  | 620-18-4 ..... 162  | 620-608 ..... 154  | 6224CX ..... 102  |
| 60219 ..... 102    | 6-12-4NMP ..... 143 | 620-18-5 ..... 162  | 620-6081 ..... 154 | 6226 ..... 105    |
| 60220 ..... 102    | 6-12-4NMR ..... 143 | 620-18-6 ..... 162  | 620-6082 ..... 154 | 6226CX ..... 105  |
| 60220LX ..... 102  | 6-12-4NMSP ... 143  | 620-18-6P ..... 162 | 620-6083 ..... 154 | 6227 ..... 105    |
| 60247 ..... 105    | 6-12-4NMSWP 143     | 620-18-7 ..... 162  | 620-6-2 ..... 145  | 6227LX ..... 105  |
| 60251 ..... 102    | 61252 ..... 105     | 620-18-8 ..... 162  | 620-700 ..... 156  | 6228 ..... 105    |
| 60251CX ..... 102  | 61252NX ..... 105   | 620-18-8P ..... 162 | 620-701 ..... 156  | 6228LX ..... 105  |
| 60252CX ..... 105  | 61255 ..... 105     | 620-200 ..... 157   | 620-702 ..... 156  | 6229 ..... 102    |
| 60254 ..... 105    | 61255LX ..... 105   | 620-201 ..... 157   | 620-703 ..... 156  | 6229LX ..... 102  |
| 60254CX ..... 105  | 61256LX ..... 105   | 620-20-10 ..... 162 | 620-704 ..... 156  | 6230 ..... 104    |
| 60254LX ..... 105  | 6-12-6 ..... 142    | 620-20134 ..... 157 | 620-705 ..... 156  | 623-000 ..... 163 |
| 60256 ..... 105    | 6-12-6NM ..... 142  | 620-202 ..... 157   | 6207E ..... 141    | 623-001 ..... 163 |
| 60256CX ..... 105  | 6-12-6NM4SWP        | 620-20-2 ..... 162  | 6208 ..... 104     | 623-002 ..... 163 |
| 60259HX ..... 103  | ..... 143           | 620-20-3 ..... 162  | 620-8-2 ..... 145  | 623-003 ..... 163 |
| 60263BCX ..... 113 | 6-12-6NMP ..... 143 | 620-20-4 ..... 162  | 6208LX ..... 104   | 623-004 ..... 163 |
| 60263BLX ..... 113 | 6-12-6NMR ..... 143 | 620-20-5 ..... 162  | 6209 ..... 104     | 623-005 ..... 163 |
| 60263CX ..... 113  | 6-12-6NMSP ... 143  | 620-20-6 ..... 162  | 6209LX ..... 104   | 623-006 ..... 163 |
| 60264BCX ..... 113 | 6-12-6NMSWP 143     | 620-20-7 ..... 162  | 6210 ..... 104     | 623-007 ..... 163 |
| 60264CX ..... 113  | 6-12-6R ..... 143   | 620-20-8 ..... 162  | 6210E ..... 141    | 623-008 ..... 163 |
| 60265BLX ..... 113 | 6-12-8NMP ..... 143 | 6-202-1 ..... 92    | 6211 ..... 104     | 623-012 ..... 164 |
| 60265LX ..... 113  | 6-12-8NMSWP 143     | 6-202-2 ..... 92    | 6211CX ..... 104   | 623-013 ..... 164 |
| 60331B ..... 120   | 6182 ..... 124      | 620-252 ..... 157   | 6212 ..... 104     | 623-014 ..... 164 |
| 60331BE ..... 120  | 6183 ..... 124      | 620-253 ..... 157   | 6212CX ..... 104   | 6230CX ..... 104  |
| 60331R ..... 120   | 6-1838L ..... 79    | 620-254 ..... 157   | 6213 ..... 102     | 6231 ..... 104    |
| 6067-3 ..... 20    | 6-1838S ..... 79    | 620-255 ..... 157   | 6213CX ..... 102   | 6231CX ..... 104  |
| 6-1 ..... 80       | 6184 ..... 124      | 620-274W ..... 157  | 6214 ..... 102     | 6231LX ..... 104  |
| 6101 ..... 118     | 6-1846S ..... 79    | 620-300 ..... 156   | 6214CX ..... 102   | 6232 ..... 104    |
| 6102 ..... 118     | 6185 ..... 124      | 620-303 ..... 156   | 6215 ..... 105     | 6232CX ..... 104  |
| 6103E ..... 141    | 6186 ..... 124      | 620-304 ..... 156   | 6216 ..... 105     | 6232LX ..... 104  |
| 6105E ..... 141    | 6187 ..... 124      | 620-306 ..... 156   | 6216CX ..... 105   | 6233 ..... 102    |
| 6107E ..... 141    | 6193 ..... 124      | 6203E ..... 141     | 6216LX ..... 105   | 6233CX ..... 102  |
| 6108 ..... 116     | 6194 ..... 124      | 620-400 ..... 156   | 6217 ..... 104     | 6233LX ..... 102  |
| 6109 ..... 116     | 6195X ..... 124     | 620-401 ..... 156   | 6217CX ..... 104   | 6234 ..... 102    |
| 6110E ..... 141    | 6-2 ..... 80        | 620-403 ..... 156   | 6217LX ..... 104   | 6234LX ..... 102  |
| 6113 ..... 118     | 62000AX ..... 113   | 620-404 ..... 156   | 6218 ..... 102     | 6235 ..... 102    |
| 6-1200 ..... 39    | 6200BSX ..... 105   | 620-405 ..... 156   | 6218CX ..... 102   | 6235CX ..... 102  |
| 61202 ..... 105    | 6200HX ..... 103    | 620-406 ..... 156   | 6218LX ..... 102   | 6235LX ..... 102  |
| 61214 ..... 105    | 620-10-2 ..... 145  | 620-408 ..... 156   | 6219 ..... 102     | 6236LX ..... 105  |
| 61220 ..... 102    | 620-12-2 ..... 145  | 620-409 ..... 156   | 6219LX ..... 102   | 6237 ..... 105    |
| 61221CX ..... 102  | 620-14-2 ..... 145  | 620-411 ..... 156   | 6220 ..... 102     | 6237LX ..... 105  |
| 61221LX ..... 102  | 620-18-10 ..... 162 | 620-502 ..... 156   | 6220CX ..... 102   | 6238 ..... 105    |
| 61223LX ..... 102  | 620-18-12 ..... 162 | 6205E ..... 141     | 6222 ..... 104     | 6238LX ..... 105  |
| 61233LX ..... 103  | 620-18-2 ..... 162  | 620-600 ..... 156   | 6222LX ..... 104   | 6239 ..... 105    |

**PART NUMBER INDEX** *cont'd*

|                    |                    |                     |                    |                     |
|--------------------|--------------------|---------------------|--------------------|---------------------|
| 6239LX ..... 105   | 625-B1 ..... 158   | 6263BLX ..... 113   | 6281 ..... 102     | 6-321 ..... 183     |
| 623-MIX ..... 163  | 625-CR15W ... 156  | 6263BNX ..... 113   | 6281LX ..... 102   | 6322 ..... 119      |
| 6241 ..... 104     | 625-CR20W ... 156  | 6263CX ..... 113    | 6282 ..... 102     | 6-3263L ..... 79    |
| 6242 ..... 104     | 625-CS120W . 156   | 6263DX ..... 113    | 6282LX ..... 102   | 6-3263S ..... 79    |
| 6-2424L ..... 79   | 625-IS5 ..... 145  | 6263LX ..... 113    | 6283 ..... 103     | 6-330 ..... 82      |
| 6242LX ..... 104   | 625-S13 ..... 157  | 6263NX ..... 113    | 6283LX ..... 103   | 6330-4 ..... 121    |
| 6244 ..... 104     | 625-S14 ..... 157  | 6264BCX ..... 113   | 6285 ..... 103     | 6330-6 ..... 121    |
| 6244LX ..... 104   | 625-S15 ..... 157  | 6264BLX ..... 113   | 6285LX ..... 103   | 6331 ..... 121      |
| 6251 ..... 102     | 625-S16 ..... 157  | 6264BMX ..... 113   | 6286 ..... 103     | 6332B ..... 120     |
| 625-1301W ... 156  | 625-S17 ..... 157  | 6264CX ..... 113    | 6287 ..... 104     | 6332G ..... 120     |
| 625-16-6 ..... 158 | 625-S18 ..... 157  | 6264LX ..... 113    | 6287CX ..... 104   | 6332R ..... 120     |
| 625-16-690 ... 158 | 625-S19 ..... 157  | 6265BCX ..... 113   | 6287NX ..... 104   | 6332W ..... 120     |
| 625-183 ..... 145  | 625-S20 ..... 157  | 6265BLX ..... 113   | 6287XX ..... 104   | 6333B ..... 120     |
| 6251CX ..... 102   | 626-10S ..... 153  | 6266BLX ..... 113   | 6288 ..... 103     | 6333G ..... 120     |
| 6251LX ..... 102   | 626-10T ..... 153  | 626-6S ..... 153    | 6288LX ..... 103   | 6333R ..... 120     |
| 6252 ..... 105     | 626-15 ..... 153   | 6267MX ..... 113    | 6289 ..... 103     | 6333W ..... 120     |
| 625-2132B ... 157  | 626-15S ..... 153  | 6268BMX ..... 113   | 6289LX ..... 103   | 6334B ..... 120     |
| 625-2132V ... 157  | 626-15T ..... 153  | 6269 ..... 113      | 6291 ..... 125     | 6334G ..... 120     |
| 625-2132W ... 157  | 6261BCX ..... 113  | 6269CX ..... 113    | 6291CX ..... 125   | 6334R ..... 120     |
| 625-2134B ... 157  | 6261CX ..... 113   | 6269LX ..... 113    | 6292 ..... 125     | 6334W ..... 120     |
| 625-2134V ... 157  | 626-20 ..... 153   | 6269MX ..... 113    | 6292CX ..... 125   | 6335B ..... 120     |
| 625-2134W ... 157  | 626-20S ..... 153  | 626-AT0003 ... 154  | 6293 ..... 125     | 6335G ..... 120     |
| 625-270W ..... 156 | 626-20T ..... 153  | 626-AT0005 ... 154  | 6293CX ..... 125   | 6335R ..... 120     |
| 6252LX ..... 105   | 626-23133 ... 154  | 626-HASR10 .. 153   | 6294 ..... 125     | 6335W ..... 120     |
| 625-304 ..... 145  | 626-23233 ... 154  | 626-HASR15 .. 153   | 6294CX ..... 125   | 6336 ..... 121      |
| 625-305 ..... 145  | 626-23333 ... 154  | 626-HASR20 .. 153   | 6295X ..... 125    | 6337 ..... 121      |
| 6253CX ..... 105   | 626-25 ..... 153   | 626-HASR25 ... 153  | 6296 ..... 125     | 6338 ..... 121      |
| 6253LX ..... 105   | 626-25S ..... 153  | 626-HASR30 ... 153  | 6296CX ..... 125   | 6339 ..... 121      |
| 6255 ..... 105     | 626-25T ..... 153  | 626-HASR40 .. 153   | 6298 ..... 125     | 6339XL ..... 121    |
| 6255CX ..... 105   | 626-26311 .... 154 | 626-HASR60 ... 153  | 6298LX ..... 125   | 6340 ..... 121      |
| 6255LX ..... 105   | 6-2626L ..... 79   | 6270 ..... 103      | 6-3 ..... 80       | 6341 ..... 121      |
| 6257 ..... 105     | 6262BCX ..... 113  | 6270LX ..... 103    | 6301 ..... 141     | 6342 ..... 121      |
| 6257NX ..... 105   | 6262BLX ..... 113  | 6272 ..... 105      | 6303 ..... 141     | 6343 ..... 121      |
| 6258 ..... 103     | 6262BMX ..... 113  | 6-2739L ..... 79    | 6-3030L ..... 79   | 6-34-4 ..... 142    |
| 625-800 ..... 145  | 6262CX ..... 113   | 6274 ..... 105      | 6-3050L ..... 79   | 6-34-4NM ..... 142  |
| 625-801 ..... 145  | 6262LX ..... 113   | 6-2748L ..... 79    | 6-3050S ..... 79   | 6-34-4NMR ..... 143 |
| 625-810 ..... 145  | 6262MX ..... 113   | 6-2748L-100 .... 79 | 6-3060L ..... 79   | 6-34-4NMSP .. 143   |
| 625-811 ..... 145  | 626-30 ..... 153   | 6-2748S ..... 79    | 6-3060L-100 ... 79 | 6-34-4R ..... 143   |
| 6258CX ..... 103   | 626-30S ..... 153  | 6274LX ..... 105    | 6-3060S ..... 79   | 6-34-6 ..... 142    |
| 6259 ..... 103     | 626-30T ..... 153  | 6276 ..... 105      | 63070 ..... 124    | 6-34-6NM ..... 142  |
| 6259CX ..... 103   | 626-38071 .... 154 | 6-2763L ..... 79    | 63076B ..... 124   | 6-34-6NMR ..... 143 |
| 625-AF10 ..... 39  | 626-38073 .... 154 | 6-2763S ..... 79    | 63077B ..... 124   | 6-34-6NMSP ... 143  |
| 625-AF12 ..... 39  | 626-38632 .... 154 | 6276LX ..... 105    | 6310X ..... 119    | 6-34-6R ..... 142   |
| 625-AF14 ..... 39  | 626-38636 .... 154 | 6277 ..... 103      | 6311 ..... 119     | 6-34-8 ..... 142    |
| 625-AF6 ..... 39   | 6263BCX ..... 113  | 6277NX ..... 103    | 6312 ..... 119     | 6-34-8NM ..... 142  |
| 625-AF8 ..... 39   | 6263BDX ..... 113  | 6278CX ..... 124    | 6321 ..... 119     | 6360B ..... 120     |



**PART NUMBER INDEX cont'd**

|                    |                  |                    |                     |                     |
|--------------------|------------------|--------------------|---------------------|---------------------|
| 6360R ..... 120    | 6413 ..... 116   | 6644 ..... 116     | 6900AX..... 117     | 6-REF401 ..... 178  |
| 6360W ..... 120    | 6414 ..... 116   | 6645 ..... 116     | 6943CX ..... 117    | 6-ST600LED .... 182 |
| 6361B ..... 121    | 6415 ..... 116   | 6683 ..... 116     | 6945CX ..... 117    | 6-T1191 ..... 184   |
| 6361R ..... 121    | 6416 ..... 116   | 6685 ..... 116     | 6946CX ..... 117    | 6-T482..... 184     |
| 6362B ..... 121    | 650-001 ..... 40 | 6700AX..... 116    | 6953CX ..... 117    | 6-T744..... 179     |
| 6362R ..... 121    | 650-002 ..... 40 | 6701 ..... 116     | 6955CX ..... 117    | 701-001 ..... 186   |
| 6362W ..... 121    | 650-003 ..... 40 | 6702 ..... 116     | 6956CX ..... 117    | 701-002 ..... 186   |
| 6-3636L ..... 79   | 650-005 ..... 40 | 6703 ..... 116     | 6-CT700F..... 182   | 701-003 ..... 186   |
| 6363B ..... 121    | 650-006 ..... 40 | 6704 ..... 116     | 6-DMM20UL.... 176   | 701-006 ..... 186   |
| 6363R ..... 121    | 650-008 ..... 41 | 6704-2X ..... 116  | 6-FT80H ..... 183   | 701-007 ..... 186   |
| 6363W ..... 121    | 650-010 ..... 41 | 6706 ..... 116     | 6-FT80R ..... 183   | 701-008 ..... 186   |
| 6364B ..... 121    | 650-011 ..... 40 | 6706-2X ..... 116  | 6-GPK035 ..... 175  | 701-009 ..... 186   |
| 6364R ..... 121    | 650-012 ..... 40 | 6722 ..... 116     | 6-HAB-BG ..... 33   | 701-011 ..... 186   |
| 6364W ..... 121    | 650-013 ..... 40 | 6722-2X..... 116   | 6-HDT303K..... 183  | 701-012 ..... 186   |
| 6365B ..... 121    | 650-014 ..... 40 | 6724 ..... 116     | 6-HG15..... 175     | 701-013 ..... 186   |
| 6365R ..... 121    | 650-015 ..... 40 | 6724-2X..... 116   | 6-HK2748 ..... 80   | 701-014 ..... 186   |
| 6365W ..... 121    | 650-016 ..... 40 | 6730 ..... 116     | 6-HK2748-1 ..... 80 | 701-015 ..... 186   |
| 6-3660L ..... 79   | 650-017 ..... 40 | 6731 ..... 116     | 6-HK2748-SAM 250    | 701-017 ..... 186   |
| 6-3660S ..... 79   | 650-020 ..... 41 | 6732 ..... 116     | 6-HK2748-SAM        | 701-018 ..... 187   |
| 6370 ..... 124     | 650-021 ..... 40 | 6733 ..... 116     | ..... 251           | 701-019 ..... 187   |
| 6371 ..... 124     | 650-023 ..... 40 | 6-733 ..... 82     | 6-HK2766 ..... 80   | 701-020 ..... 187   |
| 6383-325 ..... 121 | 650-031 ..... 40 | 6-734 ..... 82     | 6-HK2766-1 ..... 80 | 701-023 ..... 187   |
| 6383-35 ..... 121  | 650-036 ..... 40 | 6735 ..... 116     | 6-HK3050 ..... 80   | 701-025 ..... 187   |
| 6384-325 ..... 121 | 650-038 ..... 40 | 6-735 ..... 82     | 6-HK3050-1 ..... 80 | 701-028 ..... 187   |
| 6384-35 ..... 121  | 650-074 ..... 40 | 6-736 ..... 82     | 6-HK3050HD .... 80  | 701-029 ..... 187   |
| 6-4 ..... 80       | 6500A ..... 115  | 675-P521U .... 161 | 6-HK3060 ..... 80   | 701-030 ..... 187   |
| 6401 ..... 116     | 6501 ..... 115   | 675-P621U .... 161 | 6-HK3060-1 ..... 80 | 701-031 ..... 187   |
| 640-122 ..... 145  | 650-100 ..... 39 | 675-P721UT ... 161 | 6-HK3060HD .... 80  | 701-032 ..... 187   |
| 640-142 ..... 145  | 6501CX ..... 115 | 675-P722U .... 161 | 6-HK3070HD .... 80  | 701-033 ..... 187   |
| 6402 ..... 116     | 6502 ..... 115   | 675-PSD010BF       | 6-HK3364FUR ... 80  | 701-034 ..... 187   |
| 6403 ..... 116     | 650-200 ..... 39 | ..... 161          | 6-HK3378FUR.... 80  | 701-035 ..... 187   |
| 6404 ..... 116     | 6503 ..... 115   | 675-PSD111 ... 161 | 6-M22..... 80       | 701-037 ..... 187   |
| 640-845 ..... 145  | 650-300 ..... 39 | 675-PSDH121 161    | 6-M24 ..... 80      | 701-038 ..... 187   |
| 640-AF2 ..... 42   | 6503CX ..... 115 | 675-PSM30SA 161    | 6-M26 ..... 80      | 701-039 ..... 187   |
| 640-AF25 ..... 42  | 6505 ..... 115   | 675-PSM40SA 161    | 6-M2748 ..... 80    | 701-040 ..... 187   |
| 640-AF3..... 42    | 6505LX..... 115  | 675-PSP722E.. 161  | 6-M2763 ..... 80    | 701-041 ..... 186   |
| 640-FD2B ..... 42  | 6526 ..... 115   | 6800HX ..... 117   | 6-M30..... 80       | 701-043 ..... 186   |
| 640-FD2S ..... 42  | 6528 ..... 115   | 6853 ..... 117     | 6-M3030 ..... 80    | 701-046 ..... 187   |
| 640-FD3S..... 42   | 6601 ..... 116   | 6855 ..... 117     | 6-M3030-SAM. 250    | 7033 ..... 115      |
| 640-FSK2 ..... 42  | 6602 ..... 116   | 6858 ..... 117     | 6-M3030-SAM 251     | 7034 ..... 115      |
| 640-FSK3..... 42   | 6603 ..... 116   | 6859 ..... 117     | 6-M3050 ..... 80    | 7036X ..... 115     |
| 640-UL25 ..... 42  | 6622 ..... 116   | 6865 ..... 117     | 6-M3060 ..... 80    | 7066X..... 115      |
| 640-UL3..... 42    | 6623 ..... 116   | 6866 ..... 117     | 6-M3263..... 80     | 708-850 ..... 148   |
| 6411 ..... 116     | 6641 ..... 116   | 6868 ..... 117     | 6-P3030L-SAM. 250   | 7-10 ..... 81       |
| 641-14 ..... 222   | 6642 ..... 116   | 6876 ..... 117     | 6-P3030L-SAM. 251   | 7-100 ..... 92      |
| 6412 ..... 116     | 6643 ..... 116   | 6878 ..... 117     | 6-R50A..... 39      | 710-001 ..... 41    |

**PART NUMBER INDEX** cont'd

|                    |                    |                     |                     |                     |
|--------------------|--------------------|---------------------|---------------------|---------------------|
| 710-002 ..... 41   | 7-14B ..... 81     | 7-4000 ..... 92     | 750-RC841 .... 145  | 7-80633 ..... 91    |
| 710-003 ..... 41   | 7-14P ..... 81     | 7-4001 ..... 92     | 750-RC842 .... 145  | 7-918 ..... 85      |
| 710-004 ..... 41   | 7-200 ..... 92     | 7-4100 ..... 92     | 750-SLTC50 .... 144 | 7-944 ..... 85      |
| 710-005 ..... 41   | 7233RLX ..... 108  | 7-4100 ..... 92     | 750-SLTC7 ..... 144 | 799-001 ..... 89    |
| 7-100W ..... 172   | 7234RLX ..... 108  | 741-001 ..... 88    | 750-SLTC9050 144    | 799-002 ..... 89    |
| 710-100 ..... 42   | 7235RLX ..... 108  | 741-002 ..... 88    | 750-SLTC9075 144    | 799-003 ..... 89    |
| 710-101 ..... 42   | 7236RLX ..... 108  | 741-003 ..... 88    | 750-TZNMLT100       | 799-004 ..... 89    |
| 710-102 ..... 42   | 72-88220 ..... 148 | 7-4101 ..... 92     | ..... 144           | 799-005 ..... 89    |
| 710-103 ..... 42   | 72-88330 ..... 149 | 7-4200 ..... 92     | 750-TZNMLT125       | 799-006 ..... 89    |
| 710-182G ..... 41  | 7301 ..... 108     | 7-4400 ..... 93     | ..... 144           | 799-009 ..... 89    |
| 710-185G ..... 41  | 7-301K ..... 173   | 7-4500 ..... 93     | 750-TZNMLT150       | 799-010 ..... 89    |
| 7-1058 ..... 247   | 7302 ..... 108     | 750-10100 .... 144  | ..... 144           | 799-011 ..... 89    |
| 7-1078 ..... 247   | 7303 ..... 108     | 750-10500 .... 144  | 750-TZNMLT200       | 799-012 ..... 89    |
| 710-A16100 .... 41 | 7311L ..... 108    | 750-12100 .... 144  | ..... 144           | 799-013 ..... 89    |
| 710-A1650 ..... 41 | 7-316 ..... 81     | 750-121000 .. 144   | 750-TZNMLT38.144    | 799-021 ..... 89    |
| 710-A1710 ..... 41 | 7-316 ..... 81     | 750-125100 .. 144   | 750-TZNMLT50        | 799-022 ..... 89    |
| 7-10KOTN100 153    | 7316L ..... 108    | 750-1550 ..... 144  | ..... 144           | 799-024 ..... 89    |
| 7-10KOTN30... 153  | 7316X ..... 108    | 750-2050 ..... 144  | 750-TZNMLT75.144    | 799-025 ..... 89    |
| 7-10KOTN35 .. 153  | 7317L ..... 108    | 750-34100 .... 144  | 750-TZNMLT90100     | 799-040 ..... 89    |
| 7-10KOTN40 .. 153  | 7317X ..... 108    | 750-34800 .... 144  | ..... 144           | 799-041 ..... 89    |
| 7-10KOTN45... 153  | 7321X ..... 108    | 750-38100 .... 144  | 750-TZNMLT90125     | 7-AD010000 ... 172  |
| 7-10KOTN50 .. 153  | 7-34 ..... 81      | 750-401 ..... 194   | ..... 144           | 7-AL9V ..... 85     |
| 7-10KOTN60... 153  | 7-341-18 ..... 247 | 750-402 ..... 194   | 750-TZNMLT90150     | 7-AL9V-8 ..... 85   |
| 7-10KOTN70 .. 153  | 7-3412 ..... 247   | 750-500 ..... 144   | ..... 144           | 7-ALAA ..... 85     |
| 7-10KOTN80 .. 153  | 7-341-58 ..... 247 | 750-600 ..... 144   | 750-TZNMLT90200     | 7-ALAA-24 ..... 85  |
| 7-10KOTN90 .. 153  | 7-342-18 ..... 247 | 750-MLT50..... 144  | ..... 144           | 7-ALAAA ..... 85    |
| 7-10P ..... 81     | 7-342-58 ..... 247 | 750-MLT75..... 144  | 750-TZNMLT9038      | 7-ALAAA-18 ..... 85 |
| 710-P100 ..... 42  | 7-3434 ..... 247   | 750-MLT9050.. 144   | ..... 144           | 7-ALC ..... 85      |
| 7-12 ..... 81      | 7-3438 ..... 247   | 750-MLT9075.. 144   | 750-TZNMLT9050      | 7-ALC-12 ..... 85   |
| 7-121-18 ..... 247 | 7-3458 ..... 247   | 750-NMLT100. 144    | ..... 144           | 7-ALD ..... 85      |
| 7-1212 ..... 247   | 7-3478 ..... 247   | 750-NMLT125. 144    | 750-TZNMLT9075      | 7-ALD-12 ..... 85   |
| 7-121-38 ..... 247 | 7-34B ..... 81     | 750-NMLT4550. 144   | ..... 144           | 7-CRNR100 ..... 153 |
| 7-121-58 ..... 247 | 7-34P ..... 81     | 750-NMLT4575. 144   | 7-58 ..... 81       | 7-CRNR15 ..... 153  |
| 7-122-18 ..... 247 | 7-38 ..... 81      | 750-NMLT50 ... 144  | 7-5811 ..... 164    | 7-CRNR20 ..... 153  |
| 7-122-58 ..... 247 | 7-381-18 ..... 247 | 750-NMLT5090-F      | 7-5811-B ..... 164  | 7-CRNR25 ..... 153  |
| 7-123-18 ..... 247 | 7-3812 ..... 247   | ..... 144           | 7-58B ..... 81      | 7-CRNR30 ..... 153  |
| 7-1234 ..... 247   | 7-381-38 ..... 247 | 750-NMLT75 ... 144  | 7-58P ..... 81      | 7-CRNR35 ..... 153  |
| 7-1238 ..... 247   | 7-381-58 ..... 247 | 750-NMLT7590-F      | 770-15 ..... 84     | 7-CRNR40 ..... 153  |
| 7-1258 ..... 247   | 7-382-18 ..... 247 | ..... 144           | 7-711 ..... 164     | 7-CRNR45 ..... 153  |
| 7-1278 ..... 247   | 7-382-58 ..... 247 | 750-NMLT90100       | 7-711-B ..... 164   | 7-CRNR50 ..... 153  |
| 7-12B ..... 81     | 7-3834 ..... 247   | ..... 144           | 7-75W ..... 172     | 7-CRNR60 ..... 153  |
| 7-12P ..... 81     | 7-3838 ..... 247   | 750-NMLT90125       | 7-78 ..... 81       | 7-CRNR70 ..... 153  |
| 7-14 ..... 81      | 7-3858 ..... 247   | ..... 144           | 7-78P ..... 81      | 7-CRNR80 ..... 153  |
| 7142 ..... 108     | 7-3878 ..... 247   | 750-NMLT9050. 144   | 7-80045 ..... 92    | 7-CRNR90 ..... 153  |
| 7142LX ..... 108   | 7-38B ..... 81     | 750-NMLT9075. 144   | 7-806 ..... 85      | 7-CVMINITUBE .. 81  |
| 7146 ..... 108     | 7-38P ..... 81     | 750-P60NF ..... 143 | 7-80632 ..... 91    | 7-ECC12100 .. 172   |

**PART NUMBER INDEX cont'd**

|                     |                     |                    |                    |                   |
|---------------------|---------------------|--------------------|--------------------|-------------------|
| 7-ECC1225 .... 172  | 88-108220 .... 148  | ACP36483 ..... 22  | B-24H ..... 194    | B-926 ..... 170   |
| 7-ECC1250 .... 172  | 88-108330 .... 149  | ACP38422 ..... 22  | B-26..... 171      | B-927 ..... 170   |
| 7-ECC16100 .. 172   | 89DC..... 226       | ACR-1..... 30      | B-27..... 169      | B-928 ..... 170   |
| 7-ECC1625 .... 172  | 8-FWH16..... 94     | ACT-6 ..... 176    | B-28H ..... 194    | B-929 ..... 170   |
| 7-ECC1650 ..... 172 | 8-WH16 ..... 94     | ADB-1 ..... 154    | B-304 ..... 171    | B-930 ..... 170   |
| 7-ECC50725 .. 172   | 900-3 ..... 49      | ADB-2 ..... 154    | B-307 ..... 171    | B-931 ..... 170   |
| 7-ECC50730 ... 172  | 900-4 ..... 49      | ADM-1..... 154     | B-316 ..... 171    | B-932 ..... 170   |
| 7-ECC50735 ... 172  | 900-5 ..... 49      | ADM-2..... 154     | B-319 ..... 171    | B-934 ..... 170   |
| 7-L300..... 41      | 900-6 ..... 49      | AER-8 ..... 30     | B-322 ..... 171    | B-935 ..... 170   |
| 7-L300..... 164     | 91-2032 ..... 51    | AER-8BL ..... 30   | B-328 ..... 171    | B-996 ..... 170   |
| 7-P24 ..... 41      | 91-3042 ..... 51    | AG-25 ..... 92     | B-32H ..... 194    | B-998 ..... 170   |
| 7-P24 ..... 164     | 92-3232 ..... 51    | ALK150-01 .... 228 | B-333 ..... 171    | BE-24..... 171    |
| 7-P36 ..... 41      | 92-4242 ..... 51    | ALK150-05 .... 228 | B-36H ..... 194    | BE-36..... 171    |
| 7-P36 ..... 164     | 940 ..... 226       | ALK200-01 .... 228 | B-4..... 169       | BE-48..... 171    |
| 7-P36B ..... 41     | 9410SSR..... 226    | ALK300-01 .... 228 | B-428 ..... 171    | BH-1 ..... 171    |
| 7-P36B ..... 164    | 944KIT ..... 226    | AP-DD ..... 79     | B-433 ..... 171    | BNT-1 ..... 225   |
| 7-P48..... 41       | 947KIT ..... 226    | AP-DK..... 79      | B-4H ..... 194     | BNT-32..... 225   |
| 7-P48 ..... 164     | 948KIT ..... 226    | AT-1700 ..... 158  | B-501 ..... 169    | BP-46..... 76     |
| 7-P48B ..... 41     | 971KIT ..... 226    | ATK-1 ..... 229    | B-502 ..... 169    | BP-46-230..... 76 |
| 7-P48B ..... 164    | 9721 ..... 141      | ATK-1P..... 229    | B-503 ..... 169    | BPF-01 ..... 52   |
| 7-SE4W3C .... 173   | 972KIT ..... 226    | ATK-4 ..... 229    | B-504 ..... 169    | BPF-02 ..... 52   |
| 7-SPHW3AAA-BX       | 973KIT ..... 230    | AW-712..... 169    | B-505 ..... 169    | BPF-03 ..... 52   |
| ..... 173           | 980 ..... 225       | AW-712-10 .... 169 | B-604 ..... 171    | BPF-04 ..... 52   |
| 7-TLC10625 ... 172  | 98084KIT ..... 225  | AW-712-8 ..... 169 | B-610 ..... 171    | BPF-05 ..... 52   |
| 7-TLC10630.... 172  | 98087KIT ..... 225  | AW-8..... 169      | B6-12-4 ..... 142  | BPF-06 ..... 52   |
| 800-008 ..... 93    | 981 ..... 223       | AW-9..... 169      | B6-12-4NM .... 142 | BPF-07 ..... 52   |
| 800-009 ..... 93    | 983KIT ..... 226    | AW-96..... 169     | B6-12-6 ..... 142  | BPF-08 ..... 52   |
| 8200M ..... 119     | 984 ..... 226       | AW-96-10 ..... 169 | B6-12-6NM .... 142 | BPF-09 ..... 52   |
| 8201 ..... 119      | 985 ..... 226       | AW-96-8..... 169   | B-616 ..... 171    | BPF-10 ..... 52   |
| 8201C ..... 119     | A60306K..... 142    | B-1 ..... 169      | B-622 ..... 171    | BPF-11 ..... 52   |
| 8202 ..... 119      | ACB-30 ..... 32     | B-10..... 171      | B-628 ..... 171    | BPF-12 ..... 52   |
| 8203 ..... 119      | ACB-36 ..... 32     | B-10H ..... 194    | B-633 ..... 171    | BPF-13 ..... 52   |
| 8203C..... 119      | ACB-42 ..... 32     | B-124 ..... 170    | B6-34-4NM .... 142 | BPF-14 ..... 52   |
| 8207 ..... 119      | ACB-48..... 32      | B-125 ..... 170    | B6-34-6 ..... 142  | BPF-16 ..... 52   |
| 8208 ..... 119      | ACID-ELIM ..... 230 | B-126 ..... 170    | B6-34-6NM .... 142 | BPF-17 ..... 52   |
| 8220M..... 119      | ACK4 ..... 181      | B-127 ..... 170    | B-6H ..... 194     | BPF-18 ..... 52   |
| 8233 ..... 119      | ACP-10..... 84      | B-128 ..... 170    | B-704 ..... 171    | BPF-20 ..... 52   |
| 8282LX ..... 125    | ACP24242 ..... 22   | B-129 ..... 170    | B-716 ..... 171    | BPF-21 ..... 52   |
| 8284 ..... 125      | ACP24243 ..... 22   | B-12H ..... 194    | B-722 ..... 171    | BPF-22 ..... 52   |
| 8284CX ..... 125    | ACP24362 ..... 22   | B-131 ..... 170    | B-733 ..... 171    | BPF-23 ..... 52   |
| 8286 ..... 125      | ACP30302 ..... 22   | B-132 ..... 170    | B-802 ..... 171    | BPF-25 ..... 53   |
| 8286CX ..... 125    | ACP30303 ..... 22   | B-16H ..... 194    | B-807 ..... 171    | BPF-26 ..... 53   |
| 829-995 ..... 148   | ACP32322 ..... 22   | B-2..... 169       | B-816 ..... 171    | BPF-27 ..... 53   |
| 84DCPLUS..... 225   | ACP32323 ..... 22   | B-20H ..... 194    | B-8H ..... 194     | BPF-28 ..... 53   |
| 87DCPLUS..... 226   | ACP36362 ..... 22   | B-210 ..... 171    | B-924 ..... 170    | BPF-29 ..... 53   |
| 88-108 ..... 148    | ACP36363 ..... 22   | B-216 ..... 171    | B-925 ..... 170    | BPF-31 ..... 53   |

## PART NUMBER INDEX cont'd

|                 |                    |                    |                    |                    |
|-----------------|--------------------|--------------------|--------------------|--------------------|
| BPF-32 ..... 53 | BPN-52 ..... 51    | C165-0058 .... 234 | C242-0390 .... 234 | C460-0295 .... 235 |
| BPF-33 ..... 53 | BPN-53 ..... 51    | C165-0090 .... 234 | C243 ..... 164     | C460-0305 .... 235 |
| BPF-34 ..... 52 | BPN-54 ..... 51    | C165-0093 .... 234 | C245 ..... 164     | C460-0390 .... 235 |
| BPN-1 ..... 51  | BPN-6 ..... 51     | C165-0094 .... 234 | C247 ..... 164     | C460-0414 .... 235 |
| BPN-10 ..... 51 | BPN-7 ..... 51     | C165-0100 .... 234 | C2-5 ..... 168     | C460-0429 .... 235 |
| BPN-11 ..... 51 | BPN-8 ..... 51     | C165-0107 .... 234 | C254-0002 .... 233 | C460-0432 .... 235 |
| BPN-12 ..... 51 | BPN-9 ..... 51     | C165-0149 .... 234 | C254-0100 .... 233 | C5 ..... 168       |
| BPN-13 ..... 51 | BPN-A12 ..... 51   | C165-0150 .... 234 | C254-0150 .... 233 | C512 ..... 164     |
| BPN-14 ..... 51 | BPN-A34 ..... 51   | C165-0159 .... 234 | C2-5S ..... 168    | C512L ..... 164    |
| BPN-15 ..... 51 | BR115 ..... 157    | C165-0215 .... 234 | C272-0002 .... 233 | C533-0050 .... 235 |
| BPN-16 ..... 51 | BR120 ..... 157    | C165-0222 .... 234 | C272-0025 .... 233 | C533-0150 .... 235 |
| BPN-17 ..... 51 | BR130 ..... 157    | C165-0223 .... 234 | C272-0050 .... 233 | C657-0100 .... 234 |
| BPN-18 ..... 51 | BR140 ..... 157    | C165-0295 .... 234 | C272-0090 .... 233 | C947-0025 .... 235 |
| BPN-19 ..... 51 | BR150 ..... 157    | C165-0304 .... 234 | C272-0100 .... 233 | C947-0050 .... 235 |
| BPN-2 ..... 51  | BR2100 ..... 157   | C165-0305 .... 234 | C272-0150 .... 233 | C947-0100 .... 235 |
| BPN-20 ..... 51 | BR215 ..... 157    | C165-0390 .... 234 | C272-0215 .... 233 | C947-0150 .... 235 |
| BPN-21 ..... 51 | BR220 ..... 157    | C165-0399 .... 234 | C290-0002 .... 233 | C947-0215 .... 235 |
| BPN-22 ..... 51 | BR230 ..... 157    | C165-1498 .... 234 | C290-0025 .... 233 | C947-0295 .... 235 |
| BPN-23 ..... 51 | BR240 ..... 157    | C170-0003 .... 235 | C290-0050 .... 233 | C947-0390 .... 235 |
| BPN-24 ..... 51 | BR250 ..... 157    | C172-0090 .... 235 | C290-0090 .... 233 | CA-252C ..... 168  |
| BPN-25 ..... 51 | BR260 ..... 157    | C172-0100 .... 235 | C290-0100 .... 233 | CAS-2712 ..... 91  |
| BPN-26 ..... 51 | BR270 ..... 157    | C172-0150 .... 235 | C290-0150 .... 233 | CB-03 ..... 79     |
| BPN-28 ..... 51 | BS-16 ..... 224    | C172-0215 .... 235 | C290-0215 .... 233 | CB-2 ..... 78      |
| BPN-29 ..... 51 | BS-25 ..... 79     | C20 ..... 168      | C290-0390 .... 233 | CC-1 ..... 77      |
| BPN-3 ..... 51  | BS-32 ..... 224    | C20-D ..... 168    | C295-0002 .... 234 | CC33 ..... 159     |
| BPN-30 ..... 51 | C10 ..... 168      | C222 ..... 164     | C295-0090 .... 234 | CC33-18 ..... 159  |
| BPN-31 ..... 51 | C101-0050 .... 233 | C222C ..... 164    | C295-0100 .... 234 | CC33-24 ..... 159  |
| BPN-32 ..... 51 | C101-0100 .... 233 | C223 ..... 164     | C295-0150 .... 234 | CCP-L ..... 172    |
| BPN-33 ..... 51 | C101-0150 .... 233 | C223C ..... 164    | C312 ..... 164     | CCP-M ..... 172    |
| BPN-34 ..... 51 | C101-0222 .... 233 | C235-0002 .... 233 | C312L ..... 164    | CG-AER ..... 221   |
| BPN-35 ..... 51 | C105-0057 .... 233 | C235-0025 .... 233 | C410-0032 .... 234 | CGB-AER ..... 221  |
| BPN-37 ..... 51 | C105-0100 .... 233 | C235-0050 .... 233 | C410-0058 .... 234 | CH115 ..... 157    |
| BPN-38 ..... 51 | C105-0150 .... 233 | C235-0090 .... 233 | C410-0093 .... 234 | CH120 ..... 157    |
| BPN-39 ..... 51 | C105-0215 .... 233 | C235-0100 .... 233 | C410-0107 .... 234 | CH215 ..... 157    |
| BPN-4 ..... 51  | C114-0215 .... 233 | C235-0150 .... 233 | C410-0149 .... 234 | CH220 ..... 157    |
| BPN-40 ..... 51 | C1-2-6 ..... 168   | C235-0215 .... 233 | C410-0159 .... 234 | CH230 ..... 157    |
| BPN-41 ..... 51 | C142-0058 .... 235 | C241 ..... 164     | C410-0222 .... 234 | CH240 ..... 157    |
| BPN-43 ..... 51 | C154-0002 .... 234 | C242-0001 .... 234 | C410-0306 .... 234 | CH250 ..... 157    |
| BPN-44 ..... 51 | C154-0090 .... 234 | C242-0002 .... 234 | C460-0002 .... 235 | CH260 ..... 157    |
| BPN-45 ..... 51 | C154-0100 .... 234 | C242-0025 .... 234 | C460-0025 .... 235 | CK-141 ..... 79    |
| BPN-46 ..... 51 | C165-0001 .... 234 | C242-0050 .... 234 | C460-0050 .... 235 | CLL-1 ..... 230    |
| BPN-47 ..... 51 | C165-0002 .... 234 | C242-0090 .... 234 | C460-0090 .... 235 | CLL-4 ..... 230    |
| BPN-48 ..... 51 | C165-0007 .... 234 | C242-0100 .... 234 | C460-0100 .... 235 | CM-1000 ..... 49   |
| BPN-5 ..... 51  | C165-0025 .... 234 | C242-0150 .... 234 | C460-0150 .... 235 | CO-1 ..... 88      |
| BPN-50 ..... 51 | C165-0032 .... 234 | C242-0215 .... 234 | C460-0215 .... 235 | COOLWELD-32.221    |
| BPN-51 ..... 51 | C165-0050 .... 234 | C242-0295 .... 234 | C460-0222 .... 235 | CP-16 ..... 76     |



**PART NUMBER INDEX cont'd**

|                    |                         |                         |                     |                    |
|--------------------|-------------------------|-------------------------|---------------------|--------------------|
| CP-16-230 ..... 76 | CVENT-4 ..... 49        | D40880500B3B6 ..... 243 | D61420350 ... 243   | D90-293Q..... 152  |
| CP-22 ..... 76     | CVENTCAP2 ..... 49      | ..... 243               | D61420400 ... 243   | D90-294Q ..... 152 |
| CP-22-230 ..... 76 | CVENTCAP3 ..... 49      | D41020250B3B6 ..... 243 | D61420500 ... 243   | D90-295Q..... 152  |
| CP-22-230T..... 76 | CVENTCAP4 ..... 49      | ..... 243               | D61430250 ... 243   | D-90340 ..... 152  |
| CP-22LP ..... 76   | CVMINI..... 76          | D41020350B3B6 ..... 243 | D61430300.... 243   | D-90341 ..... 152  |
| CP-22LP-230.... 76 | CV-PTRAP ..... 78       | ..... 243               | D61430350 ... 243   | D-90342 ..... 152  |
| CP-22T ..... 76    | CV-RTRAP ..... 78       | D41020500B3B6 ..... 243 | D61430400 ... 243   | D90-360 ..... 152  |
| CP-CV ..... 76     | CVS-2 ..... 49          | ..... 243               | D61430500.... 243   | D90-370 ..... 152  |
| CP-M115 ..... 77   | CVS-3 ..... 49          | D41080250B3B6 ..... 243 | D61480250 ... 243   | D90-372 ..... 152  |
| CP-M230..... 77    | CV-TUBE ..... 78        | ..... 243               | D61480300 ... 243   | D90-380 ..... 152  |
| CP-MINI-L..... 77  | CW-15 ..... 79          | D41080350B3B6 ..... 243 | D61480350 ... 243   | D90-382 ..... 152  |
| CPN1 ..... 164     | CW-30 ..... 168         | ..... 243               | D61480400 ... 243   | D90-384 ..... 152  |
| CPN1C ..... 164    | D20-3132-18 ... 50      | D41080500B3B6 ..... 243 | D61480500 ... 243   | DAD032 ..... 241   |
| CPN2 ..... 164     | D20-3132-24 ... 50      | ..... 243               | D61820250 ... 243   | DAD032S ..... 241  |
| CPN2C ..... 164    | D20-3132-36 ... 50      | D60A-10 ..... 238       | D61820500.... 243   | DAD052 ..... 241   |
| CPN2M ..... 164    | D20-3132-48 ... 50      | D60A-4 ..... 238        | D61830250 ... 243   | DAD052S ..... 241  |
| CPN3 ..... 164     | D30-3131-24 ... 50      | D60A-8 ..... 238        | D61830300 ... 243   | DAD053S ..... 241  |
| CPN3C ..... 164    | D30-3131-36 ... 50      | D61020250B3B6 ..... 243 | D61830350 ... 243   | DAD082 ..... 241   |
| CRO70 ..... 180    | D30-3131-48 ... 50      | ..... 243               | D61830400.... 243   | DAD082S ..... 241  |
| CR-1 ..... 88      | D30-3132-18 ... 50      | D61020350B3B6 ..... 243 | D61830500 ... 243   | DAD083S ..... 241  |
| CRC-1 ..... 88     | D30-3132-24 ... 50      | ..... 243               | D61880250 ... 243   | DAD084S ..... 241  |
| CRC-13 ..... 88    | D30-3132-36 ... 50      | D61020500B3B6 ..... 243 | D61880300.... 243   | DAD163 ..... 241   |
| CRC-1KB ..... 87   | D30-3132-48 ... 50      | ..... 243               | D61880350.... 243   | DAD163S ..... 241  |
| CRC-2 ..... 88     | D40620250B3B6 ..... 243 | D61080250B3B6 ..... 243 | D61880400.... 243   | DAD164S ..... 241  |
| CRC-3 ..... 88     | ..... 243               | ..... 243               | D61880500.... 243   | DAD303 ..... 241   |
| CRC-4-140 ..... 85 | D40620350B3B6 ..... 243 | D61080350B3B6 ..... 243 | D61A-4 ..... 238    | DAD303S ..... 241  |
| CRC-4CF ..... 85   | ..... 243               | ..... 243               | D61A-8 ..... 238    | DAD304S ..... 241  |
| CRC-4NU..... 86    | D40620500B3B6 ..... 243 | D61080500B3B6 ..... 243 | D62A-1010 ..... 238 | DAD305 ..... 241   |
| CRC-5 ..... 88     | ..... 243               | ..... 243               | D62A-44 ..... 238   | DAD305S ..... 241  |
| CRC-5BC ..... 88   | D40680250B3B6 ..... 243 | D61220250 ... 243       | D62A-66 ..... 238   | DBF083 ..... 242   |
| CRC-6 ..... 88     | ..... 243               | D61220300 ... 243       | D62A-88 ..... 238   | DBF083S ..... 242  |
| CRC-7-140 ..... 86 | D40680350B3B6 ..... 243 | D61220350 ... 243       | D64A-1010 ..... 238 | DBF084..... 242    |
| CRC-7PS ..... 86   | ..... 243               | D61220400 ... 243       | D64A-44 ..... 238   | DBF084S ..... 242  |
| CRC-7X ..... 86    | D40680500B3B6 ..... 243 | D61220500 ... 243       | D64A-66 ..... 238   | DBF163..... 242    |
| CRC-7Z ..... 86    | ..... 243               | D61230250 ... 243       | D64A-88 ..... 238   | DBF163S ..... 242  |
| CRC-8 ..... 87     | D40820250B3B6 ..... 243 | D61230300 ... 243       | D68A-4B ..... 238   | DBF164S..... 242   |
| CRC-9 ..... 88     | ..... 243               | D61230350 ... 243       | D68A-6C ..... 238   | DBF165S..... 242   |
| CRC-CF2 ..... 88   | D40820350B3B6 ..... 243 | D61230400 ... 243       | D68A-6D ..... 238   | DC30-3132-18 .50   |
| CS-1 ..... 77      | ..... 243               | D61230500.... 243       | D68A-8D ..... 238   | DC30-3132-24.. 50  |
| CS1200 ..... 77    | D40820500B3B6 ..... 243 | D61280250 ... 243       | D69A-4A ..... 238   | DC30-3132-36 .50   |
| CS-2 ..... 77      | ..... 243               | D61280300 ... 243       | D69A-8D ..... 238   | DC30-3132-48.. 50  |
| CS-3 ..... 77      | D40880250B3B6 ..... 243 | D61280350 ... 243       | D-90113 ..... 152   | DC-4128 ..... 86   |
| CT-475M ..... 168  | ..... 243               | D61280400 ... 243       | D-90118 ..... 152   | DC-9128 ..... 86   |
| CT800..... 181     | D40880350B3B6 ..... 243 | D61280500 ... 243       | D90-290Q..... 152   | DDS-30 ..... 143   |
| CVENT-2 ..... 49   | ..... 243               | D61420250 ... 243       | D90-291Q ..... 152  | DDS-60 ..... 143   |
| CVENT-3 ..... 49   |                         | D61420300.... 243       | D90-292Q ..... 152  | DDS-60U ..... 143  |

**PART NUMBER INDEX** cont'd

|                    |                    |                            |                         |                    |
|--------------------|--------------------|----------------------------|-------------------------|--------------------|
| DE1-10D ..... 238  | DPE252240 ... 150  | DPEAUX10 ..... 151         | DSP-1 ..... 155         | DX-3 ..... 241     |
| DE1-12E ..... 238  | DPE253120 .... 150 | DPEAUX11 ..... 151         | DSS-SLD306SV ..... 241  | DX-4 ..... 241     |
| DE13 ..... 115     | DPE25324 ..... 150 | DPEAUX11QC . 151           | DSS-SLD307SV. 241       | DXA-5..... 241     |
| DE14 ..... 115     | DPE253240 ... 150  | DPEAUX20..... 151          | DST-5..... 149          | E-10 ..... 177     |
| DE1-4B ..... 238   | DPE301120 .... 150 | DPEAUX22..... 151          | DST-6..... 149          | E-5 ..... 177      |
| DE15 ..... 115     | DPE30124 ..... 150 | DPR063 ..... 152           | DT2-10..... 239         | E-6 ..... 177      |
| DE1-6B ..... 238   | DPE301240 .... 150 | DPR064 ..... 152           | DT2-4 ..... 239         | E-8..... 177       |
| DE1-6C ..... 238   | DPE302120 .... 150 | DPR066 ..... 152           | DT2-6 ..... 239         | EB-10 ..... 177    |
| DE1-6D ..... 238   | DPE30224 ..... 150 | DPSG-2 ..... 242           | DT2-8 ..... 239         | EB-8 ..... 177     |
| DE1-8D ..... 238   | DPE302240 ... 150  | DPSG-2MF ..... 242         | DTK113 ..... 78         | EC-1 ..... 41      |
| DE1-8E ..... 238   | DPE302277 ... 150  | DPSG-2S ..... 242          | DTK113B ..... 78        | EC252120 ..... 150 |
| DE23 ..... 115     | DPE303120 .... 150 | DPSG-3 ..... 242           | DTK205..... 78          | EC25224 ..... 150  |
| DE24 ..... 115     | DPE30324 ..... 150 | DPSG-3MF..... 242          | DTK207 ..... 78         | EC252240 ..... 150 |
| DE33 ..... 115     | DPE303240 .... 150 | DPSG-3S ..... 242          | DTK210..... 78          | EC252277 ..... 150 |
| DEP052 ..... 91    | DPE303277 ... 150  | DPSG-4 ..... 242           | DTP-3..... 155          | EC302120 ..... 150 |
| DEP8001 ..... 91   | DPE303480 ... 150  | DPSG-4MF..... 242          | DTT-10 ..... 87         | EC30224 ..... 150  |
| DEP8002 ..... 91   | DPE304120 ... 150  | DRV10-414080-170 ..... 244 | DTT-24 ..... 87         | EC302240 ..... 150 |
| DF-75 ..... 79     | DPE30424 ..... 150 | DRV10-414120-170 ..... 244 | DU1-10D..... 239        | EC303120 ..... 150 |
| DG321NRB..... 144  | DPE304240 ... 150  | DRV10-418140-170 ..... 244 | DU1-10E ..... 239       | EC30324 ..... 150  |
| DG322NRB..... 144  | DPE304277 ... 150  | DRV10-418140-170 ..... 244 | DU1-12D..... 239        | EC303240 ..... 150 |
| DG322URB..... 144  | DPE401120 ... 150  | DRV2-408060-170 ..... 244  | DU1-4A ..... 239        | EC303277 ..... 150 |
| DMB-1..... 142     | DPE40124 ..... 150 | DRV2-408060-270 ..... 244  | DU1-4B ..... 239        | EC402120 ..... 150 |
| DMB-2..... 142     | DPE402120 ... 150  | DRV3-410080-770 ..... 244  | DU1-6B ..... 239        | EC40224 ..... 150  |
| DMB-3..... 142     | DPE40224 ..... 150 | DRV3-412080-870 ..... 244  | DU1-6C..... 239         | EC402240 ..... 150 |
| DN1-10 ..... 239   | DPE402240 ... 150  | DRV6-412080-170 ..... 244  | DU1-6D..... 239         | EC403120 ..... 150 |
| DN1-12..... 239    | DPE402480 ... 150  | DSL13-5SVHH ..... 241      | DU1-6E ..... 239        | EC40324 ..... 150  |
| DN1-14..... 239    | DPE403120 ... 150  | DSL13-6SVHH ..... 241      | DU1-8B ..... 239        | EC403240 ..... 150 |
| DN1-3 ..... 239    | DPE40324 ..... 150 | DSL13-7SVHH ..... 241      | DU1-8D..... 239         | EC403277 ..... 150 |
| DN1-4 ..... 239    | DPE403240 ... 150  | DSL13-8SVHH ..... 241      | DU1-8E ..... 239        | EC503120 ..... 150 |
| DN1-6 ..... 239    | DPE403480 .... 150 | DSL13-9SVHH ..... 241      | DU2-10..... 239         | EC50324 ..... 150  |
| DN5-4 ..... 239    | DPE404120 ... 150  | DSL27-7SVHH ..... 241      | DU2-12 ..... 239        | EC503240 ..... 150 |
| DN5-6..... 239     | DPE404240 ... 150  | DSL27-9SVHH ..... 241      | DU2-14..... 239         | EC503277 ..... 150 |
| DNS4-10..... 239   | DPE404277 .... 150 | DSL54-11SVHH ..... 241     | DU2-4 ..... 239         | EC-56 ..... 177    |
| DNS4-12 ..... 239  | DPE503120 .... 150 | DUS4-4 ..... 240           | DU2-6 ..... 239         | EC603120 ..... 150 |
| DNS4-14..... 239   | DPE50324 ..... 150 | DUS4-6 ..... 240           | DU2-8 ..... 239         | EC60324 ..... 150  |
| DNS4-4 ..... 239   | DPE503240 .... 150 | DUCT-FRESH-16 ..... 227    | DU3-10E ..... 240       | EC603240 ..... 150 |
| DNS4-6..... 239    | DPE602120 .... 150 | DUCT-FRESH-32 ..... 227    | DU3-6D..... 240         | EC603277 ..... 150 |
| DNS4-8..... 239    | DPE603120 ... 150  | DUCT-FRESH-8. 227          | DU3-8D..... 240         | EC753120 ..... 150 |
| DP-1 ..... 168     | DPE60324 ..... 150 | DUS4-4 ..... 240           | DUCT-FRESH-16 ..... 227 | EC75324 ..... 150  |
| DP2-10 ..... 239   | DPE603240 ... 150  | DUS4-6 ..... 240           | DUCT-FRESH-32 ..... 227 | EC753240 ..... 150 |
| DP2-4 ..... 239    | DPE753120 .... 150 | DX-3 ..... 241             | DUCT-FRESH-8. 227       | EC753277 ..... 150 |
| DP2-6 ..... 239    | DPE75324 ..... 150 | DX-4 ..... 241             | DUS4-4 ..... 240        | EC810 ..... 177    |
| DP2-8 ..... 239    | DPE753240 ... 150  | DXA-5..... 241             | DUS4-6 ..... 240        | EC903120 ..... 150 |
| DPB222R ..... 144  | DPE903120 ... 150  | E-10 ..... 177             | EC-1 ..... 41           | EC90324 ..... 150  |
| DPE252120 ... 150  | DPE90324 ..... 150 | E-5 ..... 177              | EC252120 ..... 150      | EC903240 ..... 150 |
| DPE25224 ..... 150 | DPE903240 ... 150  | E-6 ..... 177              | EC25224 ..... 150       | EC903277 ..... 150 |
|                    |                    | E-8..... 177               | EC252240 ..... 150      |                    |
|                    |                    | EB-10 ..... 177            | EC252277 ..... 150      |                    |
|                    |                    | EB-8 ..... 177             | EC302120 ..... 150      |                    |
|                    |                    | EC-1 ..... 41              | EC30224 ..... 150       |                    |
|                    |                    | EC252120 ..... 150         | EC302240 ..... 150      |                    |
|                    |                    | EC25224 ..... 150          | EC303120 ..... 150      |                    |
|                    |                    | EC252240 ..... 150         | EC30324 ..... 150       |                    |
|                    |                    | EC252277 ..... 150         | EC303240 ..... 150      |                    |
|                    |                    | EC302120 ..... 150         | EC303277 ..... 150      |                    |
|                    |                    | EC30224 ..... 150          | EC402120 ..... 150      |                    |
|                    |                    | EC302240 ..... 150         | EC40224 ..... 150       |                    |
|                    |                    | EC303120 ..... 150         | EC402240 ..... 150      |                    |
|                    |                    | EC30324 ..... 150          | EC403120 ..... 150      |                    |
|                    |                    | EC303240 ..... 150         | EC40324 ..... 150       |                    |
|                    |                    | EC303277 ..... 150         | EC403240 ..... 150      |                    |
|                    |                    | EC402120 ..... 150         | EC403277 ..... 150      |                    |
|                    |                    | EC40224 ..... 150          | EC503120 ..... 150      |                    |
|                    |                    | EC402240 ..... 150         | EC50324 ..... 150       |                    |
|                    |                    | EC403120 ..... 150         | EC503240 ..... 150      |                    |
|                    |                    | EC40324 ..... 150          | EC503277 ..... 150      |                    |
|                    |                    | EC403240 ..... 150         | EC-56 ..... 177         |                    |
|                    |                    | EC403277 ..... 150         | EC603120 ..... 150      |                    |
|                    |                    | EC503120 ..... 150         | EC60324 ..... 150       |                    |
|                    |                    | EC50324 ..... 150          | EC603240 ..... 150      |                    |
|                    |                    | EC503240 ..... 150         | EC603277 ..... 150      |                    |
|                    |                    | EC503277 ..... 150         | EC753120 ..... 150      |                    |
|                    |                    | EC-56 ..... 177            | EC75324 ..... 150       |                    |
|                    |                    | EC603120 ..... 150         | EC753240 ..... 150      |                    |
|                    |                    | EC60324 ..... 150          | EC753277 ..... 150      |                    |
|                    |                    | EC603240 ..... 150         | EC810 ..... 177         |                    |
|                    |                    | EC603277 ..... 150         | EC903120 ..... 150      |                    |
|                    |                    | EC753120 ..... 150         | EC90324 ..... 150       |                    |
|                    |                    | EC75324 ..... 150          | EC903240 ..... 150      |                    |
|                    |                    | EC753240 ..... 150         | EC903277 ..... 150      |                    |
|                    |                    | EC753277 ..... 150         |                         |                    |
|                    |                    | EC810 ..... 177            |                         |                    |
|                    |                    | EC903120 ..... 150         |                         |                    |
|                    |                    | EC90324 ..... 150          |                         |                    |
|                    |                    | EC903240 ..... 150         |                         |                    |
|                    |                    | EC903277 ..... 150         |                         |                    |

**PART NUMBER INDEX cont'd**

|                    |                   |                  |                   |                  |
|--------------------|-------------------|------------------|-------------------|------------------|
| ECO-COIL .....220  | ED610 .....125    | EL3648-3 .....19 | FF-1000-S .....31 | GV07 .....159    |
| ECO-COIL-32 ...220 | ED611 .....125    | EL3842-2 .....19 | FF-250-S .....31  | GV08 .....159    |
| ECO-COIL-5 ....220 | ED612 .....125    | EL3842-3 .....19 | FF-250-UNI.....31 | GV10 .....159    |
| ECO-COIL-55 ...220 | ED613 .....125    | EL3870-3 .....19 | FF-400-S .....31  | GV12 .....159    |
| ECR01-12W ....141  | ED620 .....125    | EL4040-3 .....19 | FF-600-S .....31  | GV14 .....159    |
| ECR01-9W ....141   | ED621 .....125    | EL4558-3 .....19 | FH-1 .....154     | GV16 .....159    |
| ED1232 .....123    | ED710 .....125    | EL4848-3 .....19 | FLOW-PLUS-10 .227 | GVA1 .....159    |
| ED1238 .....123    | ED877 .....123    | EL5252-3 .....19 | FLOW-PLUS-125     | GVA2 .....159    |
| ED1240-2 .....123  | ED9726 .....123   | EL5658-3 .....19 | .....227          | H1840-4 .....21  |
| ED1262-2 .....123  | ED-AT3 .....120   | EM480.....124    | FLOW-PLUS-200     | H2424-4 .....21  |
| ED1262-2I ....123  | ED-AT5 .....120   | EM484.....124    | .....227          | H2436-4 .....21  |
| ED1301 .....123    | ED-CR15 .....120  | EP1838-3.....23  | FLOW-PLUS-25.227  | H3030-4 .....21  |
| ED1301-I .....123  | ED-CR20 .....120  | EP2424-2 .....23 | FLOW-PLUS-6...227 | H3232-4 .....21  |
| ED1703 .....121    | ED-CR25 .....120  | EP2424-3.....23  | FM0450 .....41    | H3345-4 .....21  |
| ED1709 .....121    | ED-CR30 .....120  | EP2436-2 .....23 | FP-22 .....76     | H3636-4 .....21  |
| ED1711 .....122    | ED-CR35 .....120  | EP3030-2.....23  | FP-22-230.....76  | H3642-4 .....21  |
| ED179 .....121     | ED-CR40 .....120  | EP3030-3.....23  | FP-36 .....91     | H3648-4 .....21  |
| ED1876 .....123    | ED-CR45 .....120  | EP3232-2 .....23 | FRL12-F .....244  | H3652-4 .....21  |
| ED1876-I .....123  | ED-CR50 .....120  | EP3232-3.....23  | FRL14-F.....244   | H3654-4 .....21  |
| ED1877 .....123    | ED-CR60 .....120  | EP3244-2 .....23 | FRL38-F.....244   | H3672-4 .....21  |
| ED252 .....122     | EDS-12-6NM ...143 | EP3244-3 .....23 | FRL58-F.....244   | H3842-4 .....21  |
| ED270 .....123     | EDS-60U .....143  | EP3636-2 .....23 | FTL3 .....181     | H3852-4 .....21  |
| ED270-I.....123    | EG .....222       | EP3636-3.....23  | FTL3D .....181    | H3865-4 .....21  |
| ED273 .....114     | EG-5 .....222     | EP3648-3.....23  | FULO425 .....40   | H3872-4 .....21  |
| ED273CX .....114   | EG-55 .....222    | EP3842-2.....23  | FULO625 .....40   | H4040-4 .....21  |
| ED277 .....123     | EL1838-3 .....19  | EP3842-3.....23  | GA-06 .....168    | H4242-4 .....21  |
| ED2867 .....122    | EL2424-2 .....19  | EP4040-3.....23  | GA-30 .....168    | H4558-4 .....21  |
| ED2887 .....122    | EL2424-3 .....19  | ET130C1 .....158 | GAU225-PURGE      | H5557-4 .....21  |
| ED320 .....124     | EL2430-2 .....19  | ET22 .....158    | .....168          | HC-1 .....21     |
| ED406 .....114     | EL2436-2 .....19  | ET33 .....158    | GC275 .....158    | HC-1-100.....21  |
| ED419 .....122     | EL2436-3 .....19  | ET35G .....158   | GC277 .....158    | HC5410 .....118  |
| ED4409 .....122    | EL2626-2 .....19  | ET35N.....158    | GG-1 .....78      | HC5410X .....118 |
| ED447 .....123     | EL3030-2 .....19  | ET35R .....158   | GG-1A .....78     | HC5416 .....118  |
| ED448B .....123    | EL3030-3 .....19  | ET35W .....158   | GG-1BOR .....78   | HC5416X .....118 |
| ED4509 .....122    | EL3036-2 .....19  | ET44 .....158    | GG-1H.....78      | HC5420 .....118  |
| ED453 .....123     | EL3040-2 .....19  | ET75 .....79     | GG-1NHL .....78   | HC5424 .....118  |
| ED454 .....123     | EL3232-2 .....19  | ET75-KIT.....79  | GG-1TF .....78    | HC5436 .....118  |
| ED455 .....123     | EL3232-3 .....19  | FA-01 .....79    | GGC-12 .....78    | HC5436X .....118 |
| ED468 .....123     | EL3244-2 .....19  | FA-02 .....79    | GGC-6 .....78     | HC6202 .....118  |
| ED4867 .....122    | EL3244-3 .....19  | FA-03 .....79    | GN-23H.....93     | HC6203 .....118  |
| ED494 .....123     | EL3434-2 .....19  | FAK-10 .....90   | GP1-4OBL .....93  | HCO-128 .....86  |
| ED5225 .....123    | EL3636-2 .....19  | FAK-25 .....90   | GT-750.....168    | HCO-15.....86    |
| ED600 .....125     | EL3636-3 .....19  | FB-1 .....30     | GV04 .....159     | HCO-7 .....86    |
| ED601 .....125     | EL3640-2 .....19  | FC-73.....48     | GV05 .....159     | HCP-15 .....86   |
| ED602 .....125     | EL3640-3 .....19  | FC-74.....48     | GV06 .....159     | HCP-7 .....86    |
| ED603 .....125     | EL3648-2 .....19  | FC-87.....49     | GV07 .....159     | HDR-101 .....160 |

**PART NUMBER INDEX** cont'd

|                    |                       |                                |  |                                      |
|--------------------|-----------------------|--------------------------------|--|--------------------------------------|
| HDR-102 ..... 160  | HS-60-2 ..... 181     | LIT-FLY-COND ... 250           | M-4 ..... 177                                | MKT-POP-DEVELEC<br>..... 251         |
| HDR-201 ..... 160  | HSA1 ..... 159        | LIT-FLY-CS1200 250             | M-5..... 177                                 | MKT-POP-DEVEZC<br>..... 251          |
| HDR-202 ..... 160  | HSA2..... 159         | LIT-FLY-CVKUBE 250             | MAG-1..... 182                               | MKT-POP-DEVEZC<br>..... 251          |
| HDR-211 ..... 160  | HSK1 ..... 149        | LIT-FLY-CVKUBE-S<br>..... 250  | MB21 ..... 159                               | MKT-POP-DTBACKS<br>..... 251         |
| HDR-212 ..... 160  | HSK5..... 149         | LIT-FLY-CVMINI . 250           | MB22..... 159                                | MKT-POP-DTBACKS<br>..... 251         |
| HDR-221 ..... 160  | HT1840-4..... 21      | LIT-FLY-CVMINI-S<br>..... 250  | MBK-6 ..... 78                               | M K T - P O P -<br>DTBACKSSLAT . 251 |
| HDR-222 ..... 160  | HT2424-4..... 21      | LIT-FLY-DISC ..... 250         | MG-1 ..... 175                               | MKT-POP-DUCT . 251                   |
| HEK-400 ..... 160  | HT2436-4..... 21      | LIT-FLY-DST10 .. 250           | MG-RGB ..... 175                             | MKT-POP-DUCTSAM<br>..... 251         |
| HEK-500..... 160   | HT3030-4..... 21      | LIT-FLY-DTP3 .... 250          | MG-RGR ..... 175                             | MKT-POP-DUCTSAM<br>..... 251         |
| HFL-4257 ..... 160 | HT3232-4..... 21      | LIT-FLY-DTP3ES. 250            | MHP-4..... 177                               | MKT-POP-DUCTSAM<br>..... 251         |
| HFL-4300 ..... 160 | HT3345-4..... 21      | LIT-FLY-ELITE .... 250         | MICN109 ..... 49                             | MKT-POP-DUCTSAM<br>..... 251         |
| HFL-4333 ..... 160 | HT3636-4 ..... 21     | LIT-FLY-ET ..... 250           | MKT-MERCH-CHEM<br>..... 251                  | MKT-POP-EASEL. 250                   |
| HFL-5257 ..... 160 | HT3648-4..... 21      | LIT-FLY-FLOW .... 250          | MKT-MERCH-FLEX<br>..... 251                  | MKT-POP-ET .... 251                  |
| HFL-5258 ..... 160 | HT3656-4..... 21      | LIT-FLY-FOOT ... 250           | MKT-MERCH-RSC<br>..... 251                   | MKT-POP-HSI ... 251                  |
| HFL-5300 ..... 160 | HT3842-4..... 21      | LIT-FLY-GG..... 250            | MKT-MERCH-SEAL12<br>..... 251                | MKT-POP-PF .... 251                  |
| HFL-5301 ..... 160 | HT3852-4..... 21      | LIT-FLY-HEAT ..... 250         | MKT-MERCH-SEAL30<br>..... 251                | MKT-POP-WS .. 251                    |
| HFL-5333 ..... 160 | HT4040-4 ..... 21     | LIT-FLY-HEF ..... 250          | MKT-MERCH-SEAL30<br>..... 251                | MKT-POP-WSDEMO<br>..... 250          |
| HMD1844-4 .... 21  | HT4242-4..... 21      | LIT-FLY-HPAD .... 250          | MKT-MERCH-SEAL30<br>..... 251                | MKT-POP-WSDEMO<br>..... 251          |
| HMD2436-4 .... 21  | HT4558-4..... 21      | LIT-FLY-HRP ..... 250          | M K T - M E R C H -<br>USACAPS ..... 251     | MKT-SAM-ELEC. 251                    |
| HMD3030-4 .... 21  | HVENT-2 ..... 49      | LIT-FLY-HSI ..... 250          | MKT-POP-BROCH<br>..... 250                   | MKT-SAM-ELEC 250                     |
| HMD3636-4 .... 21  | HVENT-3..... 49       | LIT-FLY-MDP ..... 250          | MKT-POP-BROCH4<br>..... 250                  | MKT-SAM-HSI ... 250                  |
| HMD3648-4 .... 21  | IGN-001 ..... 48      | LIT-FLY-MOTORS. 250            | MKT-POP-BROCH4<br>..... 250                  | MKT-SAM-HSI ... 251                  |
| HMD3842-4 .... 21  | IGN-1R..... 48        | LIT-FLY-MSPLIT . 250           | MKT-POP-CDLC 251                             | MP-12 ..... 24                       |
| HMD4040-4 .... 21  | IGN-2 ..... 48        | LIT-FLY-PF..... 250            | MKT-POP-CHEM251                              | MP-12C..... 24                       |
| HMR-130..... 160   | IGN-2-6P ..... 48     | LIT-FLY-PUMP... 250            | MKT-POP-CLRGOND<br>..... 251                 | MP-12E ..... 24                      |
| HP3232-8 ..... 23  | IGN-401 ..... 48      | LIT-FLY-PF-S..... 250          | MKT-POP-CLRSHELF<br>..... 251                | MP-18 ..... 24                       |
| HP3636-8 ..... 23  | IGN-402 ..... 48      | LIT-FLY-RSC ..... 250          | MKT-POP-CLRSTAND<br>..... 251                | MP-18C..... 24                       |
| HPR-12 ..... 30    | IGN-403 ..... 48      | LIT-FLY-SEAL .... 250          | MKT-POP-CP22<br>..... 251                    | MP-18E ..... 24                      |
| HPR-3 ..... 30     | IGN-409..... 48       | LIT-FLY-SPRAYER250             | MKT-POP-CVTUBE<br>..... 251                  | MP-2 ..... 24                        |
| HPR-3-2P ..... 30  | IQP-120 ..... 76      | LIT-FLY-SPRAYER-S<br>..... 250 | MKT-POP-CLRSTAND<br>..... 251                | MP-2C..... 24                        |
| HPR-3-2PG ..... 30 | IQP-120T ..... 76     | LIT-FLY-UC ..... 250           | M K T - P O P - C P 2 2<br>CP22 ..... 251    | MP-2E ..... 24                       |
| HPR-6..... 30      | ISO-18 ..... 24       | LIT-FLY-UCSTRAP<br>..... 250   | MKT-POP-CVTUBE<br>..... 251                  | MP-3 ..... 24                        |
| HPR-6-2P ..... 30  | ISO-2 ..... 24        | LIT-FLY-UV ..... 250           | MKT-POP-DEVBACKS<br>..... 251                | MP-3C ..... 24                       |
| HPR-6-2PG ..... 30 | ISO-4 ..... 24        | LIT-FLY-VENTS .. 250           | MKT-POP-DEVBACKS<br>..... 251                | MP-3E ..... 24                       |
| HPR-EXT ..... 30   | JB8265..... 91        | LIT-FLY-WS ..... 250           | M K T - P O P -<br>DEVBACKSSLAT<br>..... 251 | MP-4 ..... 24                        |
| HS03 ..... 159     | LIT-CAT-CD ..... 250  | M-1 ..... 177                  | MKT-POP-DEVCOMBO .... 251                    | MP-4C ..... 24                       |
| HS04 ..... 159     | LIT-CAT-HVAC.... 250  | M-1R ..... 177                 | M K T - P O P -<br>DEVBACKSSLAT<br>..... 251 | MP-4E ..... 24                       |
| HS04-100 ..... 159 | LIT-CAT-NEW.... 250   | M-2 ..... 177                  | M K T - P O P -<br>DEVCOMBO .... 251         | MP-6..... 24                         |
| HS06 ..... 159     | LIT-CAT-QS ..... 250  | M-2R ..... 177                 | M K T - P O P -<br>DEVCOMBO .... 251         | MP-6C..... 24                        |
| HS08 ..... 159     | LIT-CAT-SEAL ... 250  | M-3 ..... 177                  | M K T - P O P -<br>DEVCOMBO .... 251         | MP-6E ..... 24                       |
| HS-144 ..... 180   | LIT-FLY-3D ..... 250  | M-3R ..... 177                 | M K T - P O P -<br>DEVCOMBO .... 251         | MP-8 ..... 24                        |
| HS16 ..... 159     | LIT-FLY-3D-S ... 250  |                                |  | MP-8C..... 24                        |
| HS-192 ..... 181   | LIT-FLY-BPOOL. 250    |                                |  |                                      |
| HS-30 ..... 181    | LIT-FLY-CDLC ... 250  |                                |  |                                      |
| HS-30-2 ..... 181  | LIT-FLY-CLAD .... 250 |                                |  |                                      |
| HS-60 ..... 181    | LIT-FLY-CLRVUE. 250   |                                |  |                                      |



## PART NUMBER INDEX cont'd

|                    |                   |                   |                       |                        |
|--------------------|-------------------|-------------------|-----------------------|------------------------|
| MSA-44.....236     | PI237.....126     | PI368.....111     | PP-4.....189          | PRO-YELLOW-55.....221  |
| MSA-45.....236     | PI301.....114     | PI370.....111     | PP-8.....189          | PRO-YELLOW-AER.....221 |
| N20-SD.....168     | PI303.....114     | PI371.....111     | PPC-16.....189        | PS-01.....227          |
| PA10.....159       | PI304.....114     | PI374.....110     | PPC-8.....189         | PS-03.....227          |
| PA18.....159       | PI305.....114     | PI375.....110     | PRO-BLUE.....220      | PS-07.....227          |
| PA25.....159       | PI306.....114     | PI377.....111     | PRO-BLUE-32...220     | PS-075.....227         |
| PA25AP.....159     | PI306CX.....114   | PI378.....111     | PRO-BLUE-5....220     | PS-1.....224           |
| PANPATCH.....221   | PI307.....114     | PI379.....111     | PRO-BLUE-55...220     | PS-20.....227          |
| PANPATCH-BAG .221  | PI307CX.....114   | PI381.....123     | PRO-BLUE-AER.220      | PS-40.....227          |
| PC-600-B.....42    | PI309.....114     | PI382.....111     | PRO-BROWN...220       | PW-16.....189          |
| PC-600-S.....42    | PI310.....114     | PI383.....110     | PRO-BROWN-32.....220  | PW-32.....189          |
| PC-609-B.....42    | PI310LX.....114   | PI384.....111     | PRO-BROWN-5.220       | PW-4.....189           |
| PC-609-S.....42    | PI311.....112     | PI385.....111     | PRO-BROWN-55.....220  | PW-8.....189           |
| PC-622-B.....42    | PI312.....112     | PI385-34.....111  | PRO-BROWN-AER.....220 | PWB-16.....189         |
| PC-622-S.....42    | PI315.....112     | PI386.....111     | PRO-BROWN-55.....220  | PWB-32.....189         |
| PC-857.....42      | PI316.....114     | PI387.....110     | PRO-BROWN-55.....220  | PWB-4.....189          |
| PE-014.....194     | PI317.....114     | PI389.....111     | PRO-BUBBLE-32.....225 | PWB-8.....189          |
| PE-038.....194     | PI318.....112     | PI389-GFI.....111 | PRO-GREEN....220      | PWH-16.....189         |
| PE-058.....194     | PI319.....112     | PI390.....110     | PRO-GREEN-32.220      | PWH-4.....189          |
| PE-104.....194     | PI319CX.....112   | PI391.....110     | PRO-GREEN-5.220       | PWH-8.....189          |
| PF-08.....223      | PI320.....112     | PI393.....110     | PRO-GREEN-55.220      | PWU-16.....189         |
| PF-16.....223      | PI321.....112     | PI394.....110     | PRO-GREEN-AER.....220 | PWU-4.....189          |
| PF-ADAPTER....223  | PI322.....112     | PI411.....112     | PRO-GREEN-55.220      | PWU-8.....189          |
| PF-IGUN.....223    | PI326.....126     | PI412.....112     | PRO-KLEEN....221      | PWW-16.....189         |
| PF-IHOSE.....223   | PI327.....126     | PI416.....112     | PRO-KLEEN-5..221      | PWW-4.....189          |
| PF-KIT.....223     | PI328.....126     | PI419.....112     | PRO-KLEEN-55.221      | PWW-8.....189          |
| PG-100.....222     | PI330.....114     | PI426.....112     | PRO-RED+.....221      | QAV-2.....194          |
| PG-100-5.....222   | PI331.....114     | PI458.....112     | PRO-RED+32...221      | QN-S3.....79           |
| PG-100-55.....222  | PI332.....114     | PI459.....112     | PRO-RED+5....221      | QSAC1000.....36        |
| PG-50.....222      | PI335.....118     | PI908.....114     | PRO-RED+55...221      | QSAC1100.....36        |
| PG-50-5.....222    | PI337-3.....126   | PI908CX.....114   | PRO-RED+AER.221       | QSAC2000.....36        |
| PG-50-55.....222   | PI340.....112     | PI909LX.....114   | PRO-THAW.....230      | QSAC2100.....36        |
| PG-BG.....223      | PI341.....112     | PI912.....114     | PRO-THAW-1...230      | QSBB1000.....31        |
| PG-BG-5.....223    | PI350.....112     | PI912LX.....114   | PRO-TREAT-151.228     | QSBB2000.....31        |
| PG-BG-55.....223   | PI351.....112     | PI913.....114     | PRO-TREAT-152.228     | QSLG1000.....36        |
| PG-PLUS.....223    | PI352.....112     | PI914.....114     | PRO-TREAT-161.228     | QSLG2000.....36        |
| PG-PLUS-5.....223  | PI353.....112     | PI929.....126     | PRO-TREAT-200.228     | QSMS1200.....32        |
| PG-PLUS-55.....223 | PI360.....110     | PK-2.....183      | PRO-TREAT-217.228     | QSMS1201.....32        |
| PI203.....114      | PI361.....110     | POE100-01.....229 | PRO-TREAT-350.227     | QSMS1202.....32        |
| PI206.....114      | PI361-3/4.....110 | POE100-32.....229 | PRO-YELLOW..221       | QSMS1203.....32        |
| PI221.....125      | PI362.....110     | POE32-01.....229  | PRO-YELLOW-32.....221 | QSMS1800.....32        |
| PI222.....125      | PI363.....110     | POE32-32.....229  | PRO-YELLOW-5.221      | QSMS1801.....32        |
| PI226.....126      | PI364.....110     | POE68-01.....229  | PRO-YELLOW-5.221      | QSMS1802.....32        |
| PI227.....126      | PI365.....110     | POE68-32.....229  | PP-16.....189         | QSMS2400.....32        |
| PI228.....126      | PI366.....110     | PP-16.....189     | PP-32.....189         |                        |
| PI232CX.....111    | PI367.....110     |                   |                       |                        |

**PART NUMBER INDEX** cont'd

|                    |                   |                    |                    |                     |
|--------------------|-------------------|--------------------|--------------------|---------------------|
| QSMS2401 .....32   | QSSS1016-24 ...34 | QSWB4000 .....32   | RS-TS10.....181    | T-400.....173       |
| QSMS2402 .....32   | QSSS1017-12 ..34  | QSWI1000 .....36   | S-3.....176        | T-408.....173       |
| QSRB1000 .....32   | QSSS1017-18 ..34  | QSWI2000 .....36   | SANI-CND .....222  | T-409.....173       |
| QSSS100-12 .....34 | QSSS1017-24 ..34  | QSWI3000 .....36   | SANI-CND-32 ..222  | T-411 .....173      |
| QSSS100-12 ....34  | QSSS1018-12 ..34  | QSWI3001 .....36   | SANI-CND-5 ....222 | T-412.....173       |
| QSSS1003-12 ..34   | QSSS1018-18 ..34  | QSWI3002 .....36   | SANI-CND-55...222  | T-417 .....173      |
| QSSS1003-18 ..34   | QSSS1018-24 ..34  | QSWI4000 .....36   | SC-1 .....90       | T-418.....173       |
| QSSS1003-24 ...34  | QSSS1019-12 ..34  | QSWI5000 .....36   | SC-10 .....84      | T5401.....151       |
| QSSS1004-12 ...34  | QSSS1019-18 ...34 | QSWI6000 .....36   | SC-1SHU .....90    | T6752.....151       |
| QSSS1004-18 ...34  | QSSS1019-24 ..34  | QT-1 .....237      | SC-1WP .....90     | T6753.....151       |
| QSSS1004-24 ..34   | QSSS1020-12 ...34 | QT-100 .....237    | SC-25 .....84      | T7752.....151       |
| QSSS1005-12 ...34  | QSSS1020-18 ..34  | QT-100G .....237   | SCM-10.....84      | T-8 .....173        |
| QSSS1005-18 ..34   | QSSS1020-24 ...34 | QT-100N .....237   | SCM-25.....84      | T-9 .....173        |
| QSSS1005-24 ...34  | QSSS1021-12 ...34 | QT-2.....237       | SCM-5.....84       | TC-007.....177      |
| QSSS1006-12 ..34   | QSSS1021-18 ...34 | QTH-1 .....237     | SHF-4-10FA2 ..244  | TC-25.....79        |
| QSSS1006-18 ...34  | QSSS1021-24 ...34 | QTH-2 .....237     | SHF-4-10FA4 ..244  | TD-1.....183        |
| QSSS1006-24 ...34  | QSSS1022-12 ...34 | QTM-1.....237      | SHF-4-10FA5 ...244 | TD-2.....183        |
| QSSS1007-12 ...34  | QSSS1022-18 ..34  | QTM-2.....237      | ST-10 .....87      | TG-05 .....182      |
| QSSS1007-18 ..34   | QSSS1022-24 ..34  | R-1.....178        | ST-24 .....87      | TG-10 .....79       |
| QSSS1007-24 ...34  | QSSS1023-12 ...34 | RC-1 .....242      | ST-4 .....87       | TG-30 .....182      |
| QSSS1008-12 ..34   | QSSS1023-18 ..34  | RLF-8 .....225     | ST75.....79        | TG-30-1 .....182    |
| QSSS1008-18 ...34  | QSSS1023-24 ...34 | RM-10.....93       | SUPER-KOOL...225   | TG-30-12 .....182   |
| QSSS1008-24 ..34   | QSSS1024-12 ...34 | RM-1G .....93      | SUPER-KOOL-16      | TG-87A.....79       |
| QSSS1009-12 ...34  | QSSS1024-18 ...34 | RS-15 .....181     | .....225           | TLC-3-10 .....159   |
| QSSS1009-18 ...34  | QSSS1024-24 ...34 | RS-20 .....181     | T-1 .....173       | TLC-3-12 .....159   |
| QSSS1009-24 ..34   | QSSS1025-12 ...34 | RS-31 .....181     | T-10 .....173      | TLC-3-8 .....159    |
| QSSS1010-12 ...34  | QSSS1025-18 ...34 | RS-41.....181      | T-100 .....173     | TRIPLE-D .....220   |
| QSSS1010-18 ..34   | QSSS1025-24 ...34 | RS-9 .....181      | T-101 .....173     | TRIPLE-D-32....220  |
| QSSS1010-24 ...34  | QSSS36 .....34    | RSC-GRN-02...246   | T-11 .....173      | TRIPLE-D-5 .....220 |
| QSSS1011-12 ..34   | QSSS48 .....34    | RSC-GRN-04K .246   | T-12 .....173      | TRIPLE-D-55 ...220  |
| QSSS1011-18 ...34  | QSSS55 .....34    | RSC-GRN-10 ...246  | T-13 .....173      | TRIPLE-D-AER...220  |
| QSSS1011-24 ...34  | QSSS70 .....34    | RSC-GRN-50K ..246  | T-14 .....173      | TRIPLE-D-GRAN       |
| QSSS1012-12 ..34   | QSTD1000 .....33  | RSC-RED-02 ...246  | T1401 .....151     | .....220            |
| QSSS1012-18 ..34   | QSTD2000 .....33  | RSC-RED-02-E .246  | T1404.....151      | TRIPLE-D-RTU ..220  |
| QSSS1012-24 ..34   | QSTD3000 .....33  | RSC-RED-04K ..246  | T-15 .....173      | TS-1 .....158       |
| QSSS1013-12 ..34   | QSTD4000 .....33  | RSC-RED-04K-E.246  | T-16 .....173      | TS-3 .....158       |
| QSSS1013-18 ..34   | QSTD4001 .....33  | RSC-RED-10 ...246  | T-20.....173       | TS-4 .....158       |
| QSSS1013-24 ..34   | QSTD4002 .....33  | RSC-RED-10-E 246   | T-200 .....173     | TS-5.....158        |
| QSSS1014-12 ...34  | QSTD5000 .....33  | RSC-RED-50K...246  | T-21 .....173      | TT-120 .....177     |
| QSSS1014-18 ..34   | QSTD5001 .....33  | RSC-RED-50K-E246   | T2401 .....151     | TT-24 .....177      |
| QSSS1014-24 ...34  | QSTD5002 .....33  | RSC-SLV-02 ....246 | T2403 .....151     | TT-240 .....177     |
| QSSS1015-12 ...34  | QSTD6000 .....33  | RSC-SLV-04K ..246  | T2404.....151      | U3353-3 .....18     |
| QSSS1015-18 ...34  | QSTD6001 .....33  | RSC-SLV-10 ....246 | T-300 .....173     | U3650-3 .....18     |
| QSSS1015-24 ..34   | QSWB1000 .....32  | RSC-SLV-500 ...246 | T3401 .....151     | U3654-3 .....18     |
| QSSS1016-12 ...34  | QSWB2000 .....32  | RSC-SLV-50K...246  | T3403 .....151     | U3660-3 .....18     |
| QSSS1016-18 ...34  | QSWB3000 .....32  | RSC-TOOL.....246   | T3501 .....151     | U3678-3 .....18     |

## PART NUMBER INDEX cont'd

|                     |                     |                    |                    |                      |
|---------------------|---------------------|--------------------|--------------------|----------------------|
| U3865-3 ..... 18    | UC3132-3L ..... 19  | VCC-4B ..... 236   | W121-100 ..... 162 | WC05 ..... 165       |
| U3870-3 ..... 18    | UC3143-2 ..... 18   | VCR-1 ..... 237    | W121-50 ..... 163  | WC06 ..... 165       |
| U4054-3 ..... 18    | UC3232-2 ..... 18   | VCRT-1 ..... 237   | W122 ..... 162     | WC07 ..... 165       |
| U4550-3 ..... 18    | UC3232-3 ..... 18   | VCRT-1R ..... 237  | W122-100 ..... 162 | WC08 ..... 165       |
| U4558-3 ..... 18    | UC3232-3CA ..... 19 | VCRT-1S ..... 237  | W122-50 ..... 163  | WC09 ..... 165       |
| U4848-3 ..... 18    | UC3237-3 ..... 18   | VLC-10 ..... 237   | W123 ..... 162     | WC10 ..... 165       |
| U4854-3 ..... 18    | UC3434-2 ..... 18   | VLC-12 ..... 237   | W123-100 ..... 162 | WC12 ..... 165       |
| U4866-3 ..... 18    | UC3434-3 ..... 18   | VLC-18 ..... 237   | W123-50 ..... 163  | WC14 ..... 165       |
| U5053-3 ..... 18    | UC3445-2 ..... 18   | VLC-25 ..... 237   | W124 ..... 162     | WC16 ..... 165       |
| U5056-3 ..... 18    | UC3445-3 ..... 18   | VLC-4 ..... 237    | W124-100 ..... 162 | WCA1 ..... 165       |
| U5075-3 ..... 18    | UC3445-3CA ..... 19 | VLC-5 ..... 237    | W124-50 ..... 163  | WG840204 ..... 138   |
| U5079-3 ..... 18    | UC3539-3L ..... 19  | VLC-6 ..... 237    | W125 ..... 162     | WG840204HT ..... 138 |
| U5252-3 ..... 18    | UC3636-2 ..... 18   | VLC-8 ..... 237    | W125-100 ..... 162 | WG840205 ..... 138   |
| U5260-3 ..... 18    | UC3636-3 ..... 18   | VP68-01 ..... 230  | W125-50 ..... 163  | WG840205HT ..... 138 |
| U5557-3 ..... 18    | UC3636-3CA ..... 19 | VP68-05 ..... 230  | W141 ..... 162     | WG840463 ..... 139   |
| U6067-3 ..... 18    | UC3640-2 ..... 18   | VP68-32 ..... 230  | W141-100 ..... 162 | WG840464 ..... 139   |
| UA-1 ..... 77       | UC3642-3 ..... 18   | VS-4 ..... 236     | W141-50 ..... 163  | WG840465 ..... 138   |
| UC1636-2 ..... 18   | UC3642-3CA ..... 19 | VST-4 ..... 236    | W142 ..... 162     | WG840466 ..... 139   |
| UC1636-3 ..... 18   | UC3648-2 ..... 18   | VST-44 ..... 236   | W142-100 ..... 162 | WG840467 ..... 139   |
| UC1838-3 ..... 18   | UC3648-3 ..... 18   | VTR-24 ..... 236   | W142-50 ..... 163  | WG840468 ..... 138   |
| UC1838-3CA ..... 19 | UC3648-3CA ..... 19 | VTS-10 ..... 236   | W143 ..... 162     | WG840469 ..... 138   |
| UC2424-2 ..... 18   | UC3842-2 ..... 18   | VTS-12 ..... 236   | W143-100 ..... 162 | WG840583 ..... 139   |
| UC2424-3 ..... 18   | UC3842-3 ..... 18   | VTS-14 ..... 236   | W143-50 ..... 163  | WG840584 ..... 139   |
| UC2424-3CA ..... 19 | UC4040-2 ..... 18   | VTS-3-12 ..... 236 | W144 ..... 162     | WG840585 ..... 139   |
| UC2430-2 ..... 18   | UC4040-3 ..... 18   | VTS-3-14 ..... 236 | W144-100 ..... 162 | WG840586 ..... 139   |
| UC2430-3 ..... 18   | UC4040-3CA ..... 19 | VTS-46 ..... 236   | W144-50 ..... 163  | WG840587 ..... 139   |
| UC2436-2 ..... 18   | UC4042-3 ..... 18   | VTS-56 ..... 236   | W145 ..... 162     | WG840588 ..... 139   |
| UC2436-3 ..... 18   | UC4044-3L ..... 19  | VTS-68 ..... 236   | W145-100 ..... 162 | WG840589 ..... 139   |
| UC2436-3CA ..... 19 | UC4347-3 ..... 18   | VTS-810 ..... 236  | W145-50 ..... 163  | WG840590 ..... 139   |
| UC2442-3 ..... 18   | UV-1 ..... 40       | VVC-1 ..... 236    | W801 ..... 162     | WG840595 ..... 139   |
| UC2448-2 ..... 18   | UV-BULB ..... 40    | W101 ..... 162     | W801-100 ..... 162 | WG840596 ..... 139   |
| UC2448-3 ..... 18   | VA-3-346 ..... 236  | W101-100 ..... 162 | W801-50 ..... 163  | WG840727 ..... 138   |
| UC2448-3CA ..... 19 | VA-34 ..... 236     | W101-50 ..... 163  | W802 ..... 162     | WG840728 ..... 138   |
| UC2626-2 ..... 18   | VA-46 ..... 236     | W102 ..... 162     | W802-100 ..... 162 | WG840728HT ..... 138 |
| UC2626-3 ..... 18   | VA-68 ..... 236     | W102-100 ..... 162 | W802-50 ..... 163  | WG840729 ..... 138   |
| UC2628-2 ..... 18   | VAU-24 ..... 236    | W102-50 ..... 163  | W803 ..... 162     | WG840729HT ..... 138 |
| UC2636-3CA ..... 19 | VAU-45 ..... 236    | W103 ..... 162     | W803-100 ..... 162 | WG840730 ..... 138   |
| UC3030-2 ..... 18   | VAX-2 ..... 236     | W103-100 ..... 162 | W803-50 ..... 163  | WG840730HT ..... 138 |
| UC3030-3 ..... 18   | VAX-3 ..... 236     | W103-50 ..... 163  | W804 ..... 162     | WG840731 ..... 138   |
| UC3030-3CA ..... 19 | VAX-4 ..... 236     | W104 ..... 162     | W804-100 ..... 162 | WG840731HT ..... 138 |
| UC3036-2 ..... 18   | VAX-5 ..... 236     | W104-100 ..... 162 | W804-50 ..... 163  | WG840736HT ..... 138 |
| UC3036-3 ..... 18   | VAX-6 ..... 236     | W104-50 ..... 163  | W805 ..... 162     | WG840737HT ..... 138 |
| UC3036-3CA ..... 19 | VAX-8 ..... 236     | W105 ..... 162     | W805-100 ..... 162 | WG840738HT ..... 138 |
| UC3040-2 ..... 18   | VC-4 ..... 236      | W105-100 ..... 162 | WC02 ..... 165     | WG840739HT ..... 138 |
| UC3040-3 ..... 18   | VC-4R ..... 236     | W105-50 ..... 163  | WC03 ..... 165     | WHT20 ..... 163      |
| UC3040-3CA ..... 19 | VCC-4 ..... 236     | W121 ..... 162     | WC04 ..... 165     | WHTB10-20 ..... 163  |

## PART NUMBER INDEX cont'd

|                    |                   |
|--------------------|-------------------|
| WHTB10-50..... 163 | WTB11D ..... 165  |
| WHTB12-20..... 163 | WTB11M ..... 165  |
| WHTB12-50..... 163 | WTB15 ..... 165   |
| WHTB14-50..... 163 | WTB15C ..... 165  |
| WHTR14-50 ... 163  | WTBA1 ..... 165   |
| WHTW14-50 ... 163  | WTM05 ..... 165   |
| WM1002..... 126    | WTM05C ..... 165  |
| WM1003..... 126    | WTM07 ..... 165   |
| WM1009..... 126    | WTM07C ..... 165  |
| WM1014..... 126    | WTM1 ..... 165    |
| WP1212-164 ..244   | WTM11 ..... 165   |
| WP1212-50 ...244   | WTM11C ..... 165  |
| WP1214-164 ..244   | WTM14 ..... 165   |
| WP1214-50 ...244   | WTM14C ..... 165  |
| WP1234-50 ...244   | WTM1C ..... 165   |
| WP1234-82 ...244   | WTM2 ..... 165    |
| WP1238-164 .244    | WTM2C ..... 165   |
| WP1238-50 ...244   | WTMB05 ..... 165  |
| WP1258-164 .244    | WTMB05C ..... 165 |
| WP1258-50 ...244   | WTMB07 ..... 165  |
| WP1278-50 ...244   | WTMB07C ..... 165 |
| WP1278-82 ...244   | WTMB11 ..... 165  |
| WS-1..... 77       | WTMB11C ..... 165 |
| WT04 ..... 165     | WTMB14 ..... 165  |
| WT04C ..... 165    | WTMB14C ..... 165 |
| WT05 ..... 165     | X2424211 ..... 22 |
| WT05C ..... 165    | X2424311 ..... 22 |
| WT07 ..... 165     | X2430211 ..... 22 |
| WT07C ..... 165    | X2436211 ..... 22 |
| WT07M ..... 165    | X2436311 ..... 22 |
| WT11 ..... 165     | X3030211 ..... 22 |
| WT11C ..... 165    | X3030311 ..... 22 |
| WT11L ..... 165    | X3232211 ..... 22 |
| WT15 ..... 165     | X3232311 ..... 22 |
| WT15C ..... 165    | X3244211 ..... 22 |
| WTA1 ..... 165     | X3636211 ..... 22 |
| WTB05..... 165     | X3636311 ..... 22 |
| WTB05C ..... 165   | X3836211 ..... 22 |
| WTB05M ..... 165   | X3842211 ..... 22 |
| WTB07 ..... 165    | X3848311 ..... 22 |
| WTB07C..... 165    |                   |
| WTB07M ..... 165   |                   |
| WTB11 ..... 165    |                   |
| WTB11C..... 204    |                   |
| WTB11C ..... 165   |                   |
| WTB11CR..... 165   |                   |



**PADS**

**MOUNTING SYSTEMS**

**AIR MOVEMENT**

**HEATING PRODUCTS**

**CONDENSATE MANAGEMENT**

**GENERAL INDUSTRIAL**

**DEVCO**

**ELECTRICAL**

**TOOLS**

**PLUMBING**

**DUCTLESS SYSTEMS**

**MAINTENANCE CHEMICALS**

**INLINE COMPONENTS**

## **ABOUT DIVERSITECH**

Founded in 1971, DiversiTech® Corporation is North America's largest manufacturer of equipment pads and a leading manufacturer and supplier of components and related products for the heating, ventilating, air conditioning, and refrigeration (HVAC/R) industry. Headquartered in the Atlanta, Ga., metropolitan area, DiversiTech's mission for its wholesaler partners is to simplify their work. The Company is focused on growth through internal product development, external partnerships and acquisition. Manufacturing a suite of products, which includes a wide range of mechanical, electrical, chemical and structural parts for HVACR systems, DiversiTech brings unparalleled scaling capabilities and supplier expertise. The Company holds numerous patents and operates an advanced R&D materials division dedicated to bringing more value to its customers. The Company maintains over 1 million square feet of manufacturing and distribution space in key U.S., Canadian and European locations. DiversiTech has enjoyed a continued history of successful growth and has acquired industry recognized brand names including Wagner® Manufacturing, Specialty Chemical, EcoPad®, The Black Pad®, Quick-Sling® and Super Seal™. More information is available at [www.diversitech.com](http://www.diversitech.com).



**E LITE**  
DiversiTech

**HEF-T-PAD**  
DiversiTech

**THE BLACK PAD**  
DiversiTech

**ULTRALITE**  
DiversiTech

**GLADLITE**  
DiversiTech

LIT-CAT-HVAC  
6650 Sugarloaf Parkway  
Duluth, GA 30097  
678.542.3600  
800.995.2222  
678.542.3700 Fax  
www.diversitech.com  
©2017 DiversiTech Corporation

DOWNLOAD [http://media.  
diversitech.com/doc/  
DOC32509.pdf](http://media.diversitech.com/doc/DOC32509.pdf)

CORRECTIONS/COMMENTS  
[feedback@diversitech.com](mailto:feedback@diversitech.com)

**DIVERSITECH**®

