

CROSS REFERENCE IGNITER INFORMATION

1411

REPLACES:

- Rheem 62-22868-82 • Uni-Line 41-411

1412

REPLACES:

- Goodman B1401009 • Intercity 1009604
- Uni-Line 41-412

8028

REPLACES:

- Hayward Pool Products 1503051401

8030

REPLACES:

- Nordyne/Partners Choice 632320, 903179

• Bracket included.

1411

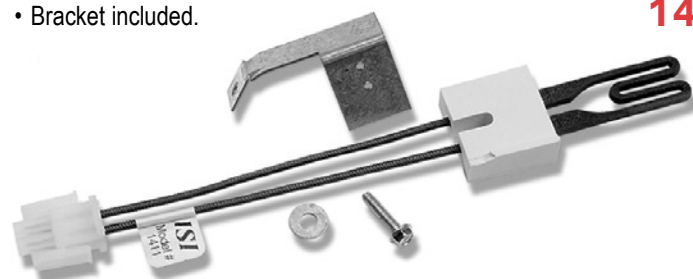

• 5.5" leads with connector.

• Bracket included.

1412



• 5.5" leads with connector.

• 5.5" leads with connector.

8028

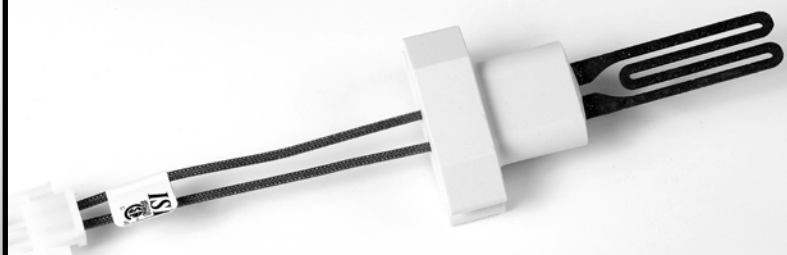

• Connector included.

8030

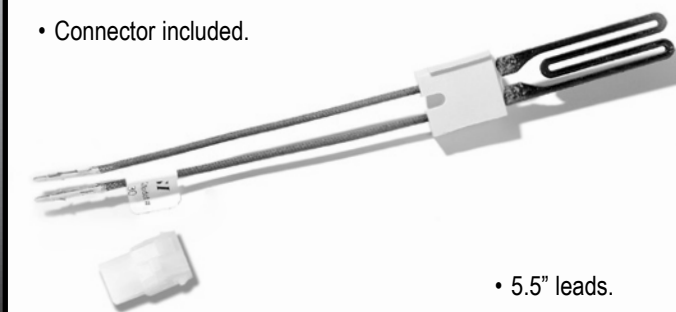

• 5.5" leads.

CROSS REFERENCE IGNITER INFORMATION

0557

REPLACES:

- White Rodgers 767A-303, 767A-353, 767A-357.

0561

REPLACES:

- White Rodgers 767A-301, 767A-306, 767A-350, 767A-354, 767A-361.

1033

REPLACES:

- Clare C238

1034

REPLACES:

- Rheem 62-22669-92

• 9" leads with connector.

0557

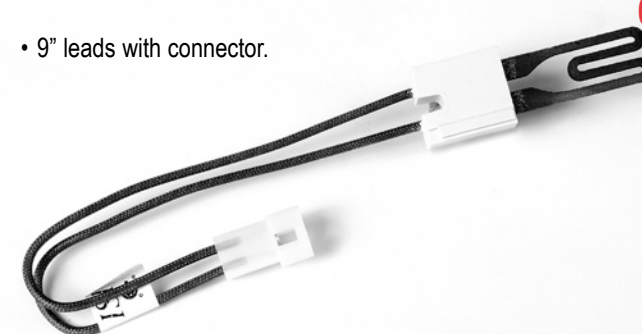

• 9" leads with connector.

0561



• 36" leads with connector.

1033

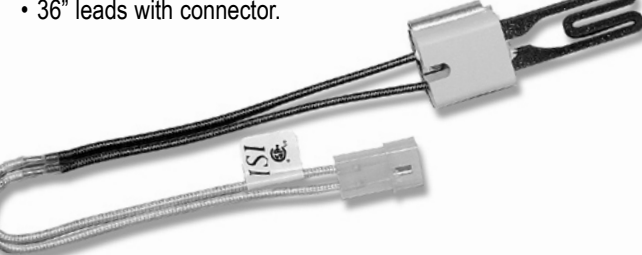

• Mounting bracket and gasket included.
• 8.5" leads with connector.

1034

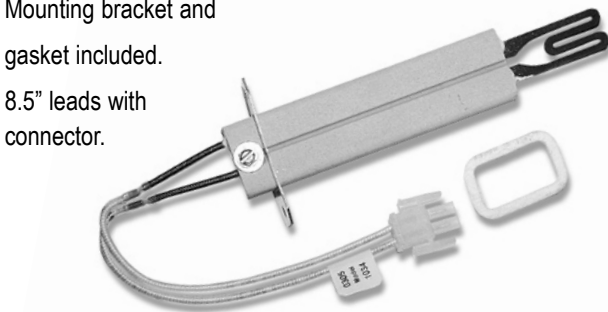

CROSS REFERENCE IGNITER INFORMATION

1040

REPLACES:

- Weil McLain 511-330-145

1050

REPLACES:

- Raypak 601559, 601600

1051

REPLACES:

- Raypak 601826

1056

REPLACES:

- DMO 20834, 26789

- 5.5" leads with connector.

1040



- 5.5" leads with connector.

1050

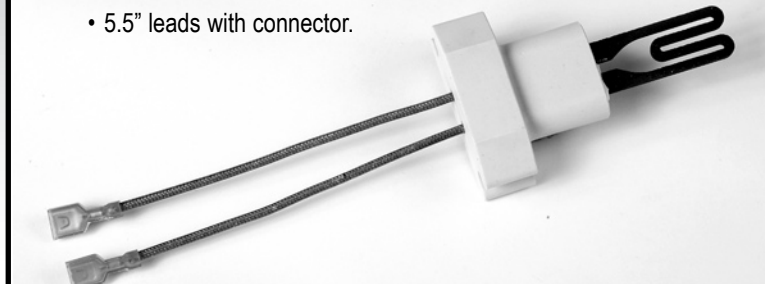

- 24" leads with connector.

1051



- 12" leads with connector.

1056



- Gasket included.
- 11" leads with wire nuts.

1406

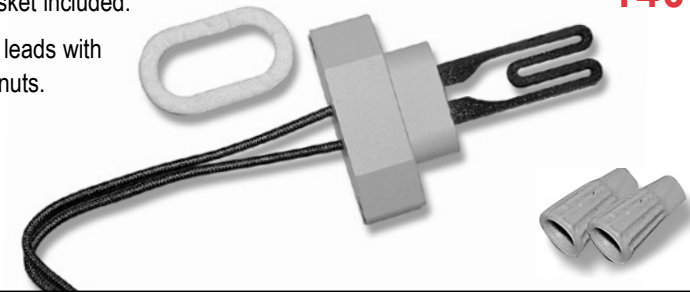

- 5.5" leads with connector.

1407

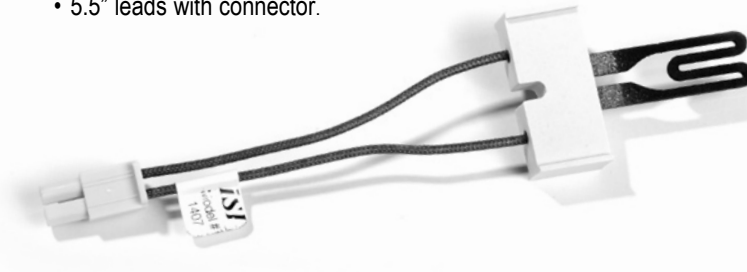

- 5.5" leads with connector.

1408



- 5.5" leads with connector.

1409

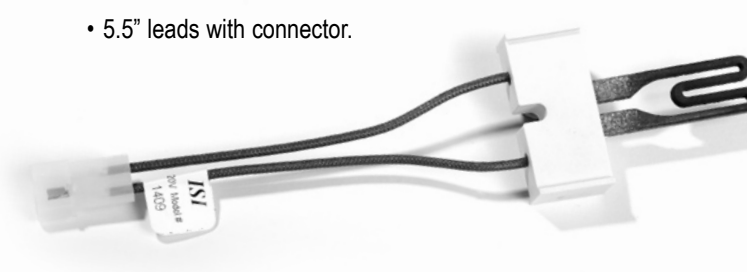

- 5.5" leads with connector.

1410



1406

REPLACES:

- Glowcore HSRK-7 • Lochinvar PLT2400
- Surfaceigniter FY009 • Uni-Line 41-406 • Weil McLain 511-330-188

1407

REPLACES:

- Trane B144676P02, IGN30
- Uni-Line 41-407

1408

REPLACES:

- Rheem 62-22868-92, 62-22868-93
- Trane B340039P01 • Uni-Line 41-408

1409

REPLACES:

- Carrier LH33ZS001, 002, 003, 004 • Ducane 20015201 • Snyder General 1380672, 1380680 • Trane IGN26 • Uni-Line 41-409 • Weil McLain 511-330-139

1410

REPLACES:

- Trane B144676P01 • Uni-Line 41-410



CROSS REFERENCE IGNITER INFORMATION

1402

REPLACES:

- Armstrong 38322B001 • Clare C-238, C-242 • DMO 20834, 26789 • Dornback 271W
- Rheem 62-22441-01 • Trane 340039P01, IGN23 • Uni-Line 41-402 • Williamson 09050

1403

REPLACES:

- Raypak 600915 • Snyder General 1380654
- Trane B138196P01, IGN26, IGN30 • Uni-Line 41-403 • Weil McLain 511-330-193

1404

REPLACES:

- Uni-Line 41-404 • Weil McLain 511-330-190

1405

REPLACES:

- Uni-Line 41-405 • White Rodgers 767A-361
- York 025-27766-000, 025-27774-000, 025-29043-000, 025-29050-000

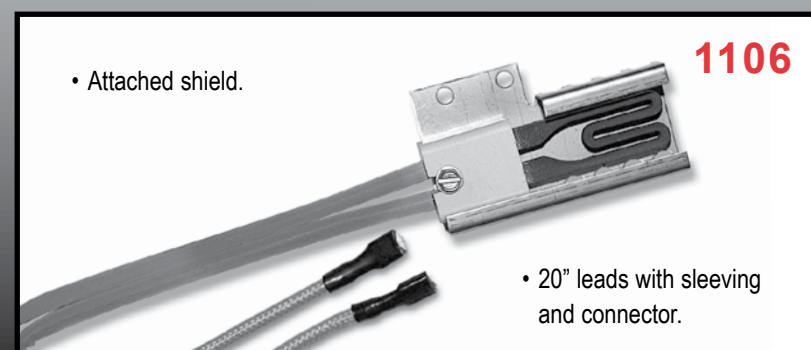
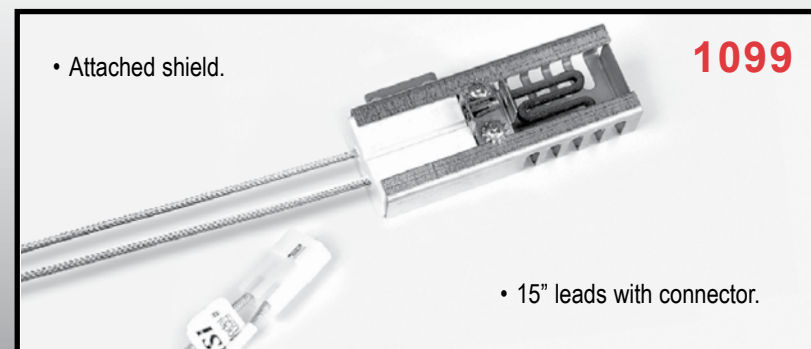
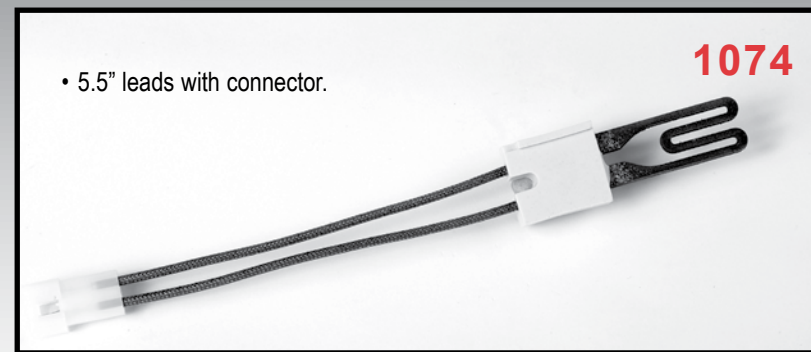
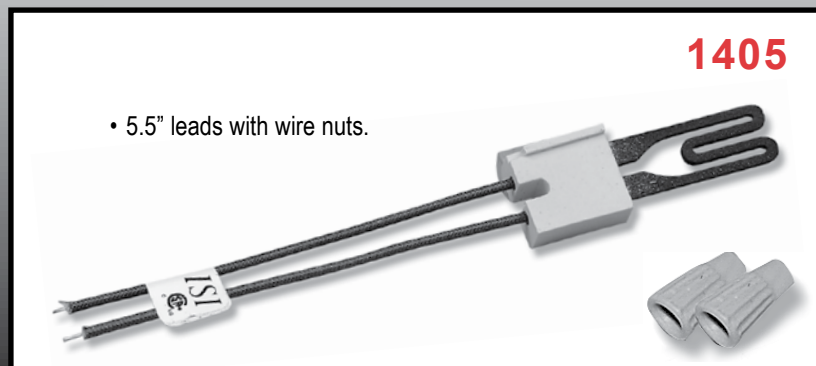
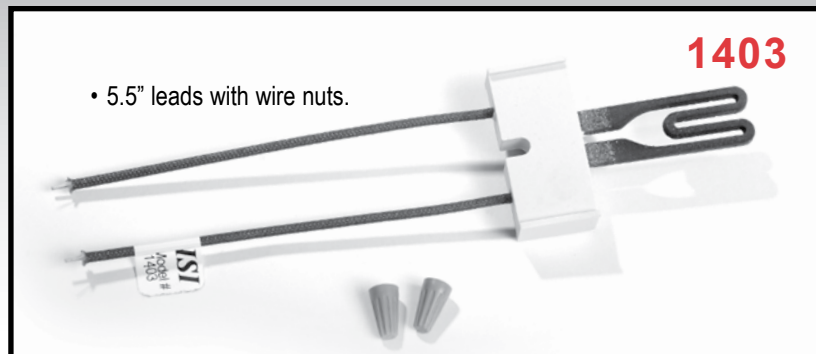

1061

REPLACES:

- Coleman 1474-051P, 052P

1074

REPLACES:

- Detroit Radiant 101D

1090

- Replacement for flat and spiral igniters in over 50 furnace applications.
- Refer to separate 1090 cross reference for complete list.

1099

REPLACES:

- Rheem AP12553

1106

REPLACES:

- GSW/John Woods 86483

CROSS REFERENCE IGNITER INFORMATION

1108

REPLACES:

- GSW/John Woods 63994

1109

REPLACES:

- Lochinvar PLT3400

1114

REPLACES:

- Nordyne/Partners Choice 632363, 903758

1119

REPLACES:

- Lennox 33J37

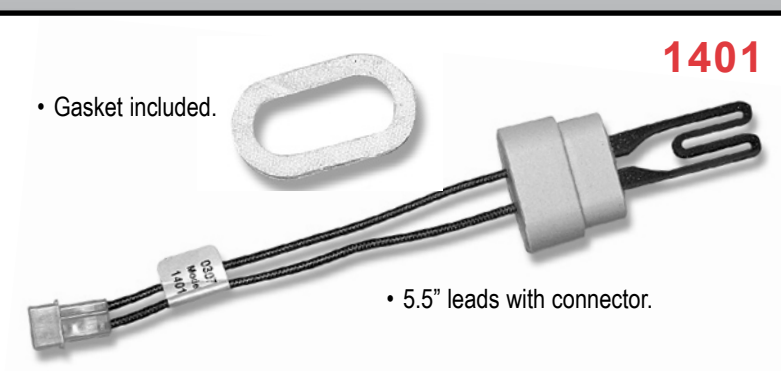
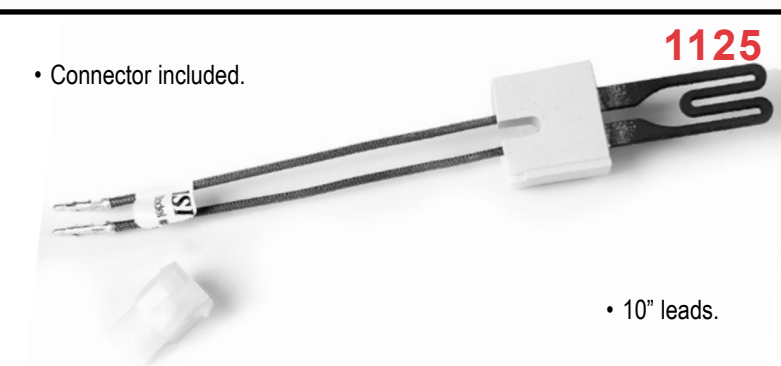
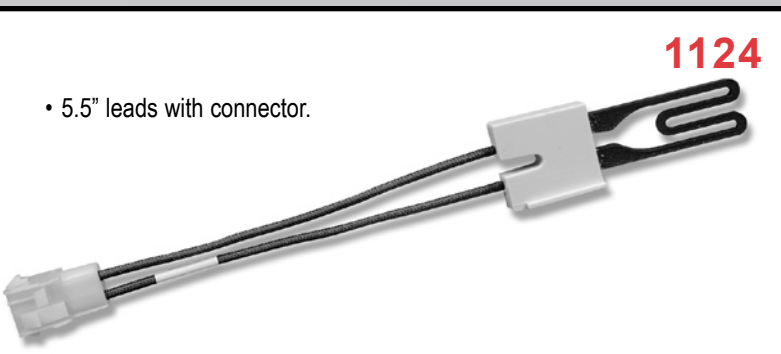
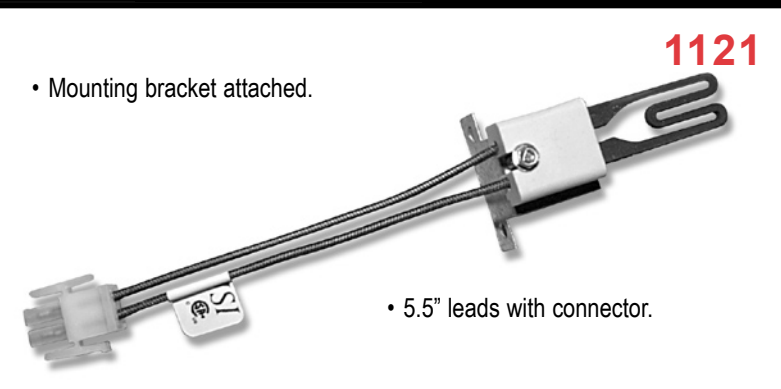
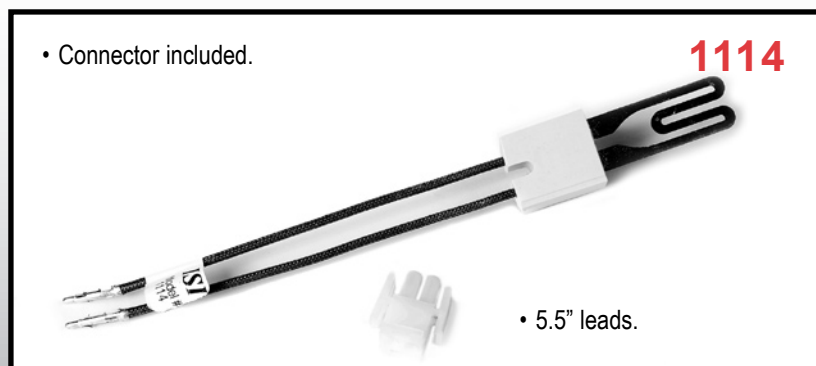
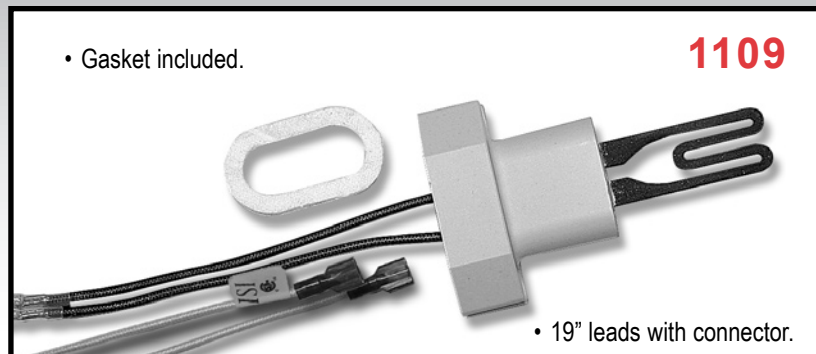
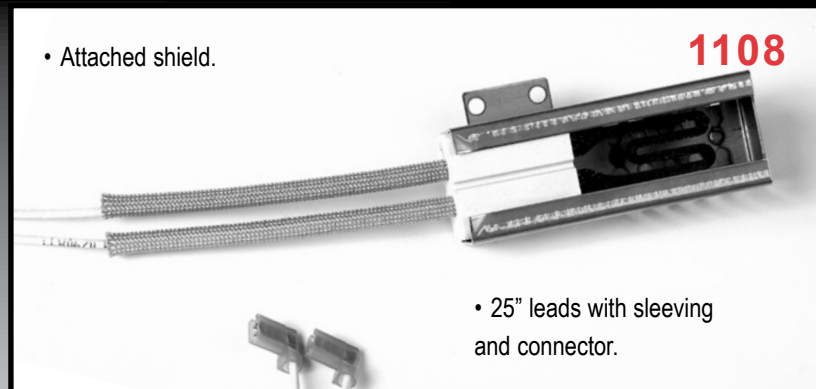

1121

REPLACES:

- Goodman B1401015, B1401018S • Modine 5H075032B

1124

REPLACES:

- York 025-32625-000

1125

REPLACES:

- Nordyne/Partners Choice 902499

1401

REPLACES:

- Amana 10041601, B1336102, D99182 • Trianco-Heatmaker 2600-359 • Uni-Line 41-401 • White Rodgers 767A-309, 767A-356