

scully



Innovative Delivery Efficiency Equipment

Complete System Catalog



www.scully.com

Over 75 Years of Safe, Innovative Oil Delivery Systems

Scully's first product, the Ventalarm Signal® was invented by Francis P. Scully in 1935. This ingenious device which whistled continuously while the tank was filling, was a simple fail-safe instrument which revolutionized the fuel oil industry- preventing spills while allowing for faster fill rates. The products which followed included:

- Tank gauges
 - TightFill connectors
 - Delivery nozzles
 - Flow controls
- designed as a total system to prevent spills and improve delivery efficiency and profitability.*

All of these products are still in use today. Scully systems now also include electronic overfill prevention, grounding, vapor sensing and identification systems for petroleum and chemical loading and storage operations.

Francis P. Scully with one of his ingenious inventions, the Ventalarm® Gauge



Safety, Efficiency and Dependability

"For over 75 years, Scully Signal Company's liquid detection and delivery systems have been built on a firm commitment to safety, efficiency and dependability.

We design, manufacture and service our products to respond directly to individual customer requests and to the needs of the marketplace. It's not uncommon for our products to outlast the tanks and vehicles in which they are installed. Scully is a family tradition spanning three generations.

The pride we take in the Scully name and our products is equaled in the care that is taken in finding liquid handling solutions and providing the highest quality service to our customers worldwide. Please contact us with your product and service needs. We look forward to serving you."

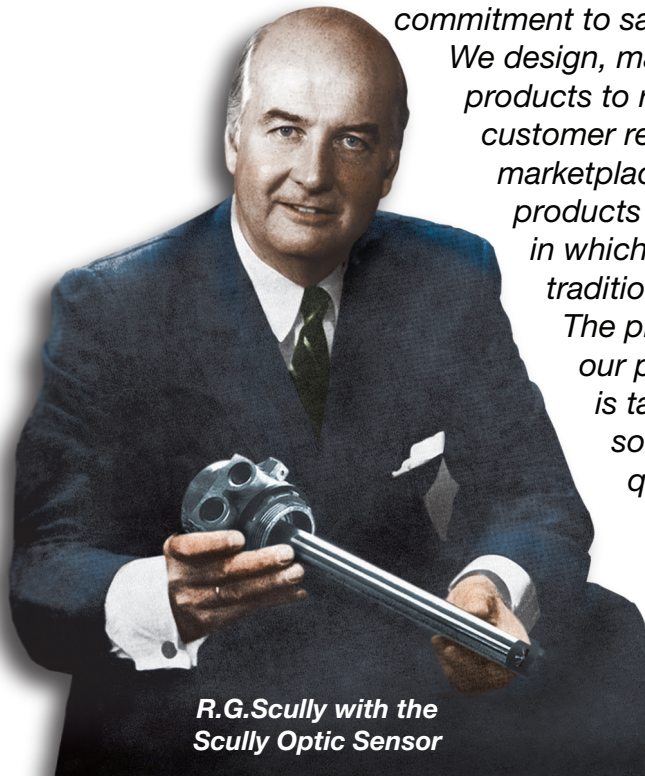

R.G. Scully with the Scully Optic Sensor

A handwritten signature in black ink, reading "Robert G. Scully".

**Robert G. Scully
President**

Delivery Efficiency Equipment

Table of Contents - Complete System Catalog

Nozzles

Pages 1 - 4



Spouts & Ventafil®

Pages 5 & 6



Sculmatic® Vehicle Pumping System

Pages 6 - 8



Tank Fill Signals

Pages 9 - 11

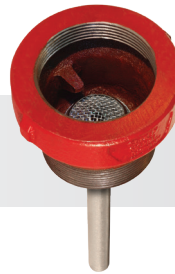

Tank Gauges & Water Detectors

Pages 12 - 14



Unifil® System

Pages 15 & 16



Fuel Oil Delivery



Lube Oil Delivery

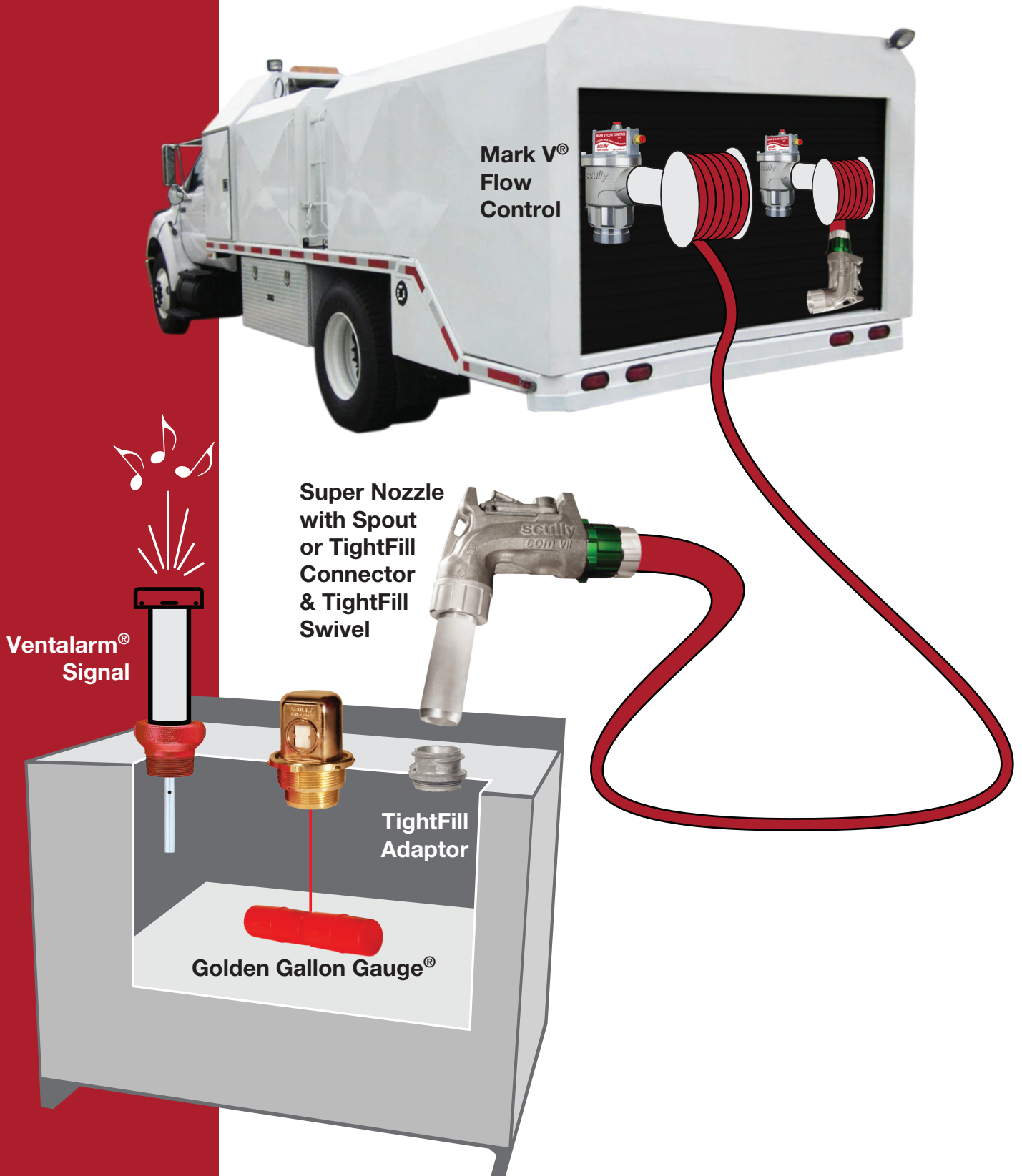

For More Information and 24 Hour Technical Assistance,
Call Scully Signal Company at 1-800-2SCULLY (1-800-272-8559)

Sculflow® Nozzles & COM A Hose Swivels

The Most Popular Delivery Nozzles in the World with Increased Hose Flexibility and Freedom of Movement



- The leading choice for light product, high volume deliveries.
- Reduced pressure drop allows for faster pumping speeds.
- Prevent closing shock to prolong truck equipment life.
- Feature leak-proof filling and no-drip operation.
- Original ball valve design and deadbolt locking handle.
- Advanced ball bearing design allows for easy rotation at all operating pressures.
- Teflon high recovery seal and shielded bearings for optimum field performance.
- No nipple required to attach hose with male style swivels.
- Lightweight aluminum and zinc construction.
- Wide variety of liquid product use.

Materials

- Aluminum body.
- Hard chrome plated brass ball valve.
- Teflon ball seat.
- Delrin ball follower.
- Aluminum and zinc swivel body.
- Teflon swivel seal.
- Viton seals.

Options

- 5 P.S.I. anti-drip valve.
 - Without swivel.
 - Sightglass.
 - Special chemicals.
- Consult Scully for part numbers.*

Flow Rates

- Used for deliveries up to 100 G.P.M.

Inlet Style	Inlet Thread	Outlet Thread	Part #
FEMALE	1 1/4"	UNIFIL Nozzle Connector	05062
FEMALE	1 1/4"	1 1/4" Female NPT	05066
FEMALE	1 1/4"	1 1/2" Female NPT	05070
FEMALE	1 1/2"	UNIFIL Nozzle Connector	05064
FEMALE	1 1/2"	1 1/4" Female NPT	05068
FEMALE	1 1/2"	1 1/2" Female NPT	05072
MALE	1 1/4"	UNIFIL Nozzle Connector	05100
MALE	1 1/2"	UNIFIL Nozzle Connector	05106

All units listed have 3 P.S.I. anti-drip valves, call for 5 P.S.I. part numbers. All units listed include swivels.

Note: 1 1/4" nozzles fit 1 1/4" hoses. 1 1/2" nozzles fit 1 3/8" hoses.

Sculflow® Nozzle TightFill Hose Swivels

Increased Hose Flexibility and Freedom of Movement

- Advanced ball bearing design allows for easy rotation at all operating pressures.
- Teflon high recovery seal and shielded bearings for optimum field performance.
- No nipple required to attach hose with male style swivels.
- Lightweight aluminum and zinc construction.
- Wide variety of liquid product use.



Female Sculflow Swivel



Male Sculflow Swivel

Inlet Style	Inlet Pipe Size	Male Outlet Thread	Part #
FEMALE	1 1/4"	COM-A	05815
FEMALE	1 1/2"	COM-A	05816
MALE	1 1/4"	COM-A	05865
MALE	1 1/2"	COM-A	05868

COM-A outlet thread screws directly into the Sculflow Nozzle body only





Scully Truck Equipment

Sculflow® Nozzle Replacement Parts

Only genuine Scully replacement parts will ensure proper operation and prevent liabilities associated with spills.

Description	Part #
Sight Glass - photo A	05421
Nozzle Connector- photo B	04346
O-Rings for Nozzle Connector (Qty.3)- photo C	04318
Anti-Drip Valve, 3 P.S.I. (Qty.5)- photo D	11502
Kit Handle & Latch Assembly (Qty.5)- photo E	11603
Nozzle Rebuild Kit- photo F	05416
Handle Upgrade Kit- photo G	11604
Seal Kit, no swivel parts- photo H	05415
Seal kit, to repair two swivels for Sculflow Nozzle- photo I	05859

Note: Latch Replacement parts for Sculflow Standard and Com Nozzles pre 1981 are available. Contact Scully for details.

				
05421	04346	04318	11502	11603
Sight Glass- A	Nozzle Connector- B	Nozzle Connector- C (Qty.3)	Anti-Drip Valve- D (Qty.5)	Handle & Latch Assembly Kit- E (Qty.5)

05416 Nozzle Rebuild Kit- F



- Self Locking Screw
- Control Rod Washer
- Zinc Plated Screw (4)
- Bushing
- Control Rod Shim
- Plated Ball
- Retainer
- 11603-Handle & Latch Assembly Kit**
- Curved Washer
- Control Rod Viton O Ring
- Viton O Ring (6 Sizes)
- Seat
- Thrust Washer
- Wave Washer
- 11502 Complete Anti-Drip Valve Assembly**

11604 Handle Upgrade Kit- G



- Control Rod Washer
- Curved Washer
- Control Rod Shim
- Viton O Ring (2 Sizes)
- Screw-Self Locking
- Control Rod Viton O Ring
- 11603-Handle & Latch Assembly Kit**
- Bushing
- Zinc Plated Screw (4)

05415 Nozzle Seal Kit- H

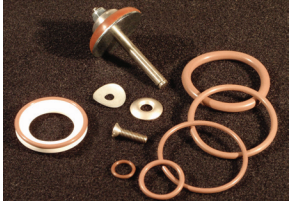

- Self Locking Screw
- Control Rod Washer
- Curved Washer
- E Ring
- Poppet & Shaft
- Viton O Ring (6 Sizes)
- Seat

05859 Seal Kit, Swivels for Sculflow Nozzle- I



- Viton O Ring
- Felt Washer
- Radial Bearing Assembly
- Large Bearing Washer
- Thrust Bearing
- Small Bearing Washer
- Retaining Ring

Super Nozzles & COM B Hose Swivels

The Ideal Commercial Delivery Nozzles with Increased Hose Flexibility and Freedom of Movement

- The leading choice for heavy product, high volume deliveries.
- Reduced pressure drop allows for faster pumping speeds.
- Prevents closing shock to prolong truck equipment life.
- Feature leak-proof filling and no-drip operation.
- Original ball valve design and deadbolt locking handle.
- Advanced ball bearing design allows for easy rotation at all operating pressures.
- Teflon high recovery seal and shielded bearings for optimum field performance.
- No nipple required to attach hose with male style swivels.
- Lightweight aluminum and zinc construction.
- Wide variety of liquid product use.



Materials

- Aluminum body.
- Hard chrome plated brass ball valve.
- Teflon ball seat.
- Delrin ball follower.
- Anodized aluminum swivel body.
- Teflon swivel seal.
- Viton seals.

Options

- Without swivel.
- Sightglass.
- Compatibility with special chemicals.

Consult Scully for part numbers

Flow Rates

- Used for deliveries up to 200 G.P.M.

Inlet Style	Inlet Thread	Outlet Thread	Part #
5 P.S.I. FEMALE	1 1/2"	1 1/2" Female NPT	05917
5 P.S.I. FEMALE	2"	2" Female NPT	05924

Super Nozzle Tightfill Hose Swivels

Increased Hose Flexibility and Freedom of Movement

- Advanced ball bearing design allows for easy rotation at all operating pressures.
- Teflon high recovery seal and shielded bearings for optimum field performance.
- No nipple required to attach hose with male style swivels.
- Lightweight aluminum and zinc construction.
- Wide variety of liquid product use.



Female Super Nozzle Swivel



Male Super Nozzle Swivel

Inlet Style	Inlet Pipe Size	Male Outlet Thread	Part #
FEMALE	1 1/2"	COM-B	05824
FEMALE	2"	COM-B	05826
MALE	2"	COM-B	05862

COM-B outlet thread screws directly into the Super Nozzle body only.

Scully Truck Equipment

Super Nozzle Replacement Parts

Only genuine Scully replacement parts will ensure proper operation and prevent liabilities associated with spills.

Description	Part #
Sight Glass - photo A	05420
O-Rings for Nozzle Connector (Qty.3)- photo B	04318
Anti-Drip valve, 5 P.S.I. (Qty.5)- photo C	11733
Kit Handle & Latch Assembly (Qty.5)- photo D	11603
Nozzle Rebuild Kit- photo E	05934
Handle Upgrade Kit- photo F	11604
Seal kit, no swivel parts- photo G	05933
Seal kit, to repair two swivels for Super Nozzle- photo H	05860

Note: Handle & Latch Replacement parts for Early Super Nozzles pre 1981 are available. Contact Scully for details.

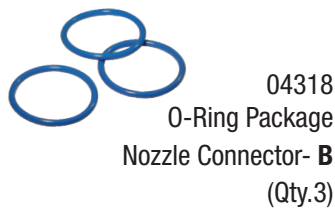

05934 Nozzle Rebuild Kit- E



- Self Locking Screw
- Control Rod Washer
- Zinc Plated Screw (3)
- Bushing
- Control Rod Shim
- Plated Ball
- Retainer
- 11603-Handle & Latch Assembly Kit**
- Curved Washer
- Control Rod
- Viton O Ring
- Viton O Ring (4 Sizes)
- Seat
- Thrust Washer
- Wave Washer
- 11733 Complete Anti-Drip Valve Assembly**

11604 Handle Upgrade Kit- G

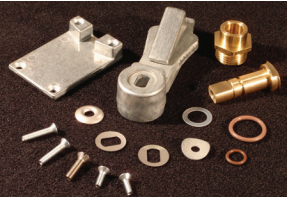

- Control Rod Washer
- Curved Washer
- Control Rod Shim
- Viton O Ring (2 Sizes)
- Screw-Self Locking
- Control Rod
- Viton O Ring
- Bushing
- Zinc Plated Screw (4)
- 11603-Handle & Latch Assembly Kit**

05933 Nozzle Seal Kit- G

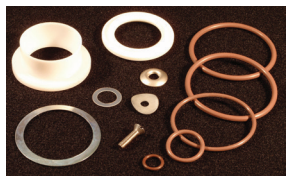

- Self Locking Screw
- Control Rod Washer
- Curved Washer
- Retainer
- Shim-Control Rod
- Seat
- Viton O Ring (4 Sizes)

05860 Seal Kit, Swivels for Super Nozzle- H



- Viton O Ring
- Felt Washer
- Radial Bearing Assembly
- Front Bearing Washer
- Thrust Bearing
- Rear Bearing Washer
- Retaining Ring

NPT Nozzle Hose Swivels

Increased Hose Flexibility, Reliability and Freedom of Movement

- Advanced ball bearing design allows for easy rotation at all operating pressures.
- Teflon high recovery seal and shielded bearings for optimum field performance.
- No nipple required to attach hose with male style swivels.
- Lightweight aluminum and zinc construction.
- Wide variety of liquid product use.



Inlet Style	Inlet Pipe Size	Male Outlet Thread	Part #
FEMALE	1 1/4"	1 1/4" Male NPT	05817
FEMALE	1 1/4"	1 1/2" Male NPT	05818
FEMALE	1 1/2"	1 1/4" Male NPT	05819
FEMALE	1 1/2"	1 1/2" Male NPT	05820
MALE	1 1/4"	1 1/4" Male NPT	05863
MALE	1 1/2"	1 1/4" Male NPT	05866
MALE	1 1/2"	1 1/2" Male NPT	05867
FEMALE	2"	2" Male NPT	05828
MALE	2"	2" Male NPT	05874

Spouts

For Loose Fill Tank Inlets

- Exclusive vacuum breaking grooves for easy and leak-free removal after fill operation.
- Made of non-sparking brass and aluminum material.
- Rugged 1/8" wall construction provides durable use.
- Model available for use with Unifil connector nozzles.



Thread Size	Length	OD	Material	Model #	Part #
1 1/4" NPT	8"	1.50"	BRASS	NS 204	06302
1 1/2" NPT	6.5"	1.90"	BRASS	NS 276	06303
FITS UNIFIL	8"	1.50"	ALUMINUM	UF 54	04334

Ventafil®

Portable Whistle-Stop and Fill Device for Underground Tanks

- Built-in anti-foam vents won't disturb sludge on the tank bottom while allowing for larger drops.
- Three-in-one unit means the driver carries only one piece.
- Fills to within 4" of the top of the tank.
- Fits 1 1/2" and 2" tank openings.
- Prevents spills and allows for product expansion.
- Available in 9", 36" or 50" lengths.

Fill Pipe Length	Inlet Connector	Model #	Part #
9"	UNIFIL	-	04828
36"	UNIFIL	VF 4814	04814
36"	2" Cam & Groove	-	04831
50"	UNIFIL	VF 4815	04815

Note: All Ventafil will accept 2" NPT male pipe threaded connections.



Scully Truck Equipment

Ventafil® Replacement Parts

Description	Part #
(A) UNIFIL 2" Adaptor	04332
(B) UNIFIL Cap	04316
(C) Cord & Lock Ring	04342
(D) Adaptor Gasket	11042
(E) Whistle	10308
(F) Whistle Gasket	10926
(G) Whistle Retaining Clip	10506
(H) Adjustable Plug Assembly	10925
(J) Relief Disk	10910
(K) Disk Holding Screw	50120
(L) Bearing Pad	10715
(M) Adjustable Plug Body	10949
(N) Thumb Screw	53100
(P) Stop Pad	11049
(Q) Nutplate	10909
(R) Screws w/ Locking Insert	50426

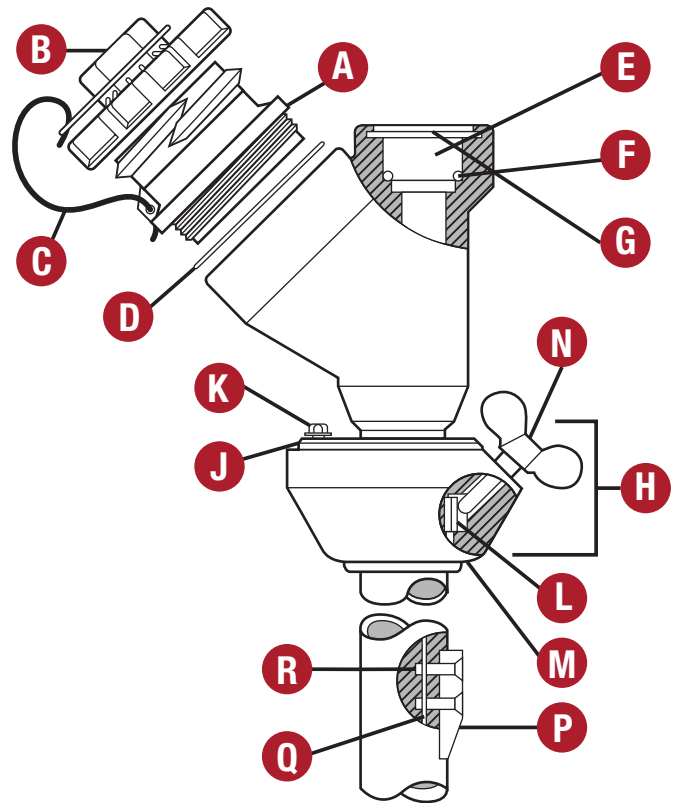

Mark V® Flow Switch Angle Check Valve

Automatic Flow Control

- Pumping rate is controlled from the nozzle to permit high pumping speeds and delivery control.
- Check valve required by weights and measures.
- Flow control switch and check valve combined in one unit.
- Reduces hose pressure at idled speed and eliminates damaging surge and shock pressures.
- Available with electric or air switch.
- Prevents hose reel movement.

Specifications

- Victaulic inlet & outlet for leak free connection.
- 1/4" gauge port.
- 20 amp normally open electrical switch. *(electric models only-not for gasoline use)*
- Less than 7 P.S.I. pressure drop at 100 G.P.M.
- 3 P.S.I. cracking pressure at zero flow.
- Viton poppet seal.

Model	Part #
MK V Air Victaulic X Victaulic	09520
MK V Electric Victaulic X Victaulic	09521

Replacement Part	Part #
Switch Housing - Electric	09554
Switch Housing - Air	09555
Poppet Valve Assembly & Seal Kit	09556



Mark IV® Flow Switch Angle Check Valve Automatic Flow Control

- Pumping rate is controlled from the nozzle to permit high pumping speeds and delivery control.
- Check valve required by weights and measures.
- Flow control switch and check valve combined in one unit.
- Reduces hose pressure at idled speed and eliminates damaging surge and shock pressures.
- Available with electric or air switch.*
- Prevents hose reel movement.

Specifications

- 1/4" gauge port.
- 20 amp normally open electrical switch (not for gasoline use).
- Less than 7 P.S.I. pressure drop at 100 G.P.M.
- 3 P.S.I. cracking pressure at zero flow.
- Viton poppet seal.

Inlet	Outlet	Switch	Model #	Part #
2" FEMALE	2" GROOVED	ELECTRIC	SM 1000	06818
2" FEMALE	2" GROOVED	AIR	SM 1100	06817

Note: Scully does not currently have a Mark IV version for electronic throttles.

Description	Model #	Part #
Air loss protection valve	SM 644	06870
Shuttle valve	SM 1053	06874
Electric conversion kit*, standard	SM 6830	06830
Air conversion kit*, standard	SM 6831	06831
Air switch	MK IV or MK V	11200
Poppet assembly	MK IV	11525
Viton Seal replacement kit	MK IV	11506
Air switch replacement kit	MK IV or MK V	11507
Electric switch for MK IV flowswitch	-	11508

* Conversion kits are complete units less the housing

Note: We recommend the use of an air filter-oiler and an air loss protection valve with any air operated Sculmatic system unless the truck's air system is already equipped with a safe, filtered and lubricated air supply.

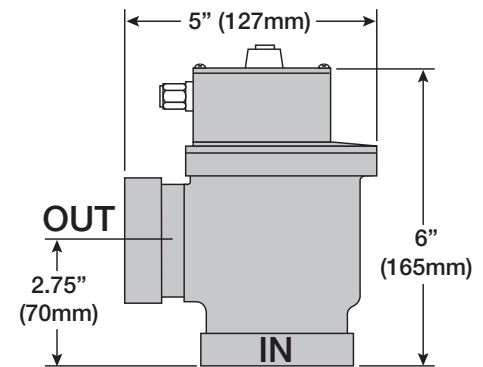

Flow Switch Angle Check Valve

Pumping Flow Control

- Equipped with hose pressure bleed.
- Viton poppet seal.
- Efficient and reliable unit.
- Easily upgraded to Mark IV.

Specifications

- 1/4" Gauge port.
- Less than 3 P.S.I. pressure drop at 100 G.P.M.
- 1.5 P.S.I. cracking pressure at zero flow.



Inlet	Outlet	Model #	Part #
2" NP	2" GROOVED	SM 1200	06819

Note: The angle check valve can be modified to perform additionally as a flow switch. The unit has a 1/4" tapping on the inlet side for a pressure gauge or other use. It also has a hose pressure bleed valve as explained in the Mark IV specifications.

Scully Truck Equipment

Sculmatic® 12 Volt Electric/Air Throttle Actuators For Air System Vehicles

- Stainless steel cable and flexible rubber outer case for easy movement and non-rusting operation.
- 1" and 3" stroke models with high pulling power.
- Uses the existing truck air system, no additional air line from the flow control to the actuator required.
- Constant operation with air loss protection.
- Easy installation.



Description	Model #	Part #
1" Max Stroke	SM 677	06863
3" Max Stroke	SM 682	06865

Kit includes 29" long cable, all attachment parts, fuse, air loss protection valve, wire and fittings.

Sculmatic® Air Throttle Actuators For Air System Vehicles

- No electrical connection required.
- Stainless steel cable and flexible rubber outer case for easy movement and non-rusting operation.
- Uses the existing truck air system, no additional air line from the flow control to the actuator required.



Description	Model #	Part #
1" Max Stroke	SM 1057	06867
3" Max Stroke	SM 1058	06868

Kit includes 29" long cable, all attachment parts, manual on-off control valve and fittings.

Scully Tank Equipment

Scully Tank Fill Signals

The Original Tank Fill Whistle Alarms

Scully tank fill signals are the original whistle-stops. They whistle when the tank is filling. When the whistle stops, the tank is full. The calibrated whistle stems allow for product expansion and may be cut for flat style tanks. A patented screen keeps the whistle chamber free from pipe scale and bugs. Scully fill alarms stop costly spills and prevent ruptured tanks while improving your delivery efficiency. They are completely reliable and accurate. A one time installation usually outlasts the life of the tank. Models are available for most every type of tank installation.

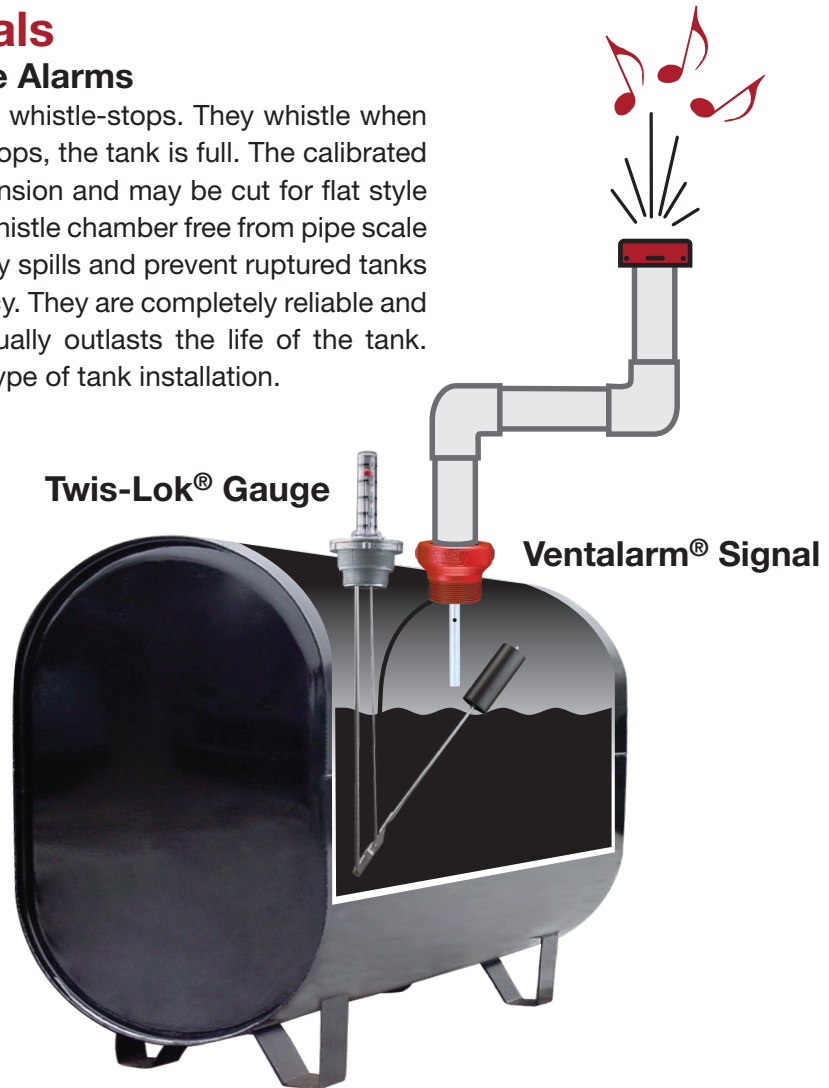

Ventalarm® Signals

The First and the Finest

- Since 1936! The original Ventalarm tank fill signal is built to last.
- Used for above and below ground tanks.
- Version for a 90° pipe elbow available.

Tank Opening	Vent Pipe	Model #	Part #
1 1/4"	1 1/4"	VS 201	00201
1 1/2"	1 1/2"	VS 202	00202
1 1/2"	1 1/4"	VS 240	00208
2"	1 1/4"	VS 521	00215
2"	1 1/2"	VS 530	00216
2"	2"	VS 270	00209
1 1/4" (90° Elbow)	1 1/4"	VS 230	00227
2"	2"	*16 1/2" - up to 2,000 gal.	00272
2"	2"	*21 3/4" - greater than 2,000 gal.	00274
2"	2"	For 275 gal. vertical and flat tanks	00275

**For cement vaulted tanks*



Scully Tank Equipment

Compression Ventalarm® Signals

The Whistle-Stop for Existing Installations

- Installs without removing the existing vent pipe.
- Special leak-proof fitting joins and seals Ventalarm to pipe.
- No threading or additional fittings required.



Tank Opening	Vent Pipe	Model #	Part #
1"	1"	VS 224	00205
1 1/4"	1 1/4"	VS 220	00203
1 1/4"	1"	VS 221	00204
1 1/2"	1 1/2"	VS 229	00207
2"	2"	VS 275	00213
Gasket Kit	1"	VS 224/221	10269
Gasket Kit	1 1/4"	VS 220	10266
Gasket Kit	2"	VS 275	10328

Note: Compression Ventalarm Signals are not for use in underground tanks.

Remote Ventalarm® Signals

Whistle-Stop for Vents Distant from Fill Pipe

- Whistle-Stop installs near fill pipe.
- Uses a special intrusion stem and weighted vent cap.
- Large tank versions available for heavy oils.
- Weighted vent cap needed to maintain proper air flow through whistle.

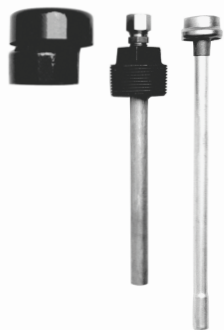
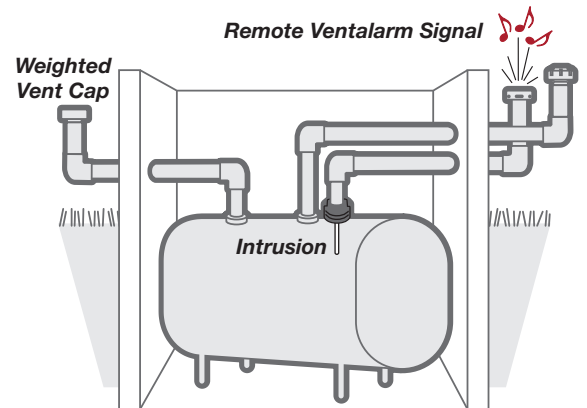

Remote Ventalarm Signals

Tank Opening	Vent Cap	Model #	Part #
1 1/4"	1 1/4"	VS 921	00219
1 1/4"	2"	VS 924	00221
*Special	1 1/4"	VS 926	00223

**Fits into hole drilled into tank when no opening is available.*



Large Tank Remote Ventalarm Signals

Description	Model #	Part #
Vent cap, 2" pipe, heavy duty	VC 127	00255
Intrusion, 2" thread	VC 113	10059
Whistle signal, 3/4" line	VC 153	10071
Complete assembly	VC 119	00233

Large tank remote signals require a 3/4" line for heavy oils - not supplied by Scully.

Remote signals require 3/8" copper tubing to connect to whistle - not supplied by Scully.

Scully Tank Equipment

Vent Caps

Description	Model #	Part #
Vent cap, 1 1/4" die cast	VC 547	00267
Vent cap, 1 1/4" weighted	VC 910	00262
Vent cap, 2" heavy duty	VC 127	00255
Vent cap, 2" unweighted	VC 921	00260



Whistler® Fill Signal

Retrofits into the Internal end of the Vent Pipe

- Economical unit installs with special tool into the vent pipe.

Description	Model #	Part #
1" Vent Pipe	WL 170	00401
1 1/4" Vent Pipe	WL 100	00402
1 1/2" Vent Pipe	WL 101	00403
2" Vent Pipe	WL 102	00404
Installation Tool	WL 140	00412



Whistler Installation Tool

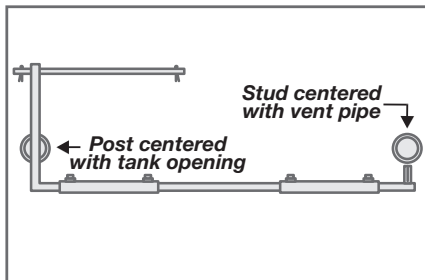

Whistler Installation

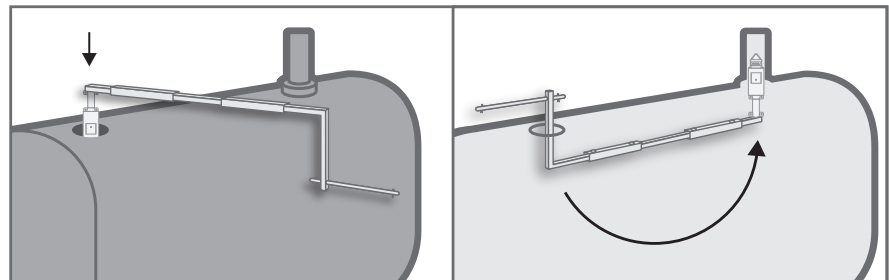

Sculclamp® Compression Pipe Couplings

Make Tank Replacement Fast and Easy

- Lets you replace a tank without removing fill and vent pipes.
- Rugged design makes pipe connections secure and leak free.
- Gaskets keep any fumes from leaking.

Description	Model #	Part #
1 1/4" Sculclamp Pipe Coupling	AF 251	01116
1 1/2" Sculclamp Pipe Coupling	AF 252	01117
2" Sculclamp Pipe Coupling	AF 253	01122

Note: Not intended for underground use.

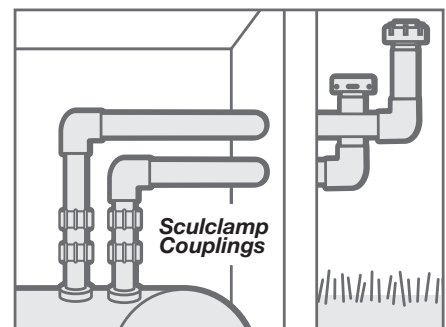

Scully Tank Equipment

Golden Gallon Gauges®

Double Float Tank Gauge for Indoor, Outdoor and Buried Tanks

- Kevlar string for smoother operation.
- Unique polypropylene double float design.
- Measurement readings available in gallons or inches.
- Large numbered, easy-to-read window has an anti-fogging vapor barrier.
- Most accurate gauge of its kind.
- Installs easily in 1 1/2" and 2" openings.
- Accommodates tank depths to 108".
- Used in a variety of liquid products.
- Perfect for will call accounts.
- The standard in lube oil and waste oil tanks.

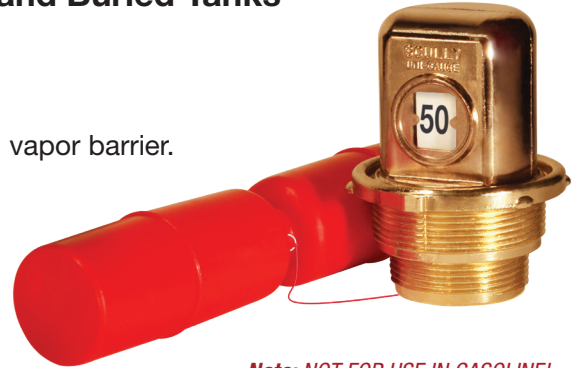

Note: NOT FOR USE IN GASOLINE!

Golden Gallon Gauges® Read in Inches

Model Size	Part #
22" depth	03130
24" depth	03129
30" depth	03126
32" depth	03125
34" depth	03124
36" depth (w/1 1/4" ext.*	
Convault D500 and 1000)	03207
36" depth	03123
36" depth, 16th inch increments	03178
38" depth	03122
40" depth	03121
42" depth	03120
44" depth	03119
46" depth	03118
47" depth	03144

Model Size	Part #
48" depth	03117
50" depth	03116
52" depth	03115
54" depth	03114
56" depth	03113
60" depth	03111
60" depth w/ 6" extension	03146
60" depth w/ 4" extension	03145
62" depth	03186
64" depth	03187
66" depth	03188
70" depth	03190
72" depth	03139
108" depth	03197

**Extensions are for cement, double wall, vaulted tanks.*

Golden Gallon Gauges® Read in Gallons

Model Size	Part #
158 gallon-Highland, 60" depth	03173
192 gallon-Highland, 72" depth	03174
245 gallon, 48" depth	03177
270 gallon, 36" depth	03162
275 gallon, 44" depth	03101
275 gallon, 42" depth	03102
275 gallon, 27" depth	03105
300 gallon, 60" depth	03175
325 gallon, 39" - 43" depth	03163
330 gallon, 43" depth	03157
500 gallon, 26" depth w/ 1 1/4" ext.*	03180
500 gallon, 65" depth	03176

Model Size	Part #
520 gallon, 48" depth	03158
550 gallon-Twin 275s, 44" depth	03171
560 gallon, 48" depth	03159
1,000 gallon, 36" depth w/ 1 1/4" ext.*	03179
1,000 gallon, 48" depth	03160
1,000 gallon, 49.5" depth w/ 1 1/2" ext.*	03195
1,000 gallon, 50" depth w/ 1 1/4" ext.*	03184
1,000 gallon, 60" - 64" depth	03161
1,000 gallon, 47" depth w/ 1 1/4" ext.*	03191
2,000 gallon, 60" - 64" depth	03165
2,000 gallon, 48" depth w/ 1 1/4" ext.*	03193

**Extensions are for cement, double wall, vaulted tanks.*

Note: Consult Scully for additional gallon & inch reading models. Some Golden Gallon Gauges are available in liters and/or centimeters, please consult Scully. Extension length is the height from bottom of gauge to top of tank. Inch reading gauges available in 2" increments from 12" to 108". Fractional and custom lengths also available. Consult Scully for part numbers. Not intended for use as an overflow prevention device. Gauge is calibrated at the factory and should not be recalibrated in the field. Do not install prior to tank shipment. Remove gauge prior to shipment with tote tanks.

Delivery Efficiency Equipment

Scully Tank Equipment

Ventalarm® Gauges

The Original Combination Whistle Alarm and Level Indicator

- One unit fill alarm and level indicator saves installation costs.
- Protects against spills.
- Durable construction known to outlast the competition and life of the tank.

Note: ULC Approved (No Gasoline)

Tank Opening	Vent Pipe	Tank Depth	Model #	Part #
1 1/2"	1 1/4"	22" - 24"	VG 125	01401
1 1/2"	1 1/4"	26" - 27"	VG 125	01402
1 1/2"	1 1/4"	42" - 44"	VG 125	01406
2"	1 1/4"	22" - 24"	VG 126	01408
2"	1 1/4"	26" - 27"	VG 126	01409
2"	1 1/4"	37"	VG 126	01412
2"	1 1/4"	42" - 44"	VG 126	01413
2"	1 1/2"	26" - 27"	-	01444
2"	1 1/2"	42" - 44"	-	01445
2"	2"	26" - 27"	-	01455
2"	2"	42" - 44"	-	01456
Replacement Vial and Gasket for all models				10159



Twis-Lok® Gauges

The Tank Gauge with Removable Cap

- Two piece construction for easy installation.
- Design helps prevent breaking the float arms.
- Rain shed design suitable for outdoor use.
- One unit fits both 1 1/2" and 2" tank openings.
- Made from non-rusting materials.

Tank Depth	Model #	Part #
22" - 24"	Twis-Lok® Gauge	01441
26" - 27"	Twis-Lok® Gauge	01442
42" - 44"	Twis-Lok® Gauge	01443
47"	Twis-Lok® Gauge	01447
Replacement Vial and Gasket for all models		10159

Econ-O-Gages®

The Low Priced Level Indicators

- Inexpensive and accurate level indicator.
- Large variety of sizes to fit most tanks.
- Leak-proof construction with non-rusting zinc casting.
- Dual bushing fits both 1 1/2" and 2" tank openings.

Tank Depth	Model #	Part #
22" - 24"	EG 217	01424
26" - 27"	EG 216	01421
30"	EG 220	01434
37"	EG 218	01425
40"	EG 221	10135
42" - 44"	EG 215	01422
47" - 48"	EG 222	01436
64"	EG 223	01439
Replacement Vial & Gasket for all models		10159



Scully Tank Equipment

Snorkel® Gauges

The Level Indicators with a Floating Burner Feed Line

- Takes clean, dry fuel from 1" below the surface.
- Ends ice and sludge clogged fuel lines.
- Provides a return line opening.
- Ideal for low burner firing rates.
- Two piece assembly makes installation easier.
- One unit fits both 1 1/2" and 2" tank openings.

Tank Depth	Model #	Part #
26" - 27"	TS 121	01415
42" - 44"	TS 120	01416
Replacement Tube	27"	10544
Replacement Tube	44"	10543
Replacement Vial & Gasket for all models		10159



Portable Water Detector & Level Sensor For Fast and Accurate Water Presence and Level Detection

The Scully Water Detector is the perfect unit to keep on hand when checking water levels in fuel tanks. It is lightweight and portable with a sensor head small enough to fit into most tank openings. Aside from above and below ground tanks, the water detector is used in boat tanks and bilges, underground wiring tunnels and more. It's a sure fire alert to the presence of water and accurate in determining volume.

- Can be used in gasolines, jet fuels, fuel oils #1- 4, diesel and ethanol gasoline blends.
- Approved by CSA as intrinsically safe for use in hazardous locations.
- Sounds an audible alarm when it touches water.
- Eliminates the need for a paste stick.
- Lightweight and battery operated.
- As easy to use as a drop line.
- 7/8" probe diameter.
- Zinc alloy housing.
- PVC cable jacket.
- Brass sensor.
- 3 lbs.



Description	Length	Part #
WB 100 G	25' (7.6m)	08019
WB 100 G Probe & Cable Only	25' (7.6m)	21326
9 Volt Eveready 216 Battery		26903

Scully Unifil® Equipment

Scully Unifil Tightfill Connections For Fast, Leak-Proof Deliveries

- Allows for higher pumping speeds.
- Reduces liabilities due to spills.



Description	Model #	Size	Part #
45° ADAPTOR			
Male & Female. Ideally suited in cases where the fill pipe is very close to the wall.	Female UF-41	1 1/4"	04324
	Female UF-44	1 1/2"	04325
	Female UF-47	2"	04328
	Male UF-152	1 1/2"	04352
	Male UF-151	2"	04351

STRAIGHT ADAPTOR

Male & Female. Used when replacing a pipe plug for 1 1/4", 1 1/2" and 2" fill pipes.

Female UF-65	1 1/4"	04336
Female UF-65C	1 1/4" cored	04337
Female UF-66	1 1/2"	04338
Female UF-66C	1 1/2" cored	04339
Female UF-67	2"	04340
Female UF-67C	2" cored	04341
Male UF-15	1 1/4"	04311
Male UF-16	1 1/2"	04312
Male UF-16C	1 1/2" cored	04313
Male UF-17	2"	04314
Male UF-17C	2" cored	04315



ALL-WEATHER CAP

This cap fits the top of all Scully straight and 45° adaptors and features a new heavy weight design. No gasket is necessary.

UF-21	Fits All Scully Straight and 45° Adaptors	04316
-------	---	-------

MALE SHOULDER ADAPTOR

Specially designed for installation in an existing fill box or coupling, or in any applications where a good watershed is desired around the joint. Available in 2" IPS size with standard threads (50S).

UF-50S	2" S	04332
UF-50SC	2" S cored	04385



NOZZLE CONNECTOR

Installed on the nozzle outlet, it incorporates a hex opening which matches the hex on Scully's all weather caps. It is all you need to complete the Unifil Tightfill Connection System. Look for the Scully name to make sure you're getting a quality Scully nozzle connector.

UF-37	1 1/4" NPT	04323
UF-46	1 1/2" NPT	04327
UF-122	Special threads for Sculflow Nozzle	04346





O-RING PACKAGE (Qty.3)

The nozzle connector O-ring is fabricated from a high cost compound for maximum life. The O-ring can be easily replaced with a nail file, penknife or pencil on the job if necessary. We suggest a package of the O-rings be carried in the glove compartment of the cab. (Qty.3)

UF-32V	Flourosilicone	04318
--------	----------------	-------



Scully Unifil® Equipment

	Description	Model #	Size	Part #
	<p>INSERT WRENCH</p> <p>This may be used at installations where the sunken fill box does not permit use of the flush insert connector for tightening or loosening the flush insert cap.</p>	UF-327	-	04360
	<p>HEX DRIVER</p> <p>One side of the hex driver is used to install all standard adaptors by inserting the adaptor and turning against the internal lugs. The other side is used for installation of flush insert adaptors.</p>	UF-309	-	04355
	<p>SPOUT</p> <p>This accessory spout quickly attaches to the nozzle connector. It is used for troublesome fills or where a loose connection is desired.</p>	UF-54	UNIFIL	04334
		NS 204	1 1/4" x 8"	06302
		NS 276	1 1/2" x 6.5"	06303
	<p>FLUSH BOX COVER</p> <p>This vertical decorative cover mounts on the house siding to hide the fill pipe. Louvres are built to provide venting and shelter from rain.</p>	UF-339	1 1/2"	04362
	<p>FLUSH INSERT ADAPTOR</p> <p>It is used with sidewalk or other flush fills and designed to insert into the existing fill box. It can be adapted to worn pipe threads by using one of three sizes: standard (S, coded blue), large (L, coded green) and extra-large (XL, coded red).</p>	UF-10S	2" S-NY	04303
		UF-10L	2" L-NY	04301
		UF-XL	2" XL-NY	04304
	<p>FLUSH INSERT CONNECTOR AND WRENCH</p> <p>Used only when making a tight connection to the Unifil flush insert adaptor. It turns quickly into the flush insert adaptor, then the nozzle connector is rapidly attached to the nozzle. The projections on the side act as a wrench to tighten or loosen the flush insert cap.</p>	UF-306	-	04358
	<p>FLUSH INSERT CAP</p> <p>This cap is designed for use with the flush insert adaptor and acts as an effective watershed. It is ideal for use in areas where flush characteristics are important. Because of its use in sunken fill boxes, this cap is supplied with a special, non-swelling gasket.</p>	UF-22	2" NY	04317
	<p>CAP IDENTIFICATION DISCS</p> <p>API color coded symbol styles for #2 fuel oil used for fill pipe identification. Company name and phone number. Installs easily in Scully all weather and flush fill caps.</p>	Name/#	300 Pcs.	04343
			500 Pcs.	10720
			1000 Pcs.	10719



Delivery Efficiency Equipment

Notes:

scully



Scully Signal Company

70 Industrial Way, Wilmington, MA 01887, USA

800 272 8559 • 617 692 8600

sales@scully.com

www.scully.com



Copyright © 2015 Scully Signal Company. Dynacheck, Dynamic Self-Checking, Dynamic Self-Testing, Faylsafe, Golden Gallon, IntelliCheck, Intellitrol, Mark IV, Sculclamp, Sculflow, Sculmatic, Twis-Lok, Unifil, Ventafil, Ventalarm, V.I.P. and Whistler are registered trademarks of Scully Signal Company. All Rights Reserved. Specifications are subject to change without notice.

60593_Complete System Rev B

November 2015