

COMBUSTION CHAMBER KITS

Heating Season
2013/2014



BOARD BLANKET PAPER STRIP ROPE GASKET CEMENT

www.lynnmfg.com

High Temperature Insulation

Index	Page
Replacement Chamber Kits	2-3
Quickies & TimeSavers	4
Kaowool Boards	4
Wet Blankets	4
Kaowool Blankets & Strips	5
Kaowool Rope	5
Ceramic Fiber Paper	6
Gaskets	6
Insulating Fire Brick	7
Industrial Products	7
Tank Gauges	8
Accessories	8



Perfect Fit Replacement Kits
For 500+ Makes & Models of Boiler/Furnaces



Huge Inventory
Everything in Catalog is Stocked



Same Day Shipment on UPS Orders
2:30 EST Cut Off Time



Great Technical Support
781-593-2500 TechSupport@LynnMfg.com

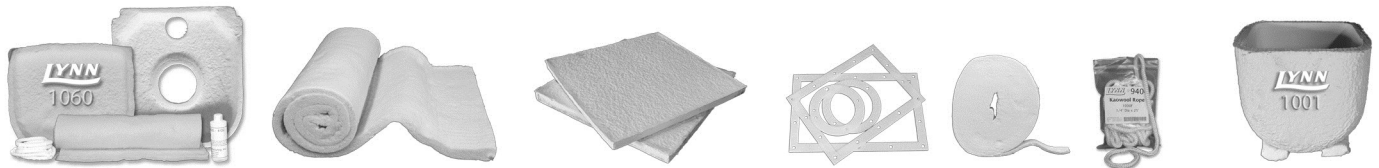

TERMS & CONDITIONS:

Terms: Net 30 Days

Freight: 50 Pieces = Free Freight (East of the Rocky Mountains). Items under \$15 trade do not qualify.

Minimum: None

Shipping Damage & Shortages: Must be noted on the freight bill at time of delivery.

Returns: Must be authorized before shipment. A restocking fee of 20-30% will be charged depending on the condition of product. Wet products can not be returned after 1 year.

Guarantee: Any Product found to be defective in material or workmanship will be replaced free of charge, if unused and within one year of purchase. This shall be Lynn Manufacturing, Inc. maximum liability.

SALES POLICY

Lynn Manufacturing, Inc. sells only to wholesalers or original equipment manufacturers.

RESTRICTION OF PRODUCT USE:

The products shown in this catalog are "for professional use only" and not for use by the general public. They are for use in servicing heating equipment by a trained, qualified technician familiar with such systems, equipped with the proper tools and equipment, familiar with all governing codes and ordinances, and licensed by the proper authorities.

MAILING ADDRESS:

15 Marion Street Lynn, MA 01905

COMBUSTION CHAMBER REPAIR SOLUTIONS

Replacement Chamber Kits

- Perfect fit molded chambers
- Everything you need for the job in one box
- Kits for 500+ makes and models
- New kits added every year
- Technical support available for “odd ball” units

Wet Base Boilers

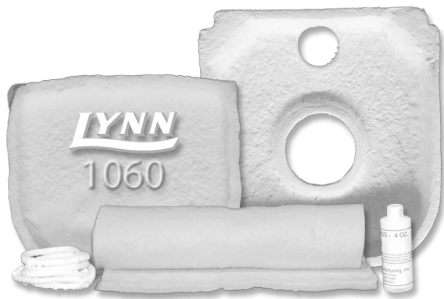

Kit Contains (if required)

- Molded Ceramic Fiber Front Refractory
- Molded Ceramic Fiber Rear Refractory (may be wet or dry depending on access)
- Dry Ceramic Fiber Blanket for Base Liner
- Waterglass
- Hardware
- Rope or Copeseal
- Complete Instructions

Dry Base Boilers



Kit Contains (if required)

- Molded Ceramic Fiber Combustion Chamber
- Refractory Cement
- Hardware
- Complete Instructions



Warm Air Furnaces



Kit Contains (if required)

- Molded Ceramic Fiber Combustion Chamber
- Hardware
- Gaskets
- Complete Instructions

Ready Reference List Contains Make and Model Information for over 500 boilers & furnaces. Found at www.LynnMfg.com.



Don't see what your looking for? Please call for technical support. 781-593-2500

List of All Kits on Page 3

Universal Combustion Chambers

- Universal Design Fits Many Makes and Models
- Many Sizes Available
- Complete Fit information available in our ready reference sheet

Quickies



Page 4

TimeSavers



Page 4

Custom Builds and Repairs

- Material to build a custom chamber or make a temporary repair.

Boards



Page 4

Dry Blankets



Page 5

Wet Blankets

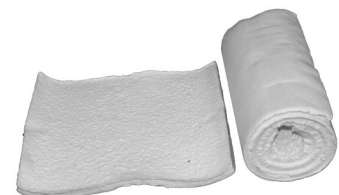

Page 4

REPLACEMENT CHAMBER KITS

Description	Fits	Item #	Description	Fits	Item #
Bard Furnace	See Ready Reference	1131	Miller/Nordyne M1	M1S & M1B	1141
Bryant Preferred	BW4 & BW5	1132	New Yorker #1	See Ready Reference	1102
Burnham C3 & C4	All	1074	New Yorker #2	See Ready Reference	1103
Burnham Fiesta	P-40, PH-40	1089	New Yorker #3	See Ready Reference	1106
Burnham Jubilee	230-260	1086	New Yorker CL	No Swing Out Door	1134
Burnham RS	RS & RSM - Not RSA	1107		Swing Out Door	1155
Burnham V-1	All	1064	New Yorker FR	See Ready Reference	1161-6
Burnham V-3	All	1065	Olsen Boiler	OSFH	1096
Burnham V-7	No Swing Out Door	1066	Olsen/Airco Furnace	9200C	1158
	Swing Out Door	1074	Peerless EC, ECT	All	1093
Burnham V-8	V-82 to V-86	1129	Peerless JO/JOT	All	1067
	V-87 to V-89	1130	Peerless WB, WV, WBV	All	1071
Columbia CS	CSF	1095	Pennco Keystone Water	Water	1105
	CSFH	1096	Pennco KSC Steam	Steam	1096
Constellation	All	1096	Repco BOS	85R, 100R, 115R	1061
Crown Bahama	No Swing Out Door	1108	Sears Kenmore 44	All	1105
	Swing Out Door	1133	Slant/Fin Liberty	See Ready Reference	1087
Crown Tabago & Kingston	TWZ & KSZ	1155		See Ready Reference	1094
Crane Series 70	All	1156	Slant/Fin Liberty II	See Ready Reference	1127
Dunkirk Empire	Water	1105		See Ready Reference	1128
Dunkirk Empire II	Water	1132	Slant/Fin XL2000	20, 30, 40, 50	1088
	Steam	1096	Slant/Fin Caravan Oil	All	1128
Dunkirk EV	DPFO 3	1075	Slant/Fin Intrepid	See Ready Reference	1127
	DPFO 3T to 5T	1073		See Ready Reference	1128
	DPFO 6T to 9	1076	Thermoflow	OWB, OWT, OSB, OST	1125
Electric Furnace-Man	OBT-5	1067	Ultimate K Series	See Ready Reference	1082-5
HB Smith #8	No Swing Out	1104	Ultimate PFO	PFO 3	1075
	Swing Out Door	1153		PFO 3T-5T	1073
HB Smith FD-12	All	1068		PFO 6T-9	1076
Hydrotherm MO	See Ready Reference	1077	Utica Starfire II	All	1095
	See Ready Reference	1078	Utica Starfire III	All	1096
Hydrotherm OR	See Ready Reference	1077	Vaillant F70	40, 45, 50, 55	1117
	See Ready Reference	1078	Vaillant F75	40, 45, 50, 55	1117
Hydrotherm PB	No Swing Out	1104	Vaillant F100	30, 40, 50, 60	1119
	Swing Out Door	1153	Weil-Mclain 65 Series	All	1101
Lennox Conservator	COWB	1105	Weil-Mclain 66, 68, 68V	All	1060
	COWB2	1132	Weil-Mclain 76, Series	All	1120
Memco SST	All SST Series	1112	Weil-Mclain 78/80	All 4" Burner Openings	1121
Memco CST	CSTO-3	1105		All 6" Burner Openings	1122
	CSTO-3T, 4, 4T, 5, 5T	1073	Weil-Mclain Gold	GO 2-8 Section	1072
	CSTO-6T, 7, 8T, 9	1076		GO 9 Section	1148
Miller/Nordyne CMF	CMF, MOC, MGC	1029	Williamson	OWB, OWT, OSB, OST	1126
Miller/Nordyne CMF2	CMF2	1141	Don't see what your looking for? Call 781-593-2500 for tech support.		

FOR COMPLETE INFORMATION ON MAKES AND MODELS USE READY REFERENCE SHEET

Quickie Combustion Chamber



Designed for Wet Base Boilers. Vacuum cast chamber made of pure 2300F ceramic fiber. Absorbs sound for quiet combustion. One piece installs quickly which saves times and money. Comes with complete instructions and soft kaowool strips.

Name	Dimensions	Firing Rate GPH	Item #
Quickie 100	11-1/2"W x 11"L x 10-3/4"H	0.75—1.25	1001
Quickie 200	12"W x 13-3/4"L x 12"H	1.35—1.75	1002
Quickie 300	12"W x 18"L x 12"H	1.75—2.25	1003
Mini Quickie	11"W x 10-1/4"L x 10-1/4"H	0.65—1.00	1004

Timesaver Combustion Chamber



Designed for Dry Base Boilers & Furnaces. Vacuum cast chamber made of 2300F ceramic fiber. Absorbs sound. Can be cut in half vertically for installation. Comes with Stainless bands and complete instructions.

Name	Dimensions	Firing Rate GPH	Item #
Time Saver 7	7-1/2"ID x 8-3/4"OD x 13-1/4"H	0.50—0.60	1007
Time Saver 9	9"ID x 10-1/2"OD x 14-1/4" H	0.65—0.85	1009
Time Saver 11	11"ID x 12-1/2"OD x 15-1/4"H	1.00—1.25	1011
Time Saver 13	13"ID x 14-1/2"OD x 14-3/4" H	1.35—1.75	1013
Time Saver 15	15"ID x 17"OD x 16" H	1.65—2.00	1015
Time Saver 2.25	17-1/2"L x 13"W x 16" H	1.75 - 2.25	1016
Time Saver 3.00	22"L x 14"W x 16"	2.25 - 3.00	1017

Kaowool Board



High density machine-able boards and thicker boards are available in the industrial section (page 7)

Rigid ceramic fiber board. Withstands temperatures up to 2300F. Applications include floors, walls, front-plates or target walls in combustion chambers. Easily cut with a knife or hacksaw and can be drilled.

Name	Dimensions	Boards/Ctn.	Item #
1/4" Board	36" x 24" x 1/4"	6	1028
1/2" Board	36" x 18" x 1/2"	4	1025
	36" x 24" x 1/2"	4	1026
3/4" Board	15" x 24" x 3/4"	2	1022
	20" x 20" x 3/4"	2	1023
	36" x 18" x 3/4"	2	1024
1" Board	20" x 20" x 1"	2	1019
	36" x 18" x 1"	2	1020
	36" x 24" x 1"	2	1021
1.5" Board	36" x 24" x 1.5"	1	1062
2" Board	36" x 24" x 2"	1	1063

Wet Kaowool Blankets



Soft & moist ceramic fiber blanket that can be formed to the shape of an existing chamber as a liner. Hardens when fired. Manufactured with a special process that prevents bacteria growth while in plastic bag. Full 1/2" thick. 2300F.

Name	Dimensions	Item #
Kit A	(1) - 14" x 48" x 1/2"	1032
Kit B	(1) 14"x48"x1/2" & (1) 14"x16"x1/2"	1033
Kit C	(1) 16"x48"x1/2" & (1) 16"x16"x1/2"	1034
24" Wet Blanket	(1) 36" x 24" x 1/2"	1035
18" Wet Blanket	(1) 36" x 18" x 1/2"	1036

Kaowool Rope



2000F Rope can be found in industrial section (page 7)

Excellent Gasket Material. Can be used between boiler sections, boiler doors and packing around burner tubes and heads. Can withstand 1000F. Each package contains 25 feet in a re-sealable plastic bag.

	Name	Dimensions	Item #
1000F Rope	1/4" Rope	1/4" OD x 25'	9404
	3/8" Rope	3/8" OD x 25'	9400
	1/2" Rope	1/2" OD x 25'	9401
	3/4" Rope	3/4" OD x 25'	9405
	1" Rope	1" OD x 25'	9406
	1-1/4", 1-1/2" & 2" 1000F Rope Can be found in industrial section		
Self Adhesive & High Density Rope. Same rope that comes in our combustion chamber kits. 1000F.			
Self-Adhesive	3/16" Self Adhesive	3/16" OD x 25'	9407
	3/8" Self Adhesive	3/8" OD x 25'	9408
	1/2" Self Adhesive	1/2" OD x 25'	9409

Dry Kaowool Blankets



Soft ceramic fiber blanket that can be formed to the shape of an existing chamber. Used to line steel and hard brick chambers. Withstands 2300F.

	Name	Dimensions	Item #
Short Blankets	1/4" Dry Blanket	60 x 24" x 1/4"	9452
	1/2" Dry Blanket	48" x 16" x 1/2"	9451
	3/4" Dry Blanket	56" x 14" x 3/4"	9450
	1" Dry Blanket	48" x 18" x 1"	9449
Mid-Size	1/2" Dry Blanket	100 x 24" x 1/2"	9454
	1" Dry Blanket	100 x 24 x 1"	9453

Many Larger Blankets Available in Industrial Section (Page 7)

Kaowool Strips

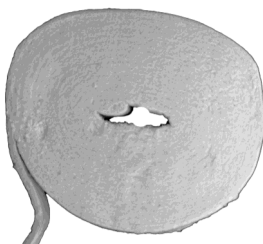

Soft ceramic fiber blanket strips commonly used as gasket material. Withstands 2300F. Packaged in master cartons of 6 strips. Bagged and labeled for individual re-sale.

	Name	Dimensions	Item #
	1/4" Strip	240" x 1" x 1/4"	9505
	1/2" Strip	300" x 1" x 1/2"	9506
	1" Strip	150" x 2" x 1"	9500
	1" Strip	150" x 3" x 1"	9504

Ceramic Fiber Paper

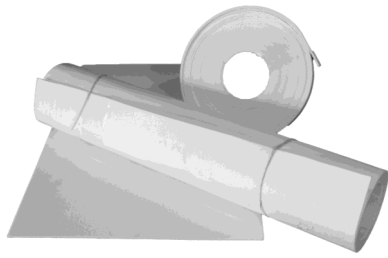

Larger Sizes and other thicknesses available in the industrial section

Ceramic Fiber Paper is commonly used for gaskets or thermal barriers. Available in a premium 2300F material or utility grade 1500F material. Each material is available in sheet, roll or strip form.

Name		Dimensions	Item #
2300F Ceramic Fiber Paper	Small Sheets	15" x 24" x 1/8" (4 sheets per pkg.)	9600
	Small Rolls	24" x 100" x 1/8"	9601
	Strips	1" x 200" x 1/8"	9602
1500F Ceramic Fiber Paper	Small Sheets	15" x 24" x 1/8" (4 sheets per pkg.)	9650
	Small Rolls	24" x 100" x 1/8"	9651
	Strip	1" x 200" x 1/8"	9652

Flat Rope / Fiberglass Tape



Soft woven tape commonly used for gasketing. Withstands 1000F.

Name	Dimensions	Item #
1/8" Tape	25' x 1" x 1/8"	9460
1/8" Tape—Spool	100' x 1" x 1/8"	9461

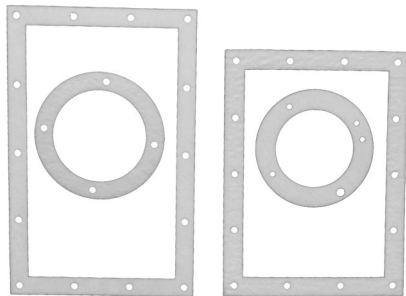

Miller-Nordyne Mobile Home Gaskets



Specifically made to fit Miller mobile home furnaces. Sold in kits of four and separately in packages of 20. Gaskets available for CMF, MOC, MGC, M1 & CMF2

		Dimensions & Contents	Item #
CMF MOC & MGC Models	Miller Gasket Kit	Burner Gasket—#3001-000 Flue Gasket—#3001195-000 Pouch Gasket—#3001181-000 Burner Plate—#301205-000 1 each/ctn.	9510
	Burner Gasket	Pcs 6-1/2"OD x 4-3/8"ID 20/ctn.	9511
	Flue Gasket	Pcs 7-1/16"ODx5-1/8"ID 20/ctn.	9514
	Pouch Gasket	Pcs 10" x 13-1/2" 20/ctn.	9512
	Burner Plate Gasket	Pcs 10-1/4" x 16" 20/ctn.	9513
	Hi-Temp Burner Plate	Pcs 10-1/4" x 16" 10/ctn.	9525
M1 & CMF2	Gasket Kit	Chamber Gaskets 2/ctn. Burner Gasket 1/ctn.	9527

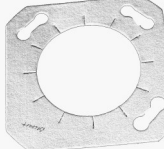
GASKETS

 <p>Universal Burner Flange Gasket (20) Pcs per Bag Replaces Beckett Part #3616 <u>Item:</u> 9550</p>	 <p>Beckett Burner Flange Gasket (20) Pcs per Bag Fits Beckett #68 Burner Flange <u>Item:</u> 9551</p>
 <p>Riello Burner Flange Gasket (20) Pcs per Bag Fits All Models <u>Item:</u> 9560</p>	 <p>Duomatic Clean Out Gasket (20) Pcs per Bag 3" OD x 2" ID <u>Item:</u> 9515</p>

Insulating Fire Brick

Insulating Fire Bricks are manufactured with a unique slurry casting process which creates a network of micro porosity that produces low thermal conductivity and good thermal shock characteristics.

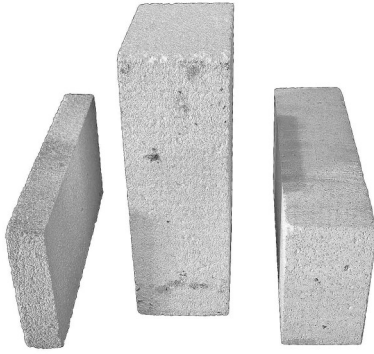

Name	Firing Rate (GPH)	Full Bricks	3" Bricks	Splits
		9" x 4.5" x 2-1/2" (12 Per Ctn.)	9" x 4.5" x 3" (10 Per Ctn.)	9" x 4.5" x 1-1/4" (20 Per Ctn.)
Item #	Item #	Item #	Item #	Item #
K-23 (2300F)	3-5	IFK23A2	IFK23A3	IFK23A1
K-26 (2600F)	6-15	IFK26A2	IFK26A3	IFK26A1
JM-28 (2800F)	16-25	IFJ28A2	IFJ28A3	IFJ28A1
JM-30 (3000F)	25+	IFJ30A2	IFJ30A3	IFJ30A1

INDUSTRIAL PRODUCTS



Kaowool Blanket—Full Rolls

For smaller sizes, see page 4. Refractory Ceramic Fiber Blankets provide excellent insulating properties, high temperature stability & resistance to chemical attack.

Name	Dimensions	Rolls/Ctn	Item #
1/4"	240" x 24" x 1/4"	4	8KAK2
	240" x 48" x 1/4"	4	8KAK4
1/2"	600" x 24" x 1/2"	1	6KAL2
	600" x 48" x 1/2"	1	6KAL4
1"	300" x 24" x 1"	1	6KR12
	300" x 48" x 1"	1	6KR14
1.5"	180" x 24" x 1-1/2"	1	6KRV2
	180" x 48" x 1-1/2"	1	6KRV4
2"	150" x 24" x 2"	1	8KR22
	150" x 48" x 2"	1	8KR24

Kaowool "M" Board

High density, machine-able, & close tolerance board. For smaller sizes general duty boards, see page 4. Please call for additional sizes and specialized grades.

Name	Dimensions	Boards/Ctn.	Item #
1/4"	36" x 24" x 1/4"	24	BPMK23
1/2"	36" x 24" x 1/2"	12	BMML23
1"	36" x 24" x 1"	6	BMM123
1.5"	36" x 24" x 1-1/2"	4	BMM923
2"	36" x 24" x 2"	3	BMM223

Ceramic Fiber Paper—Large Rolls

Smaller sizes available on page 5. Please call for specialty grades and mill rolls

Name	Dimensions	Item #
1/16"	100' x 24" x 1/16"	PY5F2A
	200' x 24" x 1/16"	PRBF2B
1/8"	50' x 24" x 1/8"	PY5J2A
	100' x 24" x 1/8"	PRBJ2B
1/4"	50' x 24" x 1/4"	PY3K2B

Industrial Rope



Smaller sizes available on page 4.

Name	Dimensions	Packaging	Item #
2000F Rope	25' x 3/8"	Bag	9402
	25' x 1/2"	Bag	9403
1000F Rope	1-1/4" Dia.	Lineal Ft.	9413
	1-1/2" Dia.	Lineal Ft.	9414
	2" Dia.	Lineal Ft.	9415

Castables

Name	Packaging	Item #
Kaolite—2300F—Lightweight Castable	40lb bag	MNK23L
Kaocast—3000F—Dense Castable	55lb bag	MNKCST

TANK GAUGES





Dual Bushing Fits 1-1/2" and 2" in one gauge. Indoor/Outdoor. Large text easily read from a distance. Highest quality gauge on the market. UL Listed. Custom Sizes available.









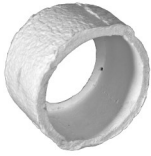
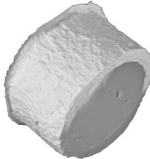
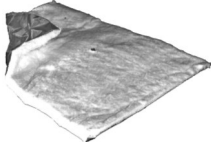

Replacement Top Kits

Item **8005**









Name	Fit	Item #
Model 42/44	Fits Vertical Tank	8000
Model 26/27	Fits Horizontal Tank	8001

ACCESSORIES

 <p>Burner Head Protector—4" OD Fits Beckett</p> <p>Item: 1030</p>	 <p>Burner Head Protector—3.5" OD Fits Riello & Carlin</p> <p>Item: 1046</p>
 <p>Flame Stop Flame Shield for Soldering/Brazing. Protect wood, painted or metal surfaces from the heat and flame of a torch. 10" x 12".</p> <p>Item: 9351</p>	 <p>Heating Forms 50 Pages per Pad</p> <p>Item: 6008</p>
 <p>Hole Plugs 100 pcs/bag</p> <p>Item: 6010</p>	 <p>Spill Pack (1) Oil Absorber Mats 15" x 19" x 1/4" (4) Oil Absorber Snakes 3" Dia. x 48" (3) Plastic Disposable Bags</p> <p>Item: 8053</p>
 <p>Oil Absorber Mat 19" x 15" x 1/4" 10/ctn.</p> <p>Item: 8050</p>	 <p>Oil Absorber Mat 19" x 15" x 1/4" 100/ctn.</p> <p>Item: 8055</p>
 <p>Oil Absorber Snakes 48" x 3" Dia. 5 pcs/ctn.</p> <p>Item: 8052</p>	 <p>Bulk Ceramic Fiber Vermiculite Substitute—2300F Material 10lbs/ctn.</p> <p>Item: FKAL10</p>

SPECIAL CEMENTS

 <p>Waterglass Quart Can</p> <p>Item: 5601</p>	 <p>Waterglass 4oz bottle—Same size as in our kits 12/ctn.</p> <p>Item: 5602</p>
 <p>High Temp. Refractory Cement 11oz Tube</p> <p>Item: 5606</p>	 <p>High Temp. Refractory Cement 30lbs Pail For bonding insulating fire brick</p> <p>Item: 5600</p>
 <p>Fiber Bond Cement Pint Can Bonds Kaowool Boards to Steel</p> <p>Item: 5604</p>	 <p>Ceramic Fiber Moldable 11 oz. Tube</p> <p>Item: MA2005</p>