

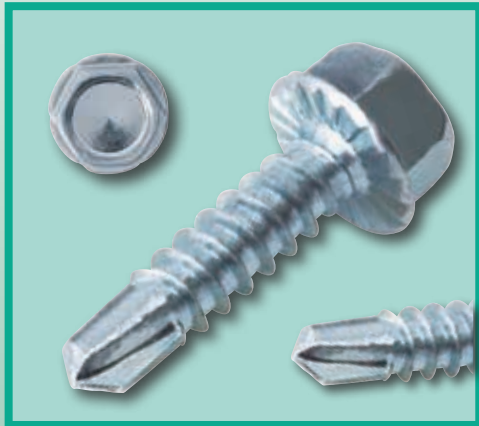

SCREWS, CHUCKS, RIVETS & DRILL BITS



PRODUCT CATALOG



SUPER SABER® SELF PIERCING SCREWS

FOR LIGHT TO MEDIUM GAUGE

Designed for light-to medium-gauge materials, the Super Saber Point offers one-step fastening. Its time saving performance is related to the saber-sharp piercing point with a "fine-cut" machine thread, which pierces the metal upon contact. Once pierced, the thread propels the screw through metal rapidly and almost without effort. They are quality tested through two strips of .024" steel.

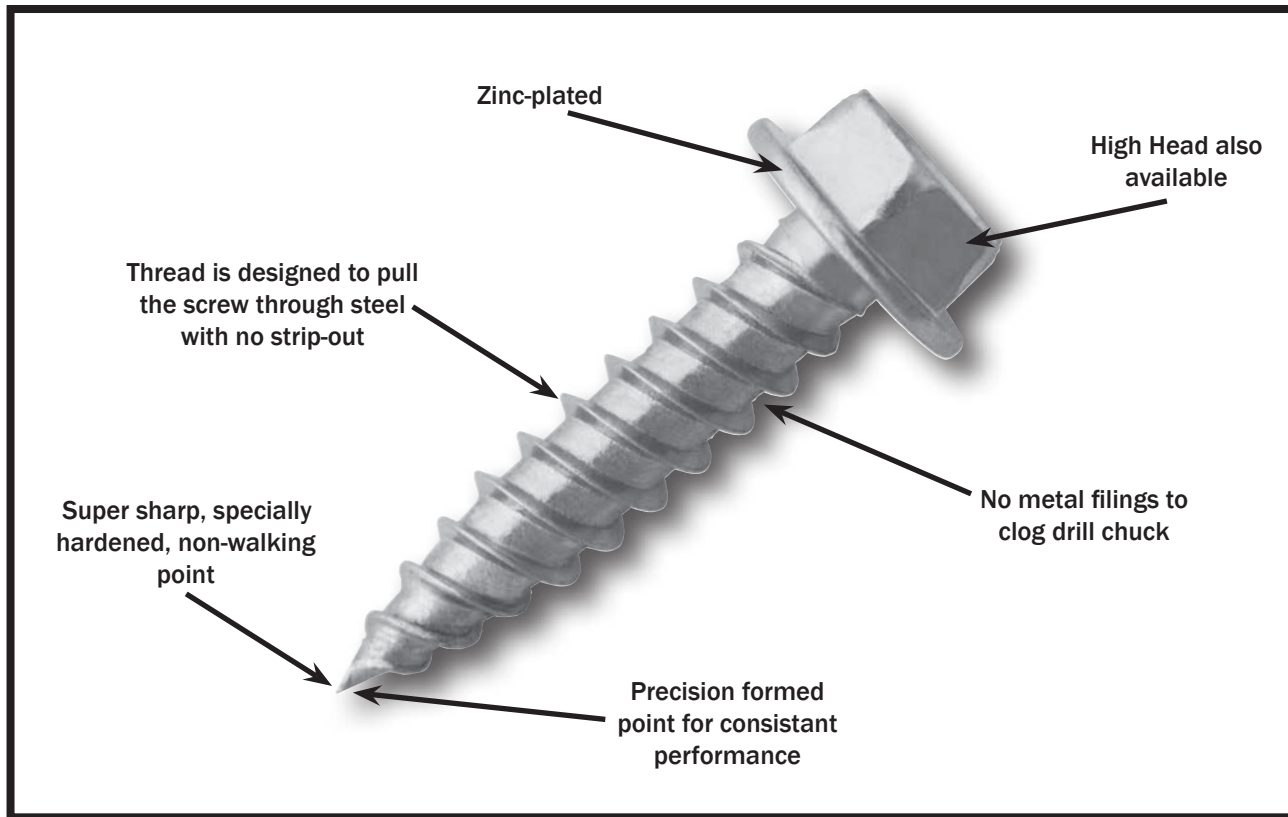

SUPER SABER SCREWS

ITEM SIZE	DRIVER SIZE	MAX. PIERCING CAPABILITY	HUNDRED PACK (SAC)	TWO-FIFTY PACK (SAQ)	FIVE HUNDRED PACK (SAF)	THOUSAND PACK (SAT)	BUCKET PACK (SAP)		BULK PACK (SAB)		5 GALLON BUCKET (BSAB)	
		DEC.	ITEM#	ITEM#	ITEM#	ITEM#	ITEM#	QTY.	ITEM#	QTY.	ITEM#	QTY.
6 x 3/8	1/4	.044 in	14165	N/A	N/A	14158	15153	5 TH	15108	20 TH	N/A	N/A
7 x 1/2	1/4	.044 in	14166	N/A	14321	14159	15154	5 TH	15109	17 TH	N/A	N/A
8 x 1/2	1/4	.044 in	14167	N/A	14322	14160	15155	5 TH	15110	14 TH	N/A	N/A
8 x 3/4	1/4	.044 in	14168	N/A	14323	14161	15156	4 TH	15111	10 TH	15004	25 TH
8 x 1	1/4	.044 in	14193	N/A	14324	14174	15167	3 TH	15124	7 TH	N/A	N/A
8 x 1-1/2	1/4	.044 in	14172	14305	14222	14175	15168	3 TH	15125	4 TH	N/A	N/A
8 x 2	1/4	.044 in	14173	14306	14221	14176	15169	3 TH	15126	3 TH	N/A	N/A
8 x 2-1/2	1/4	.044 in	N/A	14312	N/A	N/A	N/A	N/A	15123	2.5 TH	N/A	N/A
8 x 3	1/4	.044 IN	14260	14262	14263	14264	15056	2.5 TH	15057	2.5 TH	N/A	N/A
10 x 1/2	1/4	.044 in	14169	N/A	N/A	14162	15157	4 TH	15112	10 TH	N/A	N/A
10 x 3/4	1/4	.044 in	14170	N/A	14328	14163	15158	3 TH	15113	7 TH	N/A	N/A
10 x 1	1/4	.044 in	14171	N/A	14329	14164	15170	3 TH	15114	6 TH	N/A	N/A

SUPER SABER® SELF PIERCING SCREWS (CONTINUED)

SPECIAL 5/16" HEAD SUPER SABER SCREWS

ITEM SIZE	DRIVER SIZE	MAX. PIERCING CAPABILITY	HUNDRED PACK (SAC)	TWO-FIFTY PACK (SAQ)	FIVE HUNDRED PACK (SAF)	THOUSAND PACK (SAT)	BUCKET PACK (SAP)		BULK PACK (SAB)	
		DEC.	ITEM#	ITEM#	ITEM#	ITEM#	ITEM#	QTY.	ITEM#	QTY.
10 x 1/2 BH	5/16	.044 in	14228	14230	14226	14211	15117	4 TH	15115	10 TH
10 x 3/4 BH	5/16	.044 in	14223	N/A	14330	14215	15178	3 TH	15177	7 TH
10 x 1 BH	5/16	.044 in	14229	14231	14227	14212	15118	3 TH	15116	6 TH

SPECIAL WHITE PAINTED SUPER SABER SCREWS

ITEM SIZE	DRIVER SIZE	MAX. PIERCING CAPABILITY	HUNDRED PACK (SAC)	TWO-FIFTY PACK (SAQ)	FIVE HUNDRED PACK (SAF)	THOUSAND PACK (SAT)	BUCKET PACK (SAP)		BULK PACK (SAB)	
		DEC.	ITEM#	ITEM#	ITEM#	ITEM#	ITEM#	QTY.	ITEM#	QTY.
8 x 2	1/4	.044 in	15180	14311	14331	15181	15182	3 TH	15179	3 TH

HIGH HEAD SUPER SABER® SCREWS

High Head Super Sabers have the highest head in the industry. The high head stays in the chuck with ease and provides stability during insertion.



HIGH HEAD SUPER SABER SCREWS

ITEM SIZE	DRIVER SIZE	MAX. PIERCING CAPABILITY	HUNDRED PACK (SAC)	TWO-FIFTY PACK (SAQ)	FIVE HUNDRED PACK (SAF)	THOUSAND PACK (SAT)	BUCKET PACK (SAP)		BULK PACK (SAB)		2 GALLON PAIL (BKSAB)	
		DEC.	ITEM#	ITEM#	ITEM#	ITEM#	ITEM#	QTY.	ITEM#	QTY.	ITEM#	QTY.
8HH x 1/2	1/4	.044 in	14240	14245	14250	14255	15098	5 TH	15103	14 TH	N/A	N/A
8HH x 3/4	1/4	.044 in	14241	14246	14251	14256	15099	4 TH	15104	10 TH	N/A	N/A
8HH x 1	1/4	.044 in	14242	14247	14252	15257	15100	3 TH	15105	7 TH	N/A	N/A
8HH x 1-1/2	1/4	.044 in	14243	14248	14253	14258	15101	3 TH	15106	4 TH	N/A	N/A
8HH x 2	1/4	.044 in	14244	14249	14254	14259	15102	3 TH	15107	3 TH	N/A	N/A
10HH x 3/4	1/4	.044 in	14236	14237	14238	14239	15119	3 TH	15120	5 TH	15036	5 TH

SPECIAL 5/16" HIGH HEAD SUPER SABER SCREWS

ITEM SIZE	DRIVER SIZE	MAX. PIERCING CAPABILITY	HUNDRED PACK (SAC)	TWO-FIFTY PACK (SAQ)	FIVE HUNDRED PACK (SAF)	THOUSAND PACK (SAT)	BUCKET PACK (SAP)		BULK PACK (SAB)		2 GALLON PAIL (BKSAB)	
		DEC.	ITEM#	ITEM#	ITEM#	ITEM#	ITEM#	QTY.	ITEM#	QTY.	ITEM#	QTY.
10HH x 3/4BH	5/16	.044 in	14232	14233	14234	14235	15121	3 TH	15122	5 TH	15037	5 TH



PRO POINT® SELF DRILLING SCREWS

FOR HEAVY GAUGE

Pro-Point Screws, with a precision formed drill point, are designed to fasten heavy gauge metals. These screws assure accurately sized holes for maximum holding power, eliminating the need for hole preparation and frequent alignment problems encountered in parts assembly. Ideal for fastening 4-bolt flange to ductwork. Pro Point Screws are quality tested through 1/8" cold rolled steel.

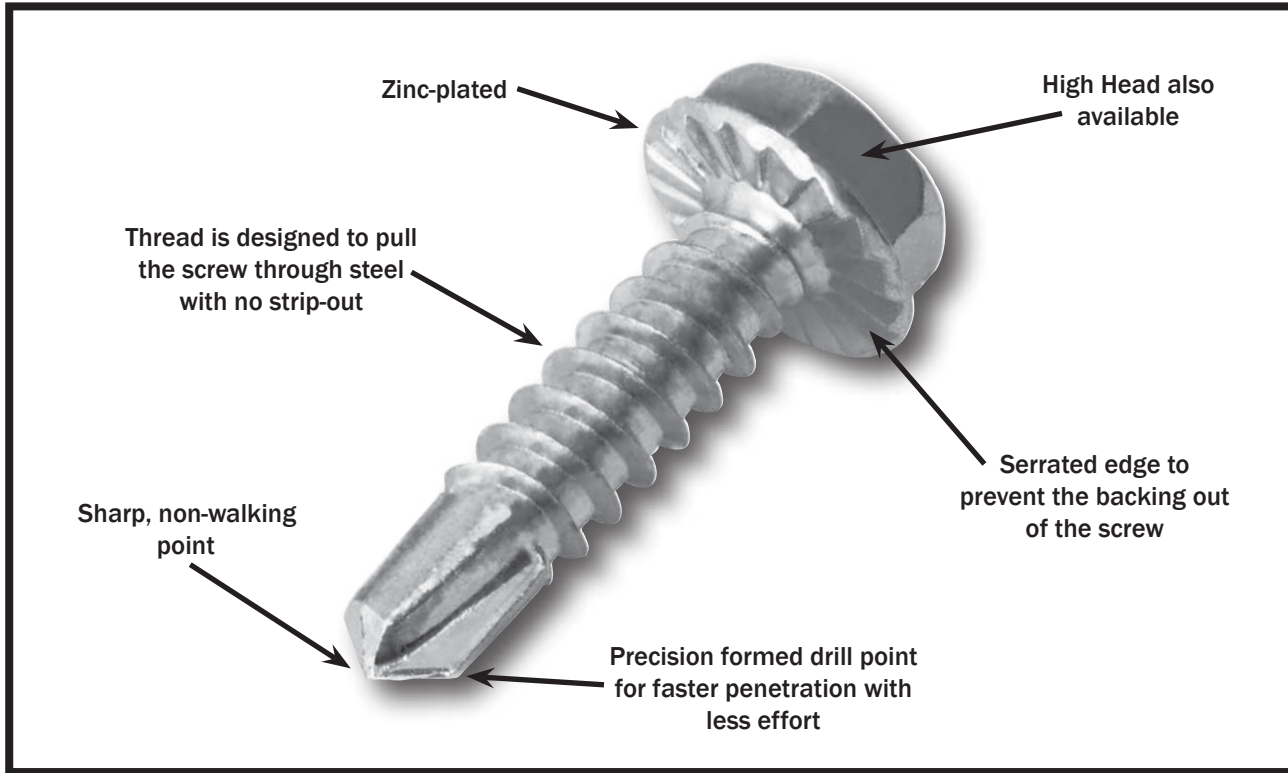

PRO POINT SCREWS

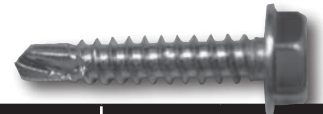

ITEM SIZE	DRIVER SIZE	DRILL PT. SIZE	MAX. DRILL CAPABILITY		HUNDRED PACK (PPC)	FIVE HUNDRED PACK (PPF)	THOUSAND PACK (PPT)	BUCKET PACK (PPP)		BULK PACK (PPB)	
			DEC.	GA.	ITEM#	ITEM#	ITEM#	ITEM#	QTY.	ITEM#	QTY.
8 x 1/2	1/4	2	.100 in		14177	14340	14185	15159	5 TH	15127	10 TH
8 x 5/8	1/4	2	.100 in		14178	N/A	14186	15160	5 TH	15128	10 TH
8 x 3/4	1/4	2	.100 in		14179	14342	14187	15161	4 TH	15129	10 TH
8 x 1	1/4	2	.100 in		14194	14195	14196	15165	3 TH	15174	5 TH
10 x 1/2	5/16	3	.110 in		14180	14343	14188	15162	4 TH	15130	8 TH
10 x 5/8	5/16	3	.175 in		14181	N/A	14189	15163	3 TH	15131	5 TH
10 x 3/4	5/16	3	.175 in		14182	14345	14190	15164	3 TH	15132	5 TH
10 x 1	5/16	3	.175 in		14183	14346	14191	15166	3 TH	15133	5 TH
12 x 3/4	5/16	3	.210 in		14184	N/A	14192	15175	3 TH	15134	5 TH

PRO POINT SCREWS WITH NEOPRENE WASHER



ITEM SIZE	DRIVER SIZE	DRILL PT. SIZE	MAX. DRILL CAPABILITY		HUNDRED PACK (PPC)	FIVE HUNDRED PACK (PPF)	THOUSAND PACK (PPT)	BUCKET PACK (PPP)		BULK PACK (NTAB)	
			DEC.	GA.	ITEM#	ITEM#	ITEM#	ITEM#	QTY.	ITEM#	QTY.
10 x 1	5/16	3	.175	7	N/A	N/A	N/A	N/A	N/A	15187	5 TH

PRO POINT® SELF DRILLING SCREWS (CONTINUED)

HIGH HEAD PRO POINT® SCREWS

High Head Pro Points have the highest head in the industry. The high head stays in the chuck with ease and provides stability during insertion.



HIGH HEAD PRO POINT SCREWS

ITEM SIZE	DRIVER SIZE	DRILL PT. SIZE	MAX. DRILL CAPABILITY		HUNDRED PACK (PPC)	FIVE HUNDRED PACK (PPF)	THOUSAND PACK (PPT)	BUCKET PACK (PPP)		BULK PACK (PPB)		2 GALLON PAIL (BKTAB)	
			DEC.	GA.	ITEM#	ITEM#	ITEM#	ITEM#	QTY.	ITEM#	QTY.	ITEM#	QTY.
8HH x 3/4	1/4	2	.100	12	14207	14206	14209	15146	4 TH	15210	10 TH	N/A	N/A
10HH x 3/4	5/16	3	.175	7	14208	14204	14210	15150	3 TH	15196	5 TH	15361	5 TH
10HH x 1-1/2	5/16	3	.175	7	N/A	N/A	14205	N/A	N/A	15173	2 TH	N/A	N/A



HIGH HEAD PRO POINT SCREWS WITH NEOPRENE WASHER

ITEM SIZE	DRIVER SIZE	DRILL PT. SIZE	MAX. DRILL CAPABILITY		HUNDRED PACK (PPC)	FIVE HUNDRED PACK (PPF)	THOUSAND PACK (PPT)	BUCKET PACK (PPP)		BULK PACK (NTAB)	
			DEC.	GA.	ITEM#	ITEM#	ITEM#	ITEM#	QTY.	ITEM#	QTY.
10HHx 3/4	5/16	3	.175	7	N/A	N/A	N/A	N/A	N/A	15189	3.5 TH
10HH x 1-1/2	5/16	3	.175	7	N/A	N/A	N/A	N/A	N/A	15188	2 TH

STAINLESS STEEL HIGH HEAD PRO POINT SCREWS (410 SERIES STAINLESS)

ITEM SIZE	DRIVER SIZE	DRILL PT. SIZE	MAX. DRILL CAPABILITY		HUNDRED PACK (PPC)	FIVE HUNDRED PACK (PPF)	THOUSAND PACK (PPT)	BUCKET PACK (PPP)		BULK PACK (PPB)	
			DEC.	GA.	ITEM#	ITEM#	ITEM#	ITEM#	QTY.	ITEM#	QTY.
10HHx 3/4	5/16	3	.175	7	14201	14202	14203	15171	3TH	15172	5 TH

PRO POINT SCREW PACKAGING

*Quantities per pail and bulk carton vary per screw size.

Item# 20003
SA1 - Shop Apron

The Duro Dyne Shop Apron is perfect for holding screws & drill chucks while on the job!

SCREW DIMENSIONS

SUPER SABER



DIMENSIONS AND TORSIONAL SPECIFICATIONS OF SELF-PIERCING AND THREADING SCREWS						
SIZE	THREADS PER INCH	D		d		MINIMUM TORSIONAL STRENGTH (LB. IN.)
		MAJOR DIAMETER		MINOR DIAMETER		
		MAX	MIN	MAX	MIN	
6	18	0.141	0.136	0.102	0.096	11.7
7	16	0.158	0.152	0.114	0.108	26.5
8	15	0.168	0.162	0.123	0.116	32.5
10	12	0.194	0.188	0.133	0.126	51.5

PRO POINT



DIMENSIONS AND TORSIONAL SPECIFICATIONS FOR SELF-DRILLING TAPPING SCREWS							
SIZE OR NOMINAL SCREW DIAMETER	THREADS PER INCH	D		d		MINIMUM TORSIONAL STRENGTH (LB. IN.)	
		MAJOR DIAMETER		MINOR DIAMETER			
		MAX	MIN	MAX	MIN		
4	0.1120	24	0.114	0.110	0.086	0.082	14
6	0.1380	20	0.139	0.135	0.104	0.099	24
8	0.1640	18	0.166	0.161	0.122	0.116	42
10	0.1900	16	0.189	0.183	0.141	0.135	61
12	0.2160	14	0.215	0.209	0.164	0.157	92
1/4	0.2500	14	0.246	0.240	0.192	0.185	150

SCREW INSTALLATION

ELECTRIC DRILL

Use 1/4" capacity low torque drill with speed from 1800-2500 RPM. #8 and #10 Pro Point screws can be installed up to 3600 rpm.

DRILL CHUCK

Duro Dyne 1/4" and 5/16" socket sizes are designed with a heavy-duty magnet to hold screws securely in position and are able to withstand the impact of usage without undue wear.

SCREW LENGTH FOR SUPER SABERS

Must be sufficient to engage multiple layers of metal being fastened. With two pieces of light-gage metal, unsupported back piece may push away under pressure. Screw length must be long enough to engage back piece of metal.

SCREW LENGTH FOR PRO POINTS

Drill point length must exceed total thickness of material to be fastened including gaps. Thread length must also exceed combined material thickness.

TECHNIQUE

Set screw in the chuck, press the point firmly against the metal, and start the drill. As the screw bites into the metal, release the trigger to allow the drill momentum to seat the screw without stripping. Heavier gages of metal require greater pressure.

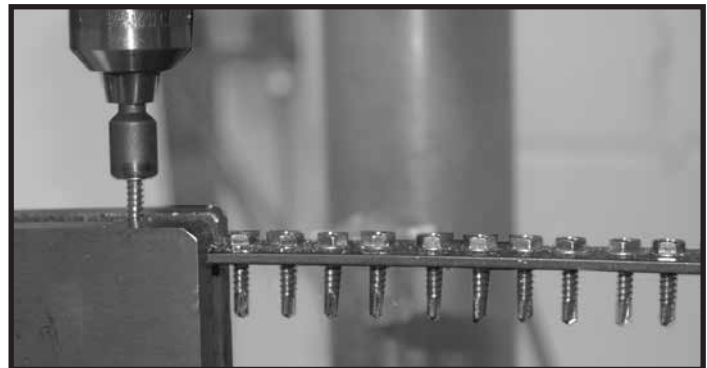

DRILL POINT LENGTH MUST EXCEED TOTAL THICKNESS

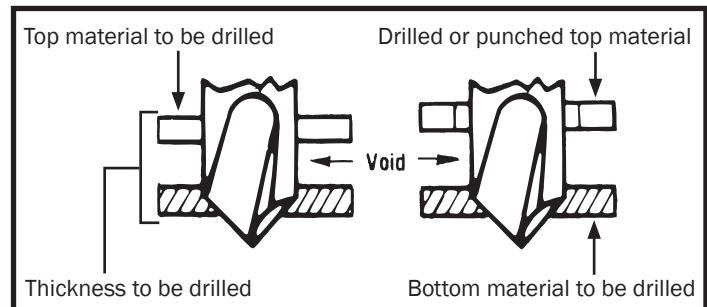

DRILL SCREW CHUCKS

Super hard, yet shock resistant, Duro Dyne Chucks outperform all others. A strong, permanent magnet holds the screw firmly in position. A precision hex hole resists the reaming effect of the screw head during extended usage.

FOR SCREW HEAD SIZE	OVERALL LENGTH	PACKED 1 PER CARD, 10 CARDS PER SLEEVE		PACKED 100 PER CTN	
		ITEM#	CODE	ITEM#	CODE
1/4"	1-3/4"	16018	DC14	16021	DC14B
5/16"	1-3/4"	16019	DC516	16022	DC516B
1/4"	2-5/8"	16008	DCL14	16012	DCL14B
5/16"	2-5/8"	16009	DCL516	16013	DCL516B

FOR SCREW HEAD SIZE	OVERALL LENGTH	PACKED 1 PER PACK		PACKED 100 PER CTN	
		ITEM#	CODE	ITEM#	CODE
1/4"	6"	16015	DCXL14	16024	DCXL14B
5/16"	6"	16016	DCXL516	16025	DCXL516B



DRILL BITS

HOT ROLLED FORGED

- Fast Cutting - Fast Starting
135° split point starts the hole where you place it. The drill does not “walk”, mar metal, or waste time.
- Long Wearing - Extra Hard
Specially hardened high speed steel makes “Super T” Drill Bits harder and longer wearing than others. This same steel/processing combination allows bits to withstand the stress of torsional twisting.
- Heavy Web Reduces Breakage
Web is the portion which is solid steel from point to shank. “Super-T” has heavier web than ordinary bits. This means more flexibility, less breakage.

TWIN END DRILL BITS

SIZE	OVERALL LENGTH	PACKED 10 PER PACK		PACKED 100 PER CTN	
		ITEM#	CODE	ITEM#	CODE
1/8	2"	24015	TED1/8	24031	TEDB1/8
#30	2"	24016	TED#30	24032	TEDB#30



SUPER-T™ DRILL BITS

SIZE	DECIMAL EQUIVALENT	PACKED 10 PER POUCH		PACKED 100 PER BOX	
		ITEM #	DESCRIPTION	ITEM #	DESCRIPTION
1/8	.1250	24004	TD1/8	24020	TDB1/8
#30	.1285	24005	TD30	24021	TDB30
9/64	.1405	24006	TD9/64	24022	TDB9/64
5/32	.1562	24007	TD5/32	24023	TDB5/32
3/16	.1875	24010	TD3/16	24026	TDB3/16
#11	.1910	24011	TD11	24027	TDB11
7/32	.2187	24012	TD7/32	24028	TDB7/32
1/4	.2500	24013	TD1/4	24029	TDB1/4
9/32	.2811	24014	TD9/32	24030	TDB9/32



PIN RIVETS™

Pin Rivets are strong, hollow rivets assembled onto a solid mandrel. They are manufactured to strict quality control standards and are available in a wide range of sizes and styles to provide the proper rivet for every type of application. Pin Rivets are inserted and set from the same side. They are particularly practical where there is no access to the reverse side of the work.



PIN RIVETS

DESCRIPTION	THOUSAND PACK		BULK TEN THOUSAND PACK	
	ITEM #	CODE	ITEM #	CODE
STEEL RIVET/STEEL PIN	23002	SS42DT	29002	SS42DB
STEEL RIVET/STEEL PIN	23004	SS44DT	29004	SS44DB
STAINLESS RIVET/STAINLESS PIN	23013	XX42DT	29013	XX42DB
STAINLESS RIVET/STAINLESS PIN	23014	XX44DT	29014	XX44DB
STAINLESS RIVET/STEEL PIN	23015	XS42DT	29015	XS42DB
STAINLESS RIVET/STEEL PIN	23016	XS44DT	29016	XS44DB
ALUMINUM RIVET/STEEL PIN	23030	AS42DT	29030	AS42DB
ALUMINUM RIVET/STEEL PIN	23032	AS44DT	29032	AS44DB
COPPER RIVET/COPPER PLATED PIN	23050	CC42DT	29050	CC42DB
COPPER RIVET/COPPER PLATED PIN	23051	CC44DT	29051	CC44DB
ALUMINUM RIVET/ALUMINUM PIN	23060	AA42DT	29060	AA42DB
ALUMINUM RIVET/ALUMINUM PIN	23062	AA44DT	29062	AA44DB

RIVET CODES

Part 1	Part 2	Part 3	Part 4	Part 5	Part 6
Rivet Material	Pin Material	Rivet Diam. (in 32nds of an inch)	Maximum Grip (in 16ths of an inch)	Rivet Head Style	Quantity
S=Steel	S=Steel	3 = 3/32"	1 = 1/16"	D=Dome	B=Bulk
A=Aluminum	A=Aluminum	4 = 1/8"	2 = 1/8"		T=Thousand
C=Copper	C=Copper	5 = 5/32"	3 = 3/16"		
X=Stainless Steel	(Coated Steel)	6 = 3/16"	4 = 1/4"		
	X=Stainless Steel	8 = 1/4"	5 = 5/16"		
			6 = 3/8"		
			8 = 1/2"		
			10 = 5/8"		

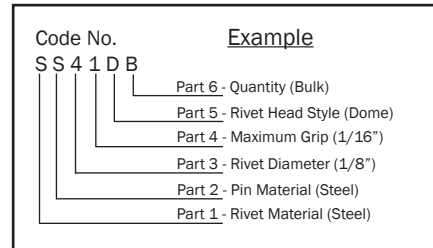

RIVET TOOL

The Rivet Tool is used for setting all popular diameter blind rivets. You need only to select and insert the proper nozzle to accommodate the rivet diameter.

- Pass thru Mandrel jaw allows for both front or back nail ejection.
- Ergonomic handles
- Handle Lock Clip
- Constructed of hardened Steel for longer life
- Compact nose design for hard to reach places.
- 4 Included nose pieces 3/32, 1/8, 5/32, 3/16" with wrench included
- High Leverage handles for more power and easier operation 25:1 mechanical advantage



ITEM#	CODE	DESCRIPTION
22110	DDPR6	Rivet Tool

Duro Dyne East Division, Bay Shore, NY	631-249-9000	Fax: 631-249-8346
Duro Dyne Midwest Division, Fairfield, OH	513-870-6000	Fax: 513-870-6005
Duro Dyne West Division, Fontana, CA	562-926-1774	Fax: 562-926-5778
Duro Dyne Canada, Lachine, Quebec, Canada	514-422-9760	Fax: 514-636-0328
www.durodyne.com E-mail: durodyne@durodyne.com		

**DURO
DYNE**

© Duro Dyne Corp.
Printed in USA 8/16
BB008402