

Threaded Products and Hardware

Channel Nuts

Superstrut® channel nuts are manufactured from Grade 2 mild steel and are case hardened.

Design Data

Superstrut® self aligning channel nuts are designed to provide resistance to pullout and resistance to side slip in excess of the full strength of the channels with which they are used. The extreme resistance to side slip results from the unique design of the alternate teeth, spaced and designed to develop a wedging action that increases with pressure or load.

Screw Threads

All threaded products are American Standard thread, free fit class 2.

Thread Size	1/4	5/16	3/8	1/2	5/8	3/4	7/8	1
Threads per inch	20	18	16	13	11	10	9	8
Design Torque (ft.-lb.)	6	11	19	50	100	125	185	275

Finish and special materials

Standard finish for all hardware is Electrogalvanized (EGC) or GoldGalv®. Stainless Steel Type 316 is also available. Contact your Regional Sales Office for availability and minimum quantities.

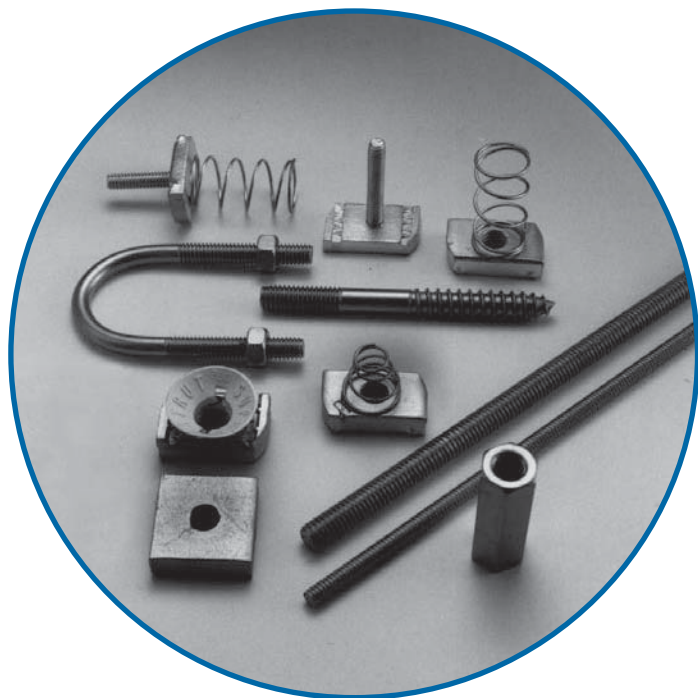

Spring Nut Selector Chart

SPRING NUT	CHANNEL SERIES					
	A - AR	B - BR	C	D	E	H
A100-1/4EGC	■		■			
A100-5/16EGC	■		■			
A100-3/8EGC	■		■			
A100-1/2EGC	■		■			
A100-3/4	■		■			
B100-1/4EGC		■		■		
B100-5/16EGC		■		■		
B100-3/8EGC		■		■		
B100-1/2EGC		■		■		
H100-3/8EGC					■	■
H100-1/2EGC					■	■
CM100-1/4	■		■	■	■	■
CM100-3/8	■		■	■	■	■
CM100-1/2	■		■	■	■	■
CM100-1/2B	■	■				
UC100-1/4	■		■	■	■	■
UC100-3/8	■		■	■	■	■
UC100-1/2	■		■	■	■	■

Threaded Products and Hardware

A100 Regular Spring Nut*

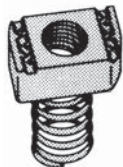

Available in Stainless Steel 316. Nut is square over 1/2 in. size. For all A and C Series channel and inserts.

Cat. No.	Size (in.)	Wt./C lb.
A100-1/4EGC	1/4	8
A100-5/16EGC	5/16	9
A100-3/8EGC	3/8	10
A100-1/2EGC	1/2	12
A100-5/8EGC	5/8	19
A100-3/4	3/4	19
A100-7/8	7/8	18

STD. PACK 100

B100 Short Spring Nut*



Available in Stainless Steel 316. For all B and D Series channel and inserts.

Cat. No.	Size (in.)	Wt./C lb.
B100-1/4EGC	1/4	7
B100-5/16EGC	5/16	8
B100-3/8EGC	3/8	9
B100-1/2EGC	1/2	9

STD. PACK 100

H100 Long Spring Nut*

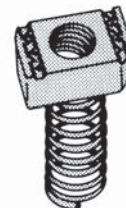

For all E and H Series channel and inserts.

Cat. No.	Size (in.)	Wt./C lb.
H100-3/8EGC	3/8	10
H100-1/2EGC	1/2	14

STD. PACK 100

AB100 Springless Nut 1/4 in. thick

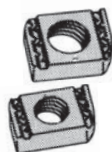

For use with all channels. Nut is square over 1/2 in. size.

Cat. No.	Size (in.)	Wt./C lb.
AB100-1/4EGC	1/4	7
AB100-5/16EGC	5/16	8
AB100-3/8EGC	3/8	9
AB100-1/2EGC	1/2	9
AB100-5/8EGC	5/8	10
AB100-3/4EGC	3/4	10

STD. PACK 100

AC100 Springless Nut Heavy duty 3/8 in. thick



For all A, C, E and H Series channel and inserts. Nut is square over 1/2 in. size.

Cat. No.	Size (in.)	Wt./C lb.
AC100-3/8EGC	3/8	9
AC100-1/2EGC	1/2	11
AC100-5/8EGC	5/8	18
AC100-3/4EGC	3/4	18

STD. PACK 100

813EG Springless Nut Light Duty

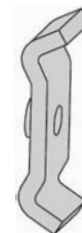

For use with all channels.

Cat. No.	Size (in.)	Wt./C lb.
813EG	1/4	5

STD. PACK 100

A182 to A185 Regular Spring Stud Nut*

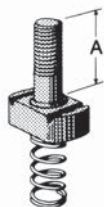

For all A and C Series channels.

Cat. No.	Bolt Dia (in.)	Length A (in.)	Wt./C lb.
A182-1/4x100EG	1/4	1	10
A182-1/4x125EG	1/4	1-1/4	15
A184-3/8x100EG	3/8	1	10
A184-3/8x125EG	3/8	1-1/4	15
A185-1/2x100EG	1/2	1	10
A185-1/2x125EG	1/2	1-1/4	15

STD. PACK 100

A177 to A179 Springless Stud Nut

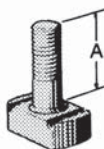

For use with all channels.

Cat. No.	Bolt Dia (in.)	Length A (in.)	Wt./C lb.
A177-1/4x100EG	1/4	1	8
A177-1/4x125EG	1/4	1-1/4	10
A179-3/8x100EG	3/8	1	13
A179-3/8x125EG	3/8	1-1/4	13.5

STD. PACK 100

812 Stud Nut

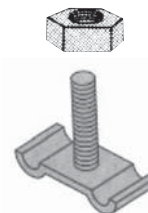

For attaching fixture to channel slot down or to channel slot up knockouts. Specify length. Hex nut included.

Cat. No.	For Channel	Wt./C lb.
812-1EG	1/4 x 1	6

STD. PACK 100

E145 Standard Hex Nut



Cat. No.	Size (in.)	Wt./C lb.
E145-1/4EGC	1/4	.72
E145-3/8EGC	3/8	1.60
E145-1/2EGC	1/2	2.78
E145-5/8EGC	5/8	6.92
E145-3/4EGC	3/4	12.70
E145-7/8EGC	7/8	19.00
E145-1EGC	1	28.00

STD. PACK 100

UCN Universal Nylon Cone Nut



GoldGalv® only
For all 1-5/8 in. and 1-1/2 in. channels.
May be used with ALL Strut Depths.
Can be used for A100 Series, B100 Series and AB100 Series.

Cat. No.	Size (in.)	Wt./C lb.
UCN-1/4	1/4	8
UCN-3/8	3/8	10
UCN-1/2	1/2	12

STD. PACK 100

AB102 Unhardened Square Nut

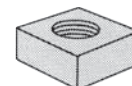

Cat. No.	Size (in.)	Wt./C lb.
AB102-1/4	1/4	13
AB102-3/8	3/8	14
AB102-1/2	1/2	14
AB102-5/8	5/8	12
AB102-3/4	3/4	11
AB102-7/8	7/8	10

STD. PACK 100

ES145 Swivel Nut and Jam Nut Combinations



Cat. No.	Size (in.)	Wt./C lb.
ES145-3/8	3/8	5.5
ES145-1/2	1/2	6.0

STD. PACK 100

E146 Standard Square Nut



Cat. No.	Size (in.)	Wt./C lb.
E146-1/4EGC	1/4	.93
E146-5/16EGC	5/16	1.60
E146-3/8EGC	3/8	2.65
E146-1/2EGC	1/2	5.83
E146-5/8EGC	5/8	10.80

STD. PACK 100

*Supplied with a plastic sleeve over the spring portion to prevent tangling inside the carton.

Threaded Products and Hardware

E147 Flat Steel Washer



STD. PACK 100

Cat. No.	Size (in.)	Wt./C lb.
E147-1/4EG	1/4	0.67
E147-5/16EG	5/16	1.11
E147-3/8EG	3/8	1.49
E147-1/2EG	1/2	3.85
E147-5/8EG	5/8	7.69
E147-3/4EG	3/4	9.89
E147-7/8EG	7/8	15.40

Available in Stainless Steel.

EF147 Fender Washer

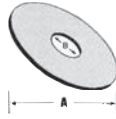

STD. PACK 100

Cat. No.	Size (in.)	A (in.)	B (in.)	Wt./C lb.
EF147-1/4EGC	1/4	1-1/4	5/16	3.1
EF147-3/8EGC	3/8	1-1/2	7/16	2.9
EF147-1/2EGC	1/2	2	9/16	5.0

Available in Stainless Steel.

E148 Lock Washer



STD. PACK 100

Cat. No.	Size (in.)	Wt./C lb.
E148-1/4EG	1/4	0.26
E148-3/8EG	3/8	0.50
E148-1/2EG	1/2	1.09
E148-5/8EG	5/8	2.57

Available in Stainless Steel.

E142 Hex Head Cap Screw

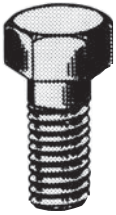

STD. PACK 100

Cat. No.	Size (in.)	Wt./C lb.
E142-1/4x100EG	1/4x1	1.74
E142-1/4x150EG	1/4x1-1/2	2.43
E142-3/8x100EG	3/8x1	4.17
E142-3/8x150EG	3/8x1-1/2	5.64
E142-1/2x100EG	1/2x1	8.94
E142-1/2x150EG	1/2x1-1/2	10.00
E142-1/2x200EG	1/2x2	11.19
E142-1/2x225EG	1/2x2-1/4	11.90
E142-1/2x250EG	1/2x2-1/2	12.52
E142-1/2x275EG	1/2x2-3/4	13.22

Available in Stainless Steel.

E150S Lag Bolt



STD. PACK 50

Cat. No.	Drill Size (in.)	Size (in.)	Wt./C lb.
E150S-3/8x1-1/2EG	1/4	3/8x1-1/2	5
E150S-3/8x2EG	1/4	3/8x2	7
E150S-3/8x2-1/2EG	1/4	3/8x2-1/2	8
E150S-3/8x3EG	1/4	3/8x3	9
E150S-1/2x1-1/2EG	11/32	1/2x1-1/2	12
E150S-1/2x2EG	11/32	1/2x2	13
E150S-1/2x2-1/2EG	11/32	1/2x2-1/2	15
E150S-1/2x3EG	11/32	1/2x3	18

Available in Stainless Steel.

E151 Coach Screw Rod



Cat. No.	Rod Size (in.)	Std Rod Lengths (in.)	Wt./C lb.
E151-3/8x4EG	3/8	4	9
E151-3/8x6EG	3/8	6	14
E151-3/8x8EG	3/8	8	22
E151-3/8x10EG	3/8	10	29
E151-3/8x12EG	3/8	12	35
E151-1/2x4EG	1/2	4	17
E151-1/2x6EG	1/2	6	22
E151-1/2x8EG	1/2	8	40
E151-1/2x10EG	1/2	10	51

Machine threaded opposite end, carbon steel.

H104 Hanger Rod Continuous Threaded



STD. PACK 3

Cat. No.	Thread Size (in.)	Wt./lb. 100 ft.	Design Load lb.
H104-1/4x10EGC	1/4	12.5	150
H104-3/8x10EGC	3/8	29	610
H104-1/2x10EGC	1/2	53.5	1130
H104-5/8x10EGC	5/8	85	1810
H104-3/4x10EGC	3/4	123	2710
H104-7/8x10EG	7/8	130	3770
H104-1x10EG	1	214	4960

- Black available upon request
- Sold per foot; standard length, 10 ft.
- Also available in stainless steel (316) standard length 6 ft. (suffix SS6)
- National coarse thread

H119 Rod Couplings

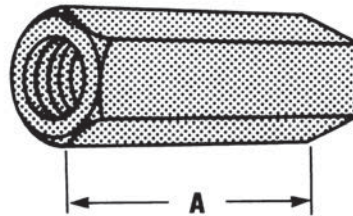

Rod Size	A (in.)	Wt./C lb.
1/4	7/8	1.90
5/16	7/8	3.75
3/8	1-1/8	3.50
1/2	1-1/4	5.50
5/8	2-1/8	18.00
3/4	2-1/4	28.00
7/8	2-1/2	55.00
1	2-1/4	56.00

Standard Rod Coupling
Example: H119-1/2EG

Order by product number, rod size, and finish.
Available in Stainless Steel.

Rod Size	A (in.)	Wt./C lb.
1/4 to 3/8	1-1/2	3.50
3/8 to 1/2	1-1/4	6.70
1/2 to 5/8	1-1/4	14.00
5/8 to 3/4	1-1/2	21.00
3/4 to 7/8	1-3/4	40.00

Rod Reducer Coupling
Example: H119-1/4x3/8EG

Threaded Products and Hardware

H122 Trapnut™ Strut Fastener

Cat. No.	Size (in.)	Design Load (lb.)	Std. Ctn.
H 122 1/4	1/4	150	50
H 122 3/8	3/8	590	
H 122 1/2	1/2	1080	
H 122 1/4 EG	1/4	150	
H 122 3/8 EG	3/8	590	
H 122 1/2 EG	1/2	1080	
H 122 3/8 SS6	3/8	590	
H 122 1/2 SS6	1/2	1080	

Finishes: Electrogalvanized (EG), GoldGalv®, Stainless Steel Type 316 (SS6)



M117 Eye Socket

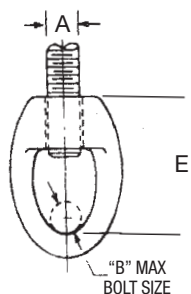
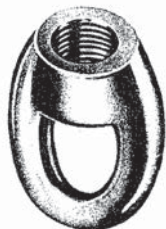

Rod Size A (in.)	Pipe Size (in.)	B (in.)	E (in.)	Wt./C lb.	Design Load, lb.
1/4	3/8	1/4	1-11/32	5	230
3/8	1/2 - 2	1/4	1-11/32	7	610
1/2	2-1/2 - 3-1/2	1/4	1-17/32	13	1130
5/8	4 - 5	3/8	1-13/16	19	1810
3/4	6	1/2	2-5/32	31	2400
7/8	8	1/2	2-11/32	44	2800

Standard Finishes - Bare (B), Electrogalvanized (EG)

Malleable iron. For attaching hanger rod to various types of hangers and beam clamps.

Order by product number, rod size, and finish. Example: M117-1/4B

Complies with Specification MSS SP69, Type 16.

E120 Swivel Joint

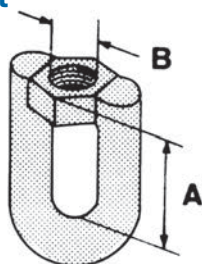

Cat. No.	Size (in.)	A (in.)	B (in.)	Wt./C lb.	Design Load, lb.
E120-3/8	3/8	1-3/8	3/8	15	1000
E120-1/2	1/2	1-1/2	1/2	25	1800

E120A Weldless Eye Nut

Rod Size T	A (in.)	B (in.)	C (in.)	D (in.)	E (in.)	F (in.)	Wt./C lb.	Design Load, lb.
3/8	7/8	5/8	1-1/4	2	2-1/2	3/8	20	2700
1/2	7/8	5/8	1-1/4	2	2-1/2	3/8	22	2700
5/8	1-3/8	3/4	1-1/2	2-1/2	3	1/2	60	5000
3/4	1-3/8	3/4	1-1/2	2-1/2	3	1/2	56	5000
7/8	1-1/2	1-5/8	1-5/16	3-5/8	4-1/2	3/4	174	10000
1	1-1/2	1-5/8	1-5/16	3-5/8	4-1/2	3/4	168	10000

Standard Finish - Bare (B)

Drop Forged Steel. For use on high temperature piping installations.

Order by product number and rod size.

Example: E120A-3/8B

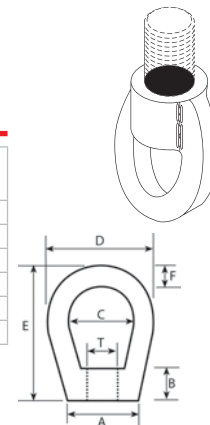

E122 Swivel Joint

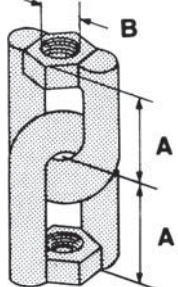

Cat. No.	Size (in.)	A (in.)	B (in.)	Wt./C lb.	Design Load, lb.
E122-3/8	3/8	1-3/8	3/8	28	1000
E122-1/2	1/2	1-1/2	1/2	48	1800

E130 Swivel Joint

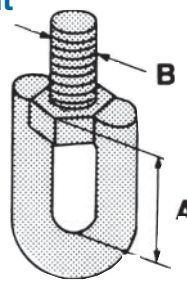

Cat. No.	Size (in.)	A (in.)	B (in.)	Wt./C lb.	Design Load, lb.
E130-3/8	3/8	1-3/8	3/8	23	1000
E130-1/2	1/2	1-1/2	1/2	48	1800

E131 Swivel Joint

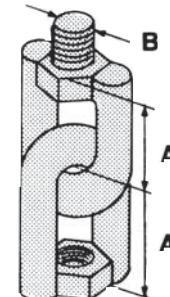

Cat. No.	Size (in.)	A (in.)	B (in.)	Wt./C lb.	Design Load, lb.
E131-3/8	3/8	1-3/8	3/8	25	1000
E131-1/2	1/2	1-1/2	1/2	52	1800

Threaded Products and Hardware

C781 Square Washer

STD
PACK
50

Cat. No.	Rod Size (in.)	Hole Size (in.)	Overall Dimensions (in.)	Wt./ C lb.
C781-3/8*	3/8	7/16	3 x 3 x 3/16	27
C781-1/2*	1/2	9/16	3 x 3 x 3/16	27
C781-5/8*	5/8	11/16	3 x 3 x 1/4	47
C781-3/4*	3/4	13/16	3 x 3 x 1/4	42
C781-7/8*	7/8	15/16	4 x 4 x 3/8	85
C781-1*	1	1-1/8	4 x 4 x 3/8	160

Used for beam applications. For channel applications use AB241.

***Finishes**

- B
- HDG
- EG
- SS6

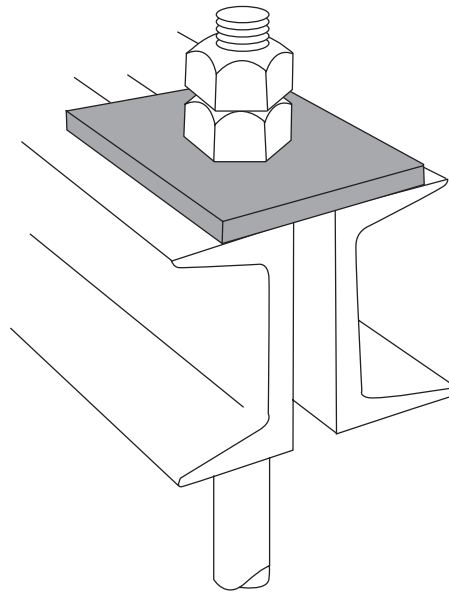

H115 Standard U-Bolt

Pipe Size (in.)	A (in.)	B (in.)	C (in.)	D (in.)	E (in.)	Wt./ C lb.	Design Load, lb.
1/2	15/16	1-3/4	1-1/2	1/4	2-3/4	13	1500
3/4	1-1/8	1-3/4	1-5/8	1/4	3-1/16	15	2000
1	1-3/8	1-7/8	1-5/8	1/4	3-5/16	16	2500
1-1/4	1-23/32	1-3/4	1-15/32	3/8	3-1/2	17	2500
1-1/2	2	1-3/4	1-7/16	3/8	3-3/4	18	2500
2	2-7/16	2-1/16	1-7/8	3/8	4-11/16	32	3300
2-1/2	2-15/16	2-1/16	1-13/16	1/2	5-1/8	34	4000
3	3-9/16	2	1-3/4	1/2	5-11/16	38	4000
3-1/2	4-3/32	2	1-23/32	1/2	6-3/16	40	4000
4	4-19/32	2-1/4	1-31/32	1/2	6-15/16	46	4000
5	5-5/8	3	2-7/32	1/2	8-5/16	101	4000
6	6-3/4	3-3/4	2-13/16	5/8	10-1/8	197	4000
8	8-3/4	3-3/4	2-13/16	5/8	12-1/8	233	4000
10	10-7/8	4	3	3/4	14-9/16	491	5400
12	12-7/8	4-1/4	3-1/4	7/8	16-15/16	773	7500

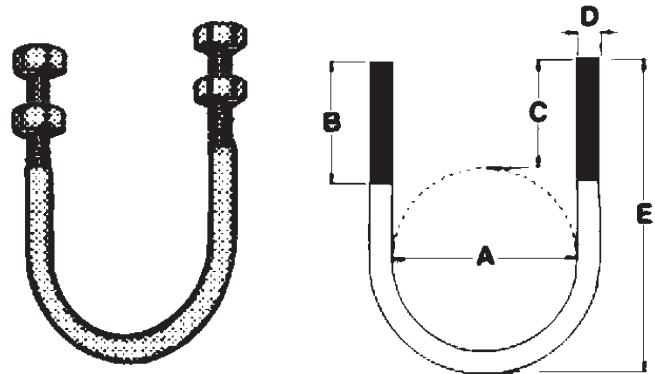

Standard Finishes - ElectroGalvanized (EG), GoldGalv®, Stainless Steel or Bare (B)

Example: H115-1/2EG

Sizes through 4 in. furnished with one hex nut per leg.
 Sizes 5 in. and above furnished with two hex nuts per leg.
 Order by Cat. No., pipe size, finish.
 Complies with Specification MSS SP69, Type 24.