

**Danger:** If the information in this manual is not followed exactly, a fire or explosion may result causing property damage, personal injury or death.

Do not store or use gasoline or other flammable vapors and liquids in the vicinity of this or any other appliance.

Installation and service must be performed by a trained and certified installer, service agency or the gas supplier.

Improper installation, adjustment, alteration, service or maintenance can cause injury or property damage. Refer to this manual. For assistance or additional information consult a qualified installer, service agency or the gas supplier.

In the Commonwealth of Massachusetts this product must be installed by a licensed plumber or gas fitter.

Upon completion of the installation, these instructions should be handed to the user of the appliance for future reference.

#### **What to do if you smell gas**

- Turn off the gas shut-off valve. Open windows and doors.
- Do not try to light any appliance.
- Do not touch any electrical switch, telephone, and do not use outlets.
- Extinguish all open flames. Do not smoke! Do not use lighters!
- Warn all occupants of the building. Do not ring doorbells!
- If you can hear gas leaking, leave the building immediately. Prevent others from entering the building and notify the police and fire department from outside the building.
- From outside the building, call the gas utility company and a trained and certified installer.

INDOOR RESIDENTIAL AND COMMERCIAL TANKLESS WATER HEATERS

**Greentherm 9800 SE 160/199 | SEC 199**

160 000/199 000 Btu - Natural Gas | 160 000/199 000 Btu - Liquefied Petroleum (LP) Gas



**BOSCH**

#### **Installation and Operating Instructions**

Temperature Modulated with Electronic Ignition Suitable for heating potable water and space heating

(Intended for variable flow applications, indoor use only)



LOW-LEAD



## Table of contents

<b>1</b>	<b>Key to symbols and safety instructions</b> .....	<b>3</b>
1.1	Key to symbols .....	3
1.2	Safety instructions .....	3
<b>2</b>	<b>Safety information</b> .....	<b>6</b>
<b>3</b>	<b>Appliance details</b> .....	<b>7</b>
3.1	Features .....	7
3.2	Specifications (Technical data) .....	8
3.3	Unpacking the heater .....	10
3.4	General rules to follow for safe operation ...	11
3.5	Dimensions and minimum installation clearances .....	12
<b>4</b>	<b>Installation instructions</b> .....	<b>13</b>
4.1	Installation tools .....	13
4.2	Introduction .....	13
4.3	Proper location for installing your heater ...	13
4.4	Heater placement and clearances .....	14
4.5	Hanging appliance on the wall .....	14
4.6	Venting .....	15
4.7	Factory regulation .....	27
4.8	Gas piping & connections .....	28
4.9	Water quality .....	31
4.10	Water connections .....	31
4.11	Domestic hot water recirculation with external pump .....	32
4.12	Space heating applications .....	33
4.13	Measuring gas pressure .....	36
<b>5</b>	<b>Electrical connections</b> .....	<b>36</b>
5.1	Electrical power supply .....	36
5.2	Position of the fuses in control unit .....	37
<b>6</b>	<b>Operating Instructions</b> .....	<b>37</b>
6.1	For your safety read before operating your water heater .....	38
6.2	Power .....	38
6.3	Error code reset .....	38
6.4	Temperature selection .....	38
6.5	Information /Adjustments menu .....	40
6.6	Service menu - AU Technical Settings .....	44
6.7	Factory default settings .....	44
6.8	Water actuators calibration .....	44
6.9	Gas type .....	45
<b>7</b>	<b>Maintenance and service</b> .....	<b>46</b>
7.1	Annual maintenance .....	47
7.2	Winterizing for seasonal use .....	47
7.3	Mineral scale build-up .....	48
<b>8</b>	<b>Troubleshooting</b> .....	<b>48</b>
8.1	Introduction .....	48
8.2	Burner does not ignite when a hot water faucet is opened .....	48
8.3	Water is too hot .....	49
8.4	Water is not hot enough .....	49
8.5	Low water flow/pressure .....	49
8.6	Hot water temperature fluctuates at tap ...	49
8.7	Noisy burner/heater during operation .....	50
8.8	Error codes C1, C2, CF and/or CE .....	50
8.9	Error codes EA and/or EC .....	50
8.10	Manifold gas pressure .....	50
8.11	Adjusting Gas/Air flow .....	51
8.12	CO emissions check .....	55
<b>9</b>	<b>Problem solving</b> .....	<b>56</b>
9.1	Error code diagnostics .....	56
<b>10</b>	<b>Electrical diagram</b> .....	<b>61</b>
<b>11</b>	<b>Sensor resistance charts</b> .....	<b>63</b>
<b>12</b>	<b>Interior components diagram</b> .....	<b>64</b>
12.1	199,000 Btu interior components .....	64
12.2	160,000 Btu interior components .....	65
<b>13</b>	<b>Protecting the environment</b> .....	<b>66</b>
<b>14</b>	<b>Installer Checklist to be completed by installer upon installation</b> .....	<b>66</b>

## 1 Key to symbols and safety instructions

### 1.1 Key to symbols

#### Warnings



Warnings in this document are identified by a warning triangle printed against a grey background.

Keywords at the start of a warning indicate the type and seriousness of the ensuing risk if measures to prevent the risk are not taken.

The following keywords are defined and can be used in this document:

- **DANGER** indicates a hazardous situation which, if not avoided, will result in death or serious injury.
- **WARNING** indicates a hazardous situation which, if not avoided, could result in death or serious injury.
- **CAUTION** indicates a hazardous situation which, if not avoided, could result in minor to moderate injury.
- **NOTICE** is used to address practices not related to personal injury.

#### Important information



This symbol indicates important information where there is no risk to people or property.

#### Additional symbols

Symbol	Explanation
▶	Step in an action sequence
→	Cross-reference to another part of the document
•	List entry
–	List entry (second level)

Table 1

### 1.2 Safety instructions

Read all instructions before installing. Perform the steps in the indicated sequence. Have the water heater inspected by a trained service technician at least once every year. Failure to comply with these instructions can result in severe, possibly fatal, personal injury as well as damage to property and equipment.

#### Installation and servicing

##### ▶ Risk of fire when soldering and brazing!

Take appropriate protective measures when soldering and brazing around combustible and flammable material.

- ▶ Ensure that only a licensed contractor installs or services the water heater.
- ▶ On hot components use only material with adequate temperature stability.

#### Installation and commissioning

- ▶ In the Commonwealth of Massachusetts, the water heater must be installed by a licensed plumber.
- ▶ Do not install this device in rooms with a high moisture level (e.g. bathrooms, saunas).

#### Function

- ▶ To ensure that the water heater functions properly, follow these installation and maintenance instructions.
- ▶ Never close the blow-off line of the T&P safety valve. For safety reasons, water may escape during heating.

#### If you smell gas

- ▶ Turn off the gas shut-off valve.
- ▶ Open windows and doors.
- ▶ Do not try to light the appliance.
- ▶ Do not touch any electrical switch, telephone, and do not use outlets.
- ▶ Extinguish all open flames. Do not smoke! Do not use lighters!
- ▶ Warn all occupants of the building. Do not ring doorbells!
- ▶ If you can hear gas leaking, leave the building immediately.
- ▶ Prevent others from entering the building and notify the police and fire department from outside the building.
- ▶ From outside the building, call the gas utility company and a trained and certified installer.

#### If you smell flue gas

- ▶ Switch off the appliance.
- ▶ Open windows and doors.
- ▶ Inform the certified installer who installed the appliance.

### **Insufficient ventilation may cause toxic flue gas to escape.**

#### **Risk of poisoning.**

- ▶ Never close off or reduce the size of the air intake and outlet openings.
- ▶ The appliance must not be operated until any obstructions have been removed.
- ▶ Inform the customer of the problem and the associated dangers.

#### **Danger from escaping flue gases**

- ▶ Ensure all vent pipes and chimneys are not damaged or blocked.
- ▶ Connect only one appliance to each vent system or chimney liner, except for cascading installation.
- ▶ The venting system piping must not feed into another air extraction duct.
- ▶ Do not route the flue system piping through or inside another air extraction duct.

#### **Danger of explosion of flammable gases**

- ▶ Work on gas components may only be carried out by a trained and certified installer.
- ▶ Installation, gas and flue connection, initial commissioning, electrical connections and annual maintenance must only be carried out by a trained and certified installer.

#### **Combustion air**

- ▶ Keep the combustion air free of corrosive substances (halogenated hydrocarbons that contain chlorine or fluorine compounds).

#### **Never shut off safety valves!**

- ▶ Water may escape from the safety valve at any time when the water is being heated.

#### **Inspection/maintenance**

- ▶ Servicing and repairs may only be carried out by a trained and certified installer.
- ▶ Immediately correct all faults to prevent system damage.
- ▶ Use only Bosch spare parts!

#### **Instruct the customer**

- ▶ Explain to the customer how the appliance works and how to operate it.
- ▶ Inform the customer that he/she must not carry out any alterations or repairs.

#### **Danger from electric shock**

- ▶ Ensure that only an authorized contractor performs electrical work.
- ▶ Before performing electrical work, disconnect the power and secure the unit against unintentional reconnection.
- ▶ Ensure the system has been disconnected from the power supply.

### **Risk of scalding at the hot water fixture**

- ▶ When the water heater is in operation, temperatures in excess of 120 °F (49 °C) can occur. To limit the temperature at the tap, install a thermostatic DHW mixing valve.
- ▶ Water heated for washing the laundry, dishes and for other cleaning purposes can cause scalding and permanent injuries.
- ▶ Children, disable and elderly are at highest risk of being scalded. Never leave such individuals in the tub or shower unattended under any circumstances. Children must not be allowed to operate hot water faucets themselves.
- ▶ If the building has occupants in the above groups who operate hot water faucets, or state laws / local ordinances stipulate specific water temperatures, take the following precautions:
  - Use the lowest possible temperature setting.
  - To prevent scalding, install a tempering device, such as an automatic mixing valve, at hot water tap or water heater. Select and install the automatic mixing valve in accordance with the valve manufacturer's recommendations and instructions.
- ▶ Water exiting from drain valves can be extremely hot. To avoid injuries:
  - Check that all connections are tight.
  - Direct exiting water away from people.
- ▶ Measures must be taken to protect against excessive temperature and pressure! Installation of a T&P safety valve is required.

To protect against corrosion and ensure compliance with the rules for electrical safety, observe the following points:

- ▶ Use metal fittings for potable water heating systems with plastic piping.
- ▶ Use only original accessories from the manufacturer.
- ▶ When installation of the water heater is complete, inspect and confirm proper ground conductor.

#### **Maintenance**

##### **Customers are advised to:**

- ▶ Inspect and maintain the water heater on a yearly basis. Service as needed. See chapter 7.1.
- ▶ Use only genuine spare parts.

#### **Flooding**

- ▶ After a flood, do not use the appliance if any part has been submerged. Damage to appliances that have been submerged can be quite severe and pose numerous safety risks.
- ▶ Every appliance that has been submerged must be replaced.

**For your safety**

- ▶ Do not store or use gasoline or other flammable, combustible or corrosive vapors and liquids in the vicinity of this or any other appliance.

**DANGER:** Fatal accidents!

Carbon monoxide poisoning.

- ▶ Carefully plan where you install the heater. Correct combustion air supply and flue pipe installation are very important. If a gas appliance is not installed correctly, fatal accidents can result such as carbon monoxide poisoning or fire.

**DANGER:**

Carbon monoxide poisoning.

- ▶ Exhaust gas must be vented to outside using approved vent material. See table 5, page 16 (In Canada use only ULCS636 approved material). Vent and combustion air connector piping must be sealed gas-tight to prevent flue gas spillage, carbon monoxide emissions and risk of fire, resulting in severe personal injury or death. Approved vent terminations must be used.

**DANGER:** Electric shock!

- ▶ Field wiring connections and electrical grounding must comply with local codes, or in the absence of local codes, with the latest edition of the National Electric Code, ANSI/NFPA 70, or in Canada, all electrical wiring must comply with the local codes and the Canadian Electrical Code, CSA C22.1 Part 1.

**DANGER:** Electric shock!

Shock hazard: line voltage is present.

- ▶ Before servicing the water heater, unplug power supply cord from outlet. Failure to do so could result in severe personal injury or death.

**WARNING:** Damage to the appliance from over pressure.

- ▶ The heater must be disconnected from the gas supply piping system during any pressure testing of that system at test pressures equal to or more than 0.5 psi.

**NOTICE:**

- ▶ The appliance should be located in an area where leakage of the heater or connections will not result in damage to the area adjacent to the appliance or to lower floors of the structure. When such locations cannot be avoided, it is recommended that a suitable drain pan, adequately drained, be installed under the appliance. The pan must not restrict combustion air flow.

**WARNING:**

- ▶ The maximum inlet gas pressure must not exceed the value specified by the manufacturer and the minimum value listed is for the purpose of input adjustment.

**NOTICE:**

- ▶ If a water heater is installed in a closed water supply system, such as one having a backflow preventer in the cold water supply line, means shall be provided to control thermal expansion. Contact the water supplier or local plumbing inspector on how to control this situation.

**WARNING:** Fire danger!

- ▶ Keep appliance area clear and free from combustible materials, gasoline and other flammable vapors and liquids.

**NOTICE:**

- ▶ Do not obstruct the flow of combustion and ventilation air.



**WARNING:** Risk of scalding and property damage.

- ▶ Precautions must be taken prior to manually operating the relief valve to avoid contact with hot water discharged from the relief valve and to prevent water damage.



**NOTICE:** Appliance damage!

- ▶ Label all wires prior to disconnection when servicing controls. Wiring errors can result in improper and dangerous operation. Verify proper operation after servicing.



**WARNING:** System damage!

- ▶ If a relief valve discharges periodically, this may be due to thermal expansion in a closed water supply system. Contact the water supplier or local plumbing inspector on how to correct this situation. Do not plug the relief valve.



**WARNING:** Personal Injury from toxic chemicals.

- ▶ Toxic chemicals, such as those used for boiler treatment, shall not be introduced into the potable water used for space heating.



**WARNING:** Personal Injury from toxic chemicals.

- ▶ A water heater which will be used to supply potable water shall not be connected to any heating system or component(s) previously used with a nonpotable water heating appliance.

## 2 Safety information

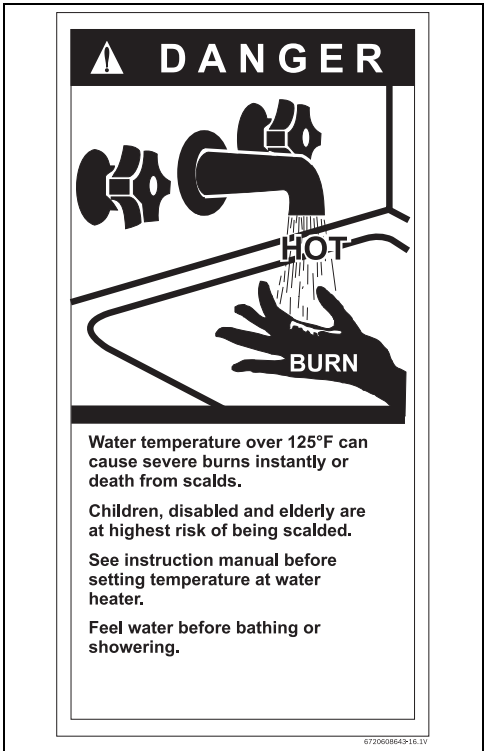



Fig. 1

The chart below shows the relationship between water temperature and time until there is a risk of scalding. It can be used as the basis for determining the safest water temperature for your application.

Temperature	Time to severe scalding <sup>1)</sup>
120 °F (48 °C)	longer than 5 minutes
125 °F (51 °C)	1.5 to 2 minutes
130 °F (54 °C)	approx. 30 seconds
135 °F (57 °C)	approx. 10 seconds
140 °F (60 °C)	less than 5 seconds
145 °F (62 °C)	less than 3 seconds
150 °F (65 °C)	approx. 1.5 seconds
155 °F (68 °C)	approx. 1 second

Table 2 Approximate time-temperature relationship until there is a risk of scalding

- 1) Source: Moritz, A.R. and Henriques, F.C., Jr. (1947). Studies of thermal injury. II. The relative importance of time and surface temperature in the causation of cutaneous burns, Am J of Pathol, 23, 695-720.



**WARNING:** California Proposition 65

The California Safe Drinking Water and Toxic Enforcement Act requires the Governor of California to publish a list of substances known to the State of California to cause cancer, birth defects, or other reproductive harm, and requires businesses to warn of potential exposure to such substances.

- ▶ This product contains chemicals known to the State of California to cause cancer, birth defects, or other reproductive harm. This appliance can cause low-level exposure to some of the substances included in the Act.

BOSCH water heater complies with the State of California Lead Law (AB1953).

### 3 Appliance details

#### 3.1 Features

Residential / Commercial models

- Greentherm 9800 SE residential models
  - maximum temperature 120 °F<sup>1)</sup>
- Greentherm 9800 SEC commercial models
  - maximum temperature 180 °F

Parts

- Color Display with touch controls.
- High power segmented burner with low NOx emissions.
- Modulating gas valve with pressure regulator.
- Modulating water valve.
- Active bypass water valve for quick response to changing water flows.
- Burner power segmentation with modulation range from 1:22.

High quality materials for long working life

- Copper primary heat exchanger.
- Stainless Steel 316L condensing heat exchanger.

Features

- 
- 1) Can be reprogrammed to achieve 140 °F

- Compact space saver: mounts on a wall with a supplied bracket.
- Easily removable one-piece cover.
- On/Off and Temperature touch control buttons.
- Reset function - Long press (> 3 sec.) the ON/OFF button.
- Programmable default temperature.
- Failure codes with message display for easy diagnostics and repair.
- Real-time diagnostics for troubleshooting/informational purposes.
- Built in freeze prevention.
- Integrated siphon to limit condensate freezing in external condensate pipes.
- Available common vent kits, more information at [www.boschheatingandcooling.com](http://www.boschheatingandcooling.com).

Accessories (Bosch part #)

- Neutralizer Kit (7738001483)
- Wi-Fi module [802.11 b/g/n (2.4 GHz)]
- Aquastat kit (7736504584)
- Recirculation pump kit (7736504585)
- Tank loading NTC (7736504583)



BOSCH is constantly improving its products, therefore specifications are subject to change without prior notice.

### 3.2 Specifications (Technical data)

Approved in US/Canada

Technical characteristics	Units	Greentherm 9800 SE / SEC 199 000 Btu	Greentherm 9800 SE 160 000 Btu
<b>Capacity</b>			
Maximum flow rate at a 35 °F (19.4 °C) rise <sup>1)</sup>	GPM (l/min)	11.2 (42.4)	9 (34)
Maximum flow rate at a 45 °F (25 °C) rise	GPM (l/min)	8.7 (32.9)	7(26.7)
Maximum flow rate at a 55 °F (30.6 °C) rise	GPM (l/min)	7.2 (27.5)	5.8 (21.9)
Maximum flow rate at a 75 °F (41.7 °C) rise	GPM (l/min)	5.2 (19.7)	4.2 (15.9)
Maximum flow rate at a 90 °F (50 °C) rise	GPM (l/min)	4.4 (16.6)	3.5 (13.2)
Maximum output	BTU/hr (kW)	197 010 (57.7)	157 608 (46.2)
Maximum input <sup>2)</sup>	BTU/hr (kW)	199 000 (58.3)	160 000 (46.64)
Thermal efficiency (Efficiency in %)	%	> 99%	> 99%
Minimum Input <sup>3)</sup>	BTU/hr (kW)	9 000 (2.6)	9 000 (2.6)
<b>Temperature Control<sup>4)</sup></b>			
<b>Residential models - Selection range</b>	°F (°C)	100 - 120 <sup>5)</sup> (38 - 49)	100 - 120 <sup>5)</sup> (38 - 49)
<b>Commercial models - Selection range</b>	°F (°C)	100 - 180 (38 - 82)	-
Default temperature	°F (°C)	120 (49)	120 (49)
Temperature stability <sup>6)</sup>	°F (°C)	± 2 (± 1)	± 2 (± 1)
<b>Gas Requirement</b>			
Gas connection	inches	¾ "	¾ "
<b>Peak load inlet gas pressure<sup>7)</sup></b>			
Propane	water column	8" - 13"	8" - 13"
Natural Gas	water column	3.5" - 10.5"	3.5" - 10.5"
To assure maximum heat input at maximum vent length minimum gas pressure should be 5" W.C.(199kBtu) and 4" W.C. (160kBtu) . For more information see section 4.6.3.			
<b>Water</b>			
Top hot water connection NPT	inches	¾ "	¾ "
Top cold water connection NPT	inches	¾ "	¾ "
Minimum water flow <sup>8)</sup>	GPM (l/min)	0.45 (1.7)	0.45 (1.7)
Maximum water pressure	PSI (bar)	150 (10.3)	150 (10.3)
Minimum recommended water pressure	PSI (bar)	18 (1.2)	18 (1.2)
Minimum well pressure	PSI (bar)	30 (2.1)	30 (2.1)
Water valve material		Polymer (PPS) (Polypropylene)	Polymer (PPS) (Polypropylene)
<b>Combustion</b>			
CO level	ppm	≤ 250 (measured)	≤ 250 (measured)
CO <sub>2</sub> level (set from factory)	%	see table 25	see table 25
<b>Dimensions</b>			
Depth	inches (mm)	9 <sup>27</sup> / <sub>32</sub> (250)	9 <sup>27</sup> / <sub>32</sub> (250)

Table 3



Technical characteristics	Units	Greentherm 9800 SE / SEC 199 000 Btu	Greentherm 9800 SE 160 000 Btu
Width	inches (mm)	18 <sup>19</sup> / <sub>32</sub> (471.5)	18 <sup>19</sup> / <sub>32</sub> (471.5)
Height	inches (mm)	31½ (800)	31½ (800)
Net weight	pounds (kg)	77.5 (35.15)	73.2 (33.20)
Gross weight	pounds (kg)	83.67 (37.95)	79.37 (36.0)
<b>Electrical</b>			
Voltage	V AC	120	120
Frequency	Hz	60	60
Amperage (Idle)	mA	40	40
Amperage (operation)	A	≤ 2,7	≤ 2,7
Water protection <sup>9)</sup>	IP	X4D	X4D

Table 3

- 1) These flow are based upon setting the unit to higher temperatures and then mixing down using cold water after the unit, to reach these flow rates.
- 2) Input rating is based on sea level operation and need not be changed for operation up to 2000 ft (610 m) elevation. For operation at elevations above 2000 ft (610 m), input rating is automatically reduced at the rate of 4 percent for each 1000 ft (305 m) above sea level.
- 3) When converted to LPG the minimum input is 17 000 BTU/hr (5 kW).
- 4) With constant flow.
- 5) Can be reprogrammed to achieve up to 140 °F (60 °C) (see chapter 6.4).
- 6) Requirements: Steady flows, single unit installations, up to 140 °F (60 °C).
- 7) To measure Gas Pressure, see Measuring Gas Pressure, chapter 4.13, page 36.
- 8) Refers to activation point. Deactivation point value is 0.35GPM (1.3 l/min).
- 9) Protection against water drops.

#### Safety devices

- Flame failure device (flame detection via ionization rod)
- Overheat prevention
- Inlet water temperature sensor
- Outlet water temperature sensor
- Exhaust flue gas temperature sensor
- Water flow sensor
- Air flow sensing technology (Optiflow)

### 3.3 Unpacking the heater

The heater is default-set by the manufacturer to operate with Natural Gas, for use with Liquid Propane, follow the conversion instructions in section 6.9.1. **Before commissioning the unit be certain you have the heater correctly set for your type of Gas - Propane or Natural Gas.** Identification labels are found on the shipping box, and on the rating plate which is located on the left side panel of the cover.

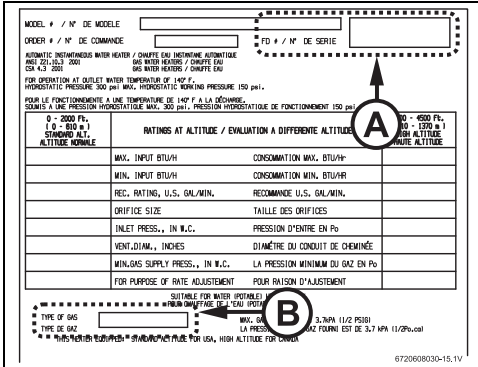

Fig. 2 Rating plate

- [A] Serial number
- [B] Type of gas (Natural gas by default)

#### 3.3.1 The box includes

- Water Heater
- LP Conversion Kit
- Pressure relief valve
- Bracket and screws for wall hanging the heater
- Installation manual (manual can be downloaded at [www.boschheatingandcooling.com](http://www.boschheatingandcooling.com))

**The Greentherm 9800 SE / SEC are not approved or designed for:**

- **Manufactured (mobile) homes, boats or any mobile installation. (Modular homes are acceptable for installation).**
- **Use above 10500 ft A.S.L. altitude.**
- **Applications where inlet water temperature is higher than 140 °F (60 °C) for Residential appliances or 180 °F (82 °C) for Commercial appliances.**  
**In these applications a 3 way valve or thermostatic mixing valve must be installed.**
- **Booster applications.**



In preheated inlet water applications (i.e. solar preheat), activation flow rate will vary depending upon the unit set point, inlet water temperature and the demand flow rate thru the unit. Please consult Bosch for further details to determine if this will function in your application.

#### 3.3.2 Remove front cover

- ▶ Loosen two Phillips head screws located on the bottom of the front cover (fig. 3).

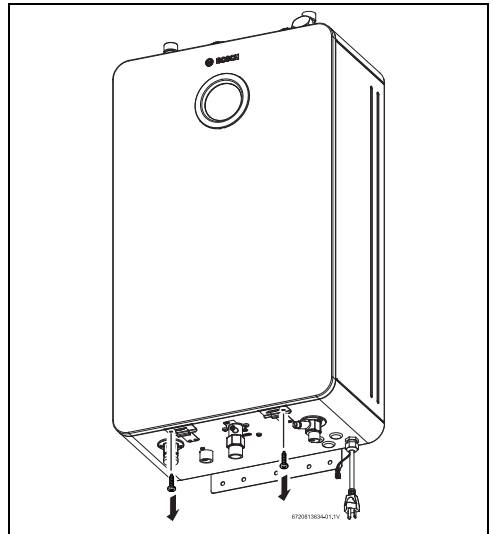

Fig. 3 Loosen two Phillips head screws

- ▶ Slowly open the front cover [1].

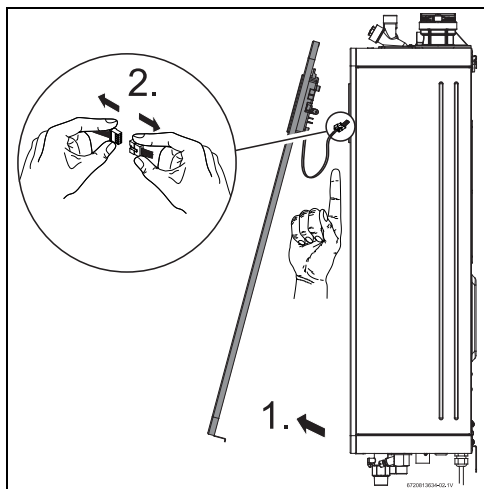

Fig. 4 Open front cover

- ▶ Disconnect the wire from the HMI (display) [2].
- ▶ Lift the front cover to remove from the appliance.
- ▶ Install the appliance so that it hangs vertically.

### 3.4 General rules to follow for safe operation

1. You must follow these instructions when you install your heater. In the United States: The installation must conform with local codes or, in the absence of local codes, the National Fuel Gas Code ANSI Z223.1/NFPA 54. In Canada: The Installation must conform with CSA B149. (1,2) INSTALLATION CODES and /or local installation codes.
2. Carefully plan where you install the heater. Correct combustion air supply and vent pipe installation are very important. If not installed correctly, fatal accidents can occur, such as carbon monoxide poisoning or fire.
3. When the unit is installed indoors with DIRECT VENT (exhaust vent and air intake connected to the outside) it is permitted to be located in bathrooms, bedrooms and occupied rooms that are normally kept closed. See chapter 4.6 (page 15). If the unit will be installed indoors and use indoor combustion air (NON-DIRECT VENT), the place where you install the heater must have enough ventilation. **The National Fuel Gas Codes do not allow NON-DIRECT VENT gas fired water heater installations in bathrooms, bedrooms or any occupied rooms normally kept closed.** See chapter 4.6 (page 15).
4. You must correctly vent your heater. See chapter 4.6 (page 15) on VENTING.
5. The appliance and its gas connection must be leak tested before placing the appliance in operation. The appliance must be isolated from the gas supply piping system by closing its individual manual gas shutoff valve (not supplied with heater) during any pressure testing at pressures in excess of ½ Psig (3.5 kPa).
6. Keep the water heater area clear and free from combustibles and flammable liquids. Do not locate the heater over any material which might burn.
7. Correct gas pressure is critical for the proper operation of this heater. Gas piping must be sized to provide the required pressure at the maximum output of the heater, while all the other gas appliances are in operation. Check with your local gas supplier, and see the section on connecting the gas supply. See chapter 4.8 (page 28).
8. Should overheating occur or the gas supply fail to shut off, turn off the gas supply at the manual gas shut off valve, on the gas line. Note: manual gas shutoff valve is not supplied with the heater but must be field installed.
9. Do not use this appliance if any part has been underwater. Immediately call the responsible party for the installation of your appliance to inspect the appliance and to replace any part of the water heater which has been underwater.
10. Failure to install the heater correctly may lead to unsafe operation.

3.5 Dimensions and minimum installation clearances

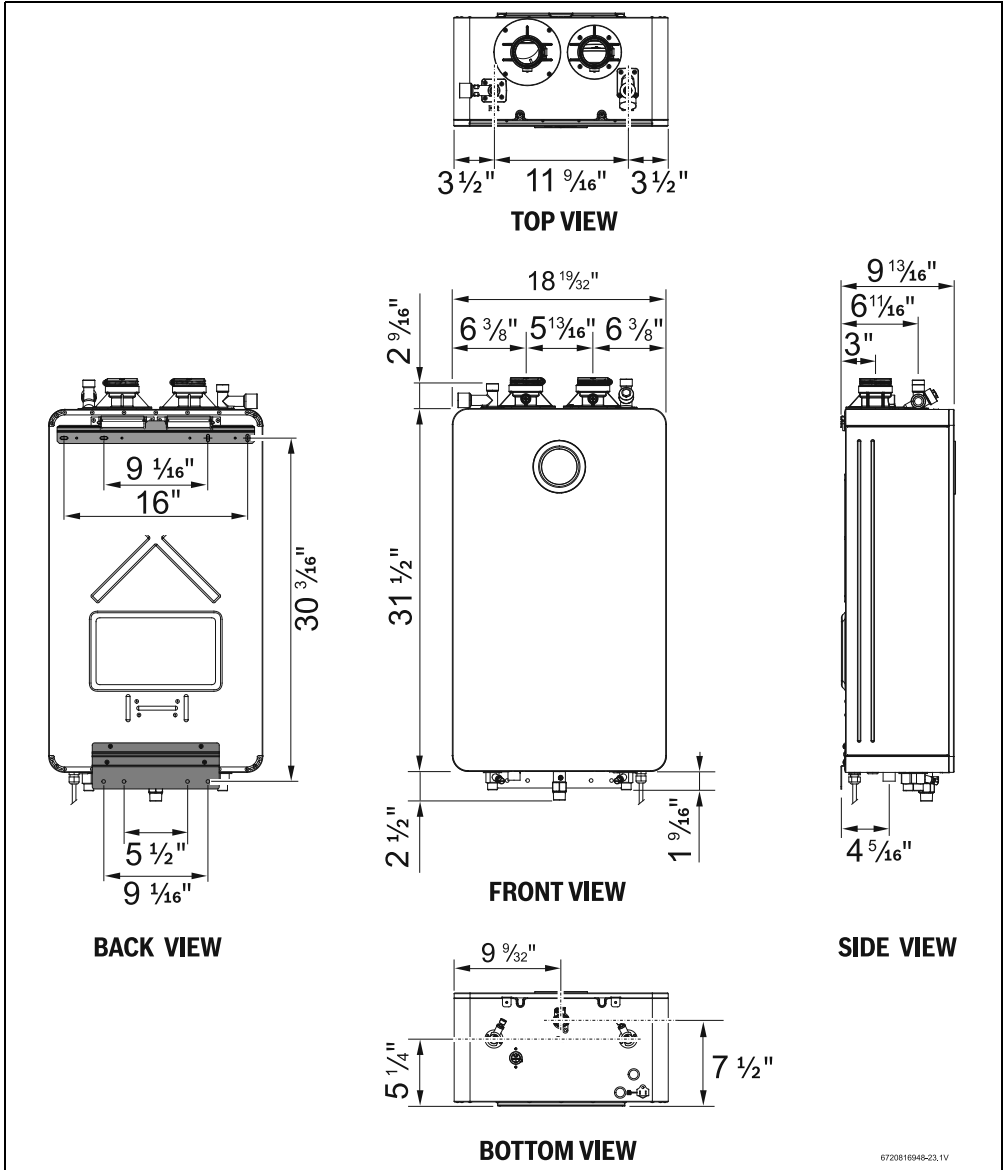

Fig. 5 Dimensions

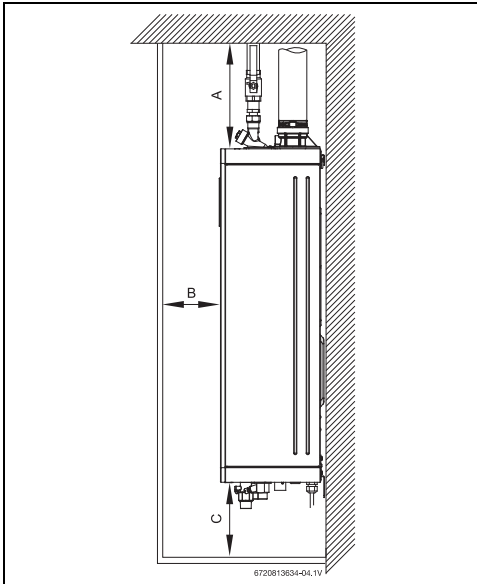

Fig. 6 Side view

	Greentherm 9800 SE / SEC
TOP (A)	12"
FRONT (B)	1"
BACK	0"
SIDES	1"
FLOOR (C)	12"

Table 4 Required minimum clearances for combustibles



For servicing access, a 2ft clearance is recommended to the front cover.

## 4 Installation instructions

### 4.1 Installation tools

The following specialized tools may be required if converting from natural gas to LP:

- Pressure manometer

### 4.2 Introduction

Please follow these instructions. Failure to follow instructions may result in:

- ▶ Damage or injury.
- ▶ Improper operation.
- ▶ Loss of warranty.



#### DANGER:

- ▶ The water heater must be installed by a qualified installer in accordance with these instructions. If improperly installed, a hazardous condition such as explosion or carbon monoxide poisoning could result. Bosch Thermotechnology Corp. is not responsible for improperly installed appliances.



Common installation practice is to first determine the path and method of venting, then design the piping layout.

### 4.3 Proper location for installing your heater

Carefully select the location of the water heater. For your safety and for proper heater operation, you must provide combustion air to the heater and properly vent the exhaust gases. Follow the guidelines below:

- ▶ **1.** Locate the heater where venting, gas and plumbing connections are feasible and convenient.
- ▶ **2.** The hot water lines should be kept short and insulated to save energy. It is recommended to locate the water heater as close as practical to the most frequently used hot water fixtures.



#### NOTICE: Risk of appliance freezing!

- ▶ The water in this water heater is cold and always remains cold except for the times the burner is on. In the event of power outage in conjunction with freezing temperatures, the heater should be drained. See chapter 7.2, page 47 "Winterizing" for draining instructions.

**WARNING:**

- ▶ Flammable materials, gasoline, pressurized containers, or any other items or articles that are potential fire hazards must NOT be placed on or adjacent to the heater. The appliance area must be kept free of all combustible materials, gasoline and other flammable vapors and liquids.

#### 4.4 Heater placement and clearances

The water heater design is approved for installation on a combustible wall (see chapter 4.5 Mounting installation) provided the floor covering below the heater is noncombustible.

For installations in an alcove or closet, maintain the minimum clearances to combustible and non-combustible materials. See fig. 6, page 13.

#### 4.5 Hanging appliance on the wall



**WARNING:** Severe personal injury and property damage!

Before mounting appliance:

- ▶ Check that there are no loose or damaged parts inside the appliance.
- ▶ Set the heater gas type according to the gas supplied to the unit.



Front cover should be removed (see instructions on page 10) in order to inspect components visually.

**WARNING:**

- ▶ Do not install this appliance on a carpeted wall. The heater must be mounted on a wall using appropriate anchoring materials.

**NOTICE:** Risk of appliance freezing!

- ▶ In areas where outside temperature is routinely below 32°F (0 °C) and the heater is to be installed on the inside of an exterior wall, provide a minimum 2" air gap or rigid insulation between the heater back and the wall.

If the wall is sheathed with plaster or drywall, it is recommended that two support boards, either 1"x 4" or 1/2" (minimum) plywood first be attached across a pair of studs, see fig. 7.

- ▶ Secure the wall mounting bracket provided with the heater to a wall surface. The heater must be kept level on the wall surface, see fig. 8, page 15.
- ▶ Hang the appliance on the bracket, see fig. 9.

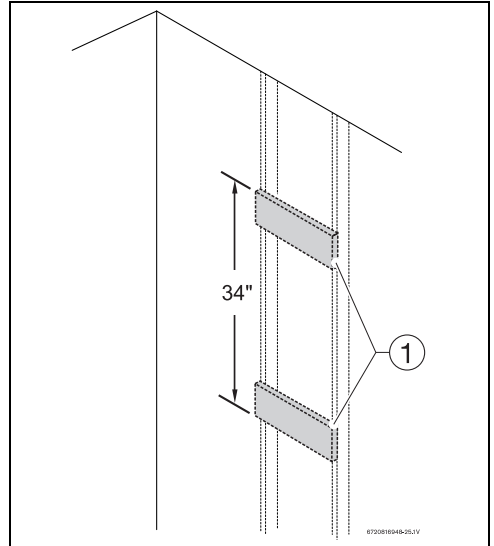

Fig. 7 Distance between support boards

[1] Support boards

Vertical studs are typically 16" (406mm) on center.

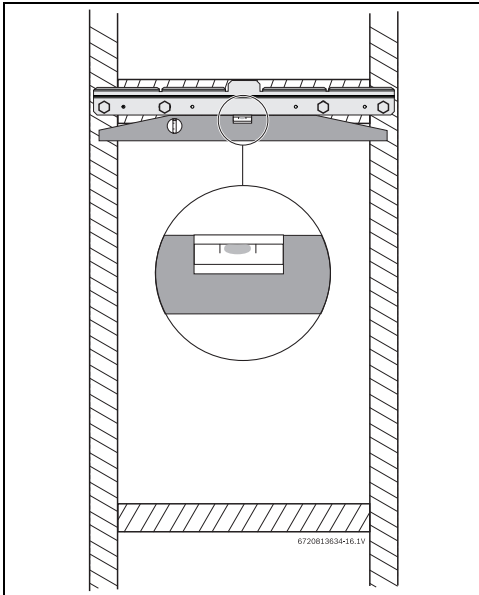

Fig. 8 Leveling wall mounting bracket

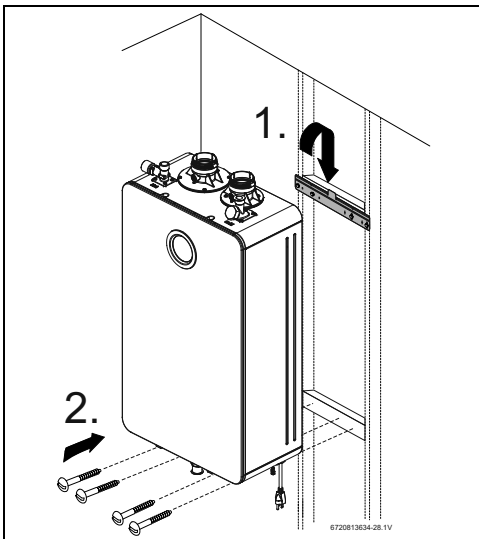

Fig. 9 Mounting the heater

## 4.6 Venting



### DANGER:

- ▶ Do not reduce the exhaust or combustion air vent pipe sizes.
- ▶ Do not common vent with any other vented appliance or stove.
- ▶ Do not use Type-B vent as the actual exhaust vent system for the appliance.



### DANGER: Flue gas poisoning!

- ▶ Failure to vent the exhaust gases to the outside (see table 5 for proper material) may result in dangerous flue gases filling the structure in which it is installed.



### NOTICE:

- ▶ Installations resulting in negative pressure/back draft require sealed combustion (twin pipe / concentric). Damage caused from back draft, ie. freezing, is not covered by warranty.



### NOTICE: Appliance malfunction!

- ▶ Protect the exhaust and inlet from leaves and debris by installing a screen on the end of the termination. ¼ " mesh minimum opening is recommended on screen.



### Flue temperature:

- ▶ To prevent the risk of flue material overheat the appliance's flue temperature is sensed and is limited. The flue temperature limit is depending on inlet water temperature.
- ▶ **Residential models:** Maximum flue temperature is limited to 145 °F.
- ▶ **Commercial models:** Maximum flue temperature is limited to 145 °F with water temperature set points up to 140 °F. When water recirculation mode is activated and temperature set point is above 140 °F, maximum flue temperature is limited to 194 °F. For flue temperature above 145 °F the use of PVC flue material is not allowed.



### CAUTION: Personal injury and property damage.

- ▶ Appliance must be installed vertically.

#### 4.6.1 Vent options

The Greentherm 9800 SE / SEC is approved with the following venting options:

Item	Material		United States	Canada
Vent or air intake pipe and fitting	PP	flexible	M&G / Duravent Centrotherm	Thermoplastic vent pipe must be certified to ULC S636. Air Intake pipe may be of any material listed (left)
		concentric		
		rigid		
	PVC	schedule 40	ANSI/ASTM D1785	
	PVC-DWV		ANSI/ASTM D2665	
	CPVC	schedule 40	ANSI/ASTM F441	
ABS-DWV	schedule 40	ANSI/ASTM D2661		
Pipe cement / primer	PVC		ANSI/ASTM D2564	
	CPVC		ANSI/ASTM F493	
	ABS		ANSI/ASTM D2235	

Table 5 Approved vent materials

**For specific questions concerning vent material, specifications, usage or installation, please contact the vent manufacturer directly.**

Approved Vent Manufacturers;

- M&G
- Centrotherm
- IPEX
- Royal Plastics
- Eccovent
- Charlotte



Do not use cellular foam core pipe for exhaust. Approved for intake only.

The vent connection for the appliance is secured with a clamp on the appliance exhaust adapter. All other vent connections must be glued, except PP and flex PP. Slide the vent pipe into the exhaust adapter. The exhaust pipe must be properly supported and must be pitched a minimum of a ¼ inch per foot back to the appliance. This allows the condensate to drain properly.

Maximum vent lengths and equivalent lengths per table 8 apply.



## 4.6.2 Approved vent components and terminations













Manufacturer	Manufacturer part number	Product description	Diagram	Horizontal	Vertical	Equivalent Lengths (Ft.)
Bosch	196050 196051 196052	2" Bird screen 3" Bird screen 4" Bird screen		■	■	0
-	-	2", 3", and 4" SCH40 (Solid Core) PVC/CPVC 45° long sweep elbow		■	■	1.5
-	-	2", 3", and 4" SCH40 (Solid Core) PVC/CPVC 45° short sweep elbow		■	■	2.5
-	-	2", 3", and 4" SCH40 (Solid Core) PVC/CPVC 90° long sweep elbow		■	■	2.5
-	-	2", 3", and 4" SCH40 (Solid Core) PVC/CPVC 90° short sweep elbow		■	■	5
-	-	2", 3", and 4" SCH 40 (Solid Core) PVC/CPVC "T" terminal w/vent screen		■	■	5
-	-	2", 3" and 4" SCH40 (Solid Core) PVC/CPVC straight pipe		■	■	1
IPEX	196005	PVC Concentric termination (2" by 16" long)		■	■	Exhaust: 1.5 Intake: 20
IPEX	196105	PVC Concentric termination (2" by 28" long)		■	■	Exhaust: 2 Intake: 20
IPEX	196125	PVC Concentric Termination Kit (2" by 40" long)		■	■	Exhaust: 3 Intake: 20
IPEX	196006 / 197009	PVC / CPVC Concentric Termination Kit (3" by 20" long)		■	■	Exhaust: 1.5 Intake: 40
IPEX	196106 / 197107	PVC / CPVC Concentric Termination Kit (3" by 32" long)		■	■	Exhaust: 2 Intake: 40
IPEX	196116 / 197117	PVC / CPVC Concentric Termination Kit (3" by 34" long)		■	■	Exhaust: 2 Intake: 40
IPEX	196021 / 197021	PVC / CPVC Concentric Termination Kit (4" by 36" long)		■	■	Exhaust: 2 Intake: 60

Table 6 Approved PVC/CPVC Vent Components &amp; Terminations



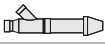

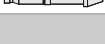

Manufacturer	Manufacturer part number	Product description	Diagram	Horizontal	Vertical	Equivalent Lengths (Ft.)
IPEX	196984 196985 196986	2" PVC Low profile termination kit 3" PVC Low profile termination kit 4" PVC Low profile termination kit		■		Exhaust: 0 Intake: 5
IPEX	081216 081219	2" PVC Wall Termination Kit 3" PVC Wall Termination Kit		■		Exhaust: 15 Intake: 7.5
Temple industries	ECAP 321	2" PVC termination E-Cap 3" PVC termination E-Cap			■	1 4
Royal Plumbing Solutions	52CVKGV6502	2" GVS-65 Concentric Vent Termination Kit		■	■	Exhaust: 2 Intake: 20
Royal Plumbing Solutions	52CVKGV6503	3" GVS-65 Concentric Vent Termination Kit		■	■	Exhaust: 2 Intake: 40
Royal Plumbing Solutions	52SWVKGVS6502 52SWVKGVS6503	2" GVS-65 Side Wall Vent Termination Kit 3" GVS-65 Side Wall Vent Termination Kit			■	Exhaust: 0 Intake: 5

Table 6 Approved PVC/CPVC Vent Components & Terminations



Manufacturer	Manufacturer part number	Product description	Diagram	Horizontal	Vertical	Equivalent Lengths (Ft.)
Duravent M&G	810009685 810009713 810009745	2" PP Twin pipe termination 3" PP Twin pipe termination 4" PP Twin pipe termination		■		Exhaust: 2 Intake: 2
Duravent M&G	810009684 810009712	2" PP Single Horizontal Termination 3" PP Single Horizontal Termination		■		6
Duravent M&G	810009682 810009710	(2" x 4") PP Horizontal Termination Kit - Concentric (3" x 5") PP Horizontal Termination Kit - Concentric		■		Exhaust: 20 Intake: 40

Table 7 Approved PP Vent Components & Terminations











Manufacturer	Manufacturer part number	Product description	Diagram	Horizontal	Vertical	Equivalent Lengths (Ft.)
Duravent M&G	810009692	(2" x 4") Black PP Vertical Termination Kit - Concentric		■	■	Exhaust: 20 Intake: 40
	810009720	(3" x 5") Black PP Vertical Termination Kit - Concentric				
	810009693	(2" x 4") Terra-Cotta PP Vertical Termination Kit - Concentric				
	810009721	(3" x 5") Terra-Cotta PP Vertical Termination Kit - Concentric				
Duravent M&G	810009691	2" Black PP Vertical Termination Cap		■	■	?
	810009719	3" Black PP Vertical Termination Cap				
Centro- therm	ISLPT0202	2" Low profile Wall Termination		■	■	Exhaust: 0 Intake: 5
	ISLPT0303	3" Low profile Wall Termination				
Centro- therm	ICRT2439	2" x 4" Concentric Roof Termination		■	■	Exhaust: 5 Intake: 5
Centro- therm	ICRT3539	3" x 5" Concentric Roof Termination		■	■	Exhaust: 10 Intake: 10
Centro- therm	ICWT242	2" x 4" Concentric Wall Termination		■	■	Exhaust: 4 Intake: 4
Centro- therm	ICWT352	3" x 5" Concentric Wall Termination		■	■	Exhaust: 6 Intake: 6
Ecco Manu- facturing	190288	2" PP Concentric Terminations Horizontal (Wall) Terminations		■	■	Exhaust: 4 Intake: 4
Ecco Manu- facturing	190388	3" PP Concentric Terminations Horizontal (Wall) Terminations		■	■	Exhaust: 6 Intake: 6
Ecco Manu- facturing	190295	2" PP Vertical (Roof) Terminations		■	■	Exhaust: 4 Intake: 4
Ecco Manu- facturing	190395	3" PP Vertical (Roof) Terminations		■	■	Exhaust: 8 Intake: 8

Table 7 Approved PP Vent Components & Terminations

### 4.6.3 Vent specifications

Establish vent clearances that comply with the vent manufacturer's specifications and all applicable national/local codes.

#### Minimum combustion air and exhaust pipe length

The minimum exhaust pipe length is 1 ft (0.3m) of straight vent pipe. The minimum air intake pipe length is 1 ft or one 90° elbow or an air intake grill cap to prevent debris from falling into the appliance.

#### Maximum combustion air and exhaust pipe length

The table 8 displays the maximum allowable straight pipe lengths for air intake and exhaust piping. Reduce the maximum allowable pipe length by the equivalent lengths for each elbow used and termination used.



#### PROPER GAS PRESSURE!

The following section assumes the water heater will receive gas pressure greater than or equal to 5" WC for the 199kBTU models (4" WC for 160kBTU models). In cases of gas pressure below 5" WC for the 199kBTU (4" WC for the 160kBTU models) models the maximum allowable vent length is reduced.



**The values of maximum flue length in table 8 are before any deductions for elbows or terminations.**

Venting	Max equivalent Exhaust length	Max equivalent Intake length
2" Twin pipe	60ft <sup>1)</sup>	60ft
3" Twin pipe	280ft <sup>1)</sup>	280ft
2"/4" Concentric pipe	60ft <sup>1)</sup>	
3"/5" Concentric pipe	280ft <sup>1)</sup>	

Table 8 Maximum Allowable Exhaust and Air Intake Lengths

1) In case gas pressure is below 5" WC for 199 kBTU (4" WC for 160 kBTU) maximum flue length must be reduced; contact Bosch support line for further assistance.



**Improper gas pressure or vent length may result in undesired symptoms or errors such as noisy burner, C1, C2.**

**Required direct vent terminal clearances (twin pipe / concentric penetration)**

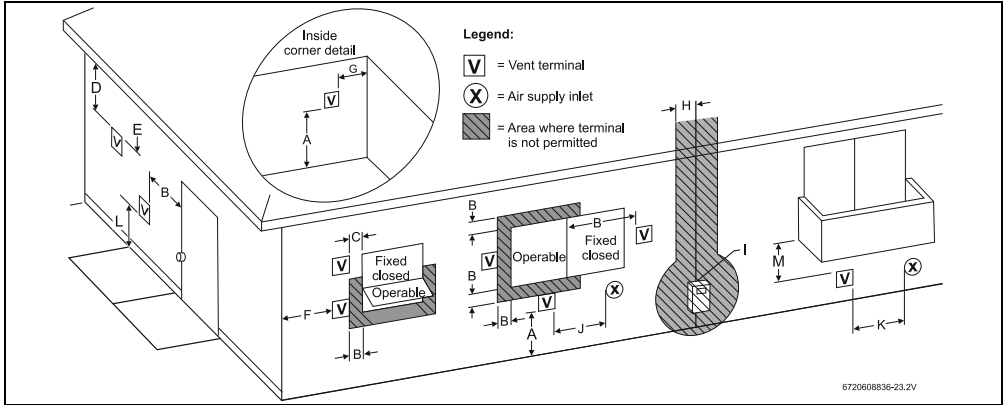

Fig. 10

	Canadian installations <sup>1)</sup> with direct vent terminals	U.S. installations <sup>2)</sup> with direct vent terminals
<b>A</b> Clearance above grade, veranda, porch, deck or balcony	12 in. (30cm)	12 in. (30cm)
<b>B</b> Clearance to window or door that may be opened	36 in. (91cm)	12 in. (30cm) below or to side of opening; 12 in. (30cm) above opening.
<b>C</b> Clearance to permanently closed window	*	*
<b>D</b> Vertical clearance to ventilated soffit located above the terminal within a horizontal distance of 2 ft (61cm) from the center line of the terminal.	*	*
<b>E</b> Clearance to unventilated soffit	*	*
<b>F</b> Clearance to outside corner	*	*
<b>G</b> Clearance to inside corner	*	*
<b>H</b> Clearance to each side of center line extended above meter/regulator assembly	36 in. (91cm) within a height 15 ft (4.6m) above the meter/regulator assembly	*
<b>I</b> Clearance to service regulator vent outlet	36 in. (91cm)	*
<b>J</b> Clearance to nonmechanical air supply inlet to building or the combustion air inlet to any other appliance.	36 in. (91cm)	12 in. (30cm)
<b>K</b> Clearance to a mechanical air supply inlet	6 feet (1.83m)	36 in. (91cm) above if within 10 ft (3m) horizontally
<b>L</b> Clearance above paved sidewalk or paved driveway located on public property	7 ft (2.13m) <sup>3)</sup>	*
<b>M</b> Clearance under veranda, porch deck or balcony	12 in. (30cm) <sup>4)</sup>	*

Table 9

- 1) In accordance with the current CSA B149.1 Natural Gas and Propane Installation Code.
- 2) In accordance with the current ANSI Z223.1 / NFPA 54, National Fuel Gas Code.
- 3) A vent shall not terminate directly above a sidewalk or paved driveway that is located between two single family dwellings and serves both dwellings.
- 4) Permitted only if veranda, porch, deck or balcony is fully open on a minimum of two sides beneath the floor.

[\*] For clearances not specified in ANSI Z223.1 / NFPA 54 or CSA-B149.1, one of the following shall be indicated:  
 a) a minimum clearance value determined by testing in accordance with Clause 5.20, Draft hoods, or;  
 b) a reference to the following footnote:  
 "Clearance in accordance with local installation codes and the requirements of the gas supplier."

**Required other than direct vent terminal clearances (single pipe penetration)**

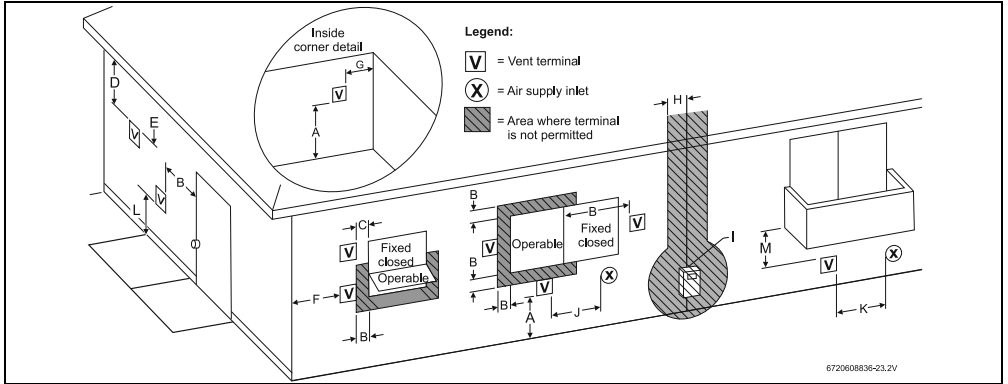

Fig. 11

	Canadian installations <sup>1)</sup> with non direct vent terminals	U.S. installations <sup>2)</sup> with non direct vent terminals
<b>A</b> Clearance above grade, veranda, porch, deck or balcony.	12 in. (30cm)	12 in. (30cm)
<b>B</b> Clearance to window or door that may be opened.	36 in. (91cm)	48 in. (1.2 m) below or to side of opening; 12 in. (30cm) above opening)
<b>C</b> Clearance to permanently closed window	*	*
<b>D</b> Vertical clearance to ventilated soffit located above the terminal within a horizontal distance of 2 feet (61cm) from the center line of the terminal	*	*
<b>E</b> Clearance to unventilated soffit	*	*
<b>F</b> Clearance to outside corner	*	*
<b>G</b> Clearance to inside corner	*	*
<b>H</b> Clearance to each side of center line extended above meter/regulator assembly	36 in. (91cm) within a height 15 ft (4.6m) above the meter/regulator assembly	*
<b>I</b> Clearance to service regulator vent outlet	36 in. (91cm)	*
<b>J</b> Clearance to nonmechanical air supply inlet to building or the combustion air inlet to any other appliance	36 in. (91cm)	48 in. (1.2m) below or to side of opening; 1 ft (300mm) above opening
<b>K</b> Clearance to mechanical air supply inlet	6 ft (1.83 m)	36 in. (91cm) above if within 10 ft (3m) horizontally
<b>L</b> Clearance above paved sidewalk or paved driveway located on public property	7 ft (2.13m) <sup>3)</sup>	*
<b>M</b> Clearance under veranda, porch deck or balcony	12 in (30cm) <sup>4)</sup>	*

Table 10

- 1) In accordance with the current CSA B149.1 Natural Gas and Propane Installation Code.
- 2) In accordance with the current ANSI Z223.1 / NFPA 54 National Fuel Gas Code.
- 3) A vent shall not terminate directly above a sidewalk or paved driveway that is located between two single family dwellings and serves both dwellings.
- 4) Permitted only if veranda, porch, deck or balcony is fully open on a minimum of two sides beneath the floor.

[\*] For clearances not specified in ANSI Z223.1 / NFPA 54 or CSA-B149.1, one of the following shall be indicated:  
 a) a minimum clearance value determined by testing in accordance with Clause 5.20, Draft hoods, or;  
 b) a reference to the following footnote:  
 "Clearance in accordance with local installation codes and the requirements of the gas supplier."

#### 4.6.4 Recommended Vent Configuration Examples

Below are approved examples of vertical and horizontal venting installations.



**NOTICE:** Using a single pipe vent in cold climates puts the water heater at risk of freezing, as negative air pressure is common in buildings during cold weather. This situation will pull cold air through the heat exchanger and can lead to damage and a water leak and is not covered by the product's warranty. In the event of negative air pressure causing back drafting contact Bosch for information.

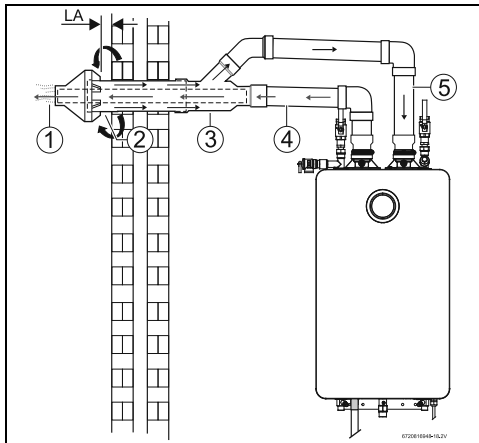

Fig. 12 Horizontal venting system (concentric vent)

- [1] Exhaust
- [2] Air intake
- [3] Concentric Vent kit
- [4] Exhaust pipe
- [5] Air Intake pipe
- [LA] Minimum 1"

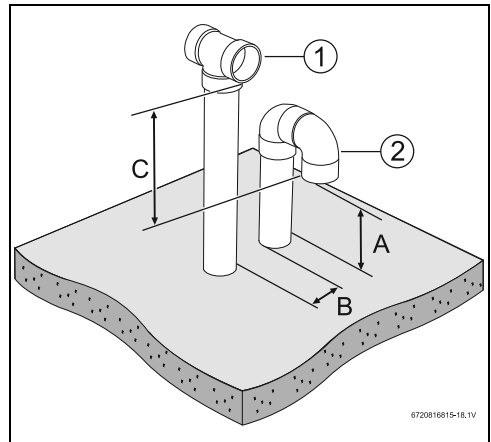

Fig. 13 Vertical venting system

- [1] Exhaust
- [2] Intake
- [A] 12 inches (305 mm) (18 in. for Canada) above maximum snow level or at least 24 inches (610 mm), whichever is greater.
- [B] 12 inches (305 mm)
- [C] 12 inches (305 mm) minimum above air intake opening

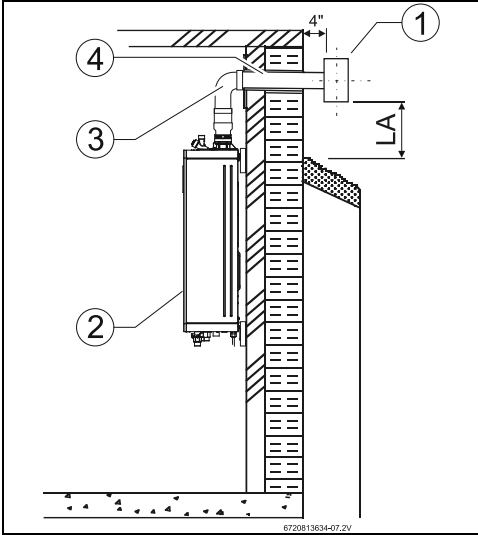

Fig. 14 Horizontal venting installation (air intake piping not shown)

- [1] Termination
- [2] Water heater
- [3] Elbow
- [4] Horizontal run should slope ¼" per foot upwards to water heater
- [LA] 12 inches (305 mm) (18 in. for Canada) above maximum snow level or at least 24 inches (610 mm), whichever is greater.



**NOTICE:**

- ▶ Place pipe supports every 5 feet (1525mm) of horizontal and vertical run, beginning with support near water heater.
- ▶ Periodic cleaning of the vent terminal and air intake screens is mandatory.
- ▶ Avoid locating vent terminals near equipment, vegetation, plants or building features which can be subject to degradation from exhaust gases.

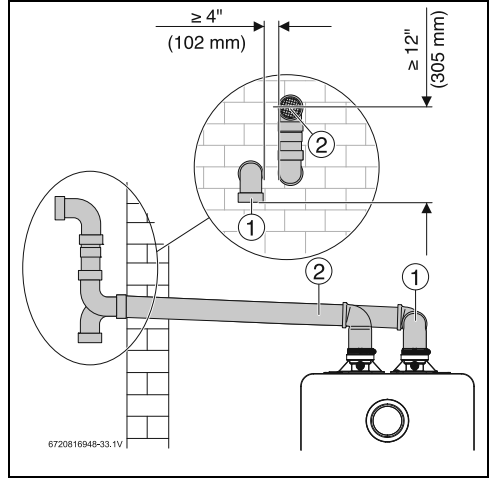

Fig. 15 Horizontal venting system (sealed combustion)

- [1] Intake
- [2] Exhaust

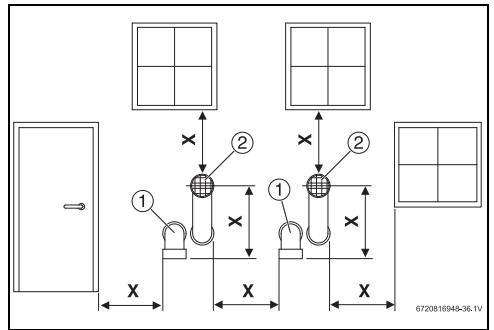

Fig. 16 Vent and air intake pipe position of a sealed combustion system

- [1] Intake
- [2] Exhaust
- [X] At least 1foot (305mm)



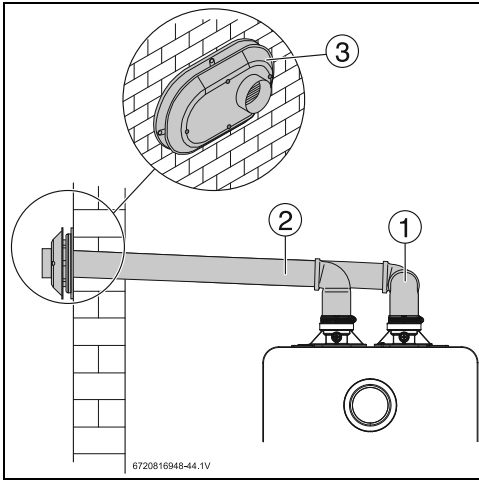

Fig. 17 Horizontal venting system (sealed combustion)

- [1] Intake
- [2] Exhaust
- [3] Termination

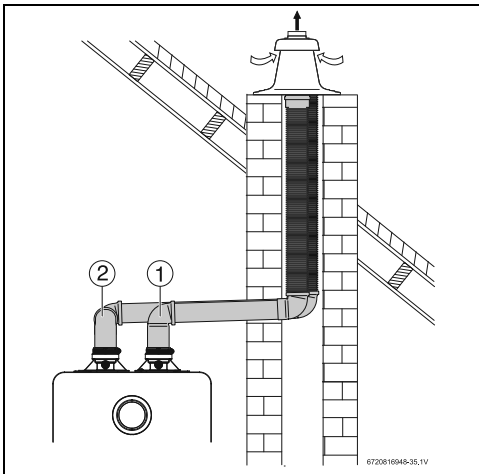

Fig. 18 Vertical venting system with flex PP (sealed combustion)

- [1] Intake
- [2] Exhaust



With Flex Pipe the maximum length is reduced by 60%, (applies only to the section in flex PP). Example: 10 feet of flex PP is equivalent to 25 feet of rigid PP. Flex Pipe according to the suppliers instructions for use in the vertical part of the installation only.

#### 4.6.5 Connecting the condensate water drain



**NOTICE:** Risk of condensate pipe freezing!  
 ► Do not install condensate drain tubing in areas where it may freeze.

#### Appliance condensate drain installation

The appliance comes equipped with an internal condensate drain and siphon. This drains condensation formed in the secondary heat exchanger. Piping must be installed under the condensate drain outlet on the water heater and piped for disposal in accordance with local codes.

To install the condensate drain, connect a 3/8" NPT adapter on the water heater.

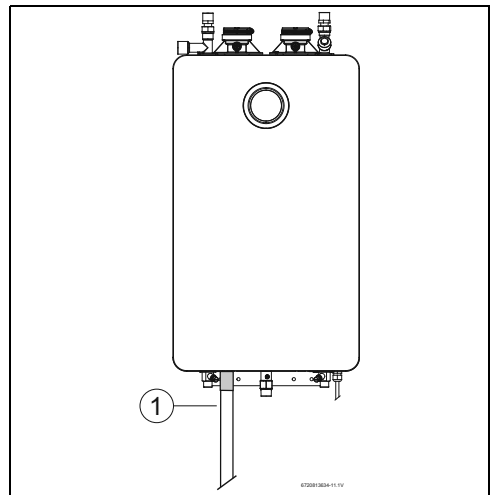

Fig. 19 Appliance drain installation

- [1] Condensate drain connection



Verify condensate disposal/neutralization is in accordance with federal, State, and local regulation.



This is a high efficiency appliance, condensate flow can be as much as 2.1 gal/hr at full power.

#### 4.6.6 Backdraft reducer

The backdraft reducer (9301BFP) is the preferred option for limiting backdraft (see fig. 20).



The backdraft reducer (9301BFP) is sized for 3" diameter PVC.



It is possible to use Backdraft reducer (9301BFP) for 2" installations. This requires 2" to 3" adapters.

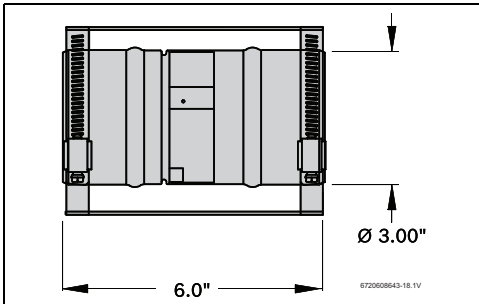

Fig. 20 Part # 9301BFP

#### Installation

For this solution to be effective, the internal flapper must be 100% closed when the water heater is not running. Refer to fig. 22 for preferred installation positions in the vent system.

Installation considerations:

- ▶ Install the damper per the supplied manufacturer's instructions.  
The damper is only to be used in the exhaust vent piping.
- ▶ Ensure directional arrow on damper label faces in the same direction as exhaust flow.
- ▶ If installed horizontally, the axis must be horizontal or slightly pitched up towards termination to ensure damper closes 100% when heater is not running.
- ▶ To allow accessibility, the damper must not be installed in an enclosed section of vent pipe.

- ▶ Do not install the damper in unconditioned spaces (e.g. attics) Condensation can build up while the heater is running which can later freeze and potentially block the flapper.

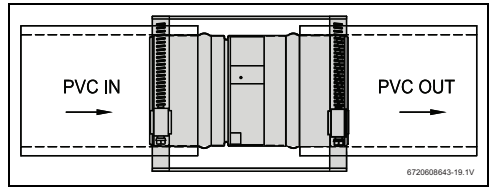

Fig. 21 Backflow reducer (9301BFP) installed

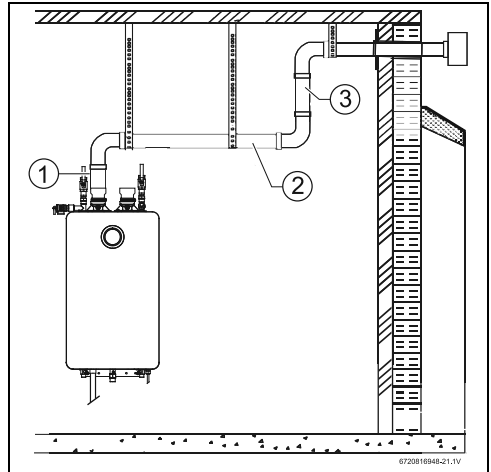

Fig. 22 Installation Recommendation for Placement of Backdraft reducer

- [1] Good
- [2] Better
- [3] Best

#### 4.6.7 Single Pipe Venting



#### NOTICE:

- ▶ Single pipe venting not recommended in cold climates.
- ▶ Installations resulting in negative pressure/back draft require sealed combustion (twin pipe / concentric).
- ▶ Damage caused from back draft, ie. freezing, are not covered by warranty.

**NOTICE:**

- ▶ When installed in an environment where corrosive chemicals or dirty air (e.g. hair salons, car washes) are present the sealed combustion (twin pipe or concentric) is required.

Although it is permissible to draw the air-intake from the inside, it is not the manufacturer's recommended installation method. Install a 90° elbow or air intake screen on the top of the air-intake inlet adaptor to prevent foreign objects from falling into the unit.

If a single pipe installation is utilized, follow guidelines below for providing adequate combustion air for the water heater as well as any other appliances that may consume air in the same space. Always follow local codes and regulations of the authority having jurisdiction.

- **Appliances located in unconfined spaces:**

- **a)** An unconfined space is one whose volume is greater than 50 cubic feet (1.42 cubic meter) per 1000 BTU/hr (292.81 Watts) of the combined rating of all appliances installed in the space. That would be 9950 cubic feet (281.8 cubic meters) or 1243 square feet with 8 foot ceiling, for a single 199 kBTU water heater.
- **b)** In unconfined spaces in buildings of conventional frame, masonry, or metal construction, infiltration air is normally adequate to provide air for combustion.

- **Appliances located in confined spaces:**

The confined space must be provided with two permanent openings, one commencing within 12 inches (304.8mm) of the top and one commencing within 12 inches (304.8mm) of the bottom of the enclosure. Each opening must have a minimum free area of one square inch per:

- 1000 BTU/hr (292.81 Watts) if all air is taken from inside the building
- 2000 BTU/hr (585.62 Watts) if all air is taken from the outside by horizontal ducts
- 4000 BTU/hr (1171.24 Watts) if all air is taken from the outside by direct openings or vertical ducts

Or the confined space must be provided with one permanent opening or duct that is within 12 inches (304.8mm) of the ceiling of the enclosure. This opening must have a minimum free area of one square inch per:

- 3000 BTU/hr (878.43 Watts) if all air is taken from the outside by a direct opening or vertical duct.

Louvers, grills and screens have a blocking effect, when used, increase the sizes of your openings by 300% for wood louvers (as wood type will reduce the free air by 75%) and 43% for

metal louvers (as metal will reduce the free air by 30%). Refer to the National Fuel Gas Code for complete information.

## 4.7 Factory regulation

The appliances are supplied having been set in the factory for the values shown on the rating plate for natural gas. For any other adjustments see chapter 7.

### 4.7.1 Natural gas



The appliances must not be operated if the dynamic gas pressure is less than 3.5" WC<sup>1)</sup> or greater than 10.5" WC.

- 1) To assure maximum heat input at maximum vent length minimum gas pressure should be 5" W.C. for the 199 kBTU models and 4" W.C. for the 160 kBTU models. For more information see section 4.6.3.

### 4.7.2 Liquid propane gas (after gas conversion)



The appliances must not be operated if the dynamic gas pressure is less than 8" WC or greater than 13" WC.

If gas conversion is needed (**Natural Gas to Liquid propane gas**), see section 6.9.

**DANGER:**

- ▶ The gas type conversion must only be carried out by a qualified contractor.

## 4.8 Gas piping & connections

Before connecting the gas supply, be sure that the heater is set for the same gas to which it will be connected.

In the United States: The installation must conform with local codes or, in the absence of local codes, the National Fuel Gas Code ANSI Z223.1/NFPA 54.

In Canada: The Installation must conform to CGA B149 INSTALLATION CODES and/or local installation codes.



### **DANGER:** Explosion hazard!

- ▶ DO NOT connect to an unregulated or high pressure propane line or to a high pressure commercial natural gas line.



### **DANGER:** Explosion hazard!

- ▶ The heater must be isolated from the gas supply piping system during any pressure testing of that system at test pressures equal to or more than 0.5 psig. If overpressure has occurred, such as through improper testing of the gas lines or malfunction of the supply system, the gas valve must be checked for safe operation.

### **GAS CONNECTIONS**

- ▶ Install a manual gas shut off valve on the gas supply line within easy reach of the appliance.
- ▶ Install a union when connecting the gas supply.
- ▶ Gas connection to the water heater is  $\frac{3}{4}$ " NPT. See chapter 4.8.1 for the minimum internal pipe diameter required.
- ▶ Undersized flexible appliance connector is not permitted.
- ▶ National Fuel Gas Code requires that a sediment trap (drip leg) be installed on gas appliances not so equipped. The drip leg must be accessible and not subject to freezing conditions. Install in accordance with the recommendations of the serving gas supplier, see fig. 24.
- ▶ Tighten gas pipe with the support of a wrench, see fig. 23.

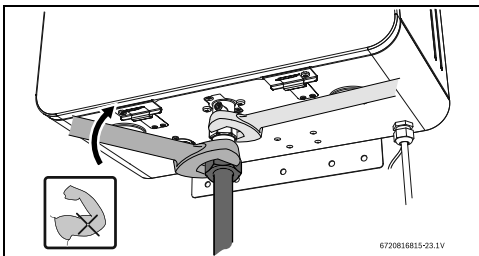

Fig. 23 Tighten gas pipe to the heater

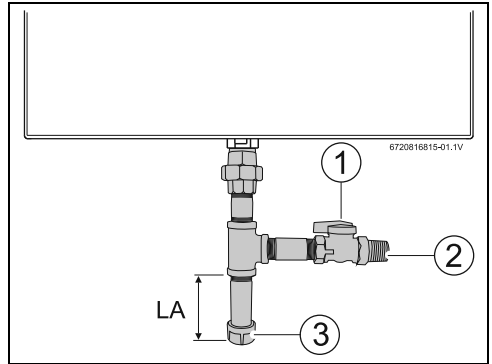

Fig. 24 Gas connection

[1] Shut off valve

[2] Gas supply

[3] Cap

[LA] Minimum 3" sediment trap, (drip leg)

Once connections are made, check for gas leaks at all joints. Apply some gas leak detection solution to all gas fittings. Bubbles are a sign of a leak. A combustible gas detector may also be used to detect for leaks.



### **DANGER:** Explosion hazard!

- ▶ If you detect a leak to the room, shut off the gas and allow for space aeration (open windows, doors). Tighten appropriate fittings to stop leak. Turn the gas on and check again with a gas leak detection solution. Never test for gas leaks using a match or flame.

### **GAS LINE SIZING**

The gas supply piping for a single heater should be sized for a maximum draw of 199000 BTU/hr for Greentherm 9800 SE / SEC 199. Measure the length of the gas supply line from the building's gas main to the heater and use the chapter 4.8.1 and 4.8.2 or the gas line manufacturer's sizing tables to determine the pipe diameter necessary. If there are more gas appliances on the line, size the gas line according to the total maximum amount of BTU draw input rating of for all appliances combined.

**Note:** Undersizing the gas line may result in diminished hot water flow rate and temperature, or improper appliance operation (noise and combustion instabilities). See chapter 4.13, page 36 for the procedure to measure gas pressure. Proper gas pressure must be confirmed at time of installation.

#### 4.8.1 Gas Line Sizing Tables for NATURAL GAS

For your convenience see below for an excerpt from gas line sizing tables for a single NG appliance. For details see the current NFPA 54.

Required input for 160000 / 199000 BTU/hr for the Greentherm 9800 SE / SEC. The gas supply system must be sized for the combined total maximum BTU/hr load requirements of all gas appliances running simultaneously.

The tables below show the maximum capacity of the gas supply pipe in cubic feet per hour. Please contact your local gas supplier for the energy content of the gas to determine the BTU/hr capacity. Use 1,000 BTU/cubic foot for rough estimations.

Maximum pipe capacity in cubic feet of Natural Gas per hour for gas pressures of <2.0 psig (55" WC or 138 mbar) and a pressure drop of 3.0" W.C. (7.5 mbar) based on 0.60 specific gravity gas).

Initial Supply Pressure of 8.0" w.c. or Greater											
Nominal Iron Pipe Size, inches	Internal Diameter inches	Length of Black Iron Pipe (Schedule 40 Metallic Pipe), Feet									
		10	20	30	40	50	60	70	80	90	100
½	0.622	454	312	250	214	190	172	158	147	138	131
¾	0.824	949	652	524	448	397	360	331	308	289	273
1	1.049	1787	1228	986	844	748	678	624	580	544	514

Table 11

Maximum pipe capacity in cubic feet of Natural Gas per hour for gas pressures of <2.0 psig (55" WC or 138 mbar) and a pressure drop of 3.0" W.C. (7.5 mbar) based on 0.60 specific gravity gas).

Initial Supply Pressure of 8.0" w.c. or Greater											
Length of Corrugated Stainless Steel Tubing (CSST), Feet											
EHD*	10	20	30	40	50	60	70	80	90	100	
30	828	580	471	407	363	330	305	285	268	251	
31	958	672	546	471	421	383	355	331	311	295	
37	1,530	1,090	895	778	698	639	593	555	524	498	

Table 12

\* EHD = Equivalent Hydraulic Diameter. The greater the value of EHD, the greater the gas capacity of the tubing.

### 4.8.2 Gas Line Sizing Tables for LP GAS

For your convenience see below for an excerpt from gas line sizing tables for a single LP appliance. Their intended use is for pipe sizing between the 2nd stage (low pressure) regulator and the appliance. For details see the current NFPA 54 or NFPA 58.

Required input for 160000 / 199000 BTU/hr for the Greentherm 9800 SE / SEC. The gas supply system must be sized for the combined total maximum BTU/hr load requirements of all gas appliances running simultaneously.

The tables below show the maximum capacity of the gas supply pipe in thousands of BTU per hour of Undiluted LP Gas at 11" W.C (0.4 psig or 27.4 mbar) based on a pressure drop of 0.5" W.C (1.25 mbar).

Pipe Sizing Between Single- or Second-Stage (Low-Pressure) Regulator and Appliance									
Nominal Iron Pipe inches	Internal Diameter inches	Length of Pipe, Feet							
		10	20	30	40	50	60	80	100
1/2	0.622	291	200	160	137	122	110	101	94
3/4	0.824	608	418	336	287	255	231	212	197
1	1.049	1150	787	632	541	480	434	400	372

Table 13

CSST Sizing Between Single- or Second-Stage (Low-Pressure) Regulator and Appliance Shutoff Valve										
EHD*	Length of Pipe, Feet									
	10	20	30	40	50	60	70	80	90	100
23	254	183	151	131	118	107	99	94	90	85
25	303	216	177	153	137	126	117	109	102	98
30	521	365	297	256	227	207	191	178	169	159
31	605	425	344	297	265	241	222	208	197	186

Table 14

\* EHD = Equivalent Hydraulic Diameter. The greater the value of EHD, the greater the gas capacity of the tubing.

Tube Sizing Between Single- or Second-Stage (Low-Pressure) Regulator and Appliance						
Nominal Iron Pipe inches	Internal Diameter inches	Length of Pipe, Feet				
		10	20	30	40	50
5/8	0.527	188	129	104	89	79
3/4	0.652	329	226	182	155	138

Table 15

Maximum Capacity of Semi-Rigid (flexible, non corrugated) Tubing in Thousands of BTU/hr of Undiluted Liquefied Petroleum Gases (at 11 inches Water Column Inlet Pressure). (Based on a Pressure Drop of 0.5 Inch Water Column)\* Source National Fuel Gas Code NFPA 54, ANSI Z223.1 - No Additional Allowance is necessary for an ordinary number of fittings.

### 4.9 Water quality

Water quality can have an impact on appliance longevity. Water supplied to the Greentherm 9800 SE / SEC must be in accordance with table 16.

For water analysis data call your local water department, or if on a well, have well water analyzed periodically. If water quality exceeds one or more of the values specified below, Bosch recommends consulting a local water treatment professional for water softening/conditioning options.

Description	Max. Levels	
pH	pH	6.5 - 8.5
TDS (total Dissolved Solids)	mg/l or ppm	690
Total hardness	mg/l or ppm	200
Aluminum	mg/l or ppm	2.0
Chlorides	mg/l or ppm	250
Copper	mg/l or ppm	1.0
Iron	mg/l or ppm	0.3
Manganese	mg/l or ppm	0.05
Zinc	mg/l or ppm	5.0

Table 16

### Connecting the pressure relief valve (PRV)

A pressure relief valve is included in the box and must be installed at the time of installation. No valve is to be placed between the PRV and the heater. No reducing coupling or other restriction may be installed in the discharge line. The discharge line must be a minimum of 4" above a drain and installed such that it allows complete drainage of both the PRV and the line. The discharge line must be placed where it will not cause any damage.

- ▶ Use the integrated port to install the PRV, see Fig. 25 [1].
- ▶ Tighten the PRV with the support of a wrench, see Fig. 25.
- ▶ Support all piping.

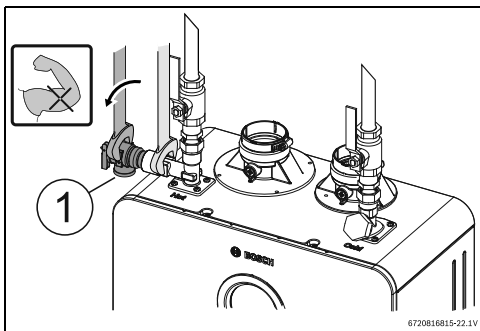

Fig. 25 Plumbing Connections (with shutoff valves) and Pressure Relief Valve

### 4.10 Water connections



Water connections are on top ONLY. Bottom connections are drain/service ports with limited flow capacity.



#### NOTICE:

▶ This heater is not approved for preheated water applications exceeding 140 °F (60 °C) for Residential appliances or 180 °F (82 °C) for Commercial appliances, in these cases use a 3-way valve or mixing valve must be installed before the appliance to prevent water exceeding 140 °F (60 °C) for Residential appliances or 180 °F (82 °C) for Commercial appliances, from entering the appliance.

- ▶ When facing the heater, the 3/4" cold connection is on the top right and the hot connection is on the top left.
- ▶ Tighten all water connections with the support of a wrench, see Fig. 26.

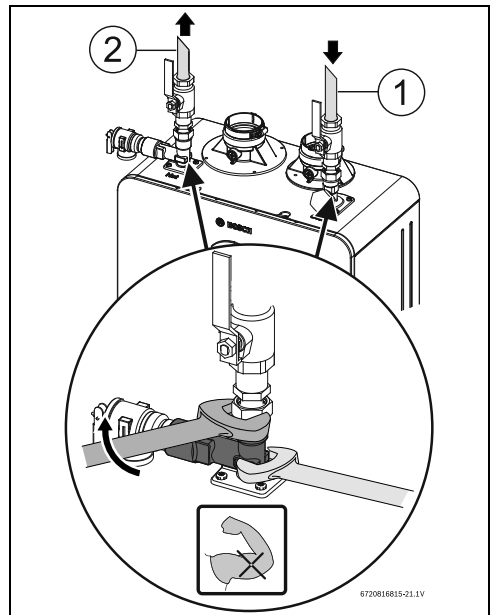

Fig. 26

- [1] Cold connection
- [2] Hot connection

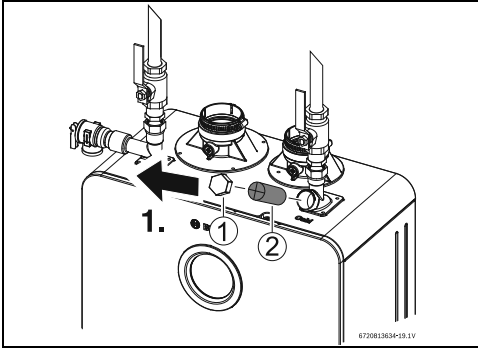

Fig. 27 Water filter

- [1] Cap
- [2] Water filter

**WARNING: Appliance damage!**

Appliance will overheat if not filled with water

- ▶ Ensure that the appliance is filled with water by opening a hot water tap, before plug in the water heater to the power supply.

- ▶ The use of unions when connecting to the inlet and outlet connections is recommended. This will facilitate any necessary servicing.
- ▶ Plastic or PEX type plumbing materials are not suitable for connecting directly to or within 18" of the water heater.
- ▶ Although water piping throughout the building may not be copper, we require that copper or suitably rated stainless steel flex line be used for the water connections for 18" on either side of the water heater (follow local codes if more stringent).
- ▶ Never sweat any piping directly to water connections, as damage will occur.
- ▶ Keep water inlet and outlet pipes to no less than ¾" diameter to allow the full flow capacity.
- ▶ If the cold and hot connections to the heater are reversed, the heater will not function.
- ▶ Be certain there are no loose particles or dirt in the piping. Blow out or flush the lines before connecting to the water heater.
- ▶ Full port shutoff valves should be installed on both the cold water supply and hot water outlet lines to facilitate servicing the heater (see fig. 25).
- ▶ For installation on a private well system with a pressure tank, the lowest pressure range setting recommended is 30-45 psi (2.06 - 3.1bar).

#### 4.11 Domestic hot water recirculation with external pump

Direct recirculation through the tankless water heater is permissible, however, the heat exchanger warranty is reduced; see warranty at [www.boschheatingandcooling.com](http://www.boschheatingandcooling.com).

The following drawing is provided to illustrate one possible recirculation design. This schematic is for illustration only and must not be used for actual installation without appropriate engineering and technical advice from a properly licensed professional in the locality where the installation is made.

This appliance has been designed to permit recirculation by controlling an external pump. For this function, the external pump must be electrically connected to the appliance - Bosch cable accessory (8738713226) is available. All the features of recirculation (→ 6.5.3, **A1 Recirculation**) can be used.

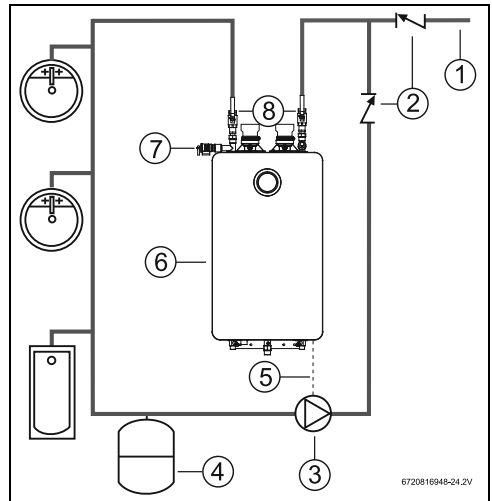

Fig. 28 Recirculation application with a dedicated return line

- [1] Cold water supply
- [2] Check valve, field supplied
- [3] Circulator pump, field supplied
- [4] Expansion tank, field supplied
- [5] Circulator cable accessory
- [6] Greentherm 9800 SE / SEC
- [7] PRV
- [8] Shutoff valves, field supplied



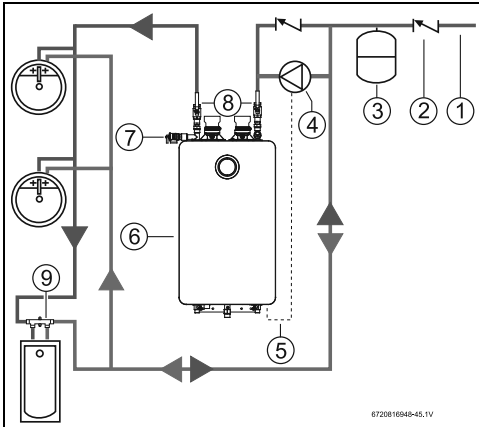

Fig. 29 Recirculation application using the cold water line and a cross-over valve

- [1] Cold water supply
- [2] Check valve, field supplied
- [3] Expansion tank, field supplied
- [4] Circulator pump, field supplied
- [5] Circulator cable accessory
- [6] Greentherm 9800 SE / SEC
- [7] PRV
- [8] Shutoff valves, field supplied
- [9] Cross-over valve, field supplied



Recirculation application showed in fig. 29 is for Greentherm 9800 SE model only. Models with a built-in pump cannot be used.

#### 4.11.1 Recirculation options

##### House Recirculation

This recirculation option uses the appliance's NTC sensor along with the optional schedule to control the pump.

##### Tank loading

This recirculation option gives the option of using one of three temperature sensors to control the recirculation option. The scheduling option is not available for tank loading, except for commercial models.

- **External NTC - 7 736 504 583**
  - Only compatible with Bosch cable/sensor accessory (7736504583).
- **Aquastat - 7 736 504 584**
  - The aquastat connector kit (7736504584) must be used to connect a field supplied aquastat to the appliance.

#### • Internal NTC

- Uses the appliance's NTC sensor to measure the incoming water temperature.

### 4.12 Space heating applications



#### CAUTION:

- ▶ If the set point temperature is above 120°F, precautions should be taken to protect users of potable water from scalding.



#### CAUTION:

- ▶ The use of a flow switch is recommended to ensure DHW priority and to prevent "cold-blow" situations when the Bosch tankless water heater is used with an air handler. Air handler installation must include a pump. The flow switch should be used to disable the blower on the air-handling system when domestic water is used.



#### CAUTION:

- ▶ Ensure the primary pump is properly sized to provide adequate flow for the system heat load.



For external pump sizing please refer to the pressure drop curves, fig. 31. Also remember to account for system piping pressure loss. A minimum of 1.7 GPM is recommended to provide adequate flow through the water heater when determining the size of the primary pump.

#### **Greentherm 9800 SE / SEC tankless water heaters are approved for use in combination DHW and space heating applications (open loop setup).**

These water heaters are not approved for use in space heating only applications (closed-loop setup). Bosch supports applications of combination DHW and space heating in an open loop configuration if plumbed similar to Fig. 30. Please see warranty document for additional details.

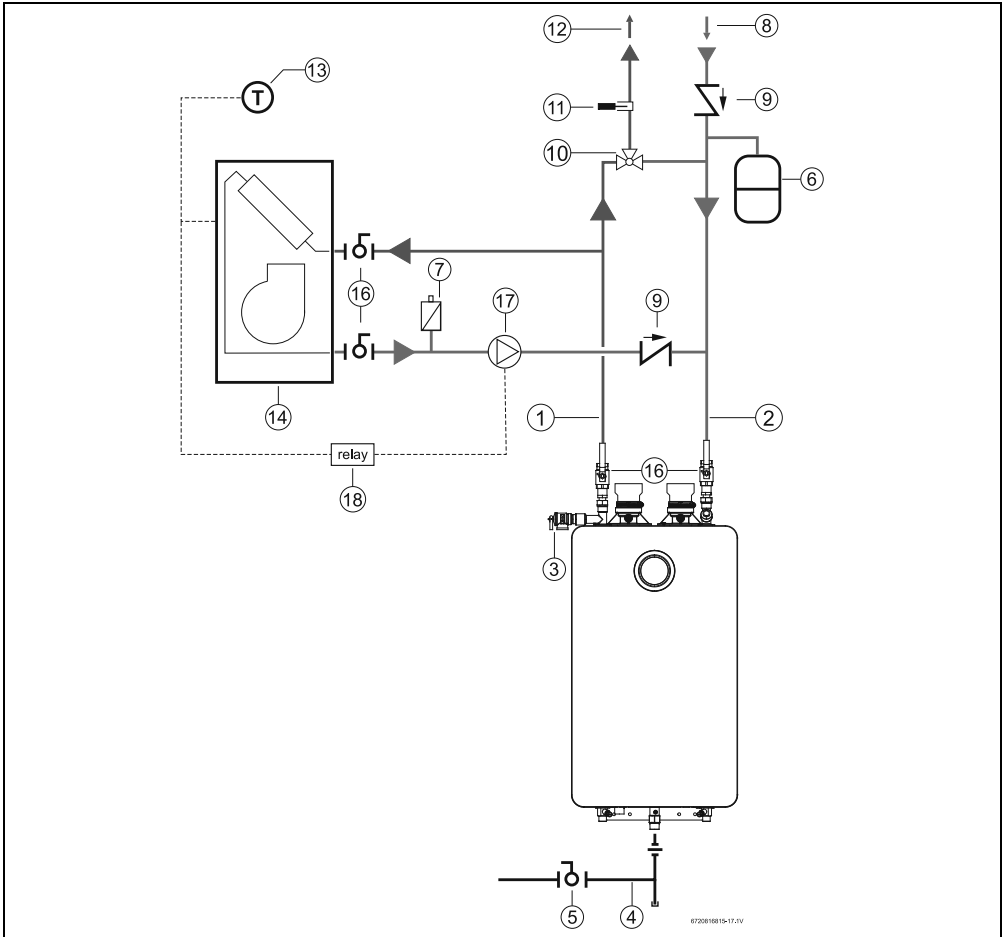

Fig. 30 Hydro air system with water heater

- |   |   |
|---|---|
| [1] Hot water outlet                            | [15] Check valve (field supplied)   |
| [2] Cold water inlet                            | [16] Shutoff valve (field supplied)   |
| [3] Pressure relief valve                       | [17] Circulation pump (only required if air handler doesn't include internal pump) (field supplied) |
| [4] Gas supply                                  | [18] Relay (only required if air handler doesn't include internal pump) (field supplied)            |
| [5] Shut off gas valve (field supplied)         |   |
| [6] Thermal expansion tank (as required)        |   |
| [7] Air purge (field supplied)                  |   |
| [8] Cold water supply                           |   |
| [9] Check valve (field supplied)                |   |
| [10] Thermostatic mixing valve (field supplied) |   |
| [11] Thermometer (optional) (field supplied)    |   |
| [12] DHW outlet                                 |   |
| [13] Thermostat (field supplied)                |   |
| [14] Air handler                                |   |

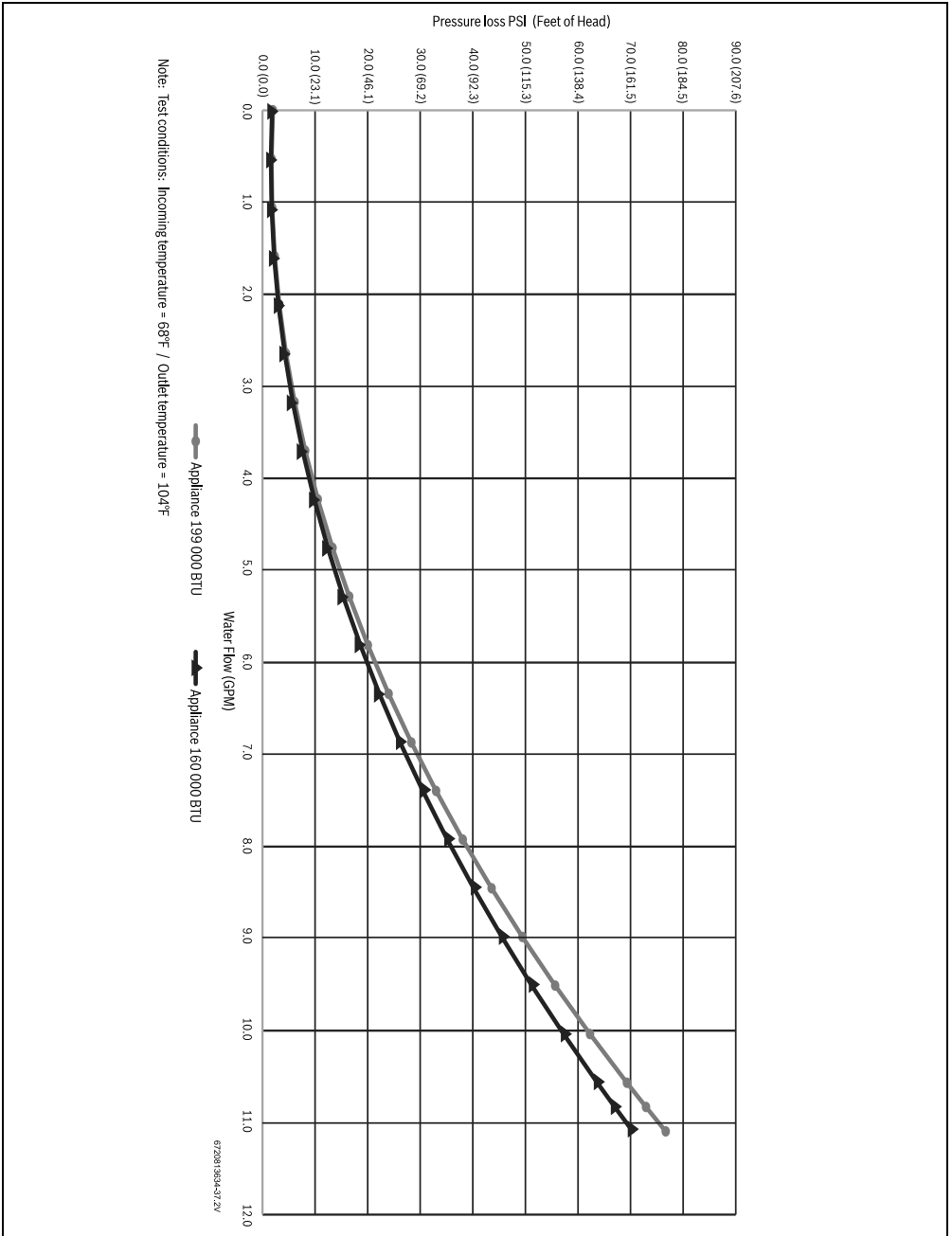

Fig. 31 Pressure drop curve

## 4.13 Measuring gas pressure

### 4.13.1 Gas supply pressure

Confirm gas pressure upon installation.

#### Connecting manometer

- ▶ Shut off gas supply at installer supplied shutoff valve for this water heater.
- ▶ Locate the inlet gas pressure test port (see Fig.32).
- ▶ Loosen the screw inside test port fitting (do not remove) and connect the manometer tube to the test port (see Fig. 32).

#### Static Pressure Test

- ▶ Turn the gas supply back on.
- ▶ Record the static gas pressure reading in table 18.

#### Dynamic Pressure Test

- ▶ Turn ON the appliance.
- ▶ Access menu **P1 Max. Power**, see section 6.6.

Note: While in this mode the appliance will run constantly at maximum power and allow maximum water flow.

For inlet gas pressure adjustment consider the following table:

Gas type	NG	LPG
Inlet gas Pressure	3.5" WC <sup>1)</sup>	8" WC

Table 17 Minimum inlet gas pressure under full operation

- To assure maximum heat input at maximum vent length, the minimum gas pressure should be 5" W.C. for the 199 kBtu models and 4" W.C. for the 160 kBtu models. For more information see section 4.6.3.
- ▶ Operate all other gas appliances (except heater) on the same gas piping system at maximum output.
  - ▶ Open all hot water taps to achieve a flow rate of at least 6 gallons per minute (1 tub and 2 sinks should be sufficient). If heater goes back to P2, open more hot water fixtures to allow sufficient flow to keep the water heater in P1.
  - ▶ Record the lowest operating gas pressure reading in table 18.
  - ▶ Turn OFF the appliance.
  - ▶ Shut off gas supply.
  - ▶ Disconnect the manometer tube from the test point.
  - ▶ Tighten the screw inside test point fitting.

Depending on the vent length, gas pressures below 5" W.C. for Natural Gas or 8" W.C. for LPG may result in reduced power output or possible error codes and must be corrected. See Gas Connections, chapter 4.8, page 28.

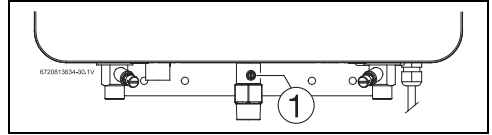

Fig. 32 Gas pressure test port

[1] Gas pressure measuring port

	Gas pressure	Date
Static Gas Pressure Reading		
Dynamic Gas Pressure Reading		

Table 18 Inlet gas pressure readings

## 5 Electrical connections

### 5.1 Electrical power supply



#### WARNING:

- ▶ For safety reasons, disconnect the power supply cord to the water heater before any service or testing is performed.



#### WARNING:

- ▶ This water heater must be electrically grounded in accordance with the most recent edition of the National Electrical Code, NFPA 70. In Canada, all electrical wiring to the heater must be in accordance with local codes and the Canadian Electrical Code, CSA C22.1 Part 1. Do not rely on the gas or water piping to ground the metal parts of the heater.



#### WARNING:

- ▶ Modification of or tampering with the power supply cord is prohibited.
- ▶ Use of extension cords is prohibited.

The water heater requires an electrical power supply from a 120VAC / 60Hz properly rated receptacle and must be properly grounded.

The water heater is wired as shown in the wiring diagram (chapter 10, Fig. 63).

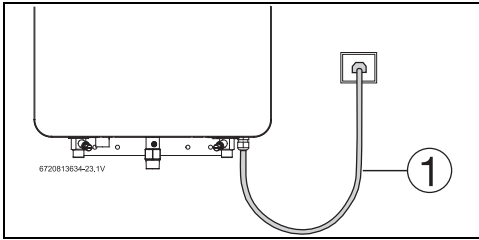

Fig. 33 Connecting power supply cord

[1] Power cord length: 5.9 ft (1.8m).

Note: The power supply that the appliance is plugged into should be isolated from possible water damage. Observe proper clearance to avoid damages.

### 5.2 Position of the fuses in control unit

To check the fuse, proceed as follows:

- ▶ Remove the front cover, see fig. 3, page 10.
- ▶ Disconnect all the cables from the control unit.
- ▶ Press the four snaps of the control unit and remove the cover.

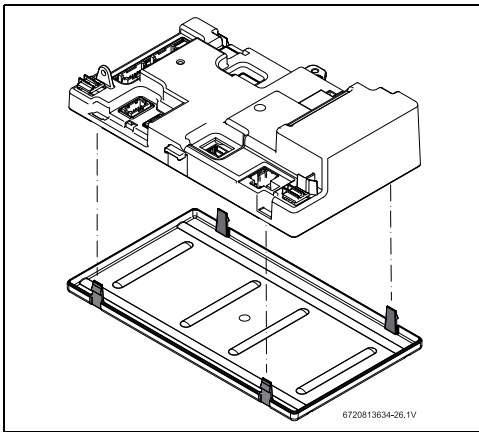

Fig. 34 Control Unit

- ▶ Press the four snaps inside the control unit and remove the PCB.

- ▶ Check the fuse on the printed circuit board, for electrical continuity, see fig. 35, [1].

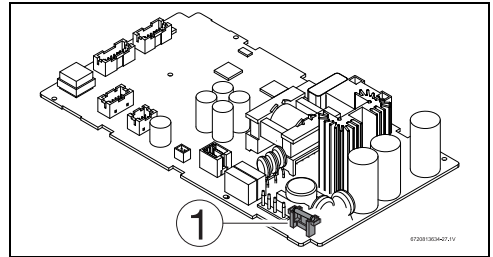

Fig. 35 Fuse position

[1] Fuse

- ▶ After checking the fuse, reinstall all parts in reverse order.

## 6 Operating Instructions

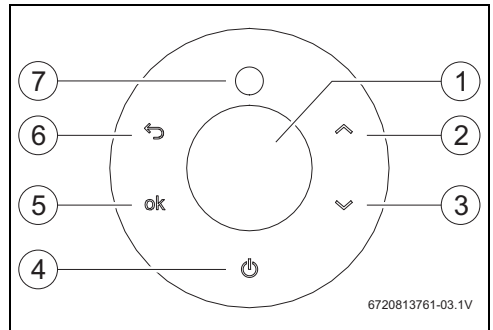

Fig. 36 Touch control display

- [1] LCD display
- [2] Up button
- [3] Down button
- [4] On/Off button
- [5] Confirmation button
- [6] Return button
- [7] Burner status / Error symbol



**NOTICE:**

- ▶ Wipe down with a damp cloth. Do not use any aggressive or corrosive cleaning agents to clean the window.

## 6.1 For your safety read before operating your water heater



### WARNING: Explosion hazard!

- ▶ If you do not follow these instructions exactly, a fire or explosion may result causing property damage, personal injury or loss of life.



### WARNING: Appliance malfunction!

Strong magnetic fields can interfere with the electronics, which can lead to appliance malfunction.

- ▶ Do not attach magnets to this water heater, neither install it near strong magnetic fields.

**A.** This appliance is equipped with electronic ignition for lighting the main burner. When turning the heater on, follow these instructions exactly.

### WHAT TO DO IF YOU SMELL GAS



- ▶ Turn off the gas shut-off valve.
- ▶ Open windows and doors.
- ▶ Do not try to ignite the appliance.
- ▶ Do not touch any electrical switch, telephone, and do not use outlets.
- ▶ Extinguish all open flames. Do not smoke! Do not use lighters!
- ▶ Warn all occupants of the building. Do not ring doorbells!
- ▶ If you can hear gas leaking, leave the building immediately.
- ▶ Prevent others from entering the building and notify the police and fire department from outside the building.
- ▶ From outside the building, call the gas utility company and a trained and certified installer.

**B.** Use only your hand to press the on/off control button. Never use tools. If the touch control display is dirty, wipe down with a damp cloth. Forceful repair may result in a fire or explosion.

**C.** Do not use this appliance if any part has been under water. Immediately call a qualified service technician to inspect the appliance and to replace any part of the control system and any gas control which has been under water.

## 6.2 Power

To turn ON the appliance;

- ▶ Touch and hold symbol  for more than 3 sec.  
The LCD display shows the selected temperature.  
When the burner is on, the display shows symbol 

(Fig. 36, [7]).

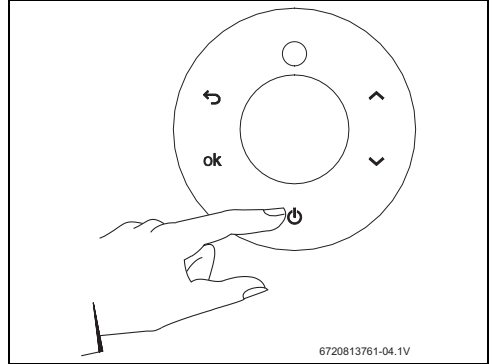



Fig. 37

To shut down the appliance;

- ▶ Touch and hold symbol  for more than 3 sec.

## 6.3 Error code reset

Some possible faults can be solved by resetting the appliance.

To remove an error code from the display,

- ▶ Touch and hold symbol  for more than 3sec.  
The appliance will initiate the start up sequence.



### WARNING: Appliance malfunction!

- ▶ If the problem persists, contact your installer.

## 6.4 Temperature selection

To select a hot water temperature:

- ▶ Touch the symbol  or  until the desired temperature is displayed.

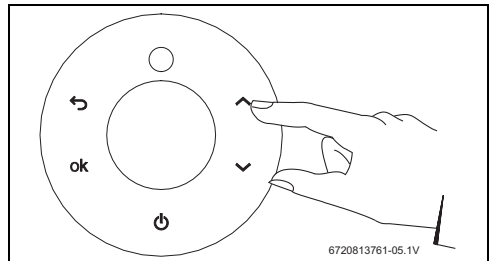

Fig. 38



To increase setpoint temperature limit of the appliance,

- ▶ Access the menu **LM - Temperature Limited** (→ Section 6.6) and select **Unlocked**.

A lower temperature set point will reduce the risk of scalding, reduce energy consumption and increase the longevity of the heat exchanger.



**CAUTION:** The temperature shown on the display is approximate, always check with your hand before bathing children or elderly.

### Setting the water temperature

The desired temperature of hot water can be adjusted on the front control panel of the heater.

The water heater has an electronically controlled gas valve that modulates the burner input in response to both varying hot water flow rates and/or changes in any incoming and outgoing water temperatures.

### Saving water resources:

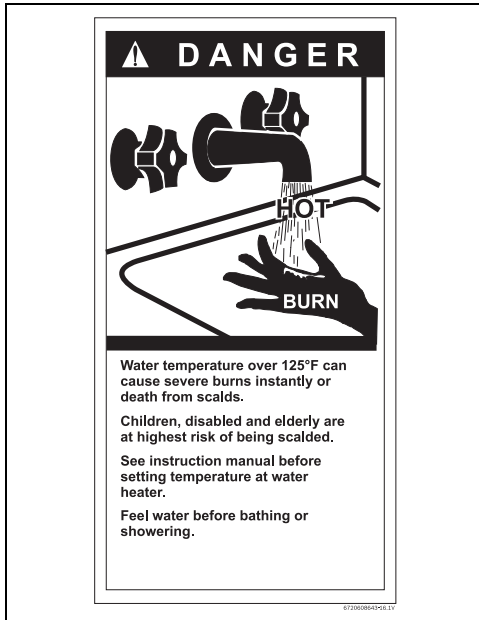

Fig. 39

### 6.4.1 Programming the default setpoint temperature

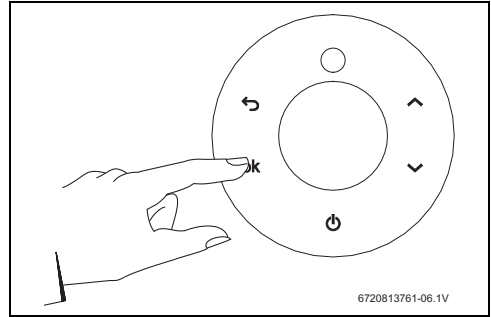

Fig. 40 "Program" key

- ▶ Touch the symbol **^** or **v** to select the desired temperature.
- ▶ Hold the "OK" button for 3 seconds to save the default set point temperature.

When the display stops blinking, the default set point temperature is saved in memory.

### Selecting the default setpoint temperature

In order to select the default setpoint temperature

- ▶ Touch the "OK" button.

Display shows the default setpoint temperature, which is now the hot water selected setpoint-temperature.

### 6.4.2 Solar Mode

If the appliance does not ignite, it means that the desired set temperature would be exceeded even running at minimum BTU. In this condition, the solar mode indicator will show on the display.

In most cases, solar mode is activated if the inlet water temperature exceeds the set point temperature minus 1 °F (0.5 °C).

#### Solar mode/warm inlet temperature activation formula

$$\text{Temp. inlet} \geq [\text{Temp. set} - 1^\circ\text{F} (0.5^\circ\text{C})]$$



$$\text{Ex.: } 111^\circ\text{F} (43.9^\circ\text{C}) \geq [112^\circ\text{F} (44.4^\circ\text{C}) - 1^\circ\text{F} (0.5^\circ\text{C})]$$

Table 19

## 6.5 Information /Adjustments menu

### Access to Information / Adjustments menu

Display shows the set point temperature.

- ▶ Touch the symbol  .  
Display shows **P4 Information**.
- ▶ Touch symbols  or  to scroll through the available menus.

### Available menus

Display	Description
P4	Information (section 6.5.1)
P9	Purge (section 6.5.2)
SA	Settings (section 6.5.3)
AU	Technical Settings [service mode] (section 6.5.4)

Table 20

#### 6.5.1 “P4” - Information

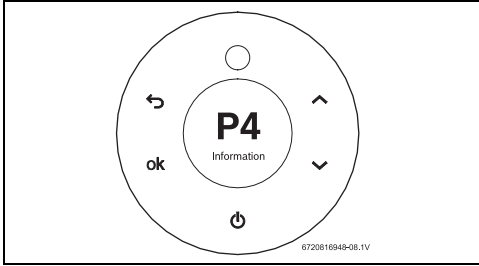



Fig. 41 P4 - Information

This menu provides access to several parameters.

- ▶ Access to information / adjustments menu.  
Display shows **P4 Information**.
- ▶ Touch the symbol **ok** .  
Display shows **DH Data History**.
- ▶ Touch the symbols  or  to choose the following information.
  - **DH Data History**
  - **OD Operation Data**
  - **FH Failure History**
  - **AC Consumptions**
  - **HS About**
- ▶ Touch the symbol **ok** to selected the desired information.

#### DH Data History

Allows you to view two parameters:

- **Operation Cycles** - number of times burner has been started.

- **Operation Hours** - number of hours burner has been operational.

#### OD Operation Data

Allows you to view various parameters of the current operation of the appliance:

- **Chamber NTC** - current water temperature at heat exchanger outlet.
- **Inlet NTC** - current temperature of the temperature sensor of the water inlet tube.
- **Outlet NTC** - current temperature of the temperature sensor of the water outlet pipe.
- **Fan Speed** - current fan speed.
- Flow - total flow, through main valve + bypass.
- **Output Power** - % current power.
- **Ambient NTC** - current temperature inside cabinet near the fan.
- **Exhaust Gas NTC** - Exhaust flue gases temperature sensor.
- **SS Hex NTC** - Flue gases temperature sensor at the condensing unit inlet (between heat exchangers).
- **External Tank** - current temperature on the external tank.
- **Barometric pressure** - current barometric pressure at installation location.
- **ION** - current ionization value.

#### FH Failure History

Allows you to view the last 10 error codes.

#### AC Consumption

Allows for displaying, in graphic form, the consumption of gas and water for the last 5 operations longer than 1 minute.

#### HS About

Allows you to view the versions of software / hardware installed on the water heater.

#### 6.5.2 “P9” - Purge

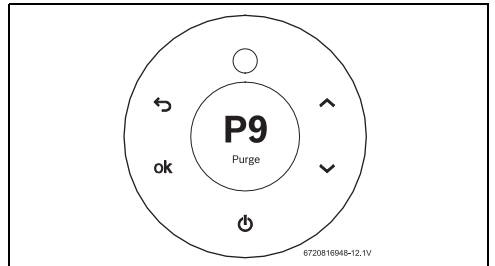



Fig. 42 P9 - Purge

This menu allows you to purge the exhaust circuit.

- ▶ Access to information / adjustments menu.  
Display shows **P4 Information**.



- ▶ Touch the symbol  until the display shows **P9 Purge**. After 2 sec. the fan starts working to purge the exhaust circuit.



The fan remains running until the Purge menu is exited, to do so:

- ▶ Touch the symbol .

### 6.5.3 SA - Settings

Only to be use when domestic recirculation is installed.

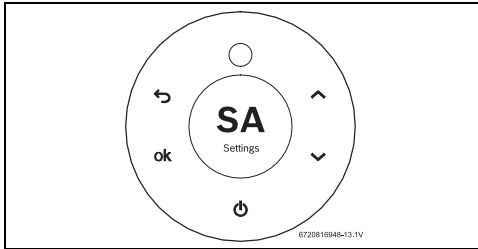





Fig. 43 SA - Settings







This menu provide access to several parameters.

- ▶ Access to information / adjustments menu. Display shows **P4 Information**.
- ▶ Touch the symbol  until the display shows **SA Settings**.
- ▶ Touch the symbol **ok** . Display shows **A0 Clock/Date**.
- ▶ Use the symbols  or  to scroll through the information/adjustments menus.
  - **A0 Clock/Date**
  - **A1 Recirculation**
  - **A2 Vacations**
  - **A3 Language Set**
  - **A4 Demonstration**
  - **A5 Reset Appliance**
  - **A6 Display Position**
  - **A7 Wireless Connectivity**
  - **A8 Startup Delay**
  - **A9 Units Set**
  - **AA Display Timeout**
  - **AB Region Selection**
- ▶ Touch the symbol **ok** to select the desired information.









#### A0 Clock/Date

Set the **time**:

- ▶ Touch the symbol **ok** . Display shows Clock and Date menu.
- ▶ Touch the symbol **ok** to set the Clock.



- ▶ Use the symbols  or  to set the hours.
- ▶ Touch the symbol **ok** when hour is correct.
- ▶ Use the symbols  or  to set the minutes.
- ▶ Touch the symbol **ok** when minutes are correct.
- ▶ Use the symbols  or  to choose **a.m.** or **p.m.**
- ▶ Touch the symbol **ok** to exit the **Clock** menu.

Set the **Date**:

- ▶ Use the symbols  or  to choose the **Date** menu. Display shows Date menu: MM / DD / YYYY.
- ▶ Touch the symbol **ok** .
- ▶ Use the symbols  or  to set the month.
- ▶ Touch the symbol **ok** when month is correct.
- ▶ Use the symbols  or  to set the day.
- ▶ Touch the symbol **ok** when the day is correct.
- ▶ Use the symbols  or  to set the year.
- ▶ Touch the symbol **ok** when the year is correct.
- ▶ Touch the symbol **ok** to exit the **Date** menu. Clock and Date are defined.
- ▶ Touch the symbol , the Hours and Clock blink 3 times and exit menu.





#### A1 Recirculation

Choosing a recirculation program:

- ▶ Use the symbols  or  to scroll through the options.
  - **HR House Recirculation**
  - **TL Tank Loading**
  - **OFF Off**











#### HR House Recirculation

Creating a **Schedule**:











- ▶ Touch the symbol **ok** , to select **Schedule**.
- ▶ Touch the symbol **ok** , to enter the programming menu. Display shows week days.
- ▶ Touch the symbol **ok** , to select a week day.
- ▶ Use the symbols  or  to choose option **Add New**.
- ▶ Touch the symbol **ok** , to enter the recirculation program.
- ▶ Use the symbols  or  to choose the beginning hour.
- ▶ Touch the symbol **ok** , to set the beginning hour.
- ▶ Use the symbols  to choose the end hour.
- ▶ Touch the symbol **ok** , to set the ending hour. A recirculation period is defined. The user can add additional recirculation periods on the same day.
- ▶ Touch the symbol **ok** , to select **Add New** and repeat all steps mentioned above.

### Copy recirculation program,

The user can copy the recirculation period(s) to other week days.

- ▶ Use the symbols  or  to select the day of the week to be copied.
- ▶ Use the symbols  or  to choose option **Copy to**.
- ▶ Touch the symbol  .  
Display shows week days.
- ▶ Touch the symbol  to select the day of the week.
- ▶ Use the symbols  or  to choose another week day.  
When week days are selected,
- ▶ Touch the symbol  to validate operation.
- ▶ Touch the symbol  to exit.

### Deleting a recirculation program,

- ▶ Use the symbols  or  to select the day of the week to be deleted.
- ▶ Touch the symbol  .
- ▶ Use the symbols  or  to choose option **Delete**.
- ▶ Touch the symbol  .
- ▶ Use the symbols  or  to choose a recirculation period.
- ▶ Touch the symbol  twice to delete recirculation period.
- ▶ Touch the symbol  to exit.

### AA Always Active

- ▶ Touch the symbol  to select **ON**.  
Recirculation will be always active.

### TL Tank Loading

- ▶ Touch the symbol  .  
Display shows following menu.
  - **External NTC**
  - **Internal NTC**
  - **Aquastat**

Select the menu according with the installation.

### OFF

- ▶ Touch the symbol  , to select **OFF**.  
Recirculation will not be active.















### A2 Vacations

Set Vacation time.







The burner will not activate while the appliance is in vacation mode.

- ▶ Touch the symbol  .  
Display shows Vacation menu.

- ▶ Use the symbol  to choose **On**.  
On starts to blink.
- ▶ Touch the symbol  to define first day of vacation: MM/DD/YYYY.
- ▶ Use the symbols  or  to set the month.
- ▶ Touch the symbol  when month is correct.
- ▶ Use the symbols  or  to set the day.
- ▶ Touch the symbol  when day is correct.
- ▶ Use the symbols  or  to set the year.
- ▶ Touch the symbol  when year is correct.
- ▶ Use the symbols  or  to define the total of days.
- ▶ Touch the symbol  to finish programming.
- ▶ Touch the symbol  to activate vacation program.

### Deactivating the vacation program.

- ▶ Use the symbol  or  to select "Off"  
Off starts to blink.
- ▶ Touch the symbol  .  
Off option is selected.
- ▶ Touch the symbol  to deactivate vacation program.

### A3 Language

Set the language.

### A4 Demonstration

Simulates in the display, the appliance is functioning.

(Only available when burner is not working)

### A5 Reset appliance



Factory default settings and parameters.



- To reset the settings and parameters:
- ▶ Touch the symbol  for 3 secs.

### A6 Display Position

Set the position:

- ▶ Touch the symbol  ,  
Adjust "Burner status/Error symbol" (→Fig. 36, [1])  
display position;
  - **Vertical**
  - **Horizontal**
- ▶ Touch the symbol  ,  
Adjust "LCD display" position (→Fig. 36, [7]);
  - **Vertical**
  - **Horizontal**



After the display's position has been adjusted:

- ▶ Touch the symbol ↶ to exit.

### A7 Wireless Connectivity

Only available with WIFI accessory module.

- ▶ Touch the symbol **ok** .  
Display shows following menu.
  - **BL Bluetooth**
  - **WIFI**

### A8 Startup Delay

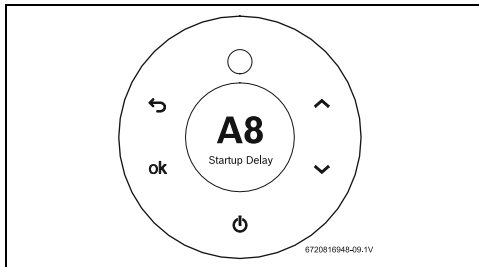

Fig. 44 A8- Startup Delay

This menu allows programming a burner start delay between 0 and 60 seconds, after detecting water flow.

- ▶ Access to information / adjustments menu.  
Display shows **SA Settings**.
- ▶ Use the symbols **^** or **v** to choose **A8 Startup Delay**.
- ▶ Touch the symbol **ok** .  
Display shows **Startup Value(s)**.
- ▶ Touch the symbol **ok** .
- ▶ Touch the symbols **^** or **v** to define, in seconds, the delay to start-up after detection of the water flow.
- ▶ Touch the symbol **ok** after reaching the desired value.

### A9 Units Set

This menu allows you to choose the units visible on the display.

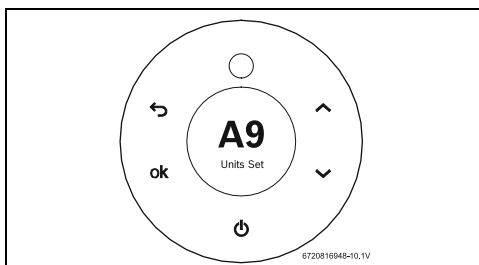

Fig. 45 A9- Units

- ▶ Access to information / adjustments menu.  
Display shows **SA Settings**.
- ▶ Touch the symbol **v** until **A9 Units is in the display**.
- ▶ Touch the symbol **ok** .
- ▶ Use the symbols **^** or **v** to select measurement units.

### Metric ( °C l/min)

### Imperial ( °F gal/min)

- ▶ Touch the symbol **ok** after selecting the desired units.  
The selected units blinks, display indicates **A9 Units**.

### AA Display Timeout

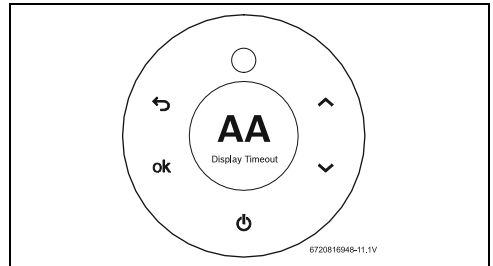

Fig. 46 AA- Backlight Control

Activation of brightness control increases energy savings when the appliance is idle.

This menu lets you control 3 parameters of the display when idle, or when the unit is not in use:

- enable / disable brightness control
- after which time the brightness control is activated
- brightness level
- ▶ Access to information / adjustments menu.  
Display shows **SA Settings**.
- ▶ Touch the symbol **v** until the display shows **AA Backlight Control**.
- ▶ Touch the symbol **ok** .  
Display shows **Backlight**.

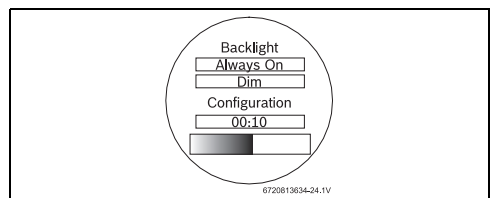





Fig. 47 Backlight control menu

- ▶ Touch the symbol **ok** .
- ▶ Use the symbols **^** or **v** to select **DIM**.
- ▶ Touch the symbol **ok** .

- ▶ Use the symbols  or  to set between 10 seconds and 1 hour.
- ▶ Touch the symbol **ok** after reaching the desired value. The time is defined, the brightness value must now be programmed.
- ▶ Use the symbols  or  to set the brightness of the display when in period of inactivity.
- ▶ Touch the symbol **ok** after reaching the desired brightness.

### AB Region Selection

- ▶ Touch the symbol **ok** .  
Display shows following menu.
  - **Europe**
  - **North America**

### 6.5.4 AU - Technical Settings







#### DANGER:

- ▶ Only for trained personnel.

- ▶ See section 6.6.

## 6.6 Service menu - AU Technical Settings



### Accessing the AU Technical Settings menu

- ▶ Touch the symbol  .  
Display shows **P4 Information**.
- ▶ Touch symbols  or  to select **AU Technical Settings** menu.
- ▶ Touch the symbol **ok** .  
Display shows Technical Settings menu (password input).
- ▶ Select the password. The password is 1886. Technical Settings completed.
- ▶ Touch the symbol  .  
Access to **installer exclusive menus**.

- **P0 - Min. Power**
- **P1 - Maximum Power**
- **P2 - Minimum Power**
- **UC - Combustion Auto Adjust**
- **P7 - Gas Type (LPG, NG)**
- **PC - Cascading (activation / deactivation)**
- **LM - Temperature Limited**
- **PE - Appliance Type**
- **PF - Bypass Activation**
- **PA - Actuator**



### LM Temperature Limited

Unlock the Temperature Limit

- ▶ Touch the symbol **ok** .  
Display shows following menu.
  - **Unlocked**
  - **Locked**
 The current selection is in green color.
- ▶ Touch symbols  or  to select **Unlocked**.
- ▶ Touch the symbol **ok** .
- ▶ Touch the symbol  to return to main menu.



### PF Bypass Activation

To Enable or Disable bypass function.



- ▶ Touch the symbol **ok** .  
Display shows following menu.
  - **Off**
  - **On**
 The current selection is in green color.
- ▶ Touch symbols  or  to select the desired option.
- ▶ Touch the symbol **ok** .
- ▶ Touch the symbol  to return to main menu.

## 6.7 Factory default settings

### Restore factory values for P1 Max. Power

- ▶ Access to menu **P1 Max. Power**.
- ▶ Touch symbols  or  to select **Reset Parameters**.
- ▶ Touch the symbol **ok** .  
The display blinks to confirm change.
- ▶ Touch the symbol **ok** .  
The factory default values for **P1** are restored.

### Restore factory values for P2 Max. Power

- ▶ Access to menu **P2 Min. Power**.
- ▶ Touch symbols  or  to select **Reset Parameters**.
- ▶ Touch the symbol **ok** .  
The display blinks to confirm change.
- ▶ Touch the symbol **ok** .  
The factory default values for **P2** are restored.

## 6.8 Water actuators calibration



Water actuators calibration must be done when main water valve or bypass valve is replaced. Also required when electronic control unit is replaced.



The water actuators calibration process takes several minutes.

- ▶ Do not interfere with the appliance.



Only possible after access Technical Settings menu (→ section 6.6).

### 6.8.1 MF main valve auto calibration

- ▶ Open one hot water tap.
- ▶ Access menu **PA**.
- ▶ Touch symbol **OK**.
- ▶ Touch symbols **^** or **∨** to select **MF main valve**.
- ▶ Touch symbol **OK**.  
The appliance will start the auto calibration of main valve.



Water flow will shut-off.  
▶ Wait until indication of calibration completed appears on the screen.

- ▶ Touch the symbol **↩** to return to main menu.

### 6.8.2 BP bypass valve auto calibration

- ▶ Open one hot water tap.  
Flow rate between 0.80 GPM and 1.80 GPM is required.  
It's possible to confirm this value by entering **P4 Information** menu.
- ▶ Access menu **PA**.
- ▶ Touch symbol **OK**.
- ▶ Touch symbols **^** or **∨** to select **BP bypass valve**.
- ▶ Touch symbol **OK**.  
The appliance will start the auto calibration of the bypass valve.



The display shows the flow rate.  
▶ You should adjust the flow rate at the beginning of the calibration process.  
▶ Wait for the indication that the calibration is completed to appear on the screen.

- ▶ Touch the symbol **↩** to return to main menu.

## 6.9 Gas type



Only possible after access **Technical Settings** menu.

- ▶ Access to menu **P7 Gas Type**.  
Display shows appliance gas type.
- ▶ Use the symbols **^** or **∨** to confirm gas type.



The gas type conversion must only be carried out by a qualified contractor.

- ▶ Touch the symbol **ok**.  
Display blinks 3 times and return to **P7** menu.

### 6.9.1 Gas conversion from NG to LPG



**DANGER: Fatal accidents!**  
Before any service or testing in the appliance,

- ▶ Turn off the appliance.
- ▶ Disconnect the power supply cord.
- ▶ Shut off the gas supply.



The gas type conversion must only be carried out by a qualified contractor.

- ▶ Turn Off the appliance.
- ▶ Remove the front cover from the appliance (section 3.3.2).
- ▶ Remove the four screws that retain the cover plate to the gas manifold, see fig. 48 (plate in grey color).

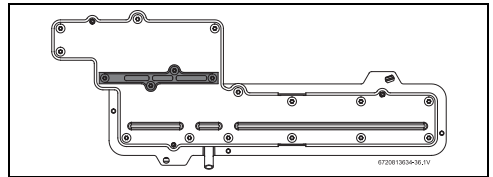

Fig. 48 Gas manifold

- ▶ Remove metal plate and seal.
- ▶ The 3 restrictor plates should be pre-assembled onto their tray, but if loose in box, follow installation instructions, as shown in fig. 49 and 50 [1].
- ▶ Insert the LP conversion plate in the appropriate location shown in fig. 49 and 50 [2].



**CAUTION:**

- ▶ All three flow restrictors and seal must be assembled according to the fig. 49 and 50, to assure correct appliance performance.

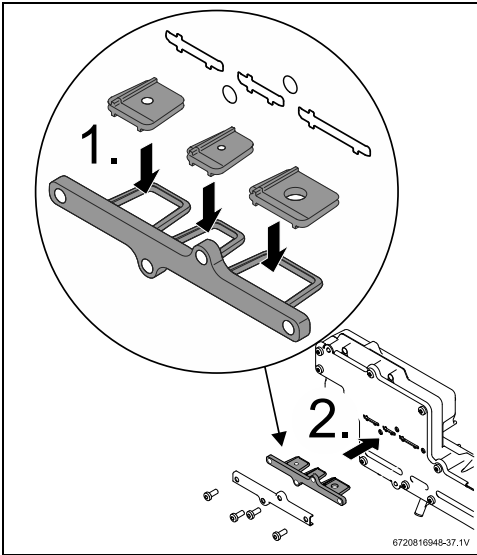

Fig. 49 199kBTU appliance gas conversion kit

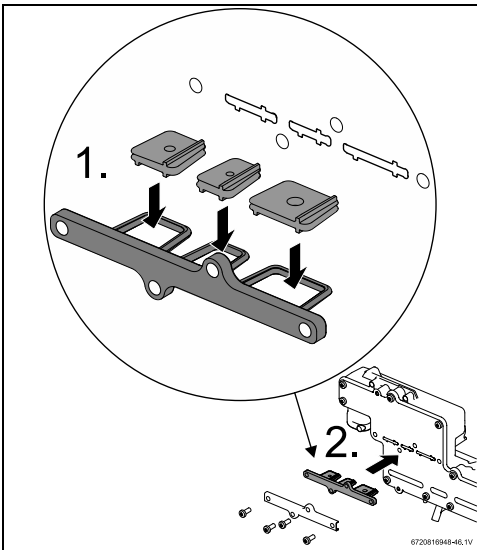

Fig. 50 160kBTU appliance gas conversion kit

- ▶ Tighten the four screws.
- ▶ Open the gas supply valve.
- ▶ Turn On the appliance.

- ▶ Check for gas leak (e.g. use leak detector fluid, like water and soap, over and around the metal plate) and act accordingly.
- ▶ Replace the front cover.
- ▶ Access the **Technical Settings** menu (section 6.6).
- ▶ Access to menu **P7 Gas Type**.  
Display shows appliance gas type.
- ▶ Use the symbols  $\wedge$  or  $\vee$  to choose gas type **LPG**.
- ▶ Touch the symbol **ok**.  
The display blinks to confirm the change.
- ▶ Touch the symbol  $\leftarrow$  to return to the main menu.
- ▶ Update "TYPE OF GAS" in the rating plate of the appliance using the label provided with the conversion plates.
- ▶ Confirm CO<sub>2</sub> and CO values and, if necessary, adjust the parameters **P1** and **P2**, see chapter 8.11 for more information.

## 7 Maintenance and service



### DANGER:

- ▶ Always shut off the electrical power supply, shut off the manual gas valve and shut off the water valves whenever servicing.



### DANGER:

- ▶ Replace all dismantled joints and o-rings with new ones.



### NOTICE:

- ▶ Inspect the complete water heating system once a year.
- ▶ Follow points 5 and 6 in Table 21 after 400 operation hours or 25000 cycles (whichever occurs first), see chapter 6.5.1 (Data History).
- ▶ Inspect the water heater and components for wear or fatigue. Immediately repair all faults to avoid damage to the system.

Annual maintenance table		
		Every year
1.	Inspect venting system	X
2.	Inspect combustion chamber	X
3.	Inspect burner	X <sup>1)</sup>
4.	Inspect pressure relief	X
5.	Inspect water filter	X
6.	Heat Exchanger Descaling	2)
7.	Inspect condensate trap	X

Table 21 Annual maintenance

- 1) Proceed with burner cleaning if error code CE is displayed. Check the flue exhaust for blockage (appliance is protected against flue blockage).
- 2) Proceed with heat exchanger descaling whenever error codes AA and E5 are displayed (appliance is protected against over heating in case of scaling).

**WARNING:** Gas leakage!

- ▶ Replace burner seals in case burner is disassembled. Consult spare part list at [www.boschheatingandcooling.com](http://www.boschheatingandcooling.com).

## 7.1 Annual maintenance

(To remove front cover, see page 10)

### Venting System

- Venting system - inspect inside of flue pipe for any blockage or restriction. Observe burner flames during heater operation (front cover must be removed). Burner flames should be steady and blue. Yellow, inconsistent (bouncing) flames may be an indication of poor ventilation or combustion air supply. Inspect the combustion air intake pipe for blockage or debris. Inspect air intake and exhaust terminations for blockage or debris.

### Heat Exchanger

- Inspect burner observation window for cracks or spillage of flue gases. Observe burner flames during heater operation. Flames should be steady and blue with no signs of yellowing. Yellow burner flames are an indication of improper combustion. Refer to section 4.6 to verify the exhaust system and combustion air supply meets the manufacturer's specifications.

### Pressure Relief

- Manually open the pressure relief valve to ensure proper operation.

### Inlet Water Filter

- Verify the inlet water filter screen is clean and undamaged. The inlet water filter is located on the top of the appliance, at the cold water inlet connection. (See Fig. 27, page 32). Close the installer supplied water shutoff valve and remove the brass hex cap holding filter. Remove the filter, clean and or replace if damaged.

### Descaling

- In areas where the water supply has a high mineral content, the heat exchanger should be flushed with a descaling solution. Scale build up will shorten the life of the water heater and damage resulting from scale is not covered under warranty. Refer to section 7.3 for detailed instructions on descaling the heat exchanger.

### Condensate Siphon

- Check for debris and clean if needed.

## 7.2 Winterizing for seasonal use

The water heater must not be installed in a location where it may be exposed to freezing temperatures. If the heater must be left in a space which is likely to experience freezing temperatures, all water must be drained from the heater.

NOTE: Use of agents such as anti-freeze is not permitted and voids the warranty, as they may cause damage to the water heater's internal components.

1. Hold ON/OFF switch on the water heater for 3 secs. to turn OFF the heater and unplug the power supply cord. The display should be blank.
2. Shut off the gas supply to the water heater.
3. Shut off the water supply to the water heater using installer supplied shutoff valve.
4. Open hot water taps to drain and relieve pressure from the plumbing system. If water continues to flow after 5 minutes, a crossover of the hot and cold water pipes is present and must be corrected before proceeding.
5. Disconnect the inlet and outlet water pipes from the water heater. Place a small bucket underneath the water heater to catch residual water remaining inside the water heater.
6. Using an air compressor, blow short bursts of air (100psi max) through the inlet water connection or inlet water filter until there is no water present coming through the outlet water connection of the heater.
7. Empty condensate trap.
8. Reconnect the water fittings and return the heater to service when danger of freezing has passed.

### 7.3 Mineral scale build-up

Periodic descaling may be necessary in areas with high mineral content in the water. Scale buildup in the heat exchanger may result in lower flow rates, error codes of AA, E3, E5 and boiling sounds in the heat exchanger.

A water softener is required if the water hardness exceeds 14 grains/gal (200 mg/l) calcium carbonate. Damage to the water heater resulting from hard water/scale deposits will not be covered under warranty.

#### Descaling using a pump

- ▶ Disconnect the electrical supply from the water heater.
- ▶ Shut off the water supply to the water heater.
- ▶ Open hot water taps to drain and relieve pressure from the plumbing system.
- ▶ Shut off hot water valve to the water heater.
- ▶ Connect a line (A) from the outlet of the circulating pump (installer supplied) to the inlet drain connection on the water heater (see fig. 51.)
- ▶ Using another line (B), connect the outlet drain connection on the water heater. Route the other end of this line into a descaling reservoir.
- ▶ Using a 3rd line (C) from the descaling reservoir, connect to the inlet side of circulating pump. Install a filter on the end of the line in the descaling reservoir.
- ▶ Make sure all connections are water tight.
- ▶ Fill the descaling reservoir with descaling solution so both lines inside are submersed. We recommend a straight white vinegar solution. If using a commercial descalant, refer to manufacturer's instructions for proper dilution ratio.
- ▶ Ensure both drain connections are open.
- ▶ Operate the circulating pump.
- ▶ Make sure there are no leaks and the solution is flowing from the descaling reservoir through the heater and returning to the reservoir.
- ▶ Run the solution through the heater until the solution returning to the descaling reservoir comes out clear. (Changing to a fresh solution may be necessary during this process).
- ▶ Disconnect all lines and drain all solution from heat exchanger. Properly discard the solution.
- ▶ Close the inlet drain connection.
- ▶ Position a container below the outlet drain connection and connect the cold water supply. Open the cold water supply shutoff valve and flush the heat exchanger with clean water.
- ▶ Close the cold water shutoff valve and reconnect hot water supply to the water heater.
- ▶ Close the outlet drain connection.

- ▶ Reconnect the electrical supply to the unit, open the water shutoff valves, and return the unit to service.

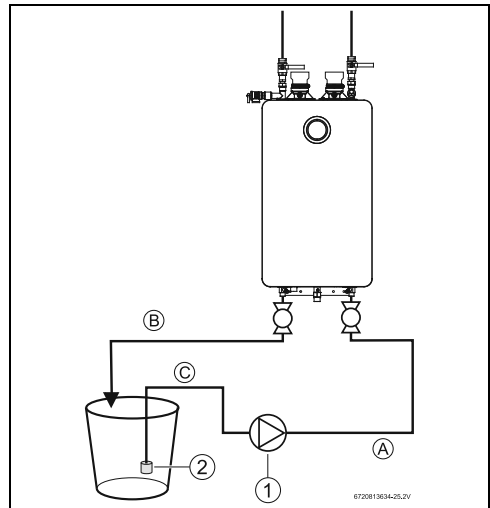

Fig. 51

- [1] Pump
- [2] Water filter

## 8 Troubleshooting



#### CAUTION:

- ▶ If you are unable to perform the tasks listed below, or need additional assistance please contact a service provider or contractor.

### 8.1 Introduction

Many of the questions customers ask regarding operation of this unit can be answered by following the troubleshooting steps as outlined below. For best results, perform each step before proceeding to the next. The suggested solutions may require that the cover be taken off (see fig. 3, page 10).

### 8.2 Burner does not ignite when a hot water faucet is opened

It is recommended to use "P4 Information" page 40, chapter 6.5.1 as a tool for problem solving.

1. If the display is blank, verify power at the outlet. (120VAC/60Hz properly grounded circuit required). Confirm power to the heater.



2. Verify if the fuse in the control board is good. To access the fuse, the control board must be removed. See chapter 5.2, page 37.
  3. Make sure cold water inlet connection is plumbed to the right side of the heater when facing unit. See Fig.26, page 31.
  4. A minimum of 0.45 gallons per minute (1.7 l/m) of hot water demand is required to activate the heater. Confirm at least 0.4 gpm flow by timing how long it takes to fill a container. A quart container should fill in 20 seconds or less, from the hot water tap only. Gradually increase water flow (hot water demand) through the heater to determine if the heater activates with higher flow.
  5. Clean the inlet water filter screen per chapter 4.10, page 31.
  6. Inspect the water path for obstructions. Make sure all shower heads, faucet aerators and whole house filters are clear of debris.
  7. Check for a plumbing crossover. A crossover in the hot and cold plumbing pipes creates back pressure on the water flowing through the heater. Therefore, a higher flow rate than normal is needed to force the heater to activate. To check for a plumbing crossover, shut off the cold water supply to the water heater. Then open all of the hot water taps served by the water heater. Wait 10 minutes and check for water flow at each tap. There should be no water flowing. Any continuous flow of water, small or large, indicates a crossover is present and must be corrected. Consult a professional plumber for help in correcting a crossover. Failing single lever faucet mixing valves are common causes of plumbing crossovers.
  8. With the water heater's power supply cord unplugged, remove the unit's front cover (See fig. 3, page 10). Check all wire connections between the water valve/water flow sensor, control unit and electrode set. See chapter 63, page 61.
3. Verify gas pressure is in accordance with specifications in chapter 4.13, page 36. A gas pressure reading is needed to proceed further. Contact your original installer or a local certified gas technician to obtain this reading.
  4. Check inlet gas particle screen/filter for blockage at inlet gas valve. Need to remove gas valve from the appliance.
  5. Cold water is mixing into the hot water lines (plumbing crossover). A plumbing crossover can unintentionally mix cold water with the hot water leaving the heater. The end result is a cooler water temperature than desired. To check for a plumbing crossover, shut off the cold water supply to the water heater. Then open all of the hot water taps served by the heater. Wait 10 minutes and check all taps for water flow. There should be no water flowing. Any continuous flow of water, small or large, indicates a crossover and must be corrected. Consult a professional plumber for help in correcting a crossover. Failing single lever faucet mixing valves are common causes of plumbing crossovers.

### 8.5 Low water flow/pressure

1. Too many hot water applications are being used simultaneously or too much flow is demanded. The water heater will effectively support two 2.0-2.5 GPM shower heads simultaneously or multiple sink applications. Greater draws will result in a water pressure drop and reduced flow at taps.
2. If the selected temperature on the unit is set too high for the demanded flow rate, the water heater will close its motorized water valve, reducing the hot water flow rate in an attempt to reach the selected output temperature. Lowering the selected temperature will allow the motorized water valve to open up for increased water flow rate.
3. Clean inlet filter screen as instructed in chapter 7.1, page 47 to increase flow through the heater.
4. Inspect the water path for obstructions. Make sure all shower heads, faucet aerators and whole house filters are clear of debris. It may be necessary to upgrade to higher flow rate shower heads if allowed by local code.
5. In areas where the water has a high mineral content, periodic descaling may necessary. See chapter 7.3, page 48 for directions.

### 8.3 Water is too hot

1. Selected temperature on the unit is too high. To lower output temperature, see chapter 6.4, page 38.
2. Confirm the heater's gas type coincides with the type of gas being supplied. See fig. 2, page 10 for location of rating plate.

### 8.4 Water is not hot enough

1. Selected temperature on the unit is too low. To raise output temperature, see chapter 6.4, page 38.
2. Confirm the heater's gas type coincides with the type of gas being supplied. See fig. 2, page 10 for location of rating plate.

### 8.6 Hot water temperature fluctuates at tap

1. If the water heater set point temperature is high, mixing at the faucet could deactivate the water heater. The addition of too much cold will overpower hot water flow from the tankless water heater reducing its flow below the activation point.  
If this slows the flow through the tankless water heater below its deactivation point, it will shut off the burner.

- Unbalanced pressure in water lines. Any restriction in the water heater, such as a clogged inlet water filter screen, can result in unequal pressures between the cold and hot water lines. In such cases, when mixing in the higher pressure cold water at the tap, the lower pressure hot water can be overpowered. This will shut down the burners because the hot water flow rate falls below the minimum flow rate required for activation. Verify that the inlet water filter screen is clean and clear of debris. See chapter 7.1, page 47 for inlet water filter cleaning instructions.
- The water heater may be deactivated by temperature balancing shower valves. If the water heater's set point temperature is set too high, the temperature balance shower valve will automatically mix in cold water to reduce the hot water temperature. An adjustment should be made to minimize the amount of cold water the valve is adding. Additionally, the temperature setting on the water heater can be lowered to reduce the amount of cold water that the temperature balance valve mixes in.
- Inlet water pressure is erratic due to fluctuating supply water pressure. For installation on a private well system with the use of a pressure tank, the lowest pressure range setting recommended is 30 - 45 psi (2.06 - 3.1 bar). Consult your installer or local plumber for effective ways to maintain constant water pressure to the appliance when on a well system.

## 8.7 Noisy burner/heater during operation

Burner noises can be heard if combustion is not properly set. This could be caused by improper gas supply conditions (gas pressure and/or gas composition).

Two types of noise can be heard: low pitch noise/vibration (rumbling) and high pitch noise/vibration (whistling).

### 8.7.1 High pitch noise

- Verify if correct gas type is selected (see section 6.9).
- Verify if gas pressure is within specified range (see section 3.2).
- Ensure that the venting used is according to specifications (see section 4.6) and cross contamination does not exist. Ensure that intake and exhaust terminations maintain required clearances.  
If gas type is properly selected, gas pressure is within range, the venting is according to specifications, and the problem persists:
- Perform the gas and air adjustment as described in section 8.11.

### 8.7.2 Low pitch noise

- Verify if correct gas type is selected (see section 6.9).

- Verify if gas pressure is within specified range (see section 3.2).

If gas type is properly selected, gas pressure is within range, the venting is according to specifications, and the problem persists:

- Perform the gas and air adjustment as described in section 8.11.

## 8.8 Error codes C1, C2, CF and/or CE

C1, C2, CF and CE errors could be caused by a too long flue and/or an obstruction in the venting.

- Verify if there are any venting obstructions and remove them if that is the case.
- Ensure that the venting used is according to specifications (see section 4.6).
- Reset the error by holding the On/Off button for 3s. If there are no obstructions and venting is according to specifications, and the problem persists:
- Perform the gas and air adjustment as described in section 8.11.

## 8.9 Error codes EA and/or EC

EA and EC errors can appear if combustion is not properly set. This could be caused by improper gas supply conditions (gas pressure and/or gas composition).

- Verify if correct gas type is selected (see section 6.9).
- Verify if gas pressure is within specified range (see section 3.2).  
If gas type is properly selected, gas pressure is within range, the venting is according to specifications, and the problem persists:
- Perform the gas and air adjustment as described in section 8.11.

## 8.10 Manifold gas pressure

The manifold gas pressure measurement is only carried out if it is necessary to confirm the value from the rating plate.<sup>1)</sup>

- ▶ Turn Off the appliance.

---

1) Manifold gas pressure may differ from value on the rating plate for altitude installations.

- ▶ Remove the front cover of the appliance (see page 10).

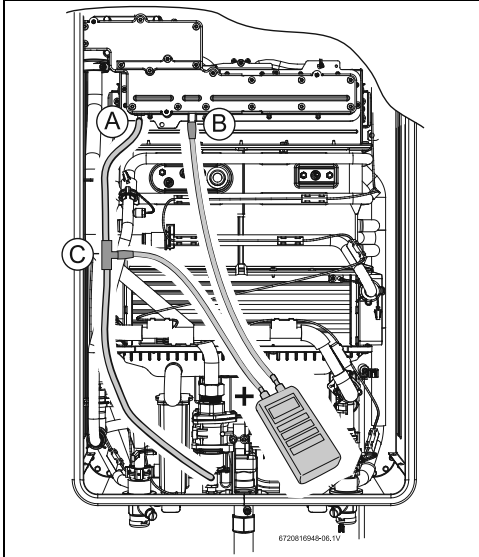

Fig. 52 Pressure head points

- [A] Air pressure head in the box
- [B] Gas pressure head in the burner
- [C] Tee (installer supplied)

- ▶ Loosen the set screw of the pressure head point [B].
- ▶ Connect the pressure gauge connection "+" to the test point [B].
- ▶ Connect the pressure gauge "-" to the pressure head point [A] using the accessory [C].
- ▶ Turn On the appliance.
- ▶ Position the front cover near the appliance and make sure the cable for the display is connected.
- ▶ Open all hot water taps to achieve a flow rate of at least 6 gallons per minute. (1 tub and 2 sinks should be sufficient). If heater goes back to P2, open more hot water fixtures to allow sufficient flow and access to **P1 menu**.
- ▶ Record the manifold gas pressure reading in table 22. Manifold gas pressure refers to the relative pressure between gas manifold nozzles inlet and outlet [A]-[B].

	Value	Date
<b>Manifold gas pressure</b>		

Table 22

- ▶ Turn Off the appliance.

- ▶ Disconnect the pressure gauges from the pressure heads points [A] and [B].
- ▶ Tighten the shutter screws of the pressure heads points [A] and [B].
- ▶ Reassemble the front cover onto the appliance.
- ▶ Turn ON the appliance to return to normal operation.

### 8.11 Adjusting Gas/Air flow



**Appliance is pre-adjusted by default with factory parameters.**

#### Gas/Air adjustments are only required when;

- The appliance is converted to LPG and energy content is more than 2820 BTU/cu ft(→ section 6.9).
- After installation, the appliance shows repeated unresolved errors (→ chapter 9).
- In Natural Gas installations where energy content is less than 900 BTU/cu ft.
- After replacement of electronic control unit, fan or gas valve.



Improper gas pressure will affect combustion.

- ▶ Please see chapter 4.13 for more information.

#### 8.11.1 Automatic adjust of Gas/Air flow

- ▶ Touch the symbol ↶.
- ▶ Touch symbols ▲ or ▼ to select **UC** menu.



Access to **UC** menu is only possible after accessing to **AU Technical Settings** menu (→ section 6.6).

- ▶ Touch the symbol **ok** to enter **UC** menu. Display shows **Combustion Auto Adjust**.

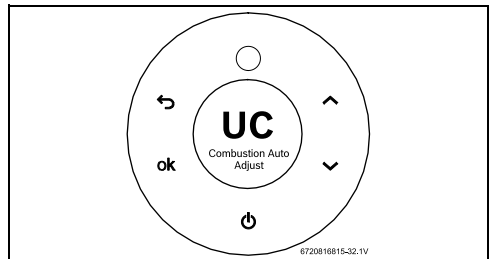

Fig. 53 Combustion Auto Adjust

- ▶ Open hot water taps when the display shows **Open Taps** message (1 tub and 2 sinks should be sufficient; when there is enough water flow the message disappears).

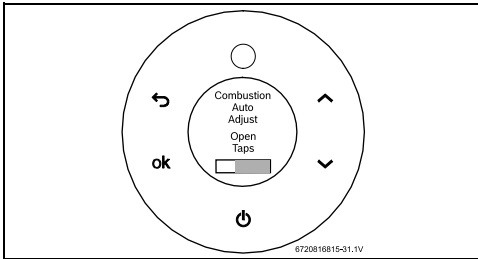

Fig. 54 Combustion Auto Adjust - Open Taps

- ▶ Touch the symbol **ok** .  
Display shows Technical Settings menu (password input).
- ▶ Select the password. The password is 1886.  
Technical Settings is completed.

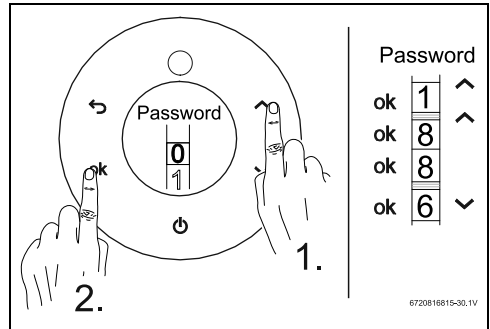

Fig. 55 Insert password

### Second step - Adjust the maximum power (P1)

- ▶ Touch the symbol **↶** .
- ▶ Touch symbols **▲** or **▼** to select **P1** menu.
- ▶ Touch the symbol **ok** to enter **P1** menu.  
Display shows **L1 Gas Adjust**.

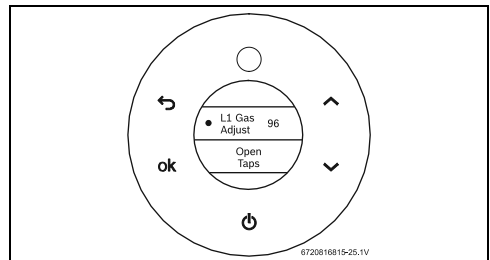

Fig. 56 L1 Gas Adjust - Open Taps

- ▶ Open hot water taps until display no longer shows **Open Taps** message (1 tub and 2 sinks should be sufficient).  
Display shows **Output Power (%)** when there is enough water flow to keep P1 mode active.



If **Open Taps** message appears during the **P1** adjustment or if the unit automatically exits **P1** mode.

- ▶ Open one more hot water tap.
- ▶ Ensure low inlet water temperature by turning off backup appliances (i.e. solar).



The **Combustion Auto Adjust** process takes several minutes.

- ▶ Do not interfere with the appliance during the auto adjustment process.  
In case of anomaly you will be guided to act accordingly.

- ▶ Wait until indication that the calibration is completed appears on the screen.
- ▶ Touch the symbol **↶** to exit **UC** menu.

### Gas and Air auto adjustment is complete.



In case of failure in the auto calibration process verify if:

- ▶ Gas type and pressure are correct.
- ▶ Vent length is according to specification.
- ▶ Hot water flow is sufficient.  
In case of positive results for all these actions:
- ▶ Exit UC menu and repeat the process.  
If failure persists:
- ▶ Contact Bosch support line for further assistance.

### 8.11.2 Adjust Gas/Air flow in 3 steps

Gas/Air flow adjust is also possible to perform manually (only recommendable if automatic adjust is not possible to conclude successfully).

#### First step - Accessing the AU Technical Settings menu

- ▶ Touch the symbol **↶** .  
Display shows **P4 Information**.
- ▶ Touch symbols **▲** or **▼** to select **AU Technical Settings** menu.



How to enter a new tuning parameter (i.e. L1, L2, A1, A2).

- ▶ Select the desired parameter.
- ▶ Touch the symbol **ok** .  
The symbols  $\blacktriangleup$   $\blacktriangledown$  appears in the display.
- ▶ Change to the desired value.
- ▶ Touch the symbol **ok** when finished.  
The symbols  $\blacktriangleup$   $\blacktriangledown$  disappear.

- ▶ Change **L1 Gas Adjust** parameter until reaches 100%  $\pm$  2% <sup>1)</sup>

**Note:** Power output may oscillate between an average value if the water conditions are unstable. Consider the average value of the oscillation in the adjustment if this is the case.

**L1 Gas Adjust** is now complete.

- ▶ Touch symbols  $\blacktriangleup$  or  $\blacktriangledown$  until display shows **A1 Air Adjust - ION**.

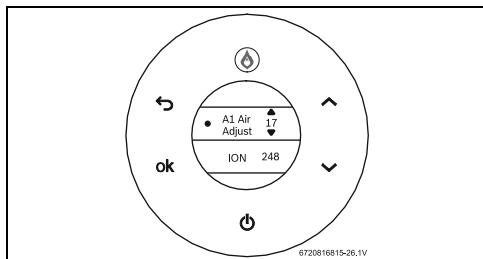

Fig. 57 A1 Air Adjust - ION

- ▶ Change **A1 Air Adjust** parameter until **ION** value is according to table 23.  
Increase **A1 Air Adjust** parameter to decrease **ION** value and vice-versa.  
**A1 Air Adjust** is now complete.

- ▶ Touch symbols  $\blacktriangleup$  or  $\blacktriangledown$  until display shows **A2 Auto Adjust**.

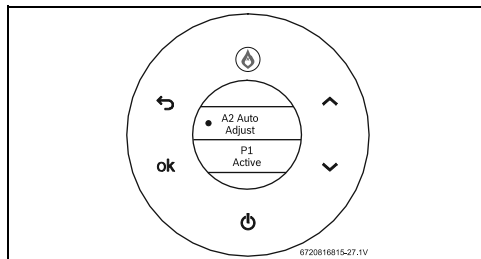

Fig. 58 A2 Auto Adjust - P1 Active

- ▶ Touch the symbol **ok** to enter A2 Auto Adjust. <sup>2)</sup>  
**A2 Auto Adjust** will start automatically.



The **A2 Auto Adjust** process takes a couple of minutes.

- ▶ Do not interfere with the appliance during the auto adjustment process.

- ▶ Wait until a check mark appears in the display.  
**A2 Auto Adjust** is completed.

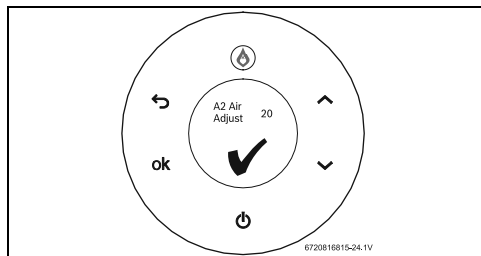

Fig. 59 A2 Auto adjust is completed

- ▶ Touch the symbol  $\blackleftarrow$  to exit **P1** menu.  
**Maximum power adjust (P1)** is completed.

P1 maximum power <sup>1)</sup>	199 000 BTU	160 000 BTU
<b>Natural Gas</b>		
ION (A1 Air Adjust)	240 - 300	200 - 260
<b>LP Gas</b>		
ION (A1 Air Adjust)	185 - 250	200 - 280

Table 23 P1 ION values

1) Increase **L1 Gas Adjust** parameter to increase output power and vice-versa.

2) **A2 Auto Adjust** will calculate automatically the amount of air in low fire (P2). This method uses P1 values to start calculation.

- 1) For information on unit's configuration (gas type: NG/LPG and capacity: 160 000BTU/199 000BTU), see rating plate (→chapter 3.3).

### Third step - Adjust the minimum power (P2)



Keep hot water taps opened to adjust **minimum power (P2)**. The unit will ramp down to low fire and the water flow should decrease automatically.

- ▶ Touch the symbol ↶.
- ▶ Touch symbols ▲ or ▼ to select **P2** menu.
- ▶ Touch the symbol **ok** to enter **P2** menu. Display shows **L2 Gas Adjust**.

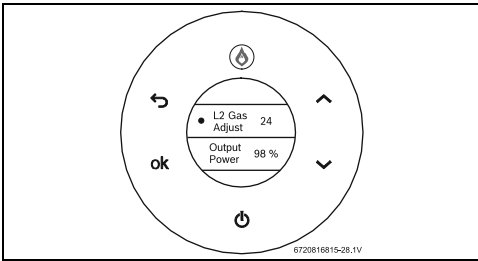

Fig. 60 L2 Gas Adjust - Output Power

- ▶ Change **L2 Gas Adjust** parameter until reaches  $100\% \pm 2\%$ .<sup>1)</sup>  
**L2 Gas Adjust** is now complete.  
**Note:** Power output may oscillate between an average value if the water conditions are unstable. Consider the average value of the oscillation in the adjustment if this is the case.
- ▶ Touch symbols ▲ or ▼ until display shows **A2 Air Adjust**.

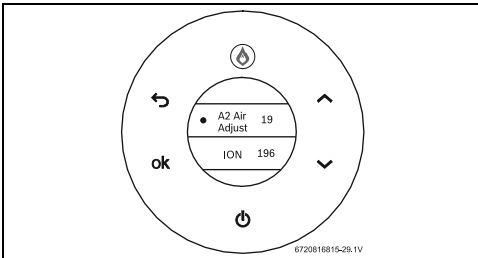

Fig. 61 A2 Air Adjust - ION

- 1) Increase **L2 Gas Adjust** parameter to increase output power and vice-versa.

- ▶ Verify if the **ION** value is according to table 24, and if there is a need to do a fine tuning.<sup>2)</sup>
- ▶ Touch the symbol ↶ to exit.  
**Minimum power adjust** is completed.

P2 minimum power <sup>1)</sup>	199 000 BTU	160 000 BTU
<b>Natural Gas</b>		
ION (A2 Air Adjust)	120 - 170	170 - 220
<b>LP Gas</b>		
ION (A2 Air Adjust)	130 - 190	105 - 150

Table 24 P2 ION values

- 1) For information on unit's configuration (gas type: NG/LPG and capacity: 160 000BTU/199 000BTU), see rating plate (→chapter 3.3).

**Gas and Air adjustment is complete.**

- 2) Increasing **A2** values will cause a decrease in **ION** values and vice-versa.

### 8.12 CO emissions check

In case air/gas combustion adjustment has been performed check emissions using reference values in tables 25 and 26.

#### 8.12.1 Access to measuring port



**Allow the appliance to stabilize before performing CO readings.**

**Let appliance warm up and wait for 2 or 5 minutes for each CO readings.**

**This will avoid wrong CO readings.**

- ▶ Open a hot water tap and let the appliance work for 2 or 5 minutes.
- ▶ Remove the screw from the flue adaptor on the left side of the appliance, as seen in fig. 62.
- ▶ Insert analyzer probe into the measuring port. The tip of the probe should be in the center of the flue pipe (approx 1.5" inserted). Avoid air gaps between probe and measuring port as they can alter readings.

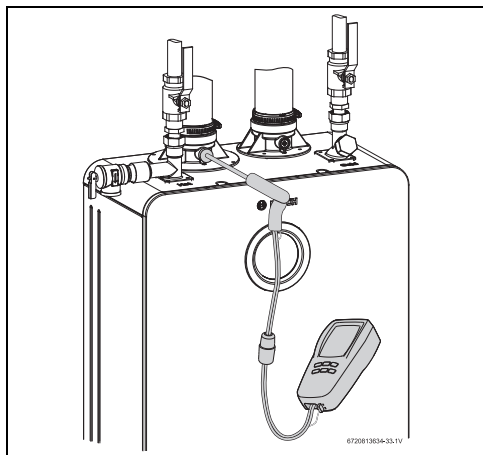

Fig. 62 Measuring port

#### 8.12.2 CO<sub>2</sub> and CO values

		CO <sub>2</sub> range (%)	Max. CO level (measured)
Greentherm 9800 SE / SEC 199 000 BTU			
Nat. Gas			
max. input	P1	8.5 % - 8.9 %	< 250 ppm
min. input	P2	N/A	< 100 ppm
LP Gas			

Table 25 CO<sub>2</sub> & CO target numbers

		CO <sub>2</sub> range (%)	Max. CO level (measured)
Greentherm 9800 SE / SEC 199 000 BTU			
max. input	P1	9.8 % - 10.2 %	< 250 ppm
min. input	P2	N/A	< 100 ppm

**\* Values above are for climate controlled conditions. Inputs such as gas pressure, heating value of the gas, humidity and temperature of combustion air all impact CO and CO<sub>2</sub> values. Changes in these inputs can result in different CO and CO<sub>2</sub> values on the same appliance.**

Table 25 CO<sub>2</sub> & CO target numbers

		CO <sub>2</sub> range (%)	Max. CO level (measured)
Greentherm 9800 SE 160 000 BTU			
Nat. Gas			
max. input	P1	8.6 % - 9.0 %	< 250 ppm
min. input	P2	N/A	< 100 ppm
LP Gas			
max. input	P1	9.7 % - 10.1 %	< 250 ppm
min. input	P2	N/A	< 100 ppm

**\* Values above are for climate controlled conditions. Inputs such as gas pressure, heating value of the gas, humidity and temperature of combustion air all impact CO and CO<sub>2</sub> values. Changes in these inputs can result in different CO and CO<sub>2</sub> values on the same appliance.**

Table 26 CO<sub>2</sub> & CO target numbers

#### 8.12.3 Returning to Service

- ▶ Remove the analyzer probe and insert the screw into the flue adaptor.
- ▶ Touch the symbol ↶ to exit service menu. The appliance is ready for normal operation.

## 9 Problem solving

### 9.1 Error code diagnostics



To remove error codes from the display,  
 ▶ Touch the On/Off button more than 3 sec. (long press).

Installation, maintenance and repair must only be carried out by qualified contractors. The following table describes the solutions for possible problems.

Display	Description	Solution
A0	Water temperature sensors [17] [19] [20] disconnected or damaged.	<ul style="list-style-type: none"> <li>▶ Check sensor wire connections.<sup>1) 2)</sup></li> <li>▶ Replace the sensor and/or wire connections, if the problem persists.<sup>1)</sup></li> </ul>
A1	Air temperature inside the cabinet [18] is above 158 °F. Appliance regulates power to protect against overheat.	<ul style="list-style-type: none"> <li>▶ External air temperature is above 140 °F.</li> <li>▶ Check for flue leakages inside the appliance or in concentric vent.<sup>1)</sup></li> </ul>
A2	External water temperature sensor/aquastat [21] disconnected, damaged or not properly installed.	<ul style="list-style-type: none"> <li>▶ Check temperature sensor and associated connections.<sup>1) 2)</sup></li> <li>▶ Check sensor position in the tank pocket.</li> <li>▶ Verify if correct recirculation settings are in use (→section 6.5.3).</li> <li>▶ Replace the sensor and/or wire connections, if the problem persists.<sup>1)</sup></li> </ul>
A3	Flue gases temperature sensor [15] disconnected or damaged.	<ul style="list-style-type: none"> <li>▶ Check sensor wire connections.<sup>1) 2)</sup></li> <li>▶ Replace the sensor and/or wire connections, if the problem persists.<sup>1)</sup></li> </ul>
A4	Air temperature sensor [18] disconnected or damaged.	<ul style="list-style-type: none"> <li>▶ Check sensor wire connections.<sup>1) 2)</sup></li> <li>▶ Replace the sensor and/or wire connections, if the problem persists.<sup>1)</sup></li> </ul>
A5	Condensing unit flue temperature sensor [16] disconnected or damaged.	<ul style="list-style-type: none"> <li>▶ Check sensor wire connections.<sup>1) 2)</sup></li> <li>▶ Replace the sensor and/or wire connections, if the problem persists.<sup>1)</sup></li> </ul>
A6	Inlet cold water temperature sensor [20] disconnected or damaged.	<ul style="list-style-type: none"> <li>▶ Check sensor wire connections.<sup>1) 2)</sup></li> <li>▶ Replace the sensor and/or wire connections, if the problem persists.<sup>1)</sup></li> </ul>
A7	Heat exchanger hot water temperature sensor [16] disconnected or damaged.	<ul style="list-style-type: none"> <li>▶ Check sensor wire connections.<sup>1) 2)</sup></li> <li>▶ Replace the sensor and/or wire connections, if the problem persists.<sup>1)</sup></li> </ul>
A8	Outlet hot water temperature sensor [17] disconnected or damaged.	<ul style="list-style-type: none"> <li>▶ Check connections or replace sensor.<sup>1) 2)</sup></li> <li>▶ Replace the sensor and/or wire connections, if the problem persists.<sup>1)</sup></li> </ul>

Table 27



Display	Description	Solution
A9	Incorrect output power (too low).	<ul style="list-style-type: none"> <li>▶ Check gas inlet pressure<sup>1)</sup> (→ section 4.13).</li> <li>▶ Check water temperature sensors [17][19][20] and water flow sensor [14] wire connections.</li> <li>▶ Check sensors resistance and water flow sensor(→ section 11) and replace any if it is not according to specification.<sup>1) 2)</sup></li> </ul>
AA	Condensing unit flue gases temperature [16] above 392 °F and/or flue gases temperature [15] above 145 °F at the exhaust sensor [15]. Appliance regulates power to protect against overheating.	<ul style="list-style-type: none"> <li>▶ Descale appliance (→ section 7.3).<sup>1)</sup></li> </ul>
C1 C2	Flue blockage detected during startup due to insufficient combustion air.	<ul style="list-style-type: none"> <li>▶ Reset error (touch and hold on/off button for 3 seconds). If the problem persists:</li> <li>▶ Check air intake and exhaust pipes and terminals for obstructions and reset the error.</li> <li>▶ Check if flue length is according to specification (→section 4.6) and reset the error.</li> <li>▶ Perform gas and air tuning (→ section 8.11).<sup>1)</sup></li> </ul>
C3	Flow sensor [14] does not detect water recirculation.	<ul style="list-style-type: none"> <li>▶ Check pump and connections.<sup>1)</sup></li> <li>▶ Check recirculation circuit for any blockage.</li> </ul>
C5	Bypass water valve [8] disconnected or damaged.	<ul style="list-style-type: none"> <li>▶ Check bypass water valve wire connections.<sup>1)</sup> If the problem persists:</li> <li>▶ Replace the bypass water valve and/or wire connections. After valve replacement, proceed with bypass water valve calibration (→section 6.8).<sup>1)</sup></li> </ul>
C7	Fan [2] disconnected or damaged.	<ul style="list-style-type: none"> <li>▶ Check fan wire connections.</li> <li>▶ Reset error (touch and hold on/off button for 3 seconds) If the problem persists:</li> <li>▶ Replace the fan and/or wire connections.<sup>1)</sup></li> </ul>
C8	Main water valve [22] disconnected or damaged.	<ul style="list-style-type: none"> <li>▶ Check main water valve wire connections.<sup>1)</sup> If the problem persists:</li> <li>▶ Replace main water valve and/or wire connections. After valve replacement, proceed with main water valve calibration (→section 6.8).<sup>1)</sup></li> </ul>
C9	Barometric pressure sensor damaged.	<ul style="list-style-type: none"> <li>▶ Reset error (touch and hold on/off button for 3 seconds). If the problem persists:</li> <li>▶ Replace electronic control unit (ECU).<sup>1)</sup></li> </ul>
CA	Water flow above 9.2gpm.	<ul style="list-style-type: none"> <li>▶ Disconnect the appliance and purge hydraulic circuit to remove air.<sup>1)</sup></li> <li>▶ Install water flow restrictor.<sup>1)</sup></li> <li>▶ Check water pressure does not exceed 150psi.(→section 3.2).</li> </ul>

Table 27

Display	Description	Solution
CE	Flue blockage detected during operation due to excessive pressure on the siphon.	<ul style="list-style-type: none"> <li>▶ Reset error (touch and hold on/off button for 3 seconds).</li> <li>If the problem persists:</li> <li>▶ Check exhaust pipes and terminals for obstructions and reset the error.</li> <li>▶ Check if flue length is according to specification (→section 4.6) and reset the error.</li> <li>▶ Perform gas and air tuning (→ section 8.11).<sup>1)</sup></li> </ul>
CF	Flue blockage detected during operation due to insufficient combustion air.	<ul style="list-style-type: none"> <li>▶ Reset error (touch and hold on/off button for 3 seconds).</li> <li>If the problem persists:</li> <li>▶ Check air intake and exhaust pipes and terminals for obstructions and reset the error.</li> <li>▶ Check if flue length is according to specification (→section 4.6) and reset the error.</li> <li>▶ Perform gas and air tuning (→ section 8.11).<sup>1)</sup></li> </ul>
E0	Electronic control unit internal error.	<ul style="list-style-type: none"> <li>▶ Reset error (touch and hold on/off button for 3 seconds).</li> <li>If the problem persists:</li> <li>▶ Replace electronic control unit.<sup>1)</sup></li> </ul>
E1	Hot water temperature above 194 °F. Appliance burner cut off to prevent scalding and reactivation after cooling down.	<ul style="list-style-type: none"> <li>▶ Disconnect the appliance and purge hydraulic circuit to remove air.</li> <li>If the problem persists:</li> <li>▶ Reduce setpoint temperature to minimize temperature instabilities.</li> </ul>
E3	Flue gases temperature above 167 °F (residential) / 194 °F (commercial) or 2 minutes above 145 °F. Appliance burner cut off to prevent overheating.	<ul style="list-style-type: none"> <li>▶ Descale appliance (→ section 7.3).<sup>1)</sup></li> <li>▶ Reset error (touch and hold on/off button for 3 seconds).</li> <li>If the problem persists:</li> <li>▶ Check sensor resistance [15] (→section 11) and replace the sensor if it is not according to specification.<sup>1)2)</sup></li> </ul>
E4	Air temperature inside cabinet above 176 °F or 2 minutes above 158 °F. Appliance burner cut off to prevent overheating.	<ul style="list-style-type: none"> <li>▶ Check for flue gas leakage inside the cabinet or concentric vent.<sup>1)</sup></li> <li>▶ Reset error (touch and hold on/off button for 3 seconds).</li> <li>If the problem persists:</li> <li>▶ Check sensor resistance [18] (→section 11) and replace the sensor if it is not according to specification.<sup>1)2)</sup></li> </ul>

Table 27

Display	Description	Solution
E5	Condensing unit flue gases temperature above 428 °F or 2 minutes above 392 °F. Appliance burner cut off to prevent overheating.	<ul style="list-style-type: none"> <li>▶ Descale appliance (→ section 7.3).<sup>1)</sup></li> <li>▶ Reset error (touch and hold on/off button for 3 seconds).</li> <li>    If the problem persists:</li> <li>▶ Check sensor resistance [16] (→section 11) and replace the sensor if it is not according to specification.<sup>1) 2)</sup></li> </ul>
E7	Electronic control unit internal error.	<ul style="list-style-type: none"> <li>▶ Reset error (touch and hold on/off button for 3 seconds).</li> <li>    If the problem persists:</li> <li>▶ Replace electronic control unit.<sup>1)</sup></li> </ul>
E8	Error during ionization test. Electronic control unit internal error.	<ul style="list-style-type: none"> <li>▶ Replace electronic control unit.<sup>1)</sup></li> </ul>
E9	Thermal fuse [13] broken.	<ul style="list-style-type: none"> <li>▶ Replace thermal fuse.<sup>1)</sup></li> </ul>
EA	Ignition failure.	<ul style="list-style-type: none"> <li>▶ Check gas inlet pressure (→ section 4.13).<sup>1)</sup></li> <li>▶ Perform gas and air tuning (→ section 8.11).<sup>1)</sup></li> </ul>
EB	Electronic control unit internal error.	<ul style="list-style-type: none"> <li>▶ Reset error (touch and hold on/off button for 3 seconds).</li> <li>    If the problem persists:</li> <li>▶ Replace electronic control unit.<sup>1)</sup></li> </ul>
EC	Flame lost during operation.	<ul style="list-style-type: none"> <li>▶ Check gas inlet pressure (→ section 4.13).<sup>1)</sup></li> <li>▶ Perform gas and air tuning (→ section 8.11).<sup>1)</sup></li> </ul>
EE	Gas valve modulation solenoid [7] disconnected.	<ul style="list-style-type: none"> <li>▶ Check gas valve wire connection.<sup>1)</sup></li> <li>    If the problem persists:</li> <li>▶ Replace the gas valve and/or wire connections and/or electronic control unit. For gas valve replacement perform gas and air tuning (→ section 8.11).<sup>1)</sup></li> </ul>
EF	Wrong gas connected (LP instead of NG) for current appliance configuration.	<ul style="list-style-type: none"> <li>▶ Check gas type (→ section 6.9).<sup>1)</sup></li> </ul>
F2	Electronic control unit internal error.	<ul style="list-style-type: none"> <li>▶ Reset error (touch and hold on/off button for 3 seconds).</li> <li>    If the problem persists:</li> <li>▶ Replace electronic control unit.<sup>1)</sup></li> </ul>
F3	Electronic control unit internal error.	<ul style="list-style-type: none"> <li>▶ Reset error (touch and hold on/off button for 3 seconds).</li> <li>    If the problem persists:</li> <li>▶ Replace electronic control unit.<sup>1)</sup></li> </ul>
F7	Electronic control unit internal error.	<ul style="list-style-type: none"> <li>▶ Reset error (touch and hold on/off button for 3 seconds).</li> <li>    If the problem persists:</li> <li>▶ Replace electronic control unit.<sup>1)</sup></li> </ul>
F8	Electronic control unit internal error.	<ul style="list-style-type: none"> <li>▶ Reset error (touch and hold on/off button for 3 seconds).</li> <li>    If the problem persists:</li> <li>▶ Replace electronic control unit.<sup>1)</sup></li> </ul>

Table 27

Display	Description	Solution
F9	Gas valve driver internal fault.	<ul style="list-style-type: none"> <li>▶ Check gas valve wire connections.<sup>1)</sup></li> <li>If the problem persists:</li> <li>▶ Replace the wire connections and/or electronic control unit.<sup>1)</sup></li> </ul>
FA	Gas leakage in the gas path (gas valve or gas manifold shut-off valves).	<ul style="list-style-type: none"> <li>▶ Replace the gas valve and/or gas manifold.<sup>1)</sup></li> <li>▶ After gas valve and/or gas manifold replacement perform gas and air tuning (→ section 8.11).<sup>1)</sup></li> </ul>
FC	Touch screen key pressed for more than 20 seconds.	<ul style="list-style-type: none"> <li>▶ Release the touch screen key.</li> <li>▶ Clean the touch screen display.</li> </ul>
Display reads <b>SOLAR</b> but without existence of solar thermal system.	Power demand lower than appliance minimum output power.	<ul style="list-style-type: none"> <li>▶ Increase hot water flow.</li> <li>▶ increase setpoint temperature.</li> </ul>
Display reads <b>SOLAR</b> and water temperature low.		
High pitch noise (whistling)	Combustion flame with gas in excess or lack of air.	<ul style="list-style-type: none"> <li>▶ Check if gas type is correct (→ section 6.9).<sup>1)</sup></li> <li>▶ Check gas inlet pressure (→ section 4.13).<sup>1)</sup></li> <li>▶ Perform gas and air tuning (→ section 8.11).<sup>1)</sup></li> </ul>
Low pitch noise with vibration (rumbling)	Combustion flame with air in excess or lack of gas.	<ul style="list-style-type: none"> <li>▶ Check if gas type is correct (→ section 6.9).<sup>1)</sup></li> <li>▶ Check gas inlet pressure (→ section 4.13).<sup>1)</sup></li> <li>▶ Perform gas and air tuning (→ section 8.11).<sup>1)</sup></li> </ul>

Table 27

1) only to be carried out by qualified contractors.

2) see temperature resistance charts in fig. 64 and 65.

- ▶ Note: If the appliance is locked for safety reasons, information is shown on the display to give more information on the problem. Once the problem is solved, you may have to reset the error (touch and hold  button for 3 seconds). Error reset will only take effect if error is visible on the display.

## 10 Electrical diagram

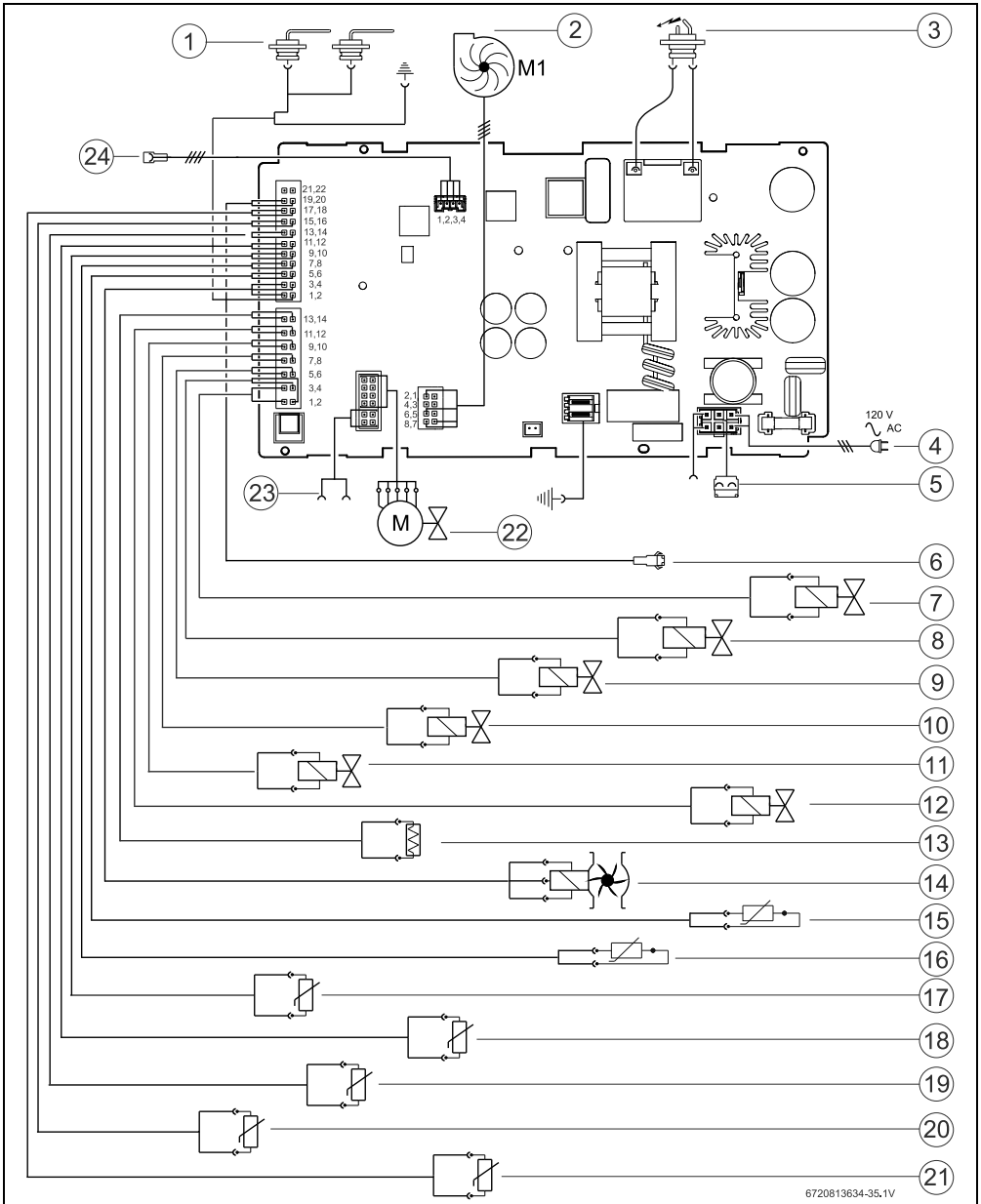

6720813634-35.1V

Fig. 63 Electrical diagram

- [1] Ionization sensor
- [2] Fan
- [3] Ignition electrode
- [4] Power supply
- [5] Connection for anti freeze kit
- [6] Connection for remote control
- [7] Gas valve - modulation solenoid
- [8] Bypass water valve
- [9] Electrovalve 3
- [10] Electrovalve 1
- [11] Electrovalve 2
- [12] Gas valve - safety solenoid
- [13] Thermal fuse
- [14] Water flow sensor
- [15] Flue gases temperature sensor
- [16] Condensing unit flue gases temperature sensor
- [17] Outlet hot water temperature sensor
- [18] Air temperature sensor
- [19] Heat exchanger hot water temperature sensor
- [20] Inlet cold water temperature sensor
- [21] External water temperature sensor/Aquastat
- [22] Main water valve
- [23] Cascading in/Out
- [24] Touch control display connection

## 11 Sensor resistance charts

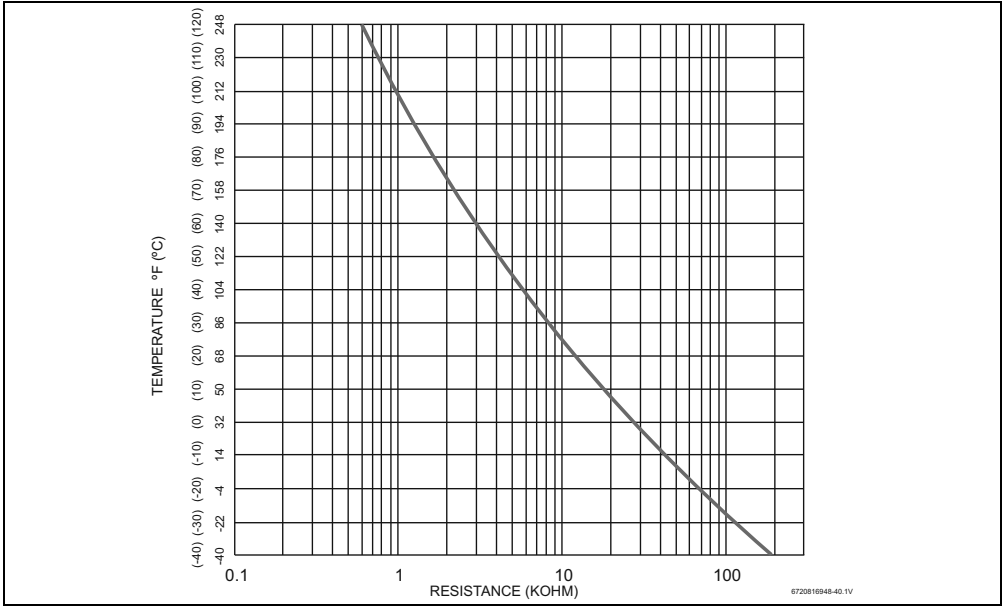

Fig. 64 Inlet, outlet and heat exchanger water temperature sensors characteristics

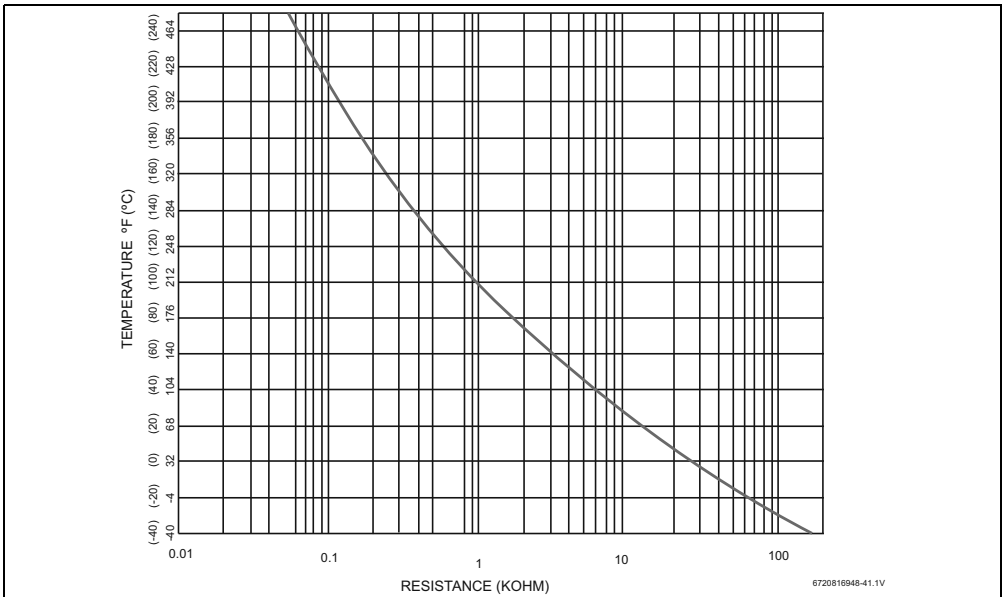

Fig. 65 Flue gases and condensing unit flue gases temperature sensors characteristics

## 12 Interior components diagram

### 12.1 199,000 Btu interior components

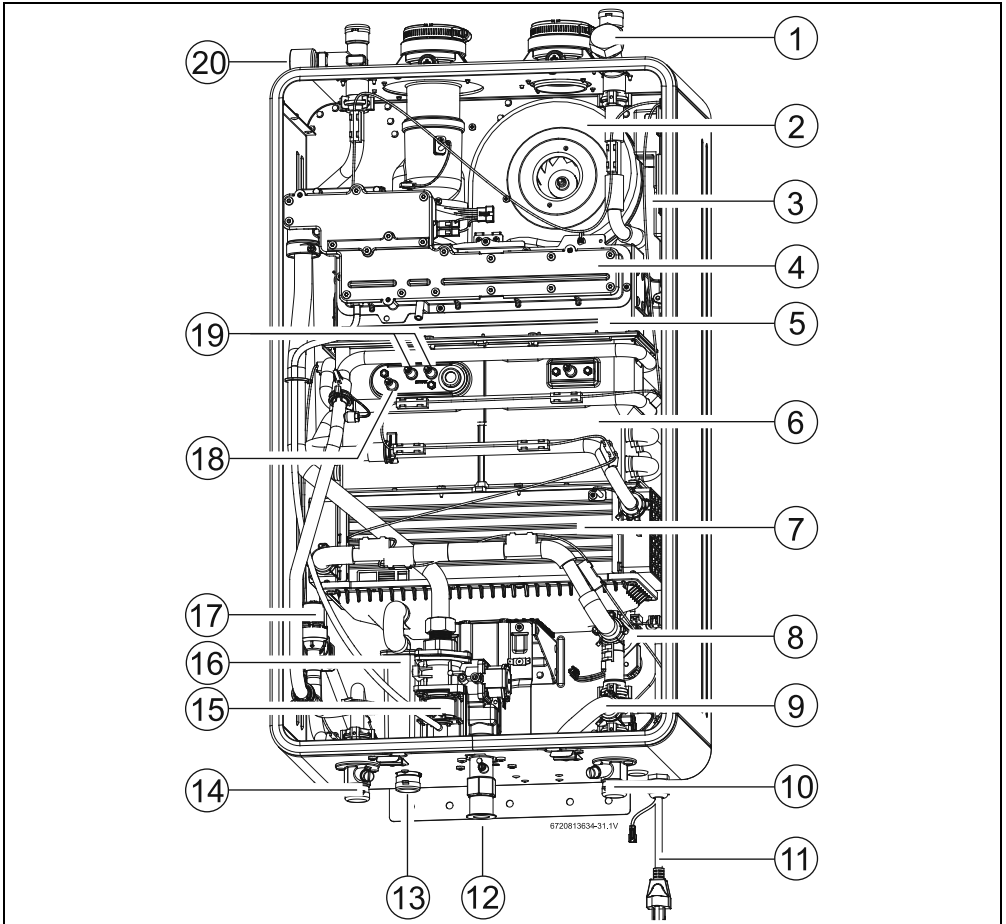

Fig. 66 199,000 Btu components

- |                        |                          |
|------------------------|--------------------------|
| [1] Inlet water filter | [11] Power cord          |
| [2] Air fan            | [12] Gas connection      |
| [3] Control unit       | [13] Condensate drain    |
| [4] Gas manifold       | [14] HE drain            |
| [5] Burner             | [15] Gas valve           |
| [6] Heat exchanger     | [16] Condensate trap     |
| [7] Condensing unit    | [17] By-pass water valve |
| [8] Main water valve   | [18] Ionization sensor   |
| [9] By-pass pipe       | [19] Ignition electrodes |
| [10] HE drain          | [20] PRV connection      |



## 12.2 160,000 Btu interior components

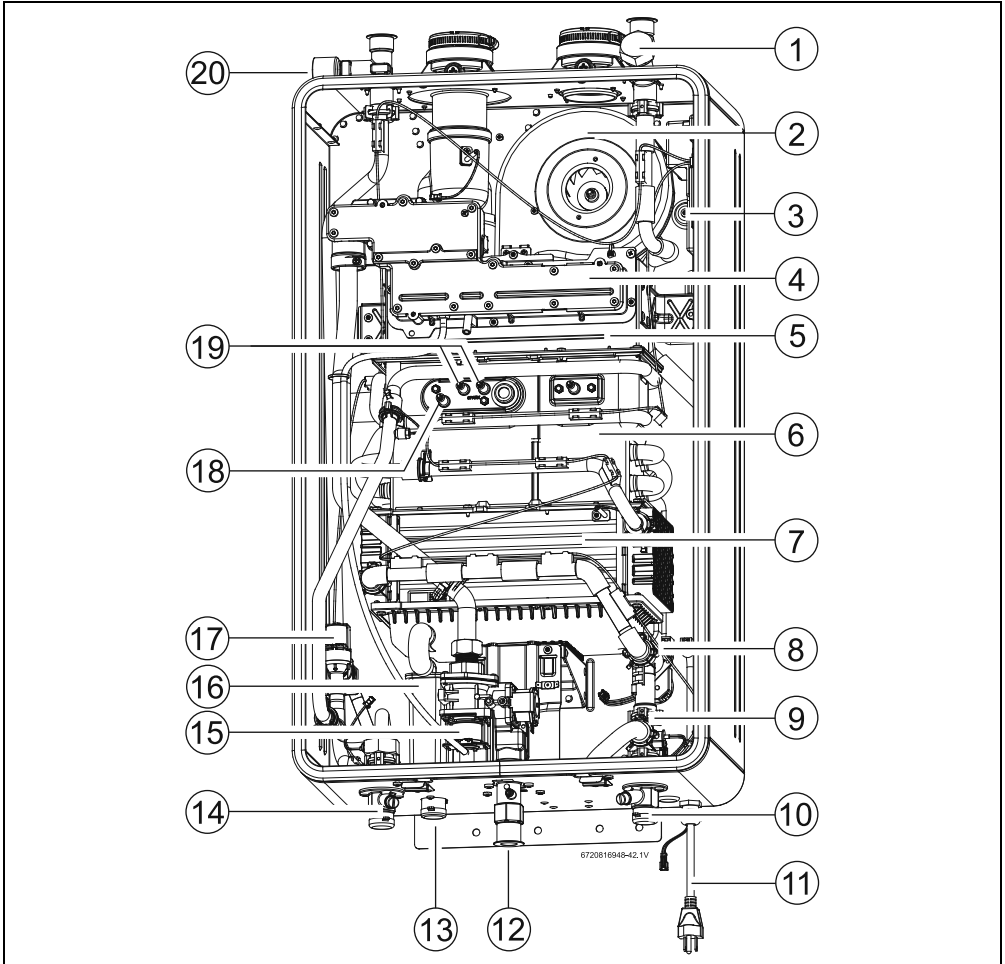



Fig. 67 160,000 Btu components

- |                        |                          |
|------------------------|--------------------------|
| [1] Inlet water filter | [13] Condensate drain    |
| [2] Air fan            | [14] HE drain            |
| [3] Control unit       | [15] Gas valve           |
| [4] Gas manifold       | [16] Condensate trap     |
| [5] Burner             | [17] By-pass water valve |
| [6] Heat exchanger     | [18] Ionization sensor   |
| [7] Condensing unit    | [19] Ignition electrodes |
| [8] Main water valve   | [20] PRV connection      |
| [9] By-pass pipe       |                          |
| [10] HE drain          |                          |
| [11] Power cord        |                          |
| [12] Gas connection    |                          |

### 13 Protecting the environment



#### Packing

The packing box may be fully recycled as confirmed by the recycling symbol .

#### Components

Many parts in the heater can be fully recycled at the end of the product life. Contact your city authorities for information about the disposal of recyclable products.

#### Saving water resources:

- ▶ Make sure you close all the taps after any use. Avoid leaving the taps dripping. Repair any leaking tap.
- ▶ Define the temperature you want, in the appliance or with the remote control. This way you have the precise water flow needed (mixing cold water to regulate temperature will increase the water flow with consequent waste of water).

### 14 Installer Checklist to be completed by installer upon installation

Serial Number <sup>1)</sup>	_____
Gas Pressure Reading <sup>2)</sup>	
Static	
Dynamic	
Water Pressure	
Building Water Pressure	
Pressure Range if on Well system	
Installing Company	
Installer name	
Address	
Phone	

Table 28

- 1) Serial number is located on the rating plate which is located on the right side of the appliance cabinet.
- 2) See Chapter 4.13 and gas pressure table (to be filled out by installer).



Installation manual should be left with the owner after the installation is tested and completed. Additional copies of the installation manual are available at [www.boschheatingandcooling.com](http://www.boschheatingandcooling.com).

**Notes**



6720816815

Bosch Thermotechnology Corp.  
50 Wentworth Avenue  
Londonderry, NH 03053  
Tel. 603-552-1100  
Fax 603-965-7581  
[www.boschheatingandcooling.com](http://www.boschheatingandcooling.com)  
U.S.A.

Products manufactured by  
Bosch Termotecnologia SA  
Estrada de Cacia  
3800-533 Cacia  
Portugal

Bosch Thermotechnology Corp. reserves the right  
to make changes without notice due to continuing  
engineering and technological advances.