

**PRS**  
*Streamline*™

**COPPER PRESS FITTINGS**  
CATALOG





**TRUSTED**





## Mueller Industries' Streamline PRS™ press fittings are the trusted, quality solution to flameless copper joining.

Streamline PRS™ is Mueller Industries' solution for professionals choosing to join copper tubing through the use of press technology. The company's Streamline® brand has been the trusted name in copper piping systems since 1930. With Streamline PRS™, this heritage of quality and reliability is now available for contractors preferring flameless, mechanical press joining.

- 1/2" – 4" including couplings, elbows, tees, adapters, fitting reducers, caps, and flanges
- Extensive offering of reducing tees
- Leak detection feature identifies un-crimped connections
- Compatible with most common pressing tools and jaws in the market
- EPDM (Ethylene Propylene Diene Monomer) seals are factory-installed & lubricated
- Packaged in common industry quantities

### TABLE OF CONTENTS

BENEFITS.....	4	FEATURES .....	19
SYSTEM DATA.....	5	TESTING WITH LEAK DETECTION .....	20
DIMENSIONAL DATA.....	6-15	INSTALLATION GUIDELINES .....	21-24
TOOLS & JAWS .....	16	FAQ'S .....	25-26
ENGINEERING DATA.....	17		
INSTALLATION INSTRUCTIONS.....	18		

## STREAMLINE®

### THE BEST IN THE JOINT.®

Since 1930, Mueller Industries' Streamline® brand has been the preferred choice of professionals around the world.

Trust your copper piping system with the proven performance and reliability of Streamline® products.

- Copper Plumbing Tube
- Copper AC & Refrigeration Tube
- Copper Oxygen & Medical Gas Tube
- Copper Temperature Control Tube
- Copper Plastic-Coated Tube
- Copper-Iron Tube (XHP™)
- Copper Line Sets & Mini Split Line Sets
- Copper Lines Sets with Duraguard™ PE Insulation
- Copper Solder-Joint Fittings & Flanges
- Copper Press-Joint Fittings & Flanges (PRS™)
- Copper Push-Fit Fittings (PSH™)
- Copper-Iron Braze-Joint Fittings (XHP™)
- Copper Solder-Joint Oxygen/Medical Gas Fittings
- Cast Bronze Fittings & Flanges
- Brass 45° Flare Fittings & Flanges
- Plumbing Valves
- Refrigeration Valves & Manifolds
- AC/R Protection Devices

### WHY STREAMLINE PRS™?

Press technology is growing in use as installers seek alternative methods due to skilled labor constraints and other factors. Its common piping system applications today range from those in new commercial building construction, to MRO factory maintenance, to retrofit and remodel of existing flow control systems. Since the first design was patented, there have been a number of important evolutionary modifications. These improvements have been focused on providing greater ease of installation and on increasing the reliability of modern press technology.

Streamline PRS™ builds upon these advancements and continues the quest of improved joint design, increased holding power, and greater reliability. With patented design improvements and rigorous testing requirements, we are confident that we have accomplished all of these objectives.

We understand that press tool and jaw sets are an expensive investment for the contractor and inventory item for wholesalers. Therefore, we focused on improvements to the seal mechanics, rather than the basic design of the fitting. With our design, Streamline PRS™ fittings are compatible with most tools and jaws on the market, making it easy for the end user.

With Streamline PRS™ we are confident that we have engineered a better, more reliable joint that will withstand higher pressures and will yield significantly improved anti-creep performance.



QUALITY

## SYSTEM DESCRIPTION

Streamline PRS™ mechanical press copper fittings are for use in plumbing or mechanical applications. Sizes range from 1/2" – 4" and the fittings are designed to join ASTM B88 (Types K, L, M) hard-drawn copper tube (1/2" – 4") and soft copper tube (1/2" – 1-1/4").

## FITTINGS

- 350 line items available, including elbows, couplings, fitting reducers, tees, adapters, unions, caps, flanges, and accessories.
- All fittings are made of either wrought copper or lead-free brass.

## APPLICATIONS

- All tubing must comply with the ASTM B88 standard.
- Approved for installations in above and below ground applications as allowed by local code.

## OPERATING PARAMETERS

- Operating pressure: 200 PSI CWP max
- Operating temperature range: -20°F – 250°F

## SYSTEM BENEFITS

- Fast and easy to use
- Flameless
- Permanent connections
- Size range from 1/2" to 4"
- Large selection of fittings
- Consistent professional appearance
- Less equipment required
- Environmentally friendly system
- Compatibility of fittings and tools

## APPROVED APPLICATIONS

- Potable water
- Hydronic heating (w/ glycol)
- Chilled water
- Compressed air (200 PSI max)
- Non-medical gases (140 PSI max)
- Low pressure steam (15 PSI max)
- Vacuum (24.5" mercury max @ 68°F)

## WARRANTY

Streamline PRS™ fittings carry a 50-year limited warranty against defects in material and workmanship.

## APPROVALS & CERTIFICATIONS

- ASME B16.51
- IAPMO PS-117
- NSF/ANSI 61
- NSF/ANSI 372
- CSA TIL-MSE-13
- ABS





## 45° ELBOW • SMALL

P X P

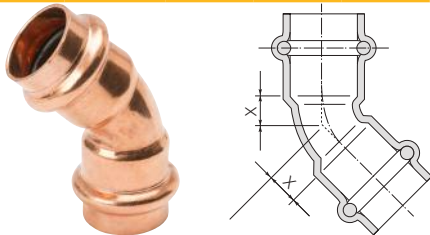

Item No.	Diameter	Approx Wt Lbs / Pc	Inner Qty Pcs / Bag	Master Qty Pcs / Box	Dimensions (Inch)	
					X	Z
PF 03026	1/2"	0.10	10	400	0.28	
PF 03034	3/4"	0.15	10	200	0.37	
PF 03044	1"	0.21	5	140	0.45	
PF 03050	1-1/4"	0.28	1	70	0.51	
PF 03055	1-1/2"	0.58	1	40	0.59	
PF 03059	2"	0.82	1	25	0.79	

## 45° ELBOW • STREET • LARGE

FTG X P

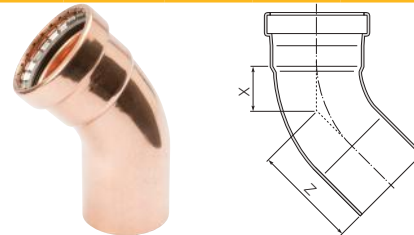

Item No.	Diameter	Approx Wt Lbs / Pc	Inner Qty Pcs / Bag	Master Qty Pcs / Box	Dimensions (Inch)	
					X	Z
PF 03363	2-1/2"	1.57	1	18	1.30	3.23
PF 03368	3"	2.32	1	12	1.57	3.50
PF 03373	4"	3.96	1	6	2.07	4.59

## 45° ELBOW • LARGE

P X P

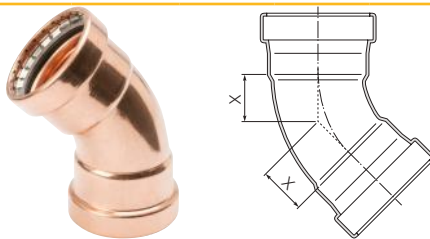

Item No.	Diameter	Approx Wt Lbs / Pc	Inner Qty Pcs / Bag	Master Qty Pcs / Box	Dimensions (Inch)	
					X	Z
PF 03063	2-1/2"	1.74	1	16	1.30	
PF 03067	3"	2.27	1	12	1.57	
PF 03073	4"	4.11	1	6	2.07	

## 90° ELBOW • SHORT RADIUS • SMALL

P X P

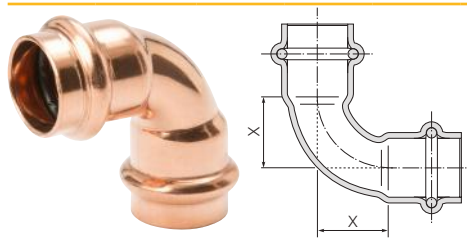

Item No.	Diameter	Approx Wt Lbs / Pc	Inner Qty Pcs / Bag	Master Qty Pcs / Box	Dimensions (Inch)	
					X	Z
PF 02722	1/2"	0.12	10	350	0.75	
PF 01634	3/4"	0.18	10	180	0.75	
PF 01647	1"	0.28	5	100	1.22	
PF 02084	1-1/4"	0.35	1	55	1.22	
PF 02085	1-1/2"	0.63	1	35	1.24	
PF 02086	2"	1.07	1	18	2.05	

## 45° ELBOW • STREET • SMALL

FTG X P

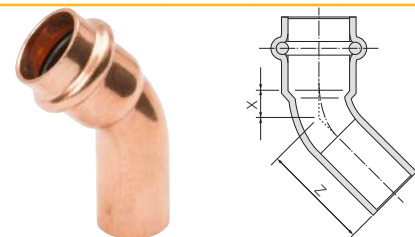

Item No.	Diameter	Approx Wt Lbs / Pc	Inner Qty Pcs / Bag	Master Qty Pcs / Box	Dimensions (Inch)	
					X	Z
PF 03326	1/2"	0.09	10	450	0.28	1.10
PF 03334	3/4"	0.15	10	260	0.37	1.32
PF 03344	1"	0.20	5	140	0.45	1.44
PF 03350	1-1/4"	0.28	1	70	0.51	1.67
PF 03355	1-1/2"	0.56	1	40	0.59	2.13
PF 03359	2"	0.80	1	25	0.79	2.48

## 90° ELBOW • LONG RADIUS • SMALL

P X P

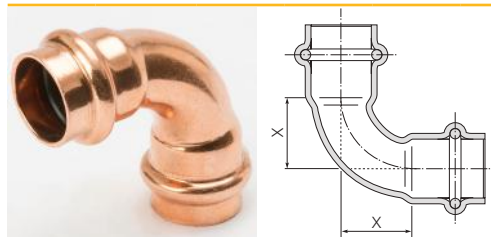

Item No.	Diameter	Approx Wt Lbs / Pc	Inner Qty Pcs / Bag	Master Qty Pcs / Box	Dimensions (Inch)	
					X	Z
PF 02722	1/2"	0.12	10	350	0.75	
PF 02734	3/4"	0.20	10	180	1.30	
PF 02747	1"	0.29	5	100	1.30	
PF 02055	1-1/4"	0.40	1	55	1.65	
PF 02063	1-1/2"	0.79	1	35	2.01	
PF 02072	2"	1.21	1	18	2.52	

**90° ELBOW • LONG RADIUS • LARGE**  
P X P

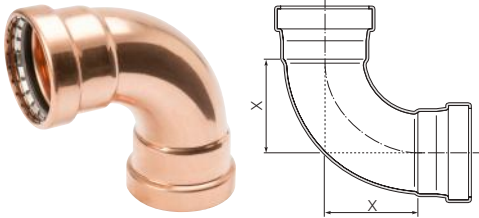

Item No.	Diameter	Approx Wt Lbs / Pc	Inner Qty Pcs / Bag	Master Qty Pcs / Box	Dimensions (Inch)	
					X	
PF 02082	2-1/2"	2.10	1	12	2.99	
PF 02092	3"	2.10	1	9	3.58	
PF 02095	4"	5.62	1	4	4.74	

**90° ELBOW • LONG RADIUS • STREET • SMALL**  
FTG X P

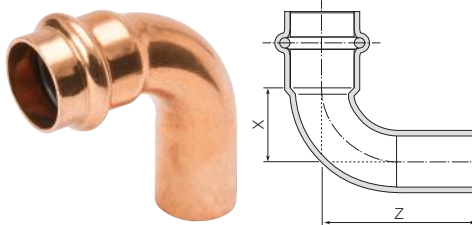

Item No.	Diameter	Approx Wt Lbs / Pc	Inner Qty Pcs / Bag	Master Qty Pcs / Box	Dimensions (Inch)	
					X	Z
PF 02822	1/2"	0.11	10	400	0.75	1.57
PF 02834	3/4"	0.19	10	200	1.02	2.01
PF 02847	1"	0.27	5	100	1.30	2.28
PF 02350	1-1/4"	0.41	1	55	1.65	2.83
PF 02355	1-1/2"	0.76	1	35	2.01	3.52
PF 02359	2"	1.16	1	20	2.52	4.15

**90° ELBOW • LONG RADIUS REDUCING • SMALL** P X P

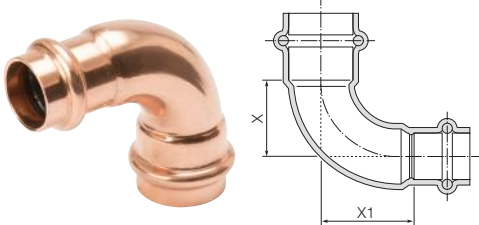

Item No.	Diameter	Approx Wt Lbs / Pc	Inner Qty Pcs / Bag	Master Qty Pcs / Box	Dimensions (Inch)	
					X	X1
PF 02736	3/4" x 1/2"	0.19	15	240	1.02	1.26
PF 02749	1" x 3/4"	0.30	10	120	1.30	1.56

**90° ELBOW • LONG RADIUS • STREET • LARGE**  
FTG X P

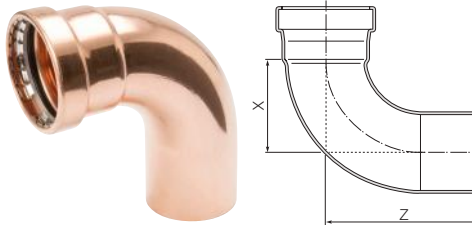

Item No.	Diameter	Approx Wt Lbs / Pc	Inner Qty Pcs / Bag	Master Qty Pcs / Box	Dimensions (Inch)	
					X	Z
PF 02363	2-1/2"	2.05	1	14	2.99	5.00
PF 02368	3"	3.04	1	9	3.58	5.58
PF 02395	4"	5.70	1	4	4.74	7.05

**90° ELBOW • SHORT RADIUS • STREET • SMALL**  
FTG X P

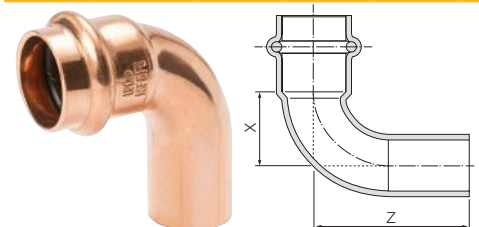

Item No.	Diameter	Approx Wt Lbs / Pc	Inner Qty Pcs / Bag	Master Qty Pcs / Box	Dimensions (Inch)	
					X	Z
PF 01654	3/4"	0.16	10	200	0.75	2.01
PF 02344	1"	0.27	5	100	1.22	2.28
PF 02384	1-1/4"	0.35	1	55	1.22	2.84
PF 02385	1-1/2"	0.64	1	35	1.24	3.52
PF 02386	2"	1.05	1	20	2.05	4.15

## 90° ELBOW • MALE • SMALL

P X MPT

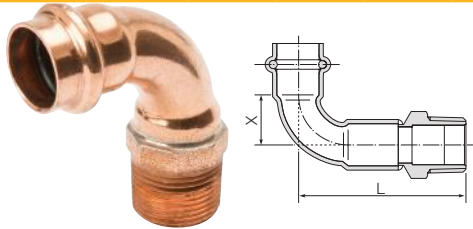

Item No.	Diameter	Approx Wt Lbs / Pc	Inner Qty Pcs / Bag	Master Qty Pcs / Box	Dimensions (Inch)	
					L	X
PF 01506	1/2"	0.23	5	200	2.82	0.75
PF 01531	3/4"	0.39	5	120	3.36	1.02
PF 01558	1"	0.60	1	65	3.76	1.30
PF 01593	1-1/4"	0.81	1	45	4.41	1.65
PF 01631	1-1/2"	1.42	1	25	5.22	2.01
PF 01679	2"	2.12	1	15	5.98	2.52

## ADAPTER • FEMALE • SMALL

P X FPT

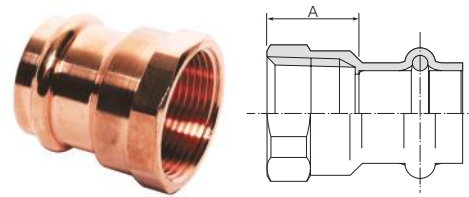

Item No.	Diameter	Approx Wt Lbs / Pc	Inner Qty Pcs / Bag	Master Qty Pcs / Box	Dimensions (Inch)
					A
PF 01231	1/2"	0.10	10	300	0.70
PF 01246	3/4"	0.17	10	150	0.87
PF 01263	1"	0.25	10	180	0.89
PF 01271	1-1/4"	0.35	1	80	0.96
PF 01279	1-1/2"	0.53	1	55	1.02
PF 01287	2"	0.78	1	40	1.06

## 90° ELBOW • FEMALE • SMALL

P X FPT

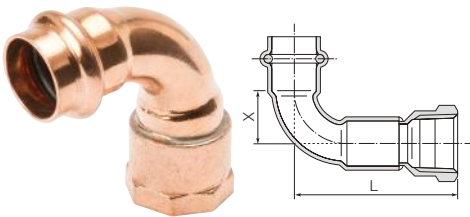

Item No.	Diameter	Approx Wt Lbs / Pc	Inner Qty Pcs / Bag	Master Qty Pcs / Box	Dimensions (Inch)	
					L	X
PF 01507	1/2"	0.23	5	200	2.65	0.75
PF 01532	3/4"	0.37	5	120	3.24	1.02
PF 01559	1"	0.55	1	60	3.57	1.30
PF 01594	1-1/4"	0.74	1	45	4.13	1.65
PF 01632	1-1/2"	1.34	1	25	4.95	2.01
PF 01680	2"	1.98	1	15	5.67	2.52

## ADAPTER • FEMALE • LARGE

P X FPT

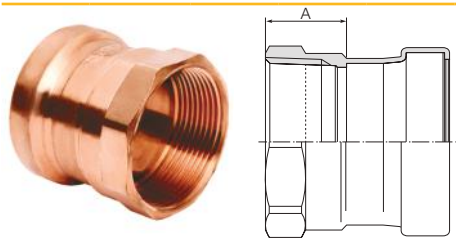

Item No.	Diameter	Approx Wt Lbs / Pc	Inner Qty Pcs / Bag	Master Qty Pcs / Box	Dimensions (Inch)
					A
PF 01296	2-1/2"	1.25	1	36	1.30
PF 01297	3"	1.85	1	24	1.54

## 90° ELBOW • DROP EAR • SMALL

P X FPT

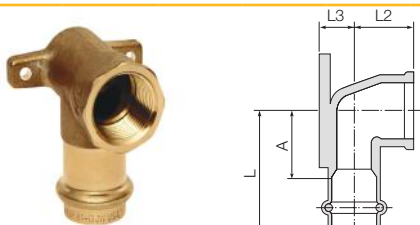

Item No.	Diameter	Approx Wt Lbs / Pc	Inner Qty Pcs / Bag	Master Qty Pcs / Box	Dimensions (Inch)			
					A	L	L2	L3
PF 01508	1/2"	0.25	5	100	0.88	1.63	0.76	0.75
PF 02581	3/4"	0.44	5	60	1.09	2.00	1.25	0.87

## ADAPTER • FEMALE • REDUCING • SMALL

P X FPT

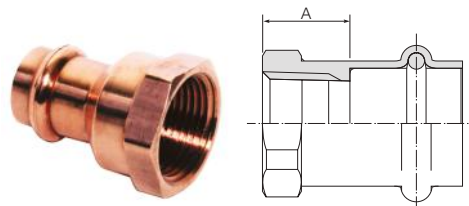

Item No.	Diameter	Approx Wt Lbs / Pc	Inner Qty Pcs / Bag	Master Qty Pcs / Box	Dimensions (Inch)
					A
PF 01232	1/2" x 3/8"	0.07	10	300	0.53
PF 01230	1/2" x 3/4"	0.15	10	180	0.98
PF 01247	3/4" x 1/2"	0.17	10	180	0.71
PF 01265	1" x 1/2"	0.29	10	120	0.73
PF 01264	1" x 3/4"	0.22	10	200	0.71
PF 01261	1" x 1-1/4"	0.46	10	60	1.40
PF 01272	1-1/4" x 1"	0.29	1	100	0.85
PF 01270	1-1/4" x 1-1/2"	0.62	1	70	1.56
PF 01280	1-1/2" x 1-1/4"	0.46	1	70	0.94



**ADAPTER • FEMALE • STREET • SMALL**  
FTG X FPT

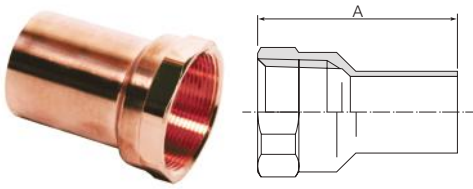

Item No.	Diameter	Approx Wt Lbs / Pc	Inner Qty Pcs / Bag	Master Qty Pcs / Box	Dimensions (Inch)	
					A	
PF 15310	1/2"	0.09	5	250		1.59
PF 01546	3/4"	0.15	5	150		1.90
PF 01563	1"	0.23	1	110		1.96
PF 01571	1-1/4"	0.32	1	100		2.17
PF 01579	1-1/2"	0.49	1	55		2.63
PF 01587	2"	0.75	1	40		2.84

**ADAPTER • MALE • LARGE**  
P X MPT

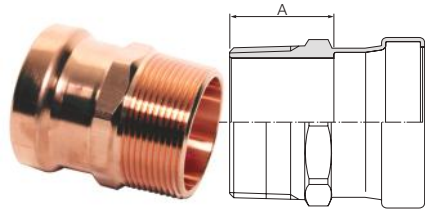

Item No.	Diameter	Approx Wt Lbs / Pc	Inner Qty Pcs / Bag	Master Qty Pcs / Box	Dimensions (Inch)	
					A	
PF 01196	2-1/2"	1.62	1	28		1.97
PF 01199	3"	2.23	1	18		2.11
PF 01150	4"	3.83	1	12		2.32

**ADAPTER • FEMALE • STREET • REDUCING • SMALL**  
FTG X FPT

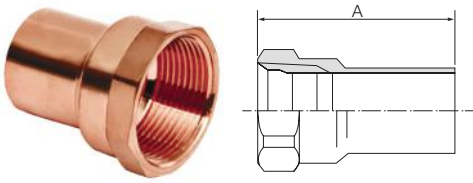

Item No.	Diameter	Approx Wt Lbs / Pc	Inner Qty Pcs / Bag	Master Qty Pcs / Box	Dimensions (Inch)	
					A	
PF 01534	1/2" x 3/4"	0.15	5	160		1.87
PF 01547	3/4" x 1/2"	0.15	5	160		1.81
PF 01564	1" x 3/4"	0.15	5	250		1.77

**ADAPTER • MALE • REDUCING • SMALL**  
P X MPT

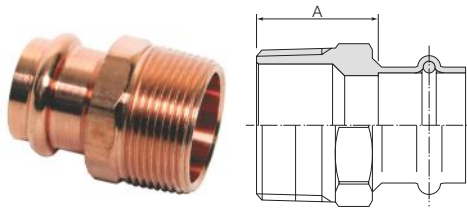

Item No.	Diameter	Approx Wt Lbs / Pc	Inner Qty Pcs / Bag	Master Qty Pcs / Box	Dimensions (Inch)	
					A	
PF 01132	1/2" x 3/8"	0.09	10	300		0.71
PF 01130	1/2" x 3/4"	0.19	10	180		0.97
PF 01147	3/4" x 1/2"	0.17	10	180		0.90
PF 01145	3/4" x 1"	0.30	10	200		1.20
PF 01164	1" x 3/4"	0.24	10	180		0.92
PF 01162	1" x 1-1/4"	0.45	10	100		1.23
PF 01172	1-1/4" x 1"	0.35	1	95		1.10
PF 01170	1-1/4" x 1-1/2"	0.59	1	75		1.30
PF 01180	1-1/2" x 1-1/4"	0.59	1	55		1.19
PF 01178	1-1/2" x 2"	1.01	1	40		1.75
PF 01188	2" x 1-1/2"	0.92	1	40		1.42

**ADAPTER • MALE • SMALL**  
P X MPT

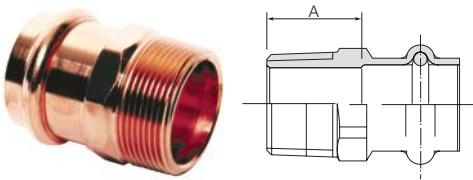

Item No.	Diameter	Approx Wt Lbs / Pc	Inner Qty Pcs / Bag	Master Qty Pcs / Box	Dimensions (Inch)	
					A	
PF 01131	1/2"	0.11	10	300		0.89
PF 01146	3/4"	0.19	10	160		0.89
PF 01163	1"	0.28	10	160		1.06
PF 01171	1-1/4"	0.37	1	100		0.99
PF 01179	1-1/2"	0.63	1	50		1.19
PF 01187	2"	0.90	1	35		1.28

**ADAPTER • MALE • STREET • SMALL**  
FTG X MPT

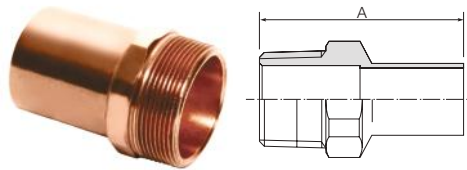

Item No.	Diameter	Approx Wt Lbs / Pc	Inner Qty Pcs / Bag	Master Qty Pcs / Box	Dimensions (Inch)	
					A	
PF 01431	1/2"	0.10	5	250		1.75
PF 01446	3/4"	0.17	5	160		2.02
PF 01463	1"	0.27	5	200		2.15
PF 01471	1-1/4"	0.41	1	100		2.44
PF 01479	1-1/2"	0.59	1	60		2.90
PF 01487	2"	0.89	1	40		3.15

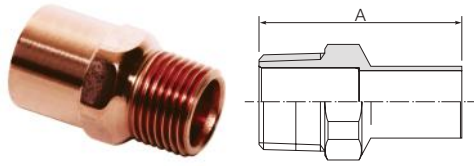
**ADAPTER • MALE • STREET  
REDUCING • SMALL FTG X MPT**

Item No.	Diameter	Approx Wt Lbs / Pc	Inner Qty Pcs / Bag	Master Qty Pcs / Box	Dimensions (Inch)	
					A	
PF 01434	1/2" x 3/4"	0.18	5	200	2.05	
PF 01447	3/4" x 1/2"	0.16	5	200	1.95	
PF 01464	1" x 3/4"	0.20	5	200	2.03	

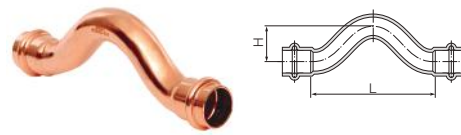
**COUPLING • CROSS OVER • SMALL  
P X P**

Item No.	Diameter	Approx Wt Lbs / Pc	Inner Qty Pcs / Bag	Master Qty Pcs / Box	Dimensions (Inch)	
					H	L
PF 02535	1/2"	0.21	10	200	0.94	3.33
PF 02583	3/4"	0.39	10	100	1.28	4.84

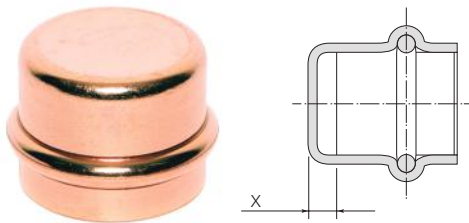
**CAP • SMALL  
P**

Item No.	Diameter	Approx Wt Lbs / Pc	Inner Qty Pcs / Bag	Master Qty Pcs / Box	Dimensions (Inch)	
					X	
PF 07007	1/2"	0.05	10	450	0.10	
PF 07009	3/4"	0.08	10	450	0.11	
PF 07011	1"	0.10	5	250	0.11	
PF 07012	1-1/4"	0.15	1	100	0.11	
PF 07013	1-1/2"	0.28	1	80	0.12	
PF 07014	2"	0.41	1	55	0.13	

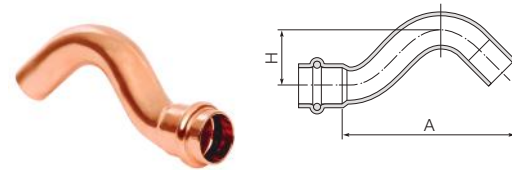
**COUPLING • CROSS OVER • STREET • SMALL  
FTG X P**

Item No.	Diameter	Approx Wt Lbs / Pc	Inner Qty Pcs / Bag	Master Qty Pcs / Box	Dimensions (Inch)	
					A	H
PF 12535	1/2"	0.15	10	250	3.78	0.94
PF 12583	3/4"	0.31	10	100	5.31	1.28

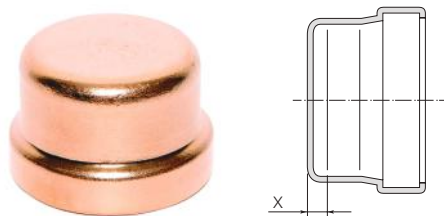
**CAP • LARGE  
P**

Item No.	Diameter	Approx Wt Lbs / Pc	Inner Qty Pcs / Bag	Master Qty Pcs / Box	Dimensions (Inch)	
					X	
PF 07015	2-1/2"	0.68	1	40	0.33	
PF 07016	3"	0.97	1	36	0.33	
PF 07018	4"	1.68	1	24	0.39	

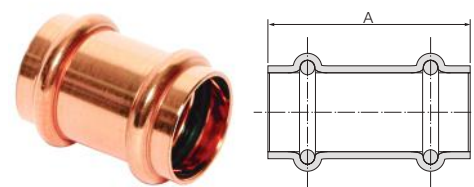
**COUPLING • NO STOP • SMALL  
P X P**

Item No.	Diameter	Approx Wt Lbs / Pc	Inner Qty Pcs / Bag	Master Qty Pcs / Box	Dimensions (Inch)	
					A	
PF 01903	1/2"	0.08	10	450	1.50	
PF 01905	3/4"	0.13	10	260	1.81	
PF 01906	1"	0.16	5	170	1.81	
PF 01907	1-1/4"	0.22	1	80	2.05	
PF 01908	1-1/2"	0.46	1	50	2.83	
PF 01909	2"	0.61	1	35	3.15	

**COUPLING • NO STOP • LARGE**

P X P

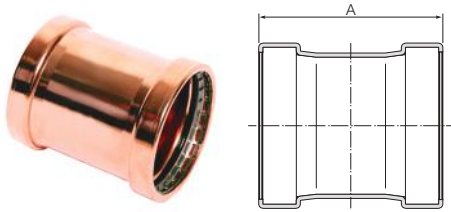

Item No.	Diameter	Approx Wt Lbs / Pc	Inner Qty Pcs / Bag	Master Qty Pcs / Box	Dimensions (Inch)
					A
PF 01910	2-1/2"	1.09	1	32	3.54
PF 01911	3"	1.45	1	18	3.86
PF 01913	4"	2.43	1	12	4.49

**COUPLING • STAKED STOP • LARGE**

P X P

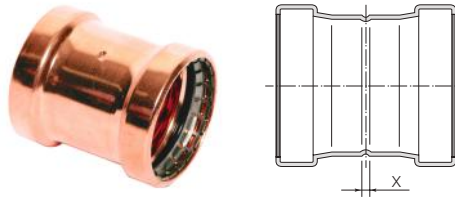

Item No.	Diameter	Approx Wt Lbs / Pc	Inner Qty Pcs / Bag	Master Qty Pcs / Box	Dimensions (Inch)
					X
PF 10151	2-1/2"	1.09	1	32	0.16
PF 10152	3"	1.45	1	18	0.16
PF 10154	4"	2.43	1	12	0.16

**COUPLING • NO STOP • EXTENDED • SMALL**

P X P

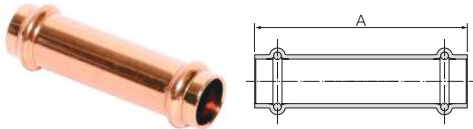

Item No.	Diameter	Approx Wt Lbs / Pc	Inner Qty Pcs / Bag	Master Qty Pcs / Box	Dimensions (Inch)
					A
PF 01950	1/2"	0.13	5	250	2.95
PF 01952	3/4"	0.20	5	150	3.41
PF 01955	1"	0.30	5	100	3.94
PF 01956	1-1/4"	0.38	1	60	4.13
PF 01957	1-1/2"	0.70	1	40	4.72
PF 01958	2"	0.95	1	27	5.31

**COUPLING • REDUCING • SMALL**

P X P

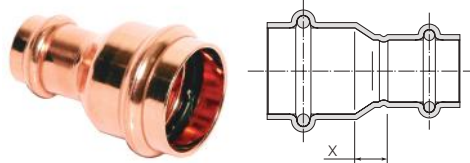

Item No.	Diameter	Approx Wt Lbs / Pc	Inner Qty Pcs / Bag	Master Qty Pcs / Box	Dimensions (Inch)
					X
PF 01036	3/4" x 1/2"	0.12	10	300	0.33
PF 01051	1" x 1/2"	0.16	10	200	0.53
PF 01049	1" x 3/4"	0.18	10	200	0.30
PF 01060	1-1/4" x 1/2"	0.21	1	100	0.71
PF 01058	1-1/4" x 3/4"	0.24	1	80	0.51
PF 01056	1-1/4" x 1"	0.23	1	80	0.31
PF 01069	1-1/2" x 1/2"	0.37	1	70	0.91
PF 01067	1-1/2" x 3/4"	0.39	1	70	0.69
PF 01065	1-1/2" x 1"	0.38	1	70	0.49
PF 01064	1-1/2" x 1-1/4"	0.39	1	60	0.37
PF 01079	2" x 1/2"	0.55	1	50	1.28
PF 01077	2" x 3/4"	0.55	1	50	1.10
PF 01075	2" x 1"	0.47	1	50	0.81
PF 01074	2" x 1-1/4"	0.55	1	40	0.73
PF 01073	2" x 1-1/2"	0.64	1	40	0.51

**COUPLING • STAKED STOP • SMALL**

P X P

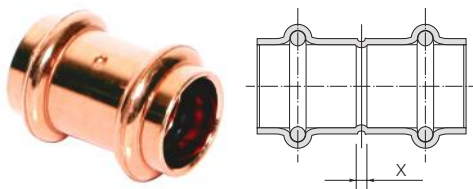

Item No.	Diameter	Approx Wt Lbs / Pc	Inner Qty Pcs / Bag	Master Qty Pcs / Box	Dimensions (Inch)
					X
PF 10145	1/2"	0.08	10	550	0.08
PF 10146	3/4"	0.13	10	260	0.08
PF 10147	1"	0.16	5	170	0.08
PF 10148	1-1/4"	0.22	1	80	0.08
PF 10149	1-1/2"	0.46	1	50	0.08
PF 10150	2"	0.61	1	35	0.08

**COUPLING • REDUCING • LARGE**

P X P

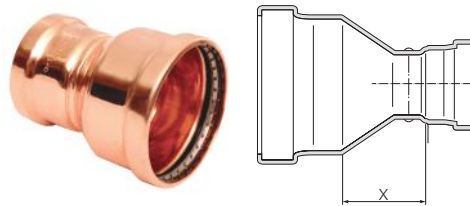

Item No.	Diameter	Approx Wt Lbs / Pc	Inner Qty Pcs / Bag	Master Qty Pcs / Box	Dimensions (Inch)
					X
PF 01086	2-1/2" x 1"	0.99	1	40	1.54
PF 01085	2-1/2" x 1-1/4"	1.00	1	40	1.65
PF 01084	2-1/2" x 1-1/2"	1.09	1	40	1.50
PF 01083	2-1/2" x 2"	1.16	1	30	1.12
PF 01095	3" x 1-1/2"	1.57	1	24	1.83
PF 01094	3" x 2"	1.58	1	24	1.50
PF 01093	3" x 2-1/2"	1.73	1	24	1.14
PF 10111	4" x 2"	2.47	1	10	2.24
PF 10110	4" x 2-1/2"	2.67	1	10	1.93
PF 10109	4" x 3"	2.79	1	10	1.54



## FITTING REDUCER • SMALL

FTG X P

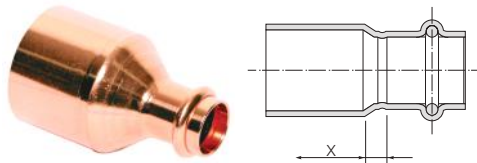

Item No.	Diameter	Approx Wt Lbs / Pc	Inner Qty Pcs / Bag	Master Qty Pcs / Box	Dimensions (Inch)	
					X	
PF 01326	3/4" x 1/2"	0.11	10	400	0.20	
PF 01339	1" x 1/2"	0.13	10	300	0.41	
PF 01337	1" x 3/4"	0.15	10	240	0.24	
PF 01347	1-1/4" x 1/2"	0.17	5	180	0.59	
PF 01345	1-1/4" x 3/4"	0.20	5	170	0.47	
PF 01343	1-1/4" x 1"	0.19	5	150	0.24	
PF 01355	1-1/2" x 1/2"	0.27	5	130	0.79	
PF 01353	1-1/2" x 3/4"	0.28	1	70	0.61	
PF 01351	1-1/2" x 1"	0.30	1	70	0.43	
PF 01350	1-1/2" x 1-1/4"	0.29	1	70	0.26	
PF 01364	2" x 1/2"	0.45	1	50	1.16	
PF 01362	2" x 3/4"	0.46	1	50	0.97	
PF 01360	2" x 1"	0.46	1	50	0.79	
PF 01359	2" x 1-1/4"	0.46	1	50	0.61	
PF 01358	2" x 1-1/2"	0.55	1	40	0.43	

## FITTING REDUCER • LARGE

FTG X P

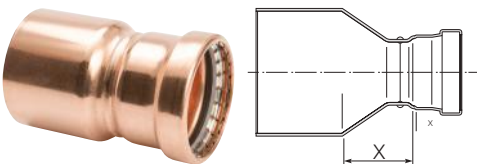

Item No.	Diameter	Approx Wt Lbs / Pc	Inner Qty Pcs / Bag	Master Qty Pcs / Box	Dimensions (Inch)	
					X	
PF 01370	2-1/2" x 1"	0.80	1	40	1.36	
PF 01369	2-1/2" x 1-1/4"	0.80	1	40	1.52	
PF 01368	2-1/2" x 1-1/2"	0.88	1	40	1.32	
PF 01367	2-1/2" x 2"	0.90	1	35	0.94	
PF 01379	3" x 1-1/4"	1.11	1	25	1.91	
PF 01378	3" x 1-1/2"	1.21	1	24	1.71	
PF 01377	3" x 2"	1.21	1	24	1.32	
PF 01376	3" x 2-1/2"	1.38	1	24	0.98	
PF 01389	4" x 2"	2.33	1	12	2.11	
PF 01388	4" x 2-1/2"	2.44	1	10	1.75	
PF 01387	4" x 3"	2.52	1	10	1.42	

## TEE • SMALL

P X P X P

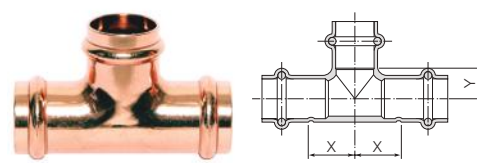

Item No.	Diameter	Approx Wt Lbs / Pc	Inner Qty Pcs / Bag	Master Qty Pcs / Box	Dimensions (Inch)	
					X	Y
PF 04006	1/2"	0.21	10	200	0.67	0.49
PF 04031	3/4"	0.35	10	120	0.81	0.55
PF 04048	1"	0.51	5	70	0.89	0.79
PF 04068	1-1/4"	0.66	1	45	0.96	0.83
PF 04084	1-1/2"	1.22	1	25	1.10	1.10
PF 40102	2"	1.73	1	15	1.30	1.34

## TEE • LARGE

P X P X P

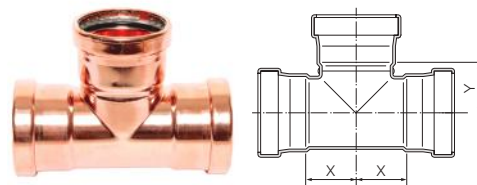

Item No.	Diameter	Approx Wt Lbs / Pc	Inner Qty Pcs / Bag	Master Qty Pcs / Box	Dimensions (Inch)	
					X	Y
PF 40123	2-1/2"	2.13	1	10	1.73	1.81
PF 40152	3"	3.01	1	7	2.01	2.11
PF 40200	4"	5.48	1	4	2.58	2.68

## TEE • REDUCING • SMALL

P X P X P

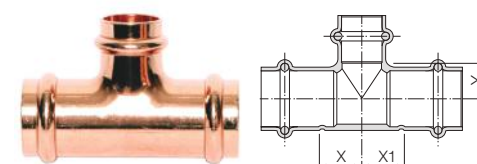

Item No.	Diameter	Approx Wt Lbs / Pc	Inner Qty Pcs / Bag	Master Qty Pcs / Box	Dimensions (Inch)		
					X	X1	Y
PF 04047	1/2" x 1/2" x 3/4"	0.32	10	140	0.83	0.83	0.55
PF 04067	1/2" x 1/2" x 1"	0.72	5	60	2.28	2.28	0.80
PF 04043	3/4" x 1/2" x 1/2"	0.28	10	150	0.61	0.77	0.55
PF 04041	3/4" x 1/2" x 3/4"	0.33	5	120	0.81	0.89	0.55
PF 04033	3/4" x 3/4" x 1/2"	0.29	10	140	0.61	0.61	0.55
PF 04065	3/4" x 3/4" x 1"	0.77	5	60	2.11	2.11	0.79
PF 04062	1" x 1/2" x 3/4"	0.44	5	80	0.81	1.00	0.71
PF 04061	1" x 1/2" x 1"	0.48	5	80	0.89	1.22	0.79
PF 04058	1" x 3/4" x 1/2"	0.51	5	100	0.69	0.77	0.79
PF 04056	1" x 3/4" x 3/4"	0.43	5	100	0.81	0.96	0.71

**TEE • REDUCING • SMALL**  
P X P X P

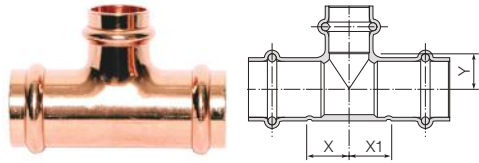

**TEE • REDUCING • LARGE**  
P X P X P

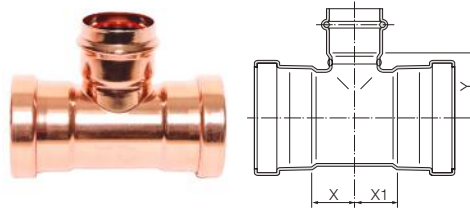

Item No.	Diameter	Approx Wt Lbs / Pc	Inner Qty Pcs / Bag	Master Qty Pcs / Box	Dimensions (Inch)			Item No.	Diameter	Approx Wt Lbs / Pc	Inner Qty Pcs / Bag	Master Qty Pcs / Box	Dimensions (Inch)		
					X	X1	Y						X	X1	Y
PF 04055	1" x 3/4" x 1"	0.48	5	70	0.89	1.10	0.80	PF 40222	2-1/2" x 3/4" x 2-1/2"	3.34	1	10	1.73	5.20	1.81
PF 04051	1" x 1" x 1/2"	0.41	5	100	0.69	0.69	0.79	PF 40221	2-1/2" x 1" x 2-1/2"	3.33	1	10	1.73	5.06	1.81
PF 04049	1" x 1" x 3/4"	0.45	5	80	0.81	0.81	0.71	PF 40220	2-1/2" x 1-1/4" x 2-1/2"	3.35	1	8	1.73	5.22	1.81
PF 04082	1" x 1" x 1-1/4"	1.02	1	35	2.42	2.42	0.83	PF 40138	2-1/2" x 1-1/2" x 2"	3.10	1	10	1.59	4.90	1.83
PF 04083	1-1/4" x 1/2" x 1-1/4"	0.81	1	40	0.96	2.66	0.83	PF 40137	2-1/2" x 1-1/2" x 2-1/2"	3.47	1	8	1.73	5.04	1.81
PF 04081	1-1/4" x 3/4" x 1/2"	0.65	1	50	0.47	2.05	0.83	PF 40135	2-1/2" x 2" x 3/4"	2.54	1	15	0.98	3.90	1.56
PF 04080	1-1/4" x 3/4" x 3/4"	0.73	1	50	0.61	2.19	0.83	PF 40134	2-1/2" x 2" x 1"	2.60	1	15	1.10	4.02	1.59
PF 04079	1-1/4" x 3/4" x 1"	0.78	1	50	0.69	2.26	0.83	PF 40132	2-1/2" x 2" x 1-1/2"	2.89	1	12	1.34	4.29	1.83
PF 04078	1-1/4" x 3/4" x 1-1/4"	0.85	1	40	0.96	2.54	0.83	PF 40131	2-1/2" x 2" x 2"	3.06	1	10	1.59	4.53	1.83
PF 04076	1-1/4" x 1" x 1/2"	0.65	1	50	0.47	1.81	0.83	PF 40130	2-1/2" x 2" x 2-1/2"	3.43	1	10	1.73	4.65	1.81
PF 04075	1-1/4" x 1" x 3/4"	0.70	1	45	0.61	1.95	0.83	PF 40129	2-1/2" x 2-1/2" x 1/2"	1.52	1	18	0.87	0.87	1.52
PF 04074	1-1/4" x 1" x 1"	0.75	1	50	0.69	2.03	0.83	PF 40128	2-1/2" x 2-1/2" x 3/4"	1.64	1	18	0.98	0.98	1.56
PF 04073	1-1/4" x 1" x 1-1/4"	0.84	1	40	0.96	2.30	0.83	PF 40127	2-1/2" x 2-1/2" x 1"	1.70	1	16	1.10	1.10	1.59
PF 04071	1-1/4" x 1-1/4" x 1/2"	0.45	1	60	0.47	0.47	0.83	PF 40126	2-1/2" x 2-1/2" x 1-1/4"	1.79	1	15	1.24	1.24	1.83
PF 04070	1-1/4" x 1-1/4" x 3/4"	0.50	1	55	0.61	0.61	0.83	PF 40125	2-1/2" x 2-1/2" x 1-1/2"	1.92	1	12	1.34	1.34	1.83
PF 04069	1-1/4" x 1-1/4" x 1"	0.57	1	50	0.69	0.69	0.83	PF 40124	2-1/2" x 2-1/2" x 2"	2.13	1	12	1.59	1.59	1.83
PF 40244	1-1/2" x 1/2" x 1-1/2"	1.48	1	25	1.10	3.39	1.10	PF 40179	3" x 3/4" x 3"	4.68	1	6	2.01	6.00	2.11
PF 40238	1-1/2" x 3/4" x 3/4"	1.04	1	30	0.63	2.74	1.10	PF 40178	3" x 1" x 3"	4.68	1	7	2.01	5.81	2.11
PF 04098	1-1/2" x 1" x 3/4"	1.08	1	30	0.63	2.56	1.10	PF 40181	3" x 1-1/4" x 3"	4.69	1	6	2.01	6.06	2.11
PF 04097	1-1/2" x 1" x 1"	1.15	1	30	0.75	2.68	1.10	PF 40174	3" x 1-1/2" x 3"	4.72	1	6	2.01	5.85	2.11
PF 04095	1-1/2" x 1" x 1-1/2"	1.46	1	25	1.10	3.03	1.10	PF 40164	3" x 2" x 2"	4.12	1	9	1.61	5.06	2.09
PF 04093	1-1/2" x 1-1/4" x 3/4"	1.11	1	35	0.63	2.38	1.10	PF 40165	3" x 2" x 2-1/2"	4.38	1	8	1.77	5.22	2.07
PF 04092	1-1/2" x 1-1/4" x 1"	1.18	1	30	0.75	2.50	1.10	PF 40167	3" x 2" x 3"	4.75	1	6	2.01	5.45	2.11
PF 04091	1-1/2" x 1-1/4" x 1-1/4"	1.24	1	30	0.96	2.72	1.16	PF 40157	3" x 2-1/2" x 2"	4.24	1	8	1.77	1.61	2.09
PF 04088	1-1/2" x 1-1/2" x 1/2"	0.75	1	40	0.47	0.47	1.08	PF 40158	3" x 2-1/2" x 2-1/2"	4.60	1	6	1.77	4.88	2.07
PF 04087	1-1/2" x 1-1/2" x 3/4"	0.84	1	35	0.63	0.63	1.10	PF 40159	3" x 2-1/2" x 3"	4.95	1	6	2.01	5.12	2.11
PF 04086	1-1/2" x 1-1/2" x 1"	0.92	1	35	0.75	0.75	1.10	PF 40145	3" x 3" x 1/2"	2.07	1	15	0.87	0.87	1.79
PF 04085	1-1/2" x 1-1/2" x 1-1/4"	1.06	1	30	0.96	0.96	1.16	PF 40146	3" x 3" x 3/4"	2.14	1	12	1.00	1.00	1.80
PF 40249	2" x 1/2" x 2"	2.11	1	15	1.30	4.11	1.34	PF 40147	3" x 3" x 1"	2.23	1	12	1.10	1.10	1.85
PF 40248	2" x 3/4" x 2"	2.12	1	15	1.30	3.92	1.34	PF 40148	3" x 3" x 1-1/4"	2.33	1	12	1.24	1.24	2.09
PF 40247	2" x 1" x 1"	1.61	1	20	3.29	0.85	1.34	PF 40149	3" x 3" x 1-1/2"	2.55	1	10	1.34	1.34	2.09
PF 40245	2" x 1" x 2"	2.09	1	15	1.30	3.74	1.34	PF 40150	3" x 3" x 2"	2.75	1	10	1.61	1.61	2.09
PF 40117	2" x 1-1/4" x 1-1/4"	1.73	1	20	0.89	3.15	1.34	PF 40151	3" x 3" x 2-1/2"	2.68	1	7	1.77	1.77	2.07
PF 40113	2" x 1-1/2" x 3/4"	1.70	1	20	0.75	2.83	1.34	PF 40204	4" x 3" x 2"	6.97	1	4	5.49	1.63	2.66
PF 40112	2" x 1-1/2" x 1"	1.73	1	20	0.85	2.93	1.34	PF 40206	4" x 3" x 3"	7.85	1	4	2.11	5.96	2.70
PF 40111	2" x 1-1/2" x 1-1/4"	1.83	1	20	0.89	2.97	1.34	PF 40191	4" x 4" x 1/2"	3.41	1	8	0.87	0.87	2.42
PF 40110	2" x 1-1/2" x 1-1/2"	1.97	1	16	1.08	3.17	1.34	PF 40192	4" x 4" x 3/4"	3.48	1	8	1.02	1.02	2.39
PF 40109	2" x 1-1/2" x 2"	2.19	1	16	1.30	3.39	1.34	PF 40193	4" x 4" x 1"	3.60	1	8	1.14	1.14	2.38
PF 40107	2" x 2" x 1/2"	0.99	1	25	0.49	0.49	1.26	PF 40194	4" x 4" x 1-1/4"	3.83	1	5	1.28	1.28	2.66
PF 40106	2" x 2" x 3/4"	1.20	1	25	0.75	0.75	1.34	PF 40195	4" x 4" x 1-1/2"	4.00	1	6	1.38	1.38	2.66
PF 40105	2" x 2" x 1"	1.28	1	23	0.85	0.85	1.34	PF 40196	4" x 4" x 2"	4.25	1	6	1.63	1.63	2.66
PF 40104	2" x 2" x 1-1/4"	1.33	1	20	0.89	0.89	1.34	PF 40197	4" x 4" x 2-1/2"	4.74	1	4	1.87	1.87	2.64
PF 40103	2" x 2" x 1-1/2"	1.53	1	16	1.08	1.08	1.34	PF 40198	4" x 4" x 3"	5.15	1	4	2.11	2.11	2.70

## TEE • FEMALE • SMALL

P X P X FPT

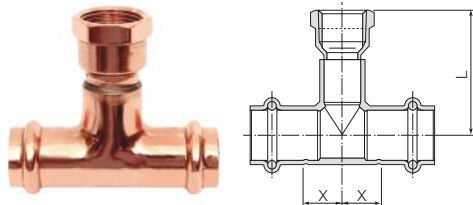

Item No.	Diameter	Approx Wt Lbs / Pc	Inner Qty Pcs / Bag	Master Qty Pcs / Box	Dimensions (Inch)	
					L	X
PF 01512	1/2"	0.30	5	150	2.08	0.67
PF 01538	3/4"	0.51	5	80	2.45	0.81
PF 01569	1"	0.74	5	60	2.75	0.89
PF 01607	1-1/4"	0.94	1	40	3.04	0.96
PF 01644	1-1/2"	1.64	1	20	3.90	1.10

## UNION • SMALL

P X P

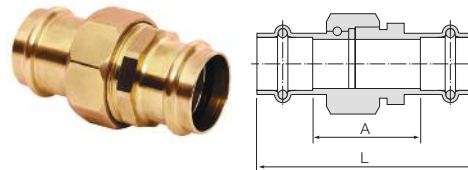

Item No.	Diameter	Approx Wt Lbs / Pc	Inner Qty Pcs / Bag	Master Qty Pcs / Box	Dimensions (Inch)	
					A	L
PF 08003	1/2"	0.31	1	144	1.38	2.87
PF 08004	3/4"	0.48	1	60	1.31	3.22
PF 08005	1"	0.73	1	32	1.91	3.27
PF 11205	1-1/4"	0.93	1	28	1.92	3.27
PF 11206	1-1/2"	1.20	1	24	2.59	3.27
PF 11207	2"	1.92	1	16	2.37	3.27

## TEE • FEMALE • REDUCING • SMALL

P X P X FPT

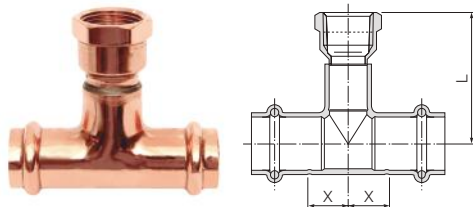

Item No.	Diameter	Approx Wt Lbs / Pc	Inner Qty Pcs / Bag	Master Qty Pcs / Box	Dimensions (Inch)	
					L	X
PF 02577	3/4" x 3/4" x 1/4"	0.36	5	120	1.89	0.61
PF 01539	3/4" x 3/4" x 1/2"	0.39	5	100	2.13	0.61
PF 01570	1" x 1" x 1/2"	0.47	5	80	2.37	0.69
PF 01572	1" x 1" x 3/4"	0.60	5	70	2.61	0.81
PF 01613	1-1/4" x 1-1/4" x 1/2"	0.56	1	60	2.41	0.47
PF 02654	1-1/4" x 1-1/4" x 3/4"	0.69	1	50	2.72	0.61
PF 01645	1-1/2" x 1-1/2" x 1/2"	0.83	1	40	2.67	0.47
PF 02673	1-1/2" x 1-1/2" x 3/4"	0.95	1	35	3.00	0.63
PF 01699	2" x 2" x 1/2"	1.06	1	25	2.85	0.49
PF 02706	2" x 2" x 3/4"	1.28	1	20	3.24	0.75

## UNION • FEMALE • SMALL

P X FPT

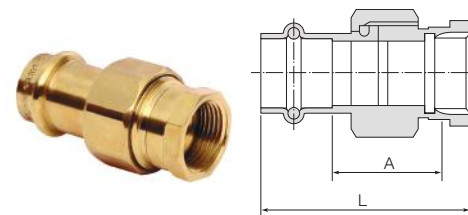

Item No.	Diameter	Approx Wt Lbs / Pc	Inner Qty Pcs / Bag	Master Qty Pcs / Box	Dimensions (Inch)	
					A	L
PF 11422	1/2"	0.21	1	192	0.90	2.05
PF 11423	3/4"	0.43	1	90	0.90	2.86
PF 11424	1"	0.62	1	48	0.83	2.82
PF 11425	1-1/4"	0.84	1	28	1.20	3.06
PF 11426	1-1/2"	1.04	1	24	1.69	3.02
PF 11427	2"	1.52	1	16	1.50	3.24

## TEE • FEMALE • REDUCING • LARGE

P X P X FPT

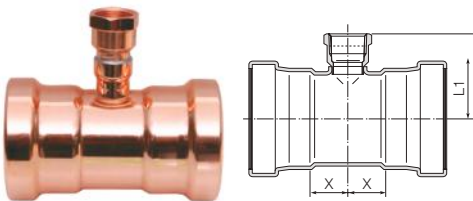

Item No.	Diameter	Approx Wt Lbs / Pc	Inner Qty Pcs / Bag	Master Qty Pcs / Box	Dimensions (Inch)	
					L1	X
PF 02727	2-1/2" x 2-1/2" x 3/4"	1.67	1	18	2.37	0.98
PF 02718	3" x 3" x 3/4"	2.27	1	13	2.61	1.00
PF 02729	4" x 4" x 3/4"	3.55	1	8	3.20	1.02

## UNION • MALE • SMALL

P X MPT

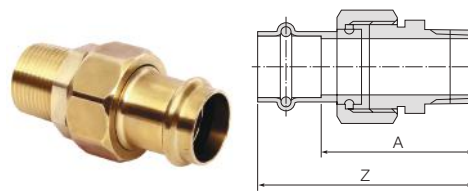

Item No.	Diameter	Approx Wt Lbs / Pc	Inner Qty Pcs / Bag	Master Qty Pcs / Box	Dimensions (Inch)	
					A	Z
PF 11210	1/2"	0.28	1	144	1.67	2.78
PF 11211	3/4"	0.49	1	60	1.77	3.38
PF 11212	1"	0.77	1	32	2.20	3.76
PF 11213	1-1/4"	1.01	1	28	2.20	3.80
PF 11214	1-1/2"	1.32	1	24	2.87	3.77
PF 11215	2"	1.97	1	16	2.56	4.56



**FLANGE • SMALL**  
P X FLANGE

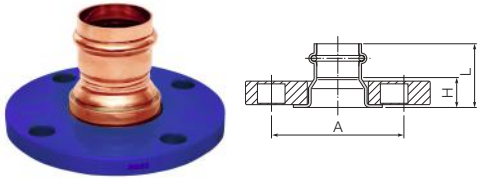

Item No.	Diameter	Approx Wt Lbs / Pc	Inner Qty Pcs / Bag	Master Qty Pcs / Box	Dimensions (Inch)		
					A	H	L
PF 02933	1"	2.34	1	14	3.11	1.78	2.68
PF 03806	1-1/4"	2.94	1	14	3.50	1.80	2.82
PF 03907	1-1/2"	3.13	1	7	3.88	1.78	3.19
PF 02980	2"	4.50	1	4	4.76	1.86	3.44

**BALL VALVE • PRESS**  
P X P

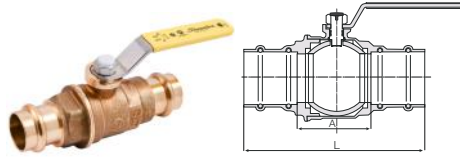

Item No.	Diameter	Approx Wt Lbs / Pc	Inner Qty Pcs / Bag	Master Qty Pcs / Box	Dimensions (Inch)	
					A	L
107-723PV	1/2"	0.54	5	50	1.15	3.90
107-724PV	3/4"	0.87	5	25	1.39	4.51
107-725PV	1"	1.14	3	15	1.65	4.77
107-726PV	1-1/4"	1.54	2	12	1.96	5.08
107-727PV	1-1/2"	2.77	2	12	2.33	5.83
107-728PV	2"	4.22	2	10	2.96	7.33

**FLANGE • LARGE**  
P X FLANGE

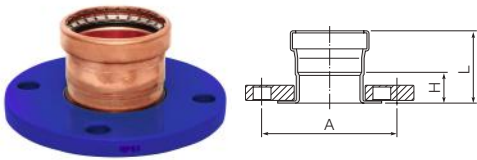

Item No.	Diameter	Approx Wt Lbs / Pc	Inner Qty Pcs / Bag	Master Qty Pcs / Box	Dimensions (Inch)		
					A	H	L
PF 02746	2-1/2"	6.29	1	4	5.51	1.57	3.26
PF 02802	3"	7.53	1	3	6.30	1.38	3.23
PF 01940	4"	11.76	1	3	7.28	1.51	3.68

**BALL VALVE • PRESS**  
P X P

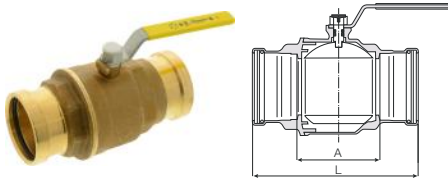

Item No.	Diameter	Approx Wt Lbs / Pc	Inner Qty Pcs / Bag	Master Qty Pcs / Box	Dimensions (Inch)	
					A	L
107-729PV	2-1/2"	8.04	1	2	3.90	8.27
107-730PV	3"	10.60	1	2	4.42	8.92
107-731PV	4"	17.44	1	1	5.74	10.24

**FLANGE**  
FTG X FLANGE

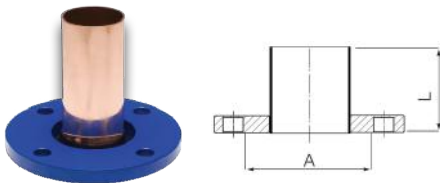

Item No.	Diameter	Approx Wt Lbs / Pc	Inner Qty Pcs / Bag	Master Qty Pcs / Box	Dimensions (Inch)	
					A	L
PF 12980	2"	6.50	1	1	4.75	6.00
PF 12746	2-1/2"	7.40	1	1	5.50	6.00
PF 12802	3"	8.50	1	1	6.00	6.00
PF 11940	4"	12.70	1	1	7.50	6.00

## TOOL & JAW COMPATIBILITY

Using the performance requirements outlined in ASME B16.51, and in-house testing requirements in conjunction with operational instructions provided by various tool and jaw manufacturers, the tools and jaws listed below are compatible with Streamline PRS™ fittings.

It is important to follow the specific manufacturer's guidelines for best use and practice and for required and periodic maintenance of both the tool and jaws used in copper press systems. Failure to do so may void the tool and jaw manufacturers' warranties and cause improper pressing of fittings.

For additional information regarding manufacturers' tools and/or jaw sets, refer to the individual websites of the specific manufacturer. Individual tool and jaw manufacturers recommended maintenance and calibration schedules vary. Be sure to follow the instructions specific to the brand of tool and jaw set being used.

### 1/2" – 2"

- Milwaukee M12 Tool w/Compact Jaws 1/2" – 1-1/4"
- Milwaukee M18 Tool w/Standard Jaws 1/2" – 2"
- NIBCO Mini Tool w/Mini Jaws 1/2" – 1"
- NIBCO Standard Tool w/Standard Jaws 1/2" – 2"
- REMS Mini Tool w/Mini Jaws 1/2" – 1-1/4"
- REMS Standard Tools w/Standard Jaws 1/2" – 2"
- Ridgid Compact Tools w/Compact Jaws 1/2" – 1-1/4"
- Ridgid Standard Tools w/Standard Jaws 1/2" – 2"
- Rothenberger Compact Tool w/Compact Jaws 1/2" – 1"
- Rothenberger Standard Tools w/Standard Jaws 1/2" – 2"
- Klauke UPA Tool w/Standard Jaws 1/2" – 2"
- Klauke MAP Tool w/Mini Jaws 1/2" – 1-1/4"

### 2-1/2" – 4"

- Milwaukee M18 Tools w/Rings & Ring Jaw
- REMS Standard Tools w/Rings & Z5 Adapter Tong
- Ridgid Standard Tools w/ Rings & V2 Actuator Jaw



## APPLICATIONS

Streamline PRS™ fittings are designed to be joined with ASTM B88 seamless copper water tube (K, L, & M) in residential and commercial plumbing and mechanical systems. Listed below are common applications approved for Streamline PRS™ fittings.

Types of Service	Comments	Pressure	Temperature	Compatible with EPDM Seal
<b>Fluids/Water Potable</b>				
Hot and Cold Water	—	200 PSI	32°F to 250°F	✓
Rainwater / Grey Water	—	200 PSI	-20°F to 250°F	✓
Chilled Water	Ethylene Glycol / Propylene Glycol	200 PSI	-20°F to 250°F	✓
Hydronic Heating	Ethylene Glycol / Propylene Glycol	200 PSI	-20°F to 250°F	✓
Cooling Water	Up to 50% Ethylene Glycol or Propylene Glycol solution	200 PSI	-20°F to 250°F	✓
Low-Pressure Steam	—	UP TO 15 PSI	248°F	✓
<b>Fuel, Oil and Lubricant</b>				
Ethanol	Pure Grain Alcohol	200 PSI	—	✓
<b>Gases</b>				
Compressed Air	Less than 25mg/m <sup>3</sup> oil content	200 PSI	Up to 140°F	✓
Oxygen - O <sub>2</sub> (non medical)	Keep oil and fat free/non-liquid O <sub>2</sub>	140 PSI	Up to 140°F	✓
Nitrogen - N <sub>2</sub>	—	200 PSI	Up to 140°F	✓
Argon	Welding Use	200 PSI	Up to 140°F	✓
Hydrogen - H <sub>2</sub>	—	125 PSI	Up to 140°F	✓
Vacuum	—	Max 29.2 inches of Mercury	Up to 140°F	✓
Carbon Dioxide - CO <sub>2</sub>	Dry	—	Up to 140°F	✓

Contact Customer Service for information on applications not listed and applications outside the temperature and pressure ranges listed above.

Fluids containing hydrocarbon-based oils are not compatible with the EPDM seal.





## INSTALLATION INSTRUCTIONS – 1/2" – 2"

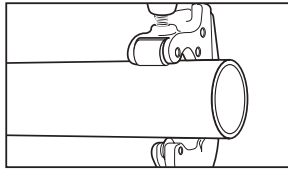

**1.** Cut tube square using a tube cutter or fine tooth saw.

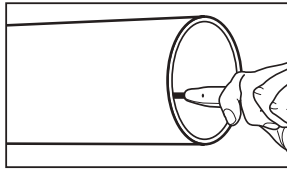

**2.** Deburr tube ID using a deburring tool.

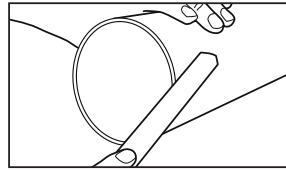

**3.** Deburr tube OD using half round file.

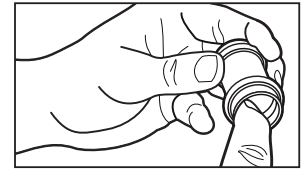

**4.** Check fitting bead to ensure seal is present. Do not use any type of oil lubrication.

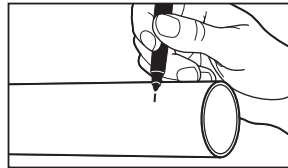

**5.** Mark tube to proper fitting insertion depth (see Insertion Depth Chart below).

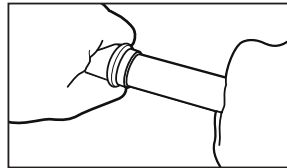

**6.** Turn slightly while sliding press fitting onto tube. Slide all the way to insertion mark and make contact with stop.

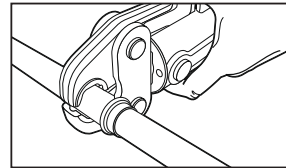

**7.** Place press tool at a right angle over fitting bead. Start the pressing process. Please see specific tool manufacturer for tool instruction.

Tube Size	1/2"	3/4"	1"	1-1/4"	1-1/2"	2"
Insertion Depth	3/4"	7/8"	7/8"	1"	1-7/16"	1-9/16"

Streamline PRS™ fittings must be connected with approved press tool. Please see specific tool manufacturer for tool instruction.

## INSTALLATION INSTRUCTIONS – 2-1/2" – 4"

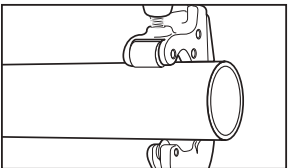

**1.** Cut tube square using a tube cutter or fine tooth saw.

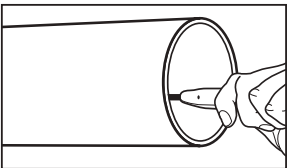

**2.** Deburr tube ID using a deburring tool.

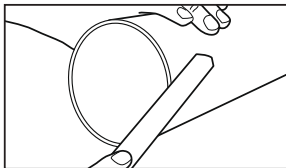

**3.** Deburr tube OD using half round file.

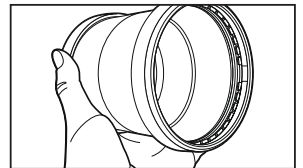

**4.** Check fitting ends to ensure seal, grip ring and nylon spacer are present. Do not use any type of oil lubrication.

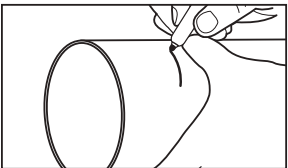

**5.** Mark tube to proper fitting insertion depth (see Insertion Depth Chart below).

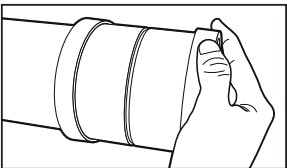

**6.** Turn slightly while sliding press fitting onto tube. Slide all the way to insertion mark and make contact with stop.

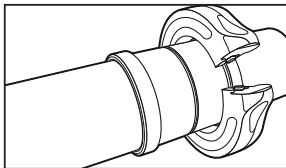

**7.** Place press-ring at a right angle over fitting bead and check for proper engagement. Re-check insertion depth.

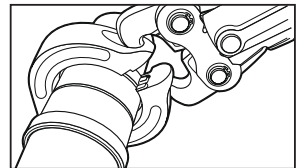

**8.** Start the pressing process. Please see specific tool manufacturer for tool instruction.

Tube Size	2-1/2"	3"	4"
Insertion Depth	1-3/4"	1-7/8"	2-1/8"



Large diameter (2-1/2" – 4") Streamline PRS™ fittings must be connected with approved press tool and press-rings. Please see specific tool manufacturer for tool instruction.

### ⚠ WARNING

Failure to follow all instructions could affect joint/system integrity and may lead to property damage. Call Customer Service at 1-800-FITTING if you have any questions or need assistance.

**Streamline PRS™ Recommended Pressure Testing:** Unpressed connections are located by pressurizing the system with air or water. When testing with water the proper pressure range is 15 PSI TO 50 PSI maximum. Leak testing with air can be dangerous at high pressures. When testing with compressed air the proper pressure is up to 15 PSI maximum. Following a successful leak test, the system may be pressure tested up to 200 PSI if required by local code requirements or project specifications.

## SURE PRS™ SEAL TECHNOLOGY



O-RING INSIDE FITTING

- Available in 1/2" - 2" fitting designs.
- Proprietary EPDM O-ring seal with circumferential leak path.
- When connected but not pressed, the fitting will leak at multiple points of the fitting hub, identifying un-pressed fittings.
- Special system testing procedures are required for fittings with leak detection. (See page 20 for instructions)

## DUOBITE™ GRIP RING



GRIP RING DETAIL

- Available in 2-1/2" - 4" fitting designs.\*
- Dual rows of matching stainless steel teeth provide maximum joint strength.
- Stainless steel teeth "bite" into the tube when the joint is pressed.

*\*2-1/2" - 4" connections are inherently "leak detecting". Before pressing, fittings are loose on the tube, allowing for water/air flow and easy identification of un-pressed connections.*

## TESTING INSTRUCTIONS FOR FITTINGS WITH LEAK DETECTION

### Pressure Testing

When installing Streamline PRS™ fittings it is recommended to perform a leak test in order to locate any un-pressed fittings. To assist in making that testing more reliable, Streamline PRS™ fittings come with a leak detection feature. The following procedures allow installers to detect un-pressed fittings in a system under pressure prior to concealment.

### Leak Testing with Air

1. When the system, or portion of the system, is installed and isolated, pressurize to 15 PSI maximum using dry clean air, carbon dioxide or nitrogen charge
2. The system should stabilize over the next several hours (2 - 3 recommended) and the pressure should be monitored with a pressure gauge.
3. If the pressure has dropped, add more pressure to bring the system back up to the 15 PSI desired initial test level. Bleed off excess pressure.
4. Allow another 2-3 hours for complete system stabilization. If upon inspection the system pressure has dropped below 15 PSI test level, there is likely an un-pressed fitting leaking.
5. Leaks are easily identified either by use of commercial leak test solution or soap and water mixture, which will form bubbles identifying an un-pressed leak point.
6. Once any un-pressed connection has been tested and repaired, repeat the testing process until 15 PSI pressure is maintained for 24 hours or for the duration of time and pressure specified by local authority codes.

### Leak Testing with Water

1. When the system, or portion of the system, is installed and isolated, pressurize to 50 PSI maximum using clean potable water.
2. The system should stabilize over the next several hours (2 - 3 recommended) and the pressure should be monitored with a pressure gauge.
3. If the pressure has dropped, add more pressure to bring the system back up to the 50 PSI desired initial test level. Bleed off excess pressure.
4. Allow another 2-3 hours for complete system stabilization. If upon inspection the system pressure has dropped below 50 PSI test level, there is likely an un-pressed fitting leaking.
5. Leaks are easily identified by leaking water.
6. Once any un-pressed connection has been tested and repaired, repeat the testing process until 50 PSI pressure is maintained for 24 hours or for the duration of time and pressure specified by local authority codes.

Once either testing procedure has been completed and verified, water/air pressure can be increased to the working pressure design of the system, not to exceed the maximum rated pressure.





## TUBE SELECTION

Streamline PRS™ fittings are designed to be joined with ASTM B88 (Types K, L, M) hard-drawn copper tube (1/2" - 4") and soft copper tube (1/2" - 1-1/4").

Copper tubing made to ASTM B88 may contain surface imperfections, which are specifically defined and allowed by the standard. This product is handled and stored multiple times before reaching the actual point of installation, potentially leading to further scratches, nicks or dents. ASTM B88 copper tube was designed for joining with solder and braze alloys – both of which are excellent gap-fill materials.

Those who specify and/or install press systems must be aware of the inherent trade-offs that accompany the decision to utilize press technology and o-ring seals. Installers should recognize surface scratches and deep incise marks (identification stamping) on the tube and avoid placing o-ring seals directly over these surface irregularities in order to reduce the risk of leaks. Sanding and cleaning the surface may or may not eliminate this concern.

## STORAGE AND HANDLING

Streamline PRS™ fittings are packaged in polybags to keep them clean and free from debris. While unlikely to be needed, the polybag also serves to keep fittings and o-ring seals together in the event that one were to be dislodged in transit. Prior to installation, it is highly recommended that a thorough visual inspection of the fittings be performed. Fittings should be handled with care and opened just prior to use, to ensure their cleanliness.

The tubing and fittings should be carefully handled during shipment and unloaded with reasonable care. Protect the stored product from moisture and dirt. Elevation above grade and away from concrete is desirable.

In the event press fittings are dropped, exercise the utmost care in visually inspecting them to assure that fittings have not been damaged or deformed.

## TOOLS & JAWS

Installer shall be qualified and licensed within the jurisdiction, and familiar with the installation of copper press joint systems.

Streamline PRS™ copper press fittings shall be installed using the proper tool, jaws, actuator, and rings as instructed by the respective press fitting and press tool manufacturer.

## DISTANCE BETWEEN JOINTS

Mechanical joint pressing causes some degree of deformity to the tubing. To prevent leaks, minimal distances between press joints are set forth in the table below.

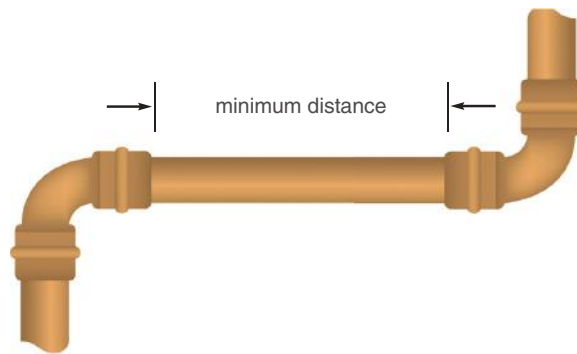

MINIMUM DISTANCE BETWEEN STREAMLINE PRS™ JOINTS		
TUBE DIAMETER	MINIMUM DISTANCE REQUIRED	
NOMINAL INCH	INCH	MM
1/2"	—	—
3/4"	—	—
1"	—	—
1-1/4"	7/16"	10
1-1/2"	5/8"	15
2"	3/4"	20
2-1/2"	5/8"	15
3"	5/8"	15
4"	5/8"	15

## PRESSING SPACE LIMITATIONS

Press tool and jaw sets can be difficult to get into some tighter spaces. In these instances it is recommended that, when possible, to preassemble product away from these space restricted areas. These assemblies can then be installed to minimize the potential for improper alignment of the pressing tools and jaws. For most press joints, use of the press tools and jaws will not pose spatial issues. The following guidelines are recommended for standard installations.

### 1/2" - 2" PRESSING WITH STANDARD JAWS - CLEARANCE REQUIREMENTS

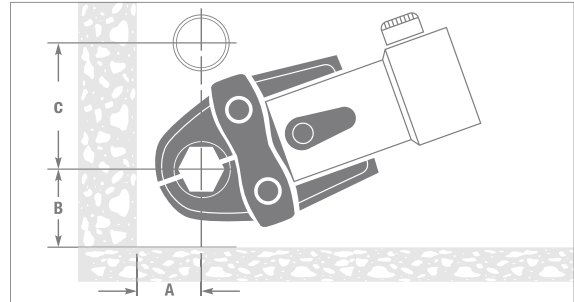
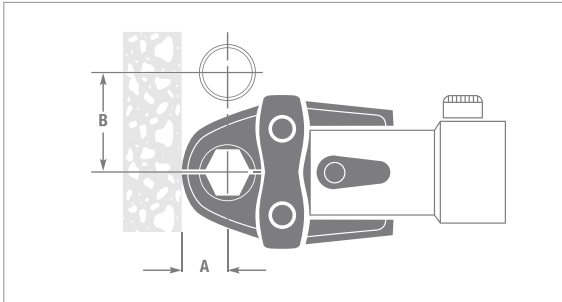

TUBE DIAMETER	A minimum		B minimum	
	INCH	MM	INCH	MM
1/2	3/4	19	1-5/8	41
3/4	7/8	22	2-1/8	54
1	1	26	2-1/2	64
1-1/4	1-1/8	29	2-7/8	73
1-1/2	1-3/4	45	3-1/2	89
2	2	51	4-3/8	111

TUBE DIAMETER	A minimum		B minimum		C minimum	
	INCH	MM	INCH	MM	INCH	MM
1/2	7/8	23	1-3/8	35	2-1/2	64
3/4	1	26	1-1/2	38	2-1/2	64
1	1-1/8	29	1-3/4	45	3	76
1-1/4	1-1/4	32	2-1/4	57	3-1/8	80
1-1/2	1-7/8	48	1-1/2	64	3-3/4	95
2	2-1/8	54	3-1/8	80	5	127

### 1/2" - 1-1/4" PRESSING WITH COMPACT JAWS - CLEARANCE REQUIREMENTS

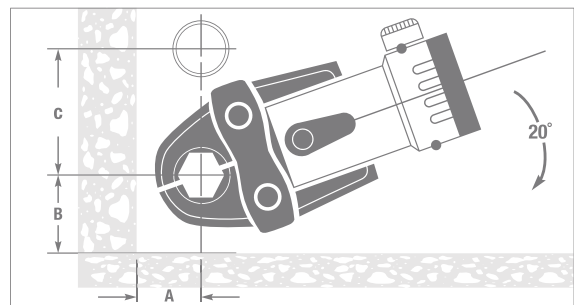
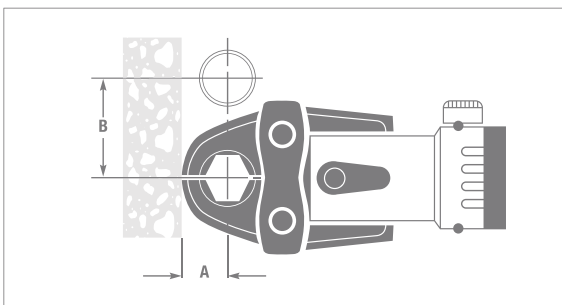

TUBE DIAMETER	A minimum		B minimum	
	INCH	MM	INCH	MM
1/2	3/4	19	2	51
3/4	7/8	22	2-3/8	60
1	7/8	26	2-5/8	67
1-1/4	1-1/8	28	3-1/8	85

TUBE DIAMETER	A minimum		B minimum		C minimum	
	INCH	MM	INCH	MM	INCH	MM
1/2	7/8	23	1-3/8	35	2-1/2	64
3/4	1	26	1-1/2	38	2-3/4	70
1	1-1/8	29	1-5/8	41	3	76
1-1/4	1-5/8	39	2-1/8	53	3-3/8	85

### 2-1/2" - 4" PRESSING WITH PRESS RINGS - CLEARANCE REQUIREMENTS

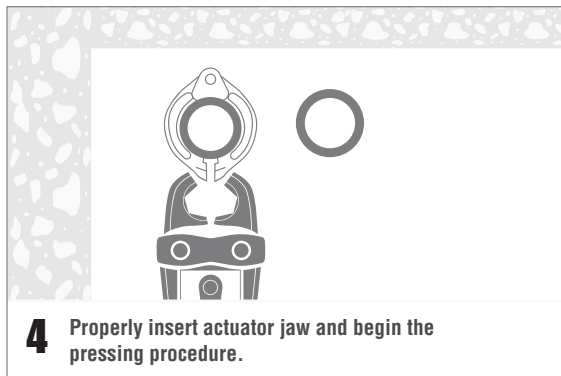
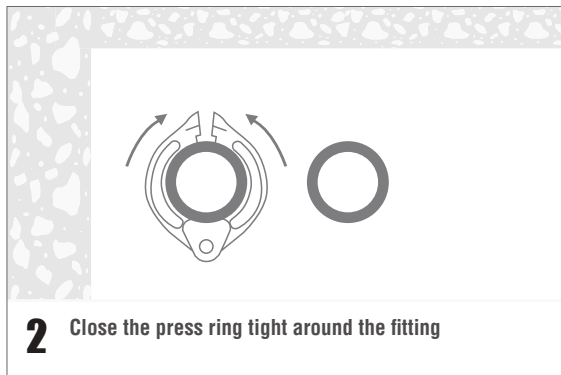

### PROCEDURE FOR LAYING THE COPPER PRESS RING AROUND THE STREAMLINE PRS™ FITTING WITH MINIMUM SPACE REQUIREMENTS

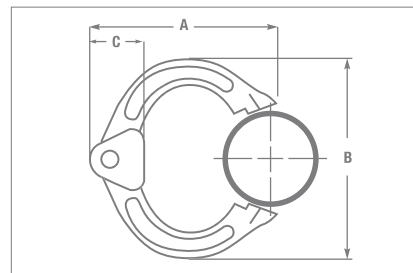
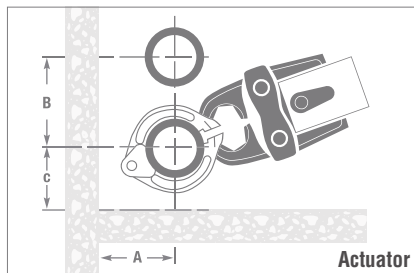
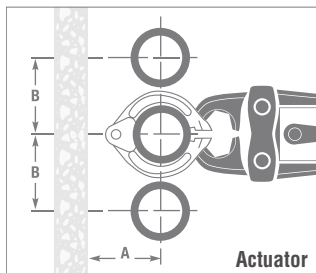

TUBE DIAMETER	A INCH (MM)	B INCH (MM)
2-1/2	4-1/8 (105)	6 (152)
3	4-3/8 (111)	7 (178)
4	5 (127)	8 (203)

TUBE DIAMETER	A INCH (MM)	B INCH (MM)	C INCH (MM)
2-1/2	4-1/8 (105)	6 (152)	4-1/2 (114)
3	4-3/8 (111)	7 (178)	4-7/8 (124)
4	5 (127)	8 (203)	5-3/4 (146)

TUBE DIAMETER	A INCH (MM)	B INCH (MM)	C INCH (MM)
2-1/2	6-3/16 (157)	6-15/16 (176)	2-7/16 (62)
3	7-7/16 (189)	8-13/16 (224)	2-7/16 (62)
4	8-1/16 (205)	10-7/16 (265)	2-7/16 (62)



## SOLDER OR BRAZING NEAR AN EXISTING PRESS CONNECTION

To ensure proper sealing of the soldered/brazed joint and the press connection, a minimum distance between the two connections must be maintained.

When soldering near a Streamline PRS™ connection, the installer must remain at least three tube diameters away from the connection to prevent damage to the sealing element of the press fitting. When brazing, the installer must remain at least nine tube diameters away from the connection. The installer should take precautions to keep the press connection cool. These methods may include 1) wrapping the press connection with a cold wet cloth, 2) fabricating solder connections prior to installing the press fitting, or 3) applying spray-type cooling gels.

TUBE DIAMETER NOMINAL INCH	SOLDERING		BRAZING	
	MINIMUM DISTANCE		MINIMUM DISTANCE	
	INCH	MM	INCH	MM
1/2"	1-1/2"	38	4-1/2"	114
3/4"	2-1/4"	57	6-3/4"	172
1"	3"	76	9	229
1-1/4"	3-3/4"	95	11-1/4"	286
1-1/2"	4-1/2"	114	13-1/2"	343
2"	6"	153	18	457
2-1/2"	7-1/2"	191	22-1/2"	572
3"	9"	229	27	686
4"	12"	305	36	915

## PRESSING NEAR AN EXISTING SOLDERED OR BRAZED CONNECTION

The minimum distance required when pressing connections near an existing brazed joint is two pipe diameters. To ensure proper sealing of both the soldered and press connections, minimum spacing between connections must be maintained. Always make sure there is no residual solder or other debris on the tubing to be inserted into the Streamline PRS™ fitting.

TUBE DIAMETER NOMINAL INCH	MINIMUM DISTANCE	
	INCH	MM
1/2"	1/4"	7
3/4"	1/4"	7
1"	7/16"	11
1-1/4"	7/16"	11
1-1/2"	5/8"	16
2"	3/4"	19
2-1/2"	1/4"	7
3"	1/4"	7
4"	1/4"	7

# RELIABLE

## FREQUENTLY ASKED QUESTIONS:

Streamline PRS™ Fittings for Use in Copper Tube Systems

**1. What is the Streamline PRS™ system rated for regarding pressure and temperature?**

200 PSI over a temperature range of -20° F to 250° F.

**2. For what types of applications is the Streamline PRS™ system approved?**

Residential and commercial plumbing and mechanical systems.

**3. For what types of media is the Streamline PRS™ system designed?**

Hot and cold domestic water, potable drinking and cooking water, condenser and chilled water, and water glycol mixtures of ethylene or propylene glycol up to 50% at 200° F.

**4. What products are included in the Streamline PRS™ system offering?**

Copper fittings in sizes 1/2" to 4" including couplings, elbows, tees, caps, adapters, fitting reducers, unions and flanges.

**5. What tubing can be used with Streamline PRS™ fittings?**

K, L, and M hard drawn copper water tube (1/2" to 4") and soft (annealed) copper tube (1/2" to 1-1/4")

**6. What is the warranty for Streamline PRS™ fittings?**

50-year limited warranty.

**7. How long will the EPDM seal last in Streamline PRS™ fittings?**

The EPDM seal carries the same warranty as the fitting in which it is installed — 50 years.

**8. What performance tests were performed on the Streamline PRS™ fittings?**

Certification to IAPMO PS-117 and ASME B16.51 requires the following tests: hydrostatic burst strength, unrestrained hydrostatic pressure, dynamic torque, static torque, bending, vacuum pressure, cyclic pressure, vibration and thermocycling.

**9. What pressing tools can be used with the Streamline PRS™ system fittings?**

Most pressing tools on the market can be used, but always refer to the Tool & Jaw Compatibility Chart.

**10. Can a Streamline PRS™ fitting connection be re-crimped?**

Yes. However, for 1/2" to 2" joints, the pressing jaws must be positioned on the same hex flats as the original crimp.

**11. Is the Streamline PRS™ system approved for use underground?**

Yes, in accordance with local plumbing codes.

**12. Are Streamline PRS™ fittings lead free?**

Yes. They have been tested and are certified to NSF/ANSI-61 and NSF/ANSI-372.

**13. Are Streamline PRS™ system seals lubricated?**

The seals are lubricated as part of the manufacturing process when they are inserted into the press fittings.

**14. Can Streamline PRS™ fittings be installed in a system subject to freezing?**

Care should always be taken when installing any system in severe freezing conditions. Systems exposed to freezing conditions should be protected per local plumbing codes.

**15. Can a Streamline PRS™ fitting be installed in tight spaces?**

Yes, as long as there is sufficient clearance around each joint to allow for the pressing tool and jaw to crimp without interference.

**16. What does EPDM stand for?**

Ethylene-Propylene Diene Monomer

**17. How far away from a Streamline PRS™ connection can another fitting be soldered or brazed?**

Soldering should not occur less than three pipe diameters from an installed press fitting. Brazing should not occur less than nine pipe diameters from an installed press fitting. The installer should protect the press connection by use of a wet rag or cooling gel.

**18. How far away from a soldered or brazed connection can a Streamline PRS™ be installed?**

A Streamline PRS™ fitting can be installed two pipe diameters from an existing soldered or brazed connection. The installer should take precaution to ensure there is no residual solder or braze material on the sealing surface and that the tube is not hot.

**19. How close together can two Streamline PRS™ connections be pressed?**

See Minimum Distance Between Streamline PRS™ Joints for distance between press fittings.

**20. What are the most common errors made when installing a Streamline PRS™ system?**

Not adequately deburring the end of the tubing, and not inserting the tube far enough into the press fitting.

**21. Can Streamline PRS™ fittings be installed in a refrigeration system?**

No. The EPDM seals are not compatible with refrigerants, and the pressure rating of the system is not sufficient for many refrigerant gases.







Distributed by Mueller Streamline Co. • 8285 Tournament Drive, Memphis, TN 38125  
800-846-9750 • [www.muellerindustries.com](http://www.muellerindustries.com)