

SYSTEM6™

**HIGH CAPACITY
HOT WATER
BASEBOARD**

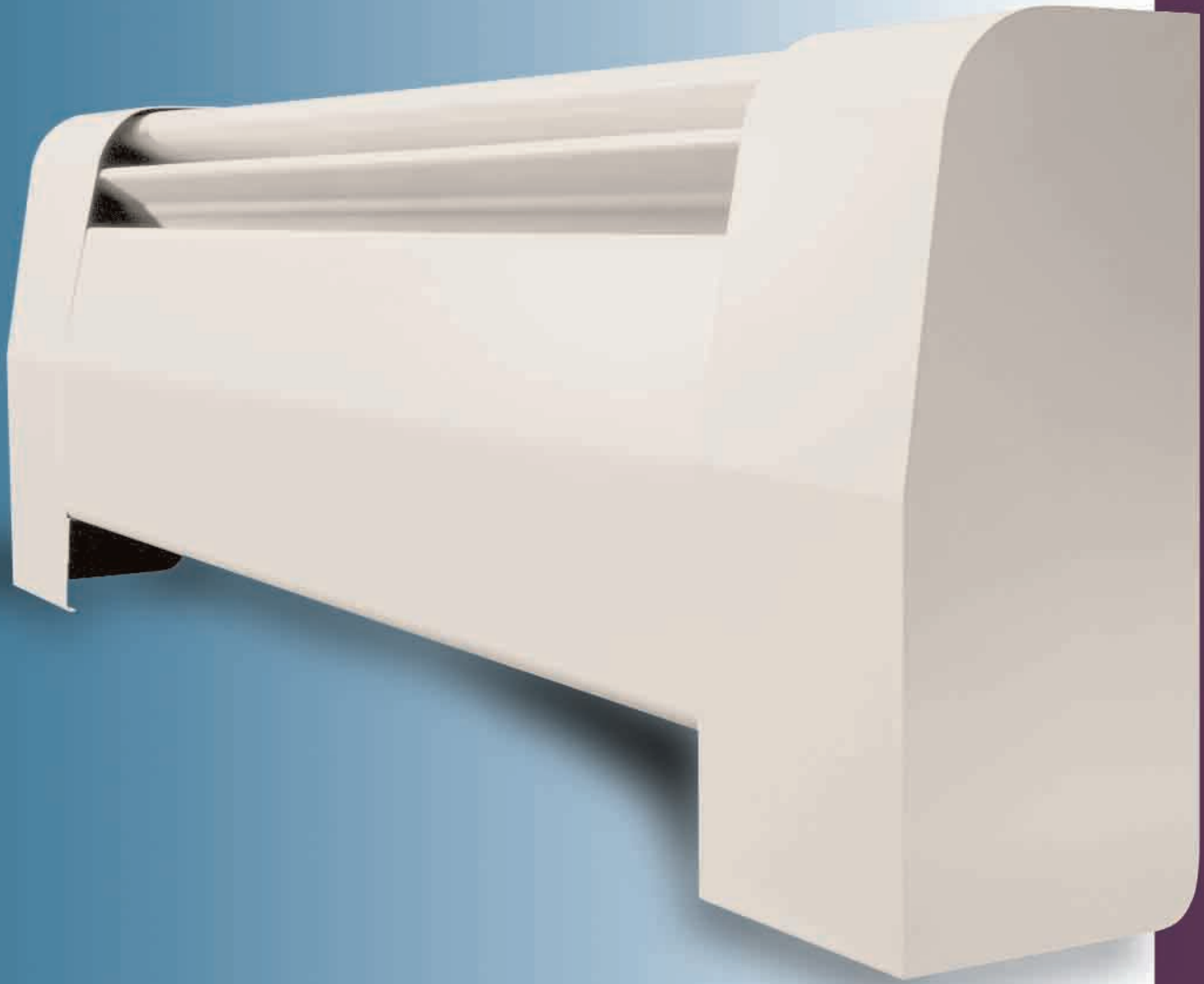

SYSTEM6™

SIX INTERCHANGEABLE HEATING ELEMENTS IN ONE LOW PROFILE ENCLOSURE FOR ANY RESIDENTIAL OR LIGHT COMMERCIAL JOB.

THE ULTIMATE IN FLEXIBILITY AND DESIGN

System 6 is a heavy-duty baseboard heating product that provides specifying engineers and contractors a choice of six interchangeable high output heating elements in one low profile enclosure. This allows for more design flexibility than any competitor's baseboard system. System 6's low profile makes it ideal where space is at a premium, while the extra-high heat outputs of all six elements meet nearly every heating requirement.

System 6 is one of the most rugged baseboards available for any residential or light commercial installation. Its 18 gauge steel front panel and heavy-duty support brackets make System 6 ideal for heavy traffic areas such as offices, apartments and building corridors as well as any home. Plus System 6 comes in a white baked enamel finish that blends with any decor. System 6 features a fully modulating damper for individual room control and its "easy glide" expansion cradles assure noise free operation. For high-capacity baseboard heating at a competitive price, specify System 6.

SNAP-ON DAMPERS

Finger-touch snap-on damper opens and closes with ease, without the use of hinges which can bind or loosen with age.

HEAVY-DUTY FRONT PANEL

With a rugged 18-gauge steel front panel, there's none heavier in the industry. This sturdy front panel resists dents and always looks new, year after year.

EASY INSTALLATION

All copper/aluminum heating elements have an expanded end for easy sweat connections without couplings. The 1 1/4" IPS steel element is threaded at both ends.

RUGGED SUPPORT BRACKETS

System 6 is constructed with strong, heavy gauge support brackets which will stand up to years of wear and tear without bending or tattering in any way.

TUBE SUPPORT SYSTEM

System 6's unique tube support design allows for fast and easy installation of a return line.

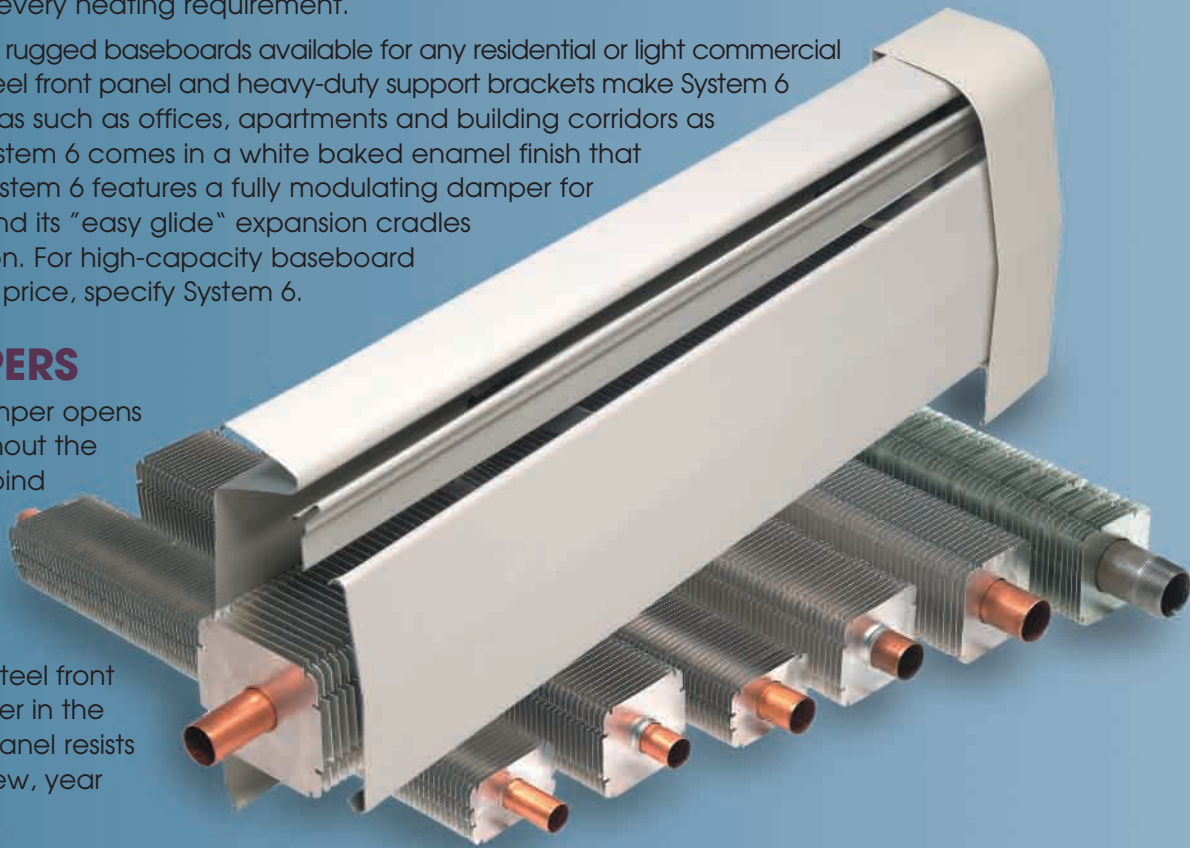

SIX INTERCHANGEABLE ELEMENTS

With a choice of six interchangeable elements, each with a different output and capacity, System 6 is ideal for virtually any type of installation.

Copper/Aluminum Elements:

- SCE-632 (3/4" with 2" x 3 1/4" fins)
- SCE-633 (3/4" with 3" x 3 1/4" fins)
- SCE-642 (1" with 2" x 3 1/4" fins)
- SCE-643 (1" with 3" x 3 1/4" fins)
- SCE-653 (1 1/4" with 3" x 3 1/4" fins)

IPS Steel Elements:

- SCE-655 (1 1/4" with 3" x 3 1/4" fins)

EXPANSION CRADLES

Easy glide polypropylene expansion cradles are attached to the fins on all six elements over the support brackets, which eliminate noisy metal to metal contact between the brackets and the enclosure. This guarantees smooth, quiet operation for years to come.

ACCESSORIES

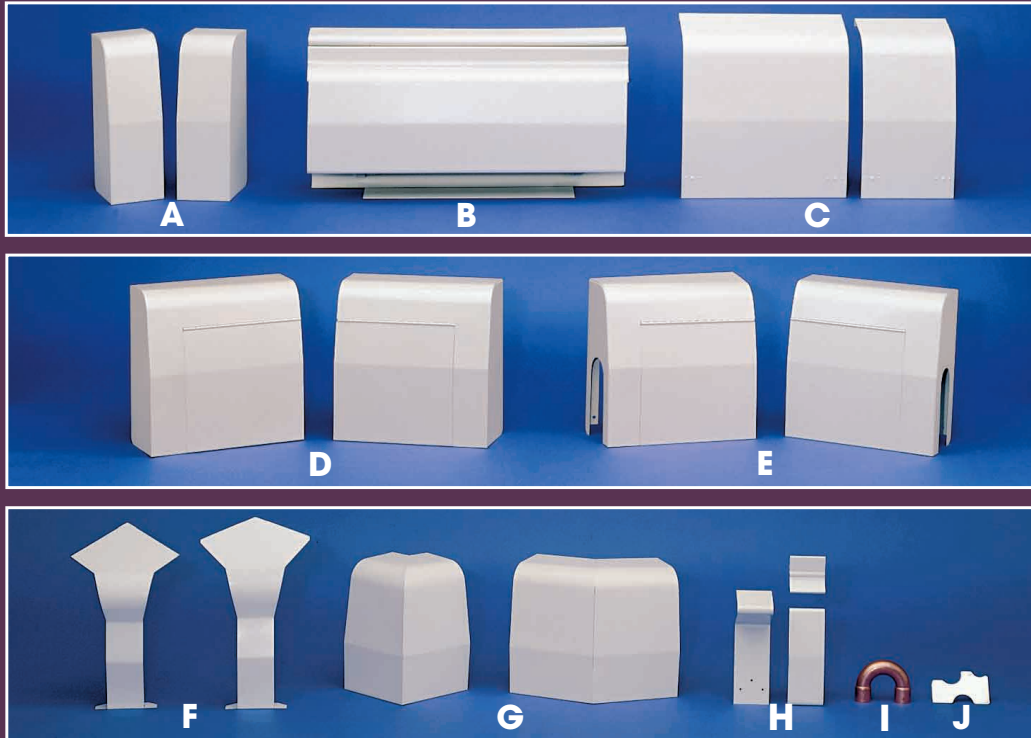

- A** END CAPS - 3" wide left (SCC-L) and right (SCC-R), for use at doorways and wherever a finished end is needed. 3" wide slotted left (SCCS-L) and right (SCCS-R), for through-the-wall connections. Fully telescopic.
- B** EXTENSION SETS - 14" wide (SEX-14). Four sections (back, front, top and damper). Telescopes to fill gaps up to 12½" between baseboard panels.
- C** WALL JOINERS - 5" (SWJ-5) and 9" (SWJ-9). Fully telescopic to conceal connecting pipes.
- D** VALVE ENCLOSURE - 9" wide left (SVE-L) and right (SVE-R). Extra wide 6" hinged door for easy access to valve or vent. Fully telescopic.
- E** VALVE ENCLOSURE (SLOTTED) - 9" wide left (SVES-L) and right (SVES-R). Extra wide 6" hinged door for easy access to valve or vent. Fully telescopic.
- F** INSIDE CORNER - 90° (SIC-90) and 135°/45° (SIC-135). One piece snap-on for easy installation. Telescopic up to 2½" on each wall.
- G** OUTSIDE CORNER - 90° (SOC-90) and 135°/45° (SOC-135). Use to trim corners at projecting wall. Telescopic up to 1" on each wall.
- H** SPLICER SET - 2" wide (SSP). Three piece snap-on top, front and damper joiner. Joins adjacent baseboard panels. Supplied free of charge in 5 ft. to 8 ft. lengths.
- I** COPPER RETURN BEND (SRB) - Custom designed 180° copper-to-copper return bend installs easily into enclosure, offering supply and return connection from one end of the baseboard. Return bend fits elements SCE-632 and SCE-633.
- J** TUBE SUPPORTS (STS) - Provides support for return tube.

SPECIFICATIONS

APPROVED RATINGS

for EMBASSY SYSTEM-6 BTU/hr. linear foot 65° Entering Air

HEATING ELEMENTS HOT WATER RATINGS IN SEN-6 ENCLOSURE

Model	Tube/Fin	Flow Rate	Average Water Temperature							
			170°	180°	190°	200°	210°	220°	230°	240°
SCE-632	Copper/Al	4 GPM (2000 lbs./Hr.)	710	800	890	970	1070	1150	1250	1330
SCE-632	Copper/Al	1 GPM (500 lbs./Hr.)	670	760	840	920	1010	1090	1180	1260
SCE-633	Copper/Al	4 GPM (2000 lbs./Hr.)	770	870	970	1070	1160	1270	1360	1460
SCE-633	Copper/Al	1 GPM (500 lbs./Hr.)	730	820	920	1010	1100	1200	1290	1380
SCE-642	Copper/Al	4 GPM (2000 lbs./Hr.)	680	760	850	930	1030	1110	1190	1280
SCE-642	Copper/Al	1 GPM (500 lbs./Hr.)	640	720	800	880	970	1050	1130	1210
SCE-643	Copper/Al	4 GPM (2000 lbs./Hr.)	740	840	930	1040	1130	1230	1320	1420
SCE-643	Copper/Al	1 GPM (500 lbs./Hr.)	700	790	880	980	1070	1160	1250	1340
SCE-653	Copper/Al	4 GPM (2000 lbs./Hr.)	710	800	900	990	1090	1180	1290	1380
SCE-653	Copper/Al	1 GPM (500 lbs./Hr.)	670	760	850	940	1030	1120	1220	1310

NOTE: All the above I=B=R Ratings are based on active length, which is 4" less than total length, and includes a 15% addition for heating effect.

The use of I=B=R Ratings at 2000 lb/hr is limited to installations where the water flow rate through the baseboard unit is equal to or greater than 2000 lb/hr. Where the flow rate through the baseboard is not known; the rating at 500 lb/hr. must be used.

LABORATORY RATINGS

for EMBASSY SYSTEM-6 BTU/hr. linear foot 65° Entering Air

SCE-655	IPS Steel	4 GPM (2000 lbs./Hr.)	610	690	770	850	930	1010	1090	1170
SCE-655	IPS Steel	1 GPM (500 lbs./Hr.)	580	650	730	800	880	960	1030	1110

Model SCE-632

3/4" Nominal Copper Tubing with 2"x3 3/4"x.010" thick aluminum fins (natural finish) x 58 fins per ft. Pressure Drop (in ft. of head per 100 ft. - ft./100 ft.) @ 1 GPM = 0.32 ft./100 ft. and @ 4 GPM = 4.16 ft./100 ft. Bursting Pressure 1412 psi.; Operating Pressure 283 psi.

Model SCE-633

3/4" Nominal Copper Tubing with 3"x3 3/4"x.020" thick aluminum fins (natural finish) x 51 fins per ft. Pressure Drop (in ft. of head per 100 ft. - ft./100 ft.) @ 1 GPM = 0.32 ft./100 ft. and @ 4 GPM = 4.16 ft./100 ft. Bursting Pressure 1412 psi.; Operating Pressure 283 psi.

Model SCE-642

1" Nominal Copper Tubing with 2"x3 3/4"x.010" thick aluminum fins (natural finish) x 58 fins per ft. Pressure Drop (in ft. of head per 100 ft. - ft./100 ft.) @ 1 GPM = 0.09 ft./100 ft. and @ 4 GPM = 1.13 ft./100 ft. Bursting Pressure 1082 psi.; Operating Pressure 216 psi.

Model SCE-643

1" Nominal Copper Tubing with 3"x3 3/4"x.020" thick aluminum fins (natural finish) x 51 fins per ft. Pressure Drop (in ft. of head per 100 ft. - ft./100 ft.) @ 1 GPM = 0.09 ft./100 ft. and @ 4 GPM = 1.13 ft./100 ft. Bursting Pressure 1082 psi.; Operating Pressure 216 psi.

Model SCE-653

1 1/4" Nominal Copper Tubing with 3"x3 3/4"x.020" thick aluminum fins (natural finish) x 51.5 fins per ft. Pressure Drop (in ft. of head per 100 ft. - ft./100 ft.) @ 1 GPM = 0.03 ft./100 ft. and @ 4 GPM = 0.41 ft./100 ft. Bursting Pressure 1556 psi.; Operating Pressure 311 psi.

Model SCE-655

1 1/4" IPS Steel Pipe with 3"x3 3/4"x.026" thick steel fins (painted finish) x 48 fins per ft. Pressure Drop @ 4 GPM = 0.35 ft./100 ft. Both ends threaded. Bursting Pressure 7590 psi.; Operating Pressure 1000 psi.

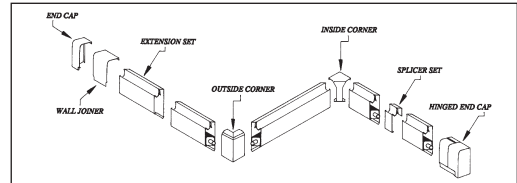
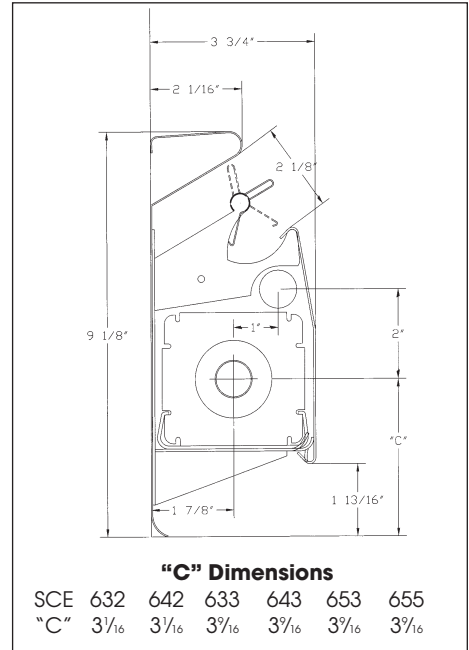

LIMITED WARRANTY - Embassy Industries, Inc. warrants all System 6 baseboard to be free of defects in material and workmanship for a period of one (1) year from date of shipment. Embassy reserves the right to change designs or materials without prior notice as it may deem necessary. Liability under this written warranty and under implied warranties is limited to the repair or replacement, without charge, at Embassy's option of any defective baseboard or part thereof for the original user only, and only if the defective baseboard or part is returned to Embassy Industries, Inc. at the address indicated on the opposite side of this page. Attn., Consumer Service Department, freight prepaid, within such one (1) year period. This warranty is void if the baseboard has been improperly installed or repaired or damaged through misuse. THE FOREGOING WARRANTY IS IN LIEU OF ALL OTHER EXPRESS WARRANTIES. ALL IMPLIED WARRANTIES, INCLUDING DESCRIPTION, MERCHANTABILITY AND FITNESS FOR PURPOSE, ARE LIMITED TO THE TERM OF THIS WRITTEN WARRANTY. IN NO EVENT SHALL EMBASSY BE LIABLE FOR INCIDENTAL OR CONSEQUENTIAL DAMAGES. This warranty gives you specific legal rights, and may vary from state to state.



A subsidiary of P&F Industries

300 SMITH STREET

FARMINGDALE, NEW YORK 11735

(631) 694-1800 • FAX (631) 694-1832

<http://www.embassyind.com>

DISTRIBUTED BY: