



Manufactured by

LYMPIA

CHIMNEY SUPPLY Inc.

"Your Partner in the Business"

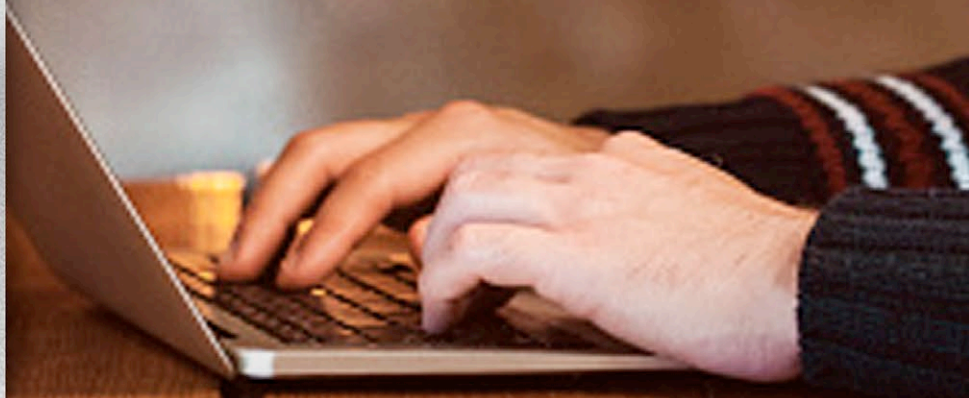

CHIMNEY AND VENTING
CATALOG



At Olympia Chimney Supply, we are committed to advocating and promoting the safe venting of home heating appliances. The Olympia commitment to a quality product starts with innovative design and engineering. We continue this commitment by working with the world-class testing and listing agency, Underwriters Laboratories (UL), ensuring our products meet or exceed safety and quality standards. We're so proud of our products that our Forever Warranty is the best in the business. Olympia Chimney Supply, making America's homes safer with high-quality chimney and venting solutions since 1999.









Manufactured by

LYMPIA

CHIMNEY SUPPLY Inc.

"Your Partner in the Business"

POWDER COATING is NOW available on VENTIS® CLASS-A, VENTIS® DIRECT VENT, VENTIS® AIR-COOLED and all caps, chase covers. This process will not only add durability to the finish of the product, but with eight stylish colors to choose from, we can also compliment any home aesthetic. See page 46 for more information.

	VENTIS® CLASS-A	3-16
	VENTIS® AIR-COOLED	17-20
	VENTIS® DIRECT VENT	21-28
	VENTIS® PELLET VENT	29-36
	BLACK STOVE PIPE	37-44
	VENTIS® DIRECT VENT PELLET	45
	POWDER COATING	46



VENTIS

CLASS-A ALL-FUEL CHIMNEY SYSTEM

Ventis® Class-A is an All-Fuel Chimney System manufactured with a stainless steel inner pipe in addition to a stainless steel outer wall pipe. Most manufactures make their Class-A pipe with a galvanized outer wall that can rust. This is the only Class-A system that has a Forever Warranty™. No fine print, just peace of mind.

A CLASS OF ITS OWN

5" to 8" Listed to UL103HT & ULC S629. 10" and 12" Listed to UL103.

Available with 304L or 316L Inner Wall Pipe

All Stainless Steel Inner and Outer Casing

Attractive Mirror Finish 430 Stainless Steel Outer Casing
(316L Outer Casing Also Available)

Exclusive Forever Warranty™ Transferable to the Next Home Owner

Made in the USA - in Scranton, Pennsylvania



POWDER COATING AVAILABLE



INNER WALL PIPE: 304L Inner /430 Outer

304L

LENGTHS	5" DIAMETER	6" DIAMETER	7" DIAMETER	8" DIAMETER	10" DIAMETER	12" DIAMETER
6"	VA304-0506	VA304-0606	VA304-0706	VA304-0806	VA304-1006	VA304-1206
12"	VA304-0512	VA304-0612	VA304-0712	VA304-0812	VA304-1012	VA304-1212
18"	VA304-0518	VA304-0618	VA304-0718	VA304-0818	VA304-1018	VA304-1218
24"	VA304-0524	VA304-0624	VA304-0724	VA304-0824	VA304-1024	VA304-1224
36"	VA304-0536	VA304-0636	VA304-0736	VA304-0836	VA304-1036	VA304-1236
48"	VA304-0548	VA304-0648	VA304-0748	VA304-0848	VA304-1048	VA304-1248



304L Stainless Steel Inner Wall, .016" thickness 5" - 8" .016" thickness 10 - 12"
 430 Stainless Steel Outer Wall, .016" thickness 5" - 8" .024" thickness 10 - 12"
 Standard solid-fuel applications

TELESCOPING LENGTH: 304L

14"-22"	VA304-TEL05	VA304-TEL06	VA304-TEL07	VA304-TEL08	VA304-TEL10	VA304-TEL12
---------	-------------	-------------	-------------	-------------	-------------	-------------

This part enables the installer to have the perfect length of chimney when and wherever needed. It is an adjustable length that extends from 14" to 22", and its smooth weld technology allows the two sections of the pipe to slide together effortlessly! Olympia uses innovative means to make sure that the insulation process has not been affected. This adjustable pipe provides for a user-friendly and professional installation.

INNER WALL PIPE: 316L Inner /430 Outer

316L

LENGTHS	5" DIAMETER	6" DIAMETER	7" DIAMETER	8" DIAMETER	10" DIAMETER	12" DIAMETER
6"	VA316-0506	VA316-0606	VA316-0706	VA316-0806	VA316-1006	VA316-1206
12"	VA316-0512	VA316-0612	VA316-0712	VA316-0812	VA316-1012	VA316-1212
18"	VA316-0518	VA316-0618	VA316-0718	VA316-0818	VA316-1018	VA316-1018
24"	VA316-0524	VA316-0624	VA316-0724	VA316-0824	VA316-1024	VA316-1224
36"	VA316-0536	VA316-0636	VA316-0736	VA316-0836	VA316-1036	VA316-1236
48"	VA316-0548	VA316-0648	VA316-0748	VA316-0848	VA316-1048	VA316-1248



ALWAYS IN STOCK
 316L Stainless Steel Inner Wall, .016" thickness
 Provides the best coal warranty in the industry! Great for oil fired appliances and still maintains the Forever Warranty
 Standard all-fuel applications
 316L Inner and Outer Available (Add 10%)

TELESCOPING LENGTH: 316L

14"-22"	VA316-TEL05	VA316-TEL06	VA316-TEL07	VA316-TEL08	VA316-TEL10	VA316-TEL12
---------	-------------	-------------	-------------	-------------	-------------	-------------

This part enables the installer to have the perfect length of chimney when and wherever needed. It is an adjustable length that extends from 14" to 22", and its smooth weld technology allows the two sections of the pipe to slide together effortlessly! Olympia uses innovative means to make sure that the insulation process has not been affected. This adjustable pipe provides for a user-friendly and professional installation.

ELBOWS: Kit includes 2 Elbows, 1 Elbow Support

304L
316L

DEGREE	5" DIAMETER	6" DIAMETER	7" DIAMETER	8" DIAMETER	10" DIAMETER	12" DIAMETER
15°	VA-EL0515	VA-EL0615	VA-EL0715	VA-EL0815	VA-EL1015	VA-EL1215
30°	VA-EL0530	VA-EL0630	VA-EL0730	VA-EL0830	VA-EL1030	VA-EL1230
15°	VA316-EL0515	VA316-EL0615	VA316-EL0715	VA316-EL0815	VA316-EL01015	VA316-EL01215
30°	VA316-EL0530	VA316-EL0630	VA316-EL0730	VA316-EL0830	VA316-EL01030	VA316-EL01230



Available in 15 or 30 degree. Used to offset obstructions such as framing joists.

No more than (4) elbows can be used on an installation

ELBOW SUPPORT (Offset Support) Stainless steel band with galvanized fastening straps

5" - 8" DIAMETER	10" - 12" DIAMETER
VA-ELS58	VA-ELS1012



Required between two elbows to support the chimney weight created by the offset and/or can be used when the chimney exceeds the weight limit of the primary support. The two straps of the support are 36" in length and it fits pipe diameters of 5", 6", 7", 8", 10" and 12".

INSULATED TEES: Cover also fits on tee take-off

304L
316L

DESCRIPTION	5" DIAMETER	6" DIAMETER	7" DIAMETER	8" DIAMETER	10" DIAMETER	12" DIAMETER
Tee, with Cover	VA304-T05	VA304-T06	VA304-T07	VA304-T08	VA304-T10	VA304-T12
Cover Only	VA304-TC05	VA304-TC06	VA304-TC07	VA304-TC08	VA304-TC10	VA304-TC12
Tee, with Cover	VA316-T05	VA316-T06	VA316-T07	VA316-T08	VA316-T10	VA316-T12
Cover Only	VA316-TC05	VA316-TC06	VA316-TC07	VA316-TC08	VA316-TC10	VA316-TC12



Located at the base of the chimney, this tee can be installed on the interior or the exterior of a structure.

The included tee cover is now easier to remove by means of a one nut driver connection; it's simple to remove, yet childproof. Install with a wall support or a tee support assembly.

Tee features a deep bottom reservoir, which means you DO NOT need an extra section of pipe when using a tee support assembly to attach the tee cover.

No more screws stripping out on the tee cover, making cleaning and inspection a breeze!

SHORT BODY INSULATED TEES: with cover

304L
316L

DESCRIPTION	5" DIAMETER	6" DIAMETER	7" DIAMETER	8" DIAMETER	10" DIAMETER	12" DIAMETER
Tee, with Cover	VA304-SBT05	VA304-SBT06	VA304-SBT07	VA304-SBT08	VA304-SBT10	VA304-SBT12
Tee, with Cover	VA316-SBT05	VA316-SBT06	VA316-SBT07	VA316-SBT08	VA316-SBT10	VA316-SBT12

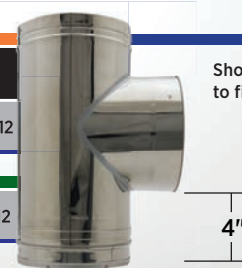

Shortened body on the tee to fit into tighter spaces.

4"

POWDER COATING AVAILABLE



RAIN CAPS:

430

TYPE	5" DIAMETER	6" DIAMETER	7" DIAMETER	8" DIAMETER	10" DIAMETER	12" DIAMETER
Standard	VA-C05	VA-C06	VA-C07	VA-C08	VA-C10	VA-C12
"Wood Style"	VA-CW05	VA-CW06	VA-CW07	VA-CW08	VA-CW10	VA-CW12
"Wide Open Style"	VA-CO05	VA-CO06	VA-CO07	VA-CO08	VA-CO10	VA-CO12



This is a stainless steel cap you can be proud to install.

Quick connect clamp for easy access to clean or inspect the chimney.

Optional 316L cap available to compliment 316L inner wall Class-A pipe.



More open screening than the standard cap. A good choice to provide some pest protection with less creosote buildup issues.

Quick connect clamp for easy access to clean or inspect the chimney.

Optional 316L cap available to compliment 316L inner wall Class-A pipe.



316L

Standard	VA316-C05	VA316-C06	VA316-C07	VA316-C08	VA316-C10	VA316-C12
"Wood Style"	VA316-CW05	VA316-CW06	VA316-CW07	VA316-CW08	VA316-CW10	VA316-CW12
"Wide Open Style"	VA316-CO05	VA316-CO06	VA316-CO07	VA316-CO08	VA316-CO10	VA316-CO12
Class-A Cap Wind/Rain Shield	VA-CWS58			-		

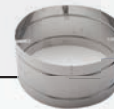

For solid fuel installations with creosote clogging issues, this is the ultimate wide open cap.

Quick connect clamp for easy access to clean or inspect the chimney.

Optional 316L cap available to compliment 316L inner wall Class-A pipe.

CLASS-A DIAMOND CAPS:

304L

DESCRIPTION	5" DIAMETER	6" DIAMETER	7" DIAMETER	8" DIAMETER
Cap with 3/4" Diamond Screen	VA-CD05	VA-CD06	VA-CD07	VA-CD08



Similar to the Open Style Cap but it contains stainless steel 3/4" screening.

WIND DIRECTIONAL RAIN CAPS:

304L

5" DIAMETER	6" DIAMETER	7" DIAMETER	8" DIAMETER
VA304-CWD05	VA304-CWD06	VA304-CWD07	VA304-CWD08



This Wind Directional Cap has been solving wind related down draft problems for decades. This proven solution is ready to connect to Ventis® Class-A pipe.

It is available in 304L and 316L to cover any fuel application.

This is a no screen cap.

PIPE END CAPS:

316L

5" DIAMETER	6" DIAMETER	7" DIAMETER	8" DIAMETER	10" DIAMETER	12" DIAMETER
VA-CPEC05	VA-CPEC06	VA-CPEC07	VA-CPEC08	VA-CPEC10	VA-CPEC12



If you are installing Ventis® Class-A under a stone slate or some other custom shroud, then you will need this item. The Pipe End Cap closes off the top section of pipe to keep moisture from contacting the insulation. Available in 316L only.

SPARK ARRESTOR SCREEN:

304L

5" DIAMETER	6" DIAMETER	7" DIAMETER	8" DIAMETER	10" DIAMETER	12" DIAMETER
VA-CSA05	VA-CSA06	VA-CSA07	VA-CSA08	VA-CSA10	VA-CSA12

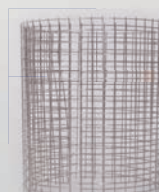

This screening can be installed in most Ventis® Class-A caps. It will not fit in the Wind Directional or Diamond Caps.

VENTED STANDARD FLASHINGS:

PITCH	5" DIAMETER	6" DIAMETER	7" DIAMETER	8" DIAMETER	10" DIAMETER	12" DIAMETER
Flat Roof	VA-F05F	VA-F06F	VA-F07F	VA-F08F	VA-F10F	VA-F12F
0/12 to 6/12	VA-F0506	VA-F0606	VA-F0706	VA-F0806	VA-F1006	VA-F1206
7/12 to 12/12	VA-F0512	VA-F0612	VA-F0712	VA-F0812	VA-F1012	VA-F1212

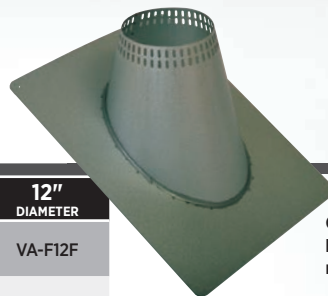

Constructed of high quality, corrosive resistant galvalume.

Available in flat and a variety of roof pitches.

Aluminum Storm Collar included.

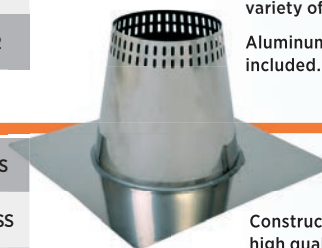

Constructed with high quality, corrosive resistant stainless steel.

Available in flat and a variety of roof pitches.

The ultimate of longevity and good looks.

Includes Stainless Steel Storm Collar.

NON-VENTED STANDARD FLASHINGS:

PITCH	5" DIAMETER	6" DIAMETER	7" DIAMETER	8" DIAMETER	10" DIAMETER	12" DIAMETER
Flat Roof	VA-FNV05F	VA-FNV06F	VA-FNV07F	VA-FNV08F	VA-FNV10F	VA-FNV12F
0/12 to 6/12	VA-FNV0506	VA-FNV0606	VA-FNV0706	VA-FNV0806	VA-FNV1006	VA-FNV1206
7/12 to 12/12	VA-FNV0512	VA-FNV0612	VA-FNV0712	VA-FNV0812	VA-FNV1012	VA-FNV1212

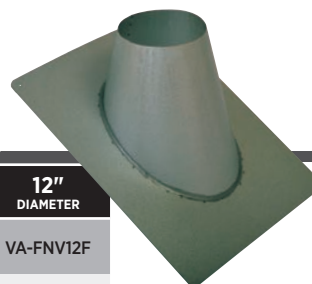

Constructed of high quality, corrosive resistant galvalume.

Available in flat and a variety of roof pitches.

Aluminum Storm Collar included.

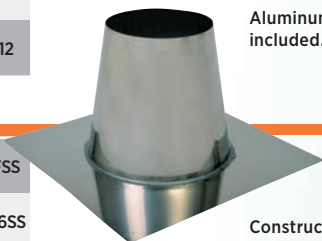

Constructed of high quality, corrosive resistant stainless steel.

Available in flat and a variety of roof pitches.

The Ultimate of longevity and good looks.

Includes Stainless Steel Storm Collar.

NON-VENTED FORMABLE LEAD FLASHINGS:

PITCH	5" DIAMETER	6" DIAMETER	7" DIAMETER	8" DIAMETER
0/12 to 6/12	VA-FNVFM0506	VA-FNVFM0606	VA-FNVFM0706	VA-FNVFM0806
7/12 to 12/12	VA-FNVFM0512	VA-FNVFM0612	VA-FNVFM0712	VA-FNVFM0812

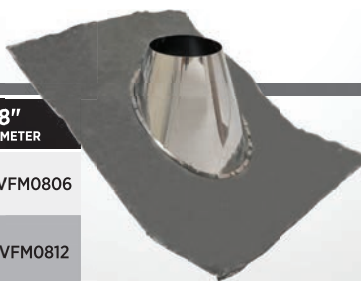

Used when the base needs to mold around irregular surfaces. (e.g. terra-cotta & metal roofs). Much more formable than Dead Soft Aluminum Flashings. Storm Collar included.

GALVALUME

304L

GALVALUME

304L

POWDER COATING AVAILABLE



NON-VENTED PEAK FLASHINGS:

GALVALUME

5" DIAMETER	6" DIAMETER	7" DIAMETER	8" DIAMETER	10" DIAMETER	12" DIAMETER
VA-FNVPK05	VA-FNVPK06	VA-FNVPK07	VA-FNVPK08	VA-FNVPK10	VA-FNVPK12

304L

VA-FNVPK05SS	VA-FNVPK06SS	VA-FNVPK07SS	VA-FNVPK08SS	VA-FNVPK10SS	VA-FNVPK12SS
--------------	--------------	--------------	--------------	--------------	--------------

Specify pitch when ordering

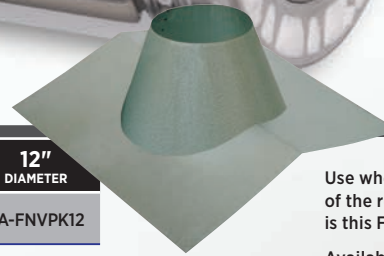

Use when coming through the peak of the roof. No matter what the peak is this Flashing will work for you.

Available in galvalume and stainless steel.

Includes Storm Collar.

Specify pitch when ordering for the perfect fit every time.

VENTED PEAK FLASHINGS:

GALVALUME

5" DIAMETER	6" DIAMETER	7" DIAMETER	8" DIAMETER	10" DIAMETER	12" DIAMETER
VA-FPK05	VA-FPK06	VA-FPK07	VA-FPK08	VA-FPK10	VA-FPK12

304L

VA-FPK05SS	VA-FPK06SS	VA-FPK07SS	VA-FPK08SS	VA-FPK10SS	VA-FPK12SS
------------	------------	------------	------------	------------	------------

Specify pitch when ordering

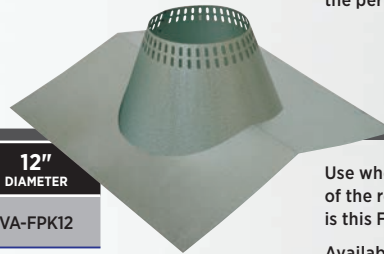

Use when coming through the peak of the roof. No matter what the peak is this Flashing will work for you.

Available in galvalume and stainless steel.

Includes Storm Collar.

Specify pitch when ordering for the perfect fit every time.

NON-VENTED METAL ROOF FLASHINGS:

GALVALUME

PITCH	5" DIAMETER	6" DIAMETER	7" DIAMETER	8" DIAMETER
0/12 to 6/12	VA-FNVMR0506	VA-FNVMR0606	VA-FNVMR0706	VA-FNVMR0806
7/12 to 12/12	VA-FNVMR0512	VA-FNVMR0612	VA-FNVMR0712	VA-FNVMR0812

304L

0/12 to 6/12	VA-FNVMR0506SS	VA-FNVMR0606SS	VA-FNVMR0706SS	VA-FNVMR0806SS
7/12 to 12/12	VA-FNVMR0512SS	VA-FNVMR0612SS	VA-FNVMR0712SS	VA-FNVMR0812SS

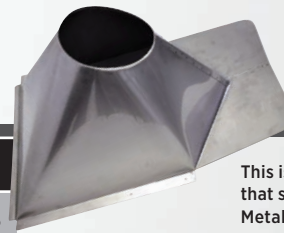

This is a one-of-a-kind design that solves the challenges of Metal Roof Flashings.

Available in galvalume and stainless steel.

Includes Storm Collar.

Trace the metal roof profile on the front edge of the Flashing and cut for a perfect fit. The Integral Snow Wedge on the high side of the Flashing diverts sliding snow and ice, as well as, water. Many a Metal Roof Flashing has been destroyed by melting, sliding snow, but not any more with Olympia's exclusive flashing design!

SNOW WEDGE:

Important for snow diversion on metal roofs

STAINLESS STEEL

PITCH	ITEM #
Low: *4/12 - 6/12 (x = 32")	VA-SWSM
Medium: *7/12 - 10/12 (x = 28")	VA-SWMD
Steep: *10/12 - 12/12 (x = 24")	VA-SWLG

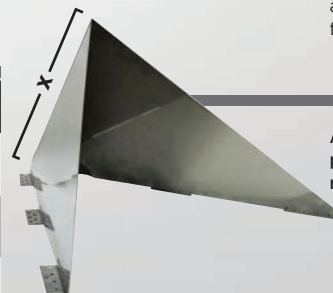

Available in low, medium or steep pitches to accommodate a variety of roof slopes.

This item is especially important for snow diversion on metal roofs.

STORM COLLAR:

ALUM

5" DIAMETER	6" DIAMETER	7" DIAMETER	8" DIAMETER	10" DIAMETER	12" DIAMETER
VA-SC58				VA-SC1012	



Aluminum Storm Collar easily adjusts to fit pipe diameters 5", 6", 7", 8", 10" and 12". Always included with every Flashing or Attic Insulation Shield.

304L

VA-SC05SS	VA-SC06SS	VA-SC07SS	VA-SC08SS	VA-SC10SS	VA-SC12SS
-----------	-----------	-----------	-----------	-----------	-----------



304L Storm Collar made to fit the exact dimension of the pipe.

Use: with all Ventis® Class-A Flashings and Attic Insulation Shields. Seal the inner edge that contacts the chimney pipe with silicone sealant.

ROOF SUPPORT:

GALVANIZED

5" DIAMETER	6" DIAMETER	7" DIAMETER	8" DIAMETER	10" DIAMETER	12" DIAMETER
VA-RS58				VA-RS1012	



This Support is designed to provide support for the chimney pipe at the roof line.

Adjusts easily to any roof pitch

Fits pipe diameters of 5", 6", 7", 8", 10" and 12".

Stainless steel band with galvanized mounting brackets

Use: to extend Class-A Chimney below a cathedral ceiling, when exceeding the weight limit of the primary support, above an offset or to provide additional stability to any installation.

TELESCOPING ROOF BRACES:

Adjusts 67" - 114"

GALVANIZED

5" DIAMETER	6" DIAMETER	7" DIAMETER	8" DIAMETER	10" DIAMETER	12" DIAMETER
VA-RB58				VA-RB1012	

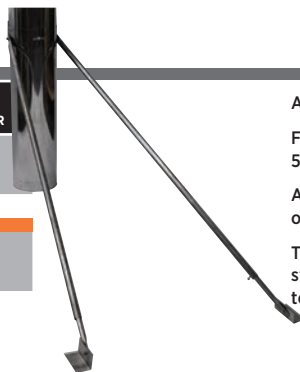

Adjusts from 5' to 9'.

Fits pipe diameters of 5", 6", 7", 8", 10" and 12".

Available in galvanized or stainless steel.

The galvanized roof brace has a stainless steel band with galvanized telescoping poles.

Use: to brace the chimney when it extends more than 5' above the roof. Mounting brackets adjust easily to any roof pitch.

304L

VA-RB58SS	VA-RB1012SS
-----------	-------------

SUPPORT BOX TRUSS SPANNER:

5" DIAMETER	6" DIAMETER	7" DIAMETER	8" DIAMETER
VA-SBTS			

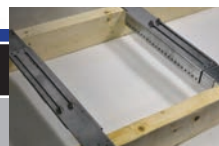

Fits 5", 6", 7", 8", 10" and 12" diameters.

Adjusts from 16" - 24" on center.

Use to eliminate the need to frame the Support Box on all sides.

POWDER COATING AVAILABLE

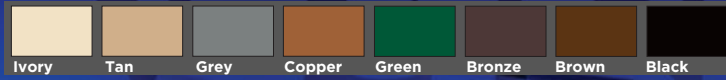

SQUARE CEILING SUPPORT:

Painted Black (Universal adapter included)

DESCRIPTION	5" DIAMETER	6" DIAMETER	7" DIAMETER	8" DIAMETER	10" DIAMETER	12" DIAMETER
11" Tall Support	VA-CCS1105	VA-CCS1106	VA-CCS1107	VA-CCS1108	VA-CCS1110	VA-CCS1112
24" Tall Support	VA-CCS2405	VA-CCS2406	VA-CCS2407	VA-CCS2408	VA-CCS2410	VA-CCS2412
24" Tall Extension	VA-CCSEXT2405	VA-CCSEXT2406	VA-CCSEXT2407	VA-CCSEXT2408	VA-CCSEXT2410	VA-CCSEXT2412

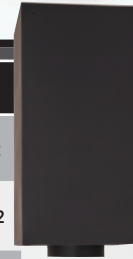

Use on flat, cathedral or sloped ceilings. The bottom of the ceiling support must extend a minimum of 3 inches into the room. A Universal Adapter must be used to connect Ventis® Class-A to either single or double wall stove pipe.

Supports up to 60' of chimney pipe from a floor or ceiling joist.

Support is constructed of 24 gauge galvalume steel painted black.

Square Ceiling Support includes a 2-piece trim collar suitable for any ceiling pitch.

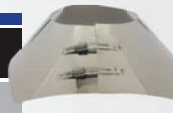

Faceplate is 18 gauge stainless steel painted black and is a unique design that does not rely on spot weld construction, but utilizes a secure formed edge for long term peace of mind.

SQUARE STORM COLLAR: Use when square ceiling support is also used as an attic insulation shield

5" DIAMETER	6" DIAMETER	7" DIAMETER	8" DIAMETER	10" DIAMETER	12" DIAMETER
\$54.00 VA-SCSQ05	VA-SCSQ06	VA-SCSQ07	VA-SCSQ08	VA-SCSQ10	VA-SCSQ12

ROUND CEILING SUPPORT:

Painted Black (Universal adapter included)

DESCRIPTION	5" DIAMETER	6" DIAMETER	7" DIAMETER	8" DIAMETER
11" Tall Support	VA-CCR1105	VA-CCR1106	VA-CCR1107	VA-CCR1108
24" Tall Support	VA-CCR2405	VA-CCR2406	VA-CCR2407	VA-CCR2408
24" Tall Extension	VA-CCREXT2405	VA-CCREXT2406	VA-CCREXT2407	VA-CCREXT2408



Use on flat, cathedral or sloped ceilings. The bottom of the ceiling support must extend a minimum of 3 inches into the room. A Universal Adapter must be used to connect Ventis® Class-A to either single or double wall stove pipe.

Supports up to 60' of chimney pipe from a floor or ceiling joist.

Support is constructed of 24 gauge galvalume steel painted black.

If used on a pitched ceiling, it is necessary to purchase a separate Pitched Ceiling Trim Collar.

Faceplate is 18 gauge stainless steel painted black and is a unique design that does not rely on spot weld construction, but utilizes a secure formed edge for long term peace of mind.



SQUARE TRIM PLATE: For flat ceiling only

5" DIAMETER	6" DIAMETER	7" DIAMETER	8" DIAMETER
VA-CCRSQTR05	VA-CCRSQTR06	VA-CCRSQTR07	VA-CCRSQTR08

CLAMP STYLE SQUARE CEILING SUPPORT BOX: Painted Black

DESCRIPTION	5" DIAMETER	6" DIAMETER	7" DIAMETER	8" DIAMETER
11" Tall Support	VA-CCS1105C	VA-CCS1106C	VA-CCS1107C	VA-CCS1108C
24" Tall Support	VA-CCS2405C	VA-CCS2406C	VA-CCS2407C	VA-CCS2408C

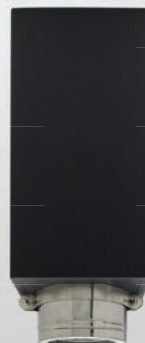

The Class-A pipe passes through the box.

The box comes with a clamp to support the pipe.

This box is used when there is a clearance issue and single or double wall pipe cannot be used as a connector pipe.

PLEASE SEE PAGE 62 FOR UNIVERSAL ADAPTERS AND ANCHOR PLATES.

FINISHING COVER: Painted Black

LENGTH	5" DIAMETER	6" DIAMETER	7" DIAMETER	8" DIAMETER
2½"	VA-FC05	VA-FC06	VA-FC07	VA-FC08
36"	VA-FC0536	VA-FC0636	VA-FC0736	VA-FC0836



Use for a finished look on the end of exposed or visible chimney pipe that extends below a ceiling. Install the Universal Adapter onto the chimney pipe and attach the Finishing Cover, then fasten single or double wall stove pipe to the appliance.

The 36" length can be used to cover the entire exposed pipe on a ceiling supported installation or can be used to cover longer than usual exposed pipe running through a Wall Pass-Thru.

Satin coat black steel painted black.

SLOPED CEILING TRIM COLLAR: Black

TO FIT	5" DIAMETER	6" DIAMETER	7" DIAMETER	8" DIAMETER
Round Ceiling Support	VA-RSTRCS05	VA-RSTRCS06	VA-RSTRCS07	VA-RSTRCS08
Finishing Cover	VA-RSTFC05	VA-RSTFC06	VA-RSTFC07	VA-RSTFC08
Class-A Pipe	VA-RSTVA05	VA-RSTVA06	VA-RSTVA07	VA-RSTVA08



Use on sloped ceilings whether you install (1) a Round Ceiling Support, (2) use a 36" Finishing cover over Class-A pipe on a roof supported installation, or (3) have exposed Class-A pipe on a roof supported installation.

No one in the world has the selection of trim collars offered by Olympia.

This selection offers a solution for every installation scenario.

Specify pitch when ordering. (Flat also available)

POWDER COATING AVAILABLE



ATTIC INSULATION SHIELD:

GALVANIZED

DESCRIPTION	5" DIAMETER	6" DIAMETER	7" DIAMETER	8" DIAMETER	10" DIAMETER	12" DIAMETER
Shield	VA-AIS05	VA-AIS06	VA-AIS07	VA-AIS08	VA-AIS10	VA-AIS12
12" Shield Extension	VA-AISEXT05	VA-AISEXT06	VA-AISEXT07	VA-AISEXT08	VA-AISEXT10	VA-AISEXT12



Use when a chimney passes through an unoccupied attic to keep insulation or any other combustible materials from contacting the chimney pipe.

Galvanized with bottom flanges that ensure a proper fit into the framed opening.

A Storm Collar is included.

FIRESTOP RADIATION SHIELD:

GALVANIZED

DESCRIPTION	5" DIAMETER	6" DIAMETER	7" DIAMETER	8" DIAMETER	10" DIAMETER	12" DIAMETER
Shield	VA-FS05	VA-FS06	VA-FS07	VA-FS08	VA-FS10	VA-FS12



Galvanized with top flanges that ensure a proper fit into the framed opening.

Adjustable upper section extends from 11" to 19" to completely cover the framing.

Designed to protect combustible framing as the chimney pipe passes through a floor and/or ceiling.

WALL PASS-THRU: (Universal adapter included)

GALVALUME

DESCRIPTION	5" DIAMETER	6" DIAMETER	7" DIAMETER	8" DIAMETER	10" DIAMETER	12" DIAMETER
Thimble, non-insulated	VA-WPT05	VA-WPT06	VA-WPT07	VA-WPT08	VA-WPT10	VA-WPT12
Extension 12" length	VA-WPEXT05	VA-WPEXT06	VA-WPEXT07	VA-WPEXT08	VA-WPEXT10	VA-WPEXT12

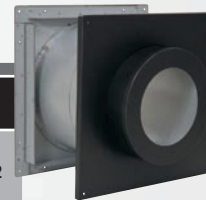

Use when a Class-A chimney passes horizontally thru a combustible wall.

Adjustable from 4" to 8"

Includes a 10" length Finishing Cover to go over the Class-A pipe on the interior.

Exterior is satin coat black steel "paint ready" to match the home exterior.

430

Cover Plate	VA-WPCP05	VA-WPCP06	VA-WPCP07	VA-WPCP08	VA-WPCP10	VA-WPCP12
Siding Trim Kit	VA-STK05	VA-STK06	VA-STK07	VA-STK08	VA-STK10	VA-STK12



Cover plate is 430 stainless steel.

Use to cover the exterior side of the Wall Pass-Thru. It's easy and it matches the pipe.

Trim kit installs with ease and looks professional.

Use to seal the outside of your Wall Pass-Thru when the structure is fitted with vinyl or aluminum siding.

30° WALL PASS THRU: (Non-Insulated)

CLASS-A	VA-WPT0530	VA-WPT0630	VA-WPT0730	VA-WPT0830
----------------	------------	------------	------------	------------



Great for those instances where the wall penetration is below grade!

UNIVERSAL ADAPTER: Painted Black

316L

DESCRIPTION	5" DIAMETER	6" DIAMETER	7" DIAMETER	8" DIAMETER	10" DIAMETER	12" DIAMETER
Male	VA-UA05	VA-UA06	VA-UA07	VA-UA08	VA-UA10	VA-UA12
Female	VA-FUA05	VA-FUA06	VA-FUA07	VA-FUA08	VA-FUA10	VA-FUA12



Use to adapt from Class-A to single or double wall black connector pipe.

Constructed of 316L stainless steel.

Painted black for a seamless transition.

TRANSITION PLATE:

From masonry chimney liner to Class-A

304L

5" DIAMETER	6" DIAMETER	7" DIAMETER	8" DIAMETER	10" DIAMETER	12" DIAMETER
VA-TP05	VA-TP06	VA-TP07	VA-TP08	VA-TP10	VA-TP12



Allows you to connect Ventis® Class-A to Forever Flex™, Armor Flex™, Rhino Rigid™, or Hybrid™ in a masonry chimney restoration.

Specify size and type of liner connecting to when ordering.

Example: This 18"x18" plate is used when a deteriorating masonry chimney is torn down to the attic. A liner such as Forever Flex™ would be installed from the heating appliance to the Transition Anchor Plate, which is mounted to the top of the masonry chimney. Ventis® Class-A would be installed on top of the Transition Plate upward to the required height.

ANCHOR PLATE:

Masonry or factory built fireplace 10"x10"

GALVANIZED

5" DIAMETER	6" DIAMETER	7" DIAMETER	8" DIAMETER	10" DIAMETER	12" DIAMETER
VA-AP05	VA-AP06	VA-AP07	VA-AP08	VA-AP10	VA-AP12



Use to attach Ventis® Class-A to a masonry fireplace or metal-cased fireplace and to certain types of heaters.

POWDER COATING AVAILABLE



STANDARD WALL SUPPORT:

GALVALUME

5" DIAMETER	6" DIAMETER	7" DIAMETER	8" DIAMETER	10" DIAMETER	12" DIAMETER
VA-WS58				VA-WS1012	

304L

VA-WS58SS				VA-WS1012SS	
-----------	--	--	--	-------------	--



Unsurpassed in the industry. For use on Wall Pass-thru Installations, the Wall Support provides both vertical load bearing and lateral support. The first Wall Support is fastened to the first chimney length as a base support and then, at a minimum of every 8' on chimney sections above.

Provides up to 4" of adjustment in or out from the vertical structure (for more adjustment away from the vertical structure please see our Extended Wall Support).

Fits pipe diameters of 5", 6", 7", 8", 10" and 12".

EXTENDED WALL SUPPORT:

GALVALUME

VA-WSE58				VA-WSE1012	
----------	--	--	--	------------	--

304L

VA-WSE58SS				VA-WSE1012SS	
------------	--	--	--	--------------	--



This is just what you need to avoid the hassle of cutting through or offsetting an eave.

It provides up to 14" of adjustment off of the vertical structure.

Provides both vertical and lateral support when installed every eight feet.

TEE SUPPORT:

GALVALUME

5" DIAMETER	6" DIAMETER	7" DIAMETER	8" DIAMETER	10" DIAMETER	12" DIAMETER
VA-TS05	VA-TS06	VA-TS07	VA-TS08	VA-TS10	VA-TS12

304L

VA-TS05SS	VA-TS06SS	VA-TS07SS	VA-TS08SS	VA-TS10SS	VA-TS12SS
-----------	-----------	-----------	-----------	-----------	-----------



This is an optional way to support your exterior installation.

Provides 2" - 5" of adjustment. It supports 60' of chimney.

Available in galvanized and stainless steel.

WALL STAND-OFF:

304L

5" DIAMETER	6" DIAMETER	7" DIAMETER	8" DIAMETER	10" DIAMETER	12" DIAMETER
VA-SF05	VA-SF06	VA-SF07	VA-SF08	VA-SF10	VA-SF12



Use in conjunction with the Tee Support to stabilize the chimney. *NOT made to provide vertical, weight-bearing support. The Tee Support will provide all the vertical, weight-bearing support that you need.

Installed every 8' provides lateral support and will adjust 2" to 6" from the structure.

INSTALLATION EXAMPLES

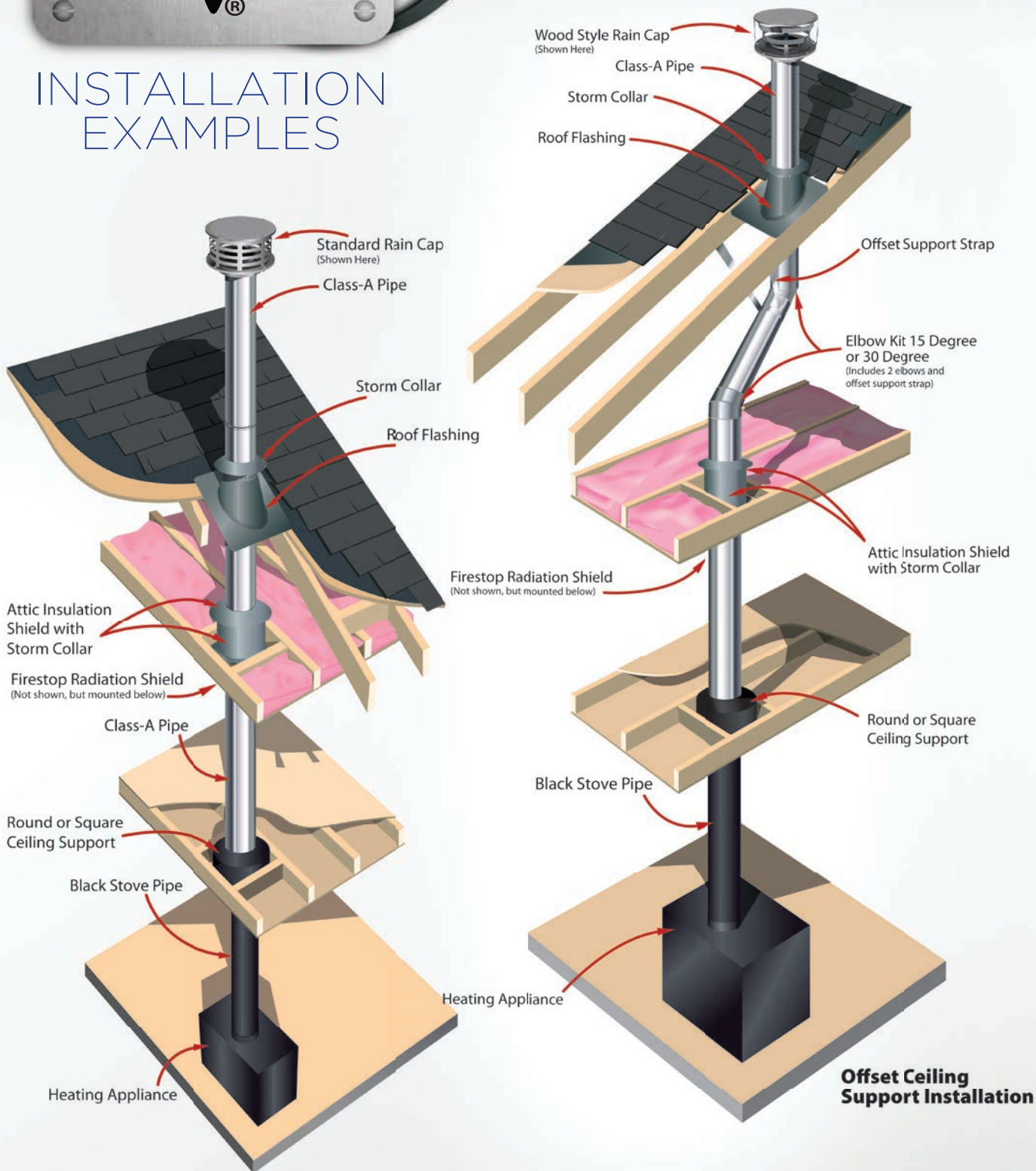

Ceiling Supported Installation
(No Offset)

Offset Ceiling Support Installation

POWDER COATING AVAILABLE

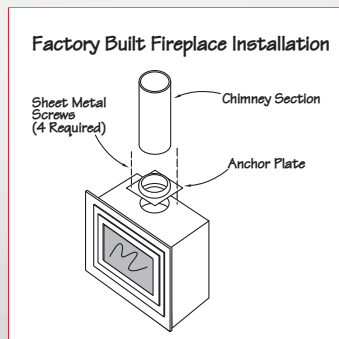
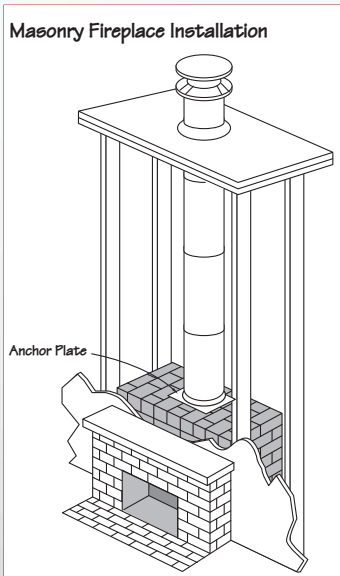
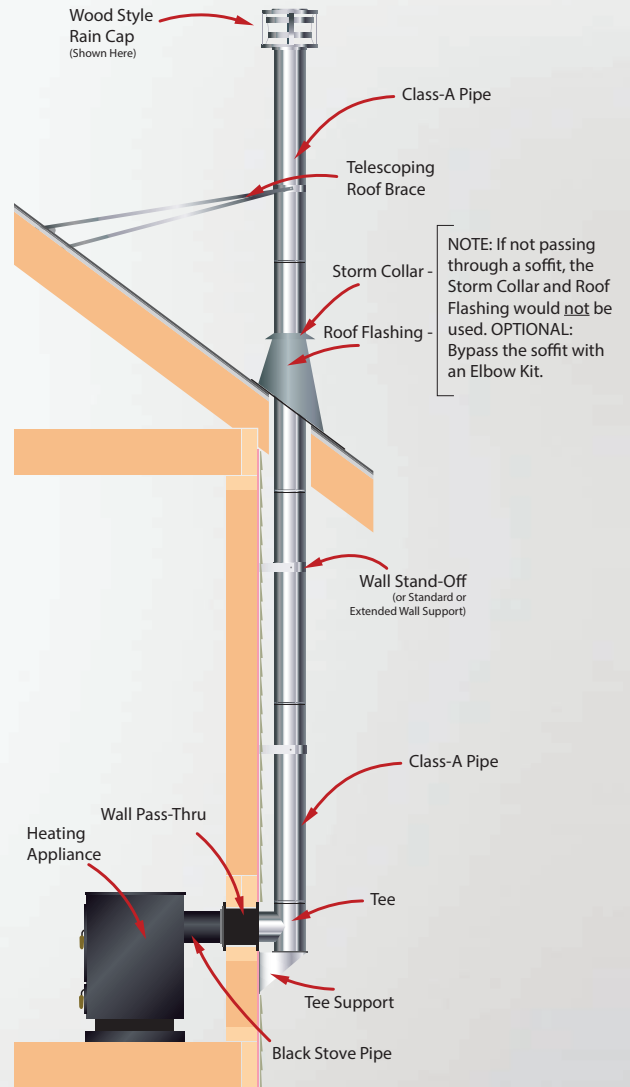
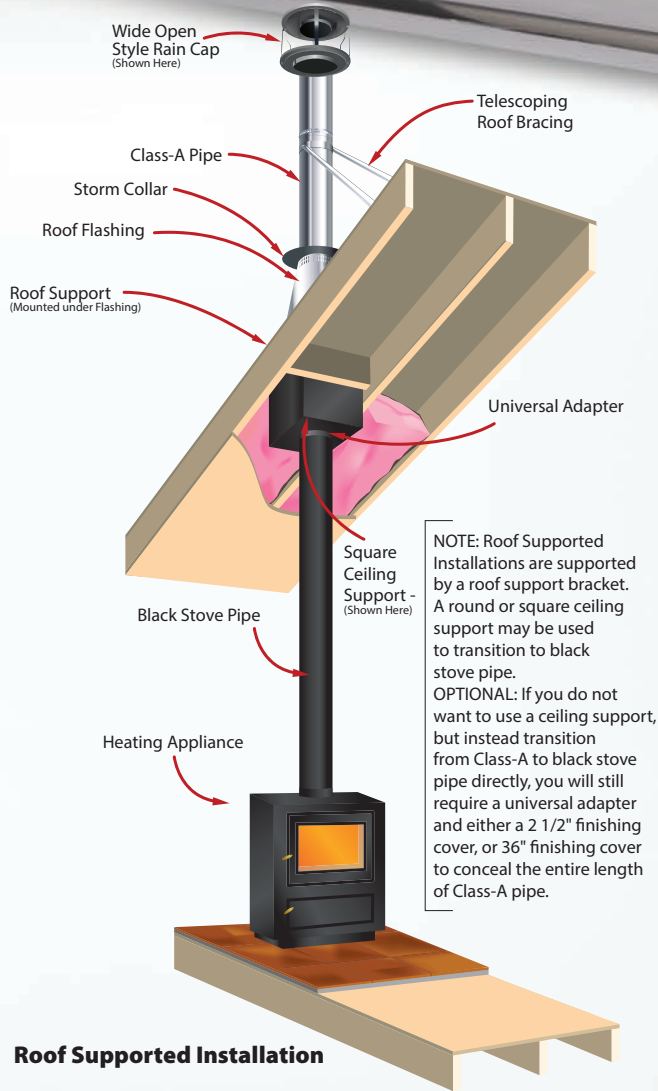



VENTIS

AIR-COOLED VENT SYSTEM

The all-new Ventis® Air-Cooled Chimney System is engineered to vent solid fueled, masonry fireplace. The system is designed mainly for warmer climates.

STAY COOL!

Designed to Provide a Hot Draft on the Inside and Stay Cool on the Outside

10" to 14" Listed to UL103 and ULC S604

304L Inner Pipe

Powder Coating Available in a Wide Variety of Colors

Lifetime Warranty

Made in the USA - in Scranton, Pennsylvania



POWDER COATING AVAILABLE



PIPE:

LENGTHS	10" DIAMETER	12" DIAMETER	14" DIAMETER
12"	VC-1012	VC-1212	VC-1412
18"	VC-1018	VC-1218	VC-1418
24"	VC-1024	VC-1224	VC-1424
36"	VC-1036	VC-1236	VC-1436
48"	VC-1048	VC-1248	—



304L stainless steel inner wall, .016" thickness
Galvalume outer wall, .024" thickness
Standard solid fuel applications

ELBOW KITS:

DEGREE	10" DIAMETER	12" DIAMETER	14" DIAMETER
15°	VC-EL1015	VC-EL1215	VC-EL1415
30°	VC-EL1030	VC-EL1230	VC-EL1430



Available in 15 or 30 degree
Used to offset obstructions such as framing joists
No more than 2 elbows can be used on an installation

ANCHOR PLATES:

10" DIAMETER	12" DIAMETER	14" DIAMETER
VC-API0	VC-API2	VC-API4

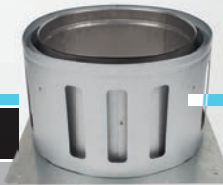

Available with or without a damper
Use to attach Ventis Air-Cooled to a masonry or factory built fireplace.

WITH DAMPER:

VC-ADP10	VC-ADP12	VC-ADP14
----------	----------	----------



Anchor plate will increase pipe length by 10"
Anchor Plate with Damper includes lintel hook and chain
Bolts directly to fireplace outlet



RAIN CAPS: 304L Stainless

10" DIAMETER	12" DIAMETER	14" DIAMETER
VC-C10	VC-C12	VC-C14

304L



Cap is made from 304L stainless steel, pipe section of cap is galvalume
Cap will add 10" to the height of the chimney pipe
Screen is 18 gauge 304 SS 5/8" mesh

304L ALUM

STORM COLLAR:

10" DIAMETER	12" DIAMETER	14" DIAMETER
VC-SC1014		



Aluminum Storm Collar easily adjusts to fit pipe diameters 10,"12"14"

VC-SC10SS	VC-SC12SS	VC-SC14SS
-----------	-----------	-----------



304L Stainless Steel Storm Collar made to fit the exact dimension of the pipe.

GALVALUME

FLASHINGS:

PITCH	10" DIAMETER	12" DIAMETER	14" DIAMETER
Flat Roof	VC-F10F	VC-F12F	VC-F14F
0/6 to 6/12	VC-F1006	VC-F1206	VC-F1406
7/12 to 12/12	VC-F1012	VC-F1212	VC-F1412



Constructed of high quality, corrosive resistant galvalume

Available in flat and a variety of pitches

Aluminum Storm Collar **NOT** included

304L

PITCH	10" DIAMETER	12" DIAMETER	14" DIAMETER
Flat Roof	VC-F10FSS	VC-F12FSS	VC-F14FSS
0/6 to 6/12	VC-F1006SS	VC-F1206SS	VC-F1406SS
7/12 to 12/12	VC-F1012SS	VC-F1212SS	VC-F1412SS



Constructed of high quality, corrosive resistant stainless steel

Available in flat and a variety of pitches

Stainless Steel Storm Collar **NOT** included

ATTIC INSULATION SHIELDS:

10" DIAMETER	12" DIAMETER	14" DIAMETER
VC-AIS10	VC-AIS12	VC-AIS14

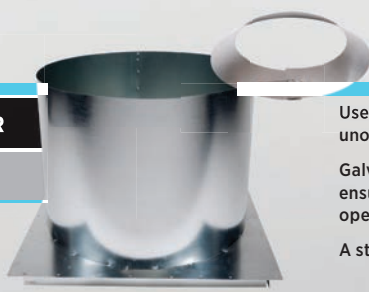

Use when a chimney passes through an unoccupied attic.

Galvanized with bottom flanges that ensure a proper fit into the framed opening

A storm collar is included

POWDER COATING AVAILABLE



FIRE STOPS:

10" DIAMETER	12" DIAMETER	14" DIAMETER
VC-FS10	VC-FS12	VC-FS14



Designed to protect combustible framing as the chimney pipe passes through a floor and or ceiling.

Telescoping upper section extends from 11" to 19" to completely cover the framing.

ROOF SUPPORT: Galvanized

10" DIAMETER	12" DIAMETER	14" DIAMETER
VC-RS1014		

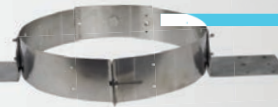

Fits pipe diameters of 10", 12", or 14"

This support is designed to provide support for the chimney at the roof line.

Adjusts easily to any roof pitch

TELESCOPING ROOF BRACES:

Adjusts 67" - 114"

10" DIAMETER	12" DIAMETER	14" DIAMETER
VC-RB1014		

VC-RB1014SS		
-------------	--	--



Fits pipe diameters of 10", 12", or 14"

Adjusts from 5' to 9'

Use: to brace the chimney when it extends more than 5' above the roof. Mounting brackets adjust easily to any roof pitch.

304L GALVANIZED



VENTIS

DIRECT VENT SYSTEM

A NEW **DIRECTION**

Ventis® Direct Vent is manufactured with our Smooth-Weld™ Technology which means you can hardly see the seams. It also can be powder coated in 8 different colors to match your stove or to give a rich look to the pipe.

Quick Connect™ Screwless System

Listed by UL to ULC/ORD-C441, UL 2112 & ANSI Z21.EE Standards

Listed for Gas-fired Direct Vent and Pellet Appliances

The Best Selection of Telescoping Sections in the Industry

Perfectly Round, Perfect Fit Pipe-to-Pipe with Olympia's Smooth-Weld™ and Precision End Forming Technology

Powder Coating Available in a Wide Variety of Colors

Limited Lifetime Warranty

Made in the USA -
in Scranton, Pennsylvania



POWDER COATING AVAILABLE



PIPE UNPAINTED: Stainless Steel Inner and Galvalume Outer

LENGTH	4" DIAMETER	4" (6-PACK)	5" DIAMETER	5" (6-PACK)
6"	VDV-0406	VDV-0406-6	VDV-0506	VDV-0506-6
9"	VDV-0409	VDV-0409-6	VDV-0509	VDV-0509-6
12"	VDV-0412	VDV-0412-6	VDV-0512	VDV-0512-6
18"	VDV-0418	VDV-0418-6	VDV-0518	VDV-0518-6
24"	VDV-0424	VDV-0424-6	VDV-0524	VDV-0524-6
36"	VDV-0436	VDV-0436-6	VDV-0536	VDV-0536-6
48"	VDV-0448	VDV-0448-6	VDV-0548	VDV-0548-6

SLIP SECTIONS:

6"	VDV-0406SL	VDV-0406SL-6	VDV-0506SL	VDV-0506SL-6
9"	VDV-0409SL	VDV-0409SL-6	VDV-0509SL	VDV-0509SL-6
16"	VDV-0416SL	VDV-0416SL-6	VDV-0516SL	VDV-0516SL-6

TELESCOPING SECTIONS:

SMALL 11"-16"	VDV-04ST	—	VDV-05ST	—
MEDIUM 18"-30"	VDV-04MT	—	VDV-05MT	—
LARGE 28"-50"	VDV-04LT	—	VDV-05LT	—

PIPE PAINTED: Stainless Steel Inner, Galvanneal Outer Painted Black

LENGTH	4" DIAMETER	4" (6-PACK)	5" DIAMETER	5" (6-PACK)
6"	VDVB-0406	VDVB-0406-6	VDVB-0506	VDVB-0506-6
9"	VDVB-0409	VDVB-0409-6	VDVB-0509	VDVB-0509-6
12"	VDVB-0412	VDVB-0412-6	VDVB-0512	VDVB-0512-6
18"	VDVB-0418	VDVB-0418-6	VDVB-0518	VDVB-0518-6
24"	VDVB-0424	VDVB-0424-6	VDVB-0524	VDVB-0524-6
36"	VDVB-0436	VDVB-0436-6	VDVB-0536	VDVB-0536-6
48"	VDVB-0448	VDVB-0448-6	VDVB-0548	VDVB-0548-6

SLIP SECTIONS:

6"	VDVB-0406SL	VDVB-0406SL-6	VDVB-0506SL	VDVB-0506SL-6
9"	VDVB-0409SL	VDVB-0409SL-6	VDVB-0509SL	VDVB-0509SL-6
16"	VDVB-0416SL	VDVB-0416SL-6	VDVB-0516SL	VDVB-0516SL-6

TELESCOPING SECTIONS:

SMALL 11" - 16"	VDVB-04ST	—	VDVB-05ST	—
MEDIUM 18" - 30"	VDVB-04MT	—	VDVB-05MT	—
LARGE 28" - 50"	VDVB-04LT	—	VDVB-05LT	—



Smooth-weld technology means virtually invisible seams.

Precision end forming for a better fit.

Easy to install with Olympia's screwless systems.

Inner pipe extended for easy lead-in. Gasket system prevents all leaks and does not require the use of silicone at the joints.

Stainless steel alloy inner wall, .016 thickness

Galvalume outer wall, .018 thickness

Compatible with Ventis® Direct Vent Pellet products.

Slides over standard pipe lengths to allow for easy adjustment and is available in 3 convenient lengths.

Compatible with Ventis® Direct Vent Pellet products.

Telescoping Sections fit inside one another and have a standard male and female connection that will fit all Ventis® Direct Vent parts. Available in 3 convenient lengths

Compatible with Ventis® Direct Vent Pellet products.

Smooth-weld technology means virtually invisible seams.

Precision end forming for a better fit.

Easy to install with Olympia's screwless systems.

Inner pipe extended for easy lead-in. Gasket system prevents all leaks and does not require the use of silicone at the joints.

Stainless steel alloy inner wall, .016 thickness

Galvanneal outer wall, .018 thickness

Painted Black exterior

Compatible with Ventis® Direct Vent Pellet products.

Slides over standard pipe lengths to allow for easy adjustment and is available in 3 convenient lengths.

Compatible with Ventis® Direct Vent Pellet products.

Telescoping Sections fit inside one another and have a standard male and female connection that will fit all Ventis® Direct Vent parts. Available in 3 convenient lengths.

Compatible with Ventis® Direct Vent Pellet products.

HORIZONTAL INSTALLATION KITS:

DESCRIPTION	4" DIAMETER	5" DIAMETER
Wall Pass Thru	VDV-KW04	VDV-KW05
Wall Trim Cover	VDV-K04	VDV-K05



Horizontal Installations Kits are available with and without a Wall Pass-Thru. VDV-KW04/05 comes with a complete Wall Pass-Thru assembly. VDV-K04/05 comes with an interior Wall Trim Cover. Both Kits include as standard: Horizontal Cap, 90 Elbow, 24" Pipe Section, and a 9" pipe section.

MASONRY CHIMNEY CONVERSION KIT:

FINISH	4" DIAMETER	5" DIAMETER
Galvalume	VDV-MCK04	VDV-MCK05

The Ventis® Masonry Conversion Kit (VDV-MCK04) is used to vent the appliance through an existing masonry chimney using the chase to provide incoming combustion air when allowed by the appliance manufacturer.

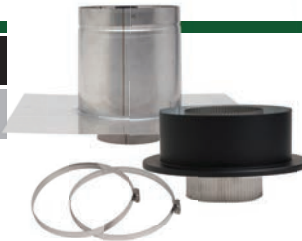

The kit includes the Masonry Conversion Adapter with built-in trim ring, top plate, and Cap Adapter. Both the Vertical Cap (VDV-VCXX) and Vertical High Wind (VDV-VCHWXX) cap (sold separately) will fit the Cap Adapter.

CLASS-A CONVERSION KIT:

DESCRIPTION	4" DIAMETER
6" Class-A Conversion Kit	VDV-CACK604
7" Class-A Conversion Kit	VDV-CACK704
8" Class-A Conversion Kit	VDV-CACK804



The Class-A Conversion Kit includes an adapter to convert an existing factory built chimney system to a Direct Vent System. Kit includes the cap adapter and the pipe adapter kits. Conversion kits fit Ventis® Class-A pipe.

See page 79 for aluminum and stainless steel liners to complete the conversion.

ELBOWS: Stainless Steel Inner and Galvalume Outer

DEGREE	4" DIAMETER	4"(6-PACK)	5" DIAMETER	5"(6-PACK)
45°	VDV-EL0445	VDV-EL0445-6	VDV-EL0545	VDV-EL0545-6
90°	VDV-EL0490	VDV-EL0490-6	VDV-EL0590	VDV-EL0590-6



Available in both a Painted Black or Galvalume finish. 45 and 90 degree elbows are available. All inner elbow segments are circumferentially welded for a leak free connection.

Compatible with Ventis® Direct Vent Pellet products.

ELBOWS: Stainless Steel Inner, Galvanneal Outer Painted Black

DEGREE	4" DIAMETER	4"(6-PACK)	5" DIAMETER	5"(6-PACK)
45°	VDVB-EL0445	VDVB-EL0445-6	VDVB-EL0545	VDVB-EL0545-6
90°	VDVB-EL0490	VDVB-EL0490-6	VDVB-EL0590	VDVB-EL0590-6

REPLACEMENT GASKET:

4" DIAMETER	5" DIAMETER
4" Direct Gasket	5" Direct Gasket

Compatible with Ventis® Direct Vent Pellet products.

POWDER COATING AVAILABLE



VERTICAL RAIN CAP:

4" DIAMETER	5" DIAMETER
304L Stainless Steel	
VDV-VC04	VDV-VC05
Copper	
VDV-VC04-Copper	VDV-VC05-Copper



The Vertical Rain Cap is made from all 304 stainless steel or copper. The cap features a Quick Connect™ Clamp for easy installation and removal.

Copper caps are custom items

VERTICAL HIGH WIND CAP: 304L Stainless

VDV-VCH04	VDV-VCH05
-----------	-----------



Made from all 304 stainless steel. The cap contains multiple baffle plates that keep the wind from interfering with the exhaust gas and air intake. The cap features a Quick Connect™ Clamp for easy installation and removal.

HORIZONTAL CAPS:

4" DIAMETER	5" DIAMETER
304L Stainless Steel	
VDV-HC04	VDV-HC05
Copper	
VDV-HC04-Copper	VDV-HC05-Copper

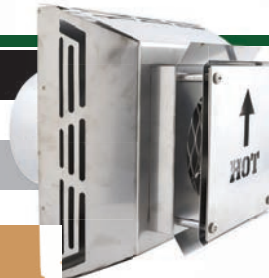

The Horizontal Cap (VDV-HCXX) is made from all 304 Stainless Steel or copper. The cap has a unique heat transferring design that keeps the heat away from the house and will not mix the fresh air with the exhaust air. **THIS CAP DOES NOT REQUIRE A STAND-OFF FOR VINYL SIDING.** The stand-off is optional.

Copper caps are custom items

SIDING STAND-OFF: 304L Stainless Steel

VDV-SS04	VDV-SS05
----------	----------

The Siding Stand-Off is made from all 304 Stainless Steel. It will stand the Horizontal Cap off of the house siding and also protect the siding from heat. Will fit both the 4" & 5" Horizontal Terminations.

SCONCE STYLE CAP:

4" DIAMETER	5" DIAMETER
304L Stainless Steel	
VDV-HSC04	VDV-HSC05
Copper	
VDV-HSC04-Copper	VDV-HSC05-Copper



Made from all 304 Stainless Steel or copper. The cap has a unique heat transferring design that keeps the heat away from the house and will not mix the fresh air with the exhaust air. **THIS CAP DOES NOT REQUIRE A STAND-OFF FOR VINYL SIDING.** The stand-off is optional.

Copper caps are custom items

SNORKEL CAPS: 304L Stainless Steel

SIZE	4" DIAMETER	5" DIAMETER
14"	VDV-SNC0414	VDV-SNC0514
36"	VDV-SNC0436	VDV-SNC0536



Snorkel Caps are used when there is a need to vertically extend the exhaust termination on the exterior side of the structure. There are two sizes that will extend your termination either 14" or 36".

STORM COLLAR: 304L Stainless Steel

4" DIAMETER	5" DIAMETER
VDV-SC04	VDV-SC05

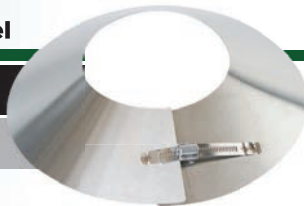

Made from stainless steel and fits the exact dimension of the pipe.

Compatible with Ventis® Direct Vent Pellet products.

FLASHINGS: Galvalume

PITCH	4" DIAMETER	5" DIAMETER
Flat Roof	VDV-F04F	VDV-F05F
0/12 to 6/12	VDV-F0406	VDV-F0506
7/12 to 12/12	VDV-F0412	VDV-F0512

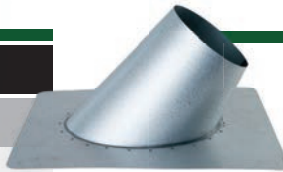

Made from Galvalume. Available in flat and a variety of roof pitches.

Compatible with Ventis® Direct Vent Pellet products.

CEILING SUPPORTS:

DESCRIPTION	4" DIAMETER	5" DIAMETER
Square	VDV-CSS04	VDV-CSS05
Rounded	VDV-CRS04	VDV-CRS05
Firestop	VDV-FS04	VDV-FS05
Attic Insulation Shield	VDV-AIS04	VDV-AIS05



Square and Round Ceiling Supports can be used on flat, cathedral or sloped ceilings. Both styles are 11" tall. A trim collar and clamp are included with both Square and Round Support Boxes.

A Firestop is required when passing through a non-insulated floor or ceiling.

An Attic Insulation Shield is necessary when passing through an insulated ceiling and requires the use of a storm collar which is included.

WALL SUPPORTS: 304L Stainless Steel

4" DIAMETER	5" DIAMETER
VDV-WS04	VDV-WS05



Wall Support: Adjusts from 1" to 4" clearance from the wall. A support is required when vertical lengths extend over 8'.

Compatible with Ventis® Direct Vent Pellet products.

POWDER COATING AVAILABLE



WALL PASS-THRU: Galvanneal, Painted Black

DESCRIPTION	4" DIAMETER	5" DIAMETER
Wall Pass-Thru	VDV-WPT04	VDV-WPT05
High Output Wall Pass-Thru	—	VDV-WPT05HO
Wall Trim Collar	VDV-WTC04	VDV-WTC05



Used when passing horizontally through a combustible wall. This part is adjustable from 4" to 9" for a variety of wall thicknesses. All interior parts are painted black.

An exterior Galvalume cover plate is included.

Compatible with Ventis® Direct Vent Pellet products.

5" High Output Wall Pass-Thru has 4" clearance on the top and a 1" clearance on the sides and bottom.

The Wall Trim Collar is used when passing horizontally through a wall. The trim cover is painted black and is for the interior side of the wall.

ADAPTERS:

DESCRIPTION	4" DIAMETER	5" DIAMETER
Galvalume	VDV-UAA04	VDV-UAA05
Painted Black	VDVB-UAA04	VDVB-UAA05



Universal Appliance Adapter- Use when there is a starter piece already installed on the appliance.

REDUCERS/INCREASER

5" to 4" DIAMETER REDUCER	4" to 5" DIAMETER INCREASER
VDV-54RDI	VDV-45RDI



Reducers/Increasesers will allow you to switch from either 4" pipe to 5" pipe.

CO-LINEAR KITS

304 Stainless Steel 3" Exhaust & 3" Air Intake Kits

Description	Aluminum Liner	430 SS Liner
KIT INCLUDES: • 1- 3"x3" 304 SS Co-Linear Cap • 2- 3"x35' Flexible Liners • 2- 3" SS Hose Clamps	VDV-CK33CC	VDV-CK33CCSS

Galvanneal Painted Black 3" Exhaust & 3" Air Intake Cap Kits

Description	Aluminum Liner	430 SS Liner
KIT INCLUDES: • 1- 3"x3" Black Co-Linear Cap • 2- 3"x35' Flexible Liners • 2- 3" SS Hose Clamps	VDVB-CK33CC	VDVB-CK33CCSS



304 Stainless Steel 4" Exhaust & 3" Air Intake Cap Kits

Description	Aluminum Liner	430 SS Liner
KIT INCLUDES: • 1- 4"x3" 304 SS Co-Linear Cap • 1- 4"x35' & 1- 3"x35' Flexible Liners • 1- 4" & 1- 3" SS Hose Clamps	VDV-CK43CC	VDV-CK43CCSS

Galvanneal Painted Black 4" Exhaust & 3" Air Intake Cap Kits

Description	Aluminum Liner	430 SS Liner
KIT INCLUDES: • 1- 4"x3" Black Co-Linear Cap • 1- 4"x35' & 1- 3"x35' Flexible Liners • 1- 4" & 1- 3" SS Hose Clamps	VDVB-CK43CC	VDVB-CK43CCSS



304 Stainless Steel High Wind 3" Exhaust & 3" Air Intake Cap Kits

Description	Aluminum Liner	430 SS Liner
KIT INCLUDES: • 1- 4" Vertical High Wind Cap • 2- 3"x35' Flexible Liners • 1- Co-Linear Top Termination (VDV-CTT04) • 4- 3" SS Hose Clamps	VDV-CK33HWA	VDV-CK33HWASS

304 Stainless Steel High Wind 4" Exhaust & 3" Air Intake Cap Kits

Description	Aluminum Liner	430 SS Liner
KIT INCLUDES: • 1- 4" Vertical High Wind Cap • 1- 4"x35' Flexible Liner • 1- 3"x35' Flexible Liner • 1- Co-Linear Top Termination (VDV-CTT043) • 2- 4" SS Hose Clamps • 2- 3" SS Hose Clamps	VDV-CK43HW	VDV-CK43HWASS



304 Stainless Steel High Wind 3" Exhaust & 3" Air Intake Cap Kits (with 5' length of Air Intake liner)

Description	Aluminum Liner	430 SS Liner
KIT INCLUDES: • 1- 4" Vertical High Wind Cap • 1- 3"x35' Flexible Liner • 1- 3"x5' Flexible Liners • 1- Co-Linear Top Termination (VDV-CTT04) • 4- 3" SS Hose Clamps	VDV-CK33HW	VDV-CK33HWSS



POWDER COATING AVAILABLE



CO-LINEAR CAPS

3" EXHAUST & 3" AIR INTAKE

4" EXHAUST & 3" AIR INTAKE

304L Stainless Steel

VDV-CC33

VDV-CC43

Galvanneal Painted Black

VDVB-CC33

VDVB-CC43



Crown Mount Caps come with a built-in 18" x 18" top plate. All Co-Linear Caps have a built-in hose clamp on the exhaust and air intake collars to attach the liner.

TERRA-COTTA MOUNT

3" EXHAUST & 3" AIR INTAKE

4" EXHAUST & 3" AIR INTAKE

304L Stainless Steel

VDV-CC33-813

VDV-CC43-813

VDV-CC33-1313

VDV-CC43-1313

Galvanneal Painted Black

VDVB-CC33-813

VDVB-CC43-813

VDVB-CC33-1313

VDVB-CC43-1313



Terra-Cotta Mount Caps come with either a 8" x 13" or 13" x 13" Terra-Cotta Frame. All Co-Linear caps have a built-in hose clamp on the exhaust and air intake collars to attach the liner.

CO-LINEAR PARTS

DESCRIPTION	4" DIAMETER
Co-Linear Top Termination	VDV-CTT04
Co-Linear Top Termination	VDV-CTT43
Co-Linear Appliance Adapter	VDV-CAC04

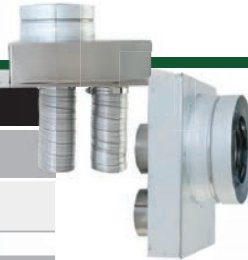

Co-Linear Top Termination (VDV-CTT04 & VDV-CTT43): Top Termination with 18" x 18" built-in top plate. The VDV-CTT04 has a 3" exhaust and a 3" air intake, the VDV-CTT43 has a 4" exhaust and a 3" air intake. Both the Vertical Cap (VDV-VCO4) and High Wind Cap (VDV-VCHW04) (sold separately) will fit the Cap Adapter. Two flexible liners will complete the installation.

MASONRY CO-LINEAR ADAPTER

Adapter with 3" Exhaust	VDV-MC04-33
Adapter with 4" Exhaust	VDV-MC04-43



The Co-Linear Appliance Adapter (VDV-CAC04) connects 3" flexible liners to the appliance. This adapter will be used with the Co-Linear Top Termination.

Use the Masonry Co-Linear Adapter when converting from 4" Direct Vent pipe to Co-Linear at the thimble. Comes with either a 3" or 4" exhaust.

FLEXIBLE LINERS

LENGTH	3" DIAMETER	4" DIAMETER
430 Stainless Steel		
25 ft	L430-325	L430-425
35 ft	L430-335	L430-435
Aluminum		
25 ft	LA325	LA425
35 ft	LA335	LA435



Ventis Stainless Steel or aluminum flexible liner is made from 430 stainless steel or aluminum. This liner is used when converting existing chimney to a Ventis® Direct Vent chimney. Both 3" and 4" diameters are available in 25' and 35' lengths.



VENTIS

PELLET VENT SYSTEM



AN INDUSTRY FIRST

Ventis® Pellet Vent is the only pellet pipe on the market with a Quick Connect™ Screwless System which results in a much cleaner looking installation. The hi-temp gaskets in our system means a “leak free” sealed system at every connection.

“Leak Free” Sealed System

Quick Connect™ Screwless System

The Best Selection of Slip Sections in the Industry

Perfectly Round, Perfect Fit Pipe-to-Pipe with Olympia's Smooth-Weld™ and Precision End Forming Technology

Available in Both Non-Painted and Painted-Black Exteriors

Limited Lifetime Warranty

Made in the USA - in Scranton, Pennsylvania

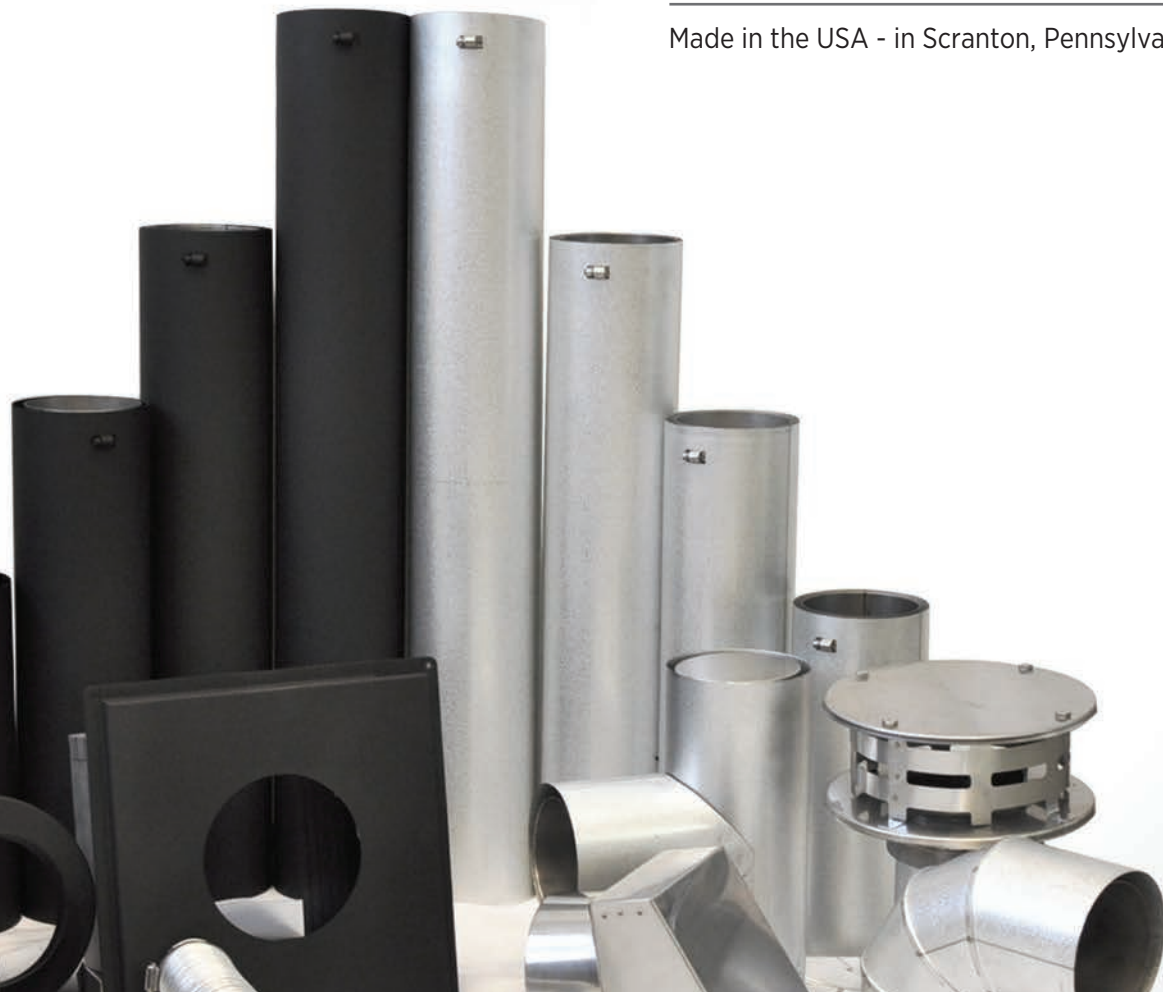

PIPE UNPAINTED: 304L inner/Galvalume Outer

LENGTHS	3" DIAMETER	3" (6-PACK)	4" DIAMETER	4" (6-PACK)
6"	VP-0306	VP-0306-6	VP-0406	VP-0406-6
12"	VP-0312	VP-0312-6	VP-0412	VP-0412-6
18"	VP-0318	VP-0318-6	VP-0418	VP-0418-6
24"	VP-0324	VP-0324-6	VP-0424	VP-0424-6
36"	VP-0336	VP-0336-6	VP-0436	VP-0436-6
48"	VP-0348	VP-0348-6	VP-0448	VP-0448-6

SLIP SECTIONS: 304L inner/Galvalume Outer

DESC.	3" DIAMETER	3" (6-PACK)	4" DIAMETER	4" (6-PACK)
6"	VP-0306SL	VP-0306SL-6	VP-0406SL	VP-0406SL-6
9"	VP-0309SL	VP-0309SL-6	VP-0409SL	VP-0409SL-6
16"	VP-0316SL	VP-0316SL-6	VP-0416SL	VP-0416SL-6

PIPE PAINTED: 304L inner/Galvalume Outer Painted Black

LENGTHS	3" DIAMETER	3" (6-PACK)	4" DIAMETER	4" (6-PACK)
6"	VPB-0306	VPB-0306-6	VPB-0406	VPB-0406-6
12"	VPB-0312	VPB-0312-6	VPB-0412	VPB-0412-6
18"	VPB-0318	VPB-0318-6	VPB-0418	VPB-0418-6
24"	VPB-0324	VPB-0324-6	VPB-0424	VPB-0424-6
36"	VPB-0336	VPB-0336-6	VPB-0436	VPB-0436-6
48"	VPB-0348	VPB-0348-6	VPB-0448	VPB-0448-6

SLIP SECTIONS: 304L inner/Painted Black

DESC.	3" DIAMETER	3" (6-PACK)	4" DIAMETER	4" (6-PACK)
6"	VPB-0306SL	VPB-0306SL-6	VPB-0406SL	VPB-0406SL-6
9"	VPB-0309SL	VPB-0309SL-6	VPB-0409SL	VPB-0409SL-6
16"	VPB-0316SL	VPB-0316SL-6	VPB-0416SL	VPB-0416SL-6

REPLACEMENT GASKET:

Gasket	3" Pellet Gasket	4" Pellet Gasket

Easy to install with Olympia's Quick Connect™ screwless system.

Revolutionary gasket system prevents all leaks and DOES NOT require the use of silicone at the joints.

304L alloy inner wall, .016 thickness.

Galvalume outer wall, .018 thickness.

Requires 1" clearance to combustibles.

Slides over standard pipe lengths to allow for easy adjustment and is available in 3 convenient lengths.

Easy to install with Olympia's Quick Connect™ screwless system

Revolutionary gasket system prevents all leaks and DOES NOT require the use of silicone at the joints

304L alloy inner wall, .016 thickness

Galvalume outer wall, .018 thickness

Painted Black Exterior

Requires 1" clearance to combustibles

Slides over standard pipe lengths to allow for easy adjustment and is available in 3 convenient lengths.

304L

304L



TEES: Galvalume Outer

TYPE	3" DIAMETER	3" (6-PACK)	4" DIAMETER	4" (6-PACK)
Tee, with cap	VP-T03	VP-T03-6	VP-T04	VP-T04-6
Stove Adapter Tee, with cap	VP-SAT03	VP-SAT03-6	VP-SAT04	VP-SAT04-6
4" to 3" Stove Adapter Tee, with cap	—	—	VP-SAT43	VP-SAT43-6
Pellet Clean-Out Tee, with caps	VP-CT03	VP-CT03-6	VP-CT04	VP-CT04-6
4" Pellet Tee with 3" Pellet Pipe Take-off	—	—	VP-T43	VP-T43-6
4" to 3" Stove Adapter for Harman Stoves	—	—	VP-SAT43HARM	VP-SAT43HARM-6



Available in both a Painted Black or Galvalume finish.

The Tee Cap on both style tees is sealed and easily removable with a nut driver.

Stove Adapter Tees connect directly to the appliance which eliminates the need for a stove adapter.

Tee cap included with every tee.

The 4" tees are compatible with Ventis® Direct Vent Pellet products.



STOVE ADAPTER TEE WITH CAP: 4" to 3"

4" body and 3" take-off that connects directly to the stove.

The 4" Adapter Tees are compatible with Ventis® Direct Vent Pellet products.

TEES: Painted Black

TYPE	3" DIAMETER	3" (6-PACK)	4" DIAMETER	4" (6-PACK)
Tee, with cap	VPB-T03	VPB-T03-6	VPB-T04	VPB-T04-6
Stove Adapter Tee, with cap	VPB-SAT03	VPB-SAT03-6	VPB-SAT04	VPB-SAT04-6
4" to 3" Stove Adapter Tee, with cap	—	—	VPB-SAT43	VPB-SAT43-6
Pellet Clean-Out Tee, with caps	VPB-CT03	VPB-CT03-6	VPB-CT04	VPB-CT04-6
4" Pellet Tee with 3" Pellet Pipe Take-off	—	—	VPB-T43	VPB-T43-6
4" to 3" Stove Adapter for Harman Stoves	—	—	VPB-SAT43HARM	VPB-SAT43HARM-6
Pellet Tee Cap with Clean Out	VPB-CTC03	VPB-CTC03-6	VPB-CTC04	VPB-CTC04-6



PELLET CLEAN-OUT TEE WITH CAP

Tee comes with a removable door on the back for easy cleaning access.

The 4" tees are compatible with Ventis® Direct Vent Pellet products.



4" PELLET TEE WITH 3" PIPE TAKE-OFF

This part is used to switch from 3" Pellet Pipe to 4" Pellet Pipe.

The 4" tees are compatible with Ventis® Direct Vent Pellet products.

ELBOWS: Galvalume Outer

DEGREE	3" DIAMETER	3"(6-PACK)	4" DIAMETER	4"(6-PACK)
45°	VP-EL0345	VP-EL0345-6	VP-EL0445	VP-EL0445-6
90°	VP-EL0390	VP-EL0390-6	VP-EL0490	VP-EL0490-6



Available in both a Painted Black or Galvalume finish.

45 and 90 degree Elbows available.

Smaller radius to make installations in confined spaces much easier.

ELBOWS: Black Finish

45°	VPB-EL0345	VPB-EL0345-6	VPB-EL0445	VPB-EL0445-6
90°	VPB-EL0390	VPB-EL0390-6	VPB-EL0490	VPB-EL0490-6

304L

304L

304L



ADAPTERS: Galvalume Painted Black

DESCRIPTION	3" DIAMETER	4" DIAMETER
Stove Adapter	VP-SA03	VP-SA04
Pellet Stove Increaser	VPB-PSI34	—
Pellet Stove Increaser	VPB-SA03HARM	—
Harman Pellet Stove Increaser	VPB-PSI34HARM	—
Pellet Pipe Increaser	—	VPB-PI34
Flex Adapter	—	VP-FLA04
Harman Stove Collar Adapter	VP-HARM2	—
Harman Stove Collar Adapter	VP-HARM6	—



The Stove Adapter will fit most flue collar sizes.

The 4" Stove Adapter is compatible with Ventis® Direct Vent Pellet products.



Pellet Stove Increaser is used to connect 4" Ventis® Pellet Pipe to a 3" Stove Outlet



Harman Stove Adapter is used to connect 3" Ventis® Pellet Pipe to a 3" Harman Stove Outlet



Pellet Stove Increaser is used to connect 4" Ventis® Pellet Pipe to a 3" Harman Stove Outlet



Pellet Pipe Increaser is used to connect 3" Ventis® Pellet Pipe to 4" Pellet Pipe.



The Flex adapter is used to connect 4" Pellet Pipe to 4" Forever Flex™ Liner.

The 4" Flex Adapter is compatible with Ventis® Direct Vent Pellet products.



Harman Stove Collar Adapter attaches directly to the Harman Stove and does not require a stove adapter. The Mounting collar comes with a high temperature gasket to ensure a leak free connection to the stove. The VP-HARM2 is 2" Long and the VP-HARM6 is 6 1/2" Long and is used for Harman P-Series units.





304L

RAIN CAPS: Vertical

3" DIAMETER	4" DIAMETER
VP-VC03	VP-VC04



Made from stainless steel.
Features a Quick Connect™ Clamp for easy access to clean or inspect the chimney.

304L

RAIN CAPS: Horizontal

3" DIAMETER	4" DIAMETER
VP-HC03	VP-HC04



Made from stainless steel.
Diverts the flue gases away from the house to prevent staining.

304L

JET CAP:

3" DIAMETER	4" DIAMETER
VP-JC03	VP-JC04



Made from stainless steel.
Adjustable 360 degrees.
Can be turned so the flue gases are directed away from objects nearby.

304L

STORM COLLAR:

3" DIAMETER	4" DIAMETER
VP-SC03	VP-SC04



Made from stainless steel and to fit the exact dimension of the pipe.

ROOF SUPPORTS:

TYPE	3" DIAMETER	4" DIAMETER
Roof Support	VP-RS03	VP-RS04
Telescoping Roof Brace	VP-RB03	VP-RB04



ROOF SUPPORT is designed to provide support for the pellet pipe at the roofline. It adjusts easily to any roof pitch.



TELESCOPING ROOF BRACE is used to brace the Pellet Pipe when it extends more than 5' above the roof. Adjusts from 5-9 feet. Mounting brackets adjust easily to any roof pitch.

304L

WALL SUPPORTS:

3" DIAMETER	4" DIAMETER
VP-WS03	VP-WS04



Adjusts from 1" to 4" clearance from the wall.
A Wall Support is required for every 8 feet of chimney pipe.



FLASHINGS:

PITCH	3" DIAMETER	4" DIAMETER
Flat Roof	VP-F03F	VP-F04F
0/12 TO 6/12	VP-F0306	VP-F0406
7/12 to 12/12	VP-F0312	VP-F0412



Made from galvalume.

Available in flat and a variety of roof pitches.

Also available in 304 stainless steel from our Custom Shop.

Storm Collar is sold separately.

CEILING SUPPORTS: Galvalume

Painted Black

GALVALUME

DESCRIPTION	3" DIAMETER	4" DIAMETER
11" Tall Square Support	VP-CSS03	VP-CSS04
11" Tall Round Support	VP-CSR03	VP-CSR04



Use on flat, cathedral or sloped ceilings

Box will support up to 40 feet of venting.

A Trim Collar and Clamp are included with both Square and Round Support Boxes.

GALVALUME

Firestop	VP-FS03	VP-FS04
Attic Insulation Shield	VP-AIS03	VP-AIS04



Firestop is required when passing through a floor or ceiling.

Attic Insulation Shield is necessary when passing through a ceiling and requires the use of a Storm Collar.

Storm Collar included.

WALL PASS-THRU: Galvalume Painted Black

GALVALUME

DESCRIPTION	3" DIAMETER	4" DIAMETER
Thimble	VP-WPT03	VP-WPT04
Thimble with 2" Fresh Air Intake	VP-WPTA032	VP-WPTA042
Thimble with 3" Fresh Air Intake	VP-WPTA033	VP-WPTA043



Adjustable from 4" to 9" for a variety of wall thicknesses

Exterior Galvalume Cover Plate is included.

Fresh Air Intake allows fresh air for combustion to come through the wall without having to cut a secondary hole.

Both the 3" & 4" models come with 4' of 2" or 3" aluminum flex.



WALL PASS THRU: Painted Black

Harman Fresh Air Adapter	VP-HAA	—
--------------------------	--------	---



This part adapts Olympia's Wall Pass-Thru with 3" Fresh Air to Harman Stoves with 2 3/4" Fresh Air.

VENTIS

PELLET VENT SYSTEM



FRESH AIR INTAKE KIT: For Pellet Stoves

DESCRIPTION	3" DIAMETER	4" DIAMETER
Fresh Air Intake Kit	FAI-3	—



Allows fresh air into an existing pellet stove & gas insert installation that had been using inside air.

The kit allows the installer to decide the best possible location for the air intake vent.

FRESH AIR INTAKE ADAPTER 3" to 2"

FAI-3-ADAPT

SIDING TRIM KIT: Must be used with the Wall Pass Thru

GALVALUME

DESCRIPTION	3" DIAMETER	4" DIAMETER
Siding Trim Kit	VP-STK03	VP-STK04
Siding Trim Kit with Fresh Air Intake	VP-STKA03	VP-STKA04

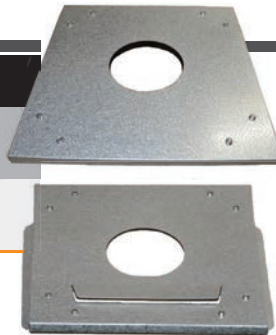

Use to seal the outside of your Wall Pass-Thru when the structure is fitted with aluminum or vinyl siding.

Siding Trim Kit must be used with the Wall Pass-Thru.

Fresh Air Intake has a louvered vent incorporated to allow fresh air in for combustion.



CHIMNEY ADAPTERS: 304L Galvalume Inner/Black Outer

5" Class-A Chimney	VP-CA035	VP-CA045
6" Class-A Chimney	VP-CA036	VP-CA046
7" Class-A Chimney	VP-CA037	VP-CA047
8" Class-A Chimney	VP-CA038	VP-CA048



Use when connecting Ventis® Pellet Pipe to Class-A Chimney Single Wall Adapter.

Chimney Adapter fits right into your 5", 6", 7" or 8" Ventis® Class-A Universal Adapter. Smaller end connects directly to 3" or 4" Ventis® Pellet Pipe.

MASONRY ADAPTERS: Galvalume Inner/Black Outer

TYPE	Connects 3" Pellet to 3" flex liner	Connects 4" Pellet to 4" flex liner	Connects 3" Pellet to 4" flex liner
6" Masonry	VP-MA036	VP-MA046	VP-MA036-4
7" Masonry	VP-MA037	VP-MA047	VP-MA037-4
8" Masonry	VP-MA038	VP-MA048	VP-MA038-4



Use when you're doing an installation into an existing masonry chimney.

Masonry Adapter fits into the masonry wall and has a black Trim Plate to cover the hole. Appliance side of the adapter connects directly to pellet vent pipe and the chimney side connects directly to a flex take-off.



DOUBLE WALL BLACK STOVE PIPE

A COOL INNOVATION

Ventis® Double Wall Black Stove Pipe has a thermal web design that allows the air to flow freely between sections. The result is that the entire length of pipe is much cooler. The Smooth-Weld™ Technology and precision end forming that is used in making this product not only give the pipe a pristine look but allows the pipe to fit together tightly. Double Wall Black is backed by Olympia's exclusive Forever Warranty™.

UL Listed to ULC-S641

Manufactured from Heavy Duty 24- Gauge Satin Coat Outer and 430 Stainless Steel Inner

Fume-Free™ ... Eliminating Fumigating Effects on Initial Firing of the Appliance

The Best Selection of Pipe Lengths, Slip Sections, & Telescoping Sections in the Industry

Exclusive Thermal Web™ Design Creates a Free Air Flow that Results in a Cooler Outer Pipe Temperature

Perfectly Round, Perfect Fit Pipe-to-Pipe with Olympia's Smooth-Weld™ and Precision End Forming Technology

Exclusive Forever Warranty™ Transferable to the Next Home Owner

Made in the USA - in Scranton, Pennsylvania





STOVE PIPE: 430

Inner /Satin Coat Steel Outer

LENGTHS	6" DIAMETER	7" DIAMETER	8" DIAMETER
6"	VDB0606	VDB0706	VDB0806
12"	VDB0612	VDB0712	VDB0812
18"	VDB0618	VDB0718	VDB0818
24"	VDB0624	VDB0724	VDB0824
36"	VDB0636	VDB0736	VDB0836
48"	VDB0648	VDB0748	VDB0848



Backed by its Exclusive Thermal Web™ design, Ventis® Double Wall Black Stove Pipe is UL/ULC Listed.

6" clearance to walls,
8" clearance to ceilings.

430 alloy stainless steel inner wall with a .016 thickness.

24-gauge Satin Coat Steel outer wall.

ELBOWS: 430

Inner /Satin Coat Steel Outer

DEGREE	6" DIAMETER	7" DIAMETER	8" DIAMETER
30°	VDB0630F	VDB0730F	VDB0830F
45°	VDB0645F	VDB0745F	VDB0845F
90°	VDB0690F	VDB0790F	VDB0890F



Available in 30,
45 and 90 degree,
non-adjustable styles.

TELESCOPING SECTIONS:

LENGTHS	6" DIAMETER	7" DIAMETER	8" DIAMETER
18" - 30" Small	VDB06ST	VDB07ST	VDB08ST
28" - 50" Medium	VDB06MT	VDB07MT	VDB08MT
40" - 68" Large	VDB06LT	VDB07LT	VDB08LT



Available in 3 convenient lengths to enable you to complete your connection from the stove to almost any application.

Sleek design eliminates the need for time consuming cutting and crimping and allows for ease of adjustment.

SLIP SECTIONS:

LENGTHS	6" DIAMETER	7" DIAMETER	8" DIAMETER
6"	VDB0606SL	VDB0706SL	VDB0806SL
12"	VDB0612SL	VDB0712SL	VDB0812SL
18"	VDB0618SL	VDB0718SL	VDB0818SL



Slides over standard pipe lengths to allow for easy adjustment.

Available in 3 convenient lengths.

ADAPTERS:

TYPE	6" DIAMETER	7" DIAMETER	8" DIAMETER
Masonry	VDB06MA	VDB07MA	VDB08MA
Stove	VDB06SA	VDB07SA	VDB08SA
Single to Double Wall	VSBD6	VSBD7	VSBD8
Double to Single Wall	VDBS6	VDBS7	VDBS8



Masonry Adapter

Stove Adapter

DOUBLE WALL TO SINGLE WALL ADAPTER

Connects Double Wall Black Stove Pipe to Single Wall Black. (Double wall end is male and single wall end is female)

SINGLE WALL TO DOUBLE WALL ADAPTER

Connects Single Wall Black Stove Pipe to Double Wall Black. (Double wall is female and single wall is male)

OVAL TO ROUND ADAPTER:

8" DIAMETER
VDB08OA



8" oval flue outlet to 8" round Ventis® Double Wall Black.

5 3/8" x 9 3/4" inner oval

CLASS-A ADAPTERS

DESCRIPTION	6" DIAMETER	7" DIAMETER	8" DIAMETER
Standard Chimney Adapter	VDB06CA	VDB07CA	VDB08CA



No hole drilling required.

Makes adapting to Class-A Chimney Pipe a breeze.

Use when connecting Ventis® Double Wall Black Stove Pipe to Class-A Chimney Universal Adapter.

Screw Pack	VDB-LGSCREWS
------------	--------------

You must drill holes.

Use to connect to Universal Adapter. Use these screws if you choose not to use the Standard Chimney Adapter. Drill three evenly spaced holes 1" down from the top edge of the pipe with a 3/16" drill bit. Then fasten with these longer screws. Screws are 1 1/4" long.



DAMPER SECTION: 430 inner

DESCRIPTION	6" DIAMETER	7" DIAMETER	8" DIAMETER
Damper	VDB06DS	VDB07DS	VDB08DS



An in-line damper is installed in a 6" length of pipe.

TEE WITH TEE CAP: 430 inner

DESCRIPTION	6" DIAMETER	7" DIAMETER	8" DIAMETER
Tee & Cap	VDB06T	VDB07T	VDB08T



Features a fixed take-off and includes a removable tee cap.

FINISHING BAND: 430 inner

6" DIAMETER	7" DIAMETER	8" DIAMETER
VDB06FB	VDB07FB	VDB08FB



Provides a finished look when attaching Ventis® Double Wall Black Stove Pipe to a Class-A Chimney Pipe at the cathedral support box or wall pass-thru.

CEILING HANGER: 430 inner

6" DIAMETER	7" DIAMETER	8" DIAMETER
VDB06H	VDB07H	VDB08H



Used for long horizontal runs exceeding 8' required to maintain listing.

INCREASERS: 430 Inner /Satin Coat Steel Outer

FROM - TO	MALE END ON	ITEM #
5" - 6"	5"	VDB56
6" - 7"	6"	VDB67
6" - 8"	6"	VDB68
7" - 8"	7"	VDB78



These allow you to adapt to your pipe diameter of choice.

REDUCERS: 430 Inner /Satin Coat Steel Outer

FROM - TO	MALE END ON	ITEM #
7" - 6"	7"	VDB76
8" - 6"	8"	VDB86
8" - 7"	8"	VDB87



These allow you to adapt to your pipe diameter of choice.



SINGLE WALL BLACK STOVE PIPE

Ventis® Single Wall Black Stove Pipe is one of the thickest stove pipes on the market. That's why Olympia can offer a 10-year warranty. Our Smooth-Weld™ Technology means the seams on the Single Wall Black pipe are hardly recognizable and allows our pipe to fit perfectly together.

AN INDUSTRY FIRST

Manufactured from Heavy Duty, 22 Gauge, Cold-Rolled Steel

Fume-Free™ Finish Eliminates The Smell on Initial Firing

Our Finish Process Also Gives Our Pipe a Scratch Resistant Finish!

Rust-Free: No Need to Hide Rusty Pipes. Install Ventis® Black with Pride!

Perfectly Round, Perfect Fit Pipe-to-Pipe with Olympia's Smooth-Weld™ and Precision End Forming Technology

The Best Selection of Telescoping Sections in the Industry

The Industry's First Slip Connector with Gap Collar™

Ten Year Limited Warranty

Made in the USA - in Scranton, Pennsylvania





STOVE PIPE: 22 gauge Cold Rolled Steel

LENGTHS	6" DIAMETER	7" DIAMETER	8" DIAMETER
6"	VSB0606	VSB0706	VSB0806
12"	VSB0612	VSB0712	VSB0812
18"	VSB0618	VSB0718	VSB0818
24"	VSB0624	VSB0724	VSB0824
36"	VSB0636	VSB0736	VSB0836
48"	VSB0648	VSB0748	VSB0848



Never smell those toxic fumes on initial firing again!

22 gauge, heavy-duty, cold-rolled steel with a Fume-Free™ finish.

The smooth-welding and forming technology used means a perfect fit every time!

These industry first features apply to all components as well.

ELBOWS: Adjustable

DEGREE	6" DIAMETER	7" DIAMETER	8" DIAMETER
45°	VSB0645A	VSB0745A	VSB0845A
90°	VSB0690A	VSB0790A	VSB0890A



Available in adjustable and fixed.

The adjustable elbows will adjust with ease, but will never come apart at the seams.

The fixed elbows are durable and will NEVER leak!

Both styles are available in 45° and 90°.

ELBOW: Fixed / Non-Adjustable

DEGREE	6" DIAMETER	7" DIAMETER	8" DIAMETER
45°	VSB0645F	VSB0745F	VSB0845F
90°	VSB0690F	VSB0790F	VSB0890F

SLIP CONNECTOR WITH GAP COLLAR

LENGTHS	6" DIAMETER	7" DIAMETER	8" DIAMETER
2" - 16"	VSB06SL	VSB07SL	VSB08SL



Use to prevent having to perform the nasty task of cutting pipe to the exact size.

Olympia has solved the unsightly, leaky gap problem with only slip connector in the industry that has a Gap Collar™.

Comes with Gap Collar™. It does not have to be ordered separately.

18" Length and adjustments 4" to 16".

SINGLE WALL BLACK HEAT SHIELD:

LENGTHS	ITEM #
6" - 8" 35" Length	VSB58HS



Reduce your required single wall clearances from 18" to 6" to the wall and 9" to the ceiling.

Comes with ceramic spacers and screws to promote easy installation.

VENTIS

SINGLE WALL BLACK STOVE PIPE

TELESCOPING SECTIONS:

22 gauge Cold Rolled Steel

LENGTH	6" DIAMETER	7" DIAMETER	8" DIAMETER
18" - 30" Small	VSB06ST	VSB07ST	VSB08ST
38" - 70" Large	VSB06LT	VSB07LT	VSB08LT

Similar to slip connectors, these telescoping lengths eliminate time consuming cutting and crimping. These lengths will adjust with ease for a perfect fit.

Two sizes available; small adjusts 18" - 30" and large adjusts 38" - 70". How about that for selection!

WALL TRIM COLLAR:

22 gauge Cold Rolled Steel

6" DIAMETER	7" DIAMETER	8" DIAMETER
VSB06WTC	VSB07WTC	VSB08WTC

To complete the stove pipe installation, use this Wall Trim Collar to give your job the finishing touch it deserves.

The outside diameter is 6" larger than the inside diameter.

ADAPTERS: 22 gauge Cold Rolled Steel

TYPE	6" DIAMETER	7" DIAMETER	8" DIAMETER
Straight Oval to Round	—	—	VSBOAS
Offset Oval to Round	—	—	VSBOAO
Male to Male	VSB06MM	VSB07MM	VSB08MM
Single to Double Wall Adapter	VSD6	VSD7	VSD8
Double to Single Wall Adapter	VDS6	VDS7	VDS8

OVAL TO ROUND STOVE ADAPTERS

Offset Adapter is 9½" high.
Straight Adapter is 11½" high.

Both adapters have an oval male end 5¾" x 9¾". The round female end accepts our 8" stove pipe.

Use to connect 8" stove pipe to some Vermont Casting Stoves with an oval flue collar.

DOUBLE MALE ADAPTER
6" long adapter with both ends male for masonry thimble applications.

DOUBLE WALL TO SINGLE WALL ADAPTER
Connects Double Wall Black Stove Pipe to Single Wall Black.
(Double wall end is male and single wall end is female)

SINGLE WALL TO DOUBLE WALL ADAPTER
Connects Single Wall Black Stove Pipe to Double Wall Black.
(Double wall is female and single wall is male)

BAROMETRIC DAMPER:

6" DIAMETER	7" DIAMETER	8" DIAMETER
DB6T	DB7T	DB8T

Automatic operation and an adjustment on the flapper so that you can get perfect draft for your heating appliance.

Comes in 6" - 8" diameters and easily installs on a tee.

Gas or oil versions available.

Use to stabilize draft by drawing room air into the flue.



TEE AND TEE CAP: 22 gauge Cold Rolled Steel

DESCRIPTION	6" DIAMETER	7" DIAMETER	8" DIAMETER
Tee	VSB06T	VSB07T	VSB08T
Tee Cap	VSB06TC	VSB07TC	VSB08TC



This tee is butt-welded and has a fixed snout.

Snout not crimped.

INCREASERS: 22 gauge Cold Rolled Steel

FROM - TO	MALE END ON	ITEM #
5" - 6"	5"	VSB56
6" - 7"	6"	VSB67
6" - 8"	6"	VSB68
7" - 8"	7"	VSB78

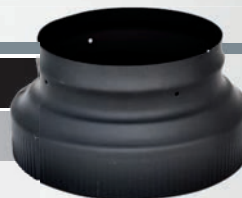

These Free-Flow™ Increasers allow you to adapt to your pipe of choice!

REDUCERS: 22 gauge Cold Rolled Steel

FROM - TO	MALE END ON	ITEM #
7" - 6"	7"	VSB76
8" - 6"	8"	VSB86
8" - 7"	8"	VSB87



These Free-Flow™ Reducers allow you to adapt to your pipe of choice!

STOVE DAMPERS:

MATERIAL	6" DIAMETER	7" DIAMETER	8" DIAMETER
Cast Iron	DSP6	DSP7	DSP8



Use in the center of single wall stove pipe. Just drill two 1/4 inch holes and it installs in seconds!



DIRECT VENT PELLETT

A DUAL PURPOSE SYSTEM



Olympia's Direct Vent Pellet is Manufactured, Listed, and Tested to Exhaust Gas or Pellet Fired Appliances

Listed by UL to ULC/ORD-C441 for Pellet Vent Applications with a 1" Clearance to Combustibles

The Outer Vent Pipe Supplies Warmed Outside Air to the Pellet Stove for Combustion. The Warmed Outside Air Increases the Stoves Efficiency.

Drawing Fresh Air Through the Outer Pipe Eliminates the Need for an Unsightly Flexible Fresh Air Pipe

Uses the Same Pipe Lengths, Connections, and Gaskets as Ventis® Direct Vent. This Enables the Sharing of Gas and Pellet Vent Systems and a Reduction in Inventory.

Made in the USA - in Scranton, Pennsylvania

TERMINATION KITS

Straight Out Horizontal Termination Kit (VDP-HSK04)

Up & Out Horizontal Termination Kit (VDP-HUK04)

Vertical Termination Kit (VDP-VK04)



Up & Out Horizontal Termination Kit



Manufactured by
LYMPIA
CHIMNEY SUPPLY Inc.

"Your Partner in the Business"

POWDER COATING



AVAILABLE COLORS

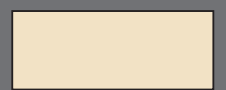

Ivory



Tan

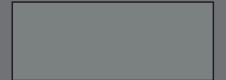

Grey

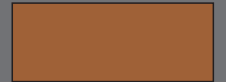

Copper

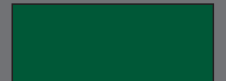

Green



Bronze

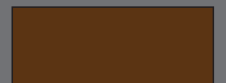

Brown

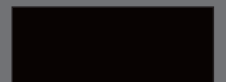

Black

POWDER COATING is NOW available on all caps, chase covers, Ventis® CLASS-A, Ventis® Direct Vent and Ventis® Air-Cooled. This process will not only add durability to the finish of the product, but with eight stylish colors to choose from, we can compliment any home aesthetic.



CLASS-A



DIRECT VENT



AIR-COOLED

CHIMNEY CAPS AND CHASE COVERS



