

**hilmar**<sup>™</sup>  
**RETOOL + CONQUER**<sup>™</sup>

**PRODUCT CATALOG**

The work takes you from superheat to freezing cold. And requires you get really comfortable in the dark, dirty and downright cramped. You gotta find a way to keep your cool even when the customer has been without hers for 27 hours. The tools in your truck are the only help you've got. And that's the kicker. Because while the work keeps getting more complex, the tools haven't evolved much at all. UNTIL NOW.

**hilmor**<sup>™</sup>  
**RETOOL + CONQUER**<sup>™</sup>

301 Chestnut Street  
East Longmeadow, MA 01028  
1-800-628-8810  
[hilmor.com](http://hilmor.com)

---

At hilmor, we're revolutionizing the HVAC/R world by creating tools that are a step ahead. Every tool we make is designed to give you all the features you need and none of the ones you don't. We're determined to deliver smart, innovative solutions when and where you need them most. So, you'll be fully equipped to retool and conquer.

---

## TABLE OF CONTENTS

### ELECTRONIC TOOLS

Electronic Tools Family	1-2
Electronic Gauge with Vacuum Sensor	3-8
Dual Readout Thermometer	9-11
Thermocouple Clamps	12

### MANIFOLDS

Manifold Family	13-16
4-Valve Aluminum Manifold	17-20
2-Valve Aluminum Manifold	21-22
2-Valve Basic Manifold	23-24

### GAUGES

Gauge Family	25
Analog Gauges	26

### HOSES

Hoses Family	27
Hoses	28
60" Refrigeration Hoses	29
Low-Loss Ball Valve Adapters	30

### BENDING TOOLS

Bender Family	31-32
Compact Bender Kit	33-36
Lever Benders	37-38
Tri-Tube Benders	39
Spring Benders	40

### FLARING TOOLS

Flare Family	41-42
Quick-Engage Flare and Swage Kit	43-46
Orbital Flare	47
Basic Flare	48
Large Basic Flare	49
Large Flare/Swage	50

### SWAGING TOOLS

Swage Family	51-52
Compact Swage Tool	53-56
Punch Swage Set	57
Multi-Swage Punch	58

### SERVICE TOOLS

Magnetic Nut Drivers Family	59
Magnetic Nut Drivers	60-62
Quick-Change Magnetic Nut Driver	63-64
9-in-1 Multi-Tool	65
Service Wrenches	66
Inspection Mirror	67
Deburrer	67
Hex Key Sets	68

### WORKSITE STORAGE

Worksite Storage Family	69
HVAC/R Tote	70
Backpack Bag	71-72
Tool Center Bag	73
Zipper Pouch	74
Manifold Cover	74

### WARRANTY/PRESSURE TEMPERATURE CHART

Warranty	75
Pressure Temperature Chart	76



# ALL THE BELLS AND WHISTLES WITHOUT THE UNNECESSARY CRAP.

From gauges to thermometers to thermocouple clamps, hilmor has retooled some of your most important on-the-job necessities. We've added the features you need. We've lost the ones you don't. Our products are innovative, simplified and built to help you conquer any job. Make sure to explore our Electronic Gauge with Vacuum Sensor - it's one of hilmor's most advanced and streamlined products available.





# WHY BUY A HYBRID GAUGE? LET'S START WITH THAT FLASHLIGHT IN YOUR MOUTH.

<p>Get out of the dark ages with the industry's first hybrid gauge featuring backlit displays. hilmor's Electronic Gauge with Vacuum Sensor offers true analog capabilities with unmatched digital precision. All within 1% accuracy.</p>	<p>+ </p>	<p><b>Lighten The Load</b> More built-in features including P/T data for 39 refrigerants, dual temperature readings and a micron-gauge save you time, money and trips to the truck.</p>
	<p>+ x2</p>	<p><b>Twice The Confidence</b> Outer gauges have a real needle to show system pressure and LSAT/VSAT temperatures, while an inner LCD displays pressures, temperatures and calculated superheat and subcooling.</p>
	<p>+ </p>	<p><b>Improved Accuracy</b> Self-calibrating gauges provide 1% accuracy every time the gauges are turned on.</p>

See all the innovations you can put to work at [hilmor.com](http://hilmor.com).



Electronic Gauge  
with Vacuum Sensor  
1839105

**hilmer**™ **RETOOL + CONQUER**™





x2





# ELECTRONIC GAUGE WITH VACUUM SENSOR



## Lighten The Load

More built-in features including P/T data for 39 refrigerants, dual temperature readings and a micron-gauge save you time, money and trips to the truck.



## Twice The Confidence

Outer gauges have a real needle to show system pressure and LSAT/VSAT temperatures, while an inner LCD displays pressures, temperatures and calculated superheat and subcooling.



## Improved Accuracy

Self-calibrating gauges provide 1% accuracy every time the gauges are turned on.



## Easy To Use

Just turn it on, and select your refrigerant. It automatically detects vacuum and displays numerically and graphically.



## Quick Identification

Outer gauge faces change color to coordinate with the selected refrigerant.



## Rugged & Durable

A high-impact boot means dropping it won't ruin your day.



## Easy To Maintain

A cleanable vacuum sensor is integrated right into the tool.



Easy-to-read LCD displays temperature, pressure, plus superheat and subcool calculations.



It's as simple as turn it on, select a refrigerant and get on with the job. No confusing menus to scroll through.



# ELECTRONIC GAUGE WITH VACUUM SENSOR



## Quick Identification

Outer gauge faces change color to coordinate with the selected refrigerant.



## Rugged & Durable

A high-impact protective boot means dropping it won't ruin your day.



## Easy To Use

Just turn it on, and select your refrigerant. It automatically detects vacuum and displays numerically and graphically.



## Easy To Maintain

A cleanable vacuum sensor is integrated right into the tool.

## Refrigerant List

Includes the following 39 refrigerants and more available by download. Top 10 refrigerants display first.

R 11	R 402B	R 422A
R 12	R 404A	R 422B
R 13	R 406A	(NU22B)
R 22	R 407A	R 422C
R 23	R 407C	(Oneshot)
R 113	R 408A	R 422D
R 114	R 409A	R 424A
R 123	R 410A	R 434A
R 124	R 414B	(RS-45)
R 125	(Hotshot)	R 438A
R 134A	R 416A	(M099)
R 401A	R 417A	R 500
(MP39)	R 420A	R 502A
R 401B	R 421A	R 503
R 402A	R 421B	R 507A

Press and hold center knob for two seconds to change refrigerant. Turn knob. Press to select.

## Item Specifications

Item Number	1839104	1839105
Product Description	EG1 Without Hoses	EG1H With Hoses
Refrigerants	List of 39 refrigerants (see left)	
Display Size	3-1/4" Diagonal	
Batteries	AA x 4 (included)	
Battery Life	24 hours of continuous use	
Low Battery Indicator	LO BATT displays when not enough power to function	
Volume	Mute by pressing mute symbol; mute icon displays on screen	
Updates	In field with USB interface located in battery compartment	
Auto Shutoff	After 20 minutes of inactivity (no button pushes) deactivate	
Thermocouple Connector Type	K	
Hoses Included	N/A	1839143 H60BVS4 Hose 60" Ball Valve - Set of 4

Measurement	Range	Resolution	Accuracy
Pressure	0 to 800 psi	0.1 psi	1% accuracy
Vacuum	50 to 9999 microns	1 micron	+-10dgt/1
Temperature	-76°F to 999.9°F	0.1°F/C	+-2°C

Maximum Overload Pressure	1000 psi
---------------------------	----------

Operating Temperature	-10°C to +50°C (LCD)
-----------------------	----------------------

## Product Dimensions

Length	8-7/8"
Width	4"
Height	8-1/4"
Weight	4.25 lbs

ONE TOOL. ZERO TRIPS BACK  
TO THE TRUCK. GET USED TO  
**SIMPLE MATH.**

Keep your cool in any climate  
with quick and easy calculations.  
hilmor's Dual Readout Thermometer  
is the industry's first to offer two  
digital readouts to help simplify the  
calculation of superheat and subcool.  
And it attaches to any manifold.



**Makes Calculations Easier**

The industry's only manifold-compatible compact thermometer with two readings to help simplify the calculation of superheat and subcool.



**Superior Versatility**

Use it on any gauge set, or remove it and use it independently.



**Reads Temperatures Quickly**

Two easy-to-use, K-style pipe clamp thermocouples get you to the temperature reading quickly.

See all the innovations you can put to work at [hilmor.com](http://hilmor.com).



Dual Readout  
Thermometer  
1839106

**hilmer**™ **RETOOL + CONQUER**™

# DUAL READOUT THERMOMETER



## Makes Calculations Easier

The industry's only manifold-compatible compact thermometer with two readings to help simplify the calculation of superheat and subcool.



## Superior Versatility

Use it on any gauge set, or remove it and use it independently.



## Reads Temperatures Quickly

Two easy-to-use, K-style tube clamp thermocouples get you to the temperature reading quickly.

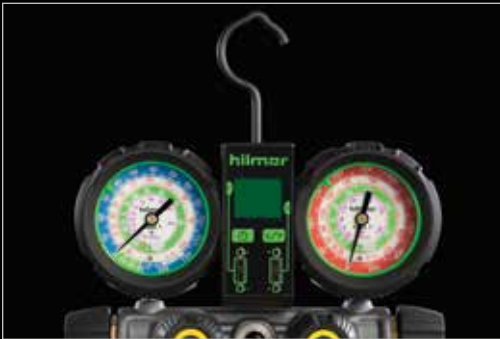

This thermometer is the first in the industry to attach to any manifold.

## Item Specifications

Item Number	1839106		
Product Description	DROT2TCC		
Thermocouples Included	1839108 TCC Thermocouple Clamps		
Batteries	AA x 1 (included)		
Battery Life	151 hours		
Connection Type	K		
Measurement	Range	Resolution	Accuracy
Temperature	-76°F to 999.9°F	0.1° F/C	±2.0°C
Operating Temperature Range		-10°C to +50°C (LCD)	
Product Dimensions			
Length	1-3/4"		
Width	1-5/8"		
Height	3-7/8"		
Weight	.7 lbs		



Dual Readout Thermometer  
1839106



# THERMOCOUPLE CLAMPS

Get right to it on up to 1-1/8" tubing with hilmor's Thermocouple Clamps. K-style connections offer a secure fit and are easy to use with other devices. This set is a perfect pairing for the hilmor Dual Readout Thermometer. When the job is done, it's easy to stow them away. Simply wrap the thermocouple wire around the handles, and secure the plug into the clamp.



## Fast, Precise, Readings

Gets right to the temperature reading up to 1-1/8" tubing.



## Secure Connections

K-style connections provide a tight fit and easy use with other devices.



## Secure Storage

Stow it away simply by wrapping the thermocouple wire around the clamp and securing the plug.



Protect the thermocouple plug when not in use by wrapping the cord around the handle and plugging into the side socket.

## Item Specifications

Item Number	1839108
Product Description	TCC
Connection Type	K
Accuracy	+/-2.0°C
Operating Temperature (plastic)	-40°F to 250°F

## Product Dimensions

Lead wire length	36"
Length	5-1/4"
Width	7/8"
Height	3-1/4"
Weight	.175 lbs



Attach K-style clamps to an easily accessible spot on the hilmor manifold.



K-style clamps securely attach to tubing up to 1-1/8" for measurements on the double.



Thermocouple Clamp  
1839108

# BUILT TO HANDLE ANY CLIMATE THROWN THEIR WAY.



Manifolds operate as your sidekick on every job. They need to be durable. They need to not leak. They need to excel in even the most extreme conditions. The hilmor line of Manifolds is ready to be put to work with replaceable stainless steel valve seats and SAE-style O-rings. The list of features goes on and on, but the one that matters most is their ability to withstand all the pressures you encounter — day in and day out.



**RUGGED, DURABLE AND BUILT  
FOR PRESSURE. IT'S TIME YOU MET  
YOUR TWIN.**

Introducing hilmor's ruggedly durable Aluminum Manifolds, featuring a forged aluminum body, easy-to-read gauges and high-impact boots. Finally, a manifold built to handle anything thrown its way. We're sure you can relate.



**Easy To Read**

Improved graphics and high-contrast colors for precise readings.



**Quick On The Job**

Get faster vacuum pulls with a true 3/8" bore.



**Comfort Grip**

Rubberized handles are optimally sized for easy turns.

See all the innovations you can put to work at [hilmor.com](http://hilmor.com).





4-Valve Aluminum Manifold  
with 60" Hoses  
1839120

**hilmer**™ **RETOOL + CONQUER**™

# 4-VALVE ALUMINUM MANIFOLD WITH 60" HOSES

## Item Specifications

Item Number/Product Description					
Refrigerants	With 60" Hoses and Low-Loss Ball Valve Adapters	Without Hoses	Temp.	Pressure Range Low	Pressure Range High
R410A	1839109 4V410H	1839111 4V410	F/C	-30" HG/300/ 500 psi	0/800 psi
R12-22-502A	1839115 4V1222502H	1839117 4V1222502	F	-30" HG/120/ 350 psi	0/500 psi
R12-22-134A	1839120 4V1222134H	1839121 4V1222134	F	-30" HG/120/ 350 psi	0/500 psi
R22-134A-404A	1839122 4V22134404H	1839124 4V22134404	F	-30" HG/120/ 350 psi	0/500 psi
HP22-407C-410A	1839128 4V22407410H	1839129 4V22407410	F	0/800 psi	0/800 psi
R22-404A-410A	1839130 4V22404410H	1839132 4V22404410	F	-30" HG/300/ 500 psi	0/800 psi
R134A-404A-407C	1839135 4V134404407H	1839137 4V134404407	F	-30" HG/120/ 350 psi	0/500 psi
Accuracy	Class 1 - 1% Accuracy (full scale)				
Gauge Connection Type	1/8" NPT Male Fitting				
Valve Type	Double O-ring Piston Style				
Valve Seat (Orifice)	Replaceable Stainless Steel (SAE-style straight thread with O-ring)				
Sight Glass	Bonded steel with SAE-style straight thread with O-ring				
Vacuum Port	3/8" full bore (quantity 1)				
Charge Ports	1/4" (quantity 3)				
Hoses Included	1839143 H60BVS4 60" Hoses with Low-Loss Ball Valve Adapters - Set of 4				
Product Dimensions					
Length	8-7/8"		8-7/8"		
Width	4"		4"		
Height	7-1/8" without hook		7-1/8" without hook		
Weight	7.05 lbs		3.40 lbs		



# 4-VALVE ALUMINUM MANIFOLD

We know that manifolds are your lifeline. So, when we decided to retool the features and design, we were meticulous down to the last detail.



## Extra Confidence

Built to last with a forged aluminum body. Designed to be leak-resistant with replaceable stainless steel valve seats, SAE-style O-rings and a securely seated, large sight glass.



## Quick On The Job

Get faster vacuum pulls with a true 3/8" bore throughout the valve.



Rubberized handles are optimally sized for quick and painless turns.



Front-mounted hose positions give you easier access.



4-Valve Aluminum Manifold  
1839120



4-Valve Aluminum Manifold  
with Hoses & Dual Readout  
Thermometer  
1839116

# 4-VALVE ALUMINUM MANIFOLD WITH HOSES & DUAL READOUT THERMOMETER

## Item Specifications

Item Number/Product Description						
Refrigerants	With 60" Hoses and Low-Loss Ball Valve Adapters		Temp.	Pressure Range Low	Pressure Range High	
R410A	1839110	4V410HD	F/C	-30" HG/300/500 psi	0/800 psi	
R12-22-502A	1839116	4V1222502HD	F	-30" HG/120/350 psi	0/500 psi	
R22-134A-404A	1839123	4V221344404HD	F	-30" HG/120/350 psi	0/500 psi	
R22-404A-410A	1839131	4V22404410HD	F	-30" HG/300/500 psi	0/800 psi	
R134A-404A-407C	1839136	4V134404407HD	F	-30" HG/120/350 psi	0/500 psi	

Accuracy	Class 1 - 1% Accuracy (full scale)
Gauge Connection Type	1/8" NPT Male Fitting
Valve Type	Double O-ring Piston Style
Valve Seat (Orifice)	Replaceable Stainless Steel (SAE-style straight thread with O-ring)
Sight Glass	Bonded steel with SAE-style straight thread with O-ring
Vacuum Port	3/8" full bore (quantity 1)
Charge Ports	1/4" (quantity 3)
Hoses Included	1839143 H60BVS4 60" Hoses with Low-Loss Ball Valve Adapters - Set of 4
Thermometer Included	1839106 DROT2TCC Dual Readout Thermometer with 2 Thermocouple Clamps
Thermocouples Included	1839108 2 TCC Thermocouple Clamps

### Product Dimensions

Length	8-7/8"
Width	4"
Height	7-1/8" without hook
Weight	7.30 lbs



# 2-VALVE ALUMINUM MANIFOLD

The rough and tumble durability of our 4-Valve with the simplicity of a 2-Valve design.



## Extra Confidence

Built to last with a forged aluminum body. Designed to be leak-resistant with replaceable stainless steel valve seats, SAE-style O-rings and a securely seated, large sight glass.



## Comfort Grip

Offers easy access with front-mounted hose positions and a permanent location for temperature clamps.



A permanent location for the temperature clamps offers quick and convenient storage.



With a forged aluminum body, it can stand up to the roughest, toughest conditions.



Rubberized handles are optimally sized for easy turns.



2-Valve Aluminum Manifold  
1839118

## Item Specifications

Item Number/Product Description						
Refrigerants	Without 60" Hoses and Low-Loss Ball Valve Adapters		Temp.	Pressure Range Low	Pressure Range High	
R410A	1839113	2V410	F/C	-30" HG/300/500 psi	0/800 psi	
R12-22-502A	1839118	2V1222502	F	-30" HG/120/350 psi	0/500 psi	
R22-134A-404A	1839126	2V22134404	F	-30" HG/120/350 psi	0/500 psi	
R22-404A-410A	1839134	2V22404410	F	-30" HG/300/500 psi	0/800 psi	
R134A-404A-407C	1839139	2V134404407	F	-30" HG/120/350 psi	0/500 psi	
Accuracy		Class 1 - 1% Accuracy (full scale)				
Gauge Connection Type		1/8" NPT Male Fitting				
Valve Type		Double O-ring Piston Style				
Valve Seat (Orifice)		Replaceable Stainless Steel (SAE-style straight thread with O-ring)				
Sight Glass		Bonded Steel with SAE-style straight thread with O-ring				
Charge Ports		1/4" (quantity 3)				
Product Dimensions						
Length		8-7/8"				
Width		1-3/4"				
Height		7-1/8" without hook				
Weight		2.45 lbs				

# 2-VALVE BASIC MANIFOLD

The hilmor 2-Valve Basic Manifold with 60" Hoses provides all the features you've come to expect from a standard manifold, and then some. It has a durable design, improved accessibility and smart functionality.

The gauges have been optimized for greater 3-1/8" readability with improved graphics, high-contrast color and glow-in-the-dark functionality. Sold with hilmor 60" hoses.



Front-mounted hose positions give you easier access.



## Easy To Read

Improved graphics and high-contrast colors deliver precise readings at a glance.



## Glow In The Dark

Light-activated paint illuminates, so you won't be left in the dark.



## Comfort Grip

Rubberized handles are optimally sized for easy turns.



## Superior Protection

Hoses have an extra abrasion-resistant layer for the tough environments of HVAC/R.



## Handles High Pressure

Rated for 800 PSI working pressure to work with high-pressure refrigerants.



2-Valve Basic Manifold  
1839119



## Item Specifications

Item Number/Product Description					
Refrigerants	With 60" Hoses		Temp.	Pressure Range Low	Pressure Range High
R410A	1839114	2VB410H	F/C	-30" HG/300/500 psi	0/800 psi
R12-22-502A	1839119	2VB1222502H	F	-30" HG/120/350 psi	0/500 psi
R22-134A-404A	1839127	2VB22134404H	F	-30" HG/120/350 psi	0/500 psi
Accuracy	Class 1 - 1% Accuracy (full scale)				
Gauge Connection Type	1/8" NPT Male Fitting				
Valve Type	Double O-ring Piston Style				
Charge Ports	1/4" (quantity 3)				
Hoses Included	1839153 H60S3 Hose 60" - Set of 3				
Product Dimensions					
Length	7-9/32"				
Width	3"				
Height	6"				
Weight	3.9 lbs				

# FINALLY, THE BRAINS OF YOUR OPERATION CAN TAKE A BUMP TO THE HEAD.



Analog Gauge  
1839086



Analog Gauge  
1839087

# ANALOG GAUGES

You need accurate readings, and you need them at a glance. hilmor gauges were made for just that. Simply choose the gauge you need, and put it to work.



### Easy To Read

Improved graphics and high-contrast colors deliver precise readings at a glance.



### Rugged & Durable

High-impact protective boots mean dropping it won't ruin your day.



Forget the flashlight. These gauges are equipped with glow-in-the-dark capabilities.



A pressure reminder allows you to set the pressure ring and reference it later.

## Item Specifications

Item Number/Product Description					
Refrigerants	Low-side (Blue)	Pressure Range	High-side (Red)	Temp.	Pressure Range
R410A	1839082 AG410L	-30" HG/300/500 psi	1839083 AG410H	F/C	0/800 psi
R12-22-502A	1839084 AG1222502L	-30" HG/120/350 psi	1839085 AG1222502H	F	0/500 psi
R12-22-134A	1839086 AG1222134L	-30" HG/120/350 psi	1839087 AG1222134H	F	0/500 psi
R22-134A-404A	1839088 AG22134404L	-30" HG/120/350 psi	1839089 AG22134404H	F	0/500 psi
HP22-407C-410A	1839090 AG22407410L	0/800 psi	1839091 AG22407410H	F	0/800 psi
R22-404A-410A	1839092 AG22404410L	-30" HG/300/500 psi	1839093 AG22404410H	F	0/800 psi
R134A-404A-407C	1839094 AG134404407L	-30" HG/120/350 psi	1839095 AG134404407H	F	0/500 psi
Accuracy	Class 1 - 1% Accuracy (full scale)				
Size	3-1/8" (80mm) Gauge				
Fitting	1/8" NPT Male connection				
Included Parts	Protective boot and dial indicator ring				
Product Dimensions					
Depth	1.71875"				
Diameter	3.625"				
Weight	0.4 lbs				

# THIS JOB TAKES SOME THICK SKIN. LUCKILY, OUR HOSES HAVE IT.



60" Refrigeration Hoses  
1839143

If you can stand the pressure, your hoses should, too. We've rethought and retooled the hoses you use every day with smart features like an extra abrasion-resistant layer for superior protection in tough conditions. All of our Hoses are rated for 800 PSI working pressure to work with the newest high-pressure refrigerants. Simply select the Hose and Ball Valves you need. You can choose from Hoses and Ball Valve Adapters individually, or buy them as a set.

# HOSES

hilmor 36" and 60" Hoses are designed with smart features including an extra abrasion-resistant layer for tough environments.



### Superior Protection

An extra abrasion-resistant layer for the tough environments of HVAC/R.



### Handles High Pressure

Rated for 800 PSI working pressure to work with high-pressure refrigerants.



36" Vacuum Hose  
1839159

## Item Specifications

### 60" Hoses

Item Number	Description	Diameter
1839150	H60R Hose 60" - Red	1/4"
1839151	H60B Hose 60" - Blue	1/4"
1839152	H60Y Hose 60" - Yellow	1/4"
1839153	H60S3 Hose 60" - Set of 3	1/4"
1839154	H6038 Hose 60" - Black - Vacuum	3/8"

Maximum Allowable

Working Pressure 800 PSI

Burst Pressure 4000 PSI

Operating Temperature -20°F to +180°F

End Connection Straight by 45 degree

### Product Dimensions

Length 60"  
Weight .625 lbs

### 36" Hoses

Item Number	Description	Diameter
1839155	H36R Hose 36" - Red	1/4"
1839156	H36B Hose 36" - Blue	1/4"
1839157	H36Y Hose 36" - Yellow	1/4"
1839158	H36S3 Hose 36" - Set of 3	1/4"
1839159	H3638 Hose 36" - Vacuum	3/8"

Maximum Allowable

Working Pressure 800 PSI

Burst Pressure 4000 PSI

Operating Temperature -20°F to +180°F

End Connection Straight by 45 degree

### Product Dimensions

Length 36"  
Weight .38 lbs

# 60" REFRIGERATION HOSES WITH LOW-LOSS BALL VALVE ADAPTERS

Rated for 800 PSI working pressure to work with high-pressure refrigerants.



## Superior Protection

An extra abrasion-resistant layer for the tough environments of HVAC/R.

## Item Specifications

Item Number	Description	Diameter
1839140	H60BVR Hose 60" - Ball Valve - Red	1/4"
1839141	H60BVB Hose 60" - Ball Valve - Blue	1/4"
1839142	H60BVY Hose 60" - Ball Valve - Yellow	1/4"
1839143	H60BVS4 Hose 60" - Ball Valve - Set of 4	1/4" & 3/8"
1839144	H60BV38 Hose 60" - Ball Valve - 3/8" VAC Black - Vacuum	3/8"

Maximum Allowable Working Pressure 800 PSI

Burst Pressure 4000 PSI

Operating Temperature -20°F to +180°F

Hoses End Connection Straight by Straight

Ball Valve End Connection Straight by 45 degree

## Product Dimensions

Length 70-1/2"

Weight 1.1 lbs



60" Refrigeration Hoses with Low-Loss Ball Valve Adapters  
1839140, 1839141, 1839142



# LOW-LOSS BALL VALVE ADAPTERS

We all know that controlling refrigerant loss on the jobsite is a big deal. And the hilmor Low-Loss Ball Valve Adapter is here to help. It is designed with an extra 6" of hose for additional length.



### Superior Protection

An extra abrasion-resistant layer for the tough environments of HVAC/R.



### Handles High Pressure

Rated for 800 PSI working pressure to work with high-pressure refrigerants.



Knob turns quickly and easily to restrict flow from hoses.

## Item Specifications

Item Number	Description	Diameter
1839145	BVR Ball Valve Adapter - Red	1/4"
1839146	BVB Ball Valve Adapter - Blue	1/4"
1839147	BVY Ball Valve Adapter - Yellow	1/4"
1839148	BVS Ball Valve Adapters - Set of 3	1/4"
1839149	BV38 Ball Valve Adapter - Black - Vacuum	3/8"

Maximum Allowable Working Pressure

800 PSI

Burst Pressure

4000 PSI

Operating Temperature

-20°F to +180°F

End Connection

Straight by 45 degree

## Product Dimensions

Length

8"

Weight

.255 lbs



Low-Loss Ball Valve Adapters  
1839145, 1839146, 1839147, 1839149

# IT TAKES BRAINS AND BRAWN TO BEND TUBES.



Quality bends on the job are a necessity. Unfortunately, so are the headaches that come with them. Not anymore. All of our bending tools are intelligently designed to give you more power and more control, resulting in a precision bend you're proud to show off. Choose the bending tool that fits your needs, and get ready to conquer your job - one precisely bent tube at a time.



# YOUR NEW BAR BET: BENDING PIPES WITH **ONE HAND.**

The hilmor Compact Bender uses smart and simple features like a spring-loaded ratcheting lever to knock out a 90-degree bend without breaking a sweat. And a quick-release button allows you to free the tube with ease - and without damage - so you can keep your cool no matter what the climate.



#### Simple Setup

Universal crossbar and color-coded mandrels make identifying and changing sizes quick and easy.



#### One-handed Operation

A ratcheting mechanism and innovative release lever allow for bending with one hand.



#### Small Space Capable

A compact design allows it to fit where others can't.

See all the innovations you can put to work at [hilmor.com](http://hilmor.com).



Compact Bender Kit  
1839032

**hilmer**™ **RETOOL + CONQUER**™





Color-coded shoes make identifying the correct tube size quick and easy.

# COMPACT BENDER KIT

## Kit Contents

Body and crossbar for 1/4" to 7/8", 1/4", 5/16", 3/8", 1/2", 5/8", 3/4" and 7/8" mandrels



## Item Specifications

Item Number	1839032
Product Description	CBK
Tube Sizes (O.D.)	1/4", 5/16", 3/8", 1/2", 5/8", 3/4", 7/8"

### Product Dimensions

Length	13.40"
Width	9.71"
Height	3.15"
Weight	7.25 lbs

### Replacement Parts

Description	Size	Bend Radius	Item Number
CBB Body	N/A	N/A	1839033
CBR Bar for 1/4" - 7/8"	N/A	N/A	1839034
CBM14 Mandrel	1/4"	1.25"	1839035
CBM516 Mandrel	5/16"	12.2"	1839036
CBM38 Mandrel	3/8"	1.15"	1839037
CBM12 Mandrel	1/2"	1.1"	1839038
CBM58 Mandrel	5/8"	1.55"	1839039
CBM34 Mandrel	3/4"	2.3"	1839040
CBM78 Mandrel	7/8"	2.75"	1839041

Tube Materials	Soft Tubing Only Copper, Steel, Aluminum, Brass
----------------	--



A ratcheting lever gives you the brawn to bend tubes with one hand.



A quick-release button allows you to free the tube with ease and without damage.



A locking slider keeps the bender compact for storage and transport.

# LEVER BENDERS

You need a tool that can give you a precise bend every time. The Hilmer Lever Bender can do just that. It's designed with markings to help you center the tube correctly.



### Simple Setup

A spring-loaded tube holding mechanism securely holds the tube in place.



### Precise Angles

Markings on the side help create up to 180° bends.



### More Leverage, More Bends

Can be placed into a vise for multiple bends or for extra leverage.

## Item Specifications

Item Numbers	1839028	1839029	1839030
Product Descriptions	LB58	LB34	LB78
Tube Sizes (O.D.)	5/8"	3/4"	7/8"
Tube Sizes (O.D.)	16 mm	19 mm	22 mm
<b>Product Dimensions</b>			
Length	29"	32.35"	34.5"
Width	4.3125"	5.5"	5.75"
Height	3.75"	4"	4.25"
Weight	5.6 lbs	6.6 lbs	7.7 lbs
Tube Materials	Soft Tubing Only Copper, Steel, Aluminum, Brass		
Bend Radius	2.25"	3"	3.25"



Lever Bender  
1839028



Stainless steel rollers reduce friction against the tube.



A spring-loaded mechanism helps to securely hold the tube in place.



The bender can be placed in a vise for even more leverage.



A comfort-grip handle can lessen the strain, allowing easier 180° bends.



# TRI-TUBE BENDERS

From start to final bend, the hilmor Tri-Tube Bender has you covered. It just takes simple sizing.



## Simple Sizing

Indicators in the handles can help you find the correct tube size.



## Quick Identification

Color-coded to help you spot the right tube size and align in the groove.



## Precise Angles

Markings on the side help create up to 180° bends.

## Item Specifications

Item Numbers	1839026	1839027
Product Descriptions	TC1438	TC1412
Tube Sizes (O.D.)	1/4", 5/16", 3/8"	1/4", 3/8", 1/2"

## Product Dimensions

Length	14"	19"
Width	2.25"	3.5"
Height	3.25"	4.25"
Weight	1.1 lbs	2.40 lbs

Tube Materials	Soft Tubing Only Copper, Steel, Aluminum, Brass
----------------	--



Color-coded tube size holes allow you to identify the correct tube size.



Correctly align the tube size with color-coded indicators.



Tri-Tube Bender  
1839027

Tri-Tube Bender  
1839026



# SPRING BENDERS

Getting an accurate bend by hand isn't always easy. But, our Spring Benders can help simplify things. Four different benders are included to fit 1/4", 3/8", 1/2" and 5/8" tubing. Simply slip the Spring Bender over soft-copper or aluminum tubing, and count on the spring to keep the tube from kinking.

## Item Specifications

Item Number	1839031			
Product Description	SB			
Tube Sizes (O.D.)	1/4"	3/8"	1/2"	5/8"
<b>Product Dimensions</b>				
Size	1/4"	3/8"	1/2"	5/8"
Length	11.3"	11.3"	11.3"	11.3"
Weight	.3125 lbs	.3125 lbs	.3125 lbs	.3125 lbs
Tube Materials	Soft Tubing Only Copper, Steel, Aluminum, Brass			



Spring Benders  
1839031

# GET IN. GET OUT. GET ON TO THE NEXT JOB.



Simple setup, precise positioning and a secure hold. It's a common theme you'll find throughout hilmor's line of flaring tools, and it's the reason our flaring tools deliver a precise, quality flare every time. Simply choose the flaring tool that fits your needs, and get ready to conquer your next job.

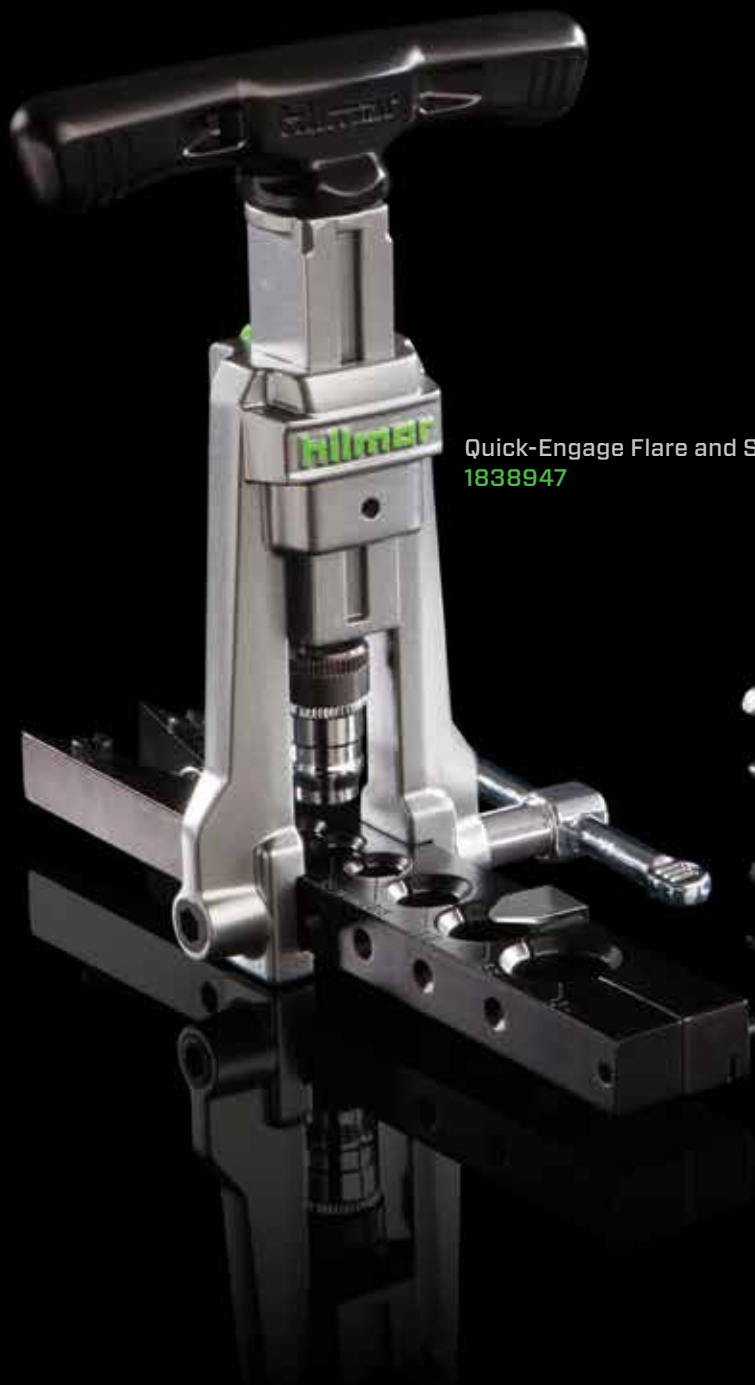

Quick-Engage Flare and Swage  
1838947



Large Flare/Swage  
1838948

MOST FLARING TOOLS REQUIRE A THIRD ARM.  
PROBLEM IS, YOU DON'T HAVE A  
**THIRD ARM.**

Extra appendages are hard to come by these days. Instead, opt for the all-new hilmor Quick-Engage Flare and Swage. Simple setup, precise positioning and a secure hold allow you to quickly conquer and move on to the next job.



**Less Work**

Allows for faster flares and swages because it requires fewer rotations.



**Simple Setup**

A clothespin-inspired, spring-loaded block grips the tube securely.



**Easy To Position**

A tube-stop arrow slides to set correct height and positioning, while ball detents allow easy flaring cone alignment.

See all the innovations you can put to work at [hilmor.com](http://hilmor.com).



Quick-Engage Flare and Swage  
1838947

**hilmar**<sup>™</sup> **RETOOL + CONQUER**<sup>™</sup>





Ball detents ensure proper and precise alignment to guarantee a perfect flare or swage every time.



Push down the yoke and with fewer rotations, you get a precise flare or swage.

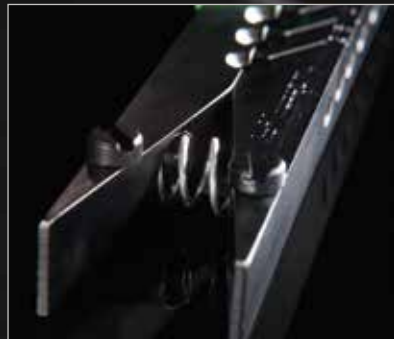

An innovative spring-loaded block holds the tube firmly in place.

# QUICK-ENGAGE FLARE AND SWAGE KIT

## Kit Contents

1 Bar, 1 Quick-Engage Yoke, 1 Flare Cone  
3/16" to 3/4", 5 Swage Heads



Tube-stop arrow easily identifies correct height and position of the tube.

## Item Specifications

Item Number 1838947

Product Description FS

Tube Sizes (O.D.) 3/16", 1/4", 5/16", 3/8", 1/2", 5/8", 3/4"

### Product Dimensions

Length 8.5"

Width 4.6"

Height 7.5"

Weight 3.50 lbs

Tube Materials Soft Tubing Only  
Copper, Steel, Aluminum, Brass

Flare Type 45 degree

# ORBITAL FLARE

The Hilmor Orbital Flare was designed to produce quality flares – again and again. A tube-stop arrow allows precise positioning and placement so you can keep that nickel in your pocket. Plus, a clutch mechanism stops the flare to eliminate cracking the tube.



## Precise Flares, Every Time

An off-center mounted cone spins on an axis to effectively produce quality flares.



## No Cracked Tubes

A clutch mechanism stops the flaring when the job is done.



## Simple Setup

A clothespin-inspired, spring-loaded block grips the tube securely.



## Easy To Position

A tube-stop arrow slides to set correct height and positioning while ball detents allow for easy flaring cone alignment.



A clutch mechanism stops the flare when the job is done to eliminate cracking the tube.



An off-center mounted cone helps to uniformly shape the tube.

## Item Specifications

Item Number 1838952

Product Description FTO

Tube Sizes (O.D.) 3/16", 1/4", 5/16", 3/8", 1/2", 5/8", 3/4"

### Product Dimensions

Length 8.5"  
Width 4.6"  
Height 5.3"  
Weight 3.75 lbs

Tube Materials Soft Tubing Only  
Copper, Steel, Aluminum, Brass

Flare Type 45 degree



Orbital Flare  
1838952

# BASIC FLARE

hilmor flaring tools are the no-muss, no-fuss way to flare. Our Basic Flare handles 1/8" to 3/4" tubes.



## Durable

The cast steel yoke and hardened flaring bar are made to be knocked around.



## Control

Steel wing nuts make it easy to hold pipe secure.



## Small Space Capable

A compact design allows it to be used even in cramped spaces.



## Quality Flares

An extra-long handle provides more leverage and self-centers for a consistent quality flare.

## Item Specifications

Item Number	1838956
Product Description	FT1834
Tube sizes (O.D.)	1/8", 3/16", 1/4", 5/16", 3/8", 1/2", 5/8", 3/4"

## Product Dimensions

Length	8.8"
Width	5.2"
Height	4.3"
Weight	2.35 lbs

Tube Materials	Soft Tubing Only Copper, Steel, Aluminum, Brass
----------------	--

Flare Type	45 degree
------------	-----------

## Replacement Parts

Item Number	1839004 FSC1434 Replacement Cone
-------------	-------------------------------------



Basic Flare  
1838956

# LARGE BASIC FLARE

The hilmor Large Basic Flare has all the advantages of hilmor flaring tools with the bulked-up size to handle 3/4" to 1-1/8" tubes. And it can fit into spaces other flaring and swaging tools can't.



## Durable

The cast steel yoke and hardened flaring bar are made to be knocked around.



## Control

Steel wing nuts make it easy to hold pipe secure.



## Small Space Capable

A compact design allows it to be used even in cramped spaces.



## Quality Flares

An extra-long handle provides more leverage and self-centers for a consistent quality flare.

## Item Specifications

Item Number	1838955
Product Description	FTL
Tube Sizes (O.D.)	3/4", 7/8", 1-1/8"

## Product Dimensions

Length	7.1"
Width	6.0"
Height	5.3"
Weight	3.7 lbs

Tube Materials	Soft Tubing Only Copper, Steel, Aluminum, Brass
----------------	--

Flare Type	45 degree
------------	-----------

## Replacement Parts

Item Number	1839007
Flare Cone	3/4" to 1-1/8"



Extra-long handle gives you additional leverage for easier flaring.



Large Basic Flare  
1838955



# LARGE FLARE/SWAGE

When you need a precise, quality flare or swage, the hilmor Large Flare/Swage delivers. Its compact design allows it to fit where others can't. And, with a long handle for additional leverage, it can help give you a leg up on any job.



## Durable

The cast steel yoke and hardened flaring bar are made to be knocked around.



## Control

Steel wing nuts make it easy to hold pipe secure.



## Small Space Capable

A compact design allows it to be used even in cramped spaces.



## Quality Flares

An extra-long handle provides more leverage and self-centers for a consistent quality flare.



Easily changeable swage heads are made for 3/4", 7/8" and 1-1/8" tubing.

## Item Specifications

Item Number	1838948
Product Description	FSL
Tube Sizes (O.D.)	3/4", 7/8", 1-1/8"

## Product Dimensions

Length	7.1"
Width	6.0"
Height	6.0"
Weight	6.4 lbs

Tube Materials	Soft Tubing Only Copper, Steel, Aluminum, Brass
----------------	--

Flare Type	45 degree
------------	-----------

## Replacement Parts

Item Number	Description	Size
1839002	FSA58 Swage Adapter	5/8"
1839003	FSA34 Swage Adapter	3/4"
1839005	FSA78 Swage Adapter	7/8"
1839006	FSA118 Swage Adapter	1-1/8"
1839007	FSC58118 Flare Cone	5/8" to 1-1/8"



Large Flare/Swage  
1838948



# NO SWEAT. NO STRAIN. JUST PICTURE-PERFECT SWAGES.



At hilmor, we've built our swaging tools around the way you work. We've retooled the design to make swaging tools much more convenient and comfortable to use. And our tools deliver. Each one is made to be precise.

THOUGHTFULLY DESIGNED TO  
ELIMINATE SWINGING A HAMMER AT  
**YOUR JEWELS.**

In tight spaces, you need a tool that can pack a punch. Just not below the belt. The all-new hilmor Compact Swage can knock out a picture-perfect swage in one shot. These lightweights have the power to swage 1-5/8" tubing and the control to swage 5/16" tubing without a crack. It's time you put a heavy hitter in your corner.



**Picture-perfect Swaging**

Simply select the correct head, place it on the tool and make a quality swage.



**Less Effort, More Control**

The power to swage 1-5/8" tubing and the control to swage 5/16" without splitting the tube.



**Small Space Capable**

A compact, pistol shape allows it to fit into the smallest of spots, even on a ladder.



**One-handed Operation**

The lever mechanism and release button allow for one-handed swaging without the fatigue.

See all the innovations you can put to work at [hilmor.com](http://hilmor.com).



Compact Swage Tool  
1839015

**hilmer**<sup>™</sup> **RETOOL + CONQUER**<sup>™</sup>





# COMPACT SWAGE TOOL

## Kit Contents

3/8", 1/2", 5/8", 3/4", and 7/8"  
Expander Heads, Deburrer and  
Compact Swage Tool



### Picture-perfect Swaging

Simply select the correct head, place it on the tool and make a quality swage.



Hydraulic mechanism and release button make one-handed swages possible.

## Item Specifications

Item Number	1839015
Product Description	CS
Kit Contents	3/8", 1/2", 5/8", 3/4", 7/8" Expander Heads, Deburrer, Compact Swage Tool
Tube Sizes (O.D.)	3/8", 1/2", 5/8", 3/4", 7/8"

Product Dimensions	
Length	9"
Width	1.75"
Height	5"
Weight	8.5 lbs

Replacement Parts		
Item Number	Description	Size
1839016	CSEH516 Expander Head	5/16"
1839017	CSEH38 Expander Head	3/8"
1839018	CSEH12 Expander Head	1/2"
1839019	CSEH58 Expander Head	5/8"
1839020	CSEH34 Expander Head	3/4"
1839021	CSEH78 Expander Head	7/8"
1839022	CSEH118 Expander Head	1-1/8"
1839023	CSEH138 Expander Head	1-3/8"
1839024	CSEH158 Expander Head	1-5/8"
1839025	CSB Compact Swage Body Kit	N/A
1839052	DBUR Deburrer	N/A

Tube Materials	Soft Tubing Only Copper, Steel, Aluminum, Brass
----------------	--

Recommended Replacement Hydraulic Liquid HV-15

Recommended Expander Head Lubricant NLGI1 or NLGI2



Multiple expander heads quickly switch out to accommodate 5/16" to 1-5/8" tubing.

# PUNCH SWAGE SET

Get the sizes you need, right when you need them with the hilmor 5-piece Punch Swage Set. Punches are available in a set with 1/4", 5/16", 3/8", 1/2" and 5/8".

## Item Specifications

Item Number	1839008				
Product Description	S1458				
Tube Sizes (O.D.)	1/4"	5/16"	3/8"	1/2"	5/8"
<b>Product Dimensions</b>					
Size	1/4"	5/16"	3/8"	1/2"	5/8"
Diameter	.50"	.70"	.70"	.90"	.90"
Height	3"	3"	3"	3.75"	3.75"
Weight	.2 lbs	.2 lbs	.2 lbs	.2 lbs	.2 lbs
Tube Materials	Soft Tubing Only Copper, Steel, Aluminum, Brass				



Punch Swage Set  
1839008

# MULTI-SWAGE PUNCH

One punch. Multiple tube sizes. The hilmor Multi-Swage Punch is designed to fit 1/4" to 5/8" tubes. Made of steel and chrome-coated for a durable design with less friction against the tube.



The Multi-Swage Punch tool is intelligently designed with a broader base to reduce missed hits.

## Item Specifications

Item Number	1839009
Product Description	MS
Tube Sizes (O.D.)	1/4" to 5/8" (1/4", 5/16", 3/8", 1/2", 5/8")
<b>Product Dimensions</b>	
Diameter	.90"
Height	5.25"
Weight	.35 lbs
Tube Materials	Soft Tubing Only Copper, Steel, Aluminum, Brass



Multi-Swage Punch  
1839009

# SOMETIMES A COMPLEX JOB CALLS FOR A SIMPLE SOLUTION.



Retooling with hilmor means getting a little more out of the tools you use every day on the job – even the basic ones. From Service Wrenches, Hex Key Sets and Magnetic Nut Drivers to a 9-in-1 Multi-Tool and Quick-Change Magnetic Nut Driver, we've got you covered. Choose the tool you need, and let hilmor help you get to work.



# MAGNETIC NUT DRIVERS

At hilmor, we've taken the nut driver up a notch. Simply put, it's ready to conquer when you are.



### Secure Hold

A magnetic tip keeps fasteners firmly in place.



### Quick Identification

A color-coded insert makes size identification simple.



### More Torque

A slip-resistant grip and wrench flats allow for maximum leverage.



### Big Bolt Capable

A hollowed shaft allows for use on long bolts.



### Rugged & Durable

Designed to last with a durable chrome-vanadium steel construction.

## SIZES

**1-1/2" Shaft Magnetic Nut Drivers:**  
Available in 1/4" and 5/16" sizes or as a 2-piece set.

**3" and 6" Shaft Magnetic Nut Drivers:**  
Sold individually, or choose our full 7-piece set or our handy 2-piece set.

**18" Shaft Magnetic Nut Drivers:**  
Available in 1/4" and 5/16" sizes.

## Item Specifications

1-1/2" Magnetic Nut Drivers			
Item Number	1839055	1839056	1839057
Size	1/4"	5/16"	Set of 2 - 1/4" & 5/16"
Color	Red	Yellow	Red & Yellow
Product Dimensions			
Length	3.5"	3.5"	3.5"
Width	1.32"	1.32"	1.32"
Weight	0.1 lbs	0.1 lbs	0.2 lbs

18" Magnetic Nut Drivers		
Item Number	1839076	1839077
Size	1/4"	5/16"
Color	Red	Yellow
Product Dimensions		
Length	22"	22"
Width	1.2"	1.2"
Weight	0.4 lbs	0.4 lbs

Additional sizes on next two pages.



1-1/2" Magnetic Nut Drivers  
1839055, 1839056

# MAGNETIC NUT DRIVERS

## Item Specifications

3" Magnetic Nut Drivers									
Item Number	1839058	1839059	1839060	1839061	1839062	1839063	1839064	1839066	1839065
Size	3/16"	1/4"	5/16"	11/32"	3/8"	7/16"	1/2"	Set of 2 - 1/4" & 5/16"	Set of 7
Color	Black	Red	Yellow	Green	Blue	Brown	Red	Red & Yellow	Multi
Product Dimensions									
Length	6.88"	6.88"	6.88"	6.88"	6.88"	7.25"	7.25"	6.88"	6.88"/7.25"
Width	1.2"	1.2"	1.2"	1.2"	1.2"	1.37"	1.37"	1.2"	1.2"/1.37"
Weight	0.2 lbs	0.2 lbs	0.2 lbs	0.2 lbs	0.25 lbs	0.35 lbs	0.35 lbs	0.4 lbs	1.65 lbs



A color-coded insert makes size identification quick and easy.



3" Magnetic Nut Driver Set  
1839065

# MAGNETIC NUT DRIVERS

## Item Specifications

6" Magnetic Nut Drivers									
Item Number	1839067	1839068	1839069	1839070	1839071	1839072	1839073	1839074	1839075
Size	3/16"	1/4"	5/16"	11/32"	3/8"	7/16"	1/2"	Set of 2 - 1/4" & 5/16"	Set of 7
Color	Black	Red	Yellow	Green	Blue	Brown	Red	Red & Yellow	Multi
Product Dimensions									
Length	9.88"	9.88"	9.88"	9.88"	9.88"	10.25"	10.25"	9.88"	9.88"/10.25"
Width	1.2"	1.2"	1.2"	1.2"	1.2"	1.37"	1.37"	1.2"	1.2"/1.37"
Weight	0.2 lbs	0.2 lbs	0.2 lbs	0.25 lbs	0.25 lbs	0.4 lbs	0.4 lbs	0.4 lbs	1.9 lbs

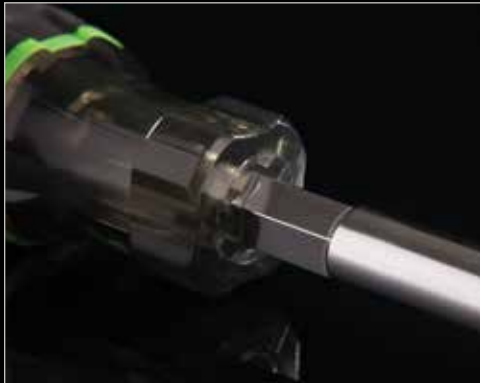

A wrench flat lets you tighten with a wrench for ease and extra confidence.



6" Magnetic Nut Driver Set  
1839075



x2



Quick-Change  
Magnetic Nut Driver  
1839054



# QUICK-CHANGE MAGNETIC NUT DRIVER

Quickly switch between 1/4" and 5/16", the two most common sizes.

x2

## Added Versatility

Quickly switch between 1/4" and 5/16", the two most common sizes.



## Secure Hold

A magnetic tip on both ends keeps fasteners firmly in place.



## Quick Identification

A color-coded insert on the bands and bottom makes size identification simple.



## Big Bolt Capable

A hollowed shaft allows for use on long bolts.



## Rugged & Durable

Designed to last with a durable chrome-vanadium steel construction.

## Item Specifications

Item Number	1839054
-------------	---------

Product Description	QCND
---------------------	------

Size	1/4" & 5/16"
------	--------------

## Product Dimensions

Length	1.32"
--------	-------

Width	1.32"
-------	-------

Height	7.5"
--------	------

Weight	.35 lbs
--------	---------



A color-coded insert allows for quick tool identification.



A slip-resistant, comfort grip gives you more torque.



# 9-IN-1 MULTI-TOOL

When you need more out of one tool, hilmor is here to help. In fact, our 9-in-1 Multi-Tool even gives you a little more. Tackle any on-the-job challenge with bits, including a valve core remover, square #2, 1/2" hex, 5/16" hex, 3/8" hex, Phillips #1, Phillips #2, 3/16" slotted and 1/4" slotted.



### More Torque

A slip-resistant grip allows for maximum leverage.



### Extra Durable

Designed with thick shaft walls for long life and less stripping.



Includes a valve core remover.

## Item Specifications

Item Number	1839053
Product Description	9IN1SV
<b>Product Dimensions</b>	
Length	1.32"
Width	1.32"
Height	7.2"
Weight	.45 lbs

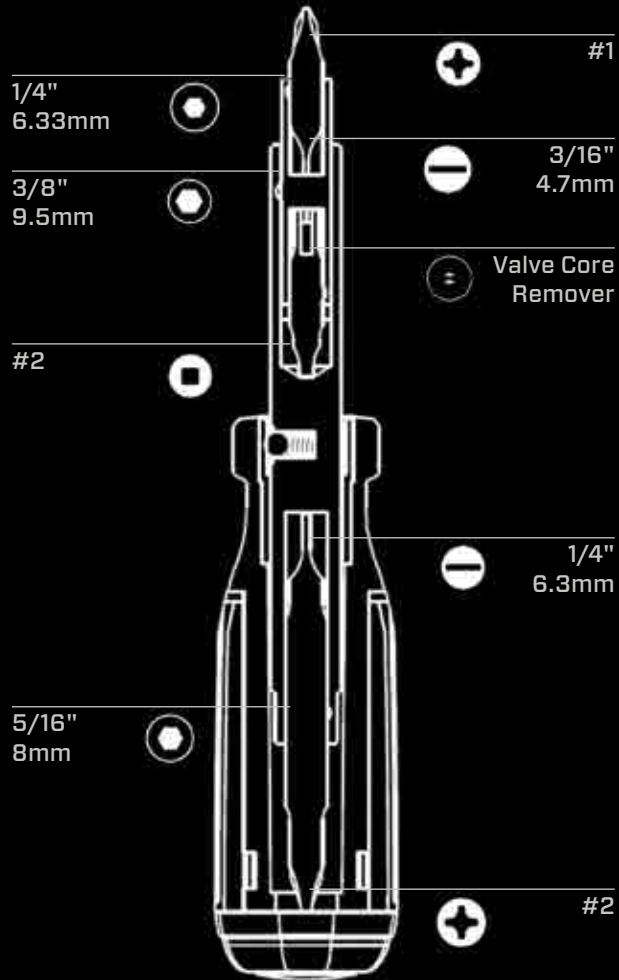

9-In-1 Multi-Tool  
1839053

# SERVICE WRENCHES

Smart features that save your knuckles and your time. Our Straight Service Wrench makes changing sizes quick and easy. Our Offset Service Wrench makes maneuvering around cramped spaces second nature. The reversible Ratchet Wrench has square openings of 1/4" and 3/16" on one end and 3/8" and 5/16" on the other end. And, when it comes to accessing liquid- and suction-based valves, reach for our Hex Key Adapter. It works on 3/16" and 5/16" hex valves.



Hex Key Adapter  
1839046

## Item Specifications

### Hex Key Adapter

Item Number	1839046
Hex Valve Sizes	3/16" and 5/16"

### Product Dimensions

Length	0.37"
Width	0.37"
Height	2.13"
Weight	0.04 lbs

## Item Specifications

Item Number			
	1839042	1839043	1839045
Product Description			
	SWS Service 1/4 X 3/16 SQ 3/8 X 5/16 SQ	SWOS Offset 1/4 X 3/16 SQ 3/8 X 5/16 SQ	SWLR Service LR 1/2 X 9/16 Hex 3/16 X 1/4 SQ
Square Sizes			
	1/4", 3/16" 3/8", 5/16"	1/4", 3/16" 3/8", 5/16"	1/4", 3/16"
Hex Sizes			
	N/A	N/A	1/2", 9/16"
Accessories			
	1839046 SWHKA Service Hex Key Adapter works on 3/16" and 5/16" Hex Valves		
Product Dimensions			
Length	.9"	.9"	1.07"
Width	.5"	.77"	.53"
Height	5.52"	5.3"	6.55"
Weight	.2 lbs	.2 lbs	.3 lbs



Straight Service Wrench  
1839042

Offset Service Wrench  
1839043

# INSPECTION MIRROR

Leaks can't hide anymore. With a handle that extends from 7-3/4" to 21-1/2", this telescoping mirror truly does go above and beyond.

## Item Specifications

Item Number	1839051
Product Description	IMIR
<b>Product Dimensions</b>	
Length	7-3/4" to 21-1/2"
Mirror Width	1.0" x 2.0"
Weight	0.1 lbs



Inspection Mirror  
1839051

# DEBURRER

Whether it's inside or outside, copper or plastic, the hilmor Deburrer can smooth things over. In fact, with its steel blades, it can deburr OD tubing from 1/4" to 1-5/8".

## Item Specifications

Item Number	1839052
Product Description	DBUR
Sizes	1/4" to 1-5/8"
<b>Product Dimensions</b>	
Length	2.1"
Width	2.1"
Height	2.3"
Weight (lbs)	0.11 lbs



Deburrer  
1839052

# HEX KEY SETS

Get the full socket contact you need. Our slip-resistant Folding Hex Key Set includes hex keys from 5/64" to 1/4". And the ball ends of our Ball End Hex Key Set let you access and turn hard-to-get-at fasteners at up to 30° angles. Get equipped with all the hex keys you need in sizes 0.05" to 3/8".



Ball End Hex Key Set  
1839049

Ball ends let you access and turn hard-to-get-at fasteners up to 30° angles.

## Item Specifications

Item Number	1839048	1839049
<b>Product Description</b>	<b>Folding Hex Key Set</b>	<b>Ball End Hex Key Set</b>
	HKFS	HKS
	5/64", 3/32", 7/64" 1/8", 9/64", 5/32" 3/16", 7/32", 1/4"	0.05", 1/16", 5/64" 3/32", 7/64", 1/8" 9/64", 5/32", 3/16" 7/32", 1/4", 5/16" 3/8"
<b>Product Dimensions</b>		
Length	1.7"	0.8"
Width	0.9"	2.8"
Height	4.3"	7.25"
Weight (lbs)	0.32 lbs	0.82 lbs



Folding Hex Key Set  
1839048

# IN THE DARK, DIRTY AND DOWNRIGHT CRAMPED, YOU GOTTA KEEP IT TOGETHER.



We're not just revolutionizing your HVAC/R equipment, we're also retooling the way you store it. We offer a wide array of smart storage and transport solutions for all your valuable tools. It's another way we help you conquer from one job to the next. And keep your cool no matter the climate.



# HVAC/R TOTE

The hilmor HVAC/R Tote is your go-to tool storage and transport solution. It includes 27 exterior and interior pockets, 18 elastic bands and clips for your keys so you can store your tools safely and find them quickly.



## Keep Organized

27 pockets and 18 elastic bands.



## Rugged & Durable

Designed to last with water-resistant bottom and reinforced rivets.



## Secure Storage

Stow your meter away safely in the padded pocket in the interior of the tote. Use the tape measure clip, key clip and tape holder loop to secure the rest of the items you need.



## Helps With The Heavy Lifting

This tote has room for multiple tools and is tested up to 50 lbs. The padded shoulder strap makes carrying more comfortable.

## Item Specifications

Item Number	1839078
Product Description	HT
Number of Pockets	
Interior	13
Exterior	14
Extra Features	Key Clip; Tape Loop; Shoulder Strap
<b>Product Dimensions</b>	
Length	7.5"
Width	7.5"
Height	13"
Weight	3.3 lbs



HVAC/R Tote  
1839078



Backpack Tool Bag  
1839080

Tools sold separately.

# BACKPACK TOOL BAG

The hilmor Backpack Tool Bag is your jobsite sidekick with 19 exterior and interior pockets. Its sturdy rubber, water-resistant bottom means rain or shine, the contents inside won't be damaged. And while it's spacious enough to hold up to 50 lbs, padded shoulder straps and a back air vent make hauling it a little more comfortable and leaves your hands free to safely climb a ladder.



## Secure Storage

Stow your meter away safely in either of the two padded zipper pockets on the exterior sides of the tote.



## Superior Versatility

Hang your manifold from the bag's metal loop for easy transport to the jobsite.



## Helps With The Heavy Lifting

This bag has room for multiple tools and is tested up to 50 lbs. The padded shoulder straps and air vent back make carrying more comfortable.

## Item Specifications

Item Number	1839080
Product Description	BKB
Number of Pockets	
Interior	11
Exterior	8

## Extra Features

Clear Vinyl ID Window Pocket; Shoulder Strap; Double-grip Handles; Steel "U" Ring; Airflow Ventilator Pads

## Product Dimensions

Length	6"
Width	14"
Height	16"
Weight	4.5 lbs



19 exterior and interior pockets allow you to store tools safely and find them quickly.



A metal loop gives you an easy way to transport your manifold.



Two padded, zippered side pockets provide safe storage for your meter.



# TOOL CENTER BAG

The hilmor Tool Center Bag is your total tool storage solution. It includes 24 exterior and interior pockets and three zippered pouches so you can store your tools safely and find them quickly.



## Keep Organized

24 pockets and three zippered pouches.



## Secure Storage

Stow your meter away safely in either of the two padded pockets on the exterior sides of the tote.



## Helps With The Heavy Lifting

This bag has room for multiple tools and is tested up to 50 lbs. The padded shoulder strap makes carrying more comfortable.



## Rugged & Durable

Designed to last with a hard plastic, water-resistant bottom and a padded aluminum carrying handle.

## Item Specifications

Item Number 1839079

Product Description TCB

Number of Pockets

Interior 13; 18 Tool Loops

Exterior 11

## Extra Features

Clear Vinyl ID Window Pocket; Shoulder Strap; Cover Flap

## Product Dimensions

Length 13.5"

Width 8.5"

Height 9"

Weight 4.5 lbs



Three zippered pouches and two padded side pockets provide safe storage for your meter.



Tool Center Bag  
1839079

# ZIPPER POUCH

The hilmor Zipper Pouch is your best bet for keeping track of all the small stuff on the jobsite – from small tools and accessories to receipts and other paperwork.



### Keep Organized

The hilmor Zipper Pouch can conveniently fit many hilmor tools, including the Punch Swage Set or Dual Readout Thermometer with two Thermocouple Clamps.



### Rugged & Durable

Designed with an inner liner to protect from water damage and a rivet on the outside so it can be clipped where it's needed.

# MANIFOLD COVER

The hilmor Manifold Cover is the ultimate shield to keep your manifold out of harm's way. The padded cover protects the manifold from any falls and scrapes while still allowing it to be hung for daily use.



### Secure Storage

Keep your manifold out of harm's way with a padded protective cover that still allows you to hang it up for daily use.



### Keep Organized

Use the two mesh pockets on the sides for spare parts and accessories.

## Item Specifications

Item Number	1839081
Product Description	ZP
Number of Pockets Interior	1

## Product Dimensions

Length	10.5"
Height	7"
Weight	3 oz



Zipper Pouch  
1839081

## Item Specifications

Item Number	1839050
Product Description	MC
Number of Pockets Exterior	2

## Product Dimensions

Length	9.5"
Width	4"
Height	9"
Weight	6 oz



Manifold Cover  
1839050



# WARRANTY

---

At hilmor, we have put the highest priority on thoughtful product design and manufacturing quality. That is why we guarantee our products to be free of material and workmanship defects for a period of time from purchase (see chart below). We get the tough conditions in which you work and have designed products to stand up to those challenges. Unfortunately, this warranty does not apply to product that has been damaged as a result of improper maintenance, accident or other misuse, or which fails to operate due to normal wear and tear.

Product Line	Time Period from Purchase
Tube Working Tools – benders, flaring & swaging	Lifetime
Service Tools & Drivers	Lifetime
Manifold bar	Lifetime
Tool Storage Bags	Lifetime
Electronics – gauges and thermometers	Three years
Analog Gauges	One year
Hoses	One year

All products subject to warranty claims should be returned to the place of purchase along with proof of purchase showing the date of purchase. The distributor from whom the product was purchased will contact hilmor for next steps, which could include field scrap or return to the factory for analysis, and work with you on a repair, replacement or credit.

Please contact hilmor Technical Services for general technical questions related to products or this warranty policy: **1-800-642-0010**.

HILMOR MAKES NO OTHER WARRANTIES, EXPRESS OR IMPLIED, CONCERNING THE PRODUCT OR THE MERCHANTABILITY OR FITNESS THEREOF FOR ANY PURPOSE. IN NO EVENT SHALL HILMOR (WHICH INCLUDES NEWELL RUBBERMAID, INC. AND ITS AFFILIATES, SUCCESSORS AND ASSIGNS) BE LIABLE FOR INCIDENTAL, CONSEQUENTIAL OR PUNITIVE DAMAGES (OR LOST PROFITS), REGARDLESS OF THE NATURE OF THE CLAIM.

---

# PRESSURE – TEMPERATURE CHART

ALL PRESSURES SHOWN ARE IN PSIG; RED PRINT = VACUUM (INCHES OF MERCURY)

F	R-12	R-22	R-134A	R-404A		R-407C		R-410A	R-502A	C
				Vapor	Liquid	Vapor	Liquid			
-40	11	1	15	5	4	3	4	12	4	-40
-35	8	3	13	8	7	5	1	15	7	-37
-30	6	5	10	11	10	8	2	19	9	-34
-25	2	7	7	14	13	11	4	23	12	-32
-20	1	10	4	17	16	14	7	27	15	-29
-15	2	13	1	21	19	18	9	32	19	-26
-10	5	17	2	25	23	21	13	37	23	-23
-5	7	20	4	29	28	25	16	43	27	-21
0	9	24	7	34	32	30	20	49	31	-18
5	12	28	9	39	37	35	24	55	36	-15
10	15	33	12	45	42	40	28	62	41	-12
15	18	38	15	51	48	46	33	70	47	-9
20	21	43	18	57	55	52	38	78	52	-7
25	25	49	22	64	61	58	44	87	59	-4
30	29	55	26	71	68	65	50	97	66	-1
35	33	62	30	79	76	73	56	107	73	2
40	37	69	35	97	84	81	63	118	81	4
45	42	76	40	106	93	89	71	130	89	7
50	47	84	46	116	103	98	79	142	97	10
55	52	93	51	127	113	108	87	155	107	13
60	58	102	58	138	123	118	97	170	116	16
65	64	111	64	150	135	129	106	185	127	18
70	70	121	71	163	147	141	117	201	138	21
75	77	132	79	176	159	153	128	217	149	24
80	84	144	87	190	173	166	140	235	161	27
85	92	156	95	205	187	180	153	254	174	29
90	100	168	104	221	202	195	166	274	187	32
95	108	182	114	237	218	210	180	295	201	35
100	117	196	124	255	234	226	195	317	216	38
105	127	211	135	273	252	243	210	340	232	41
110	136	226	147	292	270	261	226	365	248	43
115	147	243	159	313	289	280	243	391	265	46
120	158	260	171	318	310	300	261	418	283	49
125	169	278	185	339	331	321	280	446	301	52
130	181	297	199	362	353	342	300	476	321	54
135	194	317	214	385	377	365	321	507	341	57
140	207	337	229	410	401	389	342	539	363	60
145	220	359	246	436	426	412	365	573	391	63
150	234	382	263	463	453	438	389	608	415	66

# **hilmor**<sup>™</sup>

**RETOOL + CONQUER**<sup>™</sup>

301 Chestnut Street  
East Longmeadow, MA 01028  
1-800-628-8810  
[hilmor.com](http://hilmor.com)

© 1/2013 hilmor, Newell Rubbermaid