

**DURO
DYNE**®

DYNOMATE®

**4-BOLT
CONNECTOR &
DUCT WORK ACCESSORIES**

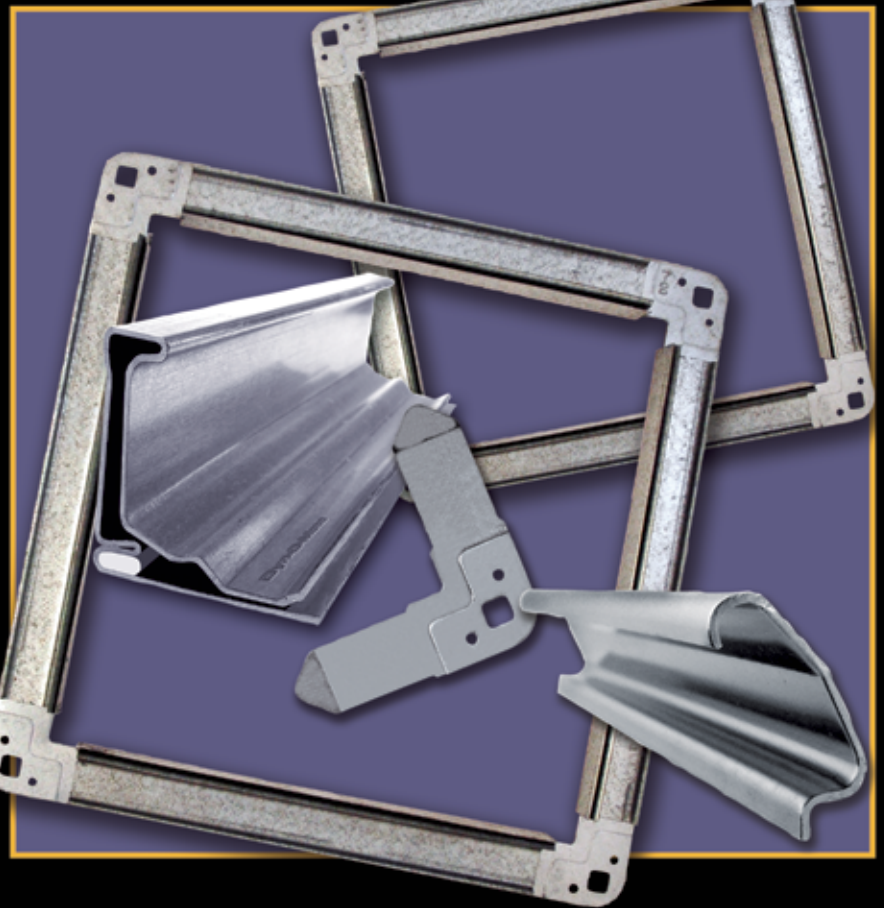

**PRODUCT
CATALOG**
& Duct Construction
Standards



	Page #
Access Doors	13-14
Assembly Instructions	21
Cleats*	7
Cut-To-Length Products	10-12
Duct Construction Standards	23-29
1/2" W.G. Static	23
1" W.G. Static	24
2" W.G. Static	25
3" W.G. Static	26
4" W.G. Static	27
6" W.G. Static	28
10" W. G. Static	29
Dyn-O-Wrap	16
Dyn-O-Loc, Insertion Tool Machine, Dyn-O-Claw	19
Dyn-O-Strut	8
Flat Drive* & Cut-To-Length	10
Flat S* & Cut-To-Length	11
Gasketing	18
Grease Duct Doors	14
Hanging Strap	7
H System	2
J System	3
Nosing	20
Punched Angle Iron	20
SMACNA Policy	22
Standing S* & Cut-To-Length	12
Test Results	30
TDC Corners	4
IDF Corners	5
Threaded Rod & Accessories	8-9
Tools	17
Vane and Rail*	15
Vane Cutter	16

Color Code Gauge Guide

- 16 gauge: Yellow
- 18 gauge: Black
- 20 gauge: Blue
- 22 gauge: White
- 24 gauge: Green
- 26 gauge: Orange or Red
- 28 gauge: Brown
- J Flange: Blue
- H Flange: White

PROPRIETARY AND CONFIDENTIAL: The drawings and specifications contained in this publication are the exclusive property of Duro Dyne Corporation and shall not be divulged, reproduced, copied or used as the basis for the manufacture or sale of apparatus without the express written authorization of Duro Dyne Corporation.

All dimensions shown throughout this Product Catalog are approximate.
*Manufactured with yellow label.

H System

Flange is designed to strengthen the duct wall and connect duct sections together. All Duro Dyne Dyn-O-Mate H Flange is furnished with an **integrated sealant pocket** for a secure air tight fit and meets

SMACNA class H for transverse joints (Aluminum). Bundles of 20ft. lengths are available **only** with a Full Truckload order and most styles are available in **specialty metals**. All Dyn-O-Mate Corners that work in the H System are a skid qty of 48 boxes.

H Flange

H Style (22 gauge) for large commercial and high-pressure applications

Item #	Code	Description	Packaging
21231	DOMH20	H Flange - 20ft	1000ft./Bundle
21235	DOMH12	H Flange - 12ft	1200ft./Bundle

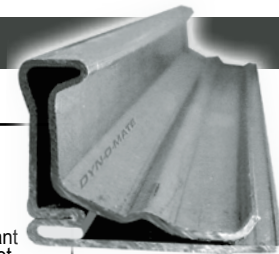
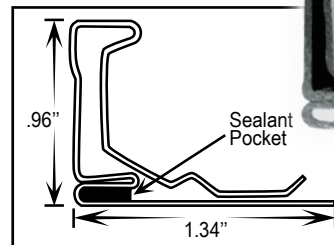

H Corner

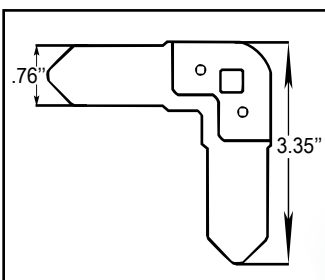

- DDH corners are manufactured from 12-gauge steel.
- For use with H Flange.
- Nuts and Bolts are **also** sold separately. (See page 10)

Item #	Code	Description	Packaging
21241	DDH	H Corner	250/Box
21249	DDHNB	H Corner with 1/4 in. Nut & Bolt	250/Box

J System

Flange is designed to strengthen the duct wall and connect duct sections together. All Duro Dyne Dyn-O-Mate J Flange is furnished with an **integrated sealant pocket** for a secure air

tight fit and **meets SMACNA** rigidity class J for transverse joints (steel). Bundles of 20ft. lengths are available **only** with a Full Truckload order and most styles are available in **specialty metals**. All Dyn-O-Mate Corners in the J System are a skid qty of 48 boxes.



J Flange

J Style (20 gauge) for large commercial and high-pressure applications

Item #	Code	Description	Packaging
21230	DOMJ20	J Flange - 20ft	1000ft./Bundle
21234	DOMJ12	J Flange - 12ft	1200ft./Bundle
21233	DOMJ10	J Flange - 10ft	500ft./Bundle
21236	DOMJ20SS	J Flange - 20ft Stainless Steel	1000ft./Bundle
21238	DOMJ20AL	J Flange - 20ft Aluminum	1000ft./Bundle

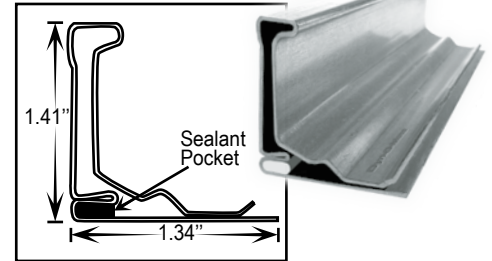

J Speed Corner

J Style (12 gauge)

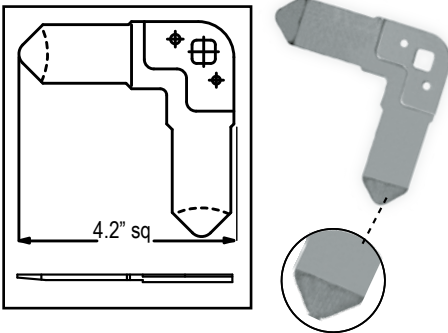

- Speed Corners have tapered coined corner tips for fast/easy hand insertion into the Flange eliminating the need for a tinner's hammer.
- Speed Corners are formed from galvanized G 60 or better 12ga USA made steel. For use with J Flange.
- Opposing size alignment holes for aligning flange or optionally making connections using a standard 10x3/4 Pro Point screw.
- Nuts and Bolts are **also** sold separately. (See page 10)

Item #	Code	Description	Packaging
21094	DDJS	J Speed Corner	250/Box
21095	DDJSNB	J Speed Corner with 3/8" Nuts & Bolts	250/Box

J Corner

J Style (12 gauge)

- J Corners are formed from galvanized G 60 or better 12ga USA made steel. For use with J Flange.
- Nuts and Bolts are also sold separately. (See page 10)
- Opposing size alignment holes for aligning flange or optionally making connections using a standard 10x3/4 Pro Point screw.

Item #	Code	Description	Packaging
21240	DDJ	J Corner	250/Box
21242	DDJNB	J Corner with 3/8in. Nut & Bolt	250/Box

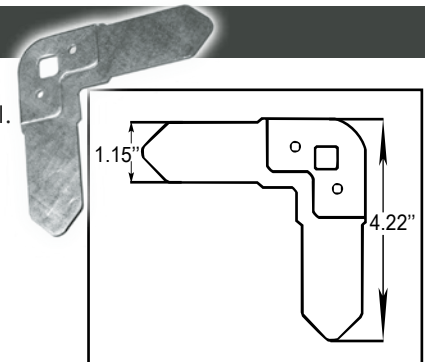

Quad Corner

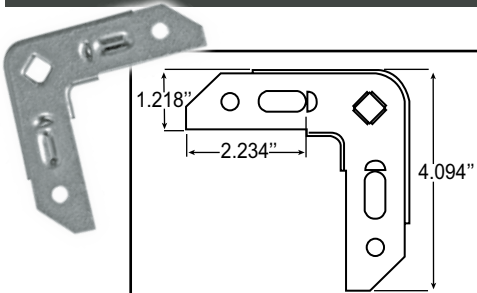

Item #	Code	Description	Packaging	Weight (lbs.)
21270	DDEJ	Quad Corner	250/Box	33
21277	DDEJ-AL	Aluminum J Quad Corner	250/Box	13
21278	DDEJ-SS	Stainless Steel J Quad Corner	250/Box	34

- Versatile corners that eliminates the need to stock multiple corners!
- Compatible with Dyn-O-Mate[®] J, Ductmate[™] 35, CL Ward[™] J, Ward Industries[™] J, and Hardcast[™] flanges, TDC & TDF connections.
- 16 gauge - The unique design of this corner results in performance like that expected from heavier gauge, but at a lower cost.
- Other materials available upon request.

TDC Corners

Transverse Duct Connection Systems (TDC) are produced by shops using flange forming machines. Like standard flange systems, they are designed to strengthen the duct

wall. Dyn-O-Mate TDC Corners assist with the duct strengthening and connecting the duct sections together. All Dyn-O-Mate TDC Corners are a skid qty of 48 boxes except part #21245 Cornermatics which are 64 Boxes.

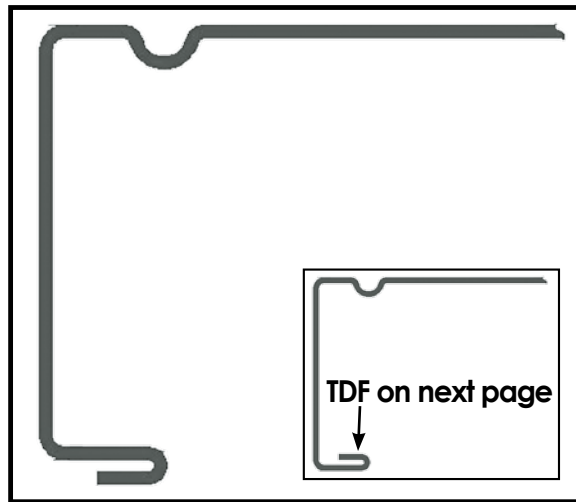

TDC Corners

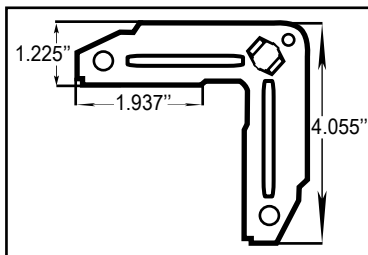
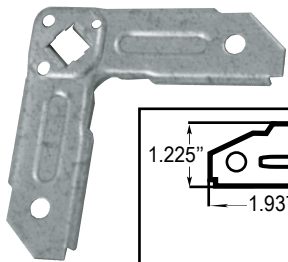

- TDC corners are designed for manual insertion on TDC connections.
- Manufactured of 16 gauge steel
- Nuts and Bolts are sold separately. (See page 10)

Item #	Code	Description	Packaging
21254	DOMC	TDC Corner	250/Box
21280	DDC-SS	TDC Stainless Steel Corner 300 Series	250/Box
21281	DDC-AL	TDC Aluminum Corner	250/Box
21284	DDC-316SS	TDC Stainless Steel Corner 316 Series	250/Box

TDC Stackable Corners

- Stackable TDC corners are for use in corner insertion machines
- Manufactured from 16-gauge steel.
- TDC corners are designed for use on TDC connections.
- Available to ship as Stacked or Unstacked

Item #	Code	Description	Packaging
21020	TDCS	Stackable TDC Corner	250/Box
21022	TDCUS	Unstacked Stackable TDC Corner*	250/Box
21245	DDCS	TDC Stackable Cornermatic™ Corner	250/Box
21264	DDCS-SS	Stackable TDC Cornermatic™ Corner - Stainless Steel	250/Box
21265	DDCS-AL	Stackable TDC Cornermatic™ Corner - Aluminum	250/Box

*20122 stackables are packed unstacked for manual insertion.

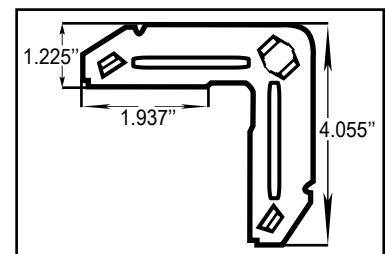
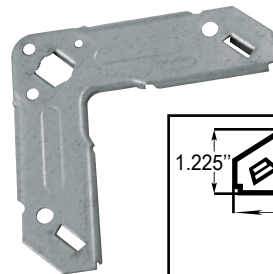

Be sure to check out the Crimper Tool for use with TDC/TDF corners on page 17.

TDF Corners

Transverse Duct Flange Systems (TDF) are produced by shops using flange forming machines. Like standard flange systems, they're designed to strengthen the duct wall. Dyn-O-Mate TDF

Corners assist with the duct strengthening and connecting the duct sections together. All Dyn-O-Mate TDF Corners are a skid qty of 48 boxes except part #21246 Cornermatics which are 64 Boxes.

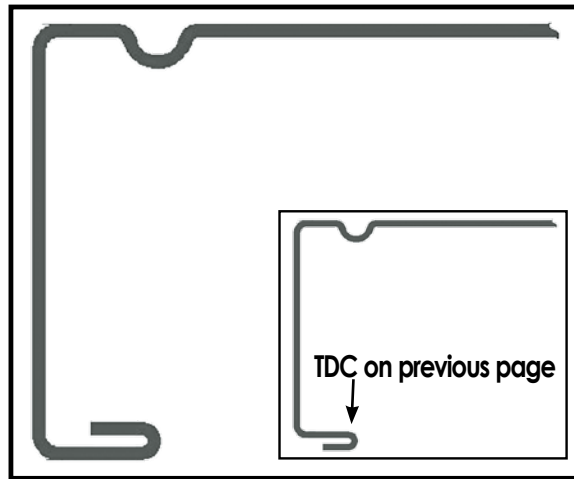

TDF Corners

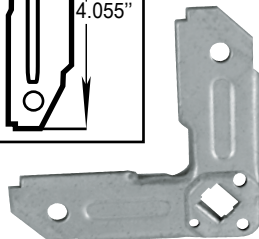
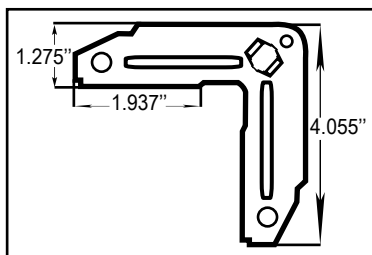

- TDF corners are designed for manual insertion on TDF connections.
- Manufactured from 16-gauge steel.
- Nuts and Bolts are sold separately. (See page 10)

Item #	Code	Description	Packaging
21255	DOMF	TDF Corner	250/Box
21282	DDF-SS	TDF Stainless Steel Corner 300 Series	250/Box
21283	DDF-AL	TDF Aluminum Corner	250/Box
21285	DDF-316SS	TDF Stainless Steel Corner 316 Series	250/Box

TDF Stackable Corners

- Stackable TDF corners are for use in corner insertion machines
- Manufactured from 16-gauge steel.
- TDF corners are designed for use on TDF connections.
- Available to ship as Stacked or Unstacked
- Nuts and Bolts are sold separately. (See page 10)

Item #	Code	Description	Packaging
21021	TDFS	Stackable TDF Corner	250/Box
21023	TDFUS	Unstacked Stackable TDF Corner*	250/Box
21246	DDFS	TDF Stackable Cornermatic™ Corner	250/Box
21010	TDFS-AL	Stackable TDF Corner - Aluminum	250/Box
21011	TDFS-SS	Stackable TDF Corner - Stainless Steel	250/Box

*20123 stackables are packed unstacked for manual insertion.

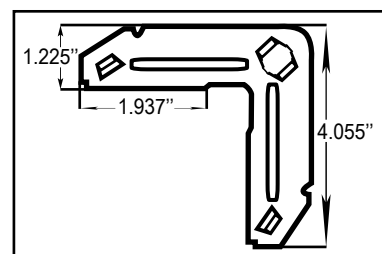

DDFS Stackable

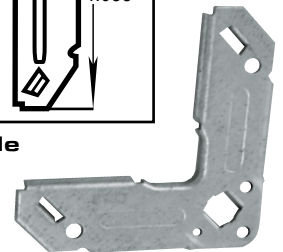

Be sure to check out the Crimper Tool for use with TDC/TDF corners on page 17.

Cleats

firmly secure together two flange connections for a more air tight seal. SMACNA recommends use of 6" cleats at 15" centers maximum for 3 " WG or less and at 12" centers maximum for higher pressures. For installation tools, see page 17.

Installation Recommendations

- 1/2" to 2" sp - 1 piece on 24" centers
- 2" to 3" sp - 1 piece on 18" centers
- 4" to 6" sp - 1 piece on 12" centers
- Over 10" sp - continuous cleat

Dyn-O-Mate Cleats

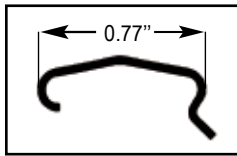

- All Dyn-O-Mate Cleats are for use on all Dyn-O-Mate J & H Flange styles.
- 20 gauge flanges for airtight duct connections.
- DOM-CLT is manufactured from 20 gauge galvanized steel 6" pieces.
- DOM-PCLT is extruded .070" PVC and designed for breakaway connection needs.

Item #	Code	Description	Packaging
21250	DOMCLT	6in. Metal Cleat	500/Box (250ft.)
21252	DOMPCLT	6in. Plastic Cleat	500/Box (250ft.)

Quad Cleats

- DOMQCLT & HDQC-PLUS are compatible with Dyn-O-Mate™ J, Ductmate™ 35, CL Ward™ J, Ward Industries™ J, Hardcast™ flanges, TDC, TDF and TD Connections, and manufactured from 22 gauge steel.
- HDQC-PLUS is recommended for high pressure, heavy duty transverse duct.
- Both the Quad Cleat and Quad Cleat Plus incorporate embossed "darts" which help the cleat lock firmly onto the flange.

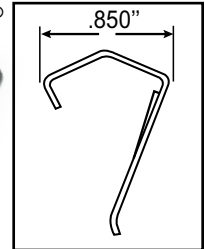
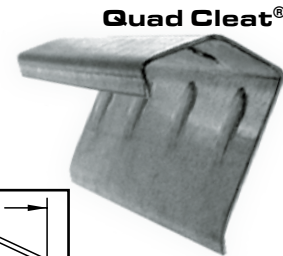

Item #	Code	Description	Packaging
21259	DOMQCLT	5-3/4in. Metal Quad Cleat®	500/Box (240ft.)
21269	HDQC-PLUS	6in. Heavy Duty Quad Cleat	500/Box (250ft.)
21228	HDQC-PLUS-SS	Stainless Steel 6in. Heavy Duty Quad Cleat	500/Box (250ft.)

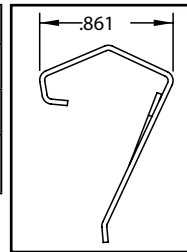

TDC/TDF Cleats

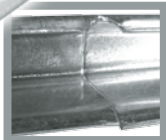

Breakaway

- TDF-CLT is used with TDF connection, TDC-CLT is used with TDC connection.
- TDC/TDF-2230 is 22 gauge steel formed into lengths of 30" long and divided into five 6" cleats that are partially cut through allowing them to be easily separated into 6" pieces.

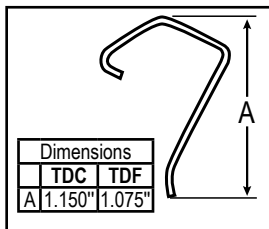

Item #	Code	Description	Packaging
30" Pieces			
13230	TDC2230	TDC 6in. Metal (Pre-Scored Cleat)	60-30in. pcs. (150ft.)
13231	TDF2230	TDF 6in. Metal (Pre-Scored Cleat)	60-30in. pcs. (150ft.)

TDF Plastic Cleat

- TDF-PCLT is extruded .070" PVC and designed for breakaway connection needs.

Item #	Code	Description	Packaging
6" Pieces			
21253	TDFPCLT	TDF 6in. Plastic	500/Box (250ft.)

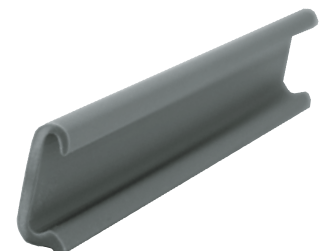
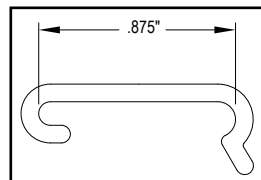

Hanging Strap

from Duro Dyne is available in perforated, coiled or flat styles. All styles offer a versatile product used for hanging ductwork. They feature convenient packaging that sets us apart from the competition.

from Duro Dyne is available in perforated, coiled or flat styles. All styles offer a versatile product used for hanging ductwork. They feature convenient packaging that sets us apart from the competition.

Perforated Galvanized Strap



- Perforated Galvanized Strap has alternating hole sizes to accommodate sheet metal screws as well as nut & bolt combinations.
- Scalloped edges and no burrs

Item #	Code	Description	Packaging
13249	PGS24	Perforated Galvanized Strap-3/4 in.-24ga.	100ft. roll/Box

Perforated Galvanized Strap (Straight Edge)

- 3-7/8" spacing between holes; 3/16" diameter

Item #	Code	Description	Packaging
13339	PGS261	Perforated Galvanized Strap-1 in.-26ga.	100ft. roll/Box
13343	PGS281	Perforated Galvanized Strap-1 in.-28ga.	100ft. roll/Box
13168	PGS301-100	Perforated Galvanized Strap-1 in.-30ga.	100ft. roll/Box
13169	PGS3015-100	Perforated Galvanized Strap-1-1/2in.-30ga.	100ft. roll/Box

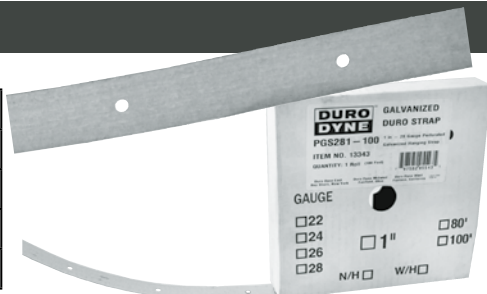

Coiled Duro Strap



- Coiled Duro Strap is manufactured from 16, 18, 22, 24, 26, 28 and 30 gauge steel.
- Coiled straps make it convenient to carry and easy to cut without wasting material.
- Dispenses straight from the carton



Item #	Code	Description	Packaging
13250	GS161-200	Galvanized Duro Strap-1in. - 16ga.	200ft./Box
13251	GS181-200	Galvanized Duro Strap-1in. - 18ga.	200ft./Box
13252	GS221-200	Galvanized Duro Strap-1in. - 22ga.	200ft./Box
13253	GS241-200	Galvanized Duro Strap-1in. - 24ga.	200ft./Box
13254	GS261-200	Galvanized Duro Strap-1in. - 26ga.	200ft./Box
13285	GS221-100	Galvanized Duro Strap-1in. - 22ga.	100ft./Box
13291	GS241-100	Galvanized Duro Strap-1in. - 24ga.	100ft./Box
13292	GS261-100	Galvanized Duro Strap-1in. - 26ga.	100ft./Box
13281	GS281-100	Galvanized Duro Strap-1in. - 28ga.	100ft./Box
13166	GS301-100	Galvanized Duro Strap-1in. - 30ga	100ft./Box
13286	GS2215-100	Galvanized Duro Strap-1-1/2in. - 22ga.	100ft./Box
13294	GS2415-100	Galvanized Duro Strap-1-1/2in. - 24ga.	100ft./Box
13295	GS2615-100	Galvanized Duro Strap-1-1/2in. - 26ga.	100ft./Box
13282	GS2815-100	Galvanized Duro Strap-1-1/2in. - 28ga.	100ft./Box
13167	GS3015-100	Galvanized Duro Strap-1-1/2in. - 30ga	100ft./Box

Flat Hanging Strap

- Flat Hanging Strap is manufactured from 16, 18, 22, and 24 gauge steel.
- Flat Hanging Strap is sold in pre-cut lengths of 10ft.
- Proudly Union Made in USA.

Item #	Code	Description	Packaging (per bundle)
13269	HS1410	14ga. Galvanized Hanging Strap-1in.	10-10ft. pcs.
13270	HS1610	16ga. Galvanized Hanging Strap-1in.	10-10ft. pcs.
13271	HS1810	18ga. Galvanized Hanging Strap-1in.	10-10ft. pcs.
13274	HS2010	20ga. Galvanized Hanging Strap-1in.	10-10ft. pcs.
13272	HS2210	22ga. Galvanized Hanging Strap-1in.	10-10ft. pcs.
13273	HS2410	24ga. Galvanized Duro Strap-1in.	10-10ft. pcs.



Color-coded ends to differentiate gauges. See page 2. Shrink-wrapped on both ends.

How the competition packs hanging strap



Dyn-O-Strut, Threaded Rod & Accessories

Hanging ductwork, equipment, wiring trays or other building components requires secure structural assemblies. These assemblies are comprised of support members attached to building anchor points with fasteners. The support members are often lengths of strut or angle iron. The fastener frequently is threaded rod combined with washers and nuts.

Dyn-O-Strut

- *Pre-Galvanized ASTM A-653 grade 33 steel sheet zinc coated by hot dip process
- Cold-formed to size from low carbon strip steel
- Slotted at 2" centers

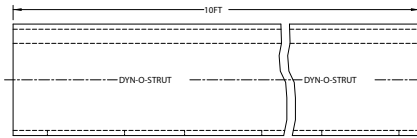

Item #	Code	Description	Packaging
13045	DS1210-158	1-5/8x1-5/8x10ft 12 GA Slotted Dyn-O-Strut - Deep	500ft/Bundle
13049	DS1410-158	1-5/8x1-5/8x10ft 14 GA Slotted Dyn-O-Strut - Deep	500ft/Bundle
13047	DS1410-1316	13/16x1-5/8x10ft 14 GA Slotted Dyn-O-Strut - Shallow	500ft/Bundle

Threaded Rod

- Available in the following sizes:
 - 1/4" – 20 threads per inch
 - 3/8" – 16 threads per inch
 - 1/2" – 13 threads per inch
 - 5/8" – 11 threads per inch
 - 3/4" – 10 threads per inch
- Shipped in sturdy cardboard tubes
- Zinc Plated

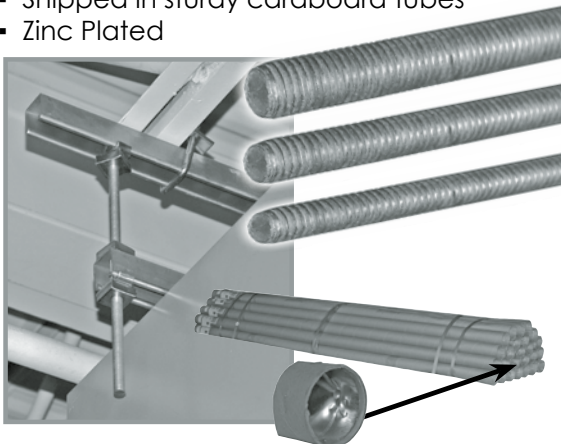

Item #	Code	Description	Packaging
21164	TR14ZP06	1/4in Threaded Rod 6ft	50 / Tube
21165	TR38ZP06	3/8in Threaded Rod 6ft	25 / Tube
21166	TR12ZP06	1/2in Threaded Rod 6ft	12 / Tube
21161	TR58ZP06	5/8in Threaded Rod 6ft- Made in the U.S.A.	8 / Tube
21162	TR34ZP06	3/4in Threaded Rod 6ft- Made in the U.S.A.	5 / Tube
21167	TR14ZP10	1/4in Threaded Rod 10ft	50 / Tube
21168	TR38ZP10	3/8in Threaded Rod 10ft	25 / Tube
21169	TR12ZP10	1/2in Threaded Rod 10ft	12 / Tube
21163	TR14ZP12USA	1/4in Threaded Rod 12ft - Made in the U.S.A.	50 / Tube
21159	TR38ZP12USA	3/8in Threaded Rod 12ft - Made in the U.S.A.	25 / Tube
21160	TR12ZP12USA	1/2in Threaded Rod 12ft - Made in the U.S.A.	12 / Tube
21188	TR38ZP12	3/8in Threaded Rod 12ft	25 / Tube
21189	TR12ZP12	1/2in Threaded Rod 12ft	12 / Tube

Accessories

Fender Washers

Item #	Code	Description	Packaging
21276	FDW12B	1/2in x 1.5in Fender Washer Bulk	50 lbs/box
21273	FDW12C	1/2in x 1.5in Fender Washer	100 pcs/box
21274	FDW14B	1/4in x 1.5in Fender Washer Bulk	50 lbs/box
21271	FDW14C	1/4in x 1.5in Fender Washer	100 pcs/box
21275	FDW38B	3/8in x 1.5in Fender Washer Bulk	50 lbs/box
21272	FDW38C	3/8in x 1.5in Fender Washer	100 pcs/box



Flat Washers

Item #	Code	Description	Packaging
21106	FW12B	1/2in Flat Washer Bulk	50 lbs/box
21107	FW12C	1/2in Flat Washer	100 pcs/box
21133	FW14B	1/4in Flat Washer Bulk	50 lbs/box
21134	FW14C	1/4in Flat Washer	100 pcs/box
21140	FW38B	3/8in Flat Washer Bulk	50 lbs/box
21141	FW38C	3/8in Flat Washer	100 pcs/box



Threaded Rod & Accessories

Nuts & Bolts

Item #	Code	Description	Packaging
21132	HN12B	1/2in-13 Hex Nut	1800/Box
21131	HN12C	1/2in-13 Hex Nut	100/Box
21077	HN14B	1/4in-20 Hex Nut Bulk	9000/Box
21069	HN14C	1/4in-20 Hex Nut	100/Box
21066	HN38B	3/8in-16 Hex Nut Bulk	3000/Box
21067	HN38C	3/8in-16 Hex Nut	100/Box
21086	HN38CSS	3/8in 302 Stainless Hex Nut	100/Box
21060	DOMNB38	3/8in Nuts & Bolts	125/Bag
21061	DOMNB14	1/4in Nuts & Bolts	125/Bag
21065	DOMB381B	3/8in-16 x 1 Bolt Bulk	1000/Box
21068	DOMB381C	3/8in-16 x 1 Bolt	100/Box
21087	DOMB381CSS	3/8in x 1 in. 304 Stainless Bolt	100/Box
21063	DOMB38114B	3/8in-16 x 1-1/4 Bolt Bulk	1000/Box
21064	DOMB38112B	3/8in-16 x 1-1/2 Bolt Bulk	800/Box
21218	HN38P1	3/8in-16 Hex Nut - 1gallon Pail	1000/Pail
21219	DOMB381P1	3/8in-16 x 1 Bolt - 2 gallon Pail	1000/Pail
21229	HN38P3	3/8in-16 Hex Nut - 2 gallon Pail	3000/Pail
13192	B381P1C	3/8in-16 x 1 Bolts in Quart Pail	100/Pail
13196	HN38P1C	3/8in-16 Hex Nut in Pint Pail	100/Pail

Rod Couplings

Item #	Code	Description	Packaging	Weight (lbs.)
21127	STRC12B	1/2in Rod Coupling-1-1/4in Long	800/Box	46.32
21130	STRC12C	1/2in Rod Coupling-1-1/4in Long	100/Box	7.04
21125	STRC14B	1/4in Rod Coupling-7/8in Long	2500/Box	46.25
21128	STRC14C	1/4in Rod Coupling-7/8in Long	100/Box	1.85
21126	STRC38B	3/8in Rod Coupling-1-1/4in Long	1250/Box	88
21129	STRC38C	3/8in Rod Coupling-1-1/4in Long	100/Box	5.79



Beam Clamps

The Beam Clamp is a structural attachment to the top or bottom of metal I-beams, purlins, channel, or angle iron. It comes in both a large or small mouth and an Electro-Galvanized or plain finish. It is available for 3/8" and 1/2" threaded rod.

- Hardened steel Cup Point Set screw.
- Complies with: Cast Clamps: Federal Specification A-A-1192A (Type 19) and MSS SP-69 (Type 19).
Stamped Clamps: Federal Specification A-A-1192A (Type 23) and MSS SP-69 (Type 23).
- **Maximum Load Limits:**
 - Small mouth 3/8 in: max load= 400lbs
 - Small mouth 1/2 in: max top load=950lbs max bottom load=760lbs
 - Large mouth 3/8 in: max top load=500lbs max bottom load=250lbs
 - Steel C clamp 3/8 in: max load=250lbs
- Designed to provide attachment of various hanger rods to structural members without drilling or welding
- UL Listed and FM approved.



Item #	Code	Description	Packaging
13179	BC5N38	3/8in Plated Small Mouth Cast Beam-Clamp w/ Lock Nut	100/Box
13189	BC12NS	1/2in Plated Small Mouth Cast Beam-Clamp w/ Lock Nut	100/Box
13191	BC38NL	3/8in Plated Large Mouth Cast Beam-Clamp w/ Lock Nut	50/Box
13184	CCN38	3/8in Plated Stamped C-Clamp w/ Lock Nut	100/Box

Flat Drive

Flat Drive

- Designed to secure the connection for lighter ductwork applications.
- Perfect for lighter gauge and residential ductwork applications.
- Tapered ends for an easy start.
- Available in 5ft., 8ft., or 10ft. lengths.

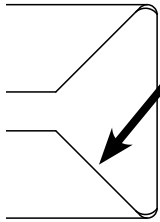

Tapered end to easily start over drives.

Item #	Code	Description	Packaging
13255	FD2410	24ga. Flat Drive 10ft.	10-10ft. pcs./Bundle
13211	FD2405	24ga. Flat Drive 5ft.	10-5ft. pcs./Bundle
13257	FD2610	26ga. Flat Drive 10ft.	10-10ft. pcs./Bundle
13342	FD2608	26ga. Flat Drive 8ft.	10-8ft. pcs./Bundle
13218	FD2605	26ga. Flat Drive 5ft.	10-5ft. pcs./Bundle
13200	FD2810	28ga. Flat Drive 10ft.	10-10ft. pcs./Bundle
13199	FD2808	28ga. Flat Drive 8ft.	10-8ft. pcs./Bundle
13198	FD2805	28ga. Flat Drive 5ft.	10-5ft. pcs./Bundle
13262	FDSS2410	Stainless Steel Flat Drive 10ft.	10-10ft. pcs./Bundle
13260	FDAL2410	Aluminum Flat Drive 10ft.	10-10ft. pcs./Bundle

Cut-To-Length Flat Drive Cleat - with tab

Cut To Length products are made to order.

PLEASE ALLOW A 2-3 WEEK LEAD TIME.

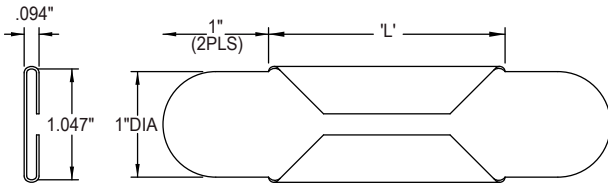

Item #	Code	Description	Packaging
13308	FDC0624	24 gage 6in Flat Drive	100/Box
13350	FDC0824	24 gage 8in Flat Drive	100/Box
13351	FDC1024	24 gage 10in Flat Drive	100/Box
13352	FDC1224	24 gage 12in Flat Drive	100/Box
13353	FDC1424	24 gage 14in Flat Drive	100/Box
13354	FDC1624	24 gage 16in Flat Drive	100/Box
13355	FDC1824	24 gage 18in Flat Drive	100/Box
13356	FDC2024	24 gage 20in Flat Drive	100/Box
13357	FDC2224	24 gage 22in Flat Drive	100/Box
13358	FDC2424	24 gage 24in Flat Drive	100/Box
13340	FDC8	26 gage 8in Flat Drive	100/Box
13341	FDC10	26 gage 10in Flat Drive	100/Box

Cut-To-Length Flat Drive Cleat - no tab

Cut To Length products are made to order. **PLEASE ALLOW A 2-3 WEEK LEAD TIME.**

All Cut-To-Length Flat Drive Cleats are sold 100/box.

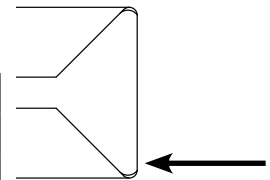

Item #	Code	Description
13307	FDCNT0624	24 Gauge 6in Flat Drive
13033	FDCNT0824	24 Gauge 8in Flat Drive
13035	FDCNT1024	24 Gauge 10in Flat Drive
13037	FDCNT1224	24 Gauge 12in Flat Drive
13039	FDCNT1424	24 Gauge 14in Flat Drive
13041	FDCNT1624	24 Gauge 16in Flat Drive
13043	FDCNT1824	24 Gauge 18in Flat Drive

Item #	Code	Description
13331	FDCNT1026	26 Gauge 10in Flat Drive
13332	FDCNT1226	26 Gauge 12in Flat Drive
13333	FDCNT1426	26 Gauge 14in Flat Drive
13334	FDCNT1626	26 Gauge 16in Flat Drive
13335	FDCNT1826	26 Gauge 18in Flat Drive
13336	FDCNT2026	26 Gauge 20in Flat Drive
13337	FDCNT2426	26 Gauge 24in Flat Drive
13338	FDCNT3626	26 Gauge 36in Flat Drive

Flat S

Flat S Lock

- Designed to secure the connection for lighter ductwork applications.
- Available in 5ft., 8ft, or 10ft. lengths.

Item #	Code	Description	Packaging
13256	FS2410	24ga. Flat S Lock 10ft.	10-10ft. pcs./Bundle
13213	FS2405	24ga. Flat S Lock 5ft.	10-10ft. pcs./Bundle
13258	FS2610	26ga. Flat S Lock 10ft.	10-10ft. pcs./Bundle
13330	FS2608	26ga. Flat S Lock 8ft.	10-8ft. pcs./Bundle
13219	FS2605	26ga. Flat S Lock 5ft.	10-8ft. pcs./Bundle
13195	FS2810	28ga. Flat S Lock 10ft.	50-5ft. pcs./Bundle
13194	FS2808	28ga. Flat S Lock 8ft.	10-5ft. pcs./Bundle
13193	FS2805	28ga. Flat S Lock 5ft.	10-5ft. pcs./Bundle
13277	FSSS2410	300 Series Stainless Steel Flat S Lock 10ft.	10-10ft. pcs./Bundle
13275	FSAL2410	Aluminum Flat S Lock 10ft.	10-10ft. pcs./Bundle

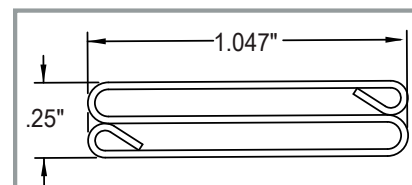
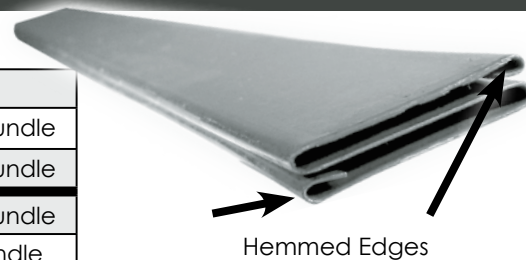

Cut-To-Length Flat S Lock

Cut To Length products are made to order. **PLEASE ALLOW A 2-3 WEEK LEAD TIME.**
All Cut-To-Length Flat S Lock are sold 100/box.

Item #	Code	Description	Item #	Code	Description
13306	FSC0624	24 gage 6in Flat S Lock	13320	FSC08	26 gage 8in Flat S Lock
13310	FSC0824	24 gage 8in Flat S Lock	13321	FSC10	26 gage 10in Flat S Lock
13311	FSC1024	24 gage 10in Flat S Lock	13322	FSC12	26 gage 12in Flat S Lock
13312	FSC1224	24 gage 12in Flat S Lock	13323	FSC14	26 gage 14in Flat S Lock
13313	FSC1424	24 gage 14in Flat S Lock	13324	FSC15	26 gage 15in Flat S Lock
13314	FSC1524	24 gage 15in Flat S Lock	13325	FSC16	26 gage 16in Flat S Lock
13315	FSC1624	24 gage 16in Flat S Lock	13326	FSC18	26 gage 18in Flat S Lock
13316	FSC1824	24 gage 18in Flat S Lock	13327	FSC20	26 gage 20in Flat S Lock
13317	FSC2024	24 gage 20in Flat S Lock	13328	FSC22	26 gage 22in Flat S Lock
13318	FSC2224	24 gage 22in Flat S Lock	13329	FSC24	26 gage 24in Flat S Lock
13319	FSC2424	24 gage 24in Flat S Lock			

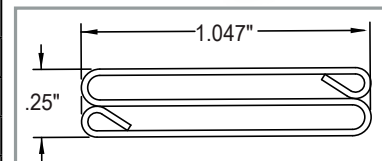
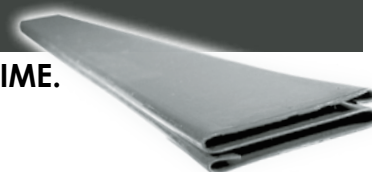

Standing S

Standing S

- Designed to reinforce the connection on wider ductwork applications.
- Available in 5ft. or 10ft. lengths.
- Hem for easy raw duct insertion.

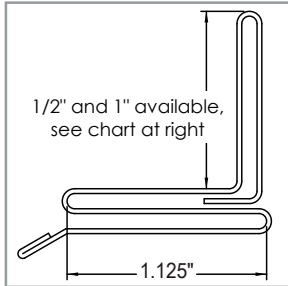
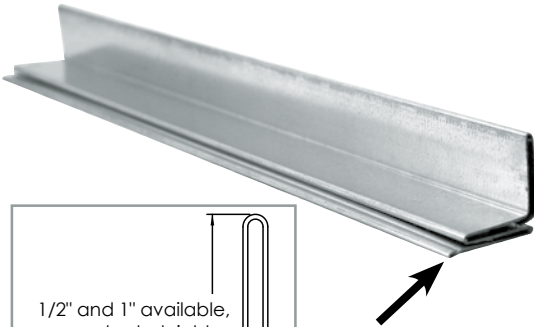

Item #	Code	Description	Packaging
13235	SS2210	22ga. 1in. Standing S 10ft.	10-10ft. pcs./Bundle
13214	SS2410	24ga. 1in. Standing S 10ft.	10-10ft. pcs./Bundle
13216	SS12-2405	24ga. 1/2in. Standing S 5ft.	50-5ft. pcs./Bundle
13201	SS12-2410	24ga. 1/2in. Standing S 10ft.	10-10ft. pcs./Bundle
13215	SS2610	26ga. 1in. Standing S 10ft.	10-10ft. pcs./Bundle
13237	SS2605	26ga. 1in. Standing S 5ft.	10-5ft. pcs./Bundle
13228	SS12-2610	26ga. 1/2in. Standing S 10ft.	10-10ft. pcs./Bundle
13212	SS12-2605	26ga. 1/2in. Standing S 5ft.	50-5ft. pcs./Bundle
13217	SSSS2410	300 Series Stainless Steel Standing S 10ft.	10-10ft. pcs./Bundle
13210	SSAL2410	Aluminum Standing S 10ft.	10-10ft. pcs./Bundle

Cut-To-Length Standing S

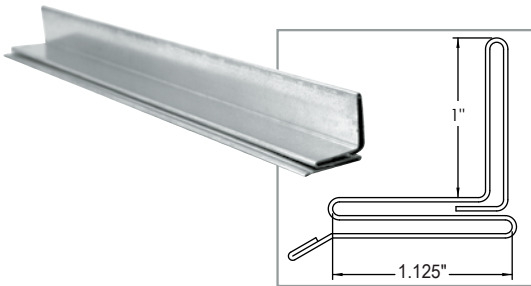

Item #	Code	Description	Packaging
13129	SS19524	24 gage 19-1/2in Standing S Lock 1in	50/Box
13130	SS21524	24 gage 21-1/2in Standing S Lock 1in	50/Box
13131	SS23524	24 gage 23-1/2in Standing S Lock 1in	50/Box
13132	SS25524	24 gage 25-1/2in Standing S Lock 1in	50/Box
13133	SS27524	24 gage 27-1/2in Standing S Lock 1in	50/Box
13134	SS29524	24 gage 29-1/2in Standing S Lock 1in	50/Box

Access Doors

Dyn-O-Mate Clamshell style Access Doors are available insulated or uninsulated and tested to withstand 20" W.G. positive pressure & 10" of negative pressure. They feature a closed Cell Neogasket and a bond to the inside plate that prevents leakage. Conical Springs between the two plates provides for easy installation and high impact plastic knobs are designed to avoid stripping and allow a tool-free operation. A template for duct-opening cut out is supplied to insure proper hole size.

Flat Access Doors For Rectangular Duct



Insulated For Rectangular Duct

Item #	Code	Description	Packaging
21177	MFADI48	4X8 FLAT Insulated Access Door	10 Pcs./Box
21178	MFADI812	8X12 FLAT Insulated Access Door	10 Pcs./Box
21179	MFADI1216	12X16 FLAT Insulated Access Door	5 Pcs./Box

*High Temperature & other sizes available upon request.

Uninsulated For Rectangular Duct

Item #	Code	Description	Packaging
21170	MFADU48	4X8 FLAT UN-IAD	10 Pcs./Box
21171	MFADU812	8X12 FLAT UN-IAD	10 Pcs./Box
21172	MFADU1216	12X16 FLAT UN-IAD	5 Pcs./Box

Round Access Doors For Round Duct

Insulated For Round Duct

4 x 8 Round Access Doors			
Item #	Code	Description	Packaging
21135	MRADI48-7	4X8-7RD Insulated Access Door	10 Pcs./Box
21137	MRADI48-11	4X8-11RD Insulated Access Door	10 Pcs./Box
21138	MRADI48-14	4X8-14RD Insulated Access Door	10 Pcs./Box
8 x 12 Round Access Doors			
Item #	Code	Description	Packaging
21144	MRADI812-14	8X12-14RD Insulated Access Door	10 Pcs./Box
21146	MRADI812-18	8X12-18RD Insulated Access Door	10 Pcs./Box
21148	MRADI812-22	8X12-22RD Insulated Access Door	10 Pcs./Box
12 x 16 Round Access Doors			
Item #	Code	Description	Packaging
21151	MRADI216-18	12X16-18RD Insulated Access Door	5 Pcs./Box
21154	MRADI1216-24	12X16-24RD Insulated Access Door	5 Pcs./Box
21156	MRADI1216-30	12X16-30RD Insulated Access Door	5 Pcs./Box
21157	MRADI1216-36	12X16-36RD Insulated Access Door	5 Pcs./Box



Uninsulated For Round Duct

4 X 8 ROUND ACCESS DOORS			
Item #	Code	Description	Packaging
21101	MRADU48-7	4X8-7RD UN-IAD	10 Pcs./Box
21103	MRADU48-11	4X8-11RD UN-IAD	10 Pcs./Box
21104	MRADU48-14	4X8-14RD UN-IAD	10 Pcs./Box
8 X 12 ROUND ACCESS DOORS			
Item #	Code	Description	Packaging
21110	MRADU812-14	8X12-14RD UN-IAD	10 Pcs./Box
21112	MRADU812-18	8X12-18RD UN-IAD	10 Pcs./Box
21114	MRADU812-22	8X12-22RD UN-IAD	10 Pcs./Box
12 X 16 ROUND ACCESS DOORS			
Item #	Code	Description	Packaging
21117	MRADU1216-18	12X16-18RD UN-IAD	5 Pcs./Box
21120	MRADU1216-24	12X16-24RD UN-IAD	5 Pcs./Box

High Temp. Access Doors

Access doors are used in duct systems for many reasons. Entry is often required to facilitate duct cleaning, examine equipment, or to test, repair, and troubleshoot system components.

Duro Dyne high temperature access doors are designed for use in duct systems with temperatures of up to 2000°F. The door is comprised of two steel plates attached to each other with spring loaded threaded studs. High temperature access doors are shipped with a self-stick template to simplify installation. Once the hole is cut, the two wing nuts on the door are loosened and the door is inserted into the duct at an angle so that the duct wall can be situated between the access door's lower and upper plates. The two wing nuts are then tightened; sealing the duct opening between the two door plates.

Flat Uninsulated High Temp Access Doors



- Single Unit with No Pieces to Assemble
- All Steel Construction with Grease Tight Seal
- Stick-On Template for Cutting Hole
- Easy Slide-In and Fasten with Wing Nuts
- High-Temperature 2000°F Ceramic Gasket and Washer
- Optional FSB Cover Plate with Easy Remove Handle
- Complies with N.F.P.A. 96-Edition Section-4 Guidelines
- Complies with UL Construction Requirements
- Union Made in the U.S.A.

Item #	Code	Description	Packaging
21190	MHTAD2000804	2000 Degree Door Only 8x4	10 Pcs./Box
21191	MHTAD201208	2000 Degree Door Only 12x8	10 Pcs./Box
21192	MHTAD201612	2000 Degree Door Only 16x12	5 Pcs./Box
21195	MHTADC200804	2000 Degree Door w/Plate 8x4	10 Pcs./Box
21196	MHTADC201208	2000 Degree Door w/Plate 12x8	10 Pcs./Box
21197	MHTADC201612	2000 Degree Door w/Plate 16x12	5 Pcs./Box

Grease Duct Doors

Duro Dyne Grease Duct Doors (GDD) are manufactured to meet or exceed all mechanical codes.

They are UL Listed and manufactured of 16 gauge steel. They feature a high temp resistant gasket to ensure the ultimate protection for your grease duct application.

Grease Duct Doors

- For installation into grease ducts
- Meets or exceeds requirements of all mechanical codes
- Bolt in unit easily installed into existing ductwork
- Removeable door panel
- High temperature resistant gasket

Item #	Code	Description
13001	DDGD0707UL	7X7 Grease Duct Bolt In Access Door
13002	DDGD0712UL	7X12 Grease Duct Bolt In Access Door
13003	DDGD0720UL	7X20 Grease Duct Bolt In Access Door
13004	DDGD1212UL	12X12 Grease Duct Bolt In Access Door
13005	DDGD1220UL	12X20 Grease Duct Bolt In Access Door
13006	DDGD1620UL	16X20 Grease Duct Bolt In Access Door
13007	DDGD2020UL	20X20 Grease Duct Bolt In Access Door

Doors are packaged 1 per box.



Vane and Rail

Dyn-O-Mate Hollow Turning Vane and Rail is double wall strength.



It is designed to redirect the air through elbows and tees in the ductwork without significant loss of air pressure. Assembled Vane & Rail minimizes turbulence in the ductwork. Duro Dyne Rail has self-aligning tabs for easy vane installation. Dyn-O-Mate Vane has reinforcing dimples for added stability.

2" Vane

- 2in. Turning Vane are manufactured from 26-gauge galvanized steel.



Item #	Code	Description	Packaging (per bundle)	Master Skid Qty.
13203	HTV2-2610	2in. Turning Vane 10ft.	5-10ft. pcs.	7200ft.
13220	HTVAL2-10	Alum. 2in. Turning Vane 10ft.	5-10ft. pcs.	7200ft.
13224	HTVSS2-10	Stainless 2in. Turning Vane 10ft.	5-10ft. pcs.	7200ft.

2" Rail

- 2in. Rail is manufactured from 22-gauge galvanized steel.
- Tapered for easy entry on to the vane.

Item #	Code	Description	Packaging (per bundle)	Master Skid Qty.
13300	DHVR2-2210	2in. Vane Rail 10ft.	10-10ft. pcs.	4000ft.
13221	HVRAL2-10	Alum. 2in. Vane Rail 10ft.	10-10ft. pcs.	4000ft.
13225	HVRSS2-10	Stainless 2in. Vane Rail 10ft.	10-10ft. pcs.	4000ft.

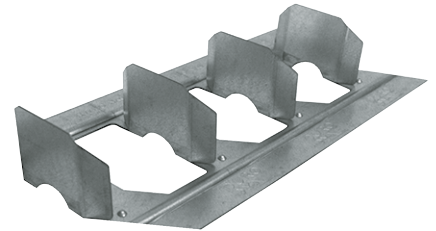

4" Vane

- 4in. Turning Vane are manufactured from 24-gauge galvanized steel.



Item #	Code	Description	Packaging (per bundle)	Master Skid Qty.
13207	HTV4-2410	4in. Turning Vane 10ft.	5-10ft. pcs.	2500ft.
13222	HTVAL4-10	Alum. 4in. Turning Vane 10ft.	5-10ft. pcs.	2500ft.
13226	HTVSS4-10	Stainless 4in. Turning Vane 10ft.	5-10ft. pcs.	2500ft.

4" Rail

- 4in. Rail is manufactured from 22-gauge galvanized steel.
- Tapered for easy entry on to the vane.

Item #	Code	Description	Packaging (per bundle)	Master Skid Qty.
13302	DHVR4-2210	4in. Vane Rail 10ft.	10-10ft.pcs.	2000ft.
13223	HVRAL4-10	Alum. 4in. Vane Rail 10ft.	10-10ft.pcs.	2000ft.
13227	HVRSS4-10	Stainless 4in. Vane Rail 10ft.	10-10ft.pcs.	2000ft.

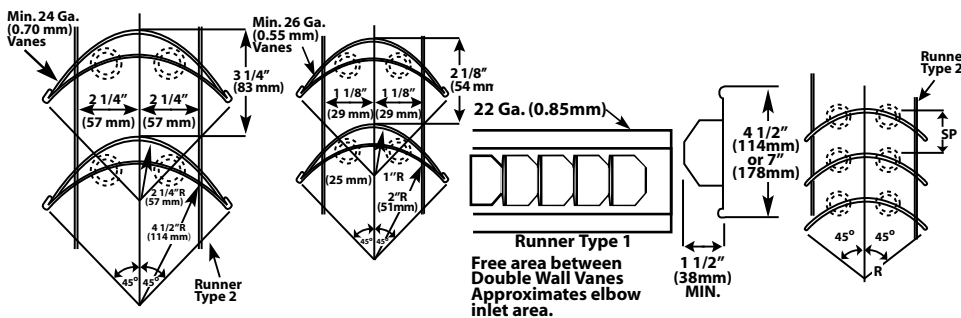
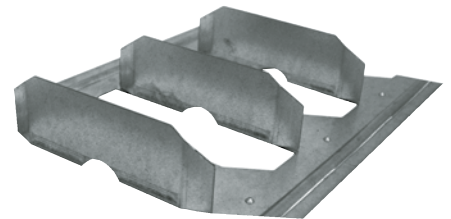

Single Vane Schedule			
	R	SP	GA
Small	2"	1 1/2"	24
	(51mm)	(38mm)	(0.70mm)
Large	4 1/2"	3 1/4"	22
	(114mm)	(83mm)	(0.85mm)

See notes on fig.2-4. Other runners may be used as appropriate. Other vane sizes, spacings or configurations are acceptable on designer approval.

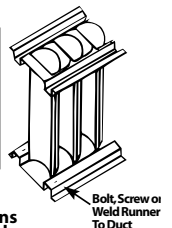

As Described on page 2.5, Figure 2-3 of the SMACNA HVAC Duct Construction Standards, 2nd Ed., 1995.

Vane Cutter

The ASVC2 2" Hollow Vane Cutter is a pneumatically powered cutting mechanism that offers a convenient and safe way to cut 2" double wall vane. It has a small footprint yet allows for large lengths of up to 10 ft vane to be cut. It uses a 110 volt power source and a 70 PSI air input so it is easily placed anywhere in a shop.

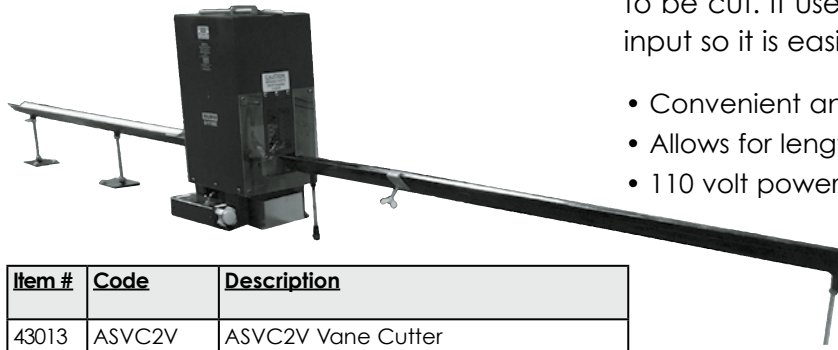

- Convenient and safe way to cut 2" double wall vane
- Allows for lengths of up to 10 ft vane to be cut
- 110 volt power source and a 70 PSI air input

Item #	Code	Description
43013	ASVC2V	ASVC2V Vane Cutter

Dyn-O-Wrap

A self-adhesive film which can protect uninstalled duct sections from the intrusion of contaminants. Available in different sizes and several varieties, including Puncture Resistant Wrap and Reverse Puncture Resistant Wrap.

- Thicker than most other duct wrapping films
- Easily removable without leaving residue
- Elongation: Twice its original length
- Weathering: UV resistant and waterproof
- Durable and flexible
- Self-adhesive surface
- Excellent adhesion to duct
- Tensile Strength: Minimum 10 psi



Dyn-O-Wrap

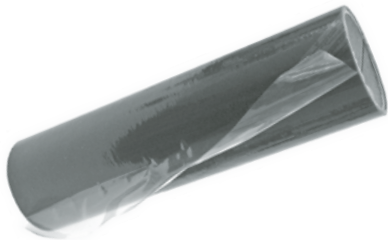

- Excellent adhesion to ductwork, yet easily removable without leaving residue.
- Color: Dark blue tint, UV resistant and waterproof
- Packaged in box

Item #	Code	Description	Packaging
13380	DW24-200	Dyn-O-Wrap 24" x 200'	6 Rolls/Box
13384	DW36-200	Dyn-O-Wrap 36" x 200'	1 Roll/Box
13388	DW48-200	Dyn-O-Wrap 48" x 200'	1 Roll/Box

Puncture Resistant Dyn-O-Wrap & Reverse Puncture Resistant Dyn-O-Wrap

- Excellent adhesion to ductwork, yet easily removable without leaving residue.
- Color: Light blue tint, UV resistant and waterproof
- Packaged in poly bag

Item #	Code	Description	Ft per roll	Packaging
13382	PRW24-200	Puncture Resistant Dyn-O-Wrap 24" x 200'	200'	1 Roll
13386	PRW36-200	Puncture Resistant Dyn-O-Wrap 36" x 200'	200'	1 Roll
13389	PRW48-200	Puncture Resistant Dyn-O-Wrap 48" x 200'	200'	1 Roll
13344	PRW24-400	Puncture Resistant Dyn-O-Wrap 24" x 400'	400'	1 Roll
13345	PRW36-400	Puncture Resistant Dyn-O-Wrap 36" x 400'	400'	1 Roll
13346	PRW48-400	Puncture Resistant Dyn-O-Wrap 48" x 400'	400'	1 Roll
13392	RPRW24-200	Reverse Puncture Resistant Dyn-O-Wrap 24" x 200'	200'	1 Roll
13393	RPRW36-200	Reverse Puncture Resistant Dyn-O-Wrap 36" x 200'	200'	1 Roll
13394	RPRW48-200	Reverse Puncture Resistant Dyn-O-Wrap 48" x 200'	200'	1 Roll

Skid Quantity is 100 Rolls.

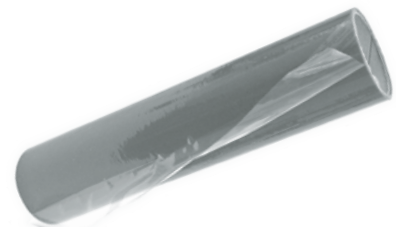

Tools

TDC/TDF Crimper Tool



The Dyn-O-Mate Crimper installs the TDC or TDF corner and crimps the edge over to hold the corner in place.

Features:

- Cast from high strength steel alloy
- Cushion grip handles
- Precision machined jaws
- High leverage crimper tool

Item #	Code	Description	Packaging
21072	DOMCRMP	TDC/TDF Crimper Tool	1 each

Cleat Tool

Install the finishing cleat quickly and easily with the Universal Magnetic Cleat Tool. The tool pulls the ductwork tight while installing the cleat and creating a quick, easy and clean seal on all size duct connections. The UMCT2 Cleat Tool features two magnets, one in the crease for holding the cleat and the second on the handle for easy storage on duct.

Item #	Code	Description	Packaging
13124	UMCT2	Universal Magnetic Cleat Tool	1 each
21051	DCTDOM	Deluxe Cleat Tool	1 each

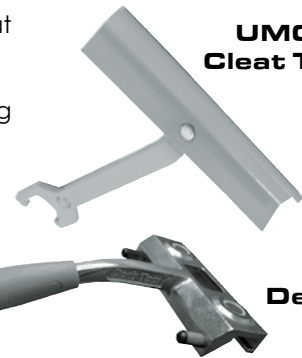

**UMCT2
Cleat Tool**

Scan for video on Magnetic Cleat Tool!



Deluxe Cleat Tool

Vane Dimpler

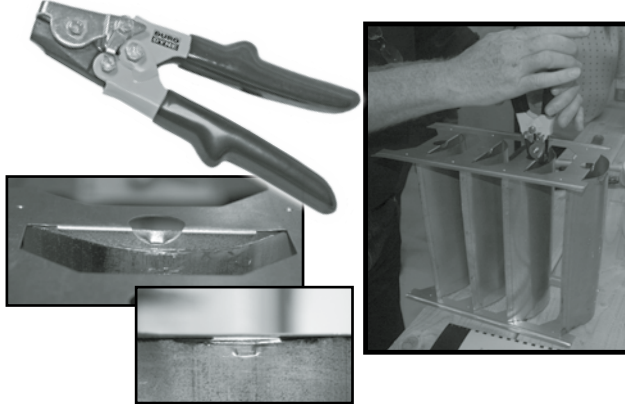

The Duro Dyne Vane Dimpler hand tool is a fast, easy way to secure vanes to rail. Designed for use with Duro Dyne tabbed (SMACNA type 1) rail and hollow vanes, the hand tool forms a locking dimple on the vanes. This dimple keeps the vane in place once it has been seated on the rail.

- Replaces tack welding, chiseling, or other awkward and time consuming methods.
- The Vane Dimpler can be used on the vane before or after placement on the rail. Either way, its locked tight!
- No other tools or welding equipment necessary.

Item #	Code	Description	Packaging
21062	DOM6	Vane Dimpler	1 each

Pittsburgh Lock Opening Tool

The Pittsburgh Lock Opening Tool is used to open a longitudinal seam that is used in the fabrication of sheet metal ductwork.

- Made of durable 30% glass filled nylon for strength and long life.
- Wide face reduces marring exposed ductwork along the leading edge of the female side of the Pittsburgh lock.
- Comfortable, ergonomic grip.
- Easily ground down to a narrower profile to fit on tighter radius elbow seams.
- Orange color is highly visible, less time searching for the tool you need.
- Tapered leading edge for easier start.

Item #	Code	Description	Packaging
10061	POT	Pittsburgh Lock Opening Tool	1



**Patent number:
8,424,361**



Gasketing

Gasket material is used to form an air tight seal at connection points. Gasketing is self stick and has a release paper to protect the adhering side. Butyl and Neoprene Gaskets offer an easy-to-

use sealant to provide a moisture and vapor-tight seal to prohibit water and dust from any connection at any atmospheric pressure.

Butyl Gasket

Used to create a permanent seal in the flange system

- Butyl gasket is a permanently soft caulking compound with a high percentage of virgin butyl rubber.
- It will adhere to most dry, clean surfaces such as steel, aluminum, plastics, wood and concrete and can withstand movement without cracking.
- Color: Gray, Black or Off White
- Temperature range: -40°F to 249°F
- Non-Corrosive

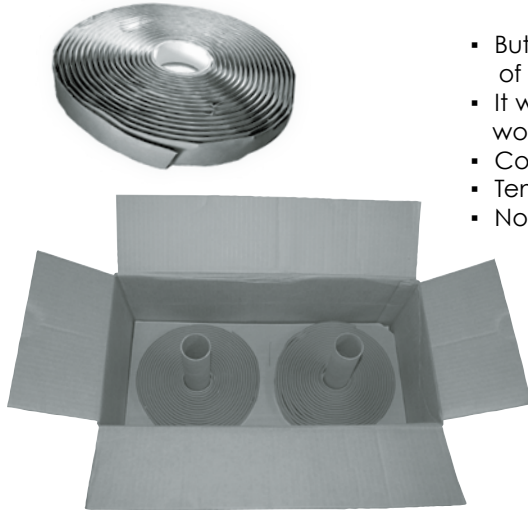

Item #	Code	Description	Packaging
21042	BTL500	Butyl Gasketing 25ft./Roll	500ft./Box
21046	BTL316-58LG	3/16in. x 5/8in. Non-UL Butyl Light Gray 25ft./Roll	500ft./Box
21047	BTL316-58DG	3/16in. x 5/8in. Non-UL UV Resistant Butyl Dark Gray 500ft./Roll	500ft./Box

Neoprene Gasket

Self-adhesive closed-cell, NBR/PVC UL723 Neoprene Gasket.

- Great for use when connecting ductwork that might periodically have to be taken apart for maintenance purposes.
- Color: Black
- Temperature range: -40°F to 220°F
- Meets ASTM C534 Grade 1, MIL-P-15280 (Form S)
- Other sizes and varieties available upon request.

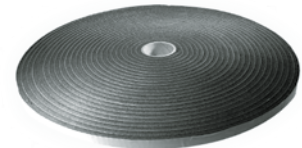

BN31634UL723

Item #	Code	Description	Packaging
6342	BN31634UL723	3/16inx3/4in Neoprene Gasketing UL723	50ft./Roll
6343	BN51634UL723	5/16inx3/4in Neoprene Gasketing UL723	50ft./Roll

For additional Neoprene Gasketing sizes and styles, please see our Air Regulation Hardware Catalog.

Conduit

Conduit is used to support duct sizes over 48" or smaller duct in high pressure applications. Duro Dyne offers conduit in 1/2" and 3/4" sizes in 10 ft. lengths.

Conduit



Item #	Code	Description	Packaging
21099	MC1210	1/2in Thin Wall Conduit - 10ft Lengths	10pcs. of 10 ft.
21100	MC3410	3/4in Thin Wall Conduit - 10ft Lengths	10pcs. of 10 ft.

Dyn-O-Loc®

Dyn-O-Loc®



Tie rods can be used to support duct sizes over 48". Dyn-O-Locs insert into the ends of the hollow tie rods to provide a means of attaching the rods to the duct. Available for use in 1/2in. and 3/4in. I.D. rods. They are easily inserted and have been **pull tested to withstand over 1900 lbs.**

- The Dyn-O-Loc Tool aids installation and assures accurate spacing.
- Large self-sealing washer
- We put the washer on the bolt, so you don't have to!
- Long bolt for easier installation
- Allows use of lighter gauge



Pre-assembled bolt with washer

Spring nut

- Locks conveniently packed in separate poly bag.

Item #	Code	Description	Packaging
21097	DOMRL12-250	1/2in. Dyn-O-Loc (Full Set)	250/Box
21098	DOMRL34-250	3/4in. Dyn-O-Loc (Full Set)	250/Box
21208	DOMRL12-100	1/2in. Dyn-O-Loc Assembly (Full Set)	100/Box
21209	DOMRL34-100	3/4in. Dyn-O-Loc Assembly (Full Set)	100/Box
21008	SN12	1/2in. Dyn-O-Loc Spring Nut Only	250/Box
21009	SN34	3/4in. Dyn-O-Loc Spring Nut Only	250/Box
21286	SWW1420	1/4-20 Dyn-O-Loc Bolt Only with Washer	250/Box



RLT



- The Dyn-O-Loc Tool aids installation and assures accurate spacing.

Item #	Code	Description	Packaging
21076	RLT	Dyn-O-Loc Tool	1 each

Rod-Loc Insertion Machine

The Rod Loc Insertion Machine offers contractors a fast and convenient way to set up rod locks and conduit. This revolutionary new machine runs off of a standard 110 volt outlet and an air supply. Simply place either 3/4" or 1/2" conduit in the cradle and by the flip of a switch the air cylinder inserts a rod lock on both ends simultaneously of hollow conduit at the perfect inset spacing, eliminating the old timely hammer in method!

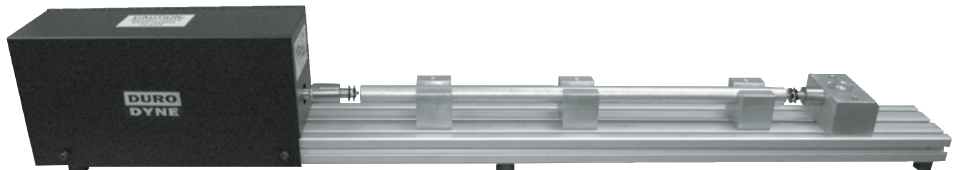

48" long extension included to accommodate up to 6' conduit

Be sure to check out the video of the prototype at AHR by scanning the QR code to the right or by visiting our YouTube page link at: <https://www.youtube.com/watch?v=Pf6mKtvekYQ>



Scan for video!

Item #	Code	Description	Packaging
43011	WVDL1234A	Rod-Loc Insertion Machine	1 each

Dyn-O-Claw

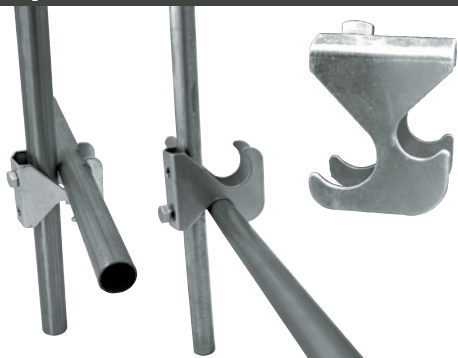

When conduits cross inside the ductwork, they can vibrate with the passing of airflow and create a rattling sound. The Dyn-O-Claw is designed to join conduits and eliminate their vibration in the duct.

- Dyn-O-Claws are easier and faster than other alternatives such as ties or welding.
- 14 gauge galvanized steel
- Works for both 1/2" and 3/4" conduit
- Steel bolt secures the Dyn-O-Claw onto the Conduit

Item #	Code	Description	Packaging
21298	DOMOC1234	Dual Dyn-O-Claw 1/2" & 3/4"	250/Box

Nosing

Nosing

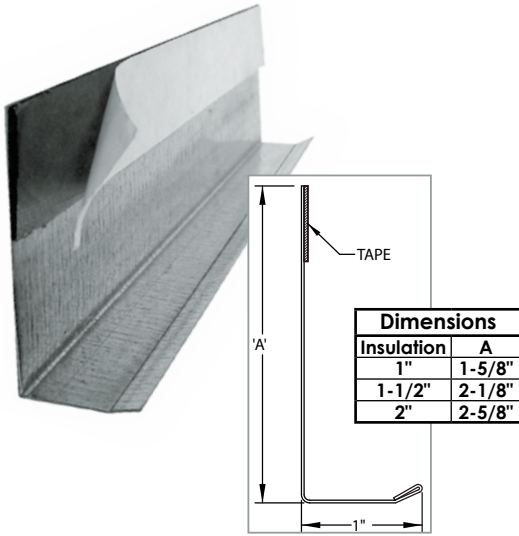

- Protects exposed edge of the duct liner.
- Minimizes the possibility of liner delaminating and causing blockage in the ductwork.
- Manufactured from 26-gauge galvanized steel.
- Designed with self adhesive tape for easy installation.
- Available for 1in, 1-1/2in, and 2in insulation.
- Sold in 10 ft. lengths.
- Hemmed to prevent damage to the liner

Item #	Code	Description	Packaging
21261	NOS100	Nosing for 1in insulation - 10 ft.	1000ft./Bundle
21262	NOS112	Nosing for 1-1/2in insulation - 10 ft.	1000ft./Bundle
21263	NOS200	Nosing for 2in insulation - 10 ft.	1000ft./Bundle

Punched Angle Iron

1-1/2in Punched Angle Iron

- Versatile product used for reinforcing & mounting duct.
- Manufactured from 16 gauge galvanized steel.
- Rollformed metal construction
- 3/16in holes on 3in centers.
- Available in 12ft lengths.
- Also available in aluminum & stainless steel.

Item #	Code	Description	Packaging
21221	PAI1612	1-1/2in x 1-1/2in x 12 ft 16ga Punched Angle Iron	600 ft / bundle
13190	PAI1412	1-1/2x1-1/2x12ft 14 Gauge angle holes @ 3in Centers	600 ft / bundle

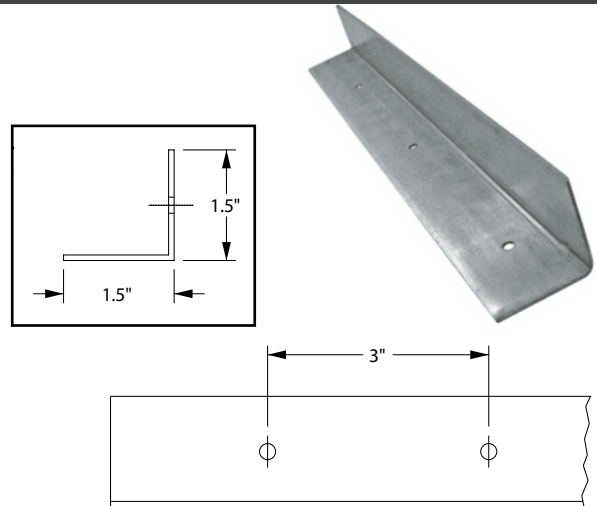

2in Punched Angle Iron

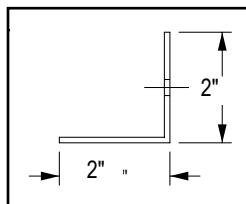

- Versatile product used for reinforcing & mounting duct.
- Manufactured from 20 gauge galvanized steel.
- Rollformed metal construction
- 1/4in holes
- Available in 4ft lengths.
- Also available in aluminum & stainless steel.

Item #	Code	Description	Packaging
21115	BPPA2048	2in x 2in x 4 ft. 20ga Punched Angle Iron	50 pcs / bundle

Assembly Instructions

for Flange/J&H Systems

Step 1: Cutting the Angle

The angle should be cut $1 \frac{5}{16}$ " shorter than the duct dimensions, cutting the angle with the spine pointing up. Using a chop saw with a 3 h.p. motor and a metal cutting blade helps to insure a clean edge with no burrs.



Step 2: Frame Assembly & Seating

Using a mallet, insert the corners into the shorter angles; install the larger angles to complete the frame. The raised portion of the corner should be facing inward with the "Dyn-O-Mate" name visible from the outside.

Starting at a corner, use a mallet, hammer the completed frame onto the raw edge of the duct section. Moving in one direction, make sure the duct is seated into the mastic.

NOTE: The duct section should not be notched.

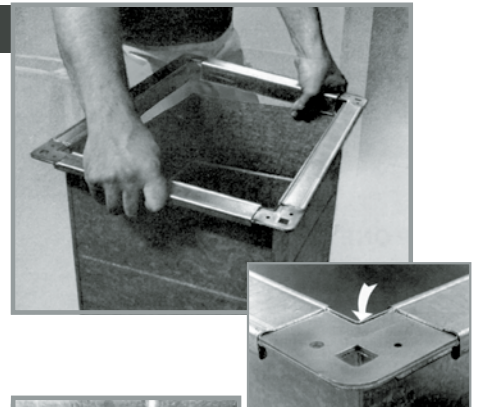

Step 3: Fastening the Frame

The frame can be fastened to the ductwork with either Tek screws (10x3/4) or spot welds.

Fastening of the angle or spot welding must start within 3/4" of each end of the angle at the duct section corners.

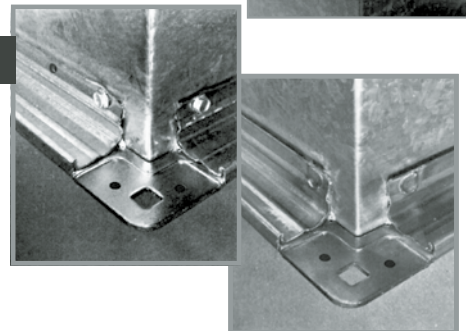

Step 4: Gasket Application

Apply a 2 to 3" strip of gasket on the 4 exposed corners of one frame, as pictured.

Starting at the center of the other mating frame, apply a single strap of gasket completely around the inside edge of the frame. **IMPORTANT:** This gasket must also cover the exposed edge of the duct section and the gap between the duct wall and the corner.

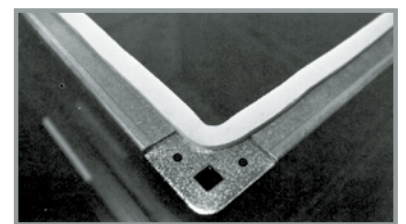
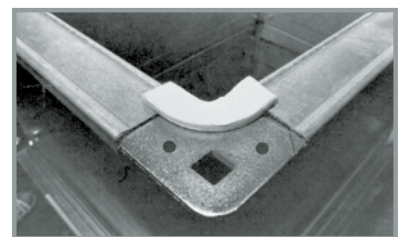

Step 5: Installing the Cleat

Snap a 6" piece of either metal or PVC cleat over the mating frame, using the following recommendations:

- 1/2" to 2" sp - 1 piece on 24" centers
- 2" to 3" sp - 1 piece on 18" centers
- 4" to 6" sp - 1 piece on 12" centers
- Over 10" sp - continuous cleat



To Whom It May Concern:

SUBJECT: Duct construction other than that in the HVAC-DCS-1985

The foreword of the 1985 HVAC-DCS states that "Although standardization intrinsically involves selection, no intention of discrimination against the use of any product or method that would serve a designer's need equally or better exists." Additionally, recognition of equivalent or other construction is acknowledged in the text as follows:

1. Italicized wording in paragraph one on page 1-12 states "a fifth alternative, that of using non-illustrated construction, is recognized based on sponsor demonstrated equivalency subject to the approval of authorities regulating use of this voluntary acceptance standard. SMACNA does not validate equivalency."
2. Text on page 1-14 states that "certain joints have been assigned maximum pressure classes. Such restrictions are not intended to prohibit consideration of other limits where evidence of acceptability is presented under the equivalent construction principle."
3. Paragraph § 1.18 on page 1-15 states that "Other construction that meets the functional criteria in Section VII or is as serviceable as that produced by the construction tables may be provided."
4. A sentence on page 1-37 says "See Figure 1-4A for commentary on proprietary joint systems and see Section VII for joint performance evaluation."
5. The text on page 1-38 "invites authorities to consider alternative constructions" and says "consult the manufacturers of alternative systems for ratings, assembly requirements and recommendations."
6. Note 3 on page IV states that "the Association refrains from endorsement of proprietary products." Note 4 on this page says "the Association will not review or judge products or components as being in compliance with the document."
7. Paragraph § 3.3 on page 3-2 says "Nothing herein is intended to constitute implied disapproval of the designer's consideration of other methods of construction."
8. Paragraph § 3.26 on page 3-13 states that "Illustrations of accessories and sleeves and collars are representative of a class of such items and are not intended to preclude the use of components not precisely identical to these."
9. Three alternative procedures for rating construction relative to the SMACNA tables are given on page 7-5, analysis, historical track record and testing. Commentary on witnessing tests and on use of test data is provided in the last paragraph on page 7-11, ending with "Authorities are invited to evaluate such construction based on evidence presented by sponsors." Otherwise, the performance criteria used for the SMACNA rectangular duct tables are given in Section VII. General performance requirements are discussed on page 1-3.

We think that these statements from the HVAC-DCS reflect a clear policy of SMACNA's abstention from judging unillustrated components and systems as being equivalent while encouraging consideration of them based on evidence presented by sponsors. Otherwise, SMACNA has not published or authorized any addenda for the 1985 HVAC-DCS.

Sincerely,

John H. Stratton
Director, Technical Services

1/2" W.G.
Static
pos or neg
Duct
Dimen.

SHOP STANDARDS RECTANGULAR DUCT REINFORCEMENT

Minimum Rigidity Class* - Minimum Gage Duct Reinforcement Spacing

R=Midpoint Reinforcement

T=Conduit Type Tie Rods

*=These tests were done as comparative tests, and the actual duct deflection was not recorded. They did not exceed SMACNA Deflection Standards.

Note: Two (2) Tie Rods - equally spaced (28" centerline) were used

	8'	6'	5'	4'	3'	2 1/2'	2'
26" dn	H-26	H-26	H-26	H-26	H-26	H-26	H-26
27-30"	H-26	H-26	H-26	H-26	H-26	H-26	H-26
31-36"	H-24	H-26	H-26	H-26	H-26	H-26	H-26
37-42"	H-24	H-24	H-26	H-26	H-26	H-26	H-26
43-48"	H-22	H-24	H-26	H-26	H-26	H-26	H-26
49-54"	H-20	H-22	H-26	H-26	H-26	H-26	H-26
55-60"	H-20	H-22	H-24	H-24	H-26	H-26	H-26
61-72"	H-18	H-20	H-22	J26T	H-24	H-24	H-24
73-84"	J-16	H-18	H-22	J26T	H-24	H-24	H-24
85-96"	J-16	J-18	J22T	H-20	J22	H-22	H-22
97-108"			J22T	J-18	J22T	J-18	J22T
109-120"			J22T		J22T	J-18	J22T

When referring to Table 1-3 thru Table 1-10 in the SMACNA HVAC Duct Construction Standards, 3rd ed., 2005,

Use the Dyn-O-Mate "H" Angle on Rigidity Class "F", "G" and "H"

Use the Dyn-O-Mate "J" Angle on Rigidity Classes above "H"

The tables as shown here are the SMACNA Tables with those interpretations already substituted.

These tests results are shown as follows:

SMACNA Table



Variation
permitted per
certified test.

SHOP STANDARDS

RECTANGULAR DUCT REINFORCEMENT

Minimum Rigidity Class* - Minimum Gage Duct Reinforcement Spacing

1" W.G.
Static
pos or neg
Duct
Dimen.

R=Midpoint Reinforcement

T=Conduit Type Tie Rods

*=These tests were done as comparative tests, and the actual duct deflection was not recorded. They did not exceed SMACNA Deflection Standards.

Note: Two (2) Tie Rods - equally spaced (28" centerline) were used

	8'	6'	5'	4'	3'	2 1/2'	2'					
14" dn	H-26	H-26	H-26	H-26	H-26	H-26	H-26					
15-20"	H-26	H-26	H-26	H-26	H-26	H-26	H-26					
21-24"	H-24	H-26	H-26	H-26	H-26	H-26	H-26					
25-30"	H-24	H-26	H-26	H-26	H-26	H-26	H-26					
31-36"	H-22	H-24	H-24	H-26	H-26	H-26	H-26					
37-42"	H-20	H-22	H-24	H-26	H-26	H-26	H-26					
43-48"	H-18	H-20	H-22	H-26	H-26	H-26	H-26					
49-54"	H-18	H-20	H-22	J-26	H-24	J-26	H-24	J-26	H-24	J-26		
55-60"	H-18	H-20	H-22	J-26	H-24	J-26	H-24	J-26	H-24	J-26	H-24	J-26
61-72"		H-18	H-18	J ²⁴ _{26T}	H-22	J26T	H-24	J26T	H-24	J-26	H-24	J-26
73-84"		J-16	J-18	J24T	J-20	J22	H-22	J22	H-22	J-24	H-22	J-24
85-96"			J-16	J-20	J-18	J-20	J-20	J22	H-20	J-22	H-22	
97-108"				J22T	J-18	J22T	J-18	J22T	J-18	J-22	J-18	J-22
109-120"				J22T		J22T	J-18	J22T	J-18	J-22	J-18	J-22

* Each duct system shall be constructed for the specific duct pressure classifications shown on the contract drawings for the project. Where no specific duct pressure class designations are provided by the designer the 1" water gage pressure class is the basis of compliance with these standards, regardless of velocity in the duct, except when the duct is variable volume: All variable volume duct upstream of VAV boxes has a 2" w.g. basis of compliance when the designer does not give a pressure class.

*Because total pressure decreases in the direction of the flow a, duct construction pressure classification equal to fan outlet pressure (or to fan total static pressure rating) cannot economically be imposed on the entire duct system. Pressure in ducts near room air terminals is nearly always below 1/2" w.g.

*Asterisks indicate wording that is taken directly and verbatim from the SMACNA HVAC Duct Construction Standards, 3rd ed., 2005.

SMACNA TABLE 1-2 DUCT SEALING REQUIREMENTS

Seal Class Class	Sealing Required	Static Pressure Construction Class
A	All transverse joints, longitudinal seams and duct wall penetrations	4" w.g. and up
B	All transverse joints and longitudinal seams	3" w.g.
C	Transverse Joint	2" w.g.

In addition to the above, any variable air volume system duct of 1" and 1/2" w.g. construction class that is up stream of the VAV boxes shall meet Seal Class C.

2" W.G.
Static
pos or neg
Duct
Dimen.

SHOP STANDARDS

RECTANGULAR DUCT REINFORCEMENT

Minimum Rigidity Class* - Minimum Gage Duct Reinforcement Spacing

R=Midpoint Reinforcement

T=Conduit Type Tie Rods

*=These tests were done as comparative tests, and the actual duct deflection was not recorded. They did not exceed SMACNA Deflection Standards.

Note: Two (2) Tie Rods - equally spaced (28" centerline) were used

	8'	6'	5'	4'	3'	2 1/2'	2'
12" dn	H-26	H-26	H-26	H-26	H-26	H-26	H-26
13-18"	H-24	H-24	H-26	H-26	H-26	H-26	H-26
19-26"	H-22	H-24	H-26	H-26	H-26	H-26	H-26
27-30"	H-20	H-22	H-24	H-26	H-26	H-26	H-26
31-36"	H-18	H-20	H-22	H-24	H-26	H-26	H-26
37-42"	H-16	H-18	H-20	H-24	H-24	H-26	H-26
43-48"	J-16	H-18	H-20	H-22	J26T	H-24	H-24
49-54"		J-16	H-18	J 22/26T	H-20	J 22/26T	H-24
55-60"		J-16	J-18	J 22/26T	H-18	J 22/26T	H-24
61-72"			J-16	J24T	J-18	J26T	H-22
73-84"				J22T	J-18	J22T	J-20
85-96"				J22T	J-18	J22T	J-20
97-108"				JT22T	JT22T	K-18	JT22T
109-120"				JT22T	JT22T	JT22T	K-18

Tie Rod Installation

Using the Dyn-O-Mate RODLOCK(Conduit Type Tie Rod) Duro Dyne Corp., through a certified testing Program (in accordance with Chapter 7 of the SMACNA HVAC Duct Construction Standards, 3rd ed., 2005) has used the Conduit Type Tie Rod being attached to the duct wall alone as the reinforcement for the panel tie rod.

Example: 22 T Center tie rod:

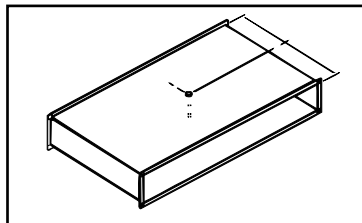

Where the Conduit Type Tie Rod is used as a flange reinforcement, "JT" or "HT", the conduit type tie rod is installed as shown below:

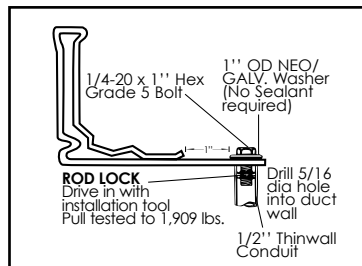

Negative Pressure

Consult SMACNA construction standards page 2.97 Section 2.8.1 paragraph 7 for specifics on reinforcement recommendations for both Positive and negative pressure duct systems.

SHOP STANDARDS RECTANGULAR DUCT REINFORCEMENT

Minimum Rigidity Class* - Minimum Gage Duct Reinforcement Spacing

3" W.G.
Static
pos or neg
Duct
Dimen.

R=Midpoint Reinforcement

T=Conduit Type Tie Rods

*=These tests were done as comparative tests, and the actual duct deflection was not recorded. They did not exceed SMACNA Deflection Standards.

Note: Two (2) Tie Rods - equally spaced (28" centerline) were used

	8'	6'	5'	4'	3'	2 1/2'	2'					
12" dn	H-24	H-26	H-26	H-26	H-26	H-26	H-26					
13-18"	H-22	H-24	H-24	H-26	H-26	H-26	H-26					
19-22"	H-20	H-22	H-24	H-26	H-24	H-26	H-26					
23,24"	H-18	H-22	H-24	H-26	H-24	H-26	H-26					
25,26"	H-18	H-22	H-24	H-24	H-26	H-26	H-26					
27,28"	H-18	H-20	H-22	H-24	H-24	H-26	H-26					
29,30"	H-18	H-20	H-22	H-24	H-24	H-26	H-26					
31-36"	H-16	H-18	H-20	H-24	H-22	H-24	H-24	H-26				
37-42"		H-18	H-20	H-24	H-22	H-24	H-24	H-24	H-24	H-26		
43-48"		J-16	J-18	J26T	H-20	J26T	H-22	H-24	H-24			
49-54"			J-18	J26T	J-18	J26T	H-22	H-24	H-24			
55-60"			J-16	J24T	J-18	J24T	H-20	H-22	H-24			
61-72"				J24T	J-16	J24T	J-20	J24T	J-22	J-24		
73-84"				J20T		J20T	J-18	J20T	J-20	J-22		
85-96"				JT20T		JT20T	K-18	JT20T	J-18	J-20		
97-108"				JT20T		JT20T		JT20T	L-18	JT20	K-18	JT20
109-120"				JT20T		JT20T		JT20T	L-18	JT20	L-18	JT20

This table shows some typical duct sizes and the weight that can be saved by changing gage per certified test:

SMACNA Table  Variation permitted per certified test.

Duct Size	Sq. Ft. per 5" Sect.	Lbs./Sq. Ft.	Lbs./Sq. Ft.	Lbs./Sq. Ft.	Lbs./Sq. Ft.	Lbs./Sq. Ft.
		.91 26 ga.	1.16 24 ga.	1.41 22 ga.	1.66 20 ga.	2.16 18 ga.
30/18	40	40	51	62	73	95
36/24	50	50	64	76	83	119
42/24	55	55	70	85	100	131
48/24	60	60	76	93	110	143
54/24	65	65	83	101	119	154
60/30	75	75	96	116	137	178
72/36	90	90	115	140	164	214
84/48	110	110	140	171	201	261
96/48	120	120	153	186	219	285

4" W.G.
Static
pos or neg
Duct
Dimen.

SHOP STANDARDS RECTANGULAR DUCT REINFORCEMENT

Minimum Rigidity Class* - Minimum Gage Duct Reinforcement Spacing

R=Midpoint Reinforcement
T=Conduit Type Tie Rods

*=These tests were done as comparative tests, and the actual duct deflection was not recorded. They did not exceed SMACNA Deflection Standards.

Note: Two (2) Tie Rods - equally spaced (28" centerline) were used

	8'	6'	5'	4'	3'	2 1/2'	2'
10" dn	H-22	H-26	H-26	H-26	H-26	H-26	H-26
11,12"	H-22	H-24	H-26	H-26	H-26	H-26	H-26
13,14"	H-22	H-22	H-24	H-26	H-26	H-26	H-26
15,16"	H-20	H-22	H-24	H-26	H-26	H-26	H-26
17-20"	H-20	H-22	H-24	H-24	H-26	H-26	H-26
21,22"	H-18	H-20	H-24	H-24	H-26	H-26	H-26
23,26"	H-18	H-20	H-22	H-24	H-24	H-26	H-26
27-30"	H-18	H-18	H-22	H-24	H-24	H-26	H-26
31-36"		H-18	H-20	H-22	H-22	H-24	H-26
37-42"		J-16	J-18	H-22	H-20	H-22	H-24
43-48"			J-18	J26T	J-18	J26T	H-22
49-54"			J-16	J24T	J-18	J24T	J-20
55-60"			J-16	J22T	J-16	J22T	J-20
61-72"				J20T	J20T	J-18	J-20
73-84"				J20T	J20T	K-16	J20T
85-96"				JT20T	JT20T	JT20T	K-18
97-108"				JT18T	JT18T	JT20T	L-18
109-120"				JT18T	JT18T	JT18T	L-18

Precautions

In any given duct system, accidental overpressure could occur and must be accounted for by design provisions, such as fail safe features, replaceable release panels and static pressure switches that can shut down the entire system. Note: On all duct systems that are to be tested for leakage, it is recommended that the first 100 feet of completed ductwork be tested before proceeding to complete the installation.

SHIPPING L SHAPED DUCT WITH THE ANGLE INSTALLED

STEP ONE

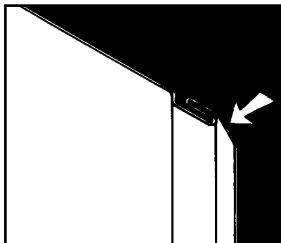

Notch the "hammer edge" of the female Pittsburgh Lock 1/4" on a 45 degree angle as shown.

STEP TWO

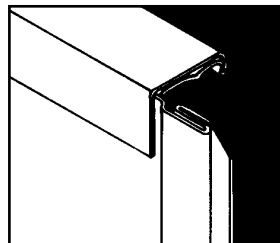

In the shop, install the angle on the duct without the corner piece.

STEP THREE

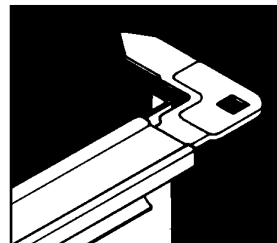

In the field insert a corner piece into the angle at the male end of the Pittsburgh Lock.

STEP FOUR

Complete the frame and bend over the hammer edge of the Pittsburgh Lock in the standard manner.

SHOP STANDARDS RECTANGULAR DUCT REINFORCEMENT

Minimum Rigidity Class* - Minimum Gage Duct Reinforcement Spacing

6" W.G.
Static
pos or neg
Duct
Dimen.

R=Midpoint Reinforcement

T=Conduit Type Tie Rods

*=These tests were done as comparative tests, and the actual duct deflection was not recorded. They did not exceed SMACNA Deflection Standards.

Note: Two (2) Tie Rods - equally spaced (28" centerline) were used

	8'	6'	5'	4'	3'	2 1/2'	2'
10" dn	H-20	H-22	H-26	H-26	H-26	H-26	H-26
11,12"	H-20	H-22	H-24	H-24	H-26	H-26	H-26
13,14"	H-20	H-20	H-22	H-24	H-26	H-26	H-26
15,18"	H-18	H-20	H-22	H-24	H-26	H-26	H-26
19-22"	H-18	H-20	H-22	H-24	H-24	H-26	H-26
23,24"	H-18	H-20	H-22	H-22	H-24	H-26	H-26
25,28"	H-16	H-18	H-20	H-22	H-24	H-24	H-24
29-30"		H-18	H-18	H24T	H-22	H-24	H-24
31-36"		J-16	J-18	H24T	H-20	H-22	H-24
37-42"			J-16	H24T	J-18	H24T	H-20
43-48"				H24T	J-18	H24T	J-18
49-54"				J20T	J-16	J20T	J-18
55-60"				J20T		H20T	J-18
61-72"				JT20T		JT20T	K-16
73-84"				JT20T		JT20T	L-16
85-96"				JT18T		JT18T	IT16
97-108"				JT18T		JT18T	JT16
109-120"				JT18T		JT18T	KT16

Dyn-O-Mate Angle as a Breakaway Connection

- A. Dyn-O-Mate frame.
Use neoprene gasket between the frames. Secure duct to sleeve.
- B. Retaining angle, secured to sleeve only.
- C. Fire damper secured to sleeve.
- D. 20 ga. Sleeve up to 54" x 54" - 18 ga. Sleeve 54" and up.
- E. Melt away (200°F) pvc cleat (typ). Install 6" pieces 12" on center starting cleat at extreme end (corners).

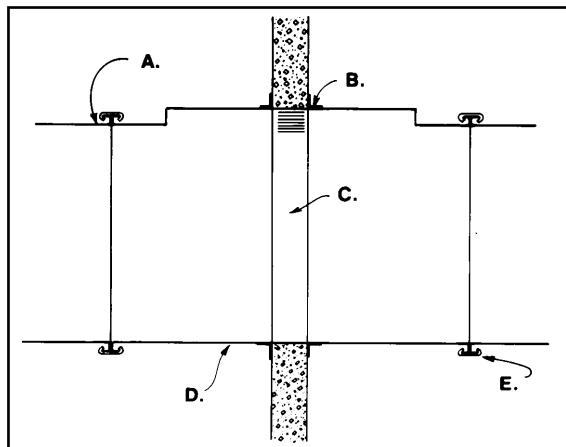

NOTE: Install duct and fire damper sleeve per normal installation procedures with bolts at the corners until all ductwork is installed and testing is completed. After successful testing, the bolts at the corners of the fire damper sleeves are to be removed so as to insure that duct will break away once cleats reach melting temperature of 200 degrees F.

10" W.G.
Static
pos or neg
Duct
Dimen.

SHOP STANDARDS RECTANGULAR DUCT REINFORCEMENT

Minimum Rigidity Class* - Minimum Gage Duct Reinforcement Spacing

R=Midpoint Reinforcement

T=Conduit Type Tie Rods

*=These tests were done as comparative tests, and the actual duct deflection was not recorded. They did not exceed SMACNA Deflection Standards.

Note: Two (2) Tie Rods - equally spaced (28" centerline) were used

	8'	6'	5'	4'	3'	2 1/2'	2'
8" dn	H-20	H-22	H-24	H-24	H-26	H-26	H-26
9",10"	H-20	H-20	H-22	H-24	H-26	H-26	H-26
11",12"	H-18	H-20	H-22	H-24	H-26	H-26	H-26
13",14"	H-18	H-18	H-20	H-22	H-24	H-26	H-26
15-18"	H-16	H-18	H-20	H-20	H-24	H-24	H-26
19",20"	H-16	H-18	H-18	H-20	H-22	H-24	H-24
21-24"		H-18	H-18	H-20	H-22	H-24	H-24
25-28"		J-16	J-18	H-18	H-22	H-24	H-24
29",30"			J-16	J-18	H-22	H-24	H-24
31-36"			J-16	J-18	J-20	H-22	H-24
37-42"			J16T	J-16	J-18	J-20	J-22
43-48"				JT16	J-18	J-18	J-22
49-54"					K-16	JT16	J-18
55-60"					L-16	JT16	K-18
61-72"						L-16	JT16
73-84"							LT16
85-96"							LT16
97-108"							LT16
109-120"							LT16

Compliance to the 1998 California Mechanical Code Addendum

NOTE:

METAL NOSING MUST BE USED WHEREVER LINER IS PRECEDED BY UNLINED METAL; OTHERWISE WHEN VELOCITY EXCEEDS 4000 FPM (20.3 MPS) USE METAL NOSING ON EVERY LEADING EDGE.

AS DESCRIBED ON PAGE 2.24, FIGURE 2-19 OF THE SMACNA HVAC DUCT CONSTRUCTION STANDARDS, 3RD ED., 2005

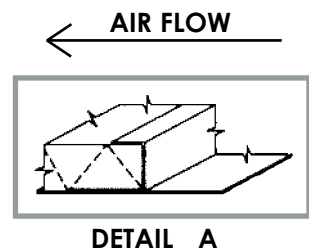

TEST RESULTS

The following tests of rectangular duct sections and transverse joints were conducted in accordance with Section VII of the SMACNA HVAC Duct Construction Standards, 3rd ed., 2005.

Operating Pressure	Duct Size	Section Length	Duct Gauge	Connector Type	Connector Deflection	Duct Deflection
1"	72/12	60"	18 ga.	H	.249	.650
1"	48/12	60"	26 ga.	H	.050	.750
1"	60/21	60"	26 ga.	J	.060	.750
1"	84/12	60"R	24 ga.	J	.072	.384
1"	96/12	60"	20 ga.	J	.290	.750
1"	84/21	60"T	26 ga.	J	.060	.350
2"	60/21	60"T	26 ga.	J	.050	.010
2"	84/12	48"	18 ga.	J	.250	.740
2"	72/12	60"R	24 ga.	H	.258	.725
2"	72/12	60"	19 ga.	J	.230	.650
2"	48/12	60"	24 ga.	H	.120	.820
2"	84/36	60"R	20 ga.	J	.168	.670
2" see note	84/21	60"T	26 ga.	J	.040	.468
3"	48/12	60"	20 ga.	H	.165	.730
3"	72/12	60"R	24 ga.	J	.140	.702
3"	60/12	60"	18 ga.	J	.131	*
3"	76/44	60"R	20 ga.	J	.220	.500
3"	60/15	60"	16 ga.	H	.148	.740
3"	60/21	60"T	26 ga.	J	.090	.040
4"	72/12	60"R	24 ga.	J	.231	.498
4"	48/12	60"R	24 ga.	H	.164	.498
4"	48/12	60"	20 ga.	H	.245	.830
4"	60/12	60"	18 ga.	J	.160	*
4"	76/44	60"R	20 ga.	J	.278	.600
4"	60/21	60"T	26 ga.	J	.120	.100
5"	48/12	60"R	24 ga.	H	.210	.525
5"	48/12	60"	18 ga.	H	.250	<.750
5"	60/12	60"	18 ga.	J	.211	*
6"	60/12	48"R	20 ga.	H	.215	.730
6"	48/12	60"R	24 ga.	H	.259	.620
6"	48/12	60"	18 ga.	H	.300	.780
6"	60/12	60"	18 ga.	J	.279	*
10"	42/12	48"	16 ga.	H	.200	.730
10"	108/58	60"R	18 ga.	J	.250	<.750
10"	120/42	48"R	16 ga.	J	.100	<.750
10"	42/24	60"R	16 ga.	J	.090	.340

R=Midpoint Reinforcement

T=Conduit Type Tie Rods

*=These tests were done as comparative tests, and the actual duct deflection was not recorded. They did not exceed SMACNA Deflection Standards.

Note: Two (2) Tie Rods - equally spaced (28" centerline) were used

**Rectangular Duct
Deflection Limits**
(As Taken from the
SMACNA HVAC Duct
Construction Standards,
3rd ed., 2005.)

DUCT WALL	LIMIT
W=12" or less	3/8"
W=13" to 18"	1/2"
W=19" to 24"	5/8"
W=25" to 84"	3/4"
W=85" to 120"	1"
Tolerance of +10%	
JOINTS & REINFORCEMENTS	LIMIT
W=48" or less	1/4"
W=49" to 120"	W/200
Tolerance of 7.5%	

Gage	Thickness in Inches			Weight				Thickness in Millimeters		
	Min.	Max.	Nom.	Min. lb/sf	Nom. Lb/sf	Max. lb/sf	Nom. Kg/m ²	Min.	Max.	Nom.
33	.0060	.0120	.0090	.2409	.376	.486		.1524	.3048	.2286
32	.0104	.0164	.0134	.4204	.563	.665		.2642	.4166	.3404
31	.0112	.0172	.0142	.4531	.594	.698		.2845	.4369	.3607
30	.0127	.0187	.0157	.5143	.656	.759	3.20	.3188	.4783	.3988
29	.0142	.020	.0172	.5755	.719	.820		.3569	.5169	.4369
28	.0157	.0217	.0187	.6367	.781	.881	3.81	.3950	.5550	.4750
27	.0172	.0232	.0202	.6979	.844	.943		.4331	.5931	.5131
26	.0187	.0247	.0217	.7591	.906	1.004	4.42	.4712	.6312	.5512
25	.0217	.0287	.0247	.8407		1.167		.5274	.7274	.6274
24	.0236	.0316	.0276	.9590	1.156	1.285	5.64	.6010	.8010	.7010
23	.0266	.0346	.0306	1.0814		1.408		.6772	.8772	.7772
22	.0296	.0376	.0336	1.2038	1.406	1.530	6.86	.7534	.9534	.8534
21	.0326	.0406	.0336	1.3263		1.653		.8296	1.0296	.9296
20	.0356	.0436	.0396	1.4486	1.656	1.775	8.08	.906	1.106	1.006
19	.0406	.0506	.0456	1.6526		2.061		1.028	1.288	1.158
18	.0466	.0566	.0516	1.8974	2.156	2.305	10.52	1.181	1.441	1.311
17	.0525	.0625	.0575	2.1381		2.546		1.331	1.591	1.461
16	.0575	.0695	.0635	2.342	2.656	2.832	12.96	1.463	1.763	1.613
15	.0650	.0770	.0710	2.6481		3.138		1.653	1.953	1.803
14	.0705	.0865	.0785	2.8725	3.281	3.525	16.01	1.784	2.204	1.994
13	.0854	.1014	.0934	3.4804		4.133		2.162	2.5823	2.372
12	.0994	.1174	.1084	4.0516	4.531	4.786	22.11	2.523	2.983	2.753
11	.1143	.1323	.1233	4.6505		5.394		2.902	3.362	3.132
10	.1292	.1472	.1382	5.2675	5.781	6.002	28.21	3.280	3.740	3.510
9	.1442	.1622	.1532	5.8795		6.614		3.661	4.121	3.891
8	.1591	.1771	.1681	6.4874	6.875	7.222		4.040	4.500	4.270

Galvanized Sheet Thickness Tolerances

NOTES:

- Based on ASTM A924/924M-94, Standard Specification for General Requirements for Sheet Steel, Metallic Coated by the Hot-Dip Process (formerly ASTMA525); and ASTMA653/A653M-94, Standard Specification for Sheet Steel, Zinc-Coat (Galvanized) or Zinc-Iron Alloy Coated (Galvanized) by the Hot-Dip Process.
- Tolerances are valid for 48 in. and 60 in. wide coil and cut length stock – other dimensions apply to other sheet widths and to strip.
- The lock forming grade of steel will conform to ASTM A653 (formerly ASTM A527).
- The steel producing industry recommends that steel be ordered by decimal thickness only. Thickness and zinc coating class can be stenciled on the sheet. The gage designation is retained for residual familiarity reference only.
- Minimum weight in this table is based on the following computation:
 Minimum sheet thickness minus 0.001 in. of G60 coating times 40.8 lb. per sf. per in. plus 0.0369 lb./sf of zinc.
 G90 stock would be comparably calculated from:
 (t-.00153 in.) 40.8 ÷ 0.05564=minimum weight.
 However, scale weight may run 2 % (or more) greater than theoretical weight. Actual weight may be near 40.82 lb. per sf per in.
- G60 coating, per ASTM A653 and ASTM A90, has 0.60 oz/sf (triple spot test) total for two sides. 0.59 oz/sf of zinc equals 0.001 in. 1oz is 0.0017 in. and is 305.15 g/m².
 G90 coating is 0.90 oz/sf (triple spot test), or 0.00153 in. Magnetic gage measurement of zinc coating may have 15% error.
- ASTM D2092, Practice for Preparation of zinc-Coated Galvanized Steel Surfaces for Paint includes mill phosphatizing.
- ASTM A755 is the Specification for Sheet Metal, Metallic Coated by the Hot-Dip Process and Prepainted by the Coating Process for Exterior Building Products. Other information is available from the National Coil Coaters Association, Philadelphia, PA.
- Much chemical and atmospheric corrosion information is available from ASM international in Metals Park, Ohio and from NACE international in Houston, TX.
- A principle international standard is ISO 3575, Continuous Hot-Dip Process, Zinc-Coated Carbon Steel Sheet of Commercial, Lock Forming and Drawing Qualities.



Please Visit Our Website
www.durodyne.com
for the most current product information.

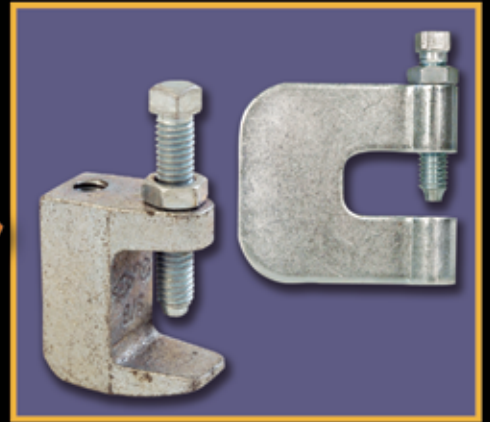
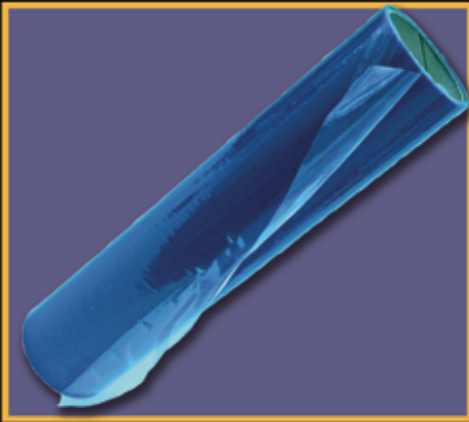

Warranty

- All Duro Dyne products are warranted against defects in quality or workmanship. Defective material will be repaired or replaced at the manufacturer's option. Liability resulting from defects in quality or workmanship is limited to the value of that material.



Most Dyn-O-Mate Products are made in the U.S.A.*
To verify any particular product please contact us.

DURO
DYNE®

© Duro Dyne Corp.
Printed in USA 10/10/17
BB021503

Duro Dyne East Division, Bay Shore, NY	631-249-9000	Fax: 631-249-8346
Duro Dyne Midwest Division, Hamilton, OH	513-870-6000	Fax: 513-870-6005
Duro Dyne West Division, Fontana, CA	562-926-1774	Fax: 562-926-5778
Duro Dyne Canada, Lachine, Quebec, Canada	514-422-9760	Fax: 514-636-0328

www.durodyne.com E-mail: durodyne@durodyne.com