

Residential and Commercial Air Duct Products

INDEX

Residential Products

Page	Contents
1	Snaplock Pipe, SMACNA Gauge Requirements, Aluminum Flexible Pipe
2	Adjustable Elbows and Angles, Tees, Reducers, Wyes
3	Takeoffs for Round and Rectangular Steel Duct, Register Boots and Boxes
4	Starting Collars; No. 261 Series, No. 720 Series, No. 650 Series
5	Starting Collars; No. 616 Series, Round Damper Sleeves, Flex Duct Connector, Backup Ring, and No. 620 Series
6	Starting Collars; No. 310 Series and No. 311 Series
7	Starting Collars; No. 710 Series and No. 711 Series
8	Insulated Register Boots and Boxes, R-4.2 and R-6.0
9	Insulated Register Boxes, R-6.0 & R-8.0 and Boxes with Gasket
10	Ceiling Radiation Damper Boxes
11	The Dryerbox and Exhaust Vents
12	Stands for Air Handler Units, Condensing Unit Tie Down Brackets
13	Radius Plenums, Drain Pans, Unit Adapters, Duct Board Boxes, Plenum Box Legs
14	Filter Housings, Can Stock, End Cap, Manual Volume Damper, Condensing Unit Cover, Line Covers and Expand-O-Duct
15	Plenums, Square to Round Transitions, Round Flex Connectors
16	Passive Return Sleeves, Duct Hangers, Mounting Brackets
17	Vent Tops, Flashings, Wallstack and Fittings
18	Mobile Home Duct Work Fittings and Duct Kits

Commercial Products

19	Commercial Duct Full Service Provider Information
20	Rectangular Duct and Fittings: S-Lock & Drive Type and Bolt Together Type B
21	Single Wall Spiral Duct Work
22	Double Wall Spiral Duct Work
23	Turning Vane & Vane Rail, Transverse Duct Connectors, Slot Diffuser Plenums
24	Access Doors and Ceiling Diffuser Adapters
25-29	Commercial Takeoff Fittings

RETURN POLICY

All returned material must be approved by Crown Products Company, Inc., prior to returning. A **"Product Return Request Form"** must be completed and returned with the material. Non-stock items may not be returned. A 15% restocking fee will be applied to all accepted returns.

WARRANTY

Crown Products Company, Inc. warrants that the air ducts and fittings it manufactures are produced in accordance with the standards and specifications shown in this catalog. No warranty of suitability for any particular purpose, nor any other presentation or warranty, whether expressed or implied, is made respecting these products.

SNAPLOCK PIPE

Galvanized Steel

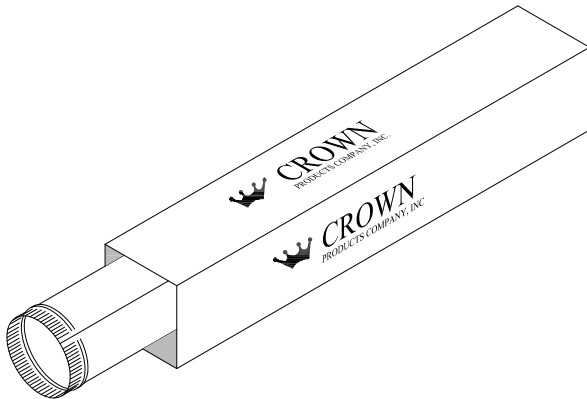

101 SNAPLOCK PIPE

Sizes: 3" through 30" diameter

DIAMETER	LENGTH	PACKAGING
3" - 14"	2 Ft.	20' per bundle
3" - 9"	5 Ft.	50' per carton
10" - 14"	5 Ft.	30' per bundle
12" - 20"	3 Ft.	30' per bundle
22" - 30"	3 & 4 Ft.	No Standard Packaging

Gauges:

Pipe is available in U.S. Gauges
 30 ga. thru 24 ga. in Reeves Snaplock
 22 ga. in ACME Lock (Hammerlock)

SMACNA GAUGE REQUIREMENTS

Galvanized Steel

Duct Diameter	Maximum 2" w.g. Positive Pressure. Longitudinal Snaplock Seam.	Duct Diameter	Maximum 2" w.g. Negative Pressure. Longitudinal Snaplock Seam.
3" thru 8"	28 ga.	6" thru 10"	28 ga.
9" thru 14"	26 ga.	12"	26 ga.
15" thru 26"	24 ga.	14" thru 16"	24 ga.
27" thru 36"	22 ga.	18" thru 20"	22 ga.
		22" thru 26"	20 ga.
		28" thru 30"	18 ga.

From SMACNA HVAC Duct Construction Standards Metal and Flexible - 2nd Edition, 1995

ALUMINUM FLEXIBLE PIPE

105 FLEX PIPE

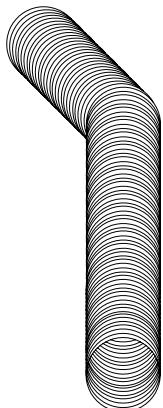

Not recommended for range hood duct.
 Ideal for bathroom and other air duct requirements.
 Furnished in 8-Ft. sections.

Duct Nominal Diameter (I.D.)	3" through 12"
Recommended Bend Radius	1.5 x Diameter to Center Line of Duct
Temperature Range	-60°F to +600°F
Maximum Operating Pressure	10" w.c. positive & 12" w.c. negative; 5,500 FPM
Listed U.L. 181	Class 0 Air Duct, meets requirements - NFPA Bulletin 90-A

107 FLEX PIPE

8-Ft. section - compressed to 38" long.
 Compressed aluminum pipe is not covered by the U.L. 181 test procedure.

ADJUSTABLE ELBOWS 90°

Galvanized Steel

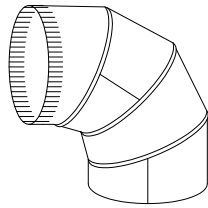

111 ADJUSTABLE ELBOW

Sizes: 3" - 30" diameter
(Elbows 22" - 30" diameter are 5-piece elbows.)

DIAMETER

- 3" - 8"
- 9" - 10"
- 12" - 14"
- 16" - 20"
- 22" - 30"

PACKAGING

- 12 per carton
- 8 per carton
- 4 per carton
- 4 per bundle, strapped
- No Standard Packaging

ADJUSTABLE ANGLE 45°

Galvanized Steel

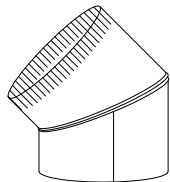

121 ADJUSTABLE ANGLE

Sizes: 4" - 30" diameter
Gauges: 30 ga. - 22 ga.

TEES

Galvanized Steel

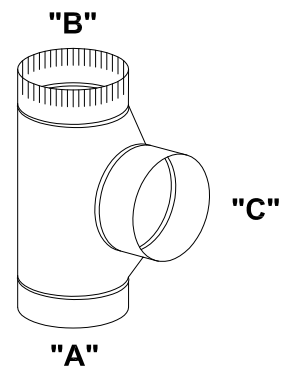

271 TEE

COLLAR SIZE	GAUGE
3" - 8"	30
9" - 12"	28
14" - 18"	26
20" - 24"	24

FOR REDUCING TEES
ORDER AS "A" x "B" x "C"

REDUCER-INCREASER

Galvanized Steel

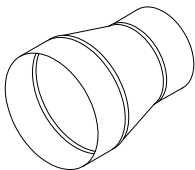

265 TAPERED REDUCER

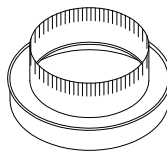

266 FLAT REDUCER

WYES

Galvanized Steel

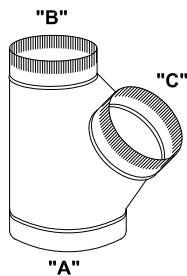

276 IN LINE WYE

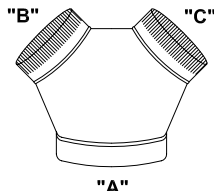

277 BULL NOSE

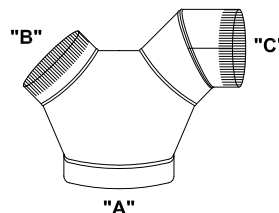

278 1-WAY
ADJUSTABLE WYE

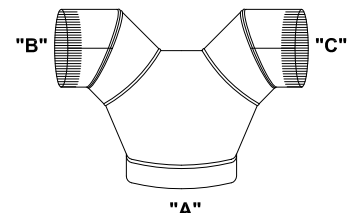

279 2-WAY
ADJUSTABLE WYE

COLLAR "A" SIZE	GAUGE
4" - 8"	30
9" - 14"	28
16" - 22"	26
24"	24

ORDER AS "A" x "B" x "C"

TAKEOFFS

Galvanized Steel

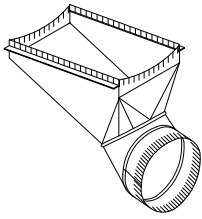

305 ROUND TAKEOFF

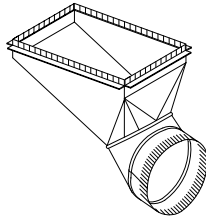

306 ADJUSTABLE TAKEOFF

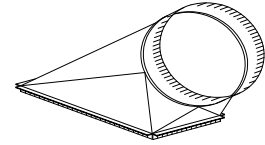

309 SIDE TAKEOFF

REGISTER BOOTS & BOXES

Galvanized Steel

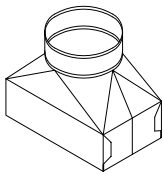

241 STRAIGHT BOOT

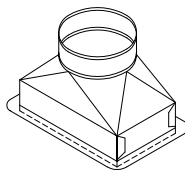

242 FRAMED BOOT

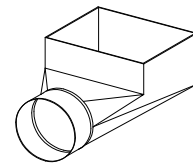

243 90° ANGLE BOOT

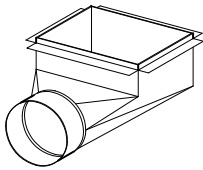

**243-F 90° ANGLE BOOT
with DRYWALL FLANGE**

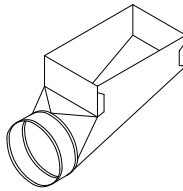

244 CENTER END BOOT

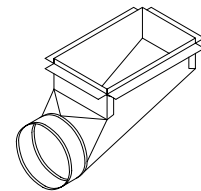

**244-F CENTER END BOOT
with DRYWALL FLANGE**

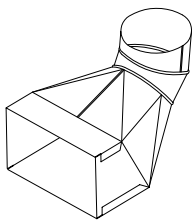

246 ADJUSTABLE BOOT

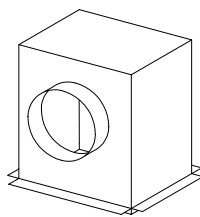

269 REGISTER BOX

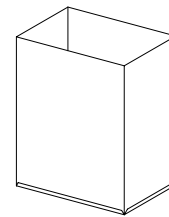

**357 BLIND BOX
12" HIGH**

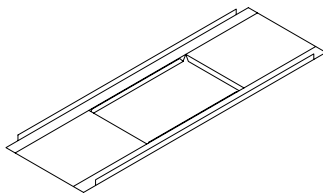

354 PLASTER FRAME

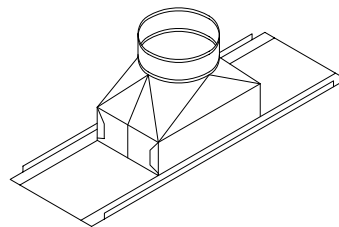

**356 PLASTER FRAME with
STRAIGHT BOOT INSTALLED**

STARTING COLLARS

FOR SHEET METAL DUCT

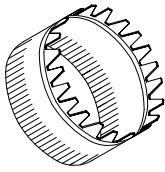

261 TAB COLLAR
3" LONG

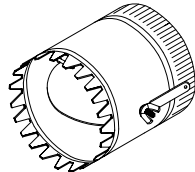

261-D
with DAMPER

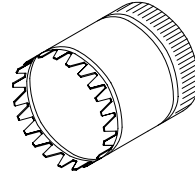

261-L
6" LONG

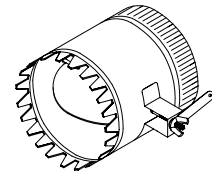

261-DS
DAMPER & 2" STANDOFF

SPIN-IN COLLARS

FOR SHEET METAL DUCT

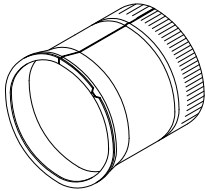

720
CRIMP & BEAD

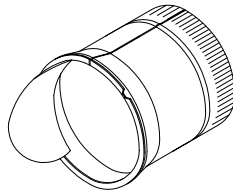

722
with SCOOP

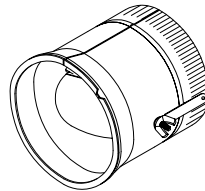

724
with DAMPER

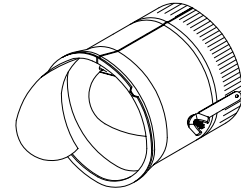

726
with SCOOP
and DAMPER

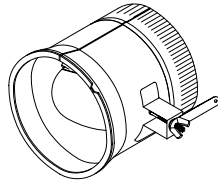

724-DSO
with DAMPER
and 2" STANDOFF

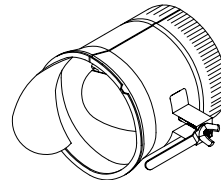

726-DSO
with SCOOP,
DAMPER and
2" STANDOFF

RING SEAL COLLARS

FOR SHEET METAL DUCT

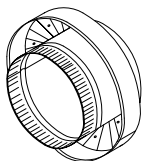

650 COLLAR

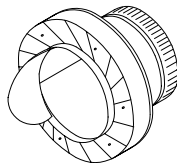

652 with SCOOP

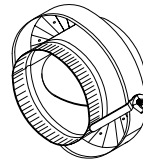

654 with DAMPER

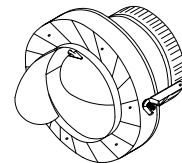

**656 with SCOOP
and DAMPER**

Ring Seal Collar - No Tabs

Install with sheet metal screws, #8 x 1/2", holes provided.

TAB COLLARS

FOR 1" and 1½" DUCT BOARD

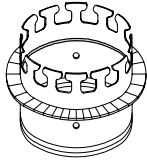

616
TAB COLLAR

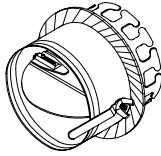

616-D
with DAMPER

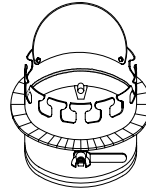

616-DS
with SCOOP
and DAMPER

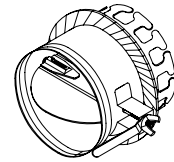

616-DSO
with 2"
STANDOFF

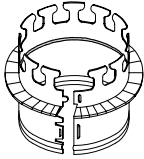

616-KD
NESTED COLLAR

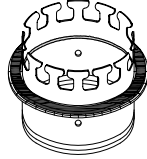

616-G
with GASKET

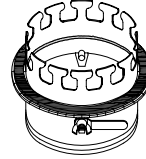

616-DG
with DAMPER
and GASKET

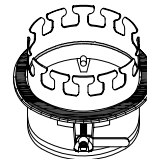

616-GDSO
with GASKET
and 2" STANDOFF

DAMPER SLEEVE, CONNECTOR & INSIDE RING

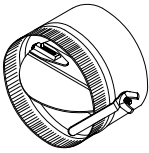

175 DAMPER
SLEEVE

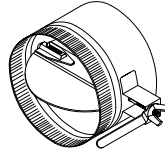

175-X DAMPER
SLEEVE WITH 2"
STANDOFF

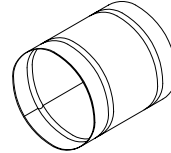

680
FLEX DUCT
CONNECTOR

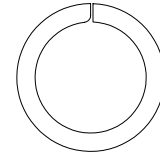

619
INSIDE
BACK-UP RING

TWIST LOCK COLLARS

FOR 1" and 1½" DUCT BOARD

"FL" COLLARS FIT 1½" DUCT BOARD

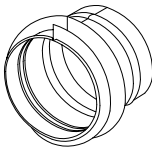

620 / 620-FL
with BEAD

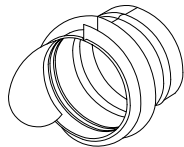

622 / 622-FL
with SCOOP

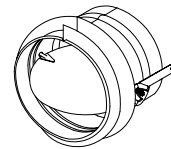

624 / 624-FL
with DAMPER

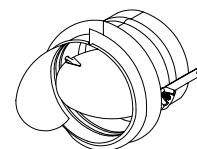

626 / 626-FL
with DAMPER
and SCOOP

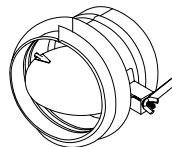

624-DSO / 624-FL-DSO
with DAMPER
and 2" STANDOFF

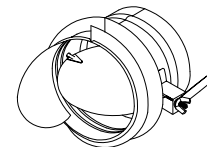

626-DSO / 626-FL-DSO
with SCOOP,
DAMPER
and 2" STANDOFF

STARTING COLLARS

WITH THERMA SEAL GASKET
OFF ROUND PIPE

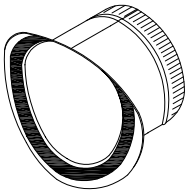

310 COLLAR

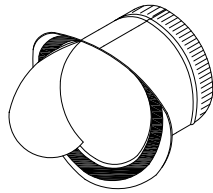

312 with SCOOP

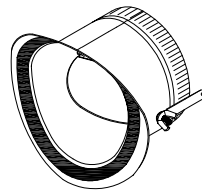

314 with DAMPER

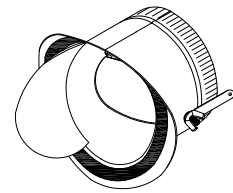

**316 with SCOOP
and DAMPER**

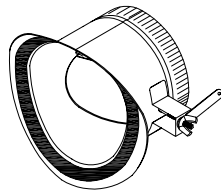

**314-DSO
with DAMPER
and 2" STANDOFF**

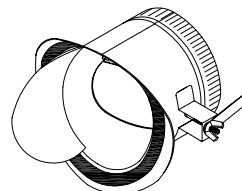

**316-DSO
with SCOOP,
DAMPER and
2" STANDOFF**

STARTING COLLARS

WITH PEEL OFF PAPER GASKET
OFF ROUND PIPE

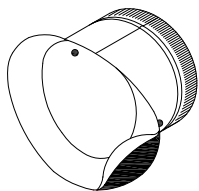

311 COLLAR

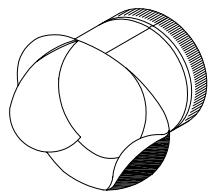

313 with SCOOP

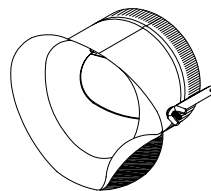

315 with DAMPER

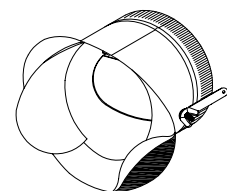

**317 with SCOOP
and DAMPER**

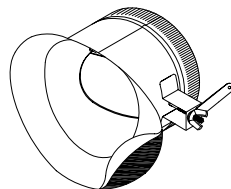

**315-DSO
with DAMPER
and 2" STANDOFF**

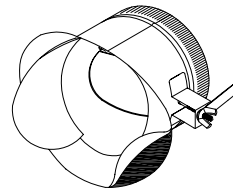

**317-DSO
with SCOOP,
DAMPER and
2" STANDOFF**

STARTING COLLARS

WITH THERMA SEAL GASKET
OFF RECTANGULAR DUCT

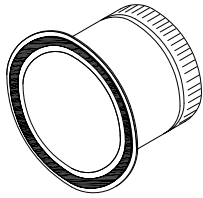

710 COLLAR

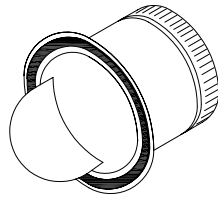

712 with SCOOP

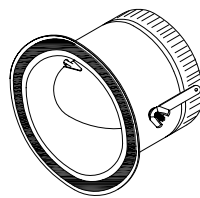

714 with DAMPER

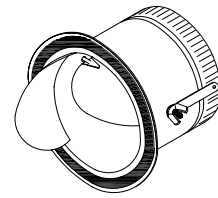

**716 with SCOOP
and DAMPER**

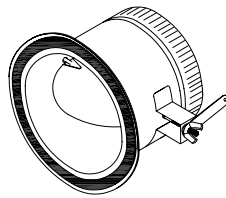

**714-DSO
with DAMPER
and 2" STANDOFF**

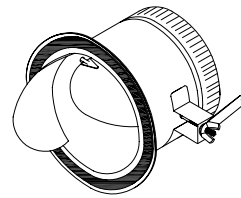

**716-DSO
with SCOOP,
DAMPER and
2" STANDOFF**

STARTING COLLARS

WITH PEEL OFF PAPER GASKET
OFF RECTANGULAR DUCT

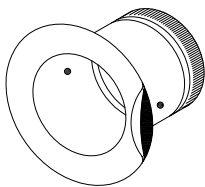

711 COLLAR

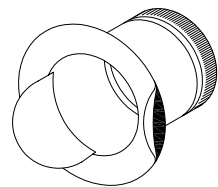

713 with SCOOP

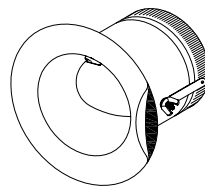

715 with DAMPER

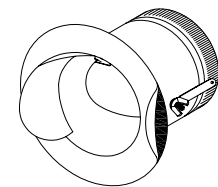

**717 with SCOOP
and DAMPER**

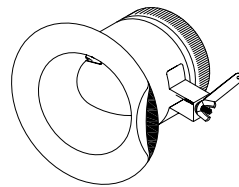

**715-DSO
with DAMPER
and 2" STANDOFF**

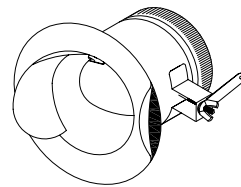

**717-DSO
with SCOOP,
DAMPER and
2" STANDOFF**

INSULATED REGISTER BOOTS & BOXES R-4.2

GALVANIZED STEEL with R-4.2 INTERNAL INSULATION

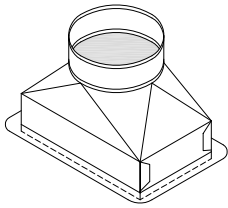

1242 FRAMED BOOT

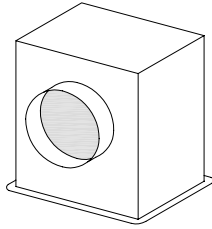

1269 FRAMED BOX

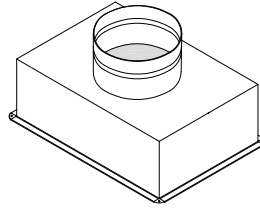

**1275 FRAMED BOX
4" HIGH**

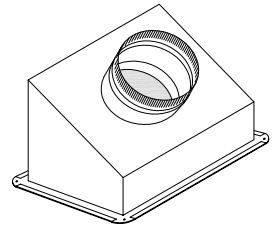

**1293 SLANT TOP
BOX**

DUCT BOARD BOXES R-4.2

GALVANIZED STEEL REINFORCED DUCT BOARD BOXES

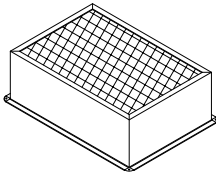

1288 4" HIGH with FLANGE
1284 4" HIGH without FLANGE
(Not Shown)

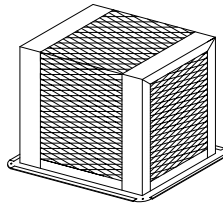

1292 (11" HIGH)
Maximum Side Collar
8" Round

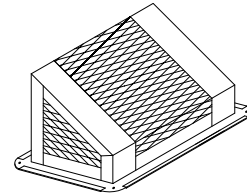

1298 SLANT TOP BOX

INSULATED REGISTER BOOTS & BOXES R-6.0

GALVANIZED STEEL with R-6.0 INTERNAL INSULATION

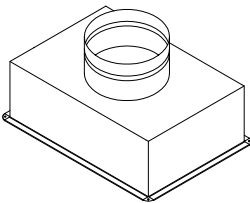

**1575 FRAMED BOX
SILVER INTERIOR**

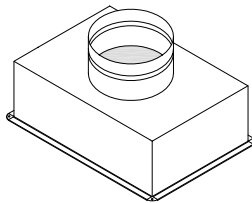

**1580 FRAMED BOX
BLACK INTERIOR**

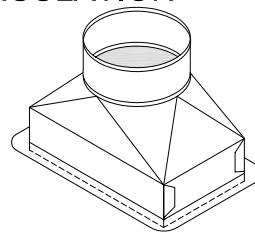

**1242-FL BOOT
BLACK INTERIOR**

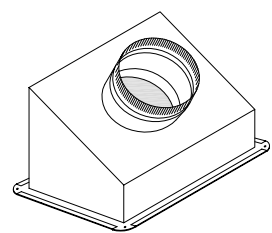

**1293-FL SLANTED TOP
BLACK INTERIOR**

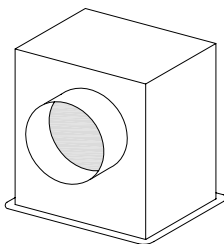

**1269-FL FRAMED BOX
BLACK INTERIOR**

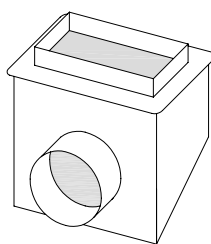

**1243-FL FLOOR BOOT
BLACK INTERIOR**

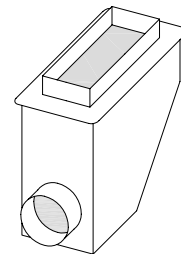

**1244-FL FLOOR BOOT
BLACK INTERIOR**

DUCT BOARD BOXES R-6.0

GALVANIZED STEEL REINFORCED DUCT BOARD BOXES
ALL WITH BLACK INTERIORS

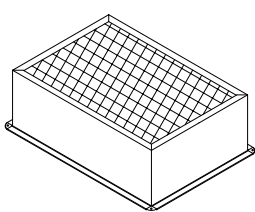

1288-FL

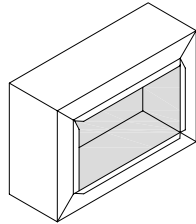

88

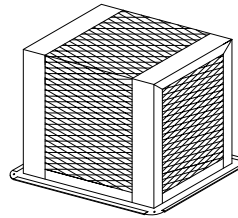

1292-FL

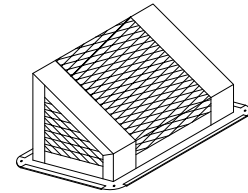

1298-FL

INSULATED REGISTER BOXES R-6.0

WITH THERMA SEAL GASKET

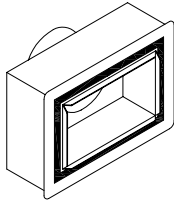

**1575-G FRAMED BOX
SILVER INTERIOR**

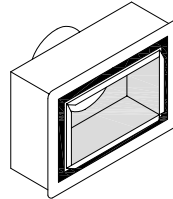

**1580-G FRAMED BOX
BLACK INTERIOR**

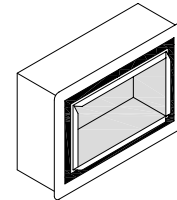

**1288-FLG DUCT BOARD BOX
BLACK INTERIOR**

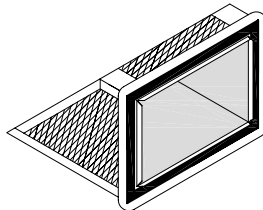

**1298-FLG SLANT TOP BOX
BLACK INTERIOR**

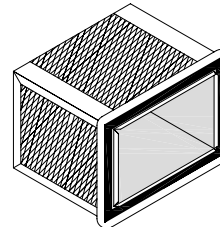

**1292-FLG DUCT BOARD BOX
BLACK INTERIOR**

Therma Seal Gasket applied to outboard flange for sealing box to building envelope.

INSULATED REGISTER BOXES R-8.0

WITH BLACK INTERIORS

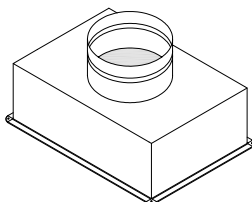

1780

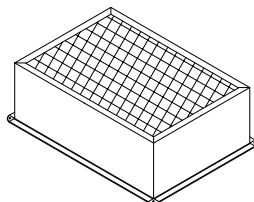

1788

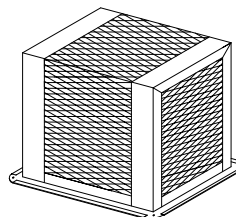

1792

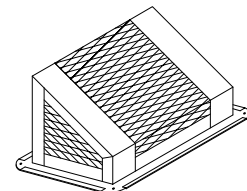

1798

CEILING RADIATION DAMPER BOXES

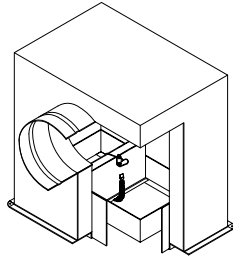

1565-CRD

**CEILING RADIATION DAMPER BOX
SIDE ENTRY COLLAR**

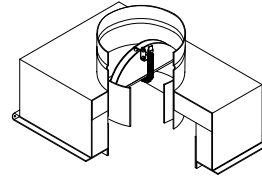

1575-CRD

**CEILING RADIATION DAMPER BOX
TOP ENTRY COLLAR**

- ✠ Galvanized steel with R-6.0 internal insulation.
- ✠ Ready to be installed and connected to supply duct.
- ✠ Hanger brackets optional.
- ✠ One hour rated CRD/Register/Grille assembly with CRD/Plenum Box assembly for use in floor-ceiling & roof-ceiling wood truss assemblies U.L. Design L-563, L-585, P-544, P547.
- ✠ Install with Crown No. 1252 Mounting Bracket (Page 16) or Crown No. 1260 18 gauge Mounting Angle (see below).
- ✠ No. 1565-CRD: Min. size = 4" x 4" - 4"Ø Max. size = 16" x 16" (256 sq. in.) - 10"Ø
- ✠ No. 1575-CRD: Min. size = 4" x 4" - 4"Ø Max. size = 16" x 16" (256 sq. in.) - 12"Ø

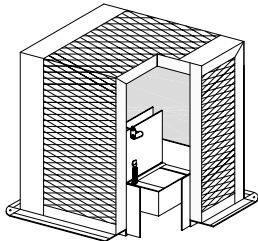

1292-CRD

**CEILING RADIATION DAMPER BOX
R-4.2 DUCT BOARD**

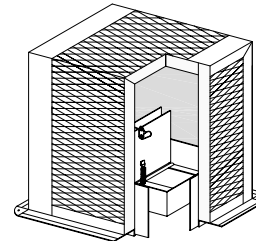

1592-CRD

**CEILING RADIATION DAMPER BOX
R-6.0 DUCT BOARD**

- ✠ Galvanized Steel Frame with Duct Board Top & Sides, Black Interior.
- ✠ Duct Board Top & Sides Allow for Various Collar Inlet Sizes, Field Installed.
- ✠ One hour rated Ceiling Radiation Damper and Fiberglass Plenum Box assembly for use in floor-ceiling & roof-ceiling wood truss assemblies U.L. Design L-563, L-585, P-544, P-547.
- ✠ Install with Crown No. 1252 Mounting Bracket (Page 16) or Crown No. 1260 18 gauge Mounting Angle (see below).
- ✠ Maximum Register Size = 16" x 16" (Maximum Area 256 sq. in.), Maximum Height = 16", Maximum Collar Size = 10"Ø.

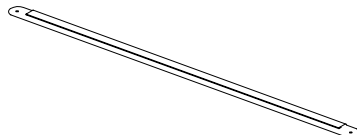

1250 MOUNTING BRACKET
24 GAUGE

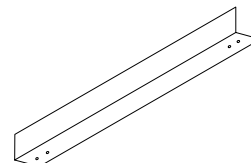

1260 MOUNTING ANGLE
18 GAUGE, 1½" x 1½" x 26" LONG

DRYERBOX & EXHAUST VENTS

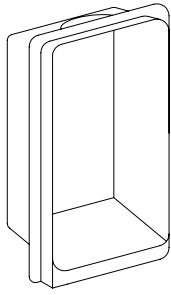

- 👑 One-piece die stamped 22 gauge aluminized steel (rigid, rust free and paintable).
- 👑 Accepts 4" diameter snaplock pipe for venting to the wall, roof or floor.
- 👑 Eliminates restrictive bends in the flex hose.
- 👑 Dryers can be installed right against the wall.
- 👑 700-350: 6 per carton. 700-425: 5 per carton.

700-350

For use in 2 x 4 stud wall

700-425

For use in 2 x 6 stud wall

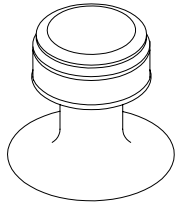

360 VENT w/ SCREEN
360-D VENT w/ DAMPER



365 VENT CAP
w/ SCREEN

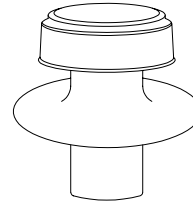

360-X w/ SCREEN & EXTENSION
360-DX w/ EXTENSION & DAMPER

ALUMINUM SEAMLESS CAP and FLASHING

Available in sizes 4", 6", 7", 8", 10" and 12" duct diameters.

Dampers available in sizes 4", 6", 7" and 8" only.

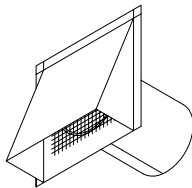

349 SIDEWALL VENT

Available with Screen or
 Flapper Damper

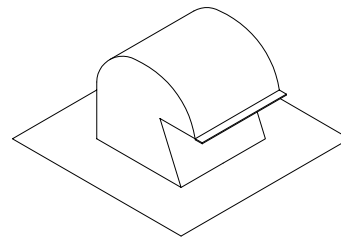

350 ROOF CAP

- 👑 **350** supplied with round collar in bottom plate and screen in top opening.
- 👑 **350-D** supplied with round collar in bottom plate and gravity damper (no screen).
- 👑 **350-R** supplied with rectangular hole in bottom plate and screen in top opening.
- 👑 **350-RD** supplied with rectangular hole in bottom plate and gravity damper (no screen).

INSTALLATION ACCESSORIES

301- CB UNIT STAND

- 👑 24 gauge Galvanized Steel. R-6 Internal Insulation.
- 👑 20" tall, 22 gauge 1" x 2" x 1" channel for C/L bracing/support.

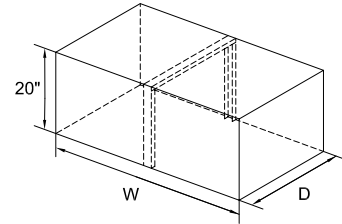

301- SM UNIT STAND

- 👑 26 gauge Galvanized Steel.
- 👑 R-6 internal insulation.
- 👑 Recessed flange at top allows for securing Air Handler to stand.

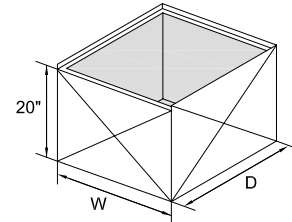

301- DB UNIT STAND

- 👑 24 gauge Galvanized Steel frame and bottom.
- 👑 R-6 duct board sides and bottom.
- 👑 Recessed flange at top allows for securing Air Handler to stand.

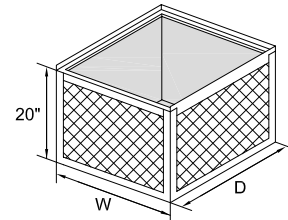

500 ADJUSTABLE RETURN AIR STAND

- 👑 Stand fits most 1½ through 3 ton Air Handlers.
- 👑 18 gauge Galvanized Steel with spot welded seams.
- 👑 Built in Filter Rack.
- 👑 18" High, 22" Deep, 14" - 25" Adjustable Width Dimension.

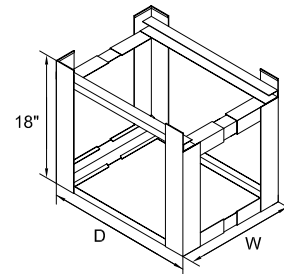

600 ADJUSTABLE AIR HANDLER STAND

- 👑 2-Way Adjustable. 18" High. 1" Filter Channel.
- 👑 14" - 27" Adjustable Width Dimension.
- 👑 17" - 29" Adjustable Depth Dimension.
- 👑 Shipped Knocked Down Flat in Carton with Assembly Hardware.
- 👑 Welded Tube Construction, Powder Coat Paint.

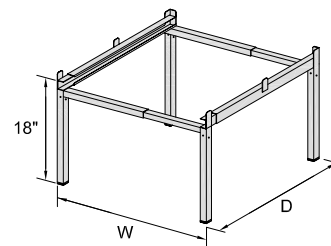

CONDENSING UNIT TIE DOWN BRACKET

- 👑 14 Gauge Galvanized Steel, Hot Dipped AFTER Punching.
- 👑 Slotted Holes for Easy Installation.
- 👑 Packaged 4 Brackets per Pack, 50 Packs per Box.
- 👑 Engineering Data Provided in each Pack.
- 👑 Standard Brackets are 1" Wide & Powder Coated, 556-2 is 2" Wide x 6" Long & Galvanized.

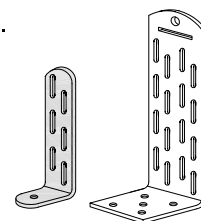

554 4" Long
556 6" Long
556-2 6" Long
558 8" Long

INSTALLATION ACCESSORIES

301- R RADIUS PLENUM

- ✎ 26 gauge Galvanized Steel, 21" Tall.
- ✎ Internally insulated with R-6 liner.
- ✎ Sized to fit air handler.

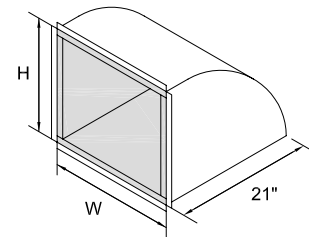

750 DRAIN PAN

- ✎ Available in 26 gauge and 24 gauge Galvanized Steel.
- ✎ One $\frac{3}{4}$ " female PVC nipple installed in the center of short side unless specified otherwise.

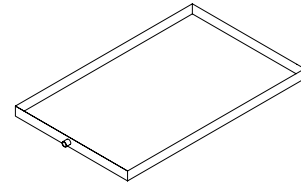

757 DRAIN PAN with SUPPORTS

- ✎ 24 gauge Galvanized Steel.
- ✎ 20 gauge support rails for placement of horizontal Air Handler.
- ✎ Options: With or without $\frac{3}{4}$ " female nipple - standard location is C/L long side. Eyebolts or "S" hooks for suspending unit are available.

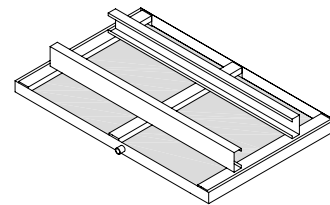

667 PACKAGE UNIT ADAPTERS, SUPPLY & RETURN

- ✎ 26 gauge Galvanized Steel.
- ✎ 1" deep panel sized to fit supply and return air openings. Collar diameter $\frac{1}{8}$ " undersized. 1" internal insulation.
- ✎ Packaged as kit - supply and return adapters.

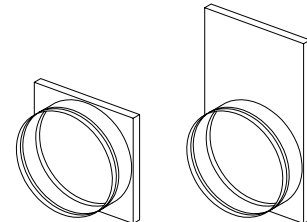

PL- 4 PLENUM BOX LEG

- ✎ 22 gauge Galvanized Steel. 3" x 3" tapered leg 4" long.
- ✎ Ideal for 301-CB, 301-SM and 301-DB plenum boxes.

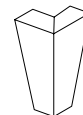

R-6 DUCT BOARD TRIANGLE BOXES

- ✎ Assembled with staples and UL SMACNA Tape.
- ✎ Four sizes available.

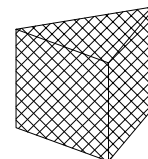

R-6 DUCT BOARD REDUCER BOXES

- ✎ Assembled with staples and UL SMACNA tape.
- ✎ Four sizes available.

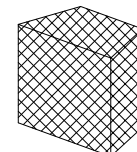

INSTALLATION ACCESSORIES

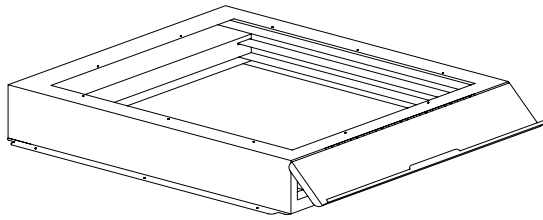

FILTER HOUSING FOR AIR HANDLERS & GAS FURNACES

- 👑 Fits Air Handlers & Furnaces through 5 tons.
- 👑 All Components Die Stamped.
- 👑 All Flanges have Rounded Corners.
- 👑 22 Gauge Galvanized Steel.
- 👑 Accepts 1" or 2" filters.
- 👑 Fully Hinged Door - No Panel or Door to Remove.

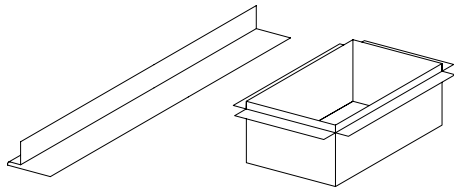

612 CAN STOCK
30 Gauge Galvanized Steel
10 ft. lengths or cut-to-size

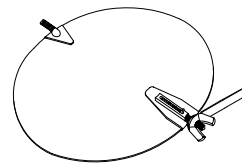

275 MANUAL VOLUME DAMPER

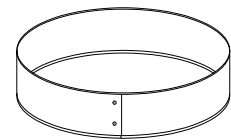

273 END CAP

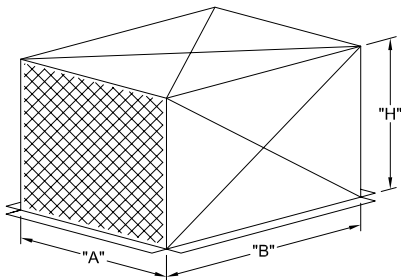

550 CONDENSING UNIT COVER

- 👑 24 Gauge Galvanized Steel (sides and top).
- 👑 Expanded Metal in both "A" x "H" openings.

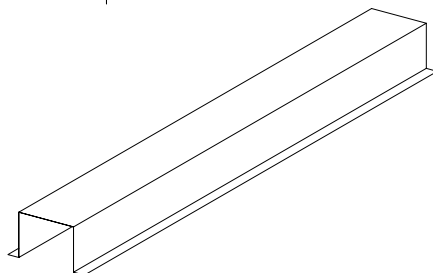

560 LINE COVER

Available in 8-ft. and 10-ft. lengths, 28 gauge and 26 gauge galvanized steel.

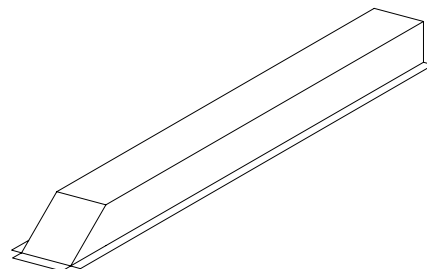

565 LINE COVER with CAP

461 EXPAND-O-DUCT
8" x 8" - 14" x 14"

465 EXPAND-O-DUCT
12" x 12" - 22" x 22"

469 EXPAND-O-DUCT
16" x 16" - 30" x 30"

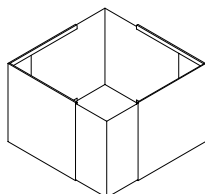





- 👑 Ideal as inside liner for fiberglass duct to support fire damper.
- 👑 22 gauge galvanized steel, 11" long.
- 👑 Edges interlock - no cutting necessary.

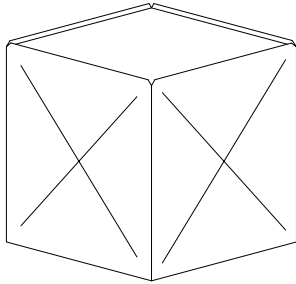



INSTALLATION ACCESSORIES

301 PLENUM - GALVANIZED STEEL







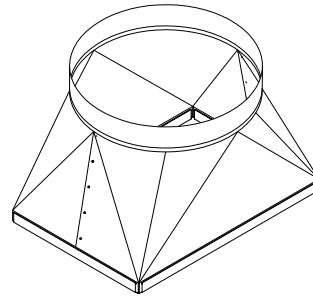

-  Internal Insulations Available: ½" x 2# Density Liner
 1" x 1.5# Density Liner
 2" x 1.5# Density Liner
-  Plenums are available in 28 gauge thru 22 gauge.
-  Button punch snaplock seam construction (4 sides) and recessed end cap standard.
-  Plenums are shipped knocked-down (5 pieces) and strapped.

480 RECTANGLE TO ROUND TRANSITION

-  Galvanized Steel
-  Available with crimp and bead collar for flexible duct attachment.
-  Transitions to 12" diameter and smaller fabricated from 28 gauge galvanized steel.
-  Transitions to 14" diameter and larger fabricated from 26 gauge galvanized steel.
-  Center-line taper is standard for Transitions. If "flat on one side" style taper is required, note the side to be flat as the first size given. For example, order size 20" x 16" - 12" rd. F.O.B. and the Transition will be flat on the 20" side.







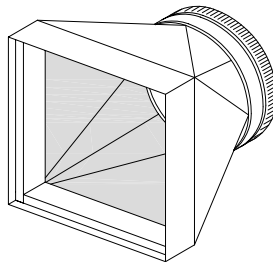

1480 RECTANGLE TO ROUND TRANSITION

-  Galvanized steel
-  Internally insulated with duct liner, R-4.2
-  Transitions to 12" diameter and smaller fabricated from 28 gauge galvanized steel.
-  Transitions to 14" diameter and larger fabricated from 26 gauge galvanized steel.
-  Collar crimped and beaded for flexible duct connection.
-  4" straight-away on rectangular end.
-  Galvanized steel sleeve inside - required by code.



1480-FL RECTANGLE TO ROUND TRANSITION

-  Galvanized steel
-  Internally insulated with duct liner, R-6.0
-  Transitions to 12" diameter and smaller fabricated from 28 gauge galvanized steel.
-  Transitions to 14" diameter and larger fabricated from 26 gauge galvanized steel.
-  Collar crimped and beaded for flexible duct connection.
-  4" straight-away on rectangular end.
-  Galvanized steel sleeve inside - required by code.

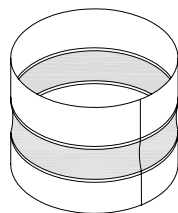

412-R FLEX CONNECTOR FOR ROUND END OF 480, 1480 AND 1480-FL

PASSIVE RETURN AIR SLEEVES

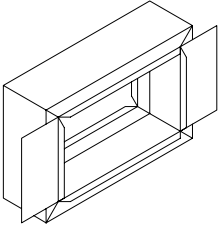

"PR" PASSIVE RETURN AIR SLEEVE

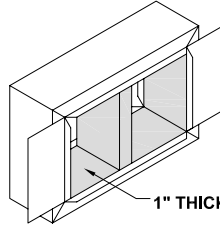

"SK" SILENT KNIGHT PASSIVE RETURN AIR SLEEVE

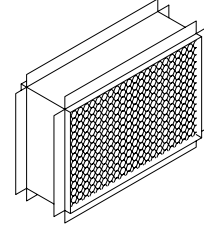

"RAP" RETURN AIR PATHWAY KIT

DUCT HANGERS

795 DUCT HANGER STRAP

Galvanized Steel
1" and 2" wide, 10-ft. long
Available in 28 ga., 26 ga., 24 ga.

798 DUCT HANGER STRAP

Galvanized Steel
1.5" wide x 100-ft. roll
Available in 26 ga.

792 TYING WIRE

18 gauge Galvanized
830-ft. Handi-Reel

777 DUCT HANGER STRAP

.019" thick Aluminum
1" x 200-ft. roll

697 DUCT BOARD HANGER CHANNEL

Galvanized Steel
10-ft. long
Available in 26 ga. and 22 ga.

797 DUCT HANGER STRAP

Galvanized Steel
1" wide x 100-ft. roll
Available in 26 ga. and 22 ga.

799 DUCT HANGER STRAP

Galvanized Steel
2" wide x 100-ft. roll
Available in 28 ga., 26 ga., 24 ga.

793 ANGLE

Galvanized Steel
Available in 30 ga. and 26 ga.

778 DUCT HANGER STRAP

.019" thick Aluminum
1" x 100-ft. roll

695 SADDLE HANGER for DUCT BOARD

22 ga. Galvanized Steel
4" wide, 2" x 2" angle

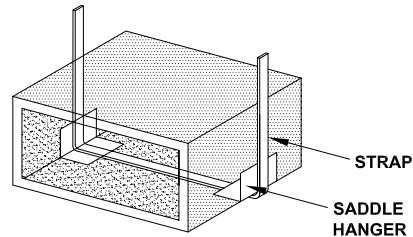
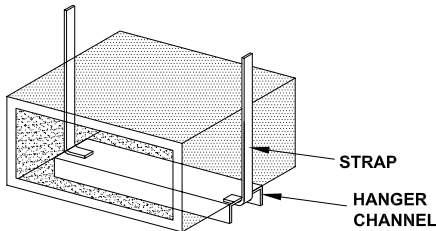

MOUNTING BRACKETS

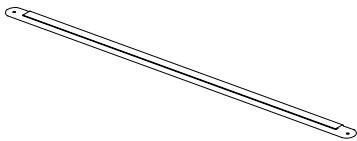

1252 MOUNTING BRACKET
Clip-on bracket for use with flanged Boots and Boxes
25" long, 26 ga. Galvanized

1250 MOUNTING BRACKET

Clip-on bracket for use with flanged Boots and Boxes
25" long, 24 ga. Galvanized

1250-16 MOUNTING BRACKET

Clip-on bracket for use with flanged Boots and Boxes
17" long, 24 ga. Galvanized

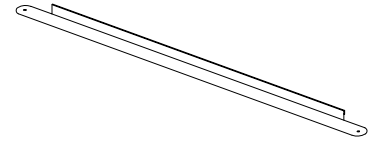

1254 MOUNTING BRACKET
Screw-on bracket for use with unflanged Boots and Boxes
25" long, 26 ga. Galvanized

VENT TOPS & FLASHINGS

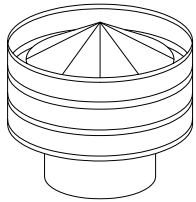

**332 VENT TOP
with WIND BAND**

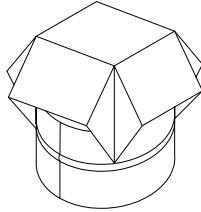

334 VENT TOP

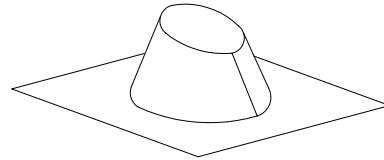

336 ROOF FLASHING

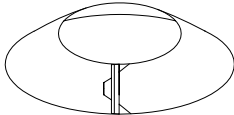

339 STORM COLLAR

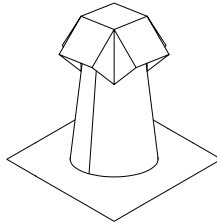

**341 ROOF JACK
for FLAT ROOF**

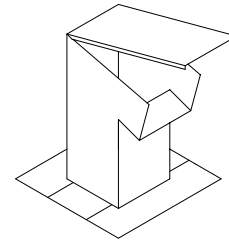

**353 ROOF JACK
for REFRIGERANT LINES**

**341-P ROOF JACK
for PITCHED ROOF**

WALLSTACK & FITTINGS

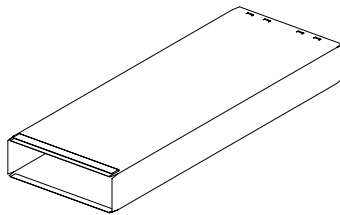

201 WALLSTACK DUCT

Wallstack duct is furnished in half sections, nested and strapped. 5 joints per bundle. Supplied with button lock side seams. 28 ga. Galv. Steel. Standard joint length is 3 ft.

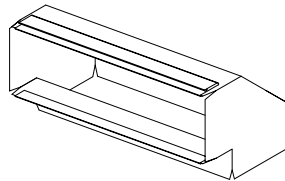

**240 90° ELBOW
SHORT WAY
(245 45° ELBOW
SHORT WAY)**

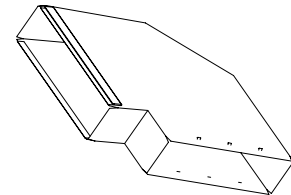

**230 90° ELBOW
LONG WAY
(235 45° ELBOW
LONG WAY)**

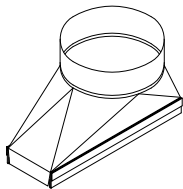

231 STRAIGHT BOOT

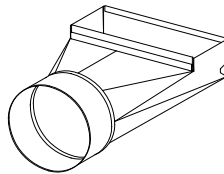

233 90° ANGLE BOOT

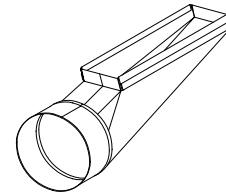

234 CENTER END BOOT

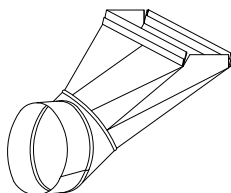

**236 ADJUSTABLE
OFFSET BOOT**

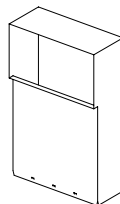

**223 STACKHEAD (11" THROAT)
222 STACHHEAD (8" THROAT)**

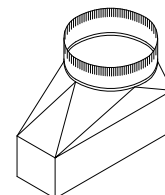

**232 RANGE HOOD
TRANSITION
3" RECTANGULAR STRAIGHTAWAY**

MOBILE HOME DUCT ACCESSORIES

SUPPLY AIR

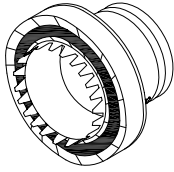

920 SUPPLY CONNECTOR
with GASKET and DAMPER

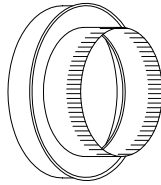

925 BUSHING

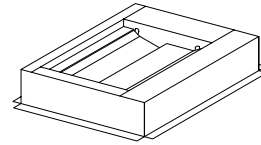

935 DAMPER SECTION
(To fit beneath furnace.
Top is removable to be used flat.)

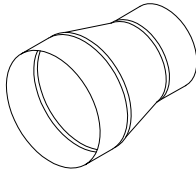

265 TAPERED REDUCER

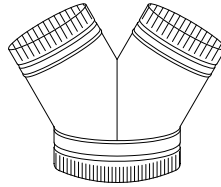

965 WYE

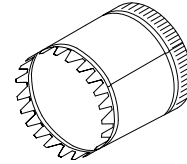

261-L STARTING COLLAR
6" LONG

RETURN AIR

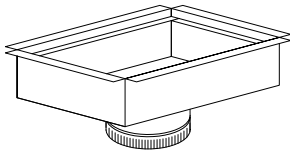

900 RETURN AIR BOX
6" DEEP with RACK for 1 FILTER

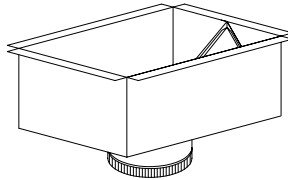

905 RETURN AIR BOX
10" DEEP with "A" RACK for 2 FILTERS

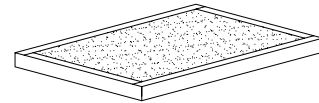

945 FILTER

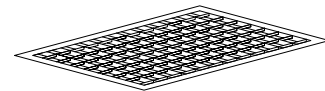

950 FLOOR GRILLE

MOBILE HOME DUCT KITS

971 SINGLE WIDE DUCT KIT, consisting of:

- 905 1 ea. R/A Box 12" x 20" - 14" oval
- 950 1 ea. 12" x 20" Floor Grille
- 945 2 ea. 10" x 20" x 1" Filter
- 920 1 ea. 12" Supply Connector

972 SINGLE WIDE DUCT KIT, consisting of:

- 905 1 ea. R/A Box 12" x 20" - 12" round
- 950 1 ea. 12" x 20" Floor Grille
- 945 2 ea. 10" x 20" x 1" Filter
- 920 1 ea. 12" Supply Connector

974 SINGLE WIDE DUCT KIT, consisting of:

- 905 1 ea. R/A Box 12" x 20" - 14" oval
- 950 1 ea. 12" x 20" Floor Grille
- 945 2 ea. 10" x 20" x 1" Filter
- 261-L 1 ea. 12" Starting Collar





976 DOUBLE WIDE DUCT KIT, consisting of:

- 905 1 ea. R/A Box 12" x 20" - 14" oval
- 950 1 ea. 12" x 20" Floor Grille
- 945 2 ea. 10" x 20" x 1" Filter
- 920 2 ea. 10" Supply Connector
- 965 1 ea. 12" x 10" x 10" Wye

COMMERCIAL DUCT PRODUCTS



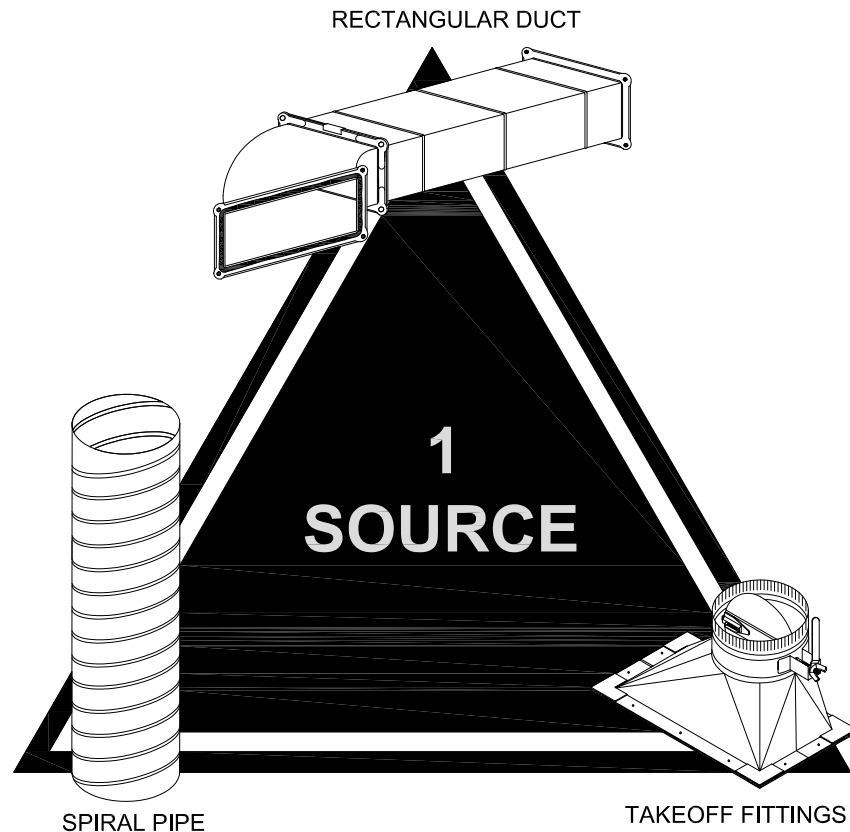

LET CROWN BE YOUR FULL-SERVICE COMMERCIAL DUCT PROVIDER

IT'S EASY TO GET GOING

-  You share your blueprints, material list or shop drawings with your Crown distributor.
-  No-cost quotes via Crown's Automated Estimating Program.
-  Job initiated and scheduled per your delivery goal.
-  Job site trailers available for large or multiple shipment jobs.



QUALITY CONSTRUCTION & CUSTOM SPECIFICATIONS WITH EVERY SHIPMENT

-  Commercial duct work is available in galvanized, paint-grip, and stainless steel.
-  Rectangular duct is available insulated with internal duct liner.
-  Rectangular and round duct is available in custom lengths to accommodate various job conditions.
-  All duct work is labeled for easy identification.

RECTANGULAR DUCT WORK

S-LOCK & DRIVE TRANSVERSE CONNECTION

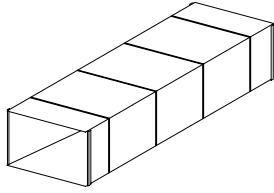

401 RECTANGULAR DUCT

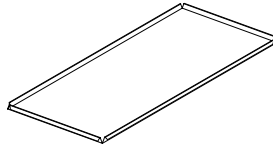

411 END CAP

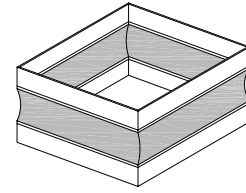

412 FLEX CONNECTOR

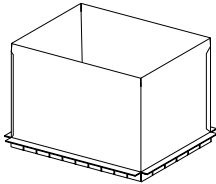

406 STARTING COLLAR

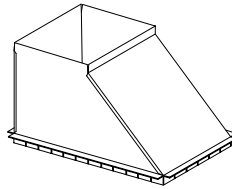

408 BOOT TAP

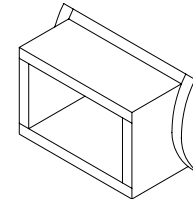

406-R GRILLE TAP

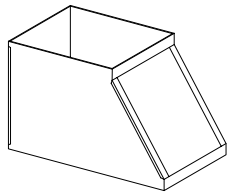

416 REDUCER

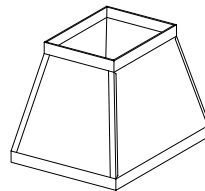

420 TRANSITION

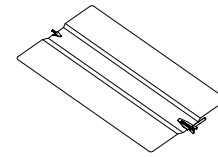

422 MANUAL VOLUME DAMPER

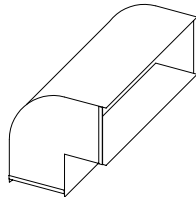

440 SHORT WAY 90° ELBOW

445 SHORT WAY 45° ELBOW

(NOT SHOWN)

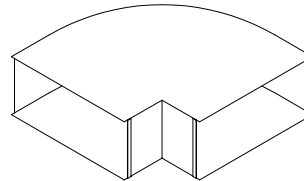

430 LONG WAY 90° ELBOW

435 LONG WAY 45° ELBOW

(NOT SHOWN)

RECTANGULAR DUCT TYPE B

FLANGED BOLT TOGETHER TRANSVERSE CONNECTION

800 SERIES TYPE B DUCT

Type B Duct is furnished in half sections ready to assemble.

Type B Duct fittings, reducers, transitions, and elbows are furnished assembled ready to install.

Type B Duct sections are furnished in two standard lengths, 56 1/4" and 44 1/4". Shorter lengths supplied as required.

Type B Duct sections are easily joined by four bolts/nuts (supplied). With the use of butyl gasket (supplied) no fabric and mastic are needed to assure air tight transverse joints.

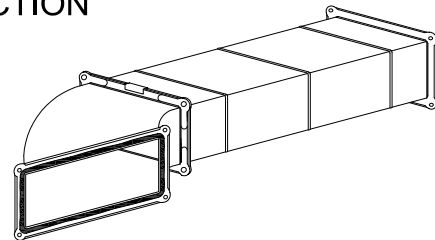





RECTANGULAR DUCT AVAILABLE WITH INTERNAL INSULATION.

CONTACT OUR COMMERCIAL DUCT DIVISION (800-818-7144) FOR PRICING AND AVAILABILITY.

SINGLE WALL SPIRAL DUCT WORK

SINGLE WALL SPIRAL PIPE & FITTINGS

-  Standard: Galvanized steel sheet per ASTM A653, CS Type B.
-  Optional: Galvannealed steel sheet (paintable) per ASTM A653. Coating designation A40.
-  Optional: Stainless Steel Type 304-2B.
-  Pipe diameters are nominal. Fittings are fabricated $\frac{1}{8}$ " undersized.

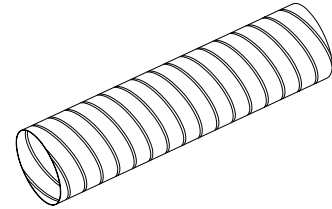

SP6101 SPIRAL PIPE
 4" - 38" Diameter
 10 ft. Jts. Standard

Steel Gauges:

Diameter	Pipe	Fittings
4" - 14"	26 ga.	24 ga.
16" - 26"	24 ga.	22 ga.
28" - 38"	22 ga.	20 ga.

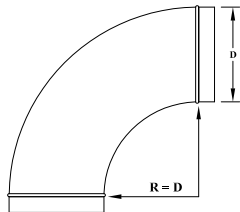

SP6111 90° ELBOW
 4" - 12" Die Stamped

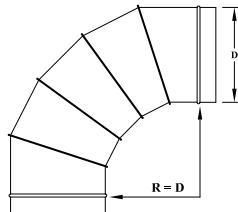

SP6111 90° ELBOW
 14" - 38" 5 Piece
 Gorelock

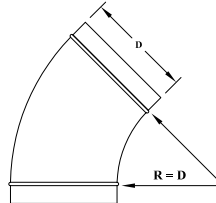

SP6121 45° ELBOW
 4" - 12" Die Stamped

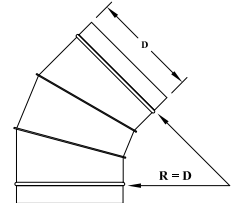

SP6121 45° ELBOW
 14" - 38" 3 Piece
 Gorelock

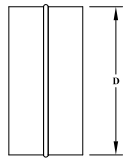

SP6680 COUPLING
 6" Long

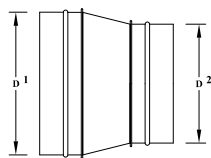

SP6265 REDUCER



SP6273 END CAP

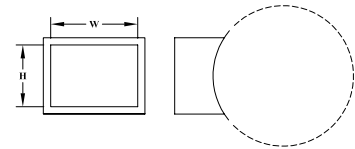

SP6406 GRILLE TAP

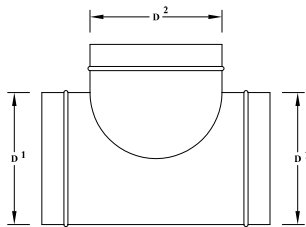

SP6271 90° TEE

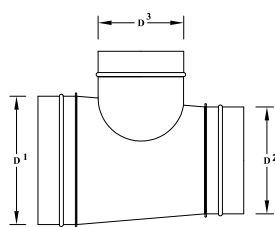

**SP6271R REDUCING
 TEE**

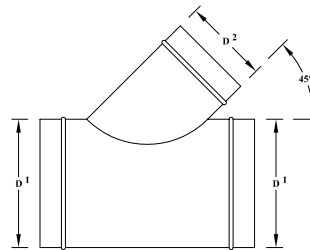

SP6276 45° LATERAL

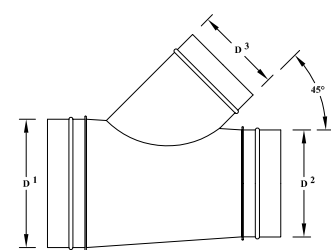

**SP6276R REDUCING
 LATERAL**

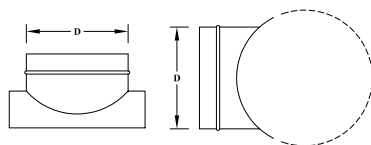







SP6307 90° SADDLE TAP

CONTACT OUR COMMERCIAL DUCT DIVISION (800-818-7144)
 FOR SPECIFICATIONS, PRICING AND AVAILABILITY.

DOUBLE WALL SPIRAL DUCT WORK

DOUBLE WALL SPIRAL PIPE & FITTINGS

-  Outer wall galvanized steel sheet per ASTM A653, CS Type B.
-  Outer wall (optional) galvanized steel sheet (paintable) per ASTM A653. Coating designation A40.
-  Outer wall (optional) stainless steel Type 304 2B
-  Pipe inner wall galvanized perforated steel.
-  Outboard flange transverse connection.
-  Steel Gauges: (outer wall)

Diameter	Pipe	Fittings
6" - 14"	26 ga.	24 ga.
16" - 26"	24 ga.	22 ga.
28" - 36"	22 ga.	20 ga.

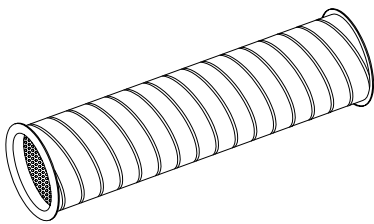

DW6101 SPIRAL PIPE
6" - 36" Diameter (I.D.)
10 ft. Jts. Standard

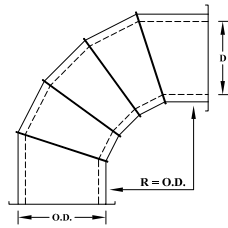

DW6111 90° ELBOW
5 Piece Gorelock

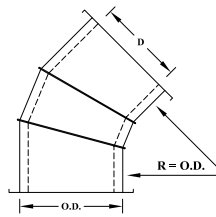

DW6121 45° ELBOW
3 Piece Gorelock

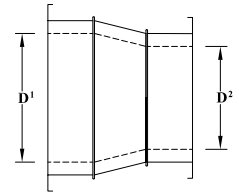

DW6265 REDUCER

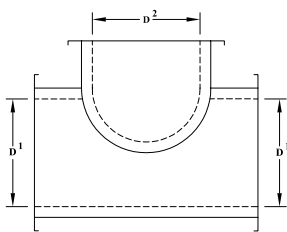

DW6271 90° TEE

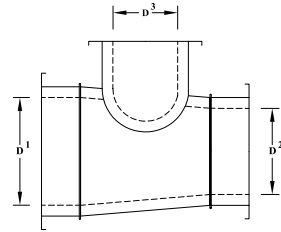

**DW6271R REDUCING
90° TEE**

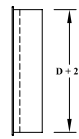

DW6273 END CAP

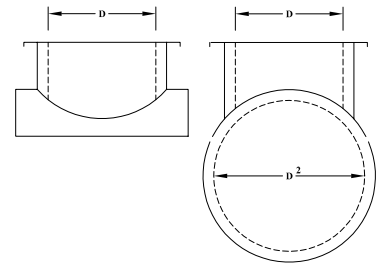

DW6307 SADDLE TAP

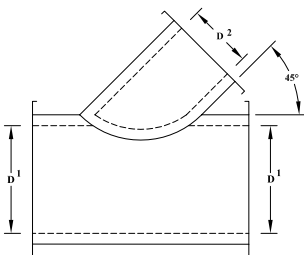

DW6276 45° LATERAL

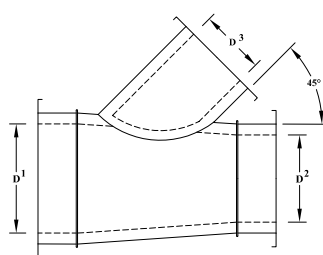

**DW6276R REDUCING
45° LATERAL**

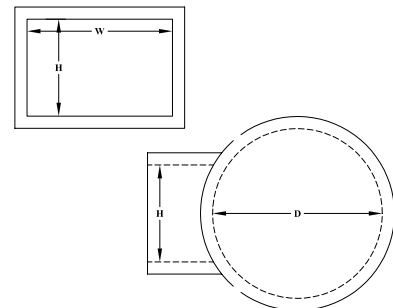

DW6406 GRILLE TAP

CONTACT OUR COMMERCIAL DUCT DIVISION (800-818-7144)
FOR SPECIFICATIONS, PRICING AND AVAILABILITY.

TURNING VANE & RAIL

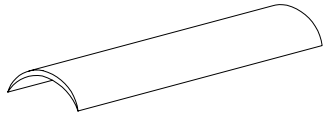

490 4" TURNING VANE
 24 Gauge Double Wall
 5 1/2" Overall Width
 10 ft. Sections

496 2" TURNING VANE
 26 Gauge Double Wall
 10 ft. Sections

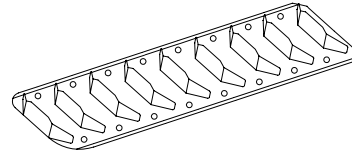

492 4" VANE RAIL
 24 Gauge
 10 ft. Sections

498 2" VANE RAIL
 24 Gauge
 10 ft. Sections

No. 496 2" Turning Vane is available on *special order basis*. Allow additional lead time.

TRANSVERSE DUCT CONNECTORS

AVAILABLE IN 5-ft. OR 10-ft. LENGTHS PACKAGED 100-ft. PER BUNDLE



FLAT S-LOCK
 1028 28 GA.
 1026 26 GA.
 1024 24 GA.

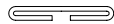

FLAT DRIVE
 1228 28 GA.
 1226 26 GA.
 1224 24 GA.

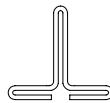

STANDING DRIVE
 1624 24 GA.
 1622 22 GA.
 1620 20 GA.

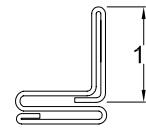

STANDING S-LOCK
 1126 26 GA.
 1124 24 GA.

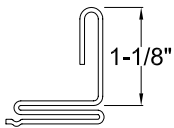

1" STANDING BAR-LOCK
 1324 24 GA.
 1322 22 GA.
 1320 20 GA.

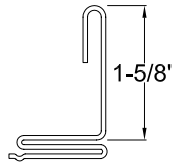



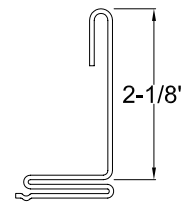



1-1/2" STANDING BAR-LOCK
 1424 24 GA.
 1422 22 GA.
 1420 20 GA.



2" STANDING BAR-LOCK
 1524 24 GA.
 1522 22 GA.
 1520 20 GA.

SLOT DIFFUSER PLENUMS

-  26 Gauge Galvanized Steel, Standard
-  1" x 1.5 lb. Density Internal Insulation, Standard
-  10" Standard Height
-  Plenum Length: 5-ft. and under
-  Round Collars Sized 4" through 9" Diameter
-  Oval Collars Sized 10" and Larger Diameter
-  Rectangular End Treatment as Required by Diffuser Spec

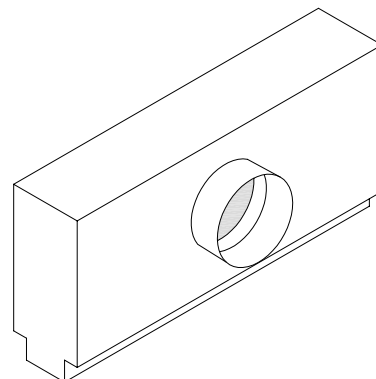

2001 SLOT DIFFUSER PLENUM

UNIVERSAL ACCESS DOOR

- 👑 For Sheet Metal Duct or 1" and 1 1/2" Duct Board
- 👑 Door Construction: 24 Gauge Galvanized Steel
Dovetails are 26 Gauge Galvanized Steel
- 👑 Door Sizes 6" x 6" through 16" x 16" Provided with 2 Cam Locks
- 👑 Larger Sizes Provided with 4 Cam Locks

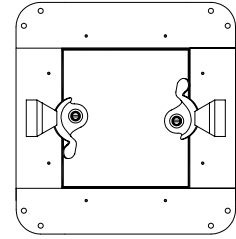

450 ACCESS DOOR

ACCESS DOOR

- 👑 Available Sizes: 6" x 6" - 24" x 24"
- 👑 Removable 24 Gauge Insulated Double Panel Door, 24 Gauge Frame
- 👑 Dual Cam Locks (4 Cam Locks on sizes 16" x 16" & larger)
- 👑 1" Thick Insulation in Door Panel
- 👑 1/2" Wide, 1/8" Thick Dual Gasket (Door to Frame / Frame to Duct)

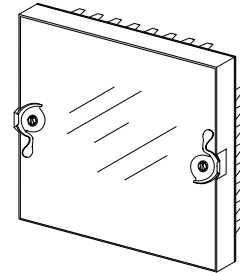

451 ACCESS DOOR

ACCESS DOOR FOR ROUND PIPE

- 👑 1" Flange Contoured to fit Round Sheet Metal Duct
- 👑 Construction: 24 Gauge Galvanized Steel Door
26 Gauge Galvanized Steel Body
- 👑 Door Sizes 6" x 6" through 16" x 16" Provided with 2 Cam Locks,
Larger Sizes Provided with 4 Cam Locks
- 👑 Gasket on Door Insures Air Tight Seal

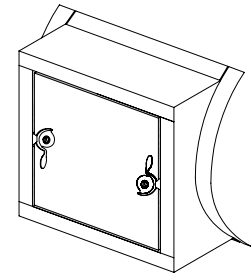

450-R ACCESS DOOR

ADAPTERS

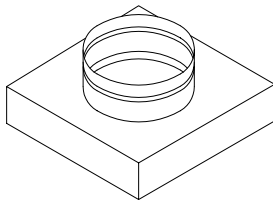

666 ADAPTER

- 👑 Rectangular dimension made 3/16" oversize
Round Collar dimension made 1/8" undersize
- 👑 Sizes 4" x 4" thru 24" x 24" - 28 gauge
Sizes 26" x 26" thru 30" x 30" - 26 gauge
- 👑 3" Deep Rectangular End
3" Long Round Collar
- 👑 Oval collars also available

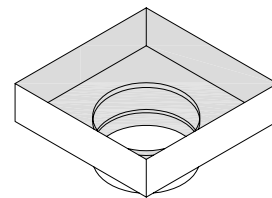









**666-B ADAPTER
BLACK INTERIOR**

- 👑 Rectangular dimension made 1/4" oversize
Round Collar dimension made 1/4" undersize
- 👑 All sizes 26 gauge
- 👑 2 7/8" Deep Rectangular End
2 3/4" Long Round Collar
- 👑 Black Interior

COMMERCIAL TAKEOFF FITTINGS

3000 Series Takeoff Fittings for Commercial Duct Installation.

- 
 Made to meet SMACNA gauge standards. Maximum 2" w.g. Positive Static Pressure. (SMACNA HVAC Duct Construction Standards Metal and Flexible - 2nd Edition 1995)
- 
 Fabricated with continuous weld longitudinal seam for no air leakage at 2" w.g. static pressure. Eliminates air leaks caused by riveted or spot welded seams.
- 
 Easy to install, features designed to reduce job installation costs.
- 
 Specifications:

Collar Diameter	Galvanized Steel Gauge
4" through 8"	28 gauge
9" through 14"	26 gauge
16" through 20"	24 gauge
- 
 Collar length is 5 1/2" - all sizes.
- 
 "D" suffix designates fittings with reinforced axis manual volume damper. Sizes 4" through 12" have reinforced damper axis with 1/4" regulator. Sizes 14" through 20" have 3/8" continuous rod damper axis.
- 
 "DS" suffix designates fittings with 2" damper handle standoff for blanket insulation. Sizes 4" through 12" have reinforced damper axis with 1/4" regulator. Sizes 14" through 20" have 3/8" continuous rod damper axis.
- 
 "DS2" suffix designates fittings sized 4" through 12" with 2" damper handle standoff and 3/8" continuous rod damper axis.

CONICAL SPIN-IN TAKEOFF

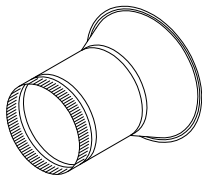

3200 CONICAL SPIN-IN

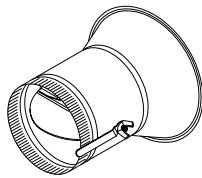

3200-D CONICAL SPIN-IN
with DAMPER

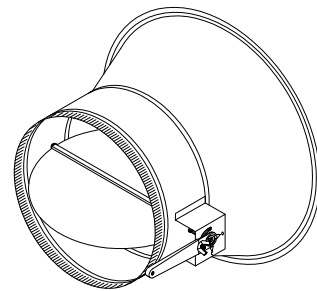

3200-DS CONICAL SPIN-IN
with 3/8" SOLID ROD AXIS
& 2" STANDOFF (14" - 20")

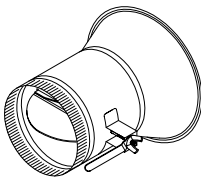

3200-DS CONICAL SPIN-IN
with 2" DAMPER HANDLE
STANDOFF (4" - 12")

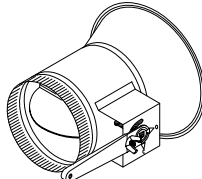

3200-DS2 CONICAL SPIN-IN
with 3/8" SOLID ROD AXIS
& 2" STANDOFF (4" - 12")

CONICAL TAKEOFF

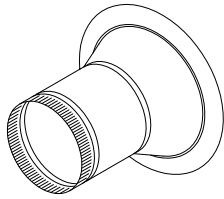

3210 CONICAL

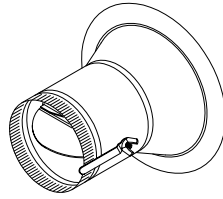

3210-D CONICAL
with DAMPER

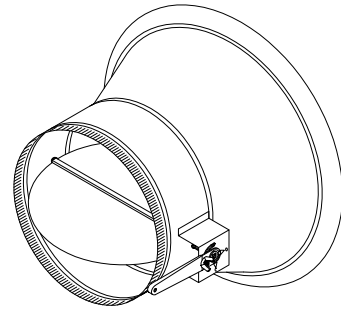

3210-DS CONICAL
with $\frac{3}{8}$ " SOLID ROD AXIS
& 2" STANDOFF (14" - 20")

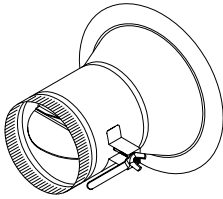

3210-DS CONICAL
with 2" DAMPER HANDLE
STANDOFF (4" - 12")

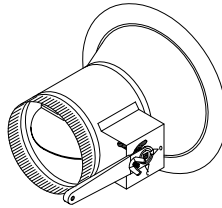

3210-DS2 CONICAL
with $\frac{3}{8}$ " SOLID ROD AXIS
& 2" STANDOFF (4" - 12")

THE No. 3210 SERIES TAKEOFFS HAVE 1" WIDE GASKET ON THE OUTBOARD FLANGE.

BELLMOUTH TAKEOFF

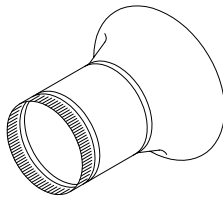

3210-B BELLMOUTH

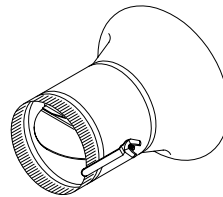

3210-BD BELLMOUTH
with DAMPER

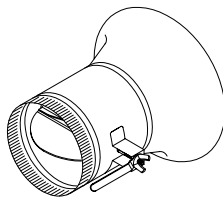

3210-BDS BELLMOUTH
with 2" DAMPER HANDLE
STANDOFF

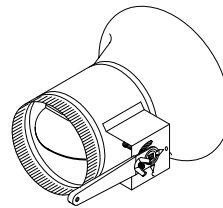

3210-BDS2 BELLMOUTH
with $\frac{3}{8}$ " SOLID ROD AXIS
& 2" STANDOFF

THE No. 3210-B SERIES IS AVAILABLE IN 6", 8", 10" and 12" DIAMETERS.
THE No. 3210-B SERIES TAKEOFFS HAVE GASKET MATERIAL ON THE OUTBOARD FLANGE.

RECTANGULAR TO ROUND TAKEOFF

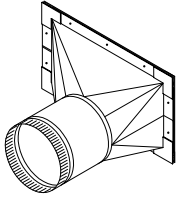

3300 45° TAKEOFF

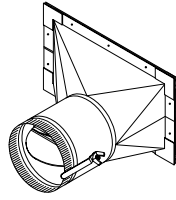

3300-D 45° TAKEOFF
with DAMPER

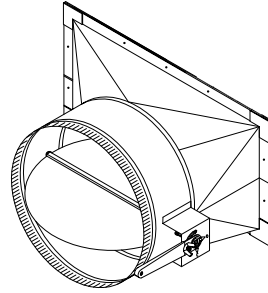

3300-DS 45° TAKEOFF
with $\frac{3}{8}$ " SOLID ROD AXIS
& 2" STANDOFF (14" - 20")

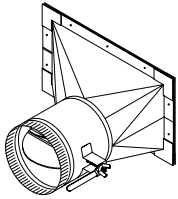

3300-DS 45° TAKEOFF
with 2" DAMPER HANDLE
STANDOFF (4" - 12")

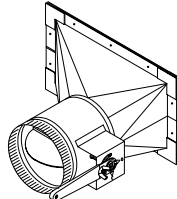

3300-DS2 45° TAKEOFF
with $\frac{3}{8}$ " SOLID ROD AXIS
& 2" STANDOFF (4" - 12")

THE No. 3300 SERIES TAKEOFFS HAVE 1" WIDE GASKET ON THE RECTANGULAR OUTBOARD FLANGE.

RECTANGULAR TO ROUND TAKEOFF

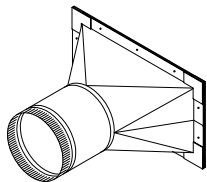

3400 TAKEOFF
CENTER TAPER

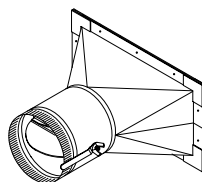

3400-D TAKEOFF
CENTER TAPER
with DAMPER

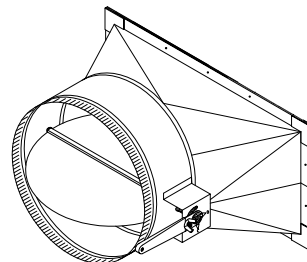

3400-DS TAKEOFF
CENTER TAPER
with $\frac{3}{8}$ " SOLID ROD AXIS
& 2" STANDOFF (14" - 20")

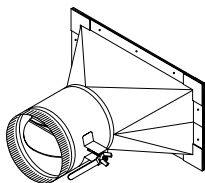

3400-DS TAKEOFF
CENTER TAPER
with 2" DAMPER HANDLE
STANDOFF (4" - 12")

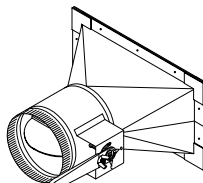

3400-DS2 TAKEOFF
CENTER TAPER
with $\frac{3}{8}$ " SOLID ROD AXIS
& 2" STANDOFF (4" - 12")

THE No. 3400 SERIES TAKEOFFS HAVE 1" WIDE GASKET ON THE RECTANGULAR OUTBOARD FLANGE.

STRAIGHT TAKEOFF

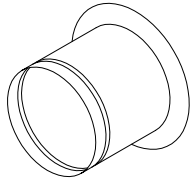

3710 TAKEOFF

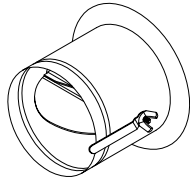

3710-D TAKEOFF
with DAMPER

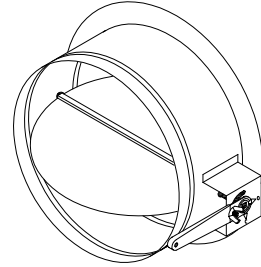

3710-DS TAKEOFF
with $\frac{3}{8}$ " SOLID ROD AXIS
& 2" STANDOFF (14" - 20")

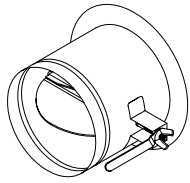

3710-DS TAKEOFF
with 2" DAMPER HANDLE
STANDOFF (4" - 12")

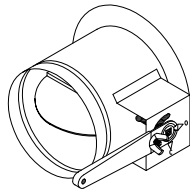

3710-DS2 TAKEOFF
with $\frac{3}{8}$ " SOLID ROD AXIS
& 2" STANDOFF (4" - 12")

THE No. 3710 SERIES TAKEOFFS HAVE 1" WIDE GASKET ON THE OUTBOARD FLANGE.

STRAIGHT SPIN-IN TAKEOFF

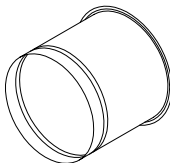

3720 SPIN-IN TAKEOFF

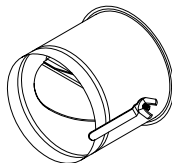

3720-D SPIN-IN TAKEOFF
with DAMPER

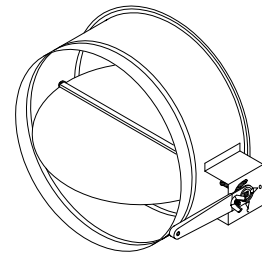

3720-DS SPIN-IN TAKEOFF
with $\frac{3}{8}$ " SOLID ROD AXIS
& 2" STANDOFF (14" - 20")

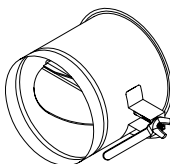

3720-DS SPIN-IN TAKEOFF
with 2" DAMPER HANDLE
STANDOFF (4" - 12")

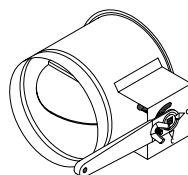

3720-DS2 SPIN-IN TAKEOFF
with $\frac{3}{8}$ " SOLID ROD AXIS
& 2" STANDOFF (4" - 12")

DAMPER SLEEVES

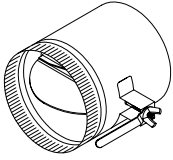

175-XS1 DAMPER SLEEVE
2" DAMPER HANDLE
STANDOFF
(SIZES 4" - 12")

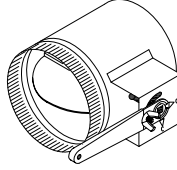

175-XS2 DAMPER SLEEVE
with $\frac{3}{8}$ " SOLID ROD AXIS
& 2" STANDOFF
(4" - 12")

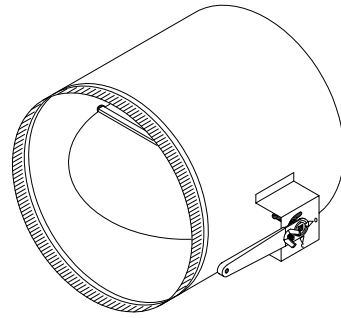

175-XS2 DAMPER SLEEVE
with $\frac{3}{8}$ " SOLID ROD AXIS
& 2" STANDOFF
(14" - 20")

NOTES

Distributed By



Corporate Office

6390 Philips Highway
Jacksonville, FL 32216
(904) 737-7144
(800) 683-7144
(904) 737-3533 fax

Commercial Duct Division

3545 New Kings Road
Jacksonville, FL 32209
(904) 924-8340
(800) 818-7144
(904) 924-0841 fax