

*Streamline*®

CARBON STEEL  
PRESS FITTINGS  
CATALOG

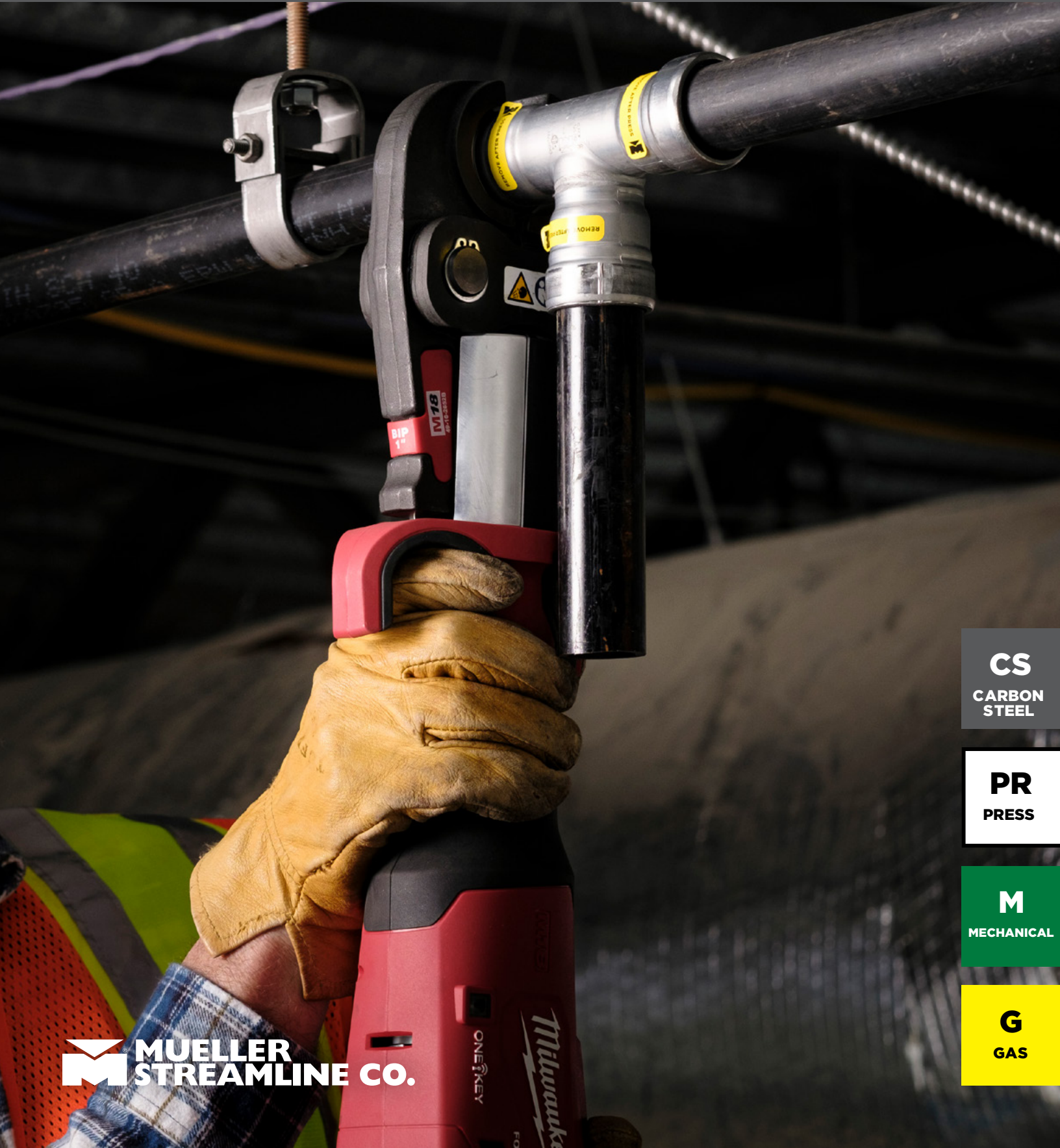

**CS**  
CARBON  
STEEL

**PR**  
PRESS

**M**  
MECHANICAL

**G**  
GAS

 **MUELLER  
STREAMLINE CO.**

ONEKEY

Milwaukee







The most trusted brand in piping systems products is now available in steel. Offering industry-leading technologies and intelligent design elements, Streamline<sup>®</sup> Carbon Steel Press Fittings provide professionals with a brand new level of system performance and reliability.

- Streamline<sup>®</sup> STL fitting line for Mechanical applications
- Streamline<sup>®</sup> STL-G fitting line for Gas applications
- Available in diameters from 1/2" to 2"
- Broad offering of 300+ fittings available
- Proprietary seal design provides unprecedented reliability

## TABLE OF CONTENTS

<b>WHY STREAMLINE<sup>®</sup> CARBON STEEL PRESS?</b> .....	<b>4</b>	<b>MECHANICAL (STL)</b> .....	<b>17</b>
<b>FEATURES &amp; HIGHLIGHTS</b> .....	<b>5</b>	<i>DIMENSIONAL DATA</i> .....	<i>18</i>
<b>WHY DUOFLEX<sup>™</sup> SEAL?</b> .....	<b>6</b>	<i>MECHANICAL APPLICATIONS</i> .....	<i>22</i>
<b>TOOLS &amp; JAW COMPATIBILITY</b> .....	<b>7</b>	<i>INSTALLATION INSTRUCTIONS – 1/2" – 2"</i> .....	<i>23</i>
<b>GAS (STL-G)</b> .....	<b>9</b>	<i>TESTING INSTRUCTIONS</i> .....	<i>24</i>
<i>DIMENSIONAL DATA</i> .....	<i>10</i>	<b>INSTALLATION GUIDELINES</b> .....	<b>25</b>
<i>GAS APPLICATIONS</i> .....	<i>14</i>	<b>FAQS</b> .....	<b>30</b>
<i>INSTALLATION INSTRUCTIONS – 1/2" – 2"</i> .....	<i>15</i>		





## WHY STREAMLINE® CARBON STEEL PRESS?

Along with soldering, brazing, threading, and grooving, press technology has become a standard joining solution for trade professionals. The popularity of press technology in the joining of copper systems inevitably led to the development of its use with other materials, particularly steel. Over the past years, there has been an increased acceptance and use of press technology with steel system applications such as mechanical, sprinkler, steam, and LP/natural gas.

During this time, our development team learned a lot about the unique challenges associated with the press joining of steel. As a result, Streamline® STL and Streamline® STL-G Carbon Press Fittings incorporate several thoughtful performance features to provide an improved fitting and more reliable joint.

These evolutionary advancements have focused on delivering greater ease of installation and increasing modern press technology reliability.

We understand that press tools and jaw sets are expensive investments for the contractor and costly inventory items for wholesalers. Therefore, we focused on improvements to the seal and grip mechanics rather than the fittings' shape/pattern designs. Because of this, Streamline® STL and Streamline® STL-G Carbon Press Fittings are compatible with most tools and jaws on the market, making use easy and cost-effective. Our efforts aimed and succeeded at providing a superior fitting while also reducing the need for reinvestment by the contractor or excessive SKU proliferation for the wholesaler.

### FEATURES & HIGHLIGHTS

Streamline® Carbon Steel Press Fittings have been engineered with several unique features and industry firsts to provide unmatched joint integrity, optimum system flow, and installer ease of use. Fittings are manufactured to specific ASTM standards & applicable system demands, thoroughly tested, and third-party certified. Proprietary innovations make Streamline® Carbon Steel Press Fittings the superior joining solution for your system.

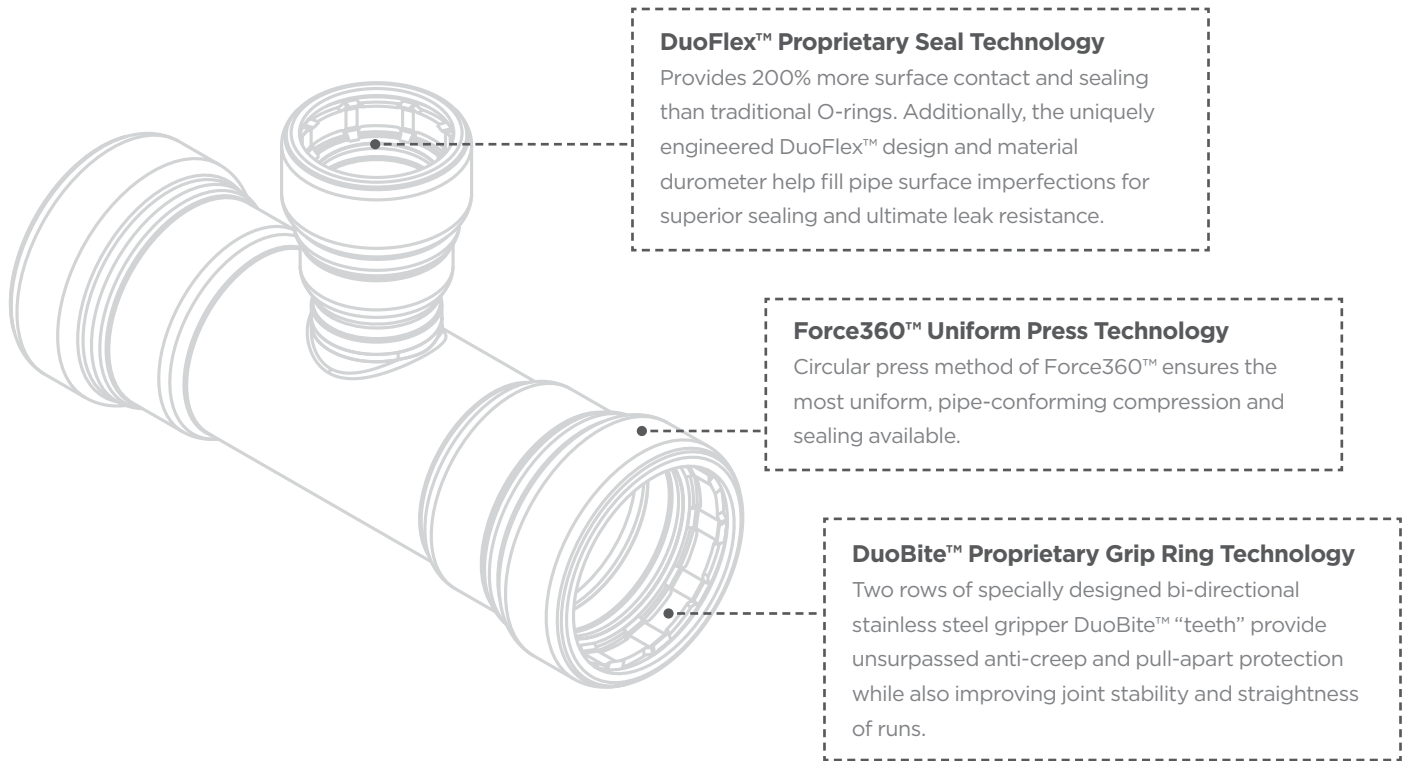

### EyeQ™ Intelligent Color Match System

With more and more joining methods and materials in the market, Streamline® wanted to make fittings and joining system selection more simplistic. Our Carbon Steel Press Fittings are some of the first to utilize our Eye-Q™ Intelligent Color Match System. Nuances in color across packaging, labeling, literature, seals, RAPID™ Flags, and other items will help end users and distributors visually identify the right fitting material, with the right joining method, and for the right system application.



### Remove After Press Identification (RAPID™) Flags

RAPID™ Flags offer installers and inspectors an easy and effective way of verifying completed joints or identifying unpressed joints. After pressing a joint, the installer removes the RAPID™ Flag from the fitting by grabbing the non-adhesive area and pulling it off. RAPID™ Flags are also easy to grasp while wearing gloves. Fast, simple, and smart.



## WHY DUOFLEX™ SEAL?

We have been around piping and flow-control products for over 100 years. Apart from threaded connections, nearly all pipe joining was originally done with filler metals and applied heat. The strength of these connections was obvious and appreciated. However, what might have gone more unnoticed was the incredible ability of soldering/brazing/welding processes to permanently fill and seal any surface imperfections in the pipe.

To be fair, piping lives a pretty rough life. It gets stored in hard steel bunks, gets shipped on open-top flatbeds, gets drug around dirty construction sites, gets hauled up construction elevators, etc., etc. In the case of carbon steel pipe, aka. black iron, it also gets an outside layer of corrosion protection via various paints, lacquers, epoxies, and even galvanizing alloys...all of which present different contact surfaces.

With the growing demand for mechanical joining came a growing reliance on O-ring seals. While O-rings are proven to be highly reliable on piping prepared under the best conditions, we know that is not where our loyal customers work every day. Our engineers ran hundreds of simulations and live tests that showed how small surface scratches and irregularities can cause annoying, slow leaks. We felt that we needed a way to recreate the impeccable capability of filler metals to address those infrequent gaps.

Thus, our patent-pending DuoFlex™ Seal is being incorporated in all Streamline® Carbon Steel Press Fittings. First, the seal design relies on a primary O-ring portion that does exactly what all others do. Importantly, the seal design adds a secondary, thinner sleeve or membrane portion that triples the amount of surface contact area. The thinner profile allows this portion of the seal to act much more flexible and to seal imperfections that an O-ring simply cannot. We are proud and excited to bring installers technology that leverages our legacy knowledge to help give our customers the confidence they deserve.



## TOOLS & JAW COMPATIBILITY

Using the performance requirements outlined in ANSI/CSA LC4 for STL-G and ASTM F3226 for STL, and in-house testing requirements in conjunction with operational instructions provided by various tool and jaw manufacturers, the tools and jaws listed below are compatible with Streamline® Carbon Steel Press Fittings.

It is important to follow the specific manufacturer's guidelines for best use and practice and for required and periodic maintenance of both the tool and jaws used in press systems. Failure to do so may void the tool and jaw manufacturers' warranties and cause improper pressing of fittings.

For additional information regarding manufacturers' tools and/or jaw sets, refer to the individual websites of the specific manufacturer. Individual tool and jaw manufacturers recommended maintenance and calibration schedules vary. Be sure to follow the instructions specific to the brand of tool and jaw set being used.



### 1/2" – 2"

- Milwaukee® M18™ FORCE LOGIC™ Press Tool w/ Standard Jaws
- Milwaukee® M18™ FORCE LOGIC™ Long Throw Press Tool w/ Standard Jaws
- REMS® Radial Press Standard w/ Standard Jaws
- Ridgid® RP Series Standard w/ Standard Jaws

### 1/2" – 3/4" ONLY

- Milwaukee® M12™ FORCE LOGIC™ w/ Compact Jaws
- REMS® Radial Press Compact w/ Compact Jaws
- Ridgid® RP Series Compact w/ Compact Jaws







## GAS (STL-G)

Streamline<sup>®</sup> STL-G Carbon Steel Press Fittings are designed for use in gas and fuel/oil piping systems utilizing Schedule 10 & Schedule 40 carbon steel pipe.

### Carbon Steel Fitting Body With:

- Corrosion-resistant zinc-nickel coating
- HNBR engineered sealing element
- 420 stainless steel grip ring
- CuZn15 brass separator ring

### Certifications:

- ANSI LC 4a/CSA 6.32a

### Complies With:

- ASME B31: Code for Pressure Piping
- (UMC) Uniform Mechanical Code
- (UPC) Uniform Plumbing Code
- (IMC) International Mechanical Code
- (IPC) International Plumbing Code
- (IFGC) International Fuel Gas Code
- NFPA 54 and 58

### Operating Parameters:

- Operating Pressure:
  - 125 PSI Max for fuel gas applications
  - 200 PSI Max for other approved applications
- Test Pressure: 600 PSI Max
- Temperature Range: -40°F to 180°F

### Approved Systems:

- Natural Gas (up to 125 PSI)
- Propane (up to 125 PSI)
- Mineral Oil (up to 200 PSI)
- Compressed Air (up to 200 PSI)
- Nitrogen (up to 200 PSI)
- Heating Fuel Oil (up to 125psi)

**CS**  
CARBON  
STEEL

**PR**  
PRESS

**G**  
GAS



15-Year Limited Warranty for approved mechanical applications\*

\*Approved applications includes non-industrial & non-marine applications.

DIMENSIONAL DATA

45° ELBOW  
P X P

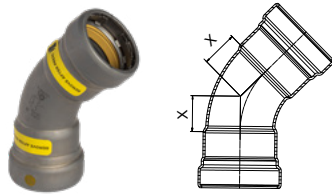

Item No.	Diameter	Catalog Wt.	Inner	Master	Dimensions (in.)	
					X	Z
CP03026G	1/2"	0.238	10	100	0.48	
CP03034G	3/4"	0.221	10	70	0.56	
CP03044G	1"	0.551	5	40	0.80	
CP03050G	1 1/4"	0.913	1	20	0.94	
CP03055G	1 1/2"	1.045	1	15	1.05	
CP03059G	2"	1.270	1	5	1.20	

45° ELBOW • STREET  
FTG X P

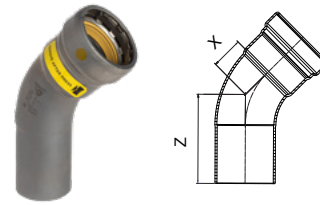

Item No.	Diameter	Catalog Wt.	Inner	Master	Dimensions (in.)	
					X	Z
CP03326G	1/2"	0.221	10	120	0.48	1.91
CP03334G	3/4"	0.205	10	30	0.56	2.07
CP03344G	1"	0.523	5	40	0.80	2.47
CP03350G	1 1/4"	0.871	1	20	0.94	3.11
CP03355G	1 1/2"	1.001	1	15	1.05	3.30
CP03359G	2"	1.232	1	5	1.20	3.51

90° ELBOW • LONG RADIUS  
P X P

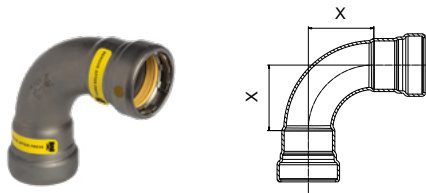

Item No.	Diameter	Catalog Wt.	Inner	Master	Dimensions (in.)	
					X	Z
CP02722G	1/2"	0.289	10	40	1.17	
CP02734G	3/4"	0.408	10	50	1.37	
CP02747G	1"	0.692	5	15	1.96	
CP02055G	1 1/4"	1.076	1	6	2.28	
CP02063G	1 1/2"	1.268	1	4	2.55	
CP02072G	2"	1.605	1	7	2.93	

90° ELBOW • LONG RADIUS • STREET  
FTG X P

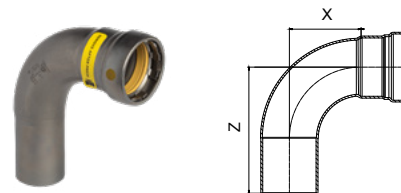

Item No.	Diameter	Catalog Wt.	Inner	Master	Dimensions (in.)	
					X	Z
CP02822G	1/2"	0.269	10	50	1.17	2.60
CP02834G	3/4"	0.390	10	30	1.37	2.87
CP02847G	1"	0.677	5	30	1.96	3.62
CP02350G	1 1/4"	1.014	1	10	2.28	4.45
CP02355G	1 1/2"	1.283	1	10	2.55	4.80
CP02359G	2"	1.568	1	7	2.93	5.24

ADAPTER • FEMALE  
P X FPT

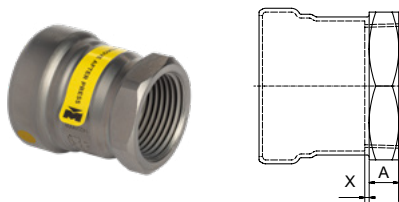

Item No.	Diameter	Catalog Wt.	Inner	Master	Dimensions (in.)	
					A	X
CP01231G	1/2"	0.132	10	80	0.52	0.00
CP01246G	3/4"	0.216	10	60	0.52	0.00
CP01263G	1"	0.293	5	20	0.66	0.01
CP01271G	1 1/4"	0.527	1	35	0.68	0.07
CP01279G	1 1/2"	0.650	1	20	0.68	0.04
CP01287G	2"	0.800	1	15	0.63	0.00

ADAPTER • MALE  
P X MPT

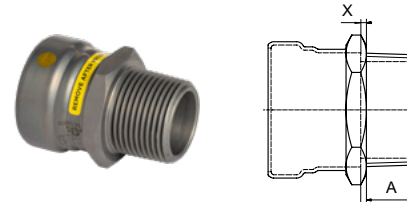

Item No.	Diameter	Catalog Wt.	Inner	Master	Dimensions (in.)	
					A	X
CP01131G	1/2"	0.181	10	70	0.75	0.17
CP01146G	3/4"	0.262	10	60	0.83	0.15
CP01163G	1"	0.381	5	30	0.98	0.10
CP01171G	1 1/4"	0.553	5	20	1.02	0.12
CP01179G	1 1/2"	0.778	1	20	1.02	0.21
CP01187G	2"	0.871	1	15	1.06	0.12

CS  
CARBON  
STEEL

PR  
PRESS

G  
GAS



### ADAPTER • FEMALE • REDUCING P X FPT

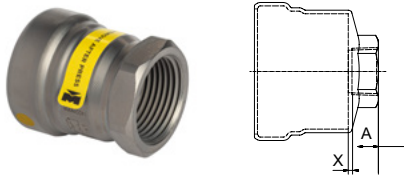

Item No.	Diameter	Catalog Wt.	Inner	Master	Dimensions (in.)	
					A	X
CP01247G	3/4" x 1/2"	0.201	10	80	0.50	0.00
CP01265G	1" x 1/2"	0.282	10	50	0.54	0.02
CP01264G	1" x 3/4"	0.309	5	40	0.55	0.00
CP01268G	1 1/4" x 1/2"	0.474	1	30	0.54	0.02
CP01269G	1 1/4" x 3/4"	0.492	1	30	0.56	0.04
CP01272G	1 1/4" x 1"	0.476	1	15	0.66	0.01
CP01276G	1 1/2" x 1/2"	0.571	1	13	0.54	0.11

### ADAPTER • FEMALE • REDUCING (CONT'D) P X FPT

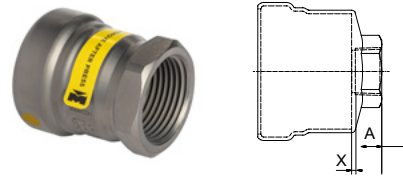

Item No.	Diameter	Catalog Wt.	Inner	Master	Dimensions (in.)	
					A	X
CP01277G	1 1/2" x 3/4"	0.582	1	25	0.56	0.09
CP11279G	1 1/2" x 1"	0.620	1	25	0.66	0.06
CP01280G	1 1/2" x 1 1/4"	0.626	1	25	0.68	0.04
CP01283G	2" x 1/2"	0.750	1	20	0.54	0.09
CP01284G	2" x 3/4"	0.758	1	20	0.56	0.07
CP01285G	2" x 1"	0.721	1	20	0.63	0.00
CP01286G	2" x 1 1/4"	0.752	1	20	0.68	0.03
CP01288G	2" x 1 1/2"	0.701	1	20	0.68	0.03

### CAP P

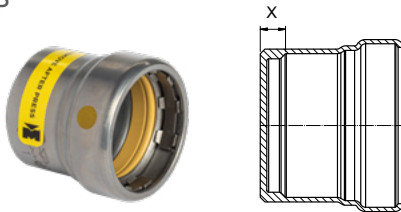

Item No.	Diameter	Catalog Wt.	Inner	Master	Dimensions (in.)
					X
CP07007G	1/2"	0.124	10	120	0.23
CP07009G	3/4"	0.185	10	80	0.28
CP07011G	1"	0.284	5	80	0.32
CP07012G	1 1/4"	0.434	1	30	0.33
CP07013G	1 1/2"	0.545	1	25	0.33
CP07014G	2"	0.697	1	20	0.40

### COUPLING • NO STOP P X P

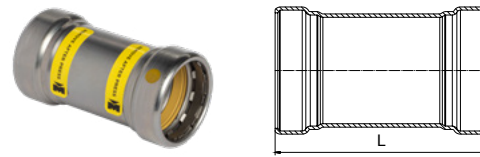

Item No.	Diameter	Catalog Wt.	Inner	Master	Dimensions (in.)
					L
CP01903G	1/2"	0.218	10	100	2.79
CP01905G	3/4"	0.298	10	70	3.01
CP01906G	1"	0.439	5	40	3.37
CP01907G	1 1/4"	0.725	1	20	4.34
CP01908G	1 1/2"	0.858	1	17	4.60
CP01909G	2"	1.014	1	12	4.86

### COUPLING • STAKED STOP P X P

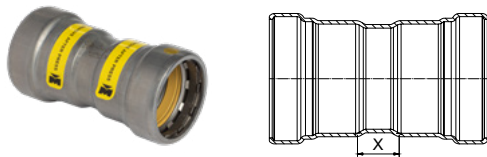

Item No.	Diameter	Catalog Wt.	Inner	Master	Dimensions (in.)
					X
CP10145G	1/2"	0.221	10	50	0.52
CP10146G	3/4"	0.300	10	70	0.54
CP10147G	1"	0.454	5	40	0.59
CP10148G	1 1/4"	0.745	1	20	0.62
CP10149G	1 1/2"	0.871	1	15	0.67
CP10150G	2"	1.058	1	12	0.84

### COUPLING • NO STOP • EXTENDED P X P

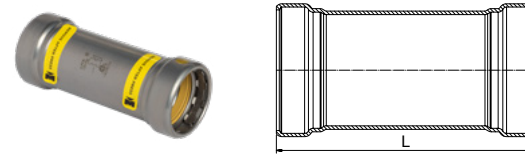

Item No.	Diameter	Catalog Wt.	Inner	Master	Dimensions (in.)
					L
CP01950G	1/2"	0.280	10	40	3.84
CP01952G	3/4"	0.381	10	30	4.04
CP01955G	1"	0.564	5	15	4.43
CP01956G	1 1/4"	0.873	1	20	5.35
CP01957G	1 1/2"	0.983	1	8	5.47
CP01958G	2"	1.157	1	6	5.67

**CS**  
CARBON  
STEEL

**PR**  
PRESS

**G**  
GAS

DIMENSIONAL DATA

COUPLING • REDUCING

P X P

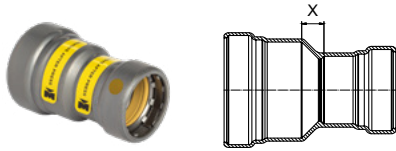

Item No.	Diameter	Catalog Wt.	Inner	Master	Dimensions (in.)	
					X	
CP01036G	3/4" x 1/2"	0.249	5	40	0.31	
CP01051G	1" x 1/2"	0.333	5	30	0.43	
CP01049G	1" x 3/4"	0.355	5	30	0.30	
CP01058G	1 1/4" x 3/4"	0.529	1	15	0.47	
CP01056G	1 1/4" x 1"	0.573	1	12	0.34	
CP01064G	1 1/2" x 1 1/4"	0.767	1	10	0.28	
CP01074G	2" x 1 1/4"	0.893	1	8	0.52	
CP01073G	2" x 1 1/2"	0.897	1	8	0.40	

FITTING REDUCER

FTG X P

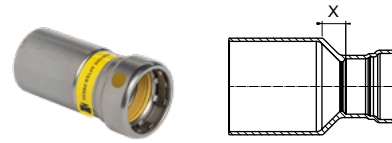

Item No.	Diameter	Catalog Wt.	Inner	Master	Dimensions (in.)	
					X	
CP01326G	3/4" x 1/2"	0.209	5	100	0.12	
CP01339G	1" x 1/2"	0.280	5	40	0.25	
CP01337G	1" x 3/4"	0.295	5	80	0.11	
CP01343G	1 1/4" x 1"	0.485	1	35	0.22	
CP01353G	1 1/2" x 3/4"	0.509	1	30	0.44	
CP01351G	1 1/2" x 1"	0.567	1	30	0.32	
CP01350G	1 1/2" x 1 1/4"	0.644	1	20	0.10	
CP01360G	2" x 1"	0.692	1	20	0.56	
CP01359G	2" x 1 1/4"	0.798	1	20	0.39	
CP01358G	2" x 1 1/2"	0.833	1	8	0.28	

TEE

P X P X P

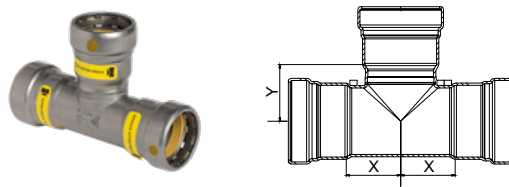

Item No.	Diameter	Catalog Wt.	Inner	Master	Dimensions (in.)	
					X	Y
CP04006G	1/2"	0.397	5	50	0.93	0.87
CP04031G	3/4"	0.578	5	30	1.06	0.98
CP04048G	1"	0.849	5	20	1.22	1.18
CP04068G	1 1/4"	1.411	1	8	1.40	1.39
CP04084G	1 1/2"	1.642	1	8	1.53	1.54
CP40102G	2"	2.002	1	5	1.80	1.87

TEE • REDUCING

P X P X P

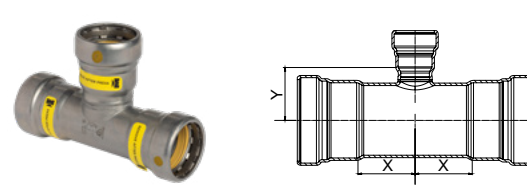

Item No.	Diameter	Catalog Wt.	Inner	Master	Dimensions (in.)	
					X	Y
CP04033G	3/4" x 3/4" x 1/2"	0.527	5	30	1.06	0.99
CP04051G	1" x 1" x 1/2"	0.741	5	25	1.22	1.13
CP04049G	1" x 1" x 3/4"	0.803	5	20	1.22	1.12
CP04071G	1 1/4" x 1 1/4" x 1/2"	1.140	1	14	1.40	1.30
CP04070G	1 1/4" x 1 1/4" x 3/4"	1.186	1	12	1.40	1.30
CP04069G	1 1/4" x 1 1/4" x 1"	1.259	1	10	1.40	1.36
CP04088G	1 1/2" x 1 1/2" x 1/2"	1.314	1	10	1.53	1.44
CP04087G	1 1/2" x 1 1/2" x 3/4"	1.371	1	10	1.53	1.43
CP04086G	1 1/2" x 1 1/2" x 1"	1.433	1	8	1.53	1.50
CP04085G	1 1/2" x 1 1/2" x 1 1/4"	1.583	1	8	1.53	1.53
CP40107G	2" x 2" x 1/2"	1.609	1	7	1.80	1.68
CP40106G	2" x 2" x 3/4"	1.656	1	7	1.80	1.67
CP40105G	2" x 2" x 1"	1.711	1	7	1.80	1.73
CP40104G	2" x 2" x 1 1/4"	1.197	1	6	1.80	1.77
CP40103G	2" x 2" x 1 1/2"	2.143	1	6	1.80	1.79

CS  
CARBON  
STEEL

PR  
PRESS

G  
GAS



### TEE • FEMALE P X P X FPT

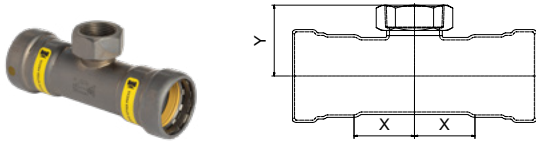

Item No.	Diameter	Catalog Wt.	Inner	Master	Dimensions (in.)	
					X	Y
CP01539G	3/4" x 3/4" x 1/2"	0.474	5	35	1.06	1.38
CP01538G	3/4" x 3/4" x 3/4"	0.545	5	35	1.06	1.40
CP01570G	1" x 1" x 1/2"	0.692	5	30	1.22	1.54
CP01572G	1" x 1" x 3/4"	0.758	5	30	1.22	1.54
CP01613G	1 1/4" x 1 1/4" x 1/2"	1.091	1	15	1.40	1.71
CP02654G	1 1/4" x 1 1/4" x 3/4"	1.133	1	12	1.40	1.71
CP02655G	1 1/4" x 1 1/4" x 1"	1.204	1	12	1.40	1.87
CP01645G	1 1/2" x 1 1/2" x 1/2"	1.272	1	10	1.53	1.83

### TEE • FEMALE (CONT'D) P X P X FPT

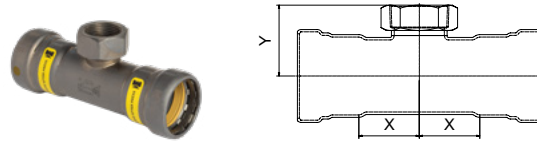

Item No.	Diameter	Catalog Wt.	Inner	Master	Dimensions (in.)	
					X	Y
CP02673G	1 1/2" x 1 1/2" x 3/4"	1.336	1	10	1.53	1.83
CP02688G	1 1/2" x 1 1/2" x 1"	1.378	1	10	1.53	1.99
CP02691G	1 1/2" x 1 1/2" x 1 1/4"	1.429	1	8	1.53	1.99
CP01699G	2" x 2" x 1/2"	1.545	1	8	1.80	2.01
CP02706G	2" x 2" x 3/4"	1.609	1	8	1.80	2.01
CP02703G	2" x 2" x 1"	1.665	1	7	1.80	2.20
CP02704G	2" x 2" x 1 1/4"	1.706	1	7	1.80	2.26
CP02705G	2" x 2" x 1 1/2"	1.728	1	7	1.80	2.20

### UNION P X P

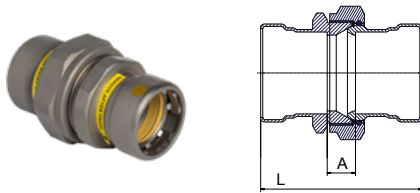

Item No.	Diameter	Catalog Wt.	Inner	Master	Dimensions (in.)	
					A	L
CP08003G	1/2"	0.489	5	30	0.85	3.04
CP08004G	3/4"	0.778	5	20	0.85	3.23
CP08005G	1"	1.204	5	25	0.83	3.51
CP11205G	1 1/4"	2.121	1	7	0.99	4.61
CP11206G	1 1/2"	2.487	1	5	1.10	4.93
CP11207G	2"	3.014	1	4	0.83	4.77

### UNION • FEMALE P X FPT

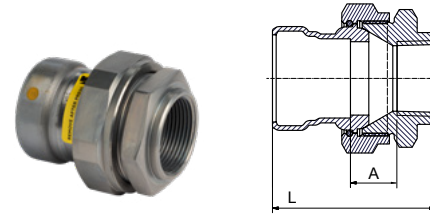

Item No.	Diameter	Catalog Wt.	Inner	Master	Dimensions (in.)	
					A	L
CP11422G	1/2"	0.454	5	30	0.78	2.40
CP11423G	3/4"	0.719	5	20	0.69	2.48
CP11424G	1"	0.741	5	15	0.80	2.80
CP11425G	1 1/4"	1.127	1	7	0.78	3.27
CP11426G	1 1/2"	2.350	1	5	0.99	3.58
CP11427G	2"	2.780	1	3	0.85	3.50

### UNION • MALE P X MPT

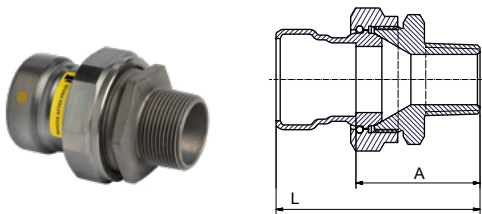

Item No.	Diameter	Catalog Wt.	Inner	Master	Dimensions (in.)	
					A	L
CP11210G	1/2"	0.470	5	30	1.70	2.84
CP11211G	3/4"	0.719	5	20	1.80	3.04
CP11212G	1"	1.168	5	15	2.01	3.39
CP11213G	1 1/4"	1.821	1	8	2.13	3.98
CP11214G	1 1/2"	2.359	1	5	2.24	4.22
CP11215G	2"	2.780	1	3	2.28	4.30

### FLANGE P X FLANGE

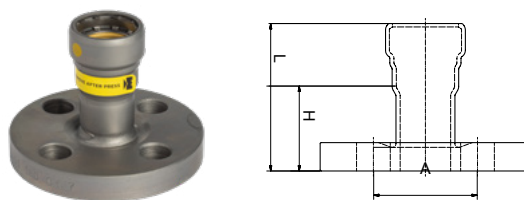

Item No.	Diameter	Catalog Wt.	Inner	Master	Dimensions (in.)		
					A	H	L
CP02881G	1/2"	1.191	1	4	2.37	1.37	2.44
CP04114G	3/4"	1.799	1	4	2.75	1.67	2.85
CP02933G	1"	2.407	1	4	3.13	1.82	3.14
CP03806G	1 1/4"	2.897	1	2	3.50	2.12	3.91
CP03907G	1 1/2"	3.695	1	2	3.87	2.25	4.15
CP02980G	2"	5.487	1	1	4.75	2.61	4.53

**CS**  
CARBON  
STEEL

**PR**  
PRESS

**G**  
GAS



# GAS APPLICATIONS

Streamline® STL-G Carbon Steel Press Fittings are designed for use in piping systems utilizing ASTM A53, Schedule 10 & Schedule 40 carbon steel pipe for use in fuel gas systems, fuel oil systems and applications with a high oil content. Listed below are common applications approved for Streamline® STL-G.

## APPROVED APPLICATIONS FOR 1/2" TO 2" STREAMLINE® STL-G:

Types of Service	Comments	Pressure	Temperature	Compatible with HNBR Seal
<b>FUEL, OIL AND LUBRICANT</b>				
Mineral Oil	—	200 PSI	Ambient	✓
Lube Oil	Petroleum based	200 PSI	Up to 150°F	✓
Propane	—	125 PSI	-40°F to 180°F	✓
Butane	—	125 PSI	-40°F to 180°F	✓
Natural Gas	—	125 PSI	-40°F to 180°F	✓
Heating Fuel Oil	—	125 PSI	Up to 100°F	✓
Diesel Fuel	—	125 PSI	Up to 100°F	✓
<b>NON-MEDICAL GASES</b>				
Compressed Air	—	200 PSI	Up to 140°F	✓
Oxygen - O <sub>2</sub> (non medical)	Keep oil and fat free/non-liquid O <sub>2</sub>	140 PSI	Up to 140°F	✓
Nitrogen - N <sub>2</sub>	—	200 PSI	Up to 140°F	✓
Hydrogen - H <sub>2</sub>	—	125 PSI	Up to 140°F	✓
Vacuum	Maximum differential pressure	Max 29.2 inches of Mercury	Up to 160°F	✓
Carbon Dioxide - CO <sub>2</sub>	Dry	200 PSI	Up to 140°F	✓
Carbon Monoxide - CO	—	200 PSI	Up to 140°F	✓
Argon- Ar	—	200 PSI	Up to 140°F	✓
Acetylene	Test pressure 350 PSI	20 PSI	Ambient	✓

**CS**  
CARBON  
STEEL

**PR**  
PRESS

**G**  
GAS



# INSTALLATION INSTRUCTIONS – 1/2" – 2"

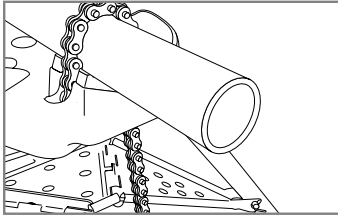

**1** Keep vise a minimum of 4" from cutting area to avoid damage to pipe.

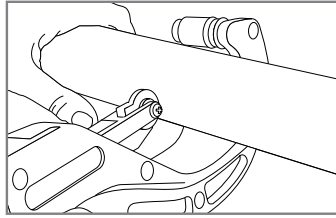

**2** Cut pipe square using a displacement-type cutter or fine-toothed saw.

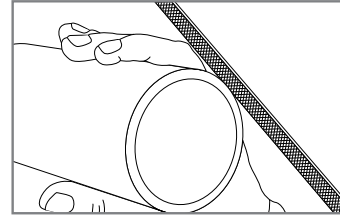

**3** Deburr pipe ID and OD using half round file or deburr tool.

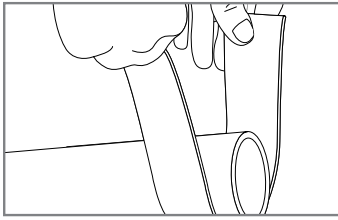

**4** Sand pipe OD to proper insertion depth. Pipe surface must be smooth and free of rust, indentation, deformation, and pipe coating.

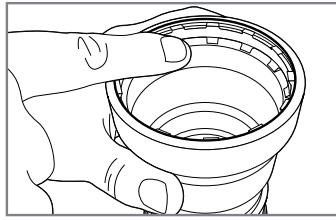

**5** Check fitting ends to ensure seal, grip ring, and spacer are present.

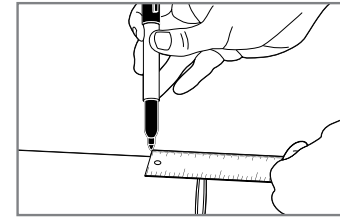

**6** Mark pipe to proper fitting insertion depth (see insertion depth chart).

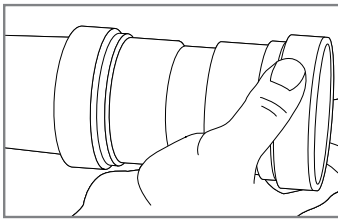

**7** Turn slightly while sliding press fitting onto pipe. Slide all the way to insertion mark & make contact with stop.

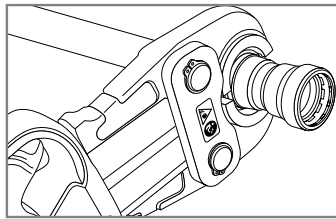

**8a** For 1/2" to 1" fittings, place press jaw at a right angle over press fitting bead. Start the pressing process. See specific tool manufacturer for tool instruction.

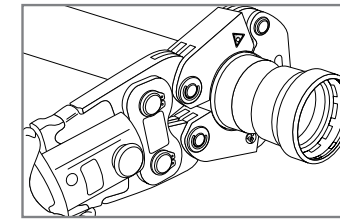

**8b** For 1-1/4" to 2" fittings, place press-ring at a right angle over fitting bead and check for proper engagement. Start the pressing process. See specific tool manufacturer for tool instruction.

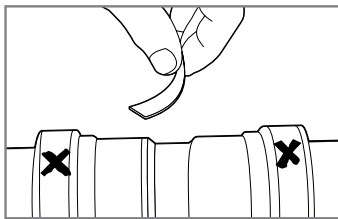

**9** Remove sticker once crimping process is complete to verify the connection has been made. Pressed joint may also be marked with an "X" for additional confirmation.

**Insertion Depth Chart (1/2" – 2")**

Pipe Size	1/2"	3/4"	1"	1-1/4"	1-1/2"	2"
Insertion Depth	1-1/8"	1-1/4"	1-3/8"	1-7/8"	2"	2"

**WARNING:** Failure to follow all instructions could affect joint/system integrity and may lead to property damage. Call Customer Service at **1-800-FITTING** if you have any questions or need assistance.

**WARNING:** The installation, inspection, testing, and purging of the fuel gas system shall be in accordance with local codes, or, in the absence of local codes, in accordance with the National Fuel Gas Code, Z223.1/NFPA 54, or the Uniform Plumbing Code, as applicable.

**CAUTION: (a)** The fittings are for use with fuel gases and are intended for the operating pressure 0-125psi. **(b)** The fuel gas system shall not be used as a grounding electrode for an electrical system.

**LEAK DETECTION:** These fittings are inherently "leak detecting." Before pressing, fittings are loose on pipe, allowing for gas/air flow to help identify un-pressed connections.

**RECOMMENDED PRESSURE TESTING:** The installation, inspection, testing and purging of the fuel gas system shall be in accordance with local codes or, in the absence of local codes, in accordance with the international fuel gas code, NFPA 54/ National fuel gas code z223.1, the Uniform Plumbing Code, NFPA 58 or CSA B 149.1 as applicable.

**CS**  
CARBON  
STEEL

**PR**  
PRESS

**G**  
GAS



# MECHANICAL (STL)



## MECHANICAL (STL)

Streamline<sup>®</sup> STL Carbon Steel Press Fittings are designed for use in mechanical & fire sprinkler piping systems utilizing Schedule 10 & Schedule 40 carbon steel pipe.

### Carbon Steel Fitting Body With:

- Corrosion-resistant zinc-nickel coating
- EPDM engineered sealing element
- 420 stainless steel grip ring
- 304 stainless steel separator ring

### Certifications:

- UL 213 Listed
- ASTM F3226

### Complies With:

- ASME B31: Code for Pressure Piping
- (UMC) Uniform Mechanical Code
- (UPC) Uniform Plumbing Code
- (IMC) International Mechanical Code
- (IPC) International Plumbing Code
- IAPMO PS-117
- NFPA 13, 13D and 13R

### Operating Parameters:

- Operating Pressure: 200 PSI CWP Max
- Test Pressure: 600 PSI CWP Max
- Temperature Range: -40°F to 250°F

### Approved Systems:

- Chilled water (Max 200 PSI)
- Hydronic Heating (Max 200 PSI)
- Fire Sprinkler (Max 200 PSI)
- Low Pressure Steam (up to 5 psi)
- Dry Compressed Air
- Technical Gases



15-Year Limited Warranty for approved mechanical applications\*

\*Approved applications includes non-industrial & non-marine applications.

**CS**  
CARBON  
STEEL

**PR**  
PRESS

**M**  
MECHANICAL



# DIMENSIONAL DATA



## 45° ELBOW P X P

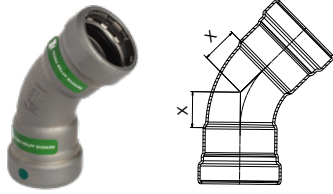

Item No.	Diameter	Catalog Wt.	Inner	Master	Dimensions (in.)	
					X	Z
CP03026	1/2"	0.238	10	100	0.48	
CP03034	3/4"	0.221	10	70	0.56	
CP03044	1"	0.551	5	40	0.80	
CP03050	1-1/4"	0.913	1	25	0.94	
CP03055	1-1/2"	1.045	1	15	1.05	
CP03059	2"	1.270	1	5	1.20	

## 45° ELBOW • STREET FTG X P

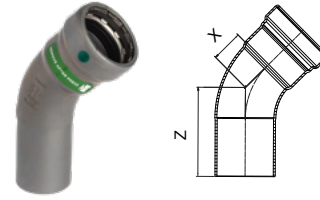

Item No.	Diameter	Catalog Wt.	Inner	Master	Dimensions (in.)	
					X	Z
CP03326	1/2"	0.221	10	120	0.48	1.91
CP03334	3/4"	0.205	10	30	0.56	2.07
CP03344	1"	0.523	5	40	0.80	2.47
CP03350	1 1/4"	0.871	1	20	0.97	3.11
CP03355	1 1/2"	1.001	1	15	1.05	3.30
CP03359	2"	1.232	1	5	1.20	3.51

## 90° ELBOW • LONG RADIUS P X P

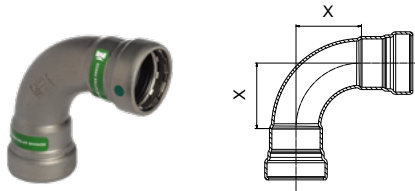

Item No.	Diameter	Catalog Wt.	Inner	Master	Dimensions (in.)	
					X	Z
CP02722	1/2"	0.289	10	40	1.17	
CP02734	3/4"	0.408	10	50	1.37	
CP02747	1"	0.692	5	15	1.96	
CP02055	1 1/4"	1.076	1	6	2.28	
CP02063	1 1/2"	1.268	1	4	2.55	
CP02072	2"	1.605	1	7	2.93	

## 90° ELBOW • LONG RADIUS • STREET FTG X P

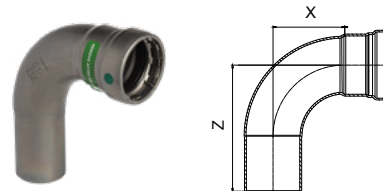

Item No.	Diameter	Catalog Wt.	Inner	Master	Dimensions (in.)	
					X	Z
CP02822	1/2"	0.269	10	50	1.17	2.60
CP02834	3/4"	0.390	10	30	1.37	2.87
CP02847	1"	0.677	5	30	1.96	3.62
CP02350	1 1/4"	1.014	1	10	2.28	4.45
CP02355	1 1/2"	1.283	1	10	2.55	4.80
CP02359	2"	1.568	1	7	2.93	5.24

## ADAPTER • FEMALE P X FPT

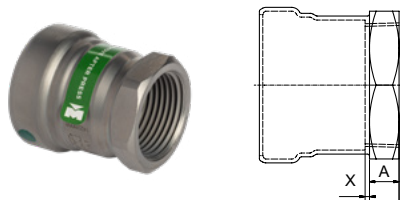

Item No.	Diameter	Catalog Wt.	Inner	Master	Dimensions (in.)	
					A	X
CP01231	1/2"	0.132	10	80	0.52	0.00
CP01246	3/4"	0.216	10	60	0.52	0.00
CP01263	1"	0.293	5	20	0.66	0.01
CP01271	1 1/4"	0.527	5	35	0.68	0.07
CP01279	1 1/2"	0.650	1	20	0.68	0.04
CP01287	2"	0.800	1	15	0.63	0.00

## ADAPTER • MALE P X MPT

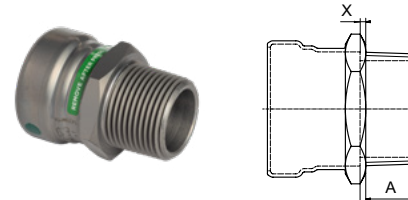

Item No.	Diameter	Catalog Wt.	Inner	Master	Dimensions (in.)	
					A	X
CP01131	1/2"	0.181	10	70	0.75	0.17
CP01146	3/4"	0.262	10	60	0.83	0.15
CP01163	1"	0.381	5	30	0.98	0.10
CP01171	1 1/4"	0.553	5	20	1.02	0.12
CP01179	1 1/2"	0.778	1	20	1.02	0.21
CP01187	2"	0.871	1	15	1.06	0.12

### ADAPTER • FEMALE • REDUCING P X FPT

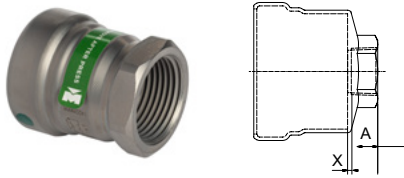

Item No.	Diameter	Catalog Wt.	Inner	Master	Dimensions (in.)	
					A	X
CP01247	3/4" x 1/2"	0.201	10	80	0.50	0.00
CP01265	1" x 1/2"	0.282	10	50	0.54	0.02
CP01264	1" x 3/4"	0.309	5	40	0.55	0.00
CP01268	1 1/4" x 1/2"	0.474	1	30	0.54	0.02
CP01269	1 1/4" x 3/4"	0.492	1	30	0.56	0.04
CP01272	1 1/4" x 1"	0.476	1	15	0.66	0.01
CP01276	1 1/2" x 1/2"	0.571	1	13	0.54	0.11

### ADAPTER • FEMALE • REDUCING (CONT'D) P X FPT

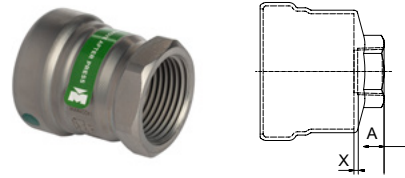

Item No.	Diameter	Catalog Wt.	Inner	Master	Dimensions (in.)	
					A	X
CP01277	1 1/2" x 3/4"	0.582	1	25	0.56	0.09
CP11279	1 1/2" x 1"	0.620	1	25	0.66	0.06
CP01280	1 1/2" x 1 1/4"	0.626	1	25	0.68	0.04
CP01283	2" x 1/2"	0.750	1	20	0.54	0.09
CP01284	2" x 3/4"	0.758	1	20	0.56	0.07
CP01285	2" x 1"	0.721	1	20	0.63	0.00
CP01286	2" x 1 1/4"	0.752	1	20	0.68	0.03
CP01288	2" x 1 1/2"	0.701	1	20	0.68	0.03

### CAP P

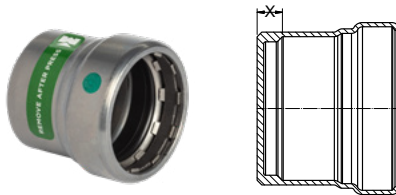

Item No.	Diameter	Catalog Wt.	Inner	Master	Dimensions (in.)
					X
CP07007	1/2"	0.124	10	120	0.23
CP07009	3/4"	0.185	10	80	0.28
CP07011	1"	0.284	5	80	0.32
CP07012	1 1/4"	0.434	1	30	0.33
CP07013	1 1/2"	0.545	1	25	0.33
CP07014	2"	0.697	1	20	0.40

### COUPLING • NO STOP P X P

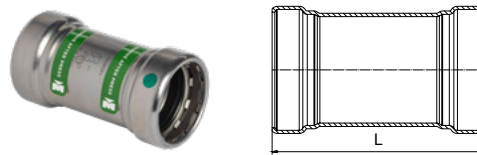

Item No.	Diameter	Catalog Wt.	Inner	Master	Dimensions (in.)
					L
CP01903	1/2"	0.218	10	100	2.79
CP01905	3/4"	0.298	10	70	3.01
CP01906	1"	0.439	5	40	3.37
CP01907	1 1/4"	0.725	1	20	4.34
CP01908	1 1/2"	0.858	1	17	4.60
CP01909	2"	1.014	1	12	4.86

### COUPLING • STAKED STOP P X P

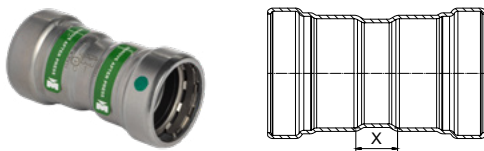

Item No.	Diameter	Catalog Wt.	Inner	Master	Dimensions (in.)
					X
CP10145	1/2"	0.221	10	50	0.52
CP10146	3/4"	0.300	10	70	0.54
CP10147	1"	0.454	5	40	0.59
CP10148	1 1/4"	0.745	1	20	0.62
CP10149	1 1/2"	0.871	1	15	0.67
CP10150	2"	1.058	1	12	0.84

### COUPLING • NO STOP • EXTENDED P X P

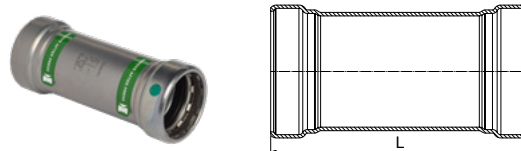

Item No.	Diameter	Catalog Wt.	Inner	Master	Dimensions (in.)
					L
CP01950	1/2"	0.280	10	40	3.84
CP01952	3/4"	0.381	10	30	4.04
CP01955	1"	0.564	5	15	4.43
CP01956	1 1/4"	0.873	1	20	5.35
CP01957	1 1/2"	0.983	1	8	5.47
CP01958	2"	1.157	1	6	5.67

**CS**  
CARBON  
STEEL

**PR**  
PRESS

**M**  
MECHANICAL

DIMENSIONAL DATA

COUPLING • REDUCING

P X P

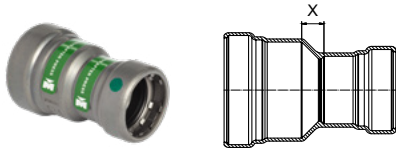

Item No.	Diameter	Catalog Wt.	Inner	Master	Dimensions (in.)	
					X	
CP01036	3/4" x 1/2"	0.249	5	40	0.31	
CP01051	1" x 1/2"	0.333	5	30	0.43	
CP01049	1" x 3/4"	0.355	5	30	0.30	
CP01058	1 1/4" x 3/4"	0.529	1	15	0.47	
CP01056	1 1/4" x 1"	0.573	1	12	0.34	
CP01064	1 1/2" x 1 1/4"	0.767	1	10	0.28	
CP01074	2" x 1 1/4"	0.893	1	8	0.52	
CP01073	2" x 1 1/2"	0.897	1	8	0.40	

FITTING REDUCER

FTG X P

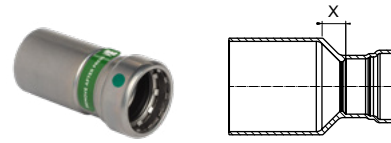

Item No.	Diameter	Catalog Wt.	Inner	Master	Dimensions (in.)	
					X	
CP01326	3/4" x 1/2"	0.209	5	100	0.12	
CP01339	1" x 1/2"	0.280	5	40	0.25	
CP01337	1" x 3/4"	0.295	5	80	0.11	
CP01343	1 1/4" x 1"	0.485	1	35	0.22	
CP01353	1 1/2" x 3/4"	0.509	1	30	0.44	
CP01351	1 1/2" x 1"	0.567	1	30	0.32	
CP01350	1 1/2" x 1 1/4"	0.644	1	20	0.10	
CP01360	2" x 1"	0.692	1	20	0.56	
CP01359	2" x 1 1/4"	0.798	1	20	0.39	
CP01358	2" x 1 1/2"	0.833	1	8	0.28	

TEE

P X P X P

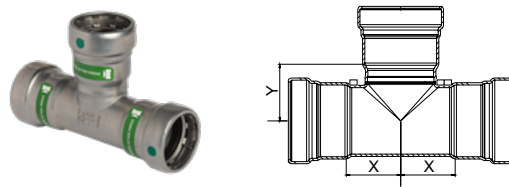

Item No.	Diameter	Catalog Wt.	Inner	Master	Dimensions (in.)	
					X	Y
CP04006	1/2"	0.397	5	50	0.93	0.87
CP04031	3/4"	0.578	5	30	1.06	0.98
CP04048	1"	0.849	5	20	1.22	1.18
CP04068	1 1/4"	1.411	1	8	1.40	1.39
CP04084	1 1/2"	1.642	1	8	1.53	1.54
CP40102	2"	2.002	1	5	1.80	1.87

TEE • REDUCING

P X P X P

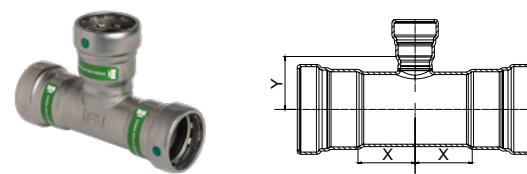

Item No.	Diameter	Catalog Wt.	Inner	Master	Dimensions (in.)	
					X	Y
CP04033	3/4" x 3/4" x 1/2"	0.527	5	30	1.06	0.99
CP04051	1" x 1" x 1/2"	0.741	5	25	1.22	1.13
CP04049	1" x 1" x 3/4"	0.803	5	20	1.22	1.12
CP04071	1 1/4" x 1 1/4" x 1/2"	1.140	1	14	1.40	1.30
CP04070	1 1/4" x 1 1/4" x 3/4"	1.186	1	12	1.40	1.30
CP04069	1 1/4" x 1 1/4" x 1"	1.259	1	10	1.40	1.36
CP04088	1 1/2" x 1 1/2" x 1/2"	1.314	1	10	1.53	1.44
CP04087	1 1/2" x 1 1/2" x 3/4"	1.371	1	10	1.53	1.43
CP04086	1 1/2" x 1 1/2" x 1"	1.433	1	8	1.53	1.50
CP04085	1 1/2" x 1 1/2" x 1 1/4"	1.583	1	8	1.53	1.53
CP40107	2" x 2" x 1/2"	1.609	1	7	1.80	1.68
CP40106	2" x 2" x 3/4"	1.656	1	7	1.80	1.67
CP40105	2" x 2" x 1"	1.711	1	7	1.80	1.73
CP40104	2" x 2" x 1 1/4"	1.197	1	6	1.80	1.77
CP40103	2" x 2" x 1 1/2"	1.922	1	6	1.80	1.79

CS  
CARBON  
STEEL

PR  
PRESS

M  
MECHANICAL



### TEE • FEMALE P X P X FPT

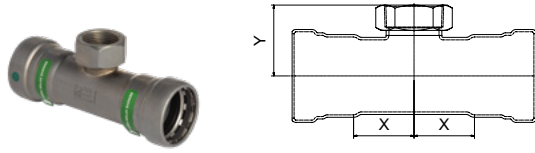

Item No.	Diameter	Catalog Wt.	Inner	Master	Dimensions (in.)	
					X	Y
CP01539	3/4" x 3/4" x 1/2"	0.474	5	35	1.06	1.38
CP01538	3/4" x 3/4" x 3/4"	0.545	5	35	1.06	1.40
CP01570	1" x 1" x 1/2"	0.692	5	30	1.22	1.54
CP01572	1" x 1" x 3/4"	0.758	5	30	1.22	1.54
CP01613	1 1/4" x 1 1/4" x 1/2"	1.091	1	15	1.40	1.71
CP02654	1 1/4" x 1 1/4" x 3/4"	1.133	1	12	1.40	1.71
CP02655	1 1/4" x 1 1/4" x 1"	1.204	1	12	1.40	1.87
CP01645	1 1/2" x 1 1/2" x 1/2"	1.272	1	10	1.53	1.83

### TEE • FEMALE (CONT'D) P X P X FPT

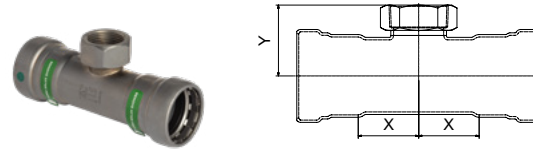

Item No.	Diameter	Catalog Wt.	Inner	Master	Dimensions (in.)	
					X	Y
CP02673	1 1/2" x 1 1/2" x 3/4"	1.336	1	10	1.53	1.83
CP02688	1 1/2" x 1 1/2" x 1"	1.378	1	10	1.53	1.99
CP02691	1 1/2" x 1 1/2" x 1 1/4"	1.429	1	8	1.53	1.99
CP01699	2" x 2" x 1/2"	1.545	1	8	1.80	2.01
CP02706	2" x 2" x 3/4"	1.609	1	8	1.80	2.01
CP02703	2" x 2" x 1"	1.665	1	7	1.80	2.20
CP02704	2" x 2" x 1 1/4"	1.706	1	7	1.80	2.26
CP02705	2" x 2" x 1 1/2"	1.728	1	7	1.80	2.20

### UNION P X P

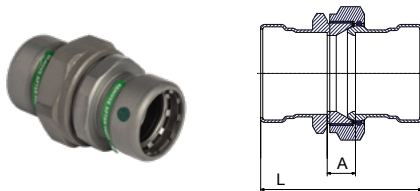

Item No.	Diameter	Catalog Wt.	Inner	Master	Dimensions (in.)	
					A	L
CP08003	1/2" x 1/2"	0.467	5	30	0.88	3.07
CP08004	3/4" x 3/4"	0.785	5	20	0.89	3.27
CP08005	1"	1.204	5	25	0.94	3.62
CP11205	1 1/4"	2.119	1	7	1.06	4.69
CP11206	1 1/2"	2.460	1	5	1.13	4.96
CP11207	2"	2.985	1	3	0.91	4.84

### UNION • FEMALE P X FPT

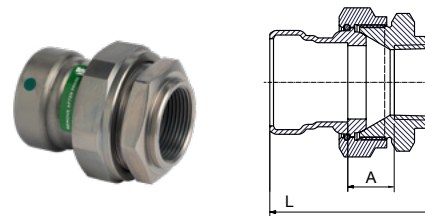

Item No.	Diameter	Catalog Wt.	Inner	Master	Dimensions (in.)	
					A	L
CP11422	1/2"	0.454	5	30	0.81	2.44
CP11423	3/4"	0.719	5	20	0.78	2.52
CP11424	1"	1.157	5	15	0.80	2.80
CP11425	1 1/4"	1.775	1	7	0.82	3.31
CP11426	1 1/2"	2.350	1	5	0.95	3.54
CP11427	2"	2.780	1	3	0.92	3.58

### UNION • MALE P X MPT

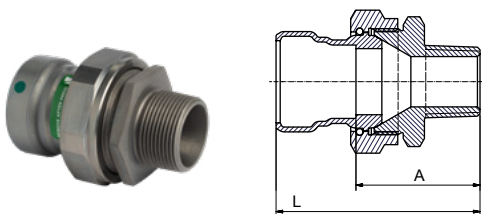

Item No.	Diameter	Catalog Wt.	Inner	Master	Dimensions (in.)	
					A	L
CP11210	1/2"	0.470	5	30	1.70	2.87
CP11211	3/4"	0.719	5	20	1.80	3.07
CP11212	1"	1.168	5	25	2.01	3.46
CP11213	1 1/4"	1.821	1	8	2.13	4.06
CP11214	1 1/2"	2.359	1	5	2.24	4.25
CP11215	2"	2.780	1	3	2.28	4.37

### FLANGE P X FLANGE

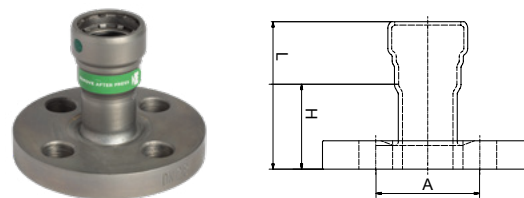

Item No.	Diameter	Catalog Wt.	Inner	Master	Dimensions (in.)		
					A	H	L
CP02881	1/2"	1.191	1	4	2.37	1.37	2.44
CP04114	3/4"	1.799	1	4	2.75	1.67	2.85
CP02933	1"	2.407	1	4	3.13	1.82	3.14
CP03806	1 1/4"	2.897	1	2	3.50	2.12	3.91
CP03907	1 1/2"	3.695	1	2	3.87	2.25	4.15
CP02980	2"	5.487	1	1	4.75	2.61	4.53

**CS**  
CARBON  
STEEL

**PR**  
PRESS

**M**  
MECHANICAL



# MECHANICAL APPLICATIONS

Streamline® STL Carbon Steel Press Fittings are designed for use in piping systems utilizing ASTM A53, A106, A135, and A795 Schedule 10 & Schedule 40 carbon steel pipe for use in mechanical and fire sprinkler applications. Listed below are common applications approved for Streamline® STL.

## APPROVED APPLICATIONS FOR 1/2” TO 2” STREAMLINE® STL:

Types of Service	Comments	Pressure	Temperature	Compatible with EPDM Seal
<b>FUEL, OIL AND LUBRICANT</b>				
Chilled Water	≤50% Ethylene Glycol / Propylene Glycol	200 PSI	-20°F to 250°F	✓
Hydronic Heating	≤50% Ethylene Glycol / Propylene Glycol	200 PSI	-20°F to 250°F	✓
Isopropyl Alcohol	—	200 PSI	Ambient	✓
Fire Sprinkler	Compliant with UL for NFPA 13, 13D and 13R	175 PSI	Ambient	✓
Low-Pressure Steam	Residential	5 PSI	Up to 227°F	✓
<b>NON-MEDICAL GASES</b>				
Compressed Air	Less than 25mg/m3 oil content	200 PSI	Up to 140°F	✓
Oxygen - O <sub>2</sub> (non medical)	Non-Medical keep free of oil and grease / non-liquid O <sub>2</sub>	140 PSI	Up to 140°F	✓
Nitrogen - N <sub>2</sub>	—	200 PSI	Up to 140°F	✓
Argon	—	200 PSI	Up to 140°F	✓
Hydrogen - H <sub>2</sub>	—	125 PSI	Up to 140°F	✓
Vacuum	—	Max 29.2 inches of Mercury	Up to 140°F	✓
Carbon Dioxide - CO <sub>2</sub>	Dry	200 PSI	Up to 140°F	✓
Acetylene	Test pressure 350 PSI	20 PSI	Ambient	✓

**CS**  
CARBON  
STEEL

**PR**  
PRESS

**M**  
MECHANICAL

# INSTALLATION INSTRUCTIONS – 1/2" – 2"

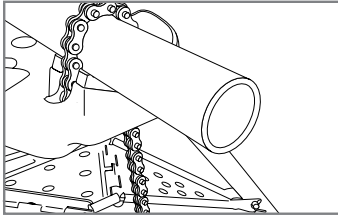

**1** Keep vise a minimum of 4" from cutting area to avoid damage to pipe.

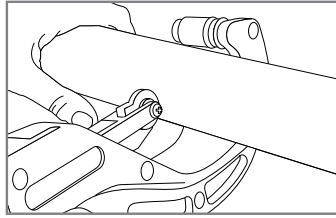

**2** Cut pipe square using a displacement-type cutter or fine-toothed saw.

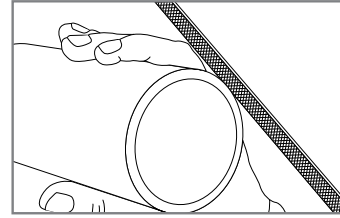

**3** Deburr pipe ID and OD using half round file or deburr tool.

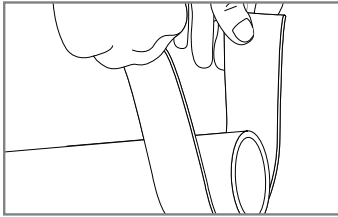

**4** Sand pipe OD to proper insertion depth. Pipe surface must be smooth and free of rust, indentation, deformation, and pipe coating.

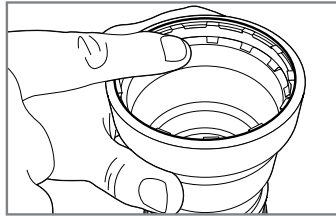

**5** Check fitting ends to ensure seal, grip ring, and spacer are present. **Do not use any type of oil lubrication.**

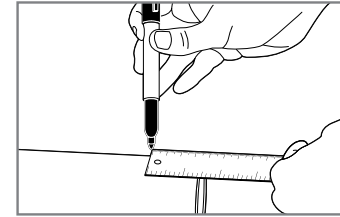

**6** Mark pipe to proper fitting insertion depth (see insertion depth chart).

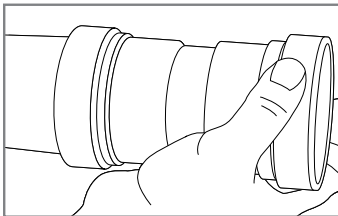

**7** Turn slightly while sliding press fitting onto pipe. Slide all the way to insertion mark & make contact with stop.

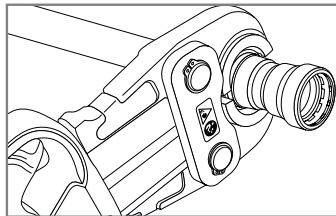

**8a** For 1/2" to 1" fittings, place press jaw at a right angle over press fitting bead. Start the pressing process. See specific tool manufacturer for tool instruction.

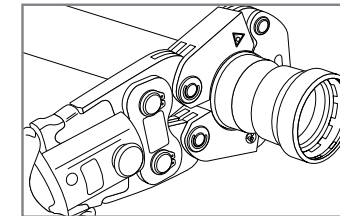

**8b** For 1-1/4" to 2" fittings, place press-ring at a right angle over fitting bead and check for proper engagement. Start the pressing process. See specific tool manufacturer for tool instruction.

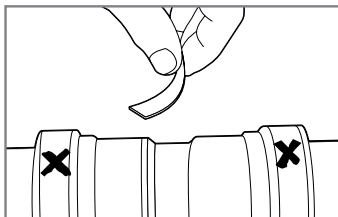

**9** Remove sticker once crimping process is complete to verify the connection has been made. Pressed joint may also be marked with an "X" for additional confirmation.

**Insertion Depth Chart (1/2" – 2")**

Pipe Size	1/2"	3/4"	1"	1-1/4"	1-1/2"	2"
Insertion Depth	1-1/8"	1-1/4"	1-3/8"	1-7/8"	2"	2"

**WARNING:** Failure to follow all instructions could affect joint/system integrity and may lead to property damage. Call Customer Service at **1-800-FITTING** if you have any questions or need assistance.

**WARNING:** The installation, inspection, testing, and purging of mechanical systems shall be in accordance with local codes, or, in the absence of local codes, in accordance with the Uniform Plumbing Code or Mechanical Code, as applicable.

**CAUTION:** (a) The fittings are for use with approved mechanical applications and are intended for the operating pressure 0-200psi. Fittings are not approved for fuel gas applications. (b) The mechanical system shall comply with the Electrical Bonding and Grounding Section of the Uniform Plumbing Code. The metal to metal contact between fitting and pipe ensures continuity of the bonding through this contact.

**LEAK DETECTION:** These fittings are inherently "leak detecting." Before pressing, fittings are loose on pipe, allowing for water/air flow to help identify un-pressed connections.

**RECOMMENDED PRESSURE TESTING:** Low-pressure air or water testing can be useful to assist in identifying any un-pressed connections. Leak testing with air can be dangerous at high pressures. When leak testing with compressed air the proper pressure range is 5 PSI to 15 PSI maximum. When leak testing with water the proper pressure range is 15 PSI to 50 PSI maximum. Following a successful leak test, the system may be pressure tested with air - recommended at 100 PSI up to a maximum 200 PSI - or with water - recommended at 200 PSI up to a maximum of 600 PSI - as required by local code requirements or project specifications.

**CS**  
CARBON  
STEEL

**PR**  
PRESS

**M**  
MECHANICAL



# TESTING INSTRUCTIONS FOR MECHANICAL FITTINGS WITH LEAK DETECTION

## PRESSURE TESTING

When installing Streamline<sup>®</sup> STL press fittings, it is recommended to perform a leak test in order to locate any un-pressed fittings. To assist in making that testing more reliable, Streamline<sup>®</sup> STL press fittings come with an inherent leak detection feature. The following procedures assist installers in detecting un-pressed fittings in a system under pressure prior to concealment.

## LEAK TESTING WITH AIR

1. When the system, or portion of the system, is installed and isolated, slowly pressurize to 15 PSI maximum using dry clean air, carbon dioxide or nitrogen charge.
2. The system should stabilize over the next several hours and the pressure should be monitored with a pressure gauge.
3. If the pressure has dropped, add more pressure to bring the system back up to the 15 PSI desired initial test level. Bleed off excess pressure.
4. Allow time for complete system stabilization. If upon inspection the system pressure has dropped below 15 PSI test level, there is likely an un-pressed fitting leaking.
5. Leaks may be easily identified either by use of commercial leak test solution or soap and water mixture, which will form bubbles identifying an un-pressed leak point.
6. Once any un-pressed connection has been tested and repaired, repeat the testing process until 15 PSI pressure is maintained for 24 hours or for the duration of time and pressure specified by local authority codes.

## LEAK TESTING WITH WATER

1. When the system, or portion of the system, is installed and isolated, slowly pressurize to 50 PSI maximum using clean water.
2. The system should stabilize over the next several hours and the pressure should be monitored with a pressure gauge.
3. If the pressure has dropped, add more pressure to bring the system back up to the 50 PSI desired initial test level. Bleed off excess pressure.
4. Allow time for complete system stabilization. If upon inspection the system pressure has dropped below 50 PSI test level, there is likely an un-pressed fitting leaking.
5. Leaks may be easily identified by leaking water.
6. Once any un-pressed connection has been tested and repaired, repeat the testing process until 50 PSI pressure is maintained for 24 hours or for the duration of time and pressure specified by local authority codes.

Once either testing procedure has been completed and verified, water/air pressure can be increased to the working pressure design of the system, not to exceed the maximum rated pressure.

The leak detection feature may assist with, but does not guarantee the detection of un-pressed connections.

# INSTALLATION GUIDELINES

## PIPE SELECTION



**Streamline® STL-G Carbon Steel Press Fittings** are designed for use in piping systems utilizing ASTM A53, Schedule 10 & Schedule 40 carbon steel pipe for use in fuel gas systems, fuel oil systems and applications with a high oil content.



**Streamline® STL Carbon Steel Press Fittings** are designed for use in piping systems utilizing ASTM A53, A106, A135, and A795 Schedule 10 & Schedule 40 carbon steel pipe for use in mechanical and fire sprinkler applications.

Carbon steel pipe, also called black iron pipe, may contain surface imperfections, which are specifically defined and allowed by the standard. This product is handled and stored multiple times before reaching the actual point of installation, potentially leading to further scratches, nicks or dents. This pipe was designed for welding with filler material which addresses any gaps in the pipe surface.

Those who specify and/or install press systems must be aware of the inherent trade-offs that accompany the decision to utilize press technology and elastomeric seals. Installers should recognize surface scratches and deep marks on the pipe and avoid placing seals directly over these surface irregularities in order to reduce the risk of leaks. Sanding and cleaning the surface may or may not eliminate this concern.

## STORAGE AND HANDLING

Streamline® Carbon Steel Press Fittings are packaged in polybags to keep them clean and free from debris. Fittings should be handled with care and opened just prior to use, to ensure their cleanliness. It is highly recommended that a thorough visual inspection of the fittings be performed to ensure all components are present.

The piping and fittings should be carefully handled during shipment and unloaded with reasonable care. Protect the stored product from moisture and dirt.

In the event press fittings are dropped, visually inspect them to assure that fittings have not been damaged or deformed. The corrosion-resistant zinc-nickel coating protects the exterior of the fittings during transit, installation, and service life.

## TOOLS & JAWS

Installer shall be qualified, licensed within the jurisdiction, and familiar with the installation of carbon steel press systems.



Streamline® Carbon Steel Press Fittings shall be installed using the proper tools, jaws, actuator, and rings as instructed by the respective press fitting and press tool manufacturer.





### UNDERGROUND BURIAL

Streamline® Carbon Steel Press Fittings are approved for underground installation in accordance with the latest applicable building codes for the state and local jurisdiction. In addition, underground joints should be wrapped in 3M™ Scotchrap™ Tape 50, Shurtape® PW 100 or a comparable impermeable coating system designed to protect joints from moisture, debris, corrosion and other soil stresses.

### PAINTING

-  Streamline® STL-G fittings have a factory-applied corrosion-resistant coating but may be painted if desired for color identification.
-  Streamline® STL fittings have a factory-applied corrosion-resistant coating but may be painted if desired for color identification. Proper care must be taken to avoid any oil-based paints from pooling inside the fitting ends in contact with the EPDM seal.

### SEAL LUBRICATION

- Streamline® Carbon Steel Press Fittings have a loose or slip fit. Should insertion be difficult, please check alignment and ensure proper pipe preparation was completed to eliminate burrs or sharp edges.
-  If additional seal lubrication is required for STL-G fittings, silicon or nonpetroleum based lubricants are recommended.
  -  If additional seal lubrication is required for STL fittings, silicon or nonpetroleum based lubricants must be used. **Do not use any type of oil lubrication.**



### MINIMUM DISTANCES WHEN WORKING WITH STREAMLINE® STL & STL-G

#### WELDING NEAR AN EXISTING PRESS CONNECTION

All welds in the system are to be completed before any press connections are made.

#### THREADED FITTINGS NEAR PRESS CONNECTIONS

Threaded connections need to be tightened prior to pressing in-line fittings.

#### DISTANCE BETWEEN JOINTS

Mechanical joint pressing causes some degree of deformity to the piping. To prevent leaks, minimal distances between press joints are set forth in the table below.

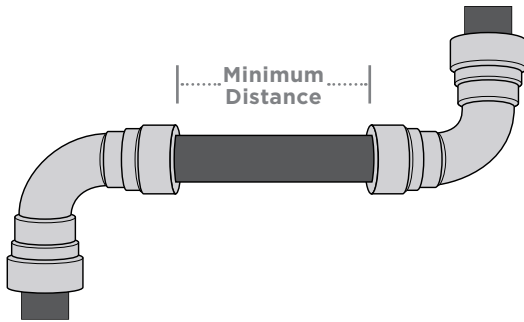

MINIMUM DISTANCE BETWEEN PRESS CONNECTIONS		
PIPE DIAMETER	MINIMUM DISTANCE REQUIRED	
NOMINAL INCH	INCH	MM
1/2"	1/4"	6
3/4"	1/4"	6
1"	1/4"	6
1-1/4"	1/2"	13
1-1/2"	1/2"	13
2"	1/2"	13

#### PRESSURE LOSS VALUES

PRESSURE LOSS EXPRESSED AS EQUIVALENT LENGTH (IN FEET OF PIPE)		
TYPE	NOMINAL DIAMETER	EQUIVALENT LENGTH (FT)
Coupling	1"	1
Coupling	1-1/4"	.4
Coupling	1-1/2"	.5
Coupling	2"	.3
Tee (Branch)	1"	4.9
Tee (Branch)	1-1/4"	5.1
Tee (Branch)	1-1/2"	5.6
Tee (Branch)	2"	8.2



# INSTALLATION INSTRUCTIONS



## PRESSING SPACE LIMITATIONS

Press tool and jaw sets can be difficult to get into some tighter spaces. In these instances it is recommended that, when possible, to preassemble product away from these space restricted areas. These assemblies can then be installed to minimize the potential for improper alignment of the pressing tools and jaws. For most press joints, use of the press tools and jaws will not pose spatial issues. The following guidelines are recommended for standard installations.

### 1/2" - 1" PRESSING WITH STANDARD JAWS - CLEARANCE REQUIREMENTS

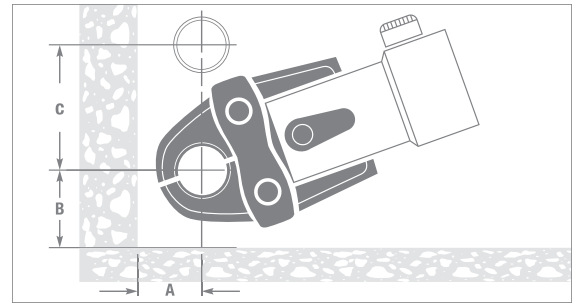
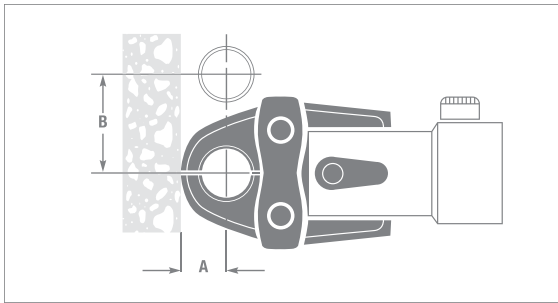

PIPE DIAMETER (INCHES)	A MINIMUM (INCHES)	B MINIMUM (INCHES)
1/2"	1"	2-5/8"
3/4"	1-1/4"	3-1/8"
1"	1-3/4"	3-5/8"

PIPE DIAMETER (INCHES)	A MIN. (INCHES)	B MIN. (INCHES)	C MIN. (INCHES)
1/2"	1-1/4"	1-7/8"	3"
3/4"	1-1/2"	2-1/8"	3-1/2"
1"	2"	2-1/2"	4"

### 1/2" - 3/4" PRESSING WITH COMPACT JAWS - CLEARANCE REQUIREMENTS

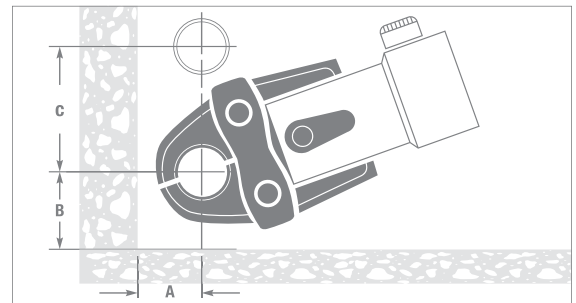
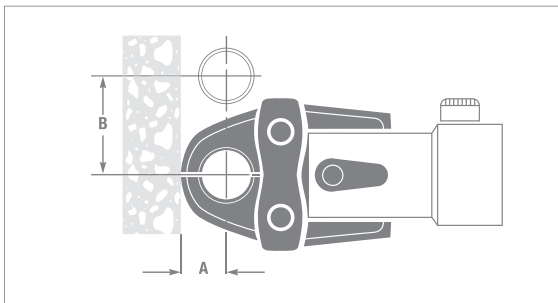

PIPE DIAMETER (INCHES)	A MINIMUM (INCHES)	B MINIMUM (INCHES)
1/2"	1-1/4"	2-7/8"
3/4"	1-1/8"	3"

PIPE DIAMETER (INCHES)	A MIN. (INCHES)	B MIN. (INCHES)	C MIN. (INCHES)
1/2"	1-1/2"	2-1/8"	3-1/8"
3/4"	1-3/8"	2-1/8"	3-3/8"

### 1-1/4" - 2" PRESSING WITH RING AND ACTUATOR IN TIGHT SPACES



**1** Wrap the press ring around the press fitting with the opening facing away from you.

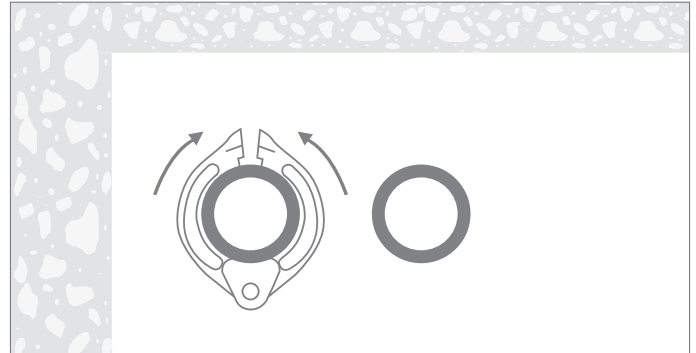

**2** Close the press ring tight around the fitting.



**3** Rotate the press ring until the actuator jaw receptacle is facing toward you.

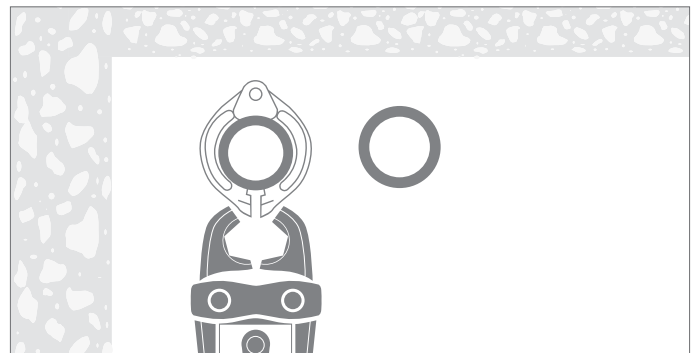

**4** Properly insert the actuator jaw and begin the pressing procedure.

### MINIMUM SPACE REQUIREMENTS FOR WORKING WITH RING AND ACTUATOR

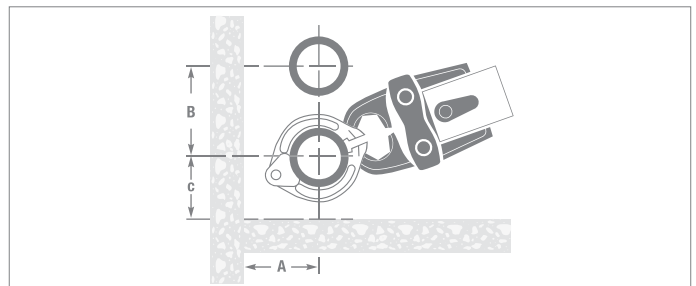
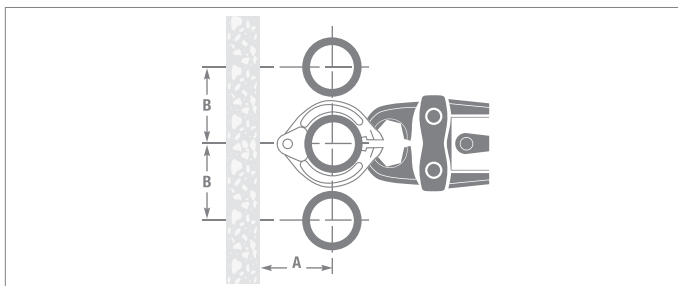

PIPE DIAMETER (INCHES)	A MINIMUM (INCHES)	B MINIMUM (INCHES)
1-1/4"	3-3/4"	4-7/8"
1-1/2"	4"	5-1/8"
2"	4"	5-3/8"

PIPE DIAMETER (INCHES)	A MINIMUM (INCHES)	B MINIMUM (INCHES)	C MINIMUM (INCHES)
1-1/4"	3-3/4"	3-3/4"	4-7/8"
1-1/2"	4"	4"	5-1/8"
2"	4"	4"	5-3/8"





FAQS



1. What are the operating pressures and temperatures for the Streamline® Carbon Steel Press system?

● **STL-G:** 125 PSI for fuel gas applications at -40°F to 180°F  
200 PSI for other approved applications at -40°F to 180°F

● **STL:** 200 PSI at a temperature range of -40°F to 250°F

2. For what types of applications is the Streamline® Carbon Steel Press system approved?

● **STL-G:** Gas and Fuel oil applications

● **STL:** Non-potable water and Mechanical applications

3. For what types of media is the Streamline® Carbon Steel Press system designed?

● **STL-G** is designed for oils, gas, fuel and non-medical gases.

● **STL** is designed for non-potable water, and dry non-medical gases.

4. What products are included in the Streamline® Carbon Steel Press offering?

Fitting sizes 1/2"- 2" including couplings, elbows, tees, caps, adapters, fitting reducers, unions and flanges.

5. What piping can be used with Streamline® Carbon Steel Press Fittings?

● **STL-G** is designed for use in piping systems utilizing ASTM A53, Schedule 10 & Schedule 40 carbon steel pipe.

● **STL** is designed for use in piping systems utilizing ASTM A53, A106, A135, and A795 Schedule 10 & Schedule 40 carbon steel pipe.

6. What is the warranty for Streamline® Carbon Steel Press Fittings?

15-year limited warranty for non-industrial and non-marine applications.

7. How long will the seal last in Streamline® Carbon Steel Press Fittings?

The EPDM and HNBR seals carry the same warranty as the fitting in which it is installed - 15 years. However, the seals are expected to have a useful life of over 50 years.

8. What performance tests were performed on Streamline® Carbon Steel Press Fittings?

● **STL-G** fittings were certified to ANSI/CSA LC4a/CSA 6.32a, which require the following tests: leakage, pressure, axial strength, torsion, bending, impact, resistance to loosening, resistance to extreme temperature cycles, resistance to freezing and thawing, and exposure to elevated temperatures.

● **STL** fittings were certified to UL213 and ASTM F3226, which require the following tests: leakage, hydrostatic, bending moment, low temperature, sprinkler outlet flow, fire test, pull-out test, vacuum test, vibration, and impulse pressure.

9. What pressing tools can be used with Streamline® Carbon Steel Press system?

Most Black Iron Press tools and jaws on the market can be used, but always refer to the Tool and Jaw Compatibility Chart.

10. Can a Streamline® Carbon Steel Press fitting be re-crimped?

Yes - there is just no guarantee this will correct a problem joint.

11. Are Streamline® Carbon Steel Press Fittings approved for use underground?

Yes - Streamline® Carbon Steel Press Fittings are approved for underground burial in accordance with the latest applicable building codes for the state and local jurisdiction. In addition, underground joints should be wrapped in 3M™ Scotchrap™ Tape 50, Shurtape® PW 100 or a comparable impermeable coating system designed to protect joints from moisture, debris, corrosion and other soil stresses.

**12. Are Streamline® Carbon Steel Press Fittings lead-free?**

Yes - the steel and component materials used to construct Streamline® Carbon Steel Press Fittings are free of lead content.

**13. Are Streamline® Carbon Steel Press Fitting seals lubricated?**

Yes - Streamline® Carbon Steel Press Fitting seals have a light, silicone-based lubricant.

**14. Can Streamline® Carbon Steel Press Fittings be installed in a system subject to freezing?**

Yes - Reference the minimum operating temperature of the fittings.

**15. Can Streamline® Carbon Steel Press Fittings be installed in tight spaces?**

Yes, as long as there is sufficient clearance around each joint to allow for the pressing tool and jaw to crimp without interference.

**16. What does HNBR stand for?**

 HNBR stands for Hydrogenated Acrylonitrile Butadiene Rubber.

**17. What does EPDM stand for?**

 EPDM stands for Ethylene-Propylene Diene Monomer.

**18. How far away from a Streamline® Carbon Steel Press Fitting connection can another fitting be welded?**

All welds in the system are to be completed before any press connections are made.

**19. How close together can two Streamline® Carbon Steel Press Fitting connections be pressed?**

Refer to the distance between joints pressing near an existing press connection.

**20. What is the most common error made when installing a Streamline® Carbon Steel Press Fitting?**

Not adequately prepping the pipe before installation. Pipe edges need to be free of burrs or any sharp edges. Joint surfaces also need to be free of deep scratches, gouges, or other irregularities that could interfere with the seals.

**21. Can I cut the pipe with a sawzall or other aggressive cutting tool?**

Yes - However, these tools often result in rough, irregular, and crooked cuts. Installers will need to take more time cleaning up the pipe edges as a result.

**22. How would an inspector identify a pressed connection?**

The fittings come with RAPID™ Flags that offer installers and inspectors an easy and effective way of verifying completed joints or identifying unpressed joints. After pressing a joint, the installer removes the RAPID™ Flag from the fitting by grabbing the nonadhesive area and pulling it off. RAPID™ Flags are also easy to grasp while wearing gloves. In the installation instructions, it is also suggested to mark fitting cups with an X to easily verify pressed connections.

**23. How would an inspector know the correct Streamline® Carbon Steel Press Fitting was used for the correct connection?**

Yellow paint dots on the fitting indicate fittings are approved for Gas applications. Green paint dots on the fitting indicate fittings are approved for Mechanical and non-potable water applications.

**24. How would an inspector identify a joint with a good sealed connection?**

Fittings are inherently leak detecting. A pressed joint with a good seal will hold pressure during the recommended leak testing procedures.

**25. Do I have to lubricate the pipe or the fitting?**

No, Streamline® Carbon Steel Press Fittings do not require lubrication of the pipe or the fitting.

**26. Can I install Streamline® Carbon Steel Press Fittings on epoxy coated pipe?**

Yes, the surface of the pipe must be smooth before installing the fittings. If necessary, surface smoothing can be accomplished by using an abrasive sanding cloth.

**27. Can Streamline® Carbon Steel Press Fittings be installed in a potable water application?**

No, Streamline® Carbon Steel Press Fittings are not approved for any potable water usage.

**28. Can a Streamline® STL fitting with EPDM seal be used for gas/fuel oil applications?**

 No, EPDM and gas/fuel oil media are not compatible.

# *Streamline*<sup>®</sup> YOUR SYSTEM

Streamline<sup>®</sup> is the preferred and specified brand of industry professionals around the world. Why? They know that since 1930, Streamline<sup>®</sup> products have been designed for trouble-free performance and manufactured to the highest standards. From tubing and fittings to valves and more, Streamline<sup>®</sup> offers a suite of quality products to support a broad range of piping systems and applications. Streamline<sup>®</sup> Your System, and get the confidence that only comes when a solution is designed to work together.

- Plumbing Supply Systems
- Drain, Waste, & Vent Systems
- Air Conditioning Systems
- Refrigeration Systems
- High-Pressure CO2 Systems
- Medical Gas/Oxygen Systems
- Mechanical & Steam Systems
- LP/Natural Gas Systems
- Industrial/Process Systems
- Hydronic Heating Systems
- Well & Pump Systems
- Underground Service Lines



**MUELLER STREAMLINE CO.**

150 Schilling Blvd, Suite 201, Collierville, TN 38017 | 1-800-FITTING | [www.muellerstreamline.com](http://www.muellerstreamline.com)

© 2021 Mueller Streamline Co.