



PREFABRICATED SHEET METAL  
DUCTS & FITTINGS

## TABLE OF CONTENTS

## PRODUCT CATEGORY INDEX

Page	Description
2	Round Pipe, Elbows, Angles & Register Boots
3-4	Trunk Duct, Fittings & Installation Accessories
5	Return Air Products
6	Oval Pipe & Fittings
7	Wall Stack & Fittings
8	Sheet Metal and Ductboard Collars
9-10	Sheet Metal and Ductboard Takeoffs
11	Air-Tite Takeoffs
12	Tees, Wyes, Reducers, End Caps & Accessories
13	Insulated Ceiling Boxes and CRD Boots
14	Register Boxes and Ceiling Outlets
15	Furnace Fittings and Accessories
16	Venting Products and Mobile Home Kits
17	Black Pipe & Fittings
18	Spiral Pipe & Fittings
19-20	Product Number Index
21-22	Technical Information



Call us toll-free at:

Philadelphia • (800) 523-1052  
Greenville • (800) 229-2803  
Indianapolis • (800) 490-7707  
Mississippi • (800) 541-6706  
Nebraska • (800) 801-0336  
Idaho • (866) 289-9908  
[www.southwarkmetal.com](http://www.southwarkmetal.com)

### About Us

Southwark Metal Manufacturing Company is a third generation family owned company that has been manufacturing prefabricated sheet metal ducts and fittings for over 60 years.

With six manufacturing plants across the United States, we guarantee to exceed your highest expectations with our quality products and superior service.

For all products within this catalog, please check with your local customer service representative for fitting sizes, availability, pricing, and submittal information.

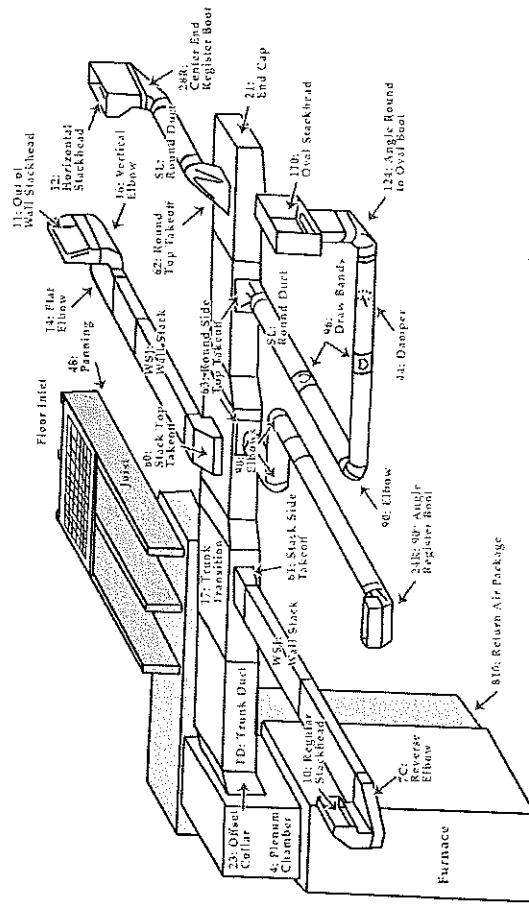

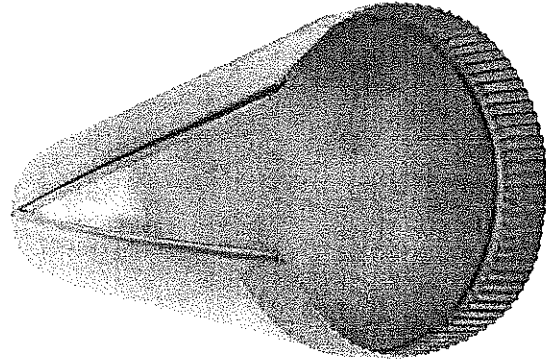

## SNAPLOCK PIPE

No tools required for assembly!

Simply start at one end and easily snap pipe together. One person can quickly assemble up to 10 ft. lengths.

The male end's self-starting crimp is knurled sufficiently so that the crimp "falls in" and yet, once assembled, completes a rigid, leak-proof connection that meets  $\pm 2"$  w.g. pressure.

- Available in 2ft, 3ft, 4ft, 5ft, and 10ft lengths
- Available in 30Ga, 28Ga, 26Ga, and 24Ga steel.

Open view

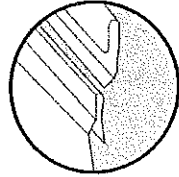

Closed view

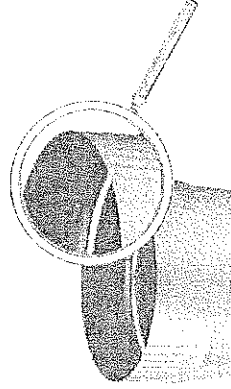
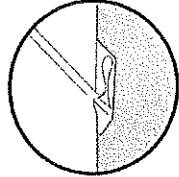

## ROUND PIPE, ELBOWS, ANGLES, REGISTER BOOTS

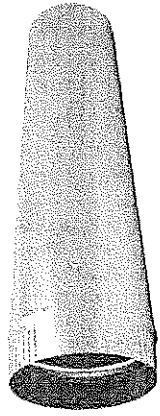

### MUI 20

Conductor Pipe

- Available in 30Ga, 28Ga, and 26Ga
- 10 ft in length
- 3" and 4" diameters only
- Acme type lock, shipped closed

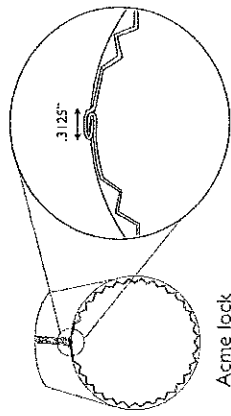

Acme lock

## REGISTER BOOTS

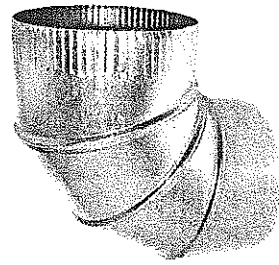

### 90° ADJUSTABLE ELBOW

Featuring:

- 4 pc. assembly for diameters 3" - 20"
- 5 pc. assembly for diameters 22" - 24"
- Crimp and bead male connection and straight female connection
- Meets  $\pm 2"$  w.g. pressure overall

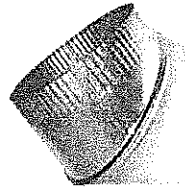

### 45° ADJUSTABLE ANGLE

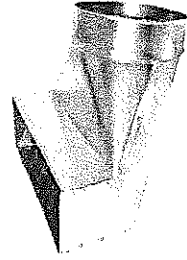

24R  
90° Register Boot

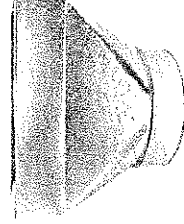

27R  
Straight Register Boot

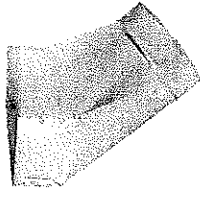

26R  
45° Register Boot

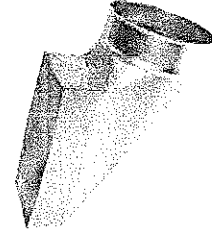

28R  
Center End  
Register Boot

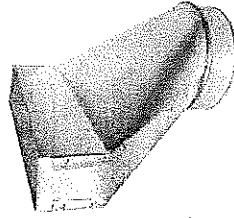

29RO  
2" Offset  
Register Boot

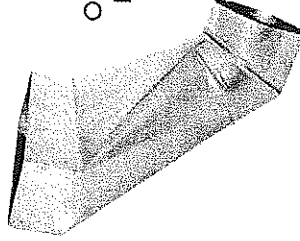

17CR  
Offset Adjustable  
Register Boot

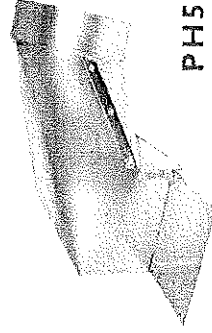

PH5  
90° Basement Boot

## TRUNK DUCT and FITTINGS

## TRUNK DUCT

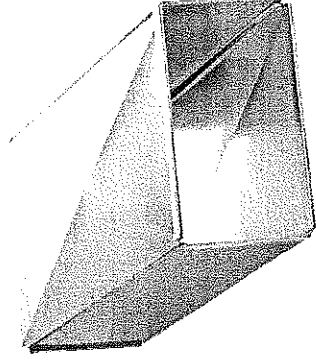

### Featuring:

- Available in 12", 30", 36", 48", 60", and 96" lengths
- Furnished in button snap-lock with s-cleat and drive connections
- Cross broken for extra stiffening strength
- E-lock duct also available
- Beaded duct also available

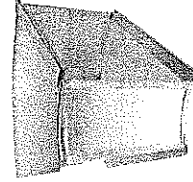

**13**  
45° Flat  
(Broadway) Angle  
Radius Throat

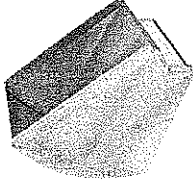

**13S**  
45° Flat  
(Broadway) Angle  
Square Throat

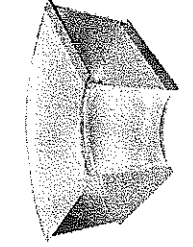

**14**  
90° Flat  
(Broadway) Elbow  
Radius Throat

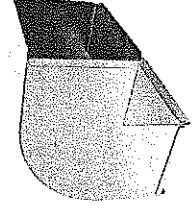

**14S**  
90° Flat  
(Broadway) Elbow  
Square Throat

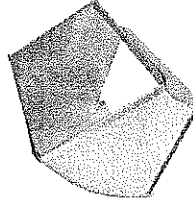

**15**  
45° Vertical  
(Shortway) Angle  
Radius Throat

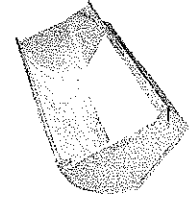

**15S**  
45° Vertical  
(Shortway) Angle  
Square Throat

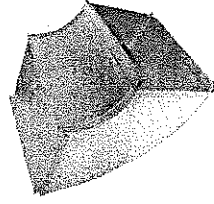

**16**  
90° Vertical  
(Shortway) Elbow  
Radius Throat

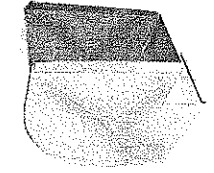

**16S**  
90° Vertical  
(Shortway) Elbow  
Square Throat

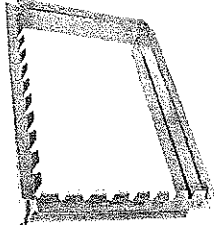

**20**  
Straight Collar

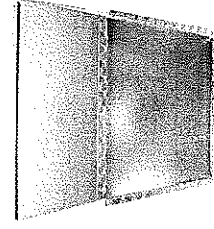

**23AT**  
Transition Collar

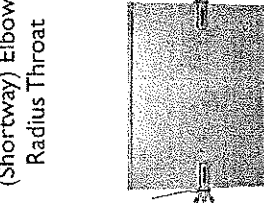

**42**  
Volume Damper



**21**  
End Cap



**23**  
Offset Collar

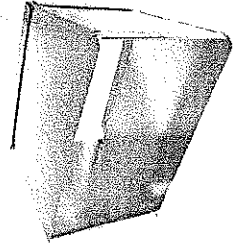

**17**  
Trunk Transition  
(tapered to one side)

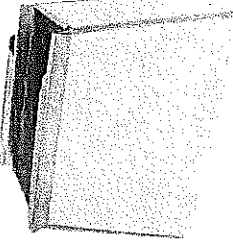

**17C**  
Trunk Reducer  
(tapered to center)

Duct Size	Plenum Opening
14 x 8	12 x 10
16 x 8	12 x 11
18 x 8	12 x 12
20 x 8	12 x 14
22 x 8	12 x 15
24 x 8	12 x 16
26 x 8	14 x 15
28 x 8	14 x 16
30 x 8	16 x 15
32 x 8	16 x 16

Duct Size	Plenum Opening
8 x 8	8 x 10
10 x 8	8 x 10
12 x 8	10 x 10
14 x 8	10 x 12
16 x 8	10 x 12
18 x 8	10 x 14
20 x 8	10 x 16
22 x 8	10 x 18
24 x 8	10 x 20
26 x 8	12 x 18
28 x 8	12 x 18
30 x 8	12 x 20
32 x 8	14 x 20

**TRUNK DUCT, FITTINGS, and  
INSTALLATION ACCESSORIES**

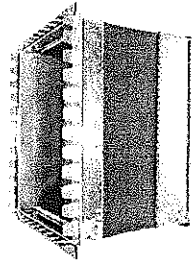

**18**  
Connector  
Plenum to Trunk

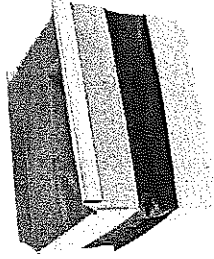

**47**  
Connector  
Furnace to Plenum

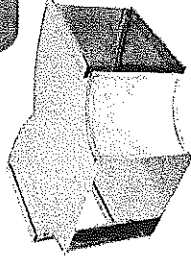

**14TT**  
Trunk Tee

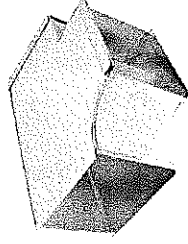

**17TT**  
Trunk Tee

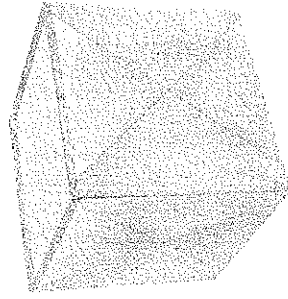

**4**  
Plenum Chamber  
• Custom Sizes  
• Shipped knocked down  
or made-up by request  
• "B" style available with flange

**ADJUSTABLE PLENUMS**

Please note: Actual plenum height is 2" less than listed size.

**TO INSTALL:**

- 1) Cut raw edges of side panels to desired width and height.
- 2) Trim top to desired width and depth.
- 3) Assemble 3 sides, slide top into side panel pockets, then position fourth side.
- 4) To complete, secure assembly with sheet metal screws.

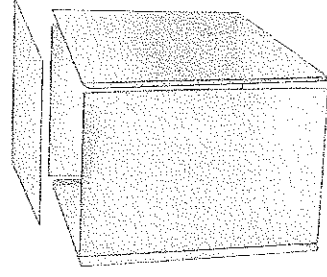

**49T**  
Adjustable Plenum Top  
**49P**  
Adjustable Plenum Side  
**49C**  
Complete Adjustable Plenum

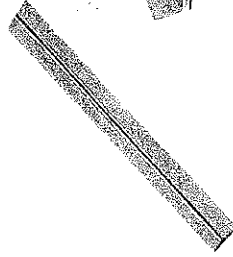

**8D**  
Drive Cleat  
8" and 10", available

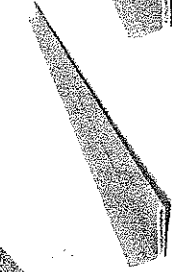

**37**  
1/2" Leg  
Rigid S-Cleat



**135**  
1" Leg  
Rigid S-Cleat



**6S**  
S-Cleat  
10" and 12" available

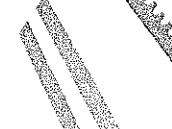

**5**  
Duct Hanger



**3**  
Fiberglass Extension

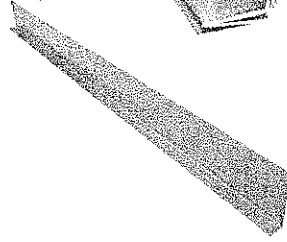

**1106**  
Cold Air Frame

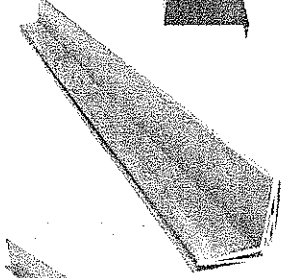

**1112**  
Plenum Corner



**133**  
Line Cover



**134**  
Can Stock

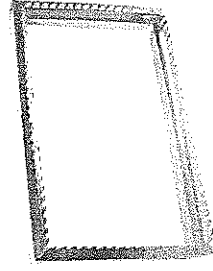

**FR**  
Filter Rack

## RETURN AIR PRODUCTS

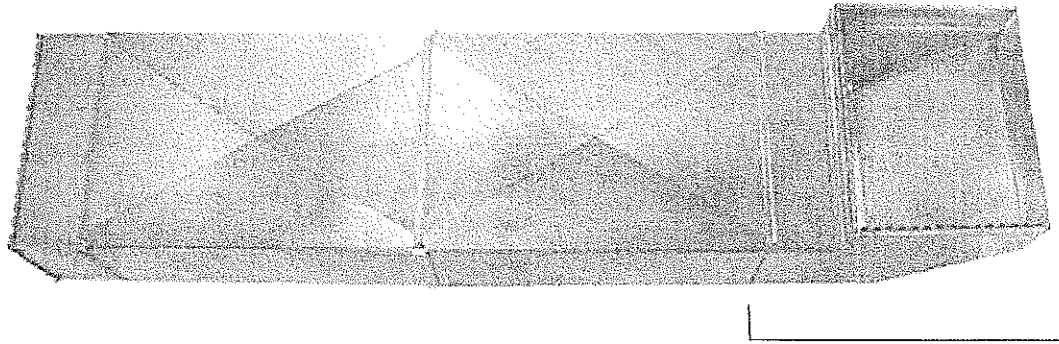

### COLD AIR BOOT

Part No.	A	B	C	Return Duct Size
SB30	30"	20"	10"	8 x 24
SB38	38"	26"	15"	10 x 25
SBF30	30"	22"	15"	8 x 24
SBF32	32"	22"	15"	8 x 24
SBF36	36"	26"	15"	10 x 25
SBF38	38"	28"	15"	10 x 25

**35**  
Trunk Reducer



**35A**  
Trunk Reducer

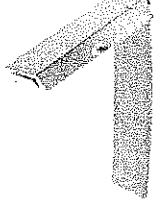

**48**  
Panning Material

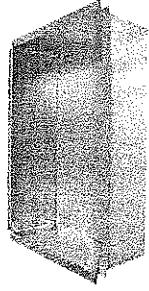

**170**  
Return Air Pan

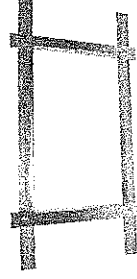

**31**  
Return Air Frame

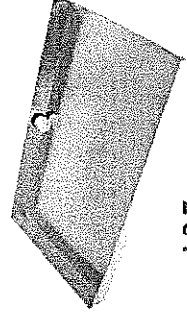

**137**  
Drain Pan  
3/4" Slip Fitting

### RETURN AIR PACKAGE

Complete package consisting of:

- 1 - #20 Starting collar
- 2 - 30" duct sections
- 1 - return air plenum with 1" filter rack
- 6 - 10" drive straps

Shipped knocked down in one carton

Return Air Pkg	Duct Size Range	Boot Only
810	20x10 - 20x16	810B
811	25x10 - 25x16	811B
812	20x10 - 20x14	812B
813	25x10 - 25x14	813B
814	20x8 - 20x16	814B
815	24x8 - 24x16	815B
816	20x8 - 20x14	816B
817	24x8 - 24x14	817B

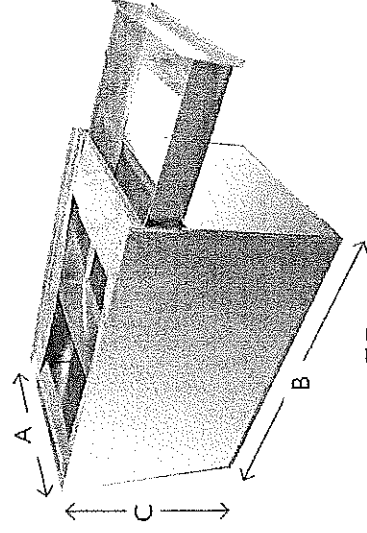

**FB**

Furnace Box with Filter Drawer  
Also available with Hinged Door

Part No.	A	B	C	Filter Size
FB1428	14 3/4"	28 1/2"	18 1/2"	14x25
FB1728	17 1/4"	28 1/2"	18 1/2"	16x25
FB2128	21 3/4"	28 1/2"	18 1/2"	20x25
FB2428	24 3/4"	28 1/2"	18 1/2"	20x25

**SB**  
Return Air Support Box

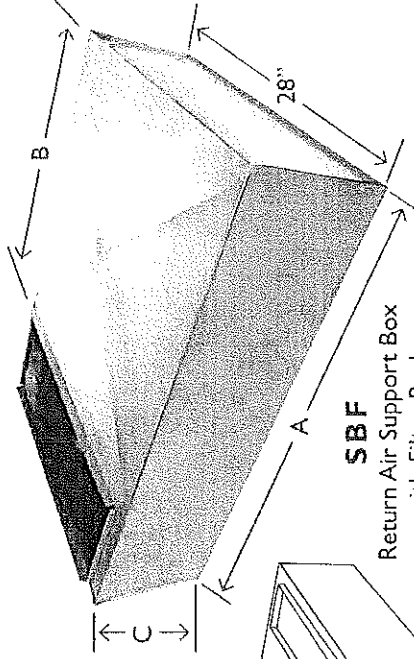
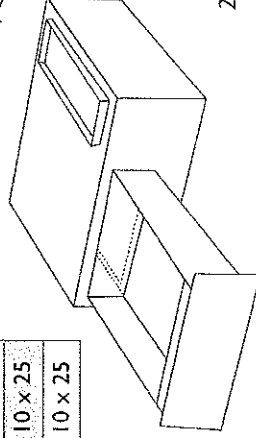

**SBF**

Return Air Support Box  
with Filter Rack

22 x 28 drawer accommodates  
1", 4" and 5" 20x25 filters

# OVAL PIPE and FITTINGS

## OVAL PIPE

Pipe Size	Height	Circumference	Area	CFM Capacity at 10 I/W/C
5"	2 1/2"	15.7"	17.2 sq in	60 CFM
6"	2 7/8"	18.8"	22.2 sq in	78 CFM
7"	3"	22.0"	27.3 sq in	104 CFM
8"	3 1/16"	25.1"	32.2 sq in	190 CFM

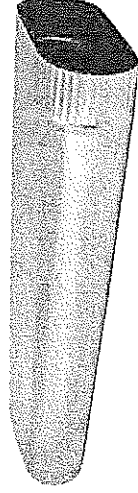

### WALL STACK VS. OVAL PHYSICAL COMPARISON

<p>5" OVAL 3 1/2" X 8"</p>	<p>6" OVAL 3 1/2" X 10"</p>	<p>7" OVAL 3 1/2" X 12"</p>	<p>8" OVAL 3 1/2" X 14"</p>
--------------------------------	---------------------------------	---------------------------------	---------------------------------

All oval pipe is made from 30Ga galvanized steel.

- No. 160 60" Oval Pipe Joint
- No. 100 100" Oval Pipe Joint
- No. 112 112" Oval Pipe Joint
- No. 113 113" Oval Pipe Joint
- No. 114 114" Oval Pipe Joint

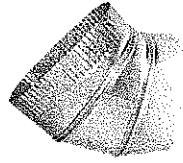

**113**  
45° Flat  
(Broadway)  
Oval Angle



**114**  
90° Flat  
(Broadway)  
Oval Elbow

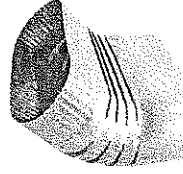

**115**  
45° Vertical  
(Shortway)  
Oval Angle



**116**  
90° Vertical  
(Shortway)  
Oval Elbow

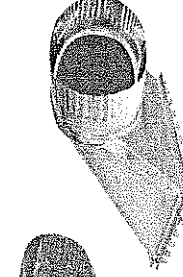

**162**  
Top Oval  
Takeoff

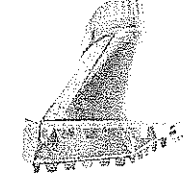

**163**  
Side Oval  
Takeoff

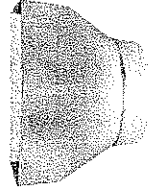

**127R**  
Straight Oval  
Register Boot

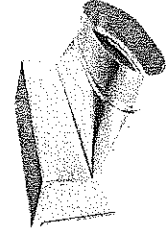

**124R**  
90° Oval  
Register Boot

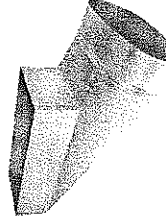

**128R**  
End Oval  
Register Boot

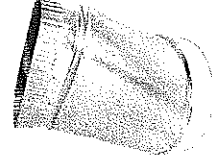

**127**  
Oval to Round  
Straight Boot



**124**  
Oval to Round  
90° Boot



**128**  
Oval to Oval  
Reverse Boot

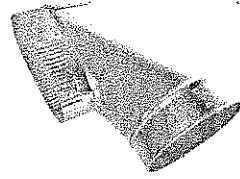

**106**  
Oval to Round  
Reverse Boot

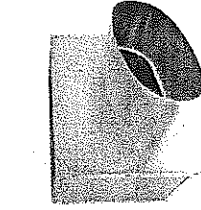

**355**  
Straight Oval  
Register Box

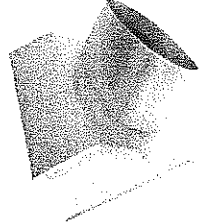

**360**  
Angle Oval  
Register Box

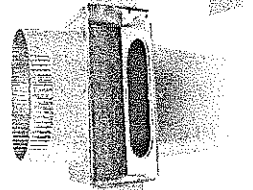

**150**  
Oval Stackhead  
with Collar



**111**  
Register  
Outlet

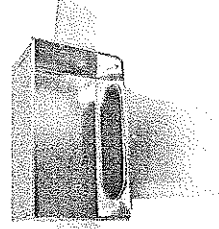

**110**  
Oval  
Stackhead

## WALL STACK and FITTINGS

### WALL STACK

#### Featuring:

- 12", 24", 30", 60", 96", 100" and 113" lengths available
- Two pieces per section
- Furnished in button snaplock
- No tools and no indentations, just snap it and it's closed!

### STACKHEADS

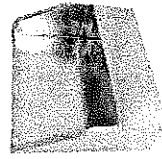

**WS11**  
Projection  
Stackhead

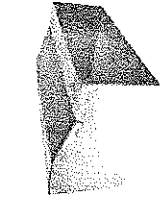

**WS12**  
Horizontal  
Stackhead

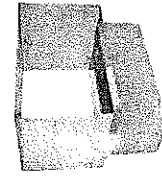

**WS9**  
Double  
Stackhead

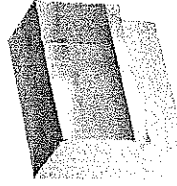

**WS10**  
Stackhead

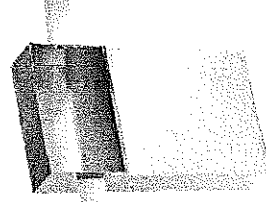

**WS10X**  
Long Throat  
Stackhead with Ears

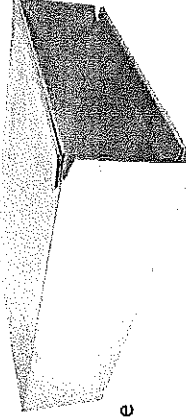

**I32**  
Adjustable  
"A" Adapter  
Available in  
2 1/4 x 10,  
2 1/4 x 12, or  
2 1/4 x 14



**I33**  
Adjustable  
"B" Adapter  
Available in  
4x10 - 3 1/4x10,  
4x10 - 3 1/4x12, or  
4x10 - 3 1/4x14

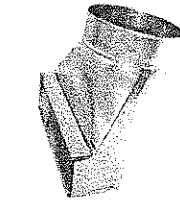

**24**  
90° Stack Boot

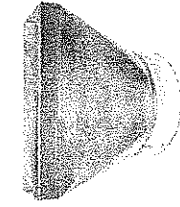

**27**  
Straight  
Stack Boot

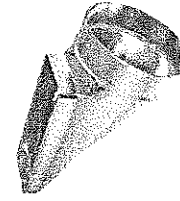

**28**  
End Stack Boot

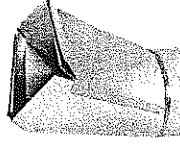

**26**  
45° Stack Boot

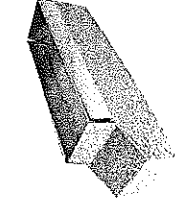

**WS17**  
45° Stack Transition

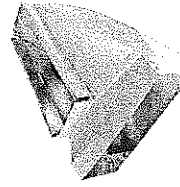

**WS7C**  
Reverse Stack  
Elbow (Center)

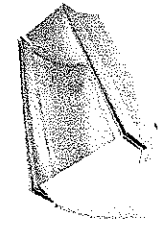

**WS15**  
45° Vertical  
(Shortway)  
Stack Angle

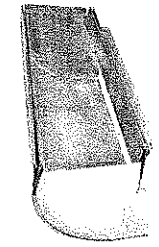

**WS16**  
90° Vertical  
(Shortway)  
Stack Elbow

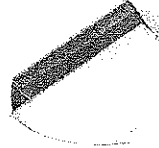

**WS13**  
45° Flat  
(Broadway)  
Stack Angle



**WS14**  
90° Flat  
(Broadway)  
Stack Elbow



**WS20**  
Straight Stack  
Collar

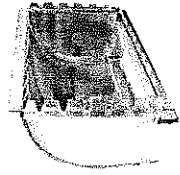

**WS60**  
Top Stack  
Takeoff

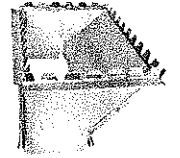

**WS61**  
Side Stack  
Takeoff



**WS21**  
Stack  
End Cap

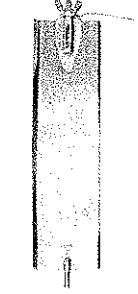

**WS45**  
Stack Damper

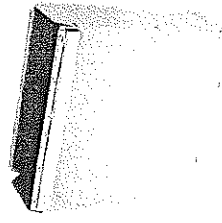

**PHEXT**  
PH Extension  
10" long



## SHEET METAL COLLARS

## SHEET METAL and DUCTBOARD COLLARS

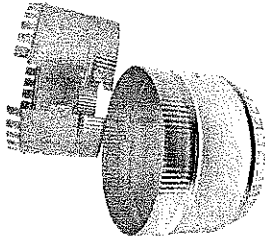

**120SC**  
Snap Collar



**97**  
Collar  
**97NC**  
No Crimp

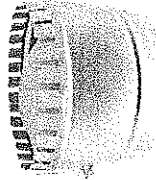

**97LS**  
Long Collar  
**97LSWD**  
with Damper



**1051**  
Collar  
**1050**  
No Crimp

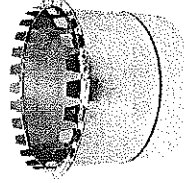

**1150**  
Long Collar  
**1149**  
With Damper

## SHEET METAL SPIN COLLARS

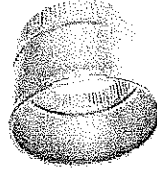

**156**  
Spin Collar

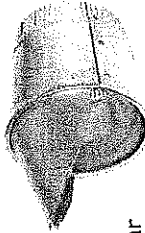

**156S**  
Spin Collar  
with Scoop



**156D**  
Spin Collar  
with Damper

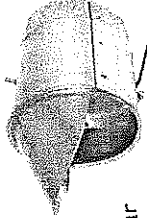

**156SD**  
Spin Collar  
with Scoop  
and Damper

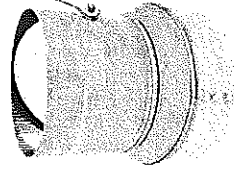

**156BM**  
Bellmouth  
Spin Collar



**156DBM**  
with Damper



**156SDBM**  
with Scoop and  
Damper

## DUCTBOARD SPIN COLLARS



**97FG**  
Spin Collar

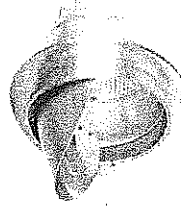

**98**  
Spin Collar  
with Scoop



**97FGWD**  
Spin Collar  
with Damper

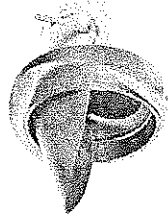

**98WD**  
Spin Collar  
with Scoop  
and Damper

## DUCTBOARD COLLARS

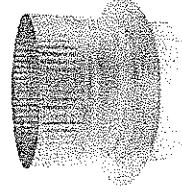

**84ST**  
Ductboard Collar  
**84STWD**  
with Damper



**122SC**  
Snap Collar  
1 1/2" or 2"  
Ductboard

**121SC**  
Snap Collar  
1" or 1 1/2" Ductboard

**SHEET METAL and  
DUCTBOARD TAKEOFFS**

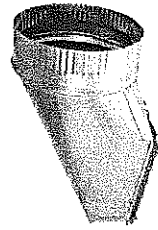

**62**  
Top Takeoff  
(Metal)

Pipe Size	Base Opening
4"	4 x 6
5"	5 x 6
6"	6 x 6
7"	7 x 7
8"	8 x 8
9"	10 x 10
10"	10 x 10
12"	12 x 12
14"	14 x 14



**62FG**  
Top Takeoff  
(Ductboard)

Pipe Size	Base Opening
4"	4 x 6
5"	5 x 6
6"	6 x 6
7"	7 x 7
8"	8 x 8
9"	10 x 10
10"	11 1/2 x 10
12"	12 x 12
14"	14 x 14

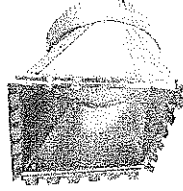

**63**  
Side Takeoff  
(Metal)

Pipe Size	Base Opening
4"	6 x 6
5"	6 x 6
6"	6 x 6
7"	6 x 8
8"	6 x 10
9"	7 x 12
10"	7 x 14
12"	8 x 18
14"	8 x 20
16"	10 x 21

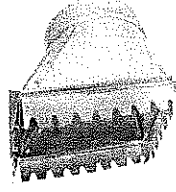

**63FG**  
Side Takeoff  
(Ductboard)

Pipe Size	Base Opening
4"	6 x 6
5"	6 x 6
6"	6 x 6
7"	6 x 8
8"	6 x 10
9"	7 x 12
10"	7 x 14
12"	8 x 18
14"	8 x 20

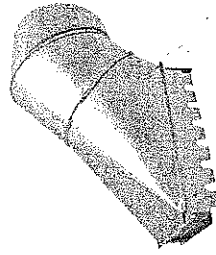

**2016**  
Adjustable Takeoff  
(Ductboard)

Pipe Size	Base Opening
4"	4 x 6
5"	5 x 6
6"	6 x 7
7"	7 x 8
8"	7 x 10
9"	9 x 11
10"	10 x 12
12"	12 x 16
14"	14 x 19

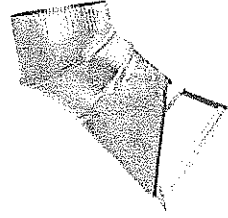

**34PLF**  
Adjustable Takeoff  
(Ductboard)

Pipe Size	Base Opening
5"	5 x 6
6"	6 3/8 x 6 3/8
7"	7 x 8
8"	6 3/8 x 10



**63A**  
Adjustable Takeoff  
(Metal)

Pipe Size	Base Opening
4"	4 x 6
5"	5 x 6
6"	6 x 7
7"	7 x 8
8"	7 x 10
9"	9 x 11
10"	10 x 12
12"	12 x 16
14"	14 x 19
16"	14 x 18
18"	18 x 18

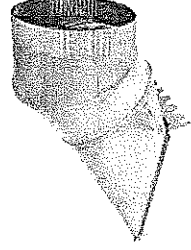

**63AFG**  
Adjustable Takeoff  
(Ductboard)

Pipe Size	Base Opening
4"	4 x 6
5"	5 x 6
6"	6 x 7
7"	7 x 8
8"	7 x 10
9"	9 x 11
10"	10 x 12
12"	12 x 16
14"	14 x 19

**SHEET METAL and  
DUCTBOARD TAKEOFFS**

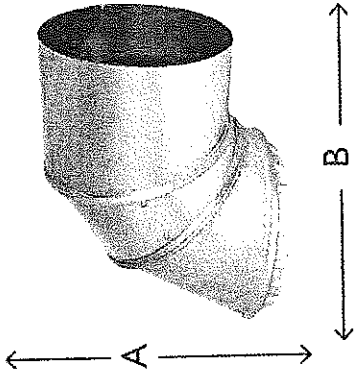

**EP15**  
Full Tab Takeoff (Metal)

Pipe Size	Base Opening	A	B
4"	6 3/8"	7 1/4"	9 1/4"
5"	6 3/8"	7 1/4"	9 1/4"
6"	7"	7 1/2"	11"
7"	8"	8 1/2"	12 1/2"

Features 3/4" tabs, tapered collar, and no crimp.  
1 7/8" rise when installed.

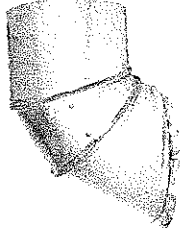

**HT15**  
Half-Tab Takeoff  
(Metal)

Pipe Size	Base Opening
4"	6 3/8"
5"	6 3/8"
6"	7"
7"	8"

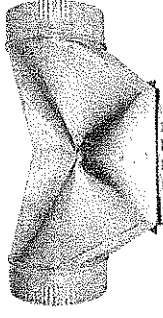

**64**  
Double Top Takeoff  
(Metal)

Pipe Size	Base Opening
5"	6 x 10
6"	7 x 10
7"	7 x 14
8"	8 x 14

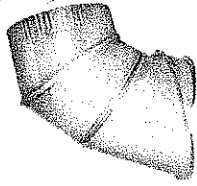

**S5**  
Pivot Takeoff  
(Metal)

Pipe Size	Base Opening
5"	6"
6"	7"
7"	8"

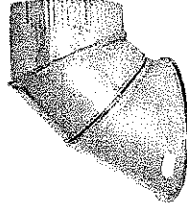

**87**  
Lever Lock Takeoff  
(Metal)

Pipe Size	Base Opening
5"	6"
6"	7"
7"	8"

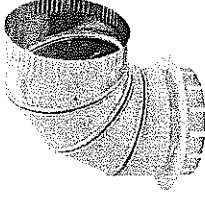

**2015**  
Round Takeoff  
Elbow (Ductboard)

Pipe Size	Base Opening
5"	6"
6"	7"
7"	8"
8"	9"

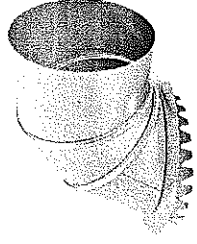

**2022**  
Round Takeoff  
(Ductboard)

Pipe Size	Base Opening
5"	6"
6"	7"
7"	8"
8"	9"

## AIR-TITE TAKEOFFS

## AIR-TITE TAKEOFFS

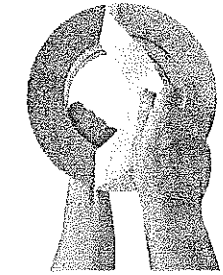

### Featuring:

- 1 1/2" wide and 1/8" thick gasket, made with high tack adhesive-coated neoprene foam -- just peel and stick for easy installation
- Gasket includes 4 1/8" pre-drilled holes for sheet metal screws attachment
- RL-2 rivet seam (+/- 4" w.g.) with 1/2" overlap, using 1/8" rivets
- Dampers available for 1/4" and 3/8" square and round bearings; also available 3/8" continuous rod damper (by request)
- Damper fittings available with 1 1/2" or 2" standoffs (by request)

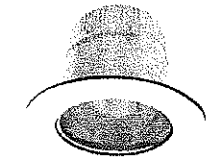

**ATT**  
Airtite takeoff



**ATD**  
Airtite Takeoff  
with Damper



**ATS**  
Airtite Takeoff  
with Scoop



**ATSD**  
Airtite Takeoff  
with Scoop  
and Damper



**ATSRP**  
Round Pipe Takeoff  
with Scoop  
**ATSDRP**  
with Scoop  
and Damper



**ATDRP**  
Round Pipe  
Takeoff  
with Damper

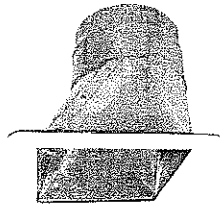

**AT63**  
Rectangular  
Airtite Takeoff  
**AT63WD**  
with Damper

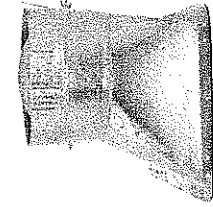

**ATHE**  
High Efficiency  
Airtite Takeoff  
**ATHEWD**  
with Damper

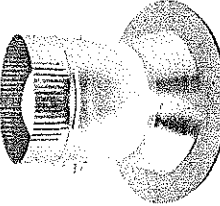

**ATTBM**  
Bellmouth  
Airtite Takeoff  
**ATDBM**  
with Damper

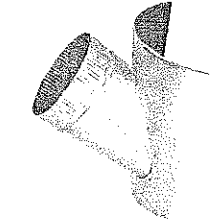

**ATTRP45**  
45° Saddle  
Airtite Takeoff

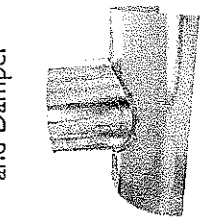

**ATTRP90**  
90° Saddle  
Airtite Takeoff

Pipe Size	Base-Opening
4"	6 x 6
5"	6 x 6
6"	6 x 6
7"	6 x 8
8"	6 x 10
9"	7 x 12
10"	7 x 14
12"	8 x 18
14"	8 x 20

Pipe Size	Base-Opening
4"	5 x 10
5"	5 x 10
6"	6 x 12
7"	6 x 12
8"	6 x 12
9"	6 x 15
10"	6 1/4 x 16
12"	8 1/2 x 18
14"	9 1/2 x 20
16"	14 x 22

Collar Size	Bellmouth Size
6"	8"
7"	9"
8"	10"
10"	12"
12"	14"
14"	16"
16"	18"



**AT63A**  
Adjustable  
Airtite Takeoff



**AT62**  
Airtite Top Takeoff  
**AT62WD**  
with Damper

**TEES, WYES, REDUCERS  
and ACCESSORIES**

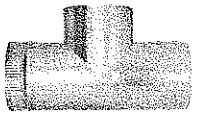

**TEE**

No. 53 24" Long  
No. 54 15" Long  
Available in  
26Ga or 24Ga

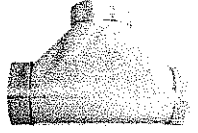

**1060**

Free Flow Tee  
Available in 30Ga,  
26Ga, and 24Ga



**200**

Trunk Tee



**201**

Straight-Thru Tee

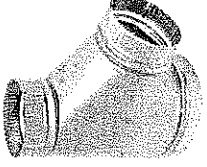

**202**

Reducing Tee

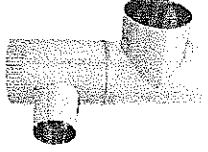

**54SW**

Swivel Tee

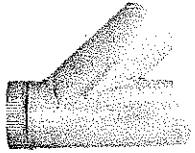

**SMOKE WYE**

No. 50 15" Long  
No. 51 24" Long

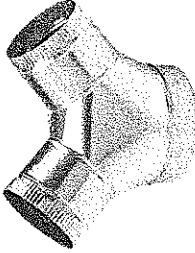

**78**

Wye Branch

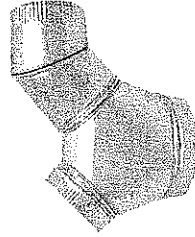

**78-1**

One-Way  
Adjustable Wye

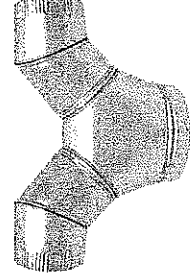

**78-2**

Two-Way  
Adjustable Wye

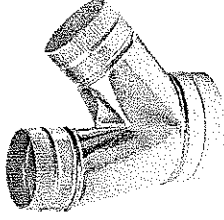

**715**

Splitter Wye



**52**

Flue Wye



**203S**

Stub Wye

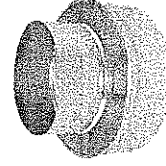

**582**

2 pc Reducer

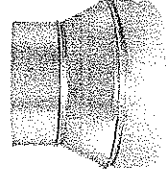

**58**

3 pc Reducer  
Available Crimped

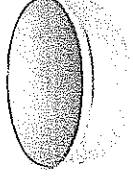

**55**

End Cap  
Available Crimped,  
With/Without Handle

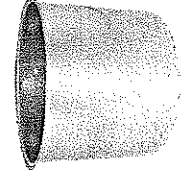

**117**

Flue Thimble

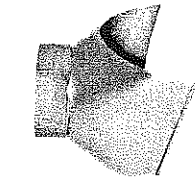

**207QT**

90° Saddle Tee

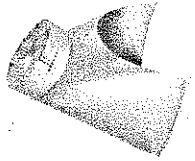

**208QY**

45° Saddle Wye

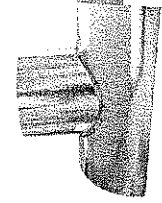

**207**

90° Vent Saddle

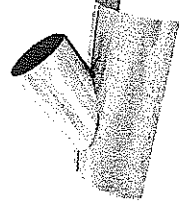

**208**

45° Vent Saddle

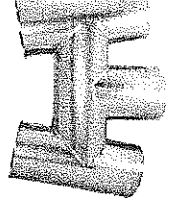

**199**

H-Vent

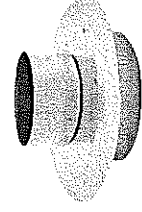

**64FR**

Flue Reducer

## INSULATED CEILING BOXES and CRD BOOTS

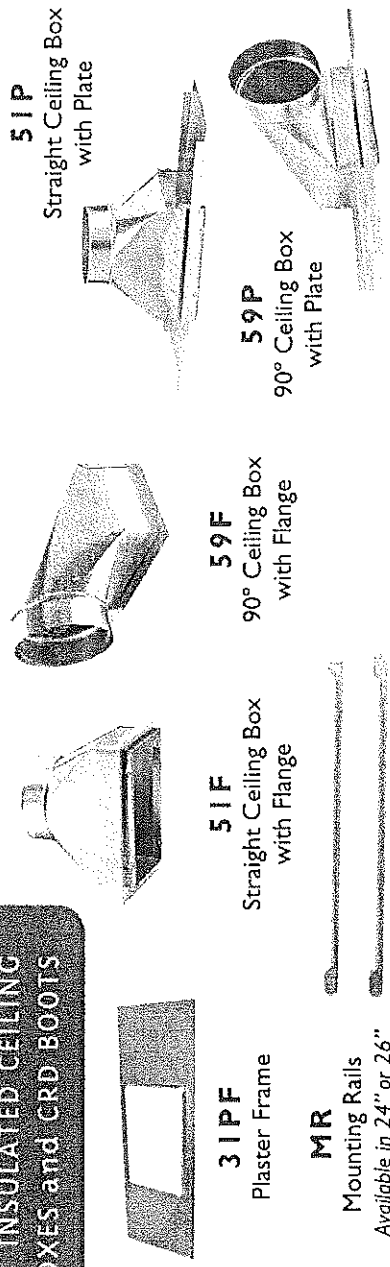

## INSULATED CEILING BOXES

Liner is available in R4 (1"), R6 (1½"), or R8 (2") insulation.

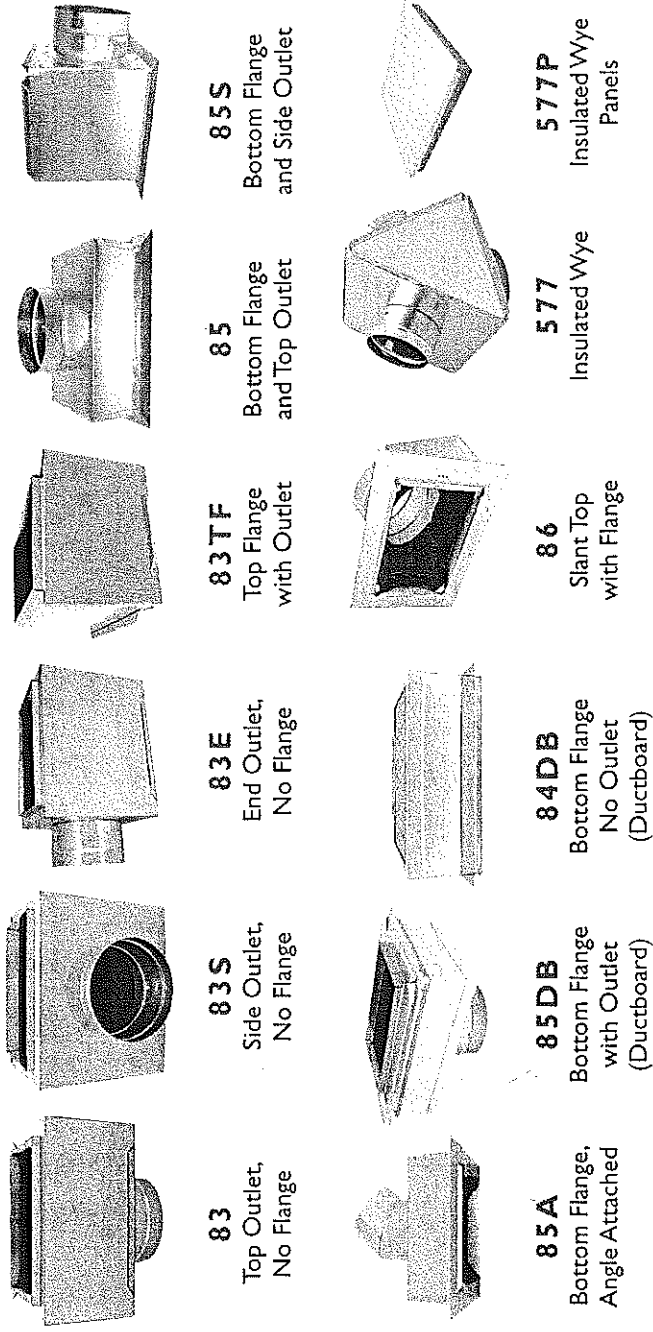

## CEILING RADIATION DAMPER BOOTS

Boots are non-insulated. Features rectangular radiation damper, butterfly-type, UL Classified 555C (3-hr rating), 212° easy access fusible link. Damper is attached with matching rivets and mounting brackets on all four sides; position in throat varies fitting to fitting.

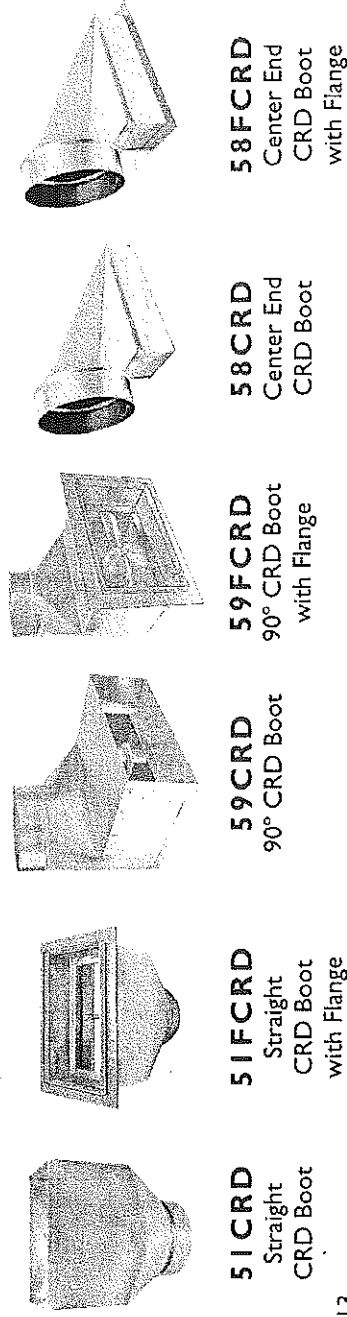

**REGISTER BOXES  
and CEILING OUTLETS**



**19RC**  
Register Collar



**70**  
Register Takeoff



**71**  
Register Tee



**74**  
Register Cap



**81**  
Ceiling Outlet  
**81D**  
with Damper

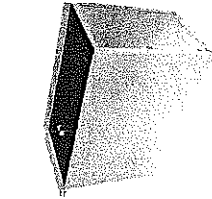

**75**  
Register Box  
7" Deep

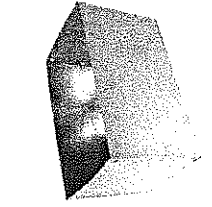

**90**  
Floor Register Box  
5" or 6" Deep

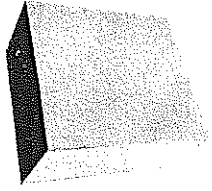

**91**  
Floor Register Box  
10" or 11" Deep

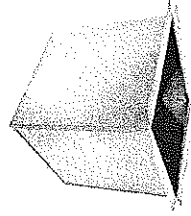

**73**  
Square  
Diffuser Box

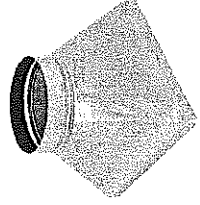

**73C**  
Square to Round  
Transition Outlet

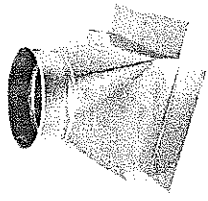

**77**  
Square to Round  
Diffuser Box

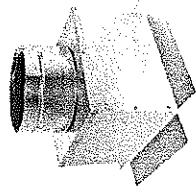

**177**  
Ceiling Outlet

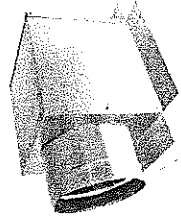

**177S**  
Side Outlet

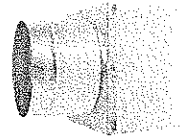

**277**  
Square to Round  
Diffuser Outlet,

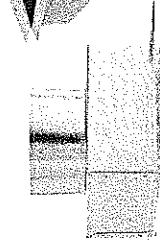

**277F**  
Square to Round  
Diffuser Outlet,  
with Flange

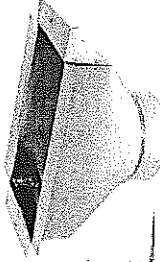

**92**  
Funnel Register  
Box with Flange

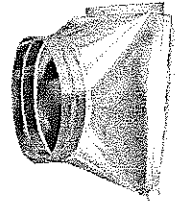

**92B**  
Funnel Register Box  
B-Box Style

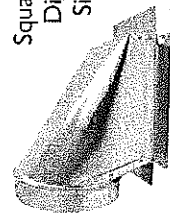

**77S**  
Square to Round  
Diffuser Box,  
Side Outlet

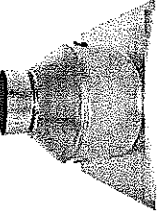

**58WF**  
Diffuser Outlet  
with Flange



**72**  
Diffuser Tee

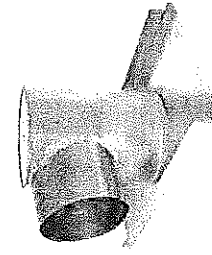

**72WF**  
Diffuser Tee  
with Flange

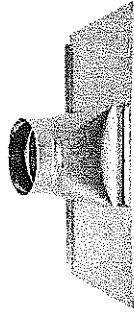

**77WF**  
Diffuser Funnel with Flange



**66WF**  
Ceiling Diffuser  
Outlet

**FURNACE FITTINGS and ACCESSORIES**

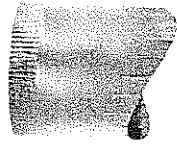

**83PC**  
Branch  
Connector

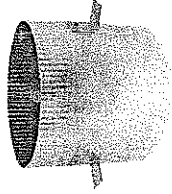

**86SC**  
Sleeve  
Connector

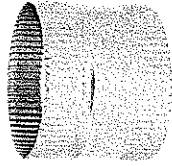

**97FC**  
Flex  
Connector

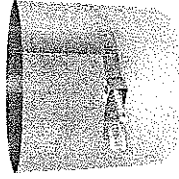

**96**  
Drawband

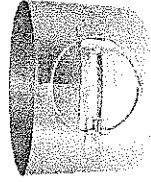

**S75**  
Snap  
Drawband

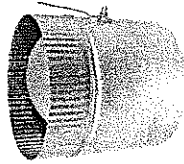

**40**  
Damper  
Section

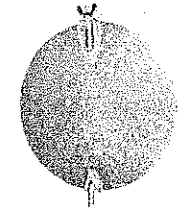

**44**  
Two Quad  
Damper

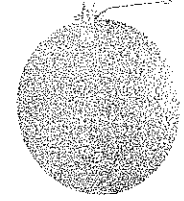

**44S**  
Damper  
Fixed Hardware

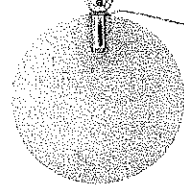

**44-1**  
One Quad  
Damper

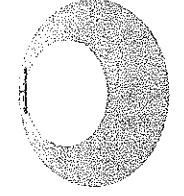

**63FC**  
Ceiling Collar

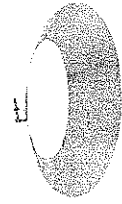

**142**  
Storm Collar

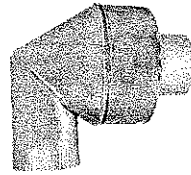

**93**  
Elbow  
Draft Vent

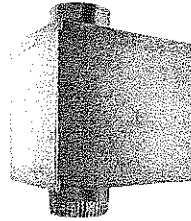

**94**  
Horizontal  
Draft Vent

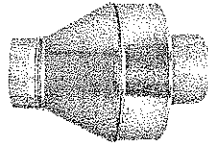

**95**  
Vertical  
Draft Vent



**140**  
Adjustable  
Roof Flashing

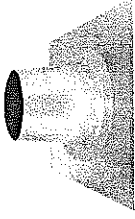

**141**  
Tall Cone  
Flashing



**RJ**  
Roof Jack

**WALL CAP**

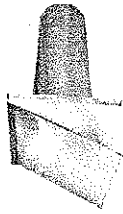

**36**  
Wall Cap



**39**  
Wall Cap  
with Damper

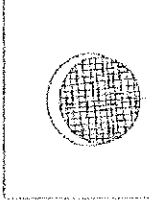

Mesh covering opening

**36AL**  
Aluminum Wall Cap

**39AL**  
Aluminum Wall Cap  
with Damper

Available with  
and without 1/4"  
galvanized wire  
birdscreen mesh  
covering interior  
tube opening.

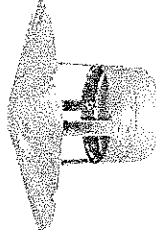

**99**  
Chimney Cap

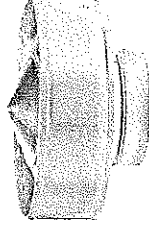

**99A**  
Chimney Cap

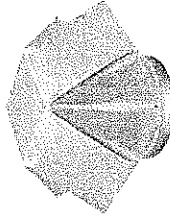

**99VC**  
Vent Cap

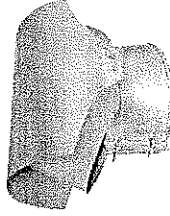

**99LD**  
Lo-Draft Chimney Cap



**VENTING PRODUCTS  
AND MOBILE HOME KITS**

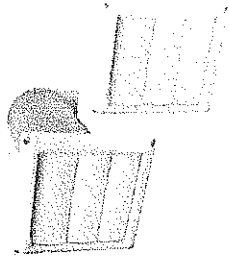

**390WP**  
White Louver  
Hood with Tail  
Face Only

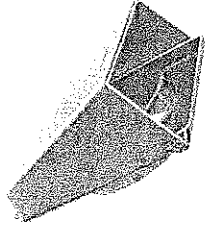

**39GP**  
Gray Plastic Wall  
Cap with Damper

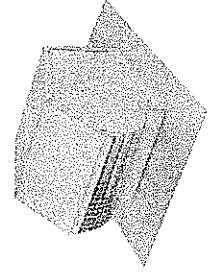

**ROOF CAP**  
Aluminum with  
Damper and Screen  
No. 239 Fits 4" round  
No. 240 Up to 7" round  
No. 241 Up to 10" round

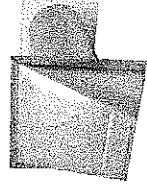

**SVH**  
Aluminum  
Vent Hood



**201VH**  
Aluminum  
Wall Cap



**391WP**  
White Plastic  
Face Only



**SVHBP**  
Brown Plastic  
Vent Hood

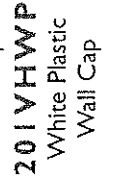

**201VHWP**  
White Plastic  
Wall Cap

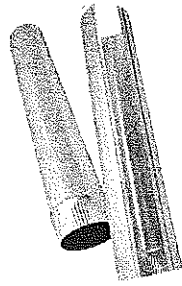

**SAP**  
Aluminum  
Snaplock Pipe



**SAE**  
Aluminum  
90° Elbow

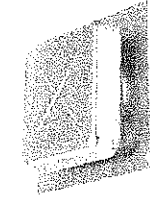

**RV51**  
Aluminum Roof  
Cap with Screen  
Up to 8" Round

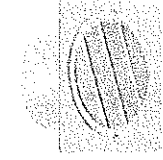

**EVI41**  
Eave Vent

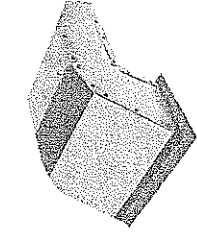

**220EC**  
Eave Vent  
with Grille



**SPC**  
Pipe Clamp



**SH**  
Flexible White  
Vinyl Hose



**MF**  
Flexible  
Aluminum  
Duct



**SAL**  
Aluminum  
Transition  
Duct

**MOBILE HOME KITS**

**SWK**

**Single Wide Kit**

*Includes:*

- 1 - Return Air Box
- 1 - Butterfly Damper
- 1 - Floor Grille
- 1 - Panel Filter

**DWK**

**Double Wide Kit**

*Includes:*

- 1 - Return Air Box
- 2 - Butterfly Dampers
- 1 - 78 Wye Branch
- 1 - Floor Grille
- 1 - Panel Filter



Panel Filter



Floor Grille

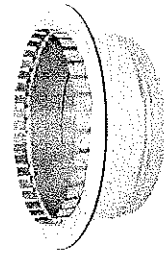

Butterfly Damper

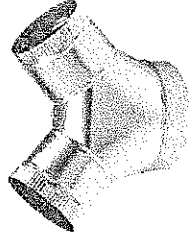

**78**  
Wye Branch

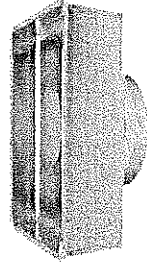

**74**  
Return Air Box  
Available as  
6" Deep Box or  
12" Deep Box

Kit sizes available:  
12x20-12 Round, 12x20-14 Oval,  
and 14x20-14 Round.

## BLACK PIPE and FITTINGS

### BLACK PIPE & FITTINGS:

- Available in 5", 6", 7", and 8" diameters
- 24 Gauge material, cold-rolled steel coils per ASTM A1008 CS-B (aiming 1/2 standard ASTM tolerances), skinpassed
- High heat black-painted with Valspar WPA0053 (.35 mil each side)
- Heat and rust resistant
- Standard packaging

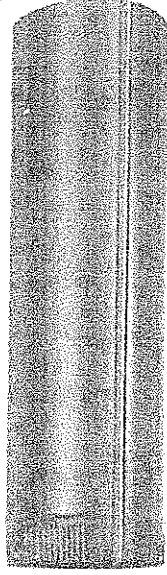

**BP**

Snaplock Pipe

Available in 12", 24", and 36" lengths

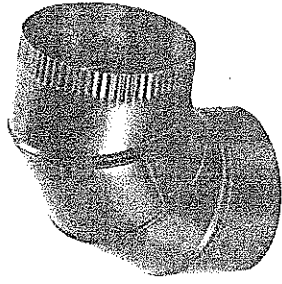

**BP90**

90° Adjustable Elbow

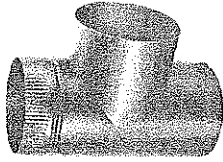

**BP54**

Tee

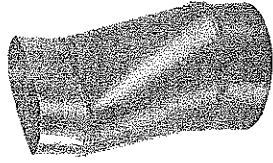

**BP127**

Oval to Round Adapter

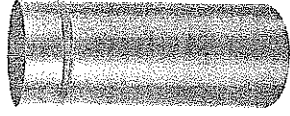

**BPCHAD**

Chimney Adapter

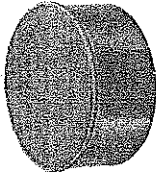

**BP55**

End Cap



**BP96**

Drawband



**BPTC**

Trim Collar

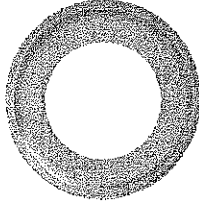

**BPC**

Pipe Collar

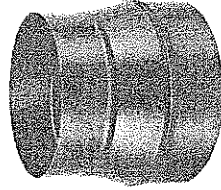

**BP58**

3 pc Reducer

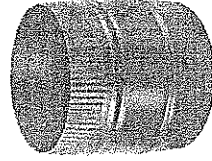

**BPCON**

Connector

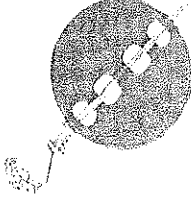

**CID**

Cast Iron Damper

## SPIRAL PIPE and FITTINGS

### SPIRAL PIPE & FITTINGS:

- 26 Ga and 24 Ga galvanized steel
- Also available in galvanized steel by request
- Low pressure fittings (+/- 4" w.g. pressure rating)
- Riveted connection
- Outside dimensions of each end diameter is approximately 1/8" under nominal size

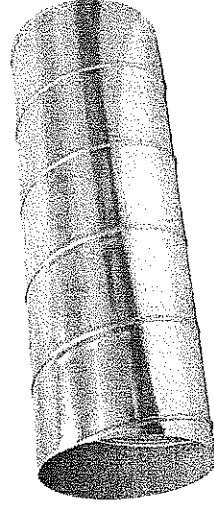

**SP10**  
Spiral Pipe

- Featuring:*
- 10 ft lengths
  - Available in 4" - 24" diameters
  - RL-1 spiral lock seam
  - Available in 26Ga and 24Ga

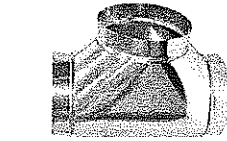

**SP54**  
Tee Joint



**SP55**  
End Cap

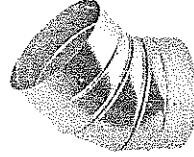

**SP45**  
45° Angle

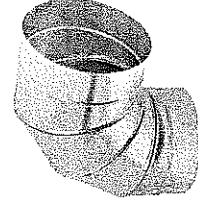

**SP90**  
90° Adjustable  
Elbow

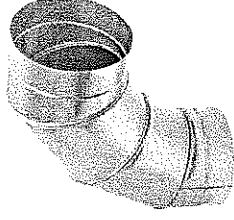

**SP90LR**  
Long Radius  
90° Elbow



**SP58**  
Tapered Reducer

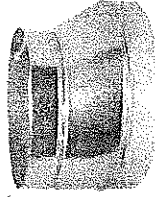

**SP58ER**  
Eccentric Reducer



**SP6**  
90° Shoe Tap

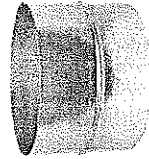

**SPCON**  
Connector

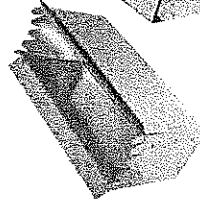

**SP70**  
Register Saddle

Diameter	Bend Radius
4"	3"
5"	3 3/4"
6"	4 1/2"
7"	5 1/4"
8"	6"
10"	7 1/2"
12"	9"
14"	10 1/2"
16"	12"
18"	13 1/2"
20"	15"
22"	16 1/2"
24"	18"

Diameter	Bend Radius
4"	6"
5"	7 1/2"
6"	9"
7"	10 1/2"
8"	12"
10"	15"
12"	18"
14"	21"
16"	24"
18"	27"
20"	30"
22"	33"
24"	36"

# PRODUCT INDEX

Item No.	Product Name	Page	Item No.	Product Name	Page
3	Fiberglass Extension	4	49C	Adjustable Plenum (Complete)	4
4	Plenum Chamber	4	49P	Adjustable Plenum Panel	4
5	Duct Hanger	4	49T	Adjustable Plenum Top	4
6S	S-Cleat	4	50	Wye - 15" Long	12
8D	Drive Cleat	4	51	Wye - 24" Long	12
13	Flat Trunk 45° Angle	3	51CRD	Straight CRD Boot	13
14	Flat Trunk 90° Elbow	3	51F	Straight Ceiling Box	13
14TT	Trunk Tee	4	51FCRD	Straight CRD Boot w/ Flange	13
15	Vertical Trunk 45° Angle	3	51P	Straight Ceiling Box w/ Plate	13
16	Vertical Trunk 90° Elbow	3	52	Flue Wye	12
17	Trunk Transition	3	53	Tee - 24" Long	12
17C	Trunk Transition (center)	3	54	Tee - 15" Long	12
17CR	Adjustable Register Boot	2	54SW	Swivel Tee	12
17TT	Trunk Tee	4	55	Tee Cap	12
18	Connector- Plenum to Trunk	4	58	3-pc Reducer	12
19RC	Register Collar	14	58CRD	End CRD Boot	13
20	Trunk Straight Collar	3	58FCRD	End CRD Boot w/ Flange	13
21	Trunk End Cap	3	58WF	Diffuser Outlet w/ Flange	14
23	Trunk Offset Collar	3	59CRD	90° CRD Boot	13
23AT	Trunk Transition Collar	3	59F	90° Ceiling Box	13
24	90° Stack Boot	7	59FCRD	90° CRD Boot w/ Flange	13
24R	90° Register Boot	2	59P	90° Ceiling Box w/ Plate	13
26	Angle Stack Boot	7	62	Top Takeoff (Metal)	9
26R	45° Register Boot	2	62FG	Top Takeoff (Ductboard)	9
27	Straight Stack Boot	7	63	Side Takeoff (Metal)	9
27R	Straight Register Boot	2	63A	Adjustable Takeoff (Metal)	9
28	End Stack Boot	7	63AFG	Adjustable Takeoff (Ductboard)	9
28R	End Register Boot	2	63FC	Ceiling Collar	15
29RO	Offset Register Boot	2	63FG	Side Takeoff (Ductboard)	9
31	Return Air Frame	5	64	Double Top Takeoff (Metal)	10
31PF	Plaster Frame	13	64FR	Flue Reducer	12
34PLF	Adj. Takeoff Fiberglass	9	66WF	Ceiling Diffuser Outlet	14
35	Trunk Reducer	5	70	Register Takeoff	14
35A	Trunk Reducer	5	71	Register Tee	14
36	Fresh Air Intake	15	72	Diffuser Tee	14
37	Rigid S-Cleat	4	72WF	Diffuser Tee w/ Flange	14
39	Galvanized Vent Hood	15	73	Square Diffuser Box	14
39AL	Alum Wall Cap w/Damper	15	73C	Sq to Rd Transition Outlet	14
39GP	Gray Plastic Wall Cap	16	74	Register Cap	14
39WP	White Plastic Wall Cap	16	74	Return Air Box	16
40	Damper Section	15	75	Register Box - 7" Deep	14
42	Trunk Volume Damper	3	77	Sq to Rd Diffuser Box	14
44	Round Damper	15	77S	Sq to Rd Diff. Box, Side Outlet	14
44-I	One Quad Damper	15	77WF	Diffuser Funnel w/ Flange	14
44S	Rd Damper- Fixed Hardware	15	78	Wye Branch	12
45	45° Adjustable Angle	2	78-1	One Way Adjustable Wye	12
47	Connector- Furnace to Plenum	4	78-2	Two Way Adjustable Wye	12
48	Panning Material	5	81	Ceiling Outlet	14
			81D	Ceiling Outlet w/ Damper	14
			83	Insul. Ceiling Box, Top Outlet	13
			83E	Insul. Ceiling Box, End Outlet	13
			83PC	Branch Connector	15
			83S	Insul. Ceiling Box, Side Outlet	13
			83TF	Insul. Ceiling Box, Top Flange	13
			84DB	Insul. Ceiling Box (Ductboard)	13
			84ST	Ductboard Collar	8
			84STWD	Ductboard Collar w/ Damper	8
			85	Insul. Ceiling Box, Top Outlet	13
			85A	Insul. Ceiling Box, Angle	13
			85DB	Insul. Ceiling Box (Ductboard)	13
			85S	Insul. Ceiling Box, Side Outlet	13
			86	Insul. Ceiling Box, Slant Top	13
			86SC	Sleeve Connector	15
			87	Lever Takeoff (Metal)	10
			90	90° Adjustable Elbow	2
			90	Floor Register Box - 6" Deep	14
			91	Floor Register Box - 10" Deep	14
			92	Funnel Register Box	14
			92B	Funnel Register Box (B-Style)	14
			93	Elbow Draft Vent	15
			94	Horizontal Draft Vent	15
			95	Vertical Draft Vent	15
			96	Drawband	15
			97	Flat Collar	8
			97FC	Flex Connector	15
			97FG	Spin Collar (Ductboard)	8
			97FGWD	Spin Collar (DB) w/ Damper	8
			97LS	Long Collar	8
			97LSWD	Long Collar w/ Damper	8
			98	Spin Collar (DB) w/ Scoop	8
			98WVD	Spin Collar (DB) w/ Scoop/Damp.	8
			99	Chimney Cap	15
			99A	Chimney Cap	15
			99LD	Lo-Draft Chimney Cap	15
			99VC	Vent Cap	15
			100	Oval Pipe - 100"	6
			106	Rd to Oval Reverse Boot	6
			110	Oval Stackhead	6
			111	Register Outlet	6
			113	Flat Oval 45° Angle	6
			114	Flat Oval 90° Elbow	6
			115	Vertical Oval 45° Angle	6
			116	Vertical Oval 90° Elbow	6
			117	Flue Thimble	12
			120SC	Snap Collar	8
			121SC	Snap Collar (Ductboard)	8
			122SC	Snap Collar (Ductboard)	8
			124	Rd to Oval 90° Boot	6
			124R	Oval 90° Register Boot	8
			127	Rd to Oval Straight Boot	6
			127R	Oval Straight Register Boot	6
			128	Oval to Oval Reverse Boot	6

**PRODUCT INDEX**

Item No.	Product Name	Qty	Item No.	Product Name	Page
128R	Oval End Register Boot	6	1050	Collar, No Crimp	8
132	"A" Adapter	6	1051	Collar	8
133	"B" Adapter	6	1060	Free Flow Tee	12
133	Line Cover	7	1106	Cold Air Frame	4
134	Can Stock	7	1109	Transition Collar	3
135	Rigid S-Cleat (1" Leg)	4	1112	Plenum Corner	4
137	Drain Pan	5	1149	Long Collar w/ Damper	8
140	Adjustable Roof Flashing	15	1150	Long Collar	8
141	Tail Cone Flashing	15	2015	Rd Takeoff Elbow (Ductboard)	10
142	Storm Collar	15	2016	Adjustable Takeoff (Ductboard)	9
150	Oval Stackhead w/ Collar	15	2022	Round Takeoff (Ductboard)	10
156	Spin Collar	15	AT62	Air-Tite Top Takeoff	11
156BM	Bellmouth Spin Collar	6	AT62WD	Air-Tite Top Takeoff w/ Damper	11
156D	Spin Collar w/ Damper	8	AT63	Rectangular Air-Tite Takeoff	11
156SDBM	Bm. Spin Collar w/Scoop/Damp	8	AT63A	Adjustable Air-Tite Takeoff	11
156DBM	Bellmouth Spin Collar w/ Damper	8	AT63WD	Rect. Air-Tite Takeoff w/ Damper	11
156S	Spin Collar w/Scoop	8	ATD	Air-Tite Takeoff w/ Damper	11
156SD	Spin Collar w/Scoop/Damper	8	ATDBM	Bellmouth AT Takeoff w/ Damper	11
156SDBM	Bm. Spin Collar w/Scoop/Damp	8	ATDRP	Rd Pipe AT Takeoff w/ Damper	11
160	Oval Pipe - 60"	8	ATHE	High Efficiency Air-Tite Takeoff	11
162	Oval Top Takeoff	8	ATHEWD	High Eff AT Takeoff w/ Damper	11
163	Oval Side Takeoff	6	ATS	Air-Tite Takeoff w/ Scoop	11
170	Return Air Pan	6	ATSD	Air-Tite Takeoff w/ Scoop/Damp	11
177	Ceiling Outlet	6	ATSRP	Rd Pipe AT Takeoff w/ Scoop	11
177S	Ceiling Side Outlet	5	ATSDRP	Rd Pipe AT T/O w/Scoop/Damp	11
199	H-Vent	14	ATT	Air-Tite Takeoff	11
200	Trunk Tee	12	ATBDM	Bellmouth Air-Tite Takeoff	11
201	Straight Thru Tee	12	ATTRP	Round Pipe Takeoff	11
201YH	Aluminum Wall Vent	12	ATTRP45	45° Saddle Air-Tite Takeoff	11
201YHWP	White Plastic Vent	12	ATTRP90	90° Saddle Air-Tite Takeoff	11
202	Reducing Tee	16	BP24	Black Pipe - 24"	17
203S	Stub Wye	12	BP54	Black Tee	17
207	90° Vent Saddle	12	BP55	Black End Cap	17
207QT	Quick Tee 90°	12	BP58	Black 3-pc Reducer	17
208	45° Vent Saddle	12	BP90	Black 90° Elbow	17
208QT	Quick Wye 45°	12	BP96	Black Drawband	17
220EC	Eave Vent	12	BP127	Black Oval to Rd Adapter	17
239	Alum. Roof Cap w/ Damper	12	BPC	Black Pipe Collar	17
240	Alum. Roof Cap w/ Damper	16	BPGHAD	Black Chimney Adapter	17
241	Alum. Roof Cap w/ Damper	16	BPCON	Black Connector	17
277	Ceiling Outlet, No Flange	14	BPTC	Black Trim Collar	17
277F	Sq to Rd Outlet w/ Flange	14	CID	Cast Iron Damper	17
355	Oval Straight Register Box	6	DWK	Double Wide Mobile Home Kit	16
360	Oval Angle Register Box	6	EPI5	Full Tab Takeoff (Metal)	10
390WP	White Louver Hood w/ Tail	16	EVI41	Eave Vent	16
391WVP	White Louver Hood	16	FB	Furnace Box	5
577	Insulated Wye	13	FR	Filter Rack	4
577P	Insulated Wye Panel	13	HT15	Half Tab Takeoff (Metal)	10
582	2-pc Reducer	12	MF	Aluminum Flexible Duct	16
810-817	Return Air Package	5	MUI20	Conductor Pipe	2
810B-817B	Cold Air Boot	5	MR	Mounting Rails	13

Item No.	Product Name	Page
PH5	90° Basement Boot	2
PHEXT	PH Extension	7
RV51	Alum Roof Cap - 8" Opening	16
S5	Pivot Takeoff (Metal)	10
S75	Snap Drawband	15
SAE	Aluminum Elbow	16
SAL	Aluminum Transition Duct	16
SAP	Aluminum Pipe	16
SB	Support Box	5
SBF	Support Box w/ Filter Rack	5
SH	White Flexible Vinyl Hose	16
SL	Snaplock Pipe	2
SP6	Spiral 90° Shoe Tap	18
SP10	Spiral Pipe	18
SP45	Spiral 45° Angle	18
SP54	Spiral Tee	18
SP55	Spiral End Cap	18
SP58	Spiral Tapered Reducer	18
SP58ER	Spiral Eccentric Reducer	18
SP70	Spiral Register Saddle	18
SP90	Spiral 90° Elbow	18
SP90LR	Spiral Long Radius 90° Elbow	18
SPC	Pipe Clamp	16
SYH	Aluminum Vent Hood	16
SYHBP	Brown Plastic Vent Hood	16
SVHWP	White Plastic Vent Hood	16
SWK	Single Wide Mobile Home Kit	16
TD	Trunk Duct	3
WSJ	Wallstack	7
WS7C	Center Reverse Stack Elbow	7
WS9	Double Stackhead	7
WS10	Stackhead	7
WS10X	Long Throat SH w/ Ears	7
WS11	Projection Stackhead	7
WS12	Horizontal Stackhead	7
WS13	Flat Stack 45° Angle	7
WS14	Flat Stack 90° Elbow	7
WS15	Vertical Stack 45° Angle	7
WS16	Vertical Stack 90° Elbow	7
WS17	Stack Transition	7
WS20	Straight Stack Collar	7
WS21	Stack End Cap	7
WS45	Stack Damper	7
WS60	Stack Top Takeoff	7
WS61	Stack Side Takeoff	7

## TECHNICAL INFORMATION

EQUIVALENT LENGTHS	
<b>PLENUM/DUCT FITTINGS</b>	
No. 23	Offset starting collar 10' EL
No. 20	Straight starting collar 35' EL
No. 120SC	Snap collar, round 35' EL
<b>ROUND ELBOWS &amp; ANGLES</b>	
	90° elbows 30' EL
	45° angles 10 - 20' EL
<b>REGISTER BOOTS</b>	
No. 24R	90° register boot 30' EL
No. 27R	Straight register boot 5' EL
No. 28R	End register boot 50' EL
<b>ROUND FITTINGS (TAKEOFFS)</b>	
No. 97	Round starting collar 35' EL
No. 63	Square to round straight 20' EL
No. 63A	Square to round adj. side takeoff 50' EL
No. 62	Square to round top takeoff 50' EL
No. 55	Round to round (adjustable) 50' EL
No. 65	Round to round 50' EL
<b>DUCT ELBOWS, RADIUS THROAT</b>	
No. 14	Up to 11" 10' EL
	12" to 21" 15' EL
	22" to 27" 20' EL
	28" to 33" 25' EL
<b>DUCT ELBOWS, SQUARE THROAT</b>	
No. 16S	Up to 11" 40' EL
	12" to 15" 55' EL
	16" to 21" 75' EL
	22" to 27" 100' EL
	28" to 33" 125' EL
<b>RETURN AIR SYSTEM</b>	
No. 810	Cold air boot, collar, duct 45- 65' EL

## SIZING REQUIREMENTS

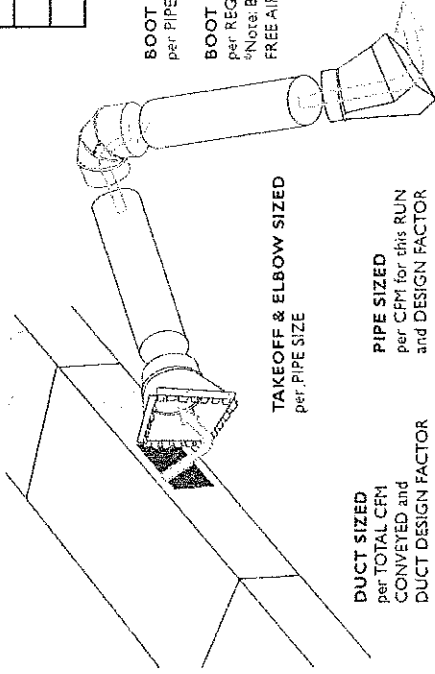

**DUCT SIZED**  
per TOTAL CFM  
CONVEYED and  
DUCT DESIGN FACTOR

**TAKEOFF & ELBOW SIZED**  
per PIPE SIZE

**PIPE SIZED**  
per CFM for this RUN  
and DESIGN FACTOR

<sup>1</sup> ASP x 100  
TOTAL EQ. LENGTH

**REGISTER SIZED**  
per STYLE, SPREAD THROW  
and FREE AREA of register and  
CFM requirement

**BOOT COLLAR SIZED**  
per PIPE SIZE

**BOOT OPENING SIZED**  
per REGISTER SIZE<sup>2</sup>  
<sup>2</sup>Note: Boot sized LARGER than  
FREE AIR, OPENING of register

## SMACNA Gauge Requirements for Galvanized Steel

Duct Diameter	2" wg. max Positive Pressure	Duct Diameter	2" wg. max Negative Pressure
3" - 8"	28 Ga	6" - 10"	28 Ga
9" - 14"	26 Ga	12"	26 Ga
15" - 26"	24 Ga	14" - 16"	24 Ga
		18" - 20"	22 Ga
		22" - 26"	20 Ga

From: SMACNA HVAC Duct Construction Standards Metal and Flexible, 2nd Ed (1995), 3.3 & 3.8

## SUPPLY OR RETURN DUCT SIZE/CAPACITY (.09 to .10 pressure drop per 100' EL)

CFM	ROUND (No. EL)	CAPACITY (No. EL)
50	5"	8 x 6
75	5"	8 x 6
100	6"	8 x 6
125	6"	3 1/2 x 10 (110)
150	7"	8 x 6
175	7"	8 x 6
200	7"	8 x 6
250	8"	6 x 10
300	9"	6 x 10
350	9"	6 x 10
400	9"	8 x 10
500	10"	10 x 10
600	12"	10 x 10
700	12"	12 x 10
800	12"	12 x 10
900	14"	14 x 10
1,000	14"	14 x 10
1,200	14"	16 x 10
1,400	16"	18 x 10
1,600	16"	20 x 10
1,800	16"	24 x 10
2,000	18"	26 x 10
2,500	18"	30 x 10
3,000	20"	36 x 10
3,500	22"	40 x 10
4,000	24"	26 x 16
		32 x 14
		38 x 12

8" Joist - 375 CFM; 10" Joist - 525 CFM (return only)

**ADJUSTMENT OF DUCT DESIGN PRESSURE (RATE) FOR EQUIVALENT LENGTHS**

Total Effective Length (Feet)	.05	.06	.08	.10	.125	.14	.16	.18	.20	.25	.30	.34	.375	.40	.50	.625	.75	1.00
35 - 44	.13	.15	.20	.25	.32	.35	.40	.45	.50	.63	.75	.85	.95	1.00	1.25	1.50	1.90	2.54
45 - 54	.10	.12	.16	.20	.25	.28	.32	.36	.40	.50	.60	.68	.76	.80	1.00	1.26	1.52	2.02
55 - 64	.08	.10	.13	.17	.21	.23	.27	.30	.33	.42	.50	.57	.63	.67	.83	1.05	1.26	1.68
65 - 74	.07	.09	.11	.14	.18	.20	.23	.26	.29	.36	.43	.49	.54	.57	.72	.90	1.08	1.44
75 - 84	.06	.08	.10	.13	.16	.18	.20	.23	.25	.31	.38	.43	.47	.50	.63	.79	.94	1.26
85 - 94	.06	.07	.09	.11	.14	.16	.18	.20	.22	.28	.33	.38	.42	.45	.56	.70	.84	1.12
95 - 104	.05	.06	.08	.10	.13	.14	.16	.18	.20	.25	.30	.33	.38	.40	.50	.63	.75	1.01
105 - 114	.05	.05	.07	.09	.11	.13	.15	.16	.18	.23	.28	.31	.34	.37	.47	.57	.69	.91
115 - 129	.04	.05	.07	.08	.10	.12	.13	.15	.17	.21	.25	.28	.31	.33	.46	.51	.62	.82
130 - 149	.04	.04	.06	.07	.09	.10	.11	.13	.14	.18	.21	.24	.27	.29	.36	.45	.54	.72
150 - 169	.03	.04	.05	.06	.08	.09	.10	.11	.13	.16	.19	.21	.24	.25	.31	.39	.47	.63
170 - 189	.03	.03	.04	.06	.07	.08	.09	.10	.11	.14	.17	.19	.21	.22	.28	.35	.42	.56
190 - 214	.03	.03	.04	.05	.06	.07	.08	.09	.10	.13	.15	.17	.19	.20	.25	.31	.37	.50
215 - 239	.02	.03	.04	.05	.05	.06	.07	.08	.09	.11	.13	.15	.17	.18	.22	.28	.33	.44
240 - 264	.02	.02	.03	.04	.05	.06	.06	.07	.08	.10	.12	.14	.15	.16	.20	.25	.30	.40
265 - 289	.02	.02	.03	.04	.04	.05	.06	.07	.07	.09	.11	.12	.14	.15	.18	.23	.27	.36
290 - 324	.02	.02	.03	.03	.04	.05	.05	.06	.07	.08	.10	.11	.12	.13	.17	.20	.24	.33
325 - 374	.02	.02	.02	.03	.04	.04	.05	.05	.06	.07	.09	.10	.11	.11	.14	.18	.21	.29
375 - 424	.01	.02	.02	.03	.03	.04	.04	.05	.05	.06	.08	.09	.09	.10	.13	.16	.19	.25
425 - 474	.01	.01	.02	.03	.03	.03	.04	.04	.05	.06	.07	.08	.08	.09	.11	.14	.17	.22
475 - 524	.01	.01	.02	.02	.03	.03	.03	.04	.04	.05	.06	.07	.07	.08	.10	.13	.15	.20
525 - 574	.01	.01	.02	.02	.02	.03	.03	.03	.04	.05	.06	.07	.07	.07	.09	.11	.14	.18
575 - 625	.01	.01	.01	.02	.02	.02	.03	.03	.03	.04	.05	.06	.06	.07	.08	.10	.13	.17

**FORMULAS**

**Sensible Heat Formula**

$$BTU/Hour = CFM \times TD \times 1.1$$

$$CFM = \frac{BTU/Hour}{1.1 \times TD \times ACF}$$

1.1 is a conversion factor

TD is the Temperature Difference created by the appliance

ACF is the Altitude Correction Factor (see above table)

**Altitude Correction Factor (ACF)**

0 ft	1.0	5000 ft	.826
500 ft	.981	6000 ft	.801
1000 ft	.962	7000 ft	.772
2000 ft	.926	8000 ft	.749
3000 ft	.891	9000 ft	.715
4000 ft	.858	10000 ft	.687

**Sensible Heat Ratio =  $\frac{\text{Sensible Load}}{\text{Sensitive Load} + \text{Latent Load}}$**

SHR below .80 = 21° TD      High humidity = 350 CFM/ton

SHR .80 to .85 = 19° TD      Ave. humidity = 400 CFM/ton

SHR above .85 = 17° TD      Low humidity = 450 CFM/ton

$$CFM = \frac{\text{Sensible Load}}{1.1 \times TD \times ACF}$$

$$1.1 \times TD \times ACF$$

**Total Heat Equation**

$$CFM = \frac{BTU/Hr}{4.5 \times H \times ACF}$$

4.5 is a conversion factor      H is the BTU per lb. of air removed

**Friction Rate**

\*%used in duct calculators

$$\text{Friction Rate} = \frac{\text{Pressure Drop} \times 100}{TEL}$$

Pressure Drop is the available static pressure (ASP) allocated to the duct work.

ASP = Blower Static Pressure - Component Pressure Drops

TEL is the Total Effective Length of the longest supply run and the longest return run.

**CFM Calculations**

$$\text{Room CFM} = \frac{\text{Blower CFM} \times \text{Room Load}}{\text{Equipment Sizing Load}}$$

$$\text{Flow Factor} = \frac{\text{Blower CFM}}{\text{Equipment Sizing Load}}$$

$$\text{Room CFM} = \text{Flow Factor} \times \text{Room Load}$$

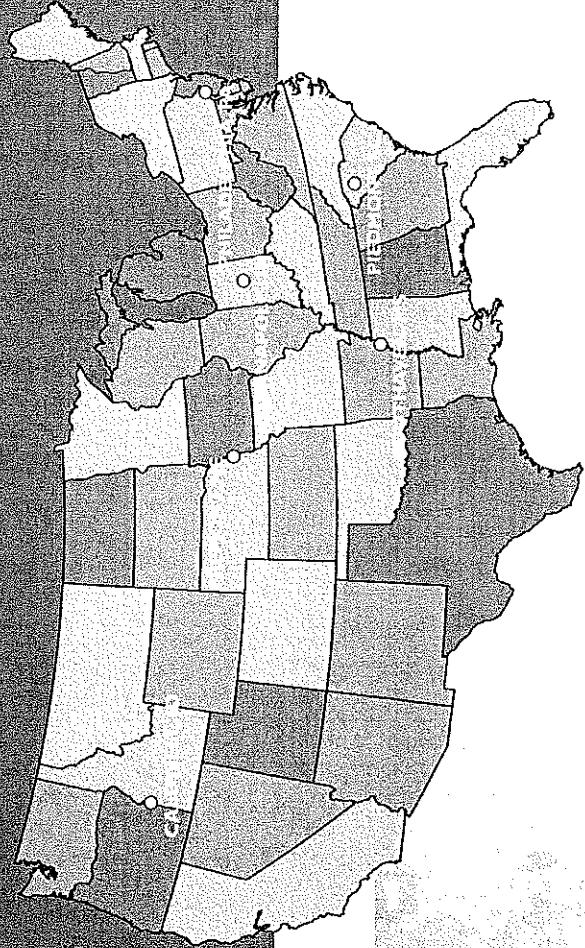

## OUR LOCATIONS

### PHILADELPHIA DIVISION

2800 Red Lion Road  
Philadelphia, PA 19114  
(800) 523-1052 • fax (800) 722-2076

#### STATES COVERED:

Pennsylvania, New Jersey, New York, Connecticut, Rhode Island, Massachusetts, Delaware, Vermont, New Hampshire, Maine, Maryland, and Virginia

### GREENVILLE DIVISION

255 Bessie Road - Highway 86  
Piedmont, SC 29673  
(800) 229-2803 • fax (864) 845-6190

#### STATES COVERED:

South Carolina, North Carolina, Virginia, Georgia, Florida, Alabama, and Tennessee

### INDIANAPOLIS DIVISION

10401 East 59th Street  
Indianapolis, IN 46236  
(800) 490-7707 • fax (317) 823-1006

#### STATES COVERED:

Indiana, Ohio, Michigan, Kentucky, West Virginia, Illinois, Wisconsin, Missouri, and Iowa

### MISSISSIPPI DIVISION

8680 Stanton Road  
Southaven, MS 38671  
(800) 541-6706 • fax (662) 393-8005

#### STATES COVERED:

Mississippi, Louisiana, Alabama, Arkansas, Tennessee, Missouri, Oklahoma, Kentucky, and Texas

### NEBRASKA DIVISION

2073 North Rademakers Way  
Fremont, NE 68025  
(800) 801-0336 • fax (402) 753-9008

#### STATES COVERED:

Nebraska, Missouri, Kansas, North Dakota, South Dakota, Colorado, Minnesota, Wyoming, and Iowa

### IDAHO DIVISION

4002 Skyway Street  
Caldwell, ID 83605  
(866) 289-9908 • fax (208) 402-2126

#### STATES COVERED:

Idaho, Montana, Nevada, Oregon, Utah, Washington, Wyoming, California, and Alaska

[www.southwarkmetal.com](http://www.southwarkmetal.com)