



PREFABRICATED SHEET METAL
DUCTS & FITTINGS

PRODUCT CATEGORY INDEX

Page	Description
2	Round Pipe, Elbows, Angles & Register Boots
3-4	Trunk Duct, Fittings & Installation Accessories
5	Return Air Products
6	Oval Pipe & Fittings
7	Wall Stack & Fittings
8	Sheet Metal and Ductboard Collars
9-10	Sheet Metal and Ductboard Takeoffs
11	Air-Tite Takeoffs
12	Tees, Wyes, Reducers, End Caps & Accessories
13	Insulated Ceiling Boxes and CRD Boots
14	Register Boxes and Ceiling Outlets
15	Furnace Fittings and Accessories
16	Venting Products and Mobile Home Kits
17	Black Pipe & Fittings
18	Spiral Pipe & Fittings
19-20	Product Number Index
21-22	Technical Information



Call us toll-free at:

Philadelphia • (800) 523-1052

Greenville • (800) 229-2803

Indianapolis • (800) 490-7707

Mississippi • (800) 541-6706

Nebraska • (800) 801-0336

Idaho • (866) 289-9908

www.southwarkmetal.com

About Us

Southwark Metal Manufacturing Company is a third generation family owned company that has been manufacturing prefabricated sheet metal ducts and fittings for over 60 years.

With six manufacturing plants across the United States, we guarantee to exceed your highest expectations with our quality products and superior service.

For all products within this catalog, please check with your local customer service representative for fitting sizes, availability, pricing, and submittal information.

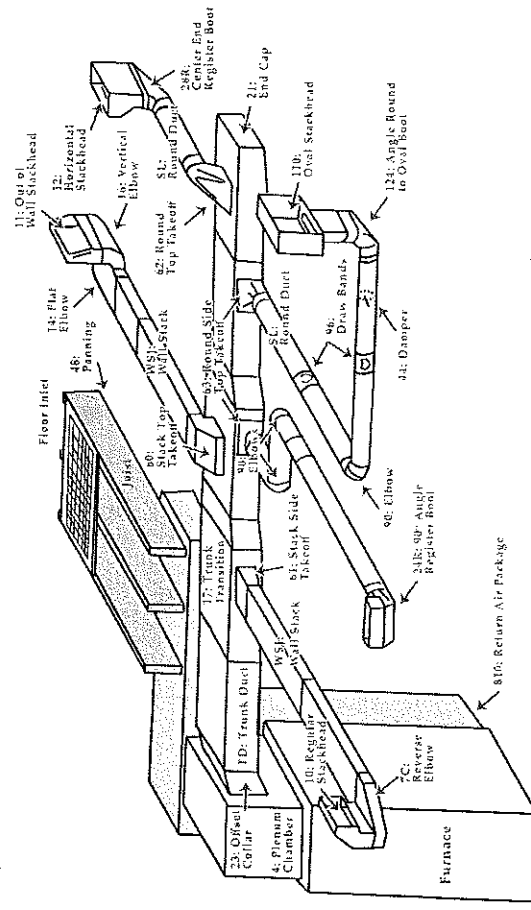

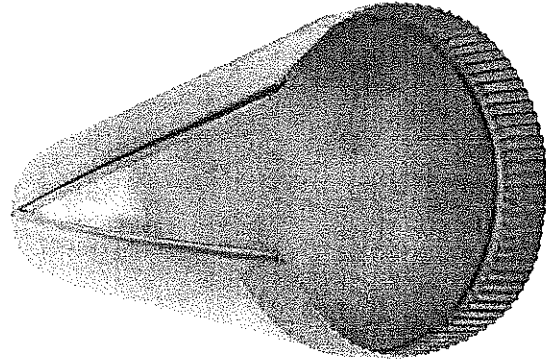

SNAPLOCK PIPE

No tools required for assembly!

Simply start at one end and easily snap pipe together. One person can quickly assemble up to 10 ft. lengths.

The male end's self-starting crimp is knurled sufficiently so that the crimp "falls in" and yet, once assembled, completes a rigid, leak-proof connection that meets $\pm 2''$ w.g. pressure.

- Available in 2ft, 3ft, 4ft, 5ft, and 10ft lengths
- Available in 30Ga, 28Ga, 26Ga, and 24Ga steel.

Open view

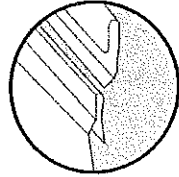

Closed view

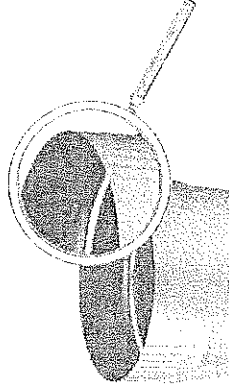
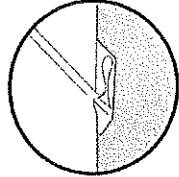

ROUND PIPE, ELBOWS, ANGLES, REGISTER BOOTS

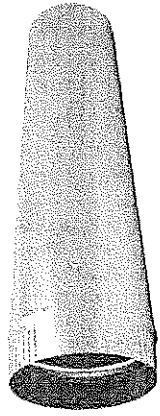

MUI 20

Conductor Pipe

- Available in 30Ga, 28Ga, and 26Ga
- 10 ft in length
- 3" and 4" diameters only
- Acme type lock, shipped closed

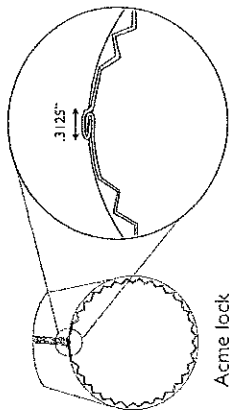

Acme lock

REGISTER BOOTS

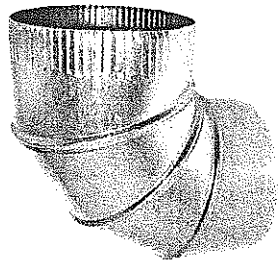

90° ADJUSTABLE ELBOW

Featuring:

- 4 pc. assembly for diameters 3" - 20"
- 5 pc. assembly for diameters 22" - 24"
- Crimp and bead male connection and straight female connection
- Meets $\pm 2''$ w.g. pressure overall

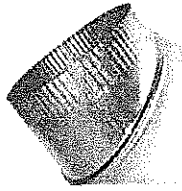

45° ADJUSTABLE ANGLE

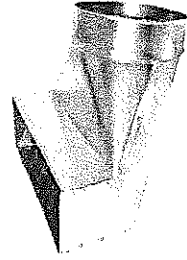

24R
90° Register Boot

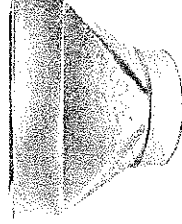

27R
Straight Register Boot

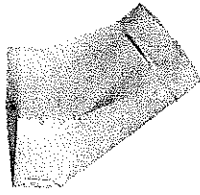

26R
45° Register Boot

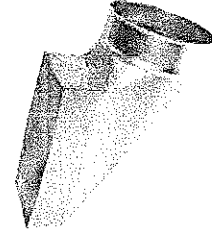

28R
Center End Register Boot
No. 28RL Left
No. 28RR Right

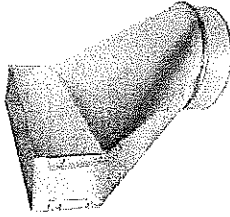

29RO
2" Offset Register Boot

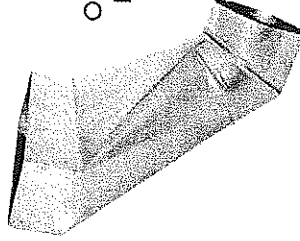

17CR
Offset Adjustable Register Boot

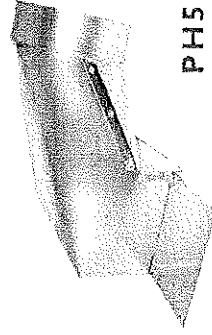

PH5
90° Basement Boot

TRUNK DUCT and FITTINGS

TRUNK DUCT

Featuring:

- Available in 12", 30", 36", 48", 60", and 96" lengths
- Furnished in button snap-lock with s-cleat and drive connections
- Cross broken for extra stiffening strength
- E-lock duct also available
- Beaded duct also available

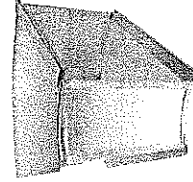
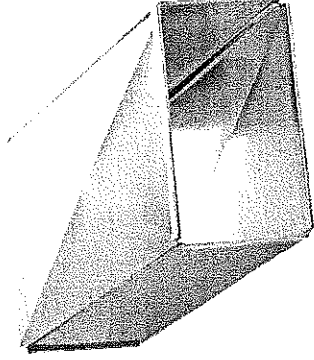

13
45° Vertical
(Shortway) Elbow
Radius Throat

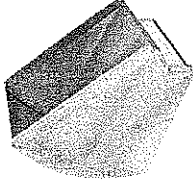

13S
45° Flat
(Broadway) Angle
Square Throat

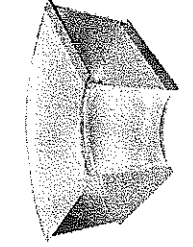

14
90° Flat
(Broadway) Elbow
Radius Throat

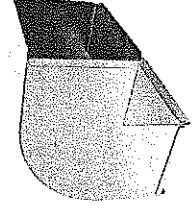

14S
90° Flat
(Broadway) Elbow
Square Throat

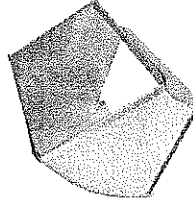

15
45° Vertical
(Shortway) Angle
Radius Throat

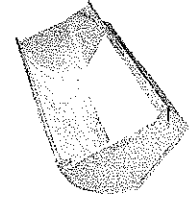

15S
45° Vertical
(Shortway) Angle
Square Throat

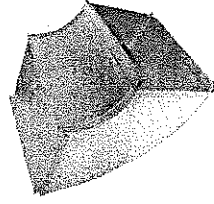

16
90° Vertical
(Shortway) Elbow
Radius Throat

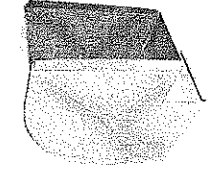

16S
90° Vertical
(Shortway) Elbow
Square Throat

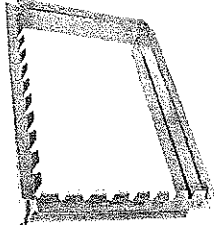

20
Straight Collar

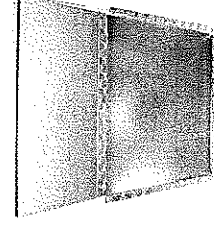

23AT
Transition Collar

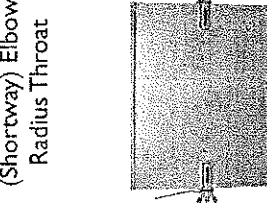

42
Volume Damper

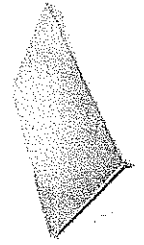

21
End Cap



23
Offset Collar

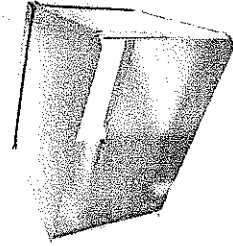

17
Trunk Transition
(tapered to one side)

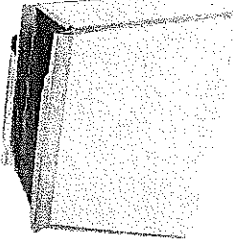

17C
Trunk Reducer
(tapered to center)

Duct Size	Plenum Opening
14 x 8	12 x 10
16 x 8	12 x 11
18 x 8	12 x 12
20 x 8	12 x 14
22 x 8	12 x 15
24 x 8	12 x 16
26 x 8	14 x 15
28 x 8	14 x 16
30 x 8	16 x 15
32 x 8	16 x 16

Duct Size	Plenum Opening
8 x 8	8 x 10
10 x 8	8 x 10
12 x 8	10 x 10
14 x 8	10 x 12
16 x 8	10 x 12
18 x 8	10 x 14
20 x 8	10 x 16
22 x 8	10 x 18
24 x 8	10 x 20
26 x 8	12 x 18
28 x 8	12 x 18
30 x 8	12 x 20
32 x 8	14 x 20

**TRUNK DUCT, FITTINGS, and
INSTALLATION ACCESSORIES**

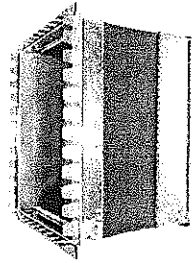

18
Connector
Plenum to Trunk

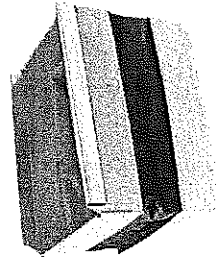

47
Connector
Furnace to Plenum

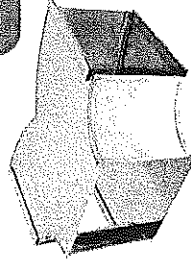

14TT
Trunk Tee

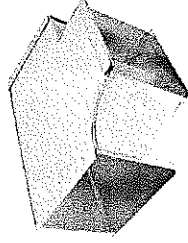

17TT
Trunk Tee

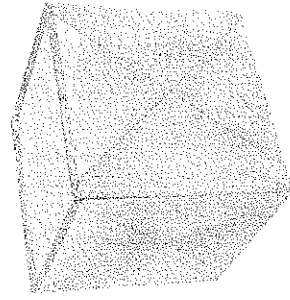

4
Plenum Chamber
• Custom Sizes
• Shipped knocked down
or made-up by request
• "B" style available with flange

ADJUSTABLE PLENUMS

Please note: Actual plenum height is 2" less than listed size.

TO INSTALL:

- 1) Cut raw edges of side panels to desired width and height.
- 2) Trim top to desired width and depth.
- 3) Assemble 3 sides, slide top into side panel pockets, then position fourth side.
- 4) To complete, secure assembly with sheet metal screws.

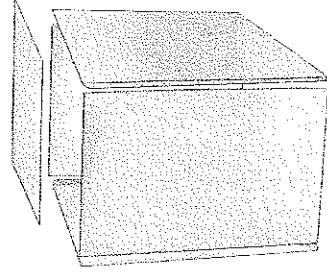

49T
Adjustable Plenum Top
49P
Adjustable Plenum Side
49C
Complete Adjustable Plenum

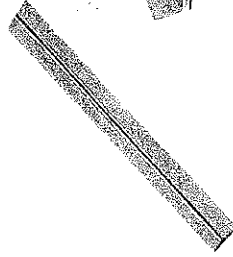

8D
Drive Cleat
8" and 10", available

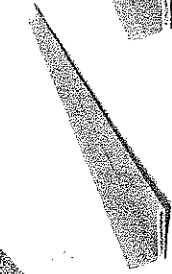

37
1/2" Leg
Rigid S-Cleat



135
1" Leg
Rigid S-Cleat



6S
S-Cleat
10" and 12" available

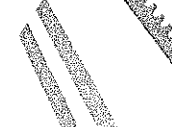

5
Duct Hanger

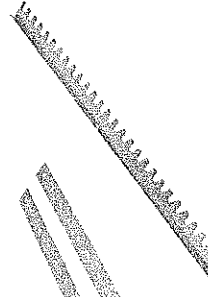

3
Fiberglass Extension

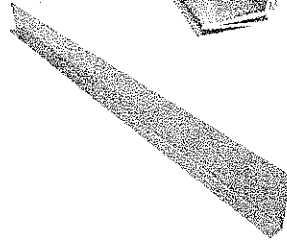

1106
Cold Air Frame

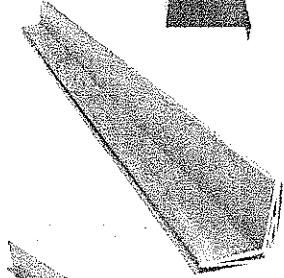

1112
Plenum Corner



133
Line Cover

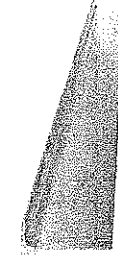

134
Can Stock



FR
Filter Rack

RETURN AIR PRODUCTS

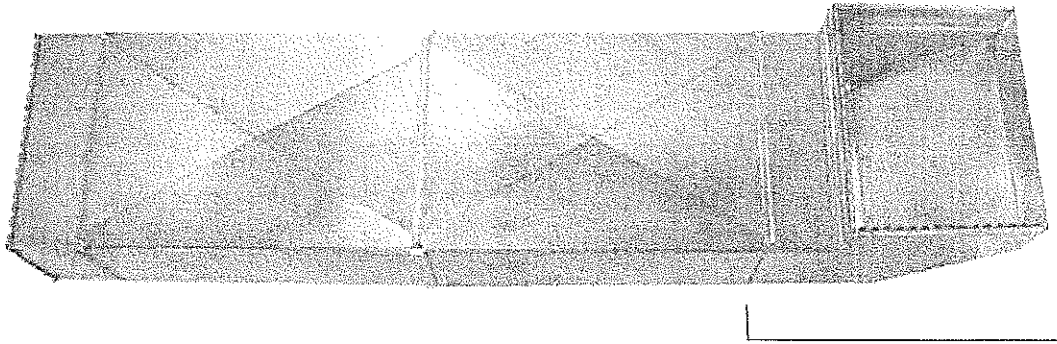

COLD AIR BOOT

Part No.	A	B	C	Return Duct Size
SB30	30"	20"	10"	8 x 24
SB38	38"	26"	15"	10 x 25
SBF30	30"	22"	15"	8 x 24
SBF32	32"	22"	15"	8 x 24
SBF36	36"	26"	15"	10 x 25
SBF38	38"	28"	15"	10 x 25

35
Trunk Reducer



35A
Trunk Reducer

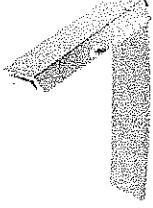

48
Panning Material

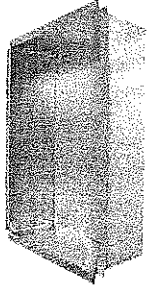

170
Return Air Pan

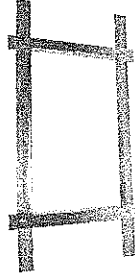

31
Return Air Frame

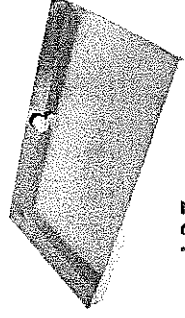

137
Drain Pan
3/4" Slip Fitting

RETURN AIR PACKAGE

Complete package consisting of:

- 1 - #20 Starting collar
- 2 - 30" duct sections
- 1 - return air plenum with 1" filter rack
- 6 - 10" drive straps

Shipped knocked down in one carton

Return Air Pkg	Duct Size Range	Boot Only
810	20x10 - 20x16	810B
811	25x10 - 25x16	811B
812	20x10 - 20x14	812B
813	25x10 - 25x14	813B
814	20x8 - 20x16	814B
815	24x8 - 24x16	815B
816	20x8 - 20x14	816B
817	24x8 - 24x14	817B

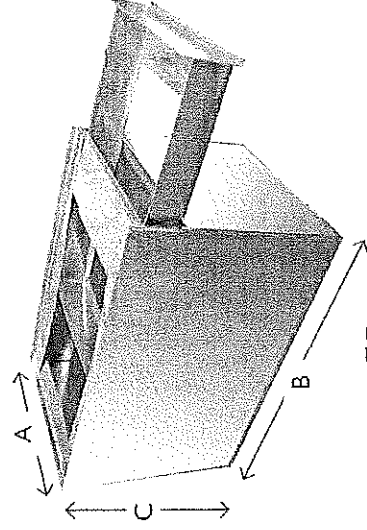

FB

Furnace Box with Filter Drawer
Also available with Hinged Door

Part No.	A	B	C	Filter Size
FB1428	14 1/4"	28 1/2"	18 1/2"	14x25
FB1728	17 1/4"	28 1/2"	18 1/2"	16x25
FB2128	21 1/4"	28 1/2"	18 1/2"	20x25
FB2428	24 1/4"	28 1/2"	18 1/2"	20x25

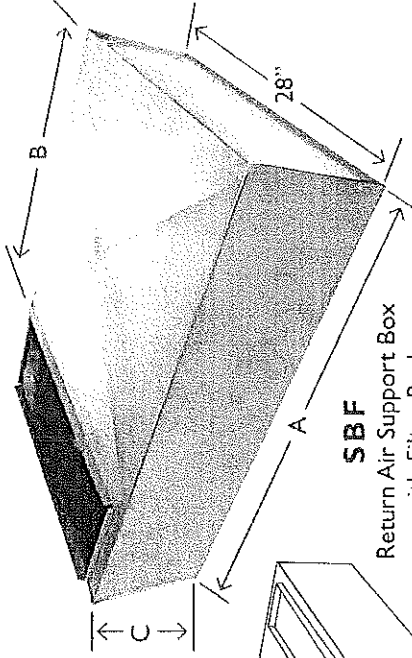

SB
Return Air Support Box

SBF

Return Air Support Box
with Filter Rack

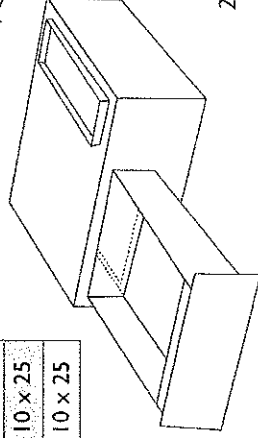

22 x 28 drawer accommodates
1", 4" and 5" 20x25 filters

OVAL PIPE and FITTINGS

OVAL PIPE

Pipe Size	Height	Circumference	Area	CFM Capacity at 10 I/W/C
5"	2 1/2"	15.7"	17.2 sq in	60 CFM
6"	2 7/8"	18.8"	22.2 sq in	78 CFM
7"	3"	22.0"	27.3 sq in	104 CFM
8"	3 1/16"	25.1"	32.2 sq in	190 CFM

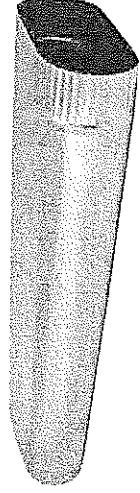

WALL STACK VS. OVAL PHYSICAL COMPARISON

<p>5" OVAL 3 1/2" X 8"</p>	<p>6" OVAL 3 1/2" X 10"</p>	<p>7" OVAL 3 1/2" X 12"</p>	<p>8" OVAL 3 1/2" X 14"</p>
--------------------------------	---------------------------------	---------------------------------	---------------------------------

All oval pipe is made from 30Ga galvanized steel.

- No. 160 60" Oval Pipe Joint
- No. 100 100" Oval Pipe Joint
- No. 112 112" Oval Pipe Joint
- No. 113 113" Oval Pipe Joint
- No. 114 114" Oval Pipe Joint

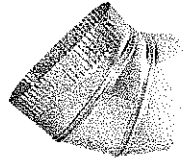

113
45° Flat
(Broadway)
Oval Angle



114
90° Flat
(Broadway)
Oval Elbow

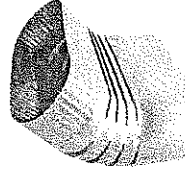

115
45° Vertical
(Shortway)
Oval Angle



116
90° Vertical
(Shortway)
Oval Elbow

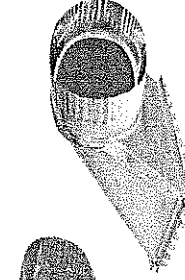

162
Top Oval
Takeoff

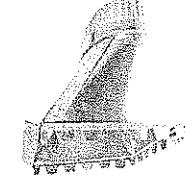

163
Side Oval
Takeoff

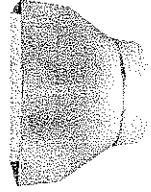

127R
Straight Oval
Register Boot

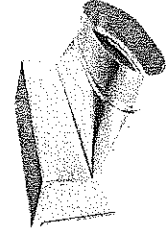

124R
90° Oval
Register Boot

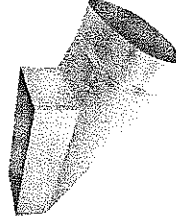

128R
End Oval
Register Boot

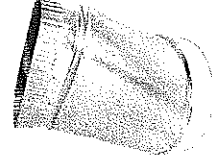

127
Oval to Round
Straight Boot



124
Oval to Round
90° Boot



128
Oval to Oval
Reverse Boot

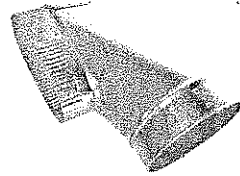

106
Oval to Round
Reverse Boot

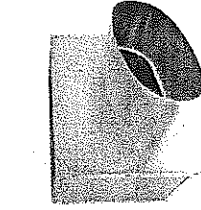

355
Straight Oval
Register Box

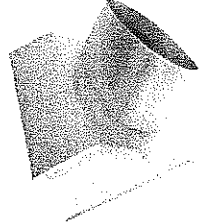

360
Angle Oval
Register Box

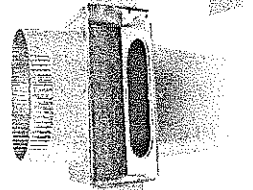

150
Oval Stackhead
with Collar



111
Register
Outlet

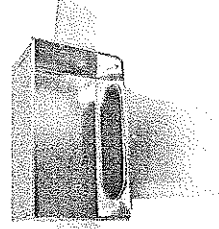

110
Oval
Stackhead

WALL STACK and FITTINGS

WALL STACK

Featuring:

- 12", 24", 30", 60", 96", 100" and 113" lengths available
- Two pieces per section
- Furnished in button snaplock
- No tools and no indentations, just snap it and it's closed!

STACKHEADS

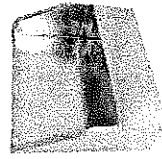

WS11
Projection
Stackhead

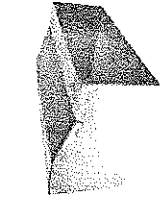

WS12
Horizontal
Stackhead

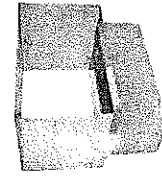

WS9
Double
Stackhead

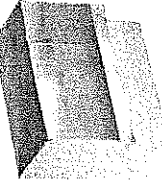

WS10
Stackhead

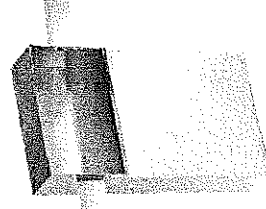

WS10X
Long Throat
Stackhead with Ears

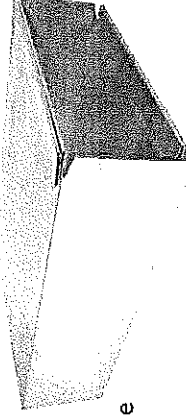

I32
Adjustable
"A" Adapter
Available in
2 1/4 x 10, or
2 1/4 x 12, or
2 1/4 x 14



I33
Adjustable
"B" Adapter
Available in
4x10 - 3 1/4x10, or
4x10 - 3 1/4x12, or
4x10 - 3 1/4x14

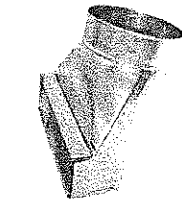

24
90° Stack Boot

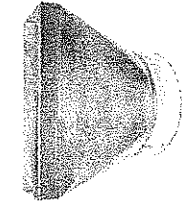

27
Straight
Stack Boot

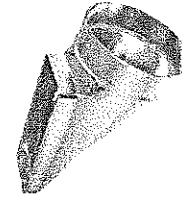

28
End Stack Boot

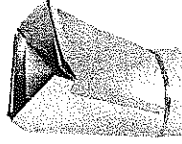

26
45° Stack Boot

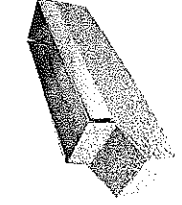

WS17
Stack Transition

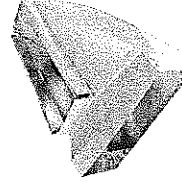

WS7C
Reverse Stack
Elbow (Center)



WS15
45° Vertical
(Shortway)
Stack Angle

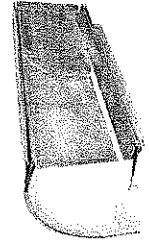

WS16
90° Vertical
(Shortway)
Stack Elbow

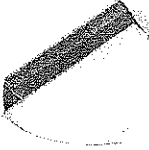

WS13
45° Flat
(Broadway)
Stack Angle



WS14
90° Flat
(Broadway)
Stack Elbow



WS20
Straight Stack
Collar

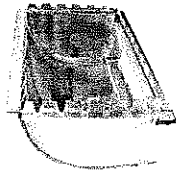

WS60
Top Stack
Takeoff

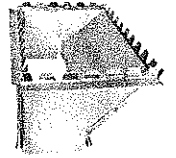

WS61
Side Stack
Takeoff



WS21
Stack
End Cap

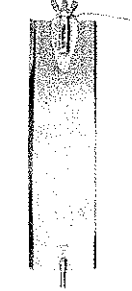

WS45
Stack Damper

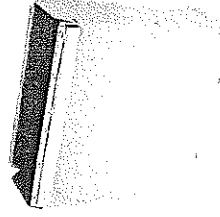

PHEXT
PH Extension
10" long

SHEET METAL COLLARS

SHEET METAL and DUCTBOARD COLLARS

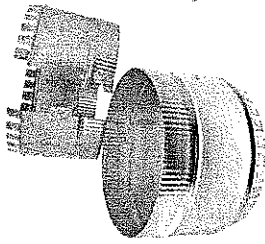

120SC
Snap Collar



97
Collar
97NC
No Crimp

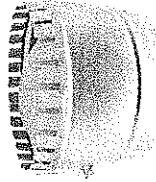

97LS
Long Collar
97LSWD
with Damper



1051
Collar
1050
No Crimp

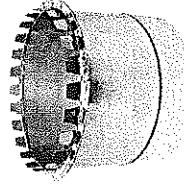

1150
Long Collar
1149
With Damper

SHEET METAL SPIN COLLARS



156
Spin Collar

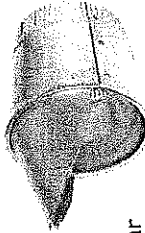

156S
Spin Collar
with Scoop



156D
Spin Collar
with Damper

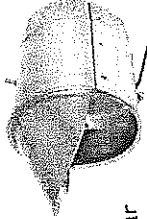

156SD
Spin Collar
with Scoop
and Damper

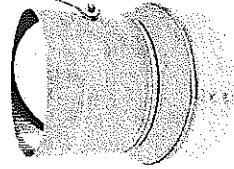

156BM
Bellmouth
Spin Collar



156DBM
with Damper



156SDBM
with Scoop and
Damper

DUCTBOARD SPIN COLLARS



97FG
Spin Collar



98
Spin Collar
with Scoop



97FGWD
Spin Collar
with Damper

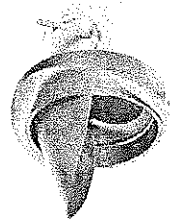

98WD
Spin Collar
with Scoop
and Damper

DUCTBOARD COLLARS

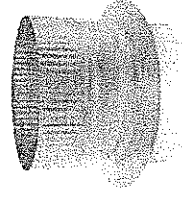

84ST
Ductboard Collar
84STWD
with Damper

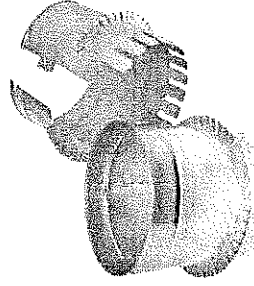

122SC
Snap Collar
1 1/2" or 2"
Ductboard

121SC
Snap Collar
1" or 1 1/2" Ductboard

**SHEET METAL and
DUCTBOARD TAKEOFFS**



62
Top Takeoff
(Metal)

Pipe Size	Base Opening
4"	4 x 6
5"	5 x 6
6"	6 x 6
7"	7 x 7
8"	8 x 8
9"	10 x 10
10"	10 x 10
12"	12 x 12
14"	14 x 14



62FG
Top Takeoff
(Ductboard)

Pipe Size	Base Opening
4"	4 x 6
5"	5 x 6
6"	6 x 6
7"	7 x 7
8"	8 x 8
9"	10 x 10
10"	11 1/2 x 10
12"	12 x 12
14"	14 x 14

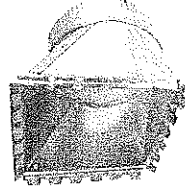

63
Side Takeoff
(Metal)

Pipe Size	Base Opening
4"	6 x 6
5"	6 x 6
6"	6 x 6
7"	6 x 8
8"	6 x 10
9"	7 x 12
10"	7 x 14
12"	8 x 18
14"	8 x 20
16"	10 x 21

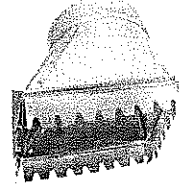

63FG
Side Takeoff
(Ductboard)

Pipe Size	Base Opening
4"	6 x 6
5"	6 x 6
6"	6 x 6
7"	6 x 8
8"	6 x 10
9"	7 x 12
10"	7 x 14
12"	8 x 18
14"	8 x 20

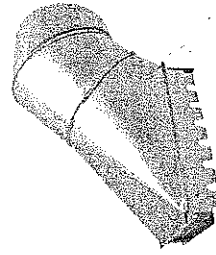

2016
Adjustable Takeoff
(Ductboard)

Pipe Size	Base Opening
4"	4 x 6
5"	5 x 6
6"	6 x 7
7"	7 x 8
8"	7 x 10
9"	9 x 11
10"	10 x 12
12"	12 x 16
14"	14 x 19

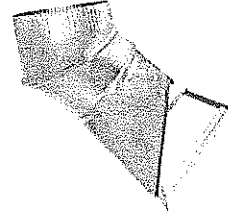

34PLF
Adjustable Takeoff
(Ductboard)

Pipe Size	Base Opening
5"	5 x 6
6"	6 3/8 x 6 3/8
7"	7 x 8
8"	6 3/8 x 10



63A
Adjustable Takeoff
(Metal)

Pipe Size	Base Opening
4"	4 x 6
5"	5 x 6
6"	6 x 7
7"	7 x 8
8"	7 x 10
9"	9 x 11
10"	10 x 12
12"	12 x 16
14"	14 x 19
16"	14 x 18
18"	18 x 18

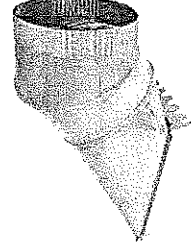

63AFG
Adjustable Takeoff
(Ductboard)

Pipe Size	Base Opening
4"	4 x 6
5"	5 x 6
6"	6 x 7
7"	7 x 8
8"	7 x 10
9"	9 x 11
10"	10 x 12
12"	12 x 16
14"	14 x 19

**SHEET METAL and
DUCTBOARD TAKEOFFS**

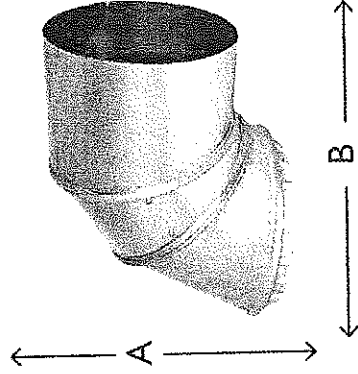

EP15
Full Tab Takeoff (Metal)

Pipe Size	Base Opening	A	B
4"	6 3/8"	7 1/4"	9 1/4"
5"	6 3/8"	7 1/4"	9 1/4"
6"	7"	7 1/2"	11"
7"	8"	8 1/2"	12 1/2"

Features 3/4" tabs, tapered collar, and no crimp.
1 7/8" rise when installed.

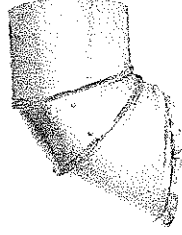

HT15
Half-Tab Takeoff
(Metal)

Pipe Size	Base Opening
4"	6 3/8"
5"	6 3/8"
6"	7"
7"	8"

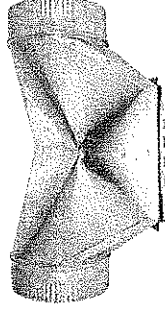

64
Double Top Takeoff
(Metal)

Pipe Size	Base Opening
5"	6 x 10
6"	7 x 10
7"	7 x 14
8"	8 x 14

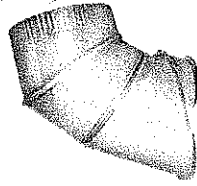

S5
Pivot Takeoff
(Metal)

Pipe Size	Base Opening
5"	6"
6"	7"
7"	8"

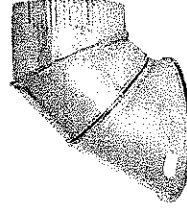

87
Lever Lock Takeoff
(Metal)

Pipe Size	Base Opening
5"	6"
6"	7"
7"	8"



2015
Round Takeoff
Elbow (Ductboard)

Pipe Size	Base Opening
5"	6"
6"	7"
7"	8"
8"	9"

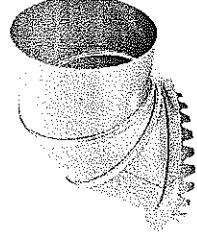

2022
Round Takeoff
(Ductboard)

Pipe Size	Base Opening
5"	6"
6"	7"
7"	8"
8"	9"

AIR-TITE TAKEOFFS

AIR-TITE TAKEOFFS

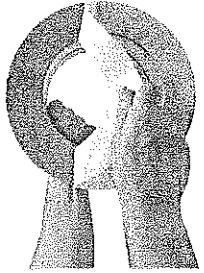

Featuring:

- 1 1/2" wide and 1/8" thick gasket, made with high tack adhesive-coated neoprene foam -- just peel and stick for easy installation
- Gasket includes 4 1/8" pre-drilled holes for sheet metal screws attachment
- RL-2 rivet seam (+/- 4" w.g.) with 1/2" overlap, using 1/8" rivets
- Dampers available for 1/4" and 3/8" square and round bearings; also available 3/8" continuous rod damper (by request)
- Damper fittings available with 1 1/2" or 2" standoffs (by request)

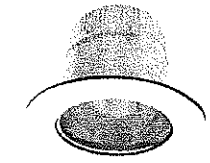

ATT
Airtite Takeoff

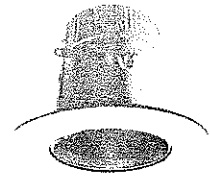

ATD
Airtite Takeoff
with Damper

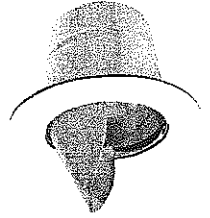

ATS
Airtite Takeoff
with Scoop

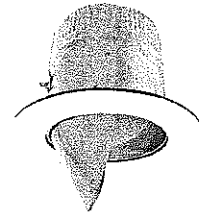

ATSD
Airtite Takeoff
with Scoop
and Damper



ATTRP
Round Pipe
Takeoff
ATDRP
with Damper

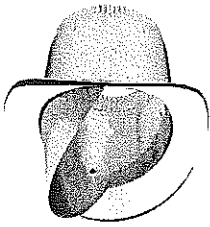

ATSRP
Round Pipe Takeoff
with Scoop
ATSDRP
with Scoop
and Damper

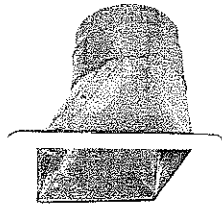

AT63
Rectangular
Airtite Takeoff
AT63WD
with Damper

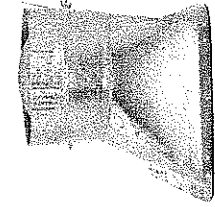

ATHE
High Efficiency
Airtite Takeoff
ATHEWD
with Damper

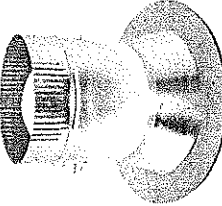

ATTBM
Bellmouth
Airtite Takeoff
ATDBM
with Damper

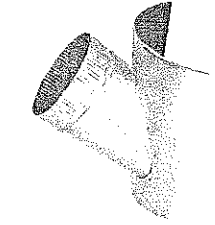

ATTRP45
45° Saddle
Airtite Takeoff

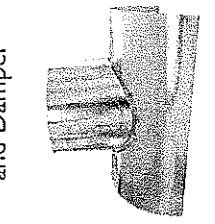

ATTRP90
90° Saddle
Airtite Takeoff

Pipe Size	Base-Opening
4"	6 x 6
5"	6 x 6
6"	6 x 6
7"	6 x 8
8"	6 x 10
9"	7 x 12
10"	7 x 14
12"	8 x 18
14"	8 x 20

Pipe Size	Base-Opening
4"	5 x 10
5"	5 x 10
6"	6 x 12
7"	6 x 12
8"	6 x 12
9"	6 x 15
10"	6 1/4 x 16
12"	8 1/2 x 18
14"	9 1/2 x 20
16"	14 x 22

Collar Size	Bellmouth Size
6"	8"
7"	9"
8"	10"
10"	12"
12"	14"
14"	16"
16"	18"



AT62
Airtite Top Takeoff
AT62WD
with Damper



AT63A
Adjustable
Airtite Takeoff

**TEES, WYES, REDUCERS
and ACCESSORIES**

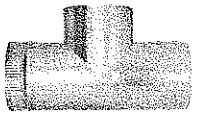

TEE

No. 53 24" Long
No. 54 15" Long
Available in
26Ga or 24Ga

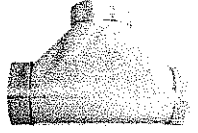

1060

Free Flow Tee
Available in 30Ga,
26Ga, and 24Ga



200

Trunk Tee



201

Straight-Thru Tee

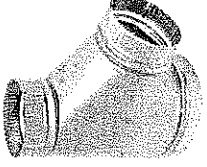

202

Reducing Tee

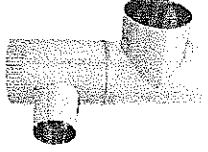

54SW

Swivel Tee

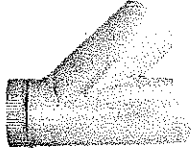

SMOKE WYE

No. 50 15" Long
No. 51 24" Long

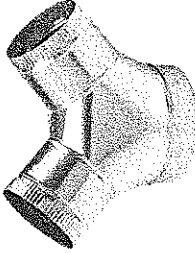

78

Wye Branch

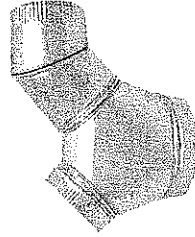

78-1

One-Way
Adjustable Wye

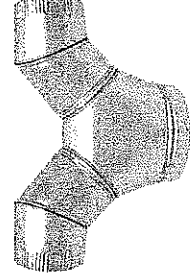

78-2

Two-Way
Adjustable Wye

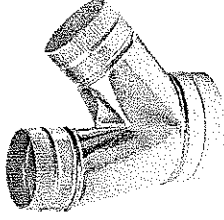

715

Splitter Wye



52

Flue Wye



203S

Stub Wye

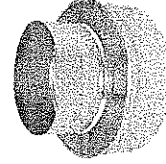

582

2 pc Reducer

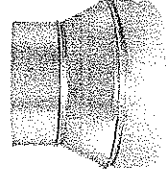

58

3 pc Reducer
Available Crimped

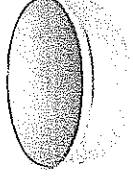

55

End Cap
Available Crimped,
With/Without Handle

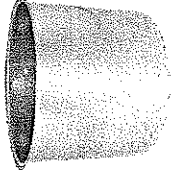

117

Flue Thimble

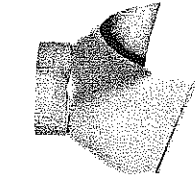

207QT

90° Saddle Tee

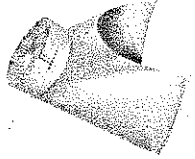

208QY

45° Saddle Wye

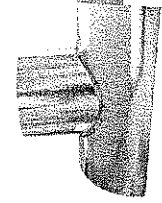

207

90° Vent Saddle

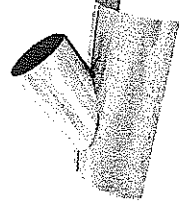

208

45° Vent Saddle

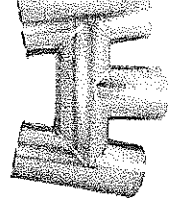

199

H-Vent

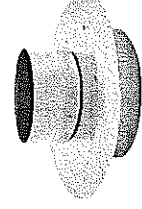

64FR

Flue Reducer

INSULATED CEILING BOXES and CRD BOOTS

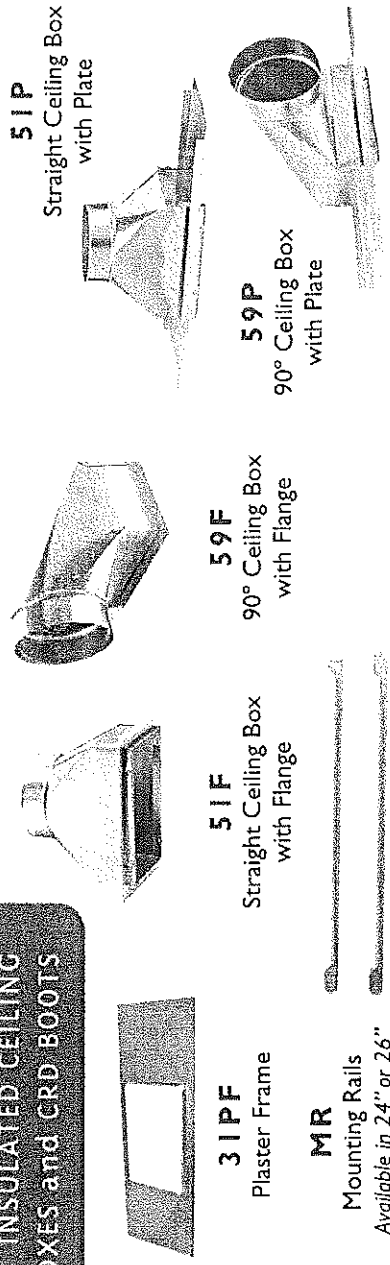

51P
Straight Ceiling Box
with Plate

51F
Straight Ceiling Box
with Flange

59P
90° Ceiling Box
with Plate

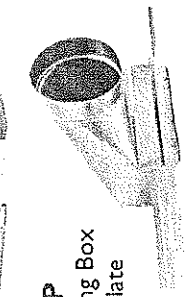

59F
90° Ceiling Box
with Flange



MR
Mounting Rails
Available in 24" or 26"

INSULATED CEILING BOXES

Liner is available in R4 (1"), R6 (1½"), or R8 (2") insulation.

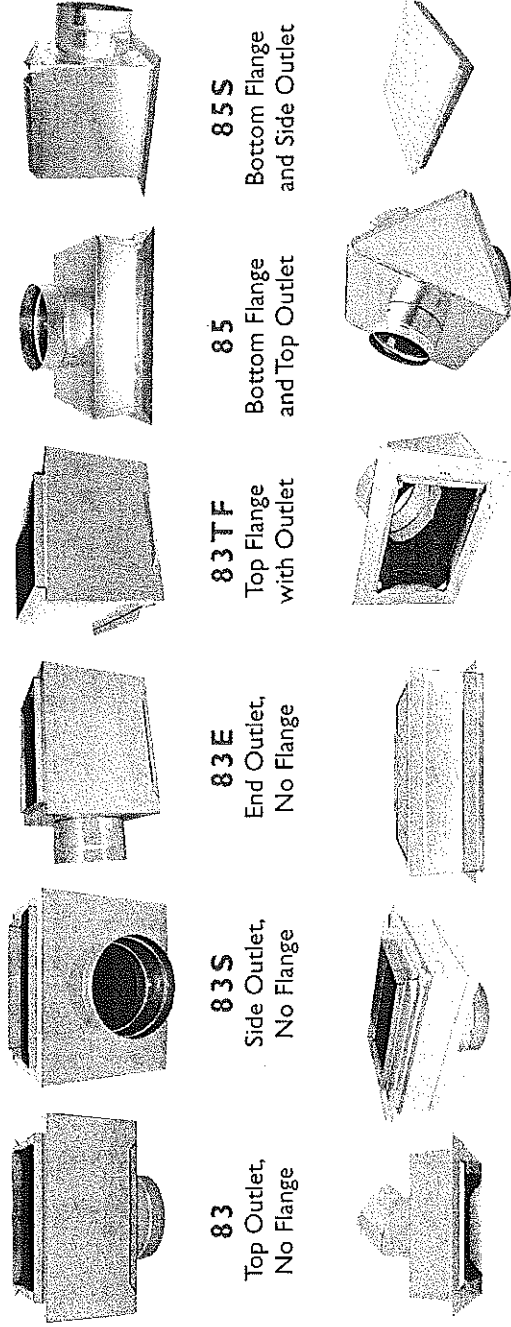

83
Top Outlet,
No Flange

83S
Side Outlet,
No Flange

83E
End Outlet,
No Flange

83TF
Top Flange
with Outlet

85
Bottom Flange
and Top Outlet

85S
Bottom Flange
and Side Outlet

85A
Bottom Flange,
Angle Attached

85DB
Bottom Flange
with Outlet
(Ductboard)

84DB
Bottom Flange
No Outlet
(Ductboard)

86
Slant Top
with Flange

577
Insulated Wye

577P
Insulated Wye
Panels

CEILING RADIATION DAMPER BOOTS

Boots are non-insulated. Features rectangular radiation damper, butterfly-type, UL Classified 555C (3-hr rating), 212° easy access fusible link. Damper is attached with matching rivets and mounting brackets on all four sides; position in throat varies fitting to fitting.



51CRD
Straight
CRD Boot

51FCRD
Straight
CRD Boot
with Flange

59CRD
90° CRD Boot

59FCRD
90° CRD Boot
with Flange

58CRD
Center End
CRD Boot

58FCRD
Center End
CRD Boot
with Flange

**REGISTER BOXES
and CEILING OUTLETS**



19RC
Register Collar



70
Register Takeoff



71
Register Tee



74
Register Cap



81
Ceiling Outlet
81D
with Damper

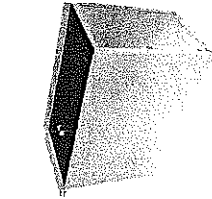

75
Register Box
7" Deep

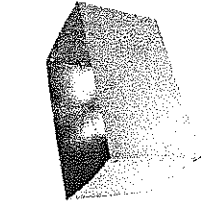

90
Floor Register Box
5" or 6" Deep

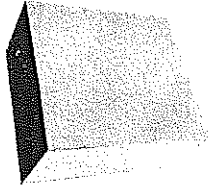

91
Floor Register Box
10" or 11" Deep

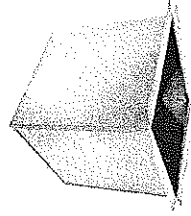

73
Square
Diffuser Box

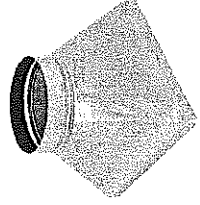

73C
Square to Round
Transition Outlet

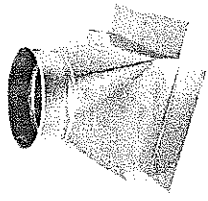

77
Square to Round
Diffuser Box

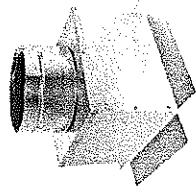

177
Ceiling Outlet

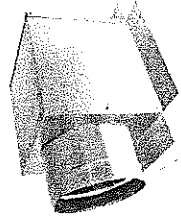

177S
Side Outlet

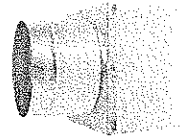

277
Square to Round
Diffuser Outlet,

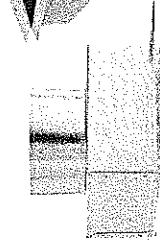

277F
Square to Round
Diffuser Outlet,
with Flange

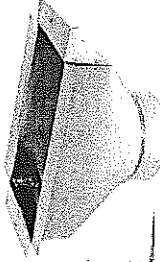

92
Funnel Register
Box with Flange

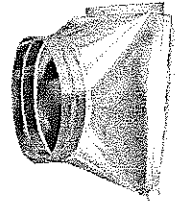

92B
Funnel Register Box
B-Box Style

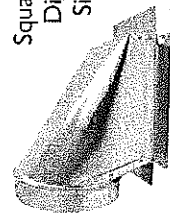

77S
Square to Round
Diffuser Box,
Side Outlet

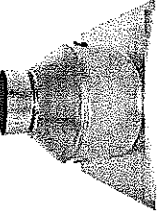

58WF
Diffuser Outlet
with Flange



72
Diffuser Tee

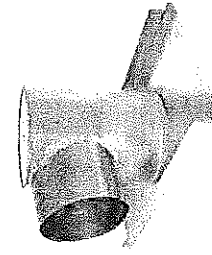

72WF
Diffuser Tee
with Flange

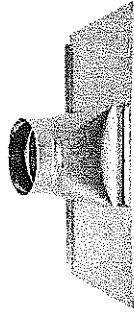

77WF
Diffuser Funnel with Flange

66WF
Ceiling Diffuser
Outlet

FURNACE FITTINGS and ACCESSORIES

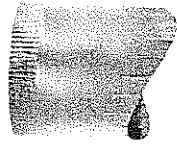

83PC
Branch
Connector

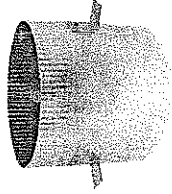

86SC
Sleeve
Connector

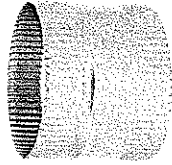

97FC
Flex
Connector

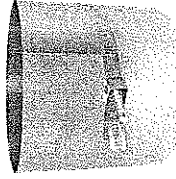

96
Drawband

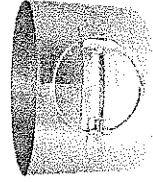

S75
Snap
Drawband

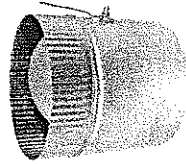

40
Damper
Section

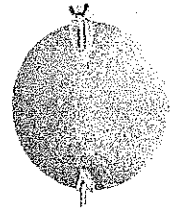

44
Two Quad
Damper

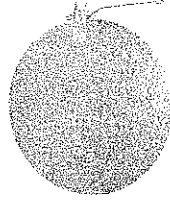

44S
Damper
Fixed Hardware

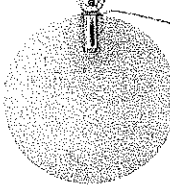

44-1
One Quad
Damper

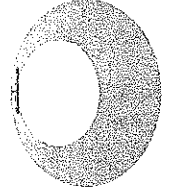

63FC
Ceiling Collar

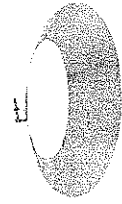

142
Storm Collar

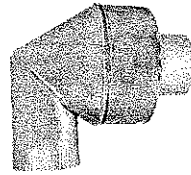

93
Elbow
Draft Vent

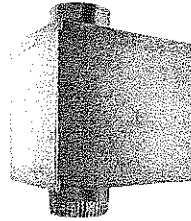

94
Horizontal
Draft Vent

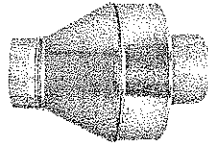

95
Vertical
Draft Vent



140
Adjustable
Roof Flashing

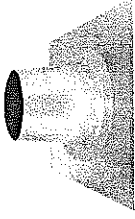

141
Tall Cone
Flashing



RJ
Roof Jack

WALL CAP

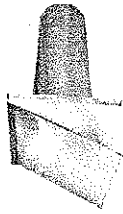

36
Wall Cap

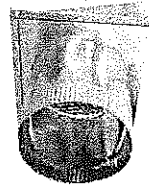

39
Wall Cap
with Damper

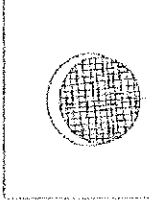

36AL
Aluminum Wall Cap

39AL
Aluminum Wall Cap
with Damper

Available with
and without 1/4"
galvanized wire
birdscreen mesh
covering interior
tube opening.

Mesh covering opening

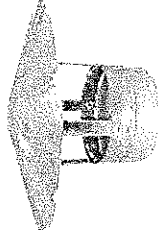

99
Chimney Cap

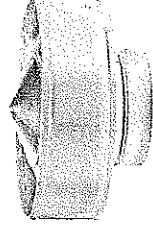

99A
Chimney Cap

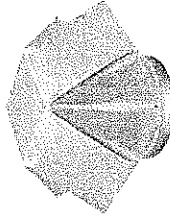

99VC
Vent Cap

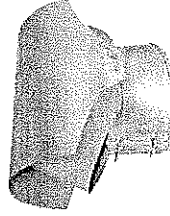

99LD
Lo-Draft Chimney Cap

**VENTING PRODUCTS
AND MOBILE HOME KITS**

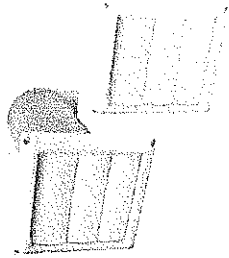

390WP
White Louver
Hood with Tail
Face Only

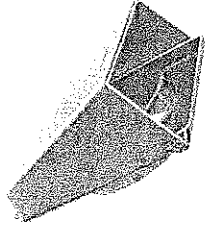

39GP
Gray Plastic Wall
Cap with Damper

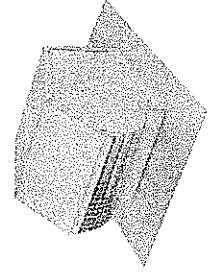

ROOF CAP
Aluminum with
Damper and Screen
No. 239 Fits 4" round
No. 240 Up to 7" round
No. 241 Up to 10" round

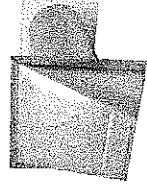

SVH
Aluminum
Vent Hood



201VH
Aluminum
Wall Cap



391WP
White Plastic
Face Only



SVHBP
Brown Plastic
Vent Hood

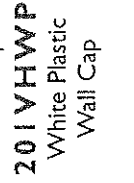

201VHWP
White Plastic
Wall Cap

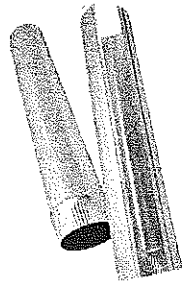

SAP
Aluminum
Snaplock Pipe



SAE
Aluminum
90° Elbow

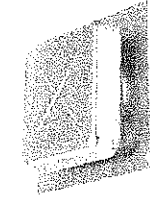

RV51
Aluminum Roof
Cap with Screen
Up to 8" Round

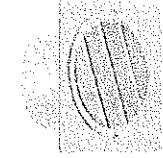

EVI41
Eave Vent

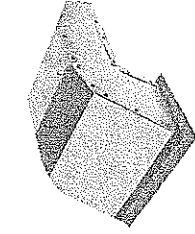

220EC
Eave Vent
with Grille



SPC
Pipe Clamp



SH
Flexible White
Vinyl Hose



MF
Flexible
Aluminum
Duct



SAL
Aluminum
Transition
Duct

MOBILE HOME KITS

SWK

Single Wide Kit

Includes:

- 1 - Return Air Box
- 1 - Butterfly Damper
- 1 - Floor Grille
- 1 - Panel Filter

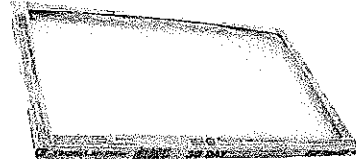

Panel Filter

DWK

Double Wide Kit

Includes:

- 1 - Return Air Box
- 2 - Butterfly Dampers
- 1 - 78 Wye Branch
- 1 - Floor Grille
- 1 - Panel Filter



Floor Grille

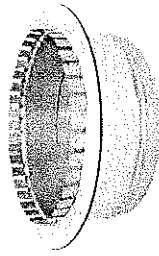

Butterfly Damper

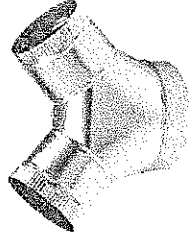

78
Wye Branch

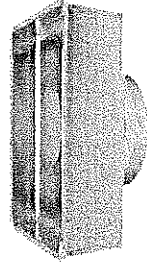

74
Return Air Box
Available as
6" Deep Box or
12" Deep Box

Kit sizes available:
12x20-12 Round, 12x20-14 Oval,
and 14x20-14 Round.

BLACK PIPE and FITTINGS

BLACK PIPE & FITTINGS:

- Available in 5", 6", 7", and 8" diameters
- 24 Gauge material, cold-rolled steel coils per ASTM A1008 CS-B (aiming 1/2 standard ASTM tolerances), skinpassed
- High heat black-painted with Valspar WPA0053 (.35 mil each side)
- Heat and rust resistant
- Standard packaging

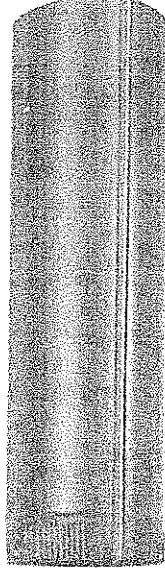

BP

Snaplock Pipe

Available in 12", 24", and 36" lengths

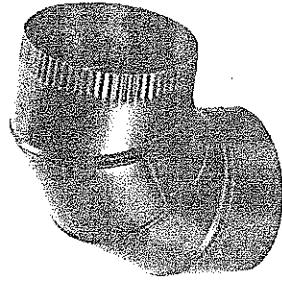

BP90

90° Adjustable Elbow

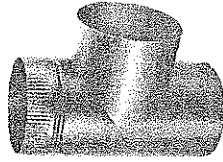

BP54

Tee

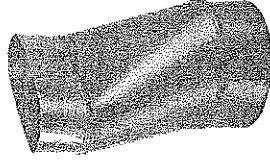

BP127

Oval to Round Adapter



BPCHAD

Chimney Adapter



BP55

End Cap

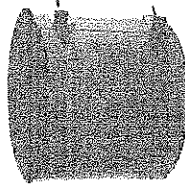

BP96

Drawband

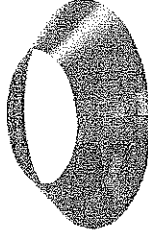

BPTC

Trim Collar

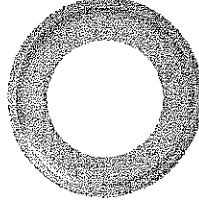

BPC

Pipe Collar

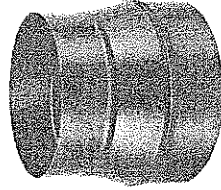

BP58

3 pc Reducer

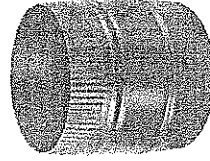

BPCON

Connector

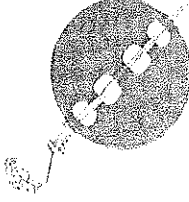

CID

Cast Iron Damper

SPIRAL PIPE and FITTINGS

SPIRAL PIPE & FITTINGS:

- 26 Ga and 24 Ga galvanized steel
- Also available in galvanized steel by request
- Low pressure fittings (+/- 4" w.g. pressure rating)
- Riveted connection
- Outside dimensions of each end diameter is approximately 1/8" under nominal size

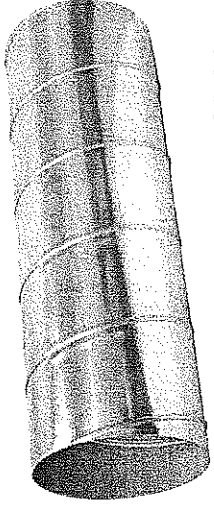

SP10
Spiral Pipe

- Featuring:*
- 10 ft lengths
 - Available in 4" - 24" diameters
 - RL-1 spiral lock seam
 - Available in 26Ga and 24Ga

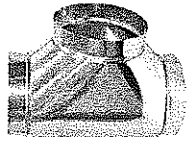

SP54
Tee Joint



SP55
End Cap

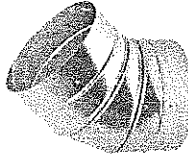

SP45
45° Angle

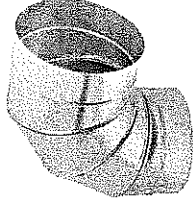

SP90
90° Adjustable
Elbow



SP90LR
Long Radius
90° Elbow



SP58
Tapered Reducer

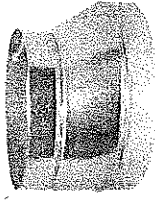

SP58ER
Eccentric Reducer



SP6
90° Shoe Tap

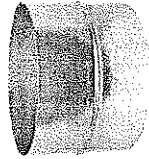

SPCON
Connector

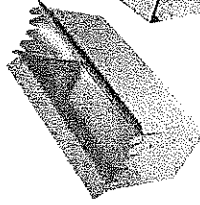

SP70
Register Saddle

Diameter	Bend Radius
4"	3"
5"	3 3/4"
6"	4 1/2"
7"	5 1/4"
8"	6"
10"	7 1/2"
12"	9"
14"	10 1/2"
16"	12"
18"	13 1/2"
20"	15"
22"	16 1/2"
24"	18"

Diameter	Bend Radius
4"	6"
5"	7 1/2"
6"	9"
7"	10 1/2"
8"	12"
10"	15"
12"	18"
14"	21"
16"	24"
18"	27"
20"	30"
22"	33"
24"	36"

PRODUCT INDEX

Item No.	Product Name	Page	Item No.	Product Name	Page
3	Fiberglass Extension	4	49C	Adjustable Plenum (Complete)	4
4	Plenum Chamber	4	49P	Adjustable Plenum Panel	4
5	Duct Hanger	4	49T	Adjustable Plenum Top	4
6S	S-Cleat	4	50	Wye - 15" Long	12
8D	Drive Cleat	4	51	Wye - 24" Long	12
13	Flat Trunk 45° Angle	3	51CRD	Straight CRD Boot	13
14	Flat Trunk 90° Elbow	3	51F	Straight Ceiling Box	13
14TT	Trunk Tee	4	51FCRD	Straight CRD Boot w/ Flange	13
15	Vertical Trunk 45° Angle	3	51P	Straight Ceiling Box w/ Plate	13
16	Vertical Trunk 90° Elbow	3	52	Flue Wye	12
17	Trunk Transition	3	53	Tee - 24" Long	12
17C	Trunk Transition (center)	3	54	Tee - 15" Long	12
17CR	Adjustable Register Boot	2	54SW	Swivel Tee	12
17TT	Trunk Tee	4	55	Tee Cap	12
18	Connector- Plenum to Trunk	4	58	3-pc Reducer	12
19RC	Register Collar	14	58CRD	End CRD Boot	13
20	Trunk Straight Collar	3	58FCRD	End CRD Boot w/ Flange	13
21	Trunk End Cap	3	58WF	Diffuser Outlet w/ Flange	14
23	Trunk Offset Collar	3	59CRD	90° CRD Boot	13
23AT	Trunk Transition Collar	3	59F	90° Ceiling Box	13
24	90° Stack Boot	7	59FCRD	90° CRD Boot w/ Flange	13
24R	90° Register Boot	2	59P	90° Ceiling Box w/ Plate	13
26	Angle Stack Boot	7	62	Top Takeoff (Metal)	9
26R	45° Register Boot	2	62FG	Top Takeoff (Ductboard)	9
27	Straight Stack Boot	7	63	Side Takeoff (Metal)	9
27R	Straight Register Boot	2	63A	Adjustable Takeoff (Metal)	9
28	End Stack Boot	7	63AFG	Adjustable Takeoff (Ductboard)	9
28R	End Register Boot	2	63FC	Ceiling Collar	15
29RO	Offset Register Boot	2	63FG	Side Takeoff (Ductboard)	9
31	Return Air Frame	5	64	Double Top Takeoff (Metal)	10
31PF	Plaster Frame	13	64FR	Flue Reducer	12
34PLF	Adj. Takeoff Fiberglass	9	66WF	Ceiling Diffuser Outlet	14
35	Trunk Reducer	5	70	Register Takeoff	14
35A	Trunk Reducer	5	71	Register Tee	14
36	Fresh Air Intake	15	72	Diffuser Tee	14
37	Rigid S-Cleat	4	72WF	Diffuser Tee w/ Flange	14
39	Galvanized Vent Hood	15	73	Square Diffuser Box	14
39AL	Alum Wall Cap w/Damper	15	73C	Sq to Rd Transition Outlet	14
39GP	Gray Plastic Wall Cap	16	74	Register Cap	14
39WP	White Plastic Wall Cap	16	74	Return Air Box	16
40	Damper Section	15	75	Register Box - 7" Deep	14
42	Trunk Volume Damper	3	77	Sq to Rd Diffuser Box	14
44	Round Damper	15	77S	Sq to Rd Diff. Box, Side Outlet	14
44-I	One Quad Damper	15	77WF	Diffuser Funnel w/ Flange	14
44S	Rd Damper- Fixed Hardware	15	78	Wye Branch	12
45	45° Adjustable Angle	2	78-1	One Way Adjustable Wye	12
47	Connector- Furnace to Plenum	4	78-2	Two Way Adjustable Wye	12
48	Panning Material	5	81	Ceiling Outlet	14
			81D	Ceiling Outlet w/ Damper	14
			83	Insul. Ceiling Box, Top Outlet	13
			83E	Insul. Ceiling Box, End Outlet	13
			83PC	Branch Connector	15
			83S	Insul. Ceiling Box, Side Outlet	13
			83TF	Insul. Ceiling Box, Top Flange	13
			84DB	Insul. Ceiling Box (Ductboard)	13
			84ST	Ductboard Collar	8
			84STWD	Ductboard Collar w/ Damper	8
			85	Insul. Ceiling Box, Top Outlet	13
			85A	Insul. Ceiling Box, Angle	13
			85DB	Insul. Ceiling Box (Ductboard)	13
			85S	Insul. Ceiling Box, Side Outlet	13
			86	Insul. Ceiling Box, Slant Top	13
			86SC	Sleeve Connector	15
			87	Lever Takeoff (Metal)	10
			90	90° Adjustable Elbow	2
			90	Floor Register Box - 6" Deep	14
			91	Floor Register Box - 10" Deep	14
			92	Funnel Register Box	14
			92B	Funnel Register Box (B-Style)	14
			93	Elbow Draft Vent	15
			94	Horizontal Draft Vent	15
			95	Vertical Draft Vent	15
			96	Drawband	15
			97	Flat Collar	8
			97FC	Flex Connector	15
			97FG	Spin Collar (Ductboard)	8
			97FGWD	Spin Collar (DB) w/ Damper	8
			97LS	Long Collar	8
			97LSWD	Long Collar w/ Damper	8
			98	Spin Collar (DB) w/ Scoop	8
			98WVD	Spin Collar (DB) w/ Scoop/Damp.	8
			99	Chimney Cap	15
			99A	Chimney Cap	15
			99LD	Lo-Draft Chimney Cap	15
			99VC	Vent Cap	15
			100	Oval Pipe - 100"	6
			106	Rd to Oval Reverse Boot	6
			110	Oval Stackhead	6
			111	Register Outlet	6
			113	Flat Oval 45° Angle	6
			114	Flat Oval 90° Elbow	6
			115	Vertical Oval 45° Angle	6
			116	Vertical Oval 90° Elbow	6
			117	Flue Thimble	12
			120SC	Snap Collar	8
			121SC	Snap Collar (Ductboard)	8
			122SC	Snap Collar (Ductboard)	8
			124	Rd to Oval 90° Boot	6
			124R	Oval 90° Register Boot	8
			127	Rd to Oval Straight Boot	6
			127R	Oval Straight Register Boot	6
			128	Oval to Oval Reverse Boot	6

PRODUCT INDEX

Item No.	Product Name	Qty	Item No.	Product Name	Page
128R	Oval End Register Boot	6	1050	Collar, No Crimp	8
132	"A" Adapter	6	1051	Collar	8
133	"B" Adapter	6	1060	Free Flow Tee	12
133	Line Cover	7	1106	Cold Air Frame	4
134	Can Stock	7	1109	Transition Collar	3
135	Rigid S-Cleat (1" Leg)	4	1112	Plenum Corner	4
137	Drain Pan	5	1149	Long Collar w/ Damper	8
140	Adjustable Roof Flashing	15	1150	Long Collar	8
141	Tail Cone Flashing	15	2015	Rd Takeoff Elbow (Ductboard)	10
142	Storm Collar	15	2016	Adjustable Takeoff (Ductboard)	9
150	Oval Stackhead w/ Collar	15	2022	Round Takeoff (Ductboard)	10
156	Spin Collar	15	AT62	Air-Tite Top Takeoff	11
156BM	Bellmouth Spin Collar	6	AT62WD	Air-Tite Top Takeoff w/ Damper	11
156D	Spin Collar w/ Damper	8	AT63	Rectangular Air-Tite Takeoff	11
156SDBM	Bm. Spin Collar w/Scoop/Damp	8	AT63A	Adjustable Air-Tite Takeoff	11
156DBM	Bellmouth Spin Collar w/ Damper	8	AT63WD	Rect. Air-Tite Takeoff w/ Damper	11
156S	Spin Collar w/Scoop	8	ATD	Air-Tite Takeoff w/ Damper	11
156SD	Spin Collar w/Scoop/Damper	8	ATDBM	Bellmouth AT Takeoff w/ Damper	11
156SDBM	Bm. Spin Collar w/Scoop/Damp	8	ATDRP	Rd Pipe AT Takeoff w/ Damper	11
160	Oval Pipe - 60"	8	ATHE	High Efficiency Air-Tite Takeoff	11
162	Oval Top Takeoff	8	ATHEWD	High Eff AT Takeoff w/Damper	11
163	Oval Side Takeoff	6	ATS	Air-Tite Takeoff w/ Scoop	11
170	Return Air Pan	6	ATSD	Air-Tite Takeoff w/ Scoop/Damp	11
177	Ceiling Outlet	6	ATSRP	Rd Pipe AT Takeoff w/ Scoop	11
177S	Ceiling Side Outlet	5	ATSDRP	Rd Pipe AT T/O w/Scoop/Damp	11
199	H-Vent	14	ATT	Air-Tite Takeoff	11
200	Trunk Tee	12	ATBDM	Bellmouth Air-Tite Takeoff	11
201	Straight Thru Tee	12	ATTRP	Round Pipe Takeoff	11
201YH	Aluminum Wall Vent	12	ATTRP45	45° Saddle Air-Tite Takeoff	11
201YHWP	White Plastic Vent	12	ATTRP90	90° Saddle Air-Tite Takeoff	11
202	Reducing Tee	16	BP24	Black Pipe - 24"	17
203S	Stub Wye	12	BP54	Black Tee	17
207	90° Vent Saddle	12	BP55	Black End Cap	17
207QT	Quick Tee 90°	12	BP58	Black 3-pc Reducer	17
208	45° Vent Saddle	12	BP90	Black 90° Elbow	17
208QT	Quick Wye 45°	12	BP96	Black Drawband	17
220EC	Eave Vent	12	BPI27	Black Oval to Rd Adapter	17
239	Alum. Roof Cap w/ Damper	12	BPC	Black Pipe Collar	17
240	Alum. Roof Cap w/ Damper	16	BPGHAD	Black Chimney Adapter	17
241	Alum. Roof Cap w/ Damper	16	BPCON	Black Connector	17
277	Ceiling Outlet, No Flange	14	BPTC	Black Trim Collar	17
277F	Sq to Rd Outlet w/ Flange	14	CID	Cast Iron Damper	17
355	Oval Straight Register Box	6	DWK	Double Wide Mobile Home Kit	16
360	Oval Angle Register Box	6	EPI5	Full Tab Takeoff (Metal)	10
390WP	White Louver Hood w/ Tail	16	EVI41	Eave Vent	16
391WVP	White Louver Hood	16	FB	Furnace Box	5
577	Insulated Wye	13	FR	Filter Rack	4
577P	Insulated Wye Panel	13	HT15	Half Tab Takeoff (Metal)	10
582	2-pc Reducer	12	MF	Aluminum Flexible Duct	16
810-817	Return Air Package	5	MUI20	Conductor Pipe	2
810B-817B	Cold Air Boot	5	MR	Mounting Rails	13

Item No.	Product Name	Page
PH5	90° Basement Boot	2
PHEXT	PH Extension	7
RV51	Alum Roof Cap - 8" Opening	16
S5	Pivot Takeoff (Metal)	10
S75	Snap Drawband	15
SAE	Aluminum Elbow	16
SAL	Aluminum Transition Duct	16
SAP	Aluminum Pipe	16
SB	Support Box	5
SBF	Support Box w/ Filter Rack	5
SH	White Flexible Vinyl Hose	16
SL	Snaplock Pipe	2
SP6	Spiral 90° Shoe Tap	18
SP10	Spiral Pipe	18
SP45	Spiral 45° Angle	18
SP54	Spiral Tee	18
SP55	Spiral End Cap	18
SP58	Spiral Tapered Reducer	18
SP58ER	Spiral Eccentric Reducer	18
SP70	Spiral Register Saddle	18
SP90	Spiral 90° Elbow	18
SP90LR	Spiral Long Radius 90° Elbow	18
SPC	Pipe Clamp	16
SYH	Aluminum Vent Hood	16
SYHBP	Brown Plastic Vent Hood	16
SYHWP	White Plastic Vent Hood	16
SWK	Single Wide Mobile Home Kit	16
TD	Trunk Duct	3
WSJ	Wallstack	7
WS7C	Center Reverse Stack Elbow	7
WS9	Double Stackhead	7
WS10	Stackhead	7
WS10X	Long Throat SH w/ Ears	7
WS11	Projection Stackhead	7
WS12	Horizontal Stackhead	7
WS13	Flat Stack 45° Angle	7
WS14	Flat Stack 90° Elbow	7
WS15	Vertical Stack 45° Angle	7
WS16	Vertical Stack 90° Elbow	7
WS17	Stack Transition	7
WS20	Straight Stack Collar	7
WS21	Stack End Cap	7
WS45	Stack Damper	7
WS60	Stack Top Takeoff	7
WS61	Stack Side Takeoff	7

TECHNICAL INFORMATION

EQUIVALENT LENGTHS	
PLENUM/DUCT FITTINGS	
No. 23 Offset starting collar	10' EL
No. 20 Straight starting collar	35' EL
No. 120SC Snap collar, round	35' EL
ROUND ELBOWS & ANGLES	
90° elbows	30' EL
45° angles	10 - 20' EL
REGISTER BOOTS	
No. 24R 90° register boot	30' EL
No. 27R Straight register boot	5' EL
No. 28R End register boot	50' EL
ROUND FITTINGS (TAKEOFFS)	
No. 97 Round starting collar	35' EL
No. 63 Square to round straight	20' EL
No. 63A Square to round adj. side takeoff	50' EL
No. 62 Square to round top takeoff	50' EL
No. 55 Round to round (adjustable)	50' EL
No. 65 Round to round	50' EL
DUCT ELBOWS, RADIUS THROAT	
No. 14 Up to 11"	10' EL
12" to 21"	15' EL
22" to 27"	20' EL
28" to 33"	25' EL
DUCT ELBOWS, SQUARE THROAT	
No. 16S Up to 11"	40' EL
12" to 15"	55' EL
16" to 21"	75' EL
22" to 27"	100' EL
28" to 33"	125' EL
RETURN AIR SYSTEM	
No. 810 Cold air boot, collar, duct	45- 65' EL

SIZING REQUIREMENTS

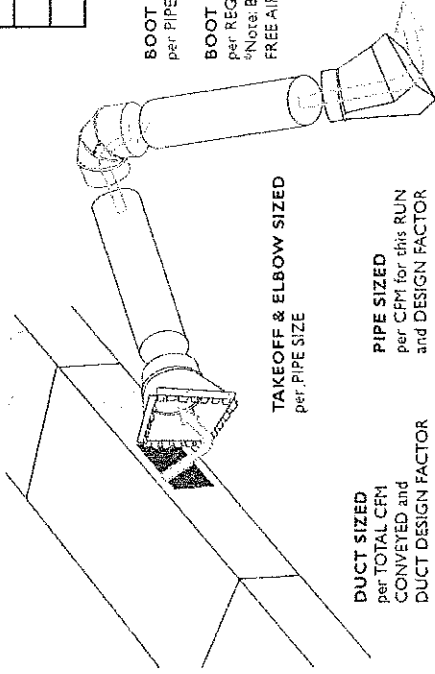

DUCT SIZED
per TOTAL CFM
CONVEYED and
DUCT DESIGN FACTOR

TAKEOFF & ELBOW SIZED
per PIPE SIZE

REGISTER SIZED
per CFM for this RUN
and DESIGN FACTOR

¹ ASP x 100
TOTAL EQ. LENGTH

BOOT COLLAR SIZED
per PIPE SIZE

BOOT OPENING SIZED
per REGISTER SIZE²
²Note: Boot sized LARGER than
FREE AIR, OPENING of register

REGISTER SIZED
per STYLE, SPREAD THROW
and FREE AREA of register and
CFM requirement

SMACNA Gauge Requirements for Galvanized Steel

Duct Diameter	2" wg. max Positive Pressure	Duct Diameter	2" wg. max Negative Pressure
3" - 8"	28 Ga	6" - 10"	28 Ga
9" - 14"	26 Ga	12"	26 Ga
15" - 26"	24 Ga	14" - 16"	24 Ga
		18" - 20"	22 Ga
		22" - 26"	20 Ga

From: SMACNA HVAC Duct Construction Standards Metal and Flexible, 2nd Ed (1995), 3.3 & 3.8

CFM	Boots (No. EL)	Capacity (CFM)	
		Boots	Capacity
50	5"	8 x 6	
75	5"	8 x 6	
100	6"	8 x 6	3 1/2 x 10 (110)
125	6"	8 x 6	3 1/2 x 12 (140)
150	7"	8 x 6	3 1/2 x 14 (160)
175	7"	8 x 6	
200	7"	8 x 6	
250	8"	6 x 10	8 x 8 6 x 12
300	9"	6 x 10	8 x 8 6 x 12
350	9"	6 x 10	8 x 8 6 x 12
400	9"	8 x 10	8 x 8 6 x 12
500	10"	10 x 10	12 x 8 8 x 12
600	12"	10 x 10	12 x 8 8 x 12
700	12"	12 x 10	14 x 8 10 x 12
800	12"	12 x 10	16 x 8 10 x 12
900	14"	14 x 10	18 x 8 12 x 12
1,000	14"	14 x 10	18 x 8 12 x 12
1,200	14"	16 x 10	24 x 8 14 x 12
1,400	16"	18 x 10	24 x 8 16 x 12
1,600	16"	20 x 10	28 x 8 18 x 12
1,800	16"	24 x 10	30 x 8 20 x 12
2,000	18"	26 x 10	32 x 8 20 x 12
2,500	18"	30 x 10	20 x 14 24 x 12
3,000	20"	36 x 10	24 x 14 28 x 12
3,500	22"	40 x 10	28 x 14 32 x 12
4,000	24"	26 x 16	32 x 14 38 x 12

8" Joist - 375 CFM; 10" Joist - 525 CFM (return only)

ADJUSTMENT OF DUCT DESIGN PRESSURE (RATE) FOR EQUIVALENT LENGTHS

Total Effective Length (Feet)	.05	.06	.08	.10	.125	.14	.16	.18	.20	.25	.30	.34	.375	.40	.50	.625	.75	1.00
35 - 44	.13	.15	.20	.25	.32	.35	.40	.45	.50	.63	.75	.85	.95	1.00	1.25	1.50	1.90	2.54
45 - 54	.10	.12	.16	.20	.25	.28	.32	.36	.40	.50	.60	.68	.76	.80	1.00	1.26	1.52	2.02
55 - 64	.08	.10	.13	.17	.21	.23	.27	.30	.33	.42	.50	.57	.63	.67	.83	1.05	1.26	1.68
65 - 74	.07	.09	.11	.14	.18	.20	.23	.26	.29	.36	.43	.49	.54	.57	.72	.90	1.08	1.44
75 - 84	.06	.08	.10	.13	.16	.18	.20	.23	.25	.31	.38	.43	.47	.50	.63	.79	.94	1.26
85 - 94	.06	.07	.09	.11	.14	.16	.18	.20	.22	.28	.33	.38	.42	.45	.56	.70	.84	1.12
95 - 104	.05	.06	.08	.10	.13	.14	.16	.18	.20	.25	.30	.33	.38	.40	.50	.63	.75	1.01
105 - 114	.05	.05	.07	.09	.11	.13	.15	.16	.18	.23	.28	.31	.34	.37	.47	.57	.69	.91
115 - 129	.04	.05	.07	.08	.10	.12	.13	.15	.17	.21	.25	.28	.31	.33	.46	.51	.62	.82
130 - 149	.04	.04	.06	.07	.09	.10	.11	.13	.14	.18	.21	.24	.27	.29	.36	.45	.54	.72
150 - 169	.03	.04	.05	.06	.08	.09	.10	.11	.13	.16	.19	.21	.24	.25	.31	.39	.47	.63
170 - 189	.03	.03	.04	.06	.07	.08	.09	.10	.11	.14	.17	.19	.21	.22	.28	.35	.42	.56
190 - 214	.03	.03	.04	.05	.06	.07	.08	.09	.10	.13	.15	.17	.19	.20	.25	.31	.37	.50
215 - 239	.02	.03	.04	.05	.05	.06	.07	.08	.09	.11	.13	.15	.17	.18	.22	.28	.33	.44
240 - 264	.02	.02	.03	.04	.05	.06	.06	.07	.08	.10	.12	.14	.15	.16	.20	.25	.30	.40
265 - 289	.02	.02	.03	.04	.04	.05	.06	.07	.07	.09	.11	.12	.14	.15	.18	.23	.27	.36
290 - 324	.02	.02	.03	.03	.04	.05	.05	.06	.07	.08	.10	.11	.12	.13	.17	.20	.24	.33
325 - 374	.02	.02	.02	.03	.04	.04	.05	.05	.06	.07	.09	.10	.11	.11	.14	.18	.21	.29
375 - 424	.01	.02	.02	.03	.03	.04	.04	.05	.05	.06	.08	.09	.09	.10	.13	.16	.19	.25
425 - 474	.01	.01	.02	.03	.03	.03	.04	.04	.05	.06	.07	.08	.08	.09	.11	.14	.17	.22
475 - 524	.01	.01	.02	.02	.03	.03	.03	.04	.04	.05	.06	.07	.07	.08	.10	.13	.15	.20
525 - 574	.01	.01	.02	.02	.02	.03	.03	.03	.04	.05	.06	.07	.07	.07	.09	.11	.14	.18
575 - 625	.01	.01	.01	.02	.02	.02	.03	.03	.03	.04	.05	.06	.06	.07	.08	.10	.13	.17

FORMULAS

Sensible Heat Formula

$$BTU/Hour = CFM \times TD \times 1.1$$

$$CFM = \frac{BTU/Hour}{1.1 \times TD \times ACF}$$

1.1 is a conversion factor

TD is the Temperature Difference created by the appliance

ACF is the Altitude Correction Factor (see above table)

Altitude Correction Factor (ACF)

0 ft	1.0	5000 ft	.826
500 ft	.981	6000 ft	.801
1000 ft	.962	7000 ft	.772
2000 ft	.926	8000 ft	.749
3000 ft	.891	9000 ft	.715
4000 ft	.858	10000 ft	.687

Sensible Heat Ratio = $\frac{\text{Sensible Load}}{\text{Sensitive Load} + \text{Latent Load}}$

SHR below .80 = 21° TD High humidity = 350 CFM/ton

SHR .80 to .85 = 19° TD Ave. humidity = 400 CFM/ton

SHR above .85 = 17° TD Low humidity = 450 CFM/ton

$$CFM = \frac{\text{Sensible Load}}{1.1 \times TD \times ACF}$$

Total Heat Equation

$$CFM = \frac{BTU/Hr}{4.5 \times H \times ACF}$$

4.5 is a conversion factor H is the BTU per lb. of air removed

Friction Rate

*%used in duct calculators

$$\text{Friction Rate} = \frac{\text{Pressure Drop} \times 100}{TEL}$$

Pressure Drop is the available static pressure (ASP) allocated to the duct work.

ASP = Blower Static Pressure - Component Pressure Drops

TEL is the Total Effective Length of the longest supply run and the longest return run.

CFM Calculations

$$\text{Room CFM} = \frac{\text{Blower CFM} \times \text{Room Load}}{\text{Equipment Sizing Load}}$$

$$\text{Flow Factor} = \frac{\text{Blower CFM}}{\text{Equipment Sizing Load}}$$

$$\text{Room CFM} = \text{Flow Factor} \times \text{Room Load}$$

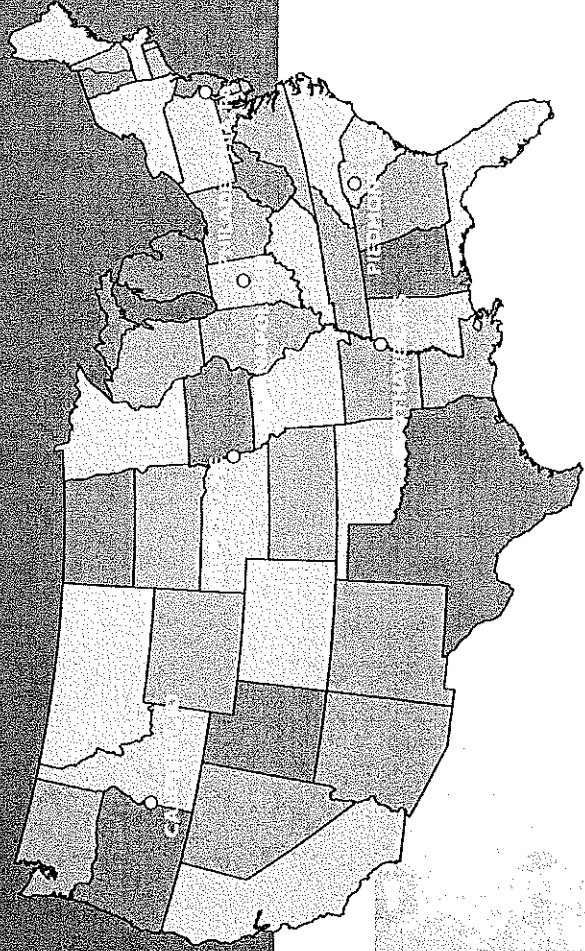

OUR LOCATIONS

PHILADELPHIA DIVISION

2800 Red Lion Road
Philadelphia, PA 19114
(800) 523-1052 • fax (800) 722-2076

STATES COVERED:

Pennsylvania, New Jersey, New York, Connecticut, Rhode Island, Massachusetts, Delaware, Vermont, New Hampshire, Maine, Maryland, and Virginia

GREENVILLE DIVISION

255 Bessie Road - Highway 86
Piedmont, SC 29673
(800) 229-2803 • fax (864) 845-6190

STATES COVERED:

South Carolina, North Carolina, Virginia, Georgia, Florida, Alabama, and Tennessee

INDIANAPOLIS DIVISION

10401 East 59th Street
Indianapolis, IN 46236
(800) 490-7707 • fax (317) 823-1006

STATES COVERED:

Indiana, Ohio, Michigan, Kentucky, West Virginia, Illinois, Wisconsin, Missouri, and Iowa

MISSISSIPPI DIVISION

8680 Stanton Road
Southaven, MS 38671
(800) 541-6706 • fax (662) 393-8005

STATES COVERED:

Mississippi, Louisiana, Alabama, Arkansas, Tennessee, Missouri, Oklahoma, Kentucky, and Texas

NEBRASKA DIVISION

2073 North Rademakers Way
Fremont, NE 68025
(800) 801-0336 • fax (402) 753-9008

STATES COVERED:

Nebraska, Missouri, Kansas, North Dakota, South Dakota, Colorado, Minnesota, Wyoming, and Iowa

IDAHO DIVISION

4002 Skyway Street
Caldwell, ID 83605
(866) 289-9908 • fax (208) 402-2126

STATES COVERED:

Idaho, Montana, Nevada, Oregon, Utah, Washington, Wyoming, California, and Alaska

www.southwarkmetal.com