

Taco® “00” Series Cartridge Circulators

For over 70 years, Taco has led the industry with the highest quality circulators you can buy. Designed for a wide range of residential and light commercial applications, every “00” comes with the reliability that has made Taco famous.



HYDRONIC COMPONENTS & SYSTEMS

**Do it once.
Do it right.®** 

Cartridge Circulators

Meet the “00” Family.

Every Taco “00” cartridge circulator is designed to make your job easier. Installation is quick and easy, and maintenance is a snap. With no mechanical seal, the self-lubricating design provides unmatched reliability. Every “00” features a field-replaceable cartridge that contains all the moving parts. Replacing the cartridge rebuilds the circulator! Additional features include:

- Standard High Capacity Output
- Direct Drive, Low Power Consumption
- Universal Flange To Flange Dimension

We’ve got you covered.

From the compact, low flow 003 to the high-head 0013, there’s a Taco Circulator to fit your job. Use for:

- Hydronic Heating
- Radiant In-Floor/Panel Heating
- Indirect Domestic Water Heating
- Solar Heating
- Heat Recovery
- Water Source Heat Pumping
- Domestic Water Recirculation
- Chilled Water Cooling Systems
- Small to Large Residential Applications
- Light Commercial Applications

Innovation all the way.

Our new IFC® Cartridge Circulators feature an Integral Flow Check, eliminating additional installation costs associated with separate in-line flow checks. The IFC® also improves system performance and is a snap to maintain. What could be better than lower cost and better performance?

Support, support, support.

Every pump we sell is included in our TacoNet® 7.0 software, so product selection and specification is as easy as typing in a few numbers. Contact us online at www.taco-hvac.com to get your TacoNet® 7.0 software. And while you’re there, browse our product lines, ask us a question, or just get to know Taco a little better. You’ll see why we’re known industry-wide as the easiest company to do business with.

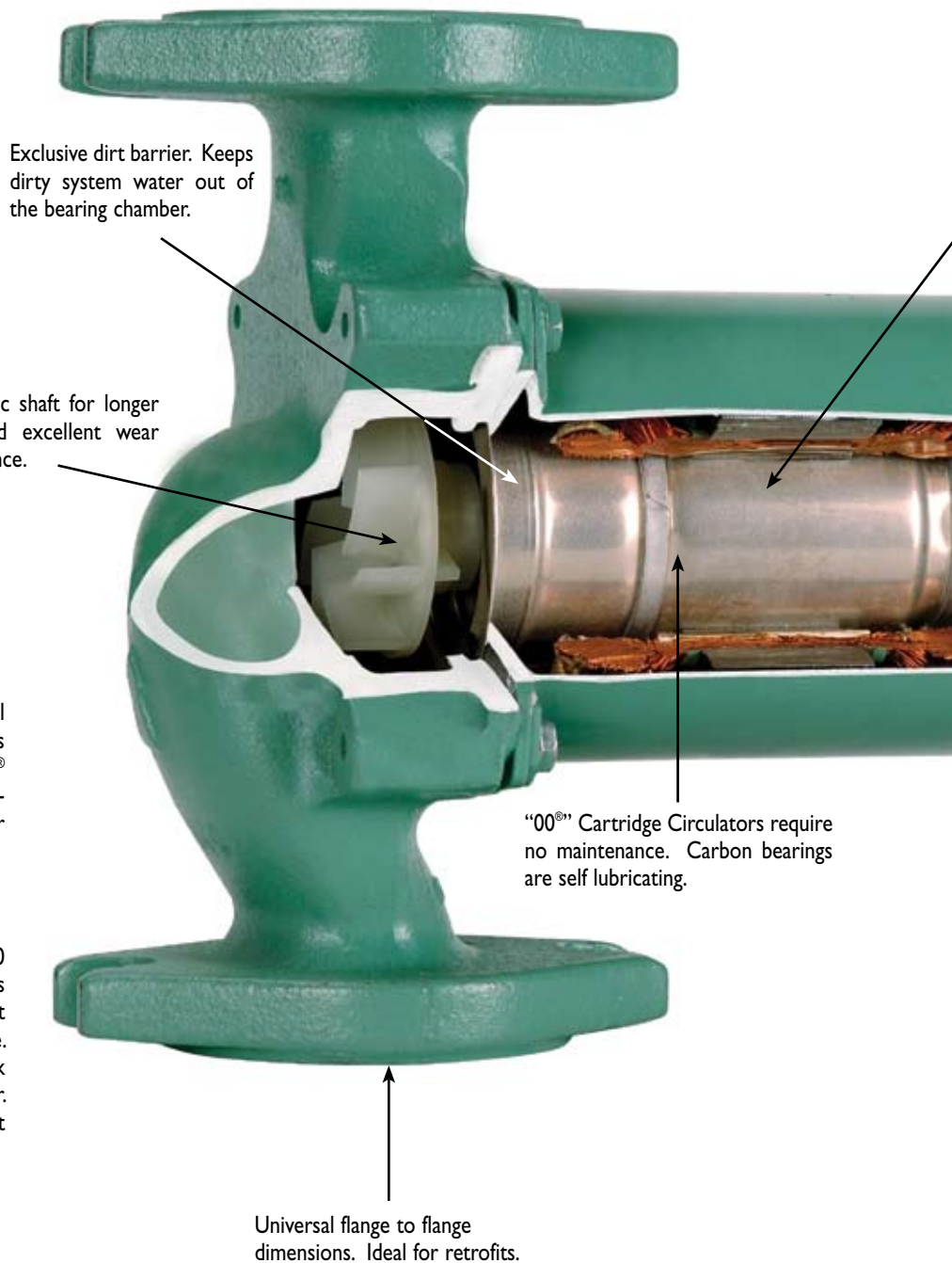

Submittal Data Information

Flange Orientation

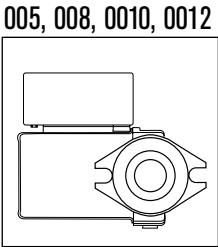
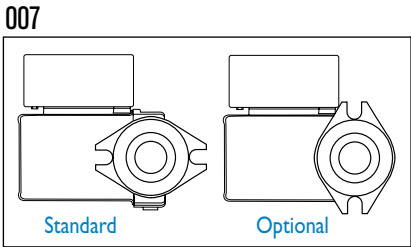

All IFC Models & 009,
0011, 0013, 0014

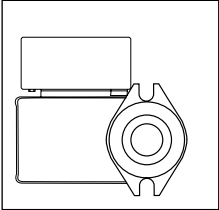

Exclusive stainless steel replaceable cartridge design. Replacing the cartridge rebuilds the circulator.

Mounting Positions

Sweat Models

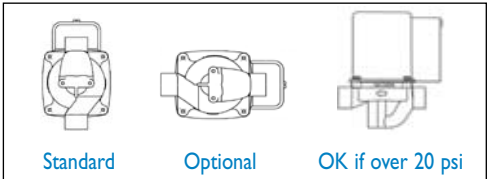

Flanged Models

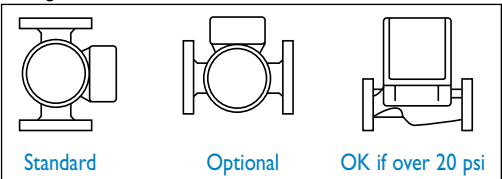

CUL Listed circulator. Motor is impedance protected.

Features

- Standard High Capacity Output-Compact Design
- Quiet, Efficient Operation
- Direct Drive-Low Power Consumption
- Unique Replaceable Cartridge Design-Field Serviceable
- Self Lubricating
- No Mechanical Seal
- Unmatched Reliability-Maintenance Free
- Anti-Condensate Baffle (ACB) to Protect Motor Windings (0011, 0012, 0013)
- Integral Flow Check (IFC)[™] Optional
- Priority Zoning Relay - Optional
- Plumb n' Plug - Pre-wired Timer Control

Materials of Construction

	003, 006	005, 007, 008	009-0014
Casing (Volute):	Bronze Only	Cast Iron or Bronze	Cast Iron or Bronze
Stator Housing:	Steel	Steel	Aluminum
Cartridge:	Stainless Steel	Stainless Steel	Stainless Steel
Impeller:	Non-Metallic	Non-Metallic	Non-Metallic
Shaft:	Ceramic	Ceramic	Ceramic
Bearings:	Carbon	Carbon	Carbon
O-Ring & Gaskets:	EPDM	EPDM	EPDM

Performance Data

	003, 006	005	007	008-0014
Minimum Fluid Temperature:	40°F (4°C)	40°F (4°C)	40°F (4°C)	40°F (4°C)
Maximum Fluid Temperature:	220°F (104°C)	220°F (104°C) Bronze 230°F (110°C) Cast Iron	230°F (110°C) Bronze 240°F (115°C) Cast Iron	230°F (110°C)
Maximum Working Pressure:	125 psi	125 psi	125 psi	125 psi



FOR INDOOR USE ONLY

Model 003 Cartridge Circulator



Model Nomenclature

- B – Bronze, Sweat
- BC – Bronze, Sweat, Panel Mount Tappings
- BT – Bronze, Threaded
- BC-I – Bronze, Union, Panel Mount Tappings

Performance Data

Flow Range: 0 – 6 GPM
 Head Range: 0 – 5 Feet
 Connection Sizes: 1/2" Swt, 3/4" Swt, 3/4" NPT, Union

Application

The Taco 003 is designed for circulating hot or chilled fresh water in open or closed loop, lower flow applications. Flow characteristics are ideal for Domestic Hot Water Recirculation, Heat Recovery Units, Water Source Heat Pumps, and Potable Water Systems. The unique, replaceable cartridge contains all of the moving parts and allows for easy service instead of replacing the entire circulator. The compact, low power consumption design is ideal for high efficiency jobs.

Pump Dimensions & Weights

Model	Connection	A		B		C		D		F		G		Ship Wt.	
		in.	mm	in.	mm	in.	mm	in.	mm	in.	mm	in.	mm	lbs.	Kg
003-B4	3/4" Swt	5-1/8	130	4-1/8	105	2-3/16	56	3-1/16	78	3-5/16	84	4-13/32	112	6.0	2.7
003-BC4	1/2" Swt	5-1/8	130	4-1/8	105	2-1/8	54	3-1/16	78	3-5/16	84	4-1/4	108	6.0	2.7
003-BT4	3/4" NPT	5-5/8	143	4-7/8	124	2	51	3-1/16	78	3-5/16	84	4	102	6.0	2.7
003-BC4-I	Union	5-5/32	131	4-11/32	110	2-31/32	76	3-1/16	78	3-5/16	84	5-15/16	151	6.0	2.7

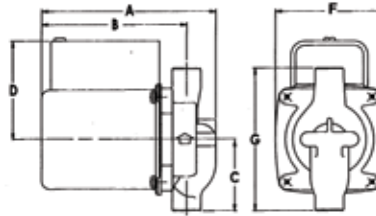

Electrical Data

Model	Volts	Hz	Ph	Amps	RPM	HP
003 All Models	115	60	1	.43	3250	1/40
Motor Type	Permanent Split Capacitor Impedance Protected					
Motor Options	220/50/1, 220/60/1, 230/60/1, 100/110/50/60/1					

Model 006 Cartridge Circulator



Model Nomenclature

- B – Bronze, Sweat
- BC – Bronze, Sweat, Panel Mount Tappings
- BT – Bronze, Threaded
- BC-I – Bronze, Union, Panel Mount Tappings

Performance Data

Flow Range: 0 – 10 GPM
 Head Range: 0 – 9 Feet
 Connection Sizes: 1/2" Swt, 3/4" Swt, 3/4" NPT, Union

Application

The Taco 006 is designed for circulating hot or chilled fresh water in open or closed loop, lower flow applications. Typical uses include Domestic Hot Water Recirculation, Hydro-Air Heating/Cooling, Heat Recovery Units, Water Source Heat Pumps, Drain Down Open Loop Solar systems and Potable Water applications. The unique, replaceable cartridge contains all of the moving parts and allows for easy service instead of replacing the entire circulator. The compact, low power consumption design is ideal for high efficiency jobs.

Pump Dimensions & Weights

Model	Connection	A		B		C		D		F		G		Ship Wt.	
		in.	mm	in.	mm	in.	mm	in.	mm	in.	mm	in.	mm	lbs.	Kg
006-B4	3/4" Swt	5-1/8	130	4-1/8	105	2-3/16	56	3-1/16	78	3-5/16	84	4-13/32	112	6.0	2.7
006-BC4	1/2" Swt	5-1/8	130	4-1/8	105	2-1/8	54	3-1/16	78	3-5/16	84	4-1/4	108	6.0	2.7
006-BT4	3/4" NPT	5-5/8	143	4-7/8	124	2	51	3-1/16	78	3-5/16	84	4	102	6.0	2.7
006-BC4-I	Union	5-5/32	131	4-11/32	110	2-31/32	76	3-1/16	78	3-5/16	84	5-15/16	151	6.0	2.7

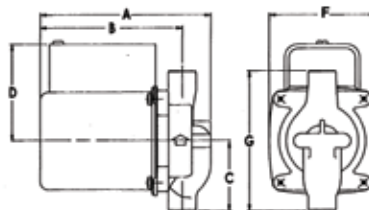

Electrical Data

Model	Volts	Hz	Ph	Amps	RPM	HP
006 All Models	115	60	1	.52	3250	1/40
Motor Type	Permanent Split Capacitor Impedance Protected					
Motor Options	220/50/1, 220/60/1, 230/60/1, 100/110/50/60/1					

Model 005 Cartridge Circulator



Model Nomenclature

F – Cast Iron, Flanged
BF – Bronze, Flanged

Variations:

Z – Zoning Circulator
J – Bronze Cartridge with Cast Iron Casing

Performance Data

Flow Range: 0 – 18 GPM
Head Range: 0 – 9.5 Feet
Connection Sizes: 3/4", 1", 1-1/4", 1-1/2" Flanged

Application

The Taco 005 is designed for a wide range of Residential/Light Commercial water circulating applications. Typical uses include Hydronic heating, add a zone additions, Zoning with circulators, Chilled Water cooling and Domestic Water Systems. Available in Cast Iron or Bronze construction with universal flange to flange dimensions. The unique replaceable cartridge contains all of the moving parts and allows for easy service, instead of replacing the entire circulator. Compact, direct-drive, low power consumption design is ideal for high efficiency jobs.

Pump Dimensions & Weights

Model	Casing	A		B		C		D		F		G		Ship Wt.	
		in.	mm	in.	mm	in.	mm	in.	mm	in.	mm	in.	mm	lbs.	Kg
005-F2	Cast Iron	5-5/8	143	4	102	3-3/16	81	2-15/16	75	4-3/4	121	6-3/8	162	8.0	3.6
005-BF2	Bronze	5-5/8	143	4	102	3-3/16	81	2-15/16	75	4-3/4	121	6-3/8	162	8.0	3.6

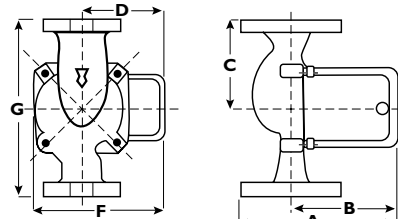

Electrical Data

Model	Volts	Hz	Ph	Amps	RPM	HP
005-F2	115	60	1	.53	3250	1/35
005-BF2	115	60	1	.54	3250	1/35
Motor Type	Permanent Split Capacitor Impedance Protected					
Motor Options	220/50/1, 220/60/1, 230/60/1, 100/110/50/60/1					

Model 007 Cartridge Circulator



Model Nomenclature

F – Cast Iron, Flanged
BF – Bronze, Flanged

Variations:

Z – Zoning Circulator
J – Bronze Cartridge with Cast Iron Casing

Performance Data

Flow Range: 0 – 20 GPM
Head Range: 0 – 11 Feet
Connection Sizes: 3/4", 1", 1-1/4", 1-1/2" Flanged

Application

The Taco 007 is a cartridge style, maintenance free, wet-rotor, in-line, single stage circulator. It is designed for quiet operation in Hydronic Heating, Radiant Heating, Hydro-Air Fan Coils, Indirect Water Heating, Chilled Water cooling, and Domestic Water Systems. Available in Cast Iron or Bronze construction with universal flange to flange dimensions. The unique replaceable cartridge contains all of the moving parts and allows for easy service, instead of replacing the entire circulator. Ideal for a wide range of applications.

Pump Dimensions & Weights

Model	Casing	A		B		C		D		F		G		Ship Wt.	
		in.	mm	in.	mm	in.	mm	in.	mm	in.	mm	in.	mm	lbs.	Kg
007-F5	Cast Iron	6-1/8	156	4-1/2	114	3-3/16	81	2-15/16	75	4-3/4	121	6-3/8	162	8.0	3.6
007-BF5	Bronze	6-1/8	156	4-1/2	114	3-3/16	81	2-15/16	75	4-3/4	121	6-3/8	162	8.0	3.6

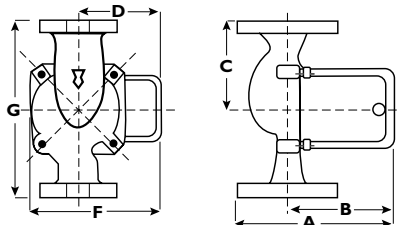

Electrical Data

Model	Volts	Hz	Ph	Amps	RPM	HP
007-F5	115	60	1	.70	3250	1/25
007-BF5	115	60	1	.76	3250	1/25
Motor Type	Permanent Split Capacitor Impedance Protected					
Motor Options	220/50/1, 220/60/1, 230/60/1, 100/110/50/60/1					

Model 008 Cartridge Circulator



Model Nomenclature

F – Cast Iron, Flanged
 BF – Bronze, Flanged
 BC – Bronze, Sweat Connections

Variations:

Z – Zoning Circulator
 J – Bronze Cartridge with Cast Iron Casing

Performance Data

Flow Range: 0 – 14 GPM
 Head Range: 0 – 16 Feet
 Connection Sizes: 3/4", 1", 1-1/4", 1-1/2" Flanged, 3/4" Sweat

Application

The Taco 008 is designed for a wide range of Residential/Light Commercial higher-head water circulating applications. Typical uses include Hydronic heating, Radiant In-Floor/Panel heating and closed-loop Solar heating systems. The Bronze 008 can be used in higher-head Heat Recovery, Water Source Heat Pumps, open-loop Solar heat and Domestic Water Recirculation systems. The unique replaceable cartridge contains all of the moving parts and allows for easy service, instead of replacing the entire circulator. Compact, direct-drive, low power consumption design is ideal for high-efficiency jobs.

Pump Dimensions & Weights

Model	Casing	A		B		C		D		F		G		Ship Wt.	
		in.	mm	in.	mm	in.	mm	in.	mm	in.	mm	in.	mm	lbs.	Kg
008-F6	Cast Iron	6	152	4	102	3-3/16	81	2-15/16	75	4-3/4	121	6-3/8	162	8.0	3.6
008-BF6	Bronze (F)	6	152	4	102	3-3/16	81	2-15/16	75	4-3/4	121	6-3/8	162	8.0	3.6
008-BC6	Bronze (S)	5-5/8	143	4-9/16	116	3-3/16	81	2-15/16	75	4-3/4	121	6-3/8	162	8.0	3.6

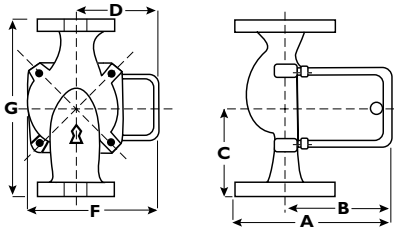

Electrical Data

Model	Volts	Hz	Ph	Amps	RPM	HP
008-F6	115	60	1	.79	3250	1/25
008-BF6	115	60	1	.84	3250	1/25
008-BC6	115	60	1	.84	3250	1/25
Motor Type	Permanent Split Capacitor Impedance Protected					
Motor Options	220/50/1, 220/60/1, 230/60/1, 100/110/50/60/1					

Model 009 Cartridge Circulator



Model Nomenclature

F – Cast Iron, Flanged
 BF – Bronze, Flanged

Variations:

Z – Zoning Circulator
 J – Bronze Cartridge with Cast Iron Casing

Performance Data

Flow Range: 0 – 8 GPM
 Head Range: 0 – 34 Feet
 Connection Sizes: 3/4", 1", 1-1/4", 1-1/2" Flanged

Application

The Taco 009 is designed for a wide range of Residential/Light Commercial higher-head/lower-flow water circulating applications. Typical uses include Hydronic heating, Radiant In-Floor/Panel heating and closed-loop Solar heating systems. The Bronze 009 can be used in higher-head/lower-flow Heat Recovery, open-loop Solar heating and Light Commercial Domestic Water Recirculation systems. The unique replaceable cartridge contains all of the moving parts and allows for easy service, instead of replacing the entire circulator. Compact, direct-drive, low power consumption design is ideal for high-efficiency jobs.

Pump Dimensions & Weights

Model	Casing	A		B		C		D		F		G		Ship Wt.	
		in.	mm	in.	mm	in.	mm	in.	mm	in.	mm	in.	mm	lbs.	Kg
009-F5	Cast Iron	7	178	5-11/16	144	3-3/16	81	3-5/16	84	4-1/8	105	6-3/8	162	9.5	4.3
009-BF5	Bronze	7	178	5-11/16	144	3-3/16	81	3-5/16	84	4-1/8	105	6-3/8	162	9.5	4.3

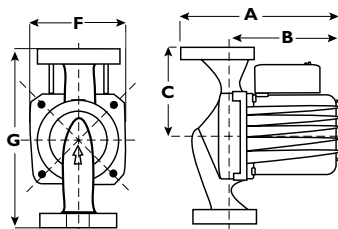

Electrical Data

Model	Volts	Hz	Ph	Amps	RPM	HP
009-F5	115	60	1	1.40	3250	1/8
009-BF5	115	60	1	1.40	3250	1/8
Motor Type	Permanent Split Capacitor Impedance Protected					
Motor Options	220/50/1, 220/60/1, 230/60/1, 100/110/50/60/1					

Model 0010 Cartridge Circulator



Model Nomenclature

F – Cast Iron, Flanged

BF – Bronze, Flanged

Variations:

Z – Zoning Circulator

J – Bronze Cartridge with Cast Iron Casing

Performance Data

Flow Range: 0 – 30 GPM

Head Range: 0 – 11.5 Feet

Connection Sizes: 3/4", 1", 1-1/4", 1-1/2" Flanged

Application

The Taco 0010 is designed for a wide range of Residential/Light Commercial medium head/medium flow water circulating applications. Typical uses include Hydronic heating, Radiant heating, Primary-Secondary loops, Indirect water heaters, Chilled Water cooling, and Potable Hot Water systems. The Bronze 0010 is designed for all open-loop, fresh water systems. The unique replaceable cartridge contains all of the moving parts and allows for easy service, instead of replacing the entire circulator. Compact, direct-drive, low power consumption design makes it ideal for high-efficiency jobs.

Pump Dimensions & Weights

Model	Casing	A		B		C		D		F		G		Ship Wt.	
		in.	mm	in.	mm	in.	mm	in.	mm	in.	mm	in.	mm	lbs.	Kg
0010-F2	Cast Iron	7-1/4	184	5-5/16	135	3-3/16	81	3-5/16	84	5-3/8	137	6-3/8	162	13	6
0010-BF2	Bronze	7-1/4	184	5-5/16	135	3-3/16	81	3-5/16	84	5-3/8	137	6-3/8	162	13	6

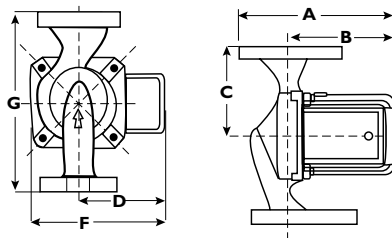

Electrical Data

Model	Volts	Hz	Ph	Amps	RPM	HP
0010-F2	115	60	1	1.10	3250	1/8
0010-BF2	115	60	1	1.17	3250	1/8
Motor Type	Permanent Split Capacitor Impedance Protected					
Motor Options	220/50/1, 220/60/1, 230/60/1, 100/110/50/60/1					

Model 0011 Cartridge Circulator



Model Nomenclature

F – Cast Iron, Flanged

BF – Bronze, Flanged

Variations:

Z – Zoning Circulator

J – Bronze Cartridge with Cast Iron Casing

Performance Data

Flow Range: 0 – 28 GPM

Head Range: 0 – 30 Feet

Connection Sizes: 3/4", 1", 1-1/4", 1-1/2" Flanged

Application

The Taco 0011 is specifically designed for high head / medium flow applications in Large Residential / Light Commercial closed loop Hydronic heating and Chilled Water cooling systems. Ideal for high pressure drop Boilers, Fan Coil units, Heat Exchangers, large Radiant Heating and Heat Recovery / Geothermal systems. Exclusive Anti-Condensate Baffle (ACB) protects motor windings on chilled water jobs. The Bronze 0011 can be used on open loop systems. The unique replaceable cartridge contains all of the moving parts and allows for easy service instead of replacing the entire circulator. Universal flange to flange dimensions and orientation allows the 0011 to easily replace other models.

Pump Dimensions & Weights

Model	Casing	A		B		C		D		F		G		Ship Wt.	
		in.	mm	in.	mm	in.	mm	in.	mm	in.	mm	in.	mm	lbs.	Kg
0011-F4	Cast Iron	7-5/8	194	6-7/32	158	3-1/4	82	3-3/4	95	6	152	6-1/2	165	12.0	5.5
0011-BF4	Bronze	7-5/8	194	6-7/32	158	3-1/4	82	3-3/4	95	6	152	6-1/2	165	12.0	5.5

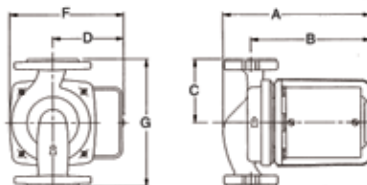

Electrical Data

Model	Volts	Hz	Ph	Amps	RPM	HP
0011-F4	115	60	1	1.76	3250	1/8
0011-BF4	115	60	1	1.76	3250	1/8
Motor Type	Permanent Split Capacitor Impedance Protected					
Motor Options	220/50/1, 220/60/1, 230/60/1, 100/110/50/60/1					

Model 0012 Cartridge Circulator



Model Nomenclature

F – Cast Iron, Flanged
 BF – Bronze, Flanged
Variations:
 Z – Zoning Circulator
 J – Bronze Cartridge with Cast Iron Casing

Performance Data

Flow Range: 0 – 50 GPM
 Head Range: 0 – 14.5 Feet
 Connection Sizes: 1-1/4", 1-1/2", 2" Flanged

Application

The Taco 0012 is specifically designed for high flow / medium head applications in Large Residential/ Light Commercial systems. Ideal for large BTUH Boilers, 2" Recirculation Loops, Primary/Secondary Loops, Commercial Water Heaters and light Commercial Heating and Cooling systems. Exclusive Anti-Condensate Baffle (ACB) protects motor windings on chilled water jobs. The Bronze 0012 can be used on open loop systems. The unique replaceable cartridge contains all of the moving parts and allows for easy service instead of replacing the entire circulator. Universal flange to flange dimensions and orientation allows the 0012 to easily replace other models. The 0012-F4 is a direct replacement for the HV Series and the 0012-F4-1 is a direct replacement for the 2" Series using existing flanges.

Pump Dimensions & Weights

Model	Flange*	Casing	A		B		C		D		F		G		Ship Wt.	
			in.	mm	in.	mm	in.	mm	in.	mm	in.	mm	in.	mm	lbs.	Kg
0012-F4	1-1/2"	Cast Iron	8-5/8	219	6-3/8	162	4-1/4	108	3-7/8	98	6	152	8-1/2	216	13.0	5.9
0012-F4-1	2"	Cast Iron	9	229	6-3/8	162	4-1/4	108	3-7/8	98	6	152	8-1/2	216	13.0	5.9
0012-BF4	1-1/2"	Bronze	8-5/8	219	6-3/8	162	4-1/4	108	3-7/8	98	6	152	8-1/2	216	13.0	5.9
0012-BF4-1	2"	Bronze	9	229	6-3/8	162	4-1/4	108	3-7/8	98	6	152	8-1/2	216	13.0	5.9

*Flanges included in carton

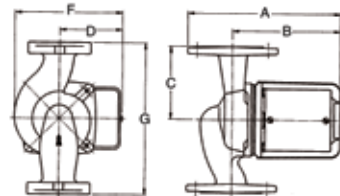

Electrical Data

Model	Volts	Hz	Ph	Amps	RPM	HP
All Models	115	60	1	1.33	3250	1/8
Motor Type	Permanent Split Capacitor Impedance Protected					
Motor Options	220/50/1, 220/60/1, 230/60/1, 100/110/50/60/1					

Model 0013 Cartridge Circulator



Model Nomenclature

F – Cast Iron, Flanged
 BF – Bronze, Flanged
Variations:
 Z – Zoning Circulator
 J – Bronze Cartridge with Cast Iron Casing

Performance Data

Flow Range: 0 – 33 GPM
 Head Range: 0 – 33 Feet
 Connection Sizes: 3/4", 1", 1-1/4", 1-1/2" Flanged

Application

The Taco 0013 is specifically designed for high head / high flow applications in Large Residential/Light Commercial systems. Ideal for high pressure drop Boilers, Fan Coil units, Heat Exchangers, larger Radiant systems, Heat Recovery and Geothermal systems. Exclusive Anti-Condensate Baffle (ACB) protects motor windings on chilled water jobs. The Bronze 0013 should be used on open loop systems. The unique replaceable cartridge contains all of the moving parts and allows for easy service instead of replacing the entire circulator. Universal flange to flange dimensions and orientation allows the 0013 to easily replace other models.

Pump Dimensions & Weights

Model	Casing	A		B		C		D		F		G		Ship Wt.	
		in.	mm	in.	mm	in.	mm	in.	mm	in.	mm	in.	mm	lbs.	Kg
0013-F3	Cast Iron	7-3/4	197	6-3/8	162	3-1/4	82	3-3/4	95	6	152	6-1/2	165	12.0	5.5
0013-BF3	Bronze	7-3/4	197	6-3/8	162	3-1/4	82	3-3/4	95	6	152	6-1/2	165	12.0	5.5

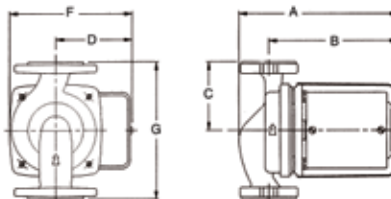

Electrical Data

Model	Volts	Hz	Ph	Amps	RPM	HP
0013-F3	115	60	1	2.0	3250	1/6
0013-BF3	115	60	1	2.0	3250	1/6
Motor Type	Permanent Split Capacitor Impedance Protected					
Motor Options	220/50/1, 220/60/1, 230/60/1, 100/110/50/60/1					

Model 0014 Cartridge Circulator



Application

The Taco 0014 is specifically designed for medium head / medium flow applications in Large Residential/Light Commercial systems. Ideal for large BTUH Boilers, Primary/Secondary loops, Commercial Water Heaters, and light Commercial Heating and Cooling systems. The Bronze 0014 should be used on open loop systems. The unique replaceable cartridge contains all of the moving parts and allows for easy service instead of replacing the entire circulator. Universal flange to flange dimensions and orientation allows the 0014 to easily replace other models. The Compact, Direct-Drive, Low Power Consumption design makes it ideal for high-efficiency jobs.

Pump Dimensions & Weights

Model	Casing	A		B		C		D		F		G		Ship Wt.	
		in.	mm	in.	mm	in.	mm	in.	mm	in.	mm	in.	mm	lbs.	Kg
0014-FI	Cast Iron	7-1/4	184	5-13/16	148	3-1/4	83	3-5/16	84	5-3/8	137	6-1/2	165	12.0	5.5
0014-BFI	Bronze	7-1/4	184	5-13/16	148	3-1/4	83	3-5/16	84	5-3/8	137	6-1/2	165	12.0	5.5

Model Nomenclature

F – Cast Iron, Flanged
BF – Bronze, Flanged

Variations:

Z – Zoning Circulator
J – Bronze Cartridge with Cast Iron Casing

Performance Data

Flow Range: 0 – 32 GPM
Head Range: 0 – 22 Feet
Connection Sizes: 3/4", 1", 1-1/4", 1-1/2" Flanged

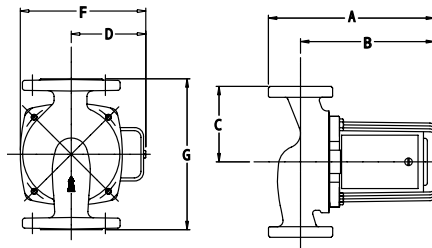

Electrical Data

Model	Volts-	Hz	Ph	Amps	RPM	HP
0014-FI	115	60	1	1.55	3250	1/8
0014-BFI	115	60	1	1.55	3250	1/8
Motor Type	Permanent Split Capacitor Impedance Protected					
Motor Options	220/50/1, 220/60/1, 230/60/1, 100/110/50/60/1					

Priority Zoning Circulator



Application

Thermostat ready. The Taco Priority Zoning Circulator combines the reliability of the "00" circulator with the convenience and efficiency of a PC board mounted switching relay package. Each zoning circulator has low and high voltage terminal strips for ease of electrical hookup, as well as a built-in priority switch. The priority switch allows the installer to choose the zone that requires the most attention and, when activated, run only that circulator. The priority zoning circulator can be used in conjunction with other circulators or zone valves. It is ideal for indirect hot water heaters, adding another zone, zoning with circulators, and for prioritizing under-sized zones. Available in a full range of sizes from 003 - 0014.

PC Board and Electrical Hook Up

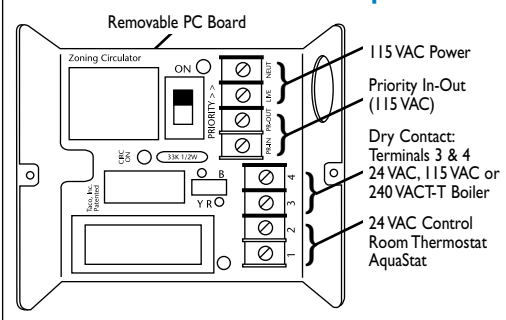

Contact Ratings

Terminals 1 & 2 24VAC 1 Phase
Terminals 3 & 4 24VAC 1 Phase 5 Amps
115VAC 1 Phase 5 Amps
240VAC 1 Phase 5 Amps (max)

PR-IN & PR-OUT 115VAC 1 Phase 8 Amps
Inrush Current (max)

Live & Neutral 115VAC 1 Phase (max)

Thermostat Ratings

24VAC SPDT 2-Wire Heating
24VAC Digital Electronic
2-Wire Max Draw 30 Milliamps

Features

- "00" Reliability
- Snap-in PC Board
- Low and High Voltage Terminal Strips
- UL and CSA Listed
- Simplified Wiring
- LED Power Light
- 100% Factory Tested
- Works With Other Circulators or Zone Valves
- Universal Thermostat Compatibility
- Available In Sizes 003 - 0014
- Patented Design
- Made in the USA

Model 003 Plumb n' Plug®



Model Nomenclature

- B – Bronze, Sweat
- BC – Panel Mount Tappings
- BT – Bronze, 3/4" FNPT
- BC-I – Bronze, Union Connection
- PNP – Plumb n' Plug® Prewired Timer & Cord

Performance Data

Flow Range: 0 – 6 GPM
 Head Range: 0 – 5 Feet
 Connection Sizes: 1/2", 3/4" Swt; 3/4" NPT; Union

Application

The Taco 003-PNP periodically re-circulates hot water through the domestic piping system to decrease the delivery time to outlet fixtures and reduce wasted water. Typical timer programming will cycle the Plumb n' Plug during high peak usage periods such as early morning or early evening. An optional Aquastat is available for constant circulation applications to maintain temperature between 95°F and 115°F. The 003-PNP is ideal for recirculation loops. Its design operating condition of 3 gpm at 3 feet of head helps to reduce erosion, corrosion and noise in system piping. Use the 003 for systems up to 200 total feet (supply and return) of 3/4" pipe. Installation of Isolation Valves, Pipe Insulation and Flow Check valves are recommended.

Pump Dimensions & Weights

Model	Connection	A		B		C		D		E		F		Ship Wt.	
		in.	mm	in.	mm	in.	mm	in.	mm	in.	mm	in.	mm	lbs.	Kg
003-BC4-PNP	1/2" Swt	7-1/4	184	1-15/16	49	2-1/8	54	3-1/16	78	5-1/4	134	3-5/16	84	6.0	2.7
003-B4-PNP	3/4" Swt	7-1/4	184	1-15/16	49	2-3/16	56	3-1/16	78	5-1/4	134	3-5/16	84	6.0	2.7
003-BT4-PNP	3/4" FNPT	7-1/4	184	1-15/16	49	2	51	3-1/16	78	5-1/4	134	3-5/16	84	6.0	2.7
003-BC4-IPNP	Union	7-1/4	184	1-15/16	49	2-31/32	76	3-1/16	78	5-1/4	134	3-5/16	84	6.0	2.7
PNP Models with Integral Flow Check (IFC®)															
003-BC4-3PNP	1/2" Swt	8-1/8	205	1-15/16	49	2-13/16	56	3-1/16	78	5-1/4	134	3-5/16	84	6.0	2.7
003-BC4-2PNP	3/4" Swt	8-1/8	205	1-15/16	49	2-13/16	56	3-1/16	78	5-1/4	134	3-5/16	84	6.0	2.7

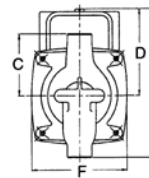
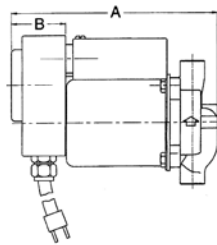

Electrical Data

Model	Volts	Hz	Ph	Amps	RPM	HP
003-PNP	115	60	1	.43	3250	1/40
Motor Type	Permanent Split Capacitor Impedance Protected					
Motor Options	220/50/1, 220/60/1, 230/60/1, 100/110/50/60/1					

Model 006 Plumb n' Plug®



Model Nomenclature

- B – Bronze, Sweat
- BC – Panel Mount Tappings
- BT – Bronze, 3/4" FNPT
- BC-I – Bronze, Union Connection
- PNP – Plumb n' Plug® Prewired Timer & Cord

Performance Data

Flow Range: 0 – 10 GPM
 Head Range: 0 – 9 Feet
 Connection Sizes: 1/2", 3/4" Swt; 3/4" NPT; Union

Application

The Taco 006-PNP periodically re-circulates hot water through the domestic piping system to decrease the delivery time to outlet fixtures and reduce wasted water. Typical timer programming will cycle the Plumb n' Plug during high peak usage periods such as early morning or early evening. An optional Aquastat is available for constant circulation applications to maintain temperature between 95°F and 115°F. The Taco 006-PNP is designed for systems using 200-400 feet of 3/4" pipe. Installation of Isolation Valves, Pipe Insulation and Flow Check valves are recommended.

Pump Dimensions & Weight

Model	Connection	A		B		C		D		E		F		Ship Wt.	
		in.	mm	in.	mm	in.	mm	in.	mm	in.	mm	in.	mm	lbs.	Kg
006-BC4-PNP	1/2" Swt	7-1/4	184	1-15/16	49	2-1/8	54	3-1/16	78	5-1/4	134	3-5/16	84	6.0	2.7
006-B4-PNP	3/4" Swt	7-1/4	184	1-15/16	49	2-3/16	56	3-1/16	78	5-1/4	134	3-5/16	84	6.0	2.7
006-BT4-PNP	3/4" FNPT	7-1/4	184	1-15/16	49	2	51	3-1/16	78	5-1/4	134	3-5/16	84	6.0	2.7
006-BC4-IPNP	Union	7-1/4	184	1-15/16	49	2-31/32	76	3-1/16	78	5-1/4	134	3-5/16	84	6.0	2.7
PNP Models with Integral Flow Check (IFC®)															
006-BC7-IPNP	1/2" Swt	8-1/8	205	1-15/16	49	2-13/16	56	3-1/16	78	5-1/4	134	3-5/16	84	6.0	2.7
006-BC7-PNP	3/4" Swt	8-1/8	205	1-15/16	49	2-13/16	56	3-1/16	78	5-1/4	134	3-5/16	84	6.0	2.7

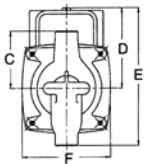
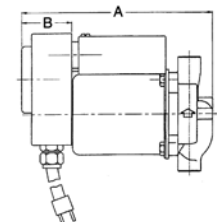

Electrical Data

Model	Volts	Hz	Ph	Amps	RPM	HP
006-PNP	115	60	1	.52	3250	1/40
Motor Type	Permanent Split Capacitor Impedance Protected					
Motor Options	220/50/1, 220/60/1, 230/60/1, 100/110/50/60/1					

Model 003-IFC® Cartridge Circulator



Model Nomenclature

BC – Bronze, Sweat, Panel Mount
IFC® – Integral Flow Check

Performance Data

Flow Range: 0 - 6 GPM
Head Range: 0 - 4.5 Feet
Connection Sizes: 1/2", 3/4" Sweat

Application

The Taco 003-IFC® with an Integral Flow Check (IFC®) is designed for the circulation of hot or chilled fresh water in open or closed loop applications. The IFC® feature eliminates separate in-line flow check, reduces installation costs and improves system performance. Typical uses include Domestic Hot Water Recirculation, Hydro-Air Fan Coil, Heat Recovery Units, Water Source Heat Pumps, and Potable Water applications. With its patented location at the Impeller inlet, the IFC® is easy to service without removing the entire unit from system piping. The unique, replaceable cartridge contains all of the moving parts and allows for easy service instead of replacing the entire circulator. Available with optional Plumb n' Plug Timer®, Power Cord and Thermostat.

Pump Dimensions & Weights

Model	Connection	A		B		C		D		F		G		Ship Wt.	
		in.	mm	in.	mm	in.	mm	in.	mm	in.	mm	in.	mm	lbs.	Kg
003-BC4-1-IFC	1/2" Swt	6	152	4-7/8	124	2-3/16	56	2-15/16	75	3-5/16	84	4-3/8	111	6.0	2.7
003-BC4-IFC	3/4" Swt	6	152	4-7/8	124	2-3/16	56	2-15/16	75	3-5/16	84	4-3/8	111	6.0	2.7

Electrical Data

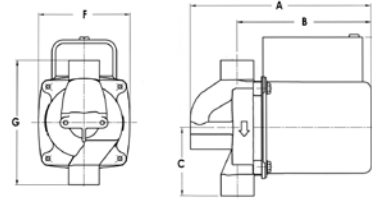

Model	Volts	Hz	Ph	Amps	RPM	HP
All 003 Models	115	60	1	.45	3250	1/40
Motor Type	Permanent Split Capacitor Impedance Protected					
Motor Options	220/50/1, 220/60/1, 230/60/1, 100/110/50/60/1					

Model 006-IFC® Cartridge Circulator



Model Nomenclature

BC – Bronze, Sweat, Panel Mount
IFC® – Integral Flow Check

Performance Data

Flow Range: 0 – 9 GPM
Head Range: 0 – 9 Feet
Connection Sizes: 1/2", 3/4" Sweat

Application

The Taco 006-IFC® with an Integral Flow Check (IFC®) is designed for the circulation of hot or chilled fresh water in open or closed loop applications. The IFC® feature eliminates separate in-line flow check, reduces installation costs and improves system performance. Typical uses include Domestic Hot Water Recirculation, Hydro-Air Fan Coil, Heat Recovery Units, Water Source Heat Pumps, Drain Down Open Loop Solar systems and Potable Water applications. Available in Bronze construction with 1/2" & 3/4" Sweat Connections. With its patented location at the Impeller inlet, the IFC® is easy to service without removing the entire unit from system piping. The unique, replaceable cartridge contains all of the moving parts and allows for easy service instead of replacing the entire circulator. Compact, Low Power Consumption design is ideal for high efficiency jobs.

Pump Dimensions & Weights

Model	Connection	A		B		C		D		F		G		Ship Wt.	
		in.	mm	in.	mm	in.	mm	in.	mm	in.	mm	in.	mm	lbs.	Kg
006-BC7-1-IFC	1/2" Swt	6	152	4-7/8	124	2-3/16	56	2-15/16	75	3-5/16	84	4-3/8	111	6.0	2.7
006-BC7-IFC	3/4" Swt	6	152	4-7/8	124	2-3/16	56	2-15/16	75	3-5/16	84	4-3/8	111	6.0	2.7

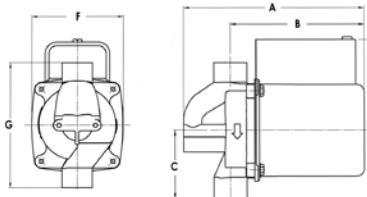

Electrical Data

Model	Volts	Hz	Ph	Amps	RPM	HP
All 006 Models	115	60	1	.52	3250	1/40
Motor Type	Permanent Split Capacitor Impedance Protected					
Motor Options	220/50/1, 220/60/1, 230/60/1, 100/110/50/60/1					

Model 005-IFC® Cartridge Circulator



Model Nomenclature

F – Cast Iron, Flanged
Z – Zoning Circulator
IFC® – Integral Flow Check

Performance Data

Flow Range: 0 - 11.5 GPM
Head Range: 0 - 10 Feet
Connection Sizes: 3/4", 1", 1-1/4", 1-1/2" Flanged

Application

The Taco 005-IFC® with an Integral Flow Check (IFC®) is designed to reduce installation costs when zoning with "00" circulators on Hydronic or Radiant heating, Hydro-Air Fan Coils or Indirect water heaters. By locating the patented IFC® inside the pump casing, a separate in-line flow check is eliminated, reducing installation costs. The reduced pressure drop of the IFC®, increases the 005 flow performance up to 240% over in-line check valves. Both the IFC® and cartridge are easily accessed for service instead of replacing the entire unit. The 005-Z-IFC® combines the circulator, flow-check and patented Priority Zoning control with built-in transformer, relay and priority switch in one complete, compact package to make it ideal for zoning. Available in Cast Iron construction with flanged connections.

Pump Dimensions & Weights

Model	Casing	A		B		C		D		E		F		Ship Wt.	
		in.	mm	in.	mm	in.	mm	in.	mm	in.	mm	in.	mm	lbs.	Kg
005-F2-IFC	Cast Iron	6-5/8	168	4-1/8	105	3-3/16	81	2-15/16	75	5	127	6-3/8	162	8	3.6
005-ZF2-IFC	Cast Iron	6-5/8	168	4-1/8	105	3-3/16	81	3-5/8	92	5-9/16	143	6-3/8	162	8	3.6

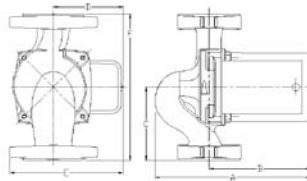

Electrical Data

Model	Volts	Hz	Ph	Amps	RPM	HP
005-F2-IFC	115	60	1	.52	3250	1/35
005-ZF2-IFC	115	60	1	.52	3250	1/35
Motor Type	Permanent Split Capacitor Impedance Protected					
Motor Options	220/50/1, 220/60/1, 230/60/1, 100/110/50/60/1					

Model 007-IFC® Cartridge Circulator



Model Nomenclature

F – Cast Iron, Flanged
Z – Zoning Circulator
IFC® – Integral Flow Check

Performance Data

Flow Range: 0 – 12.5 GPM
Head Range: 0 – 11 Feet
Connection Sizes: 3/4", 1", 1-1/4", 1-1/2" Flanged

Application

The Taco 007-IFC® with an Integral Flow Check (IFC®) is designed to reduce installation costs when zoning with "00" circulators on Hydronic or Radiant heating, Hydro-Air Fan Coils or Indirect water heaters. By locating the IFC® inside the pump casing, a separate in-line flow check is eliminated, reducing installation costs. The reduced pressure drop of the IFC®, increases the 007 flow performance by up to 240% over in-line check valves. Both the IFC® and the replaceable cartridge are easily accessed for service instead of replacing the entire unit. The 007Z-IFC® combines the circulator, flow-check and patented Priority Zoning control with built-in transformer, relay and priority switch in one complete, compact package to make it ideal for zoning. Available in Cast Iron construction with flanged connections.

Pump Dimensions & Weights

Model	Casing	A		B		C		D		E		F		Ship Wt.	
		in.	mm	in.	mm	in.	mm	in.	mm	in.	mm	in.	mm	lbs.	Kg
007-F5-IFC	Cast Iron	7	178	4-1/2	114	3-3/16	81	2-15/16	75	5	127	6-3/8	162	9	4.0
007-ZF5-IFC	Cast Iron	7	178	4-1/2	114	3-3/16	81	3-5/8	92	5-9/16	143	6-3/8	162	9	4.0

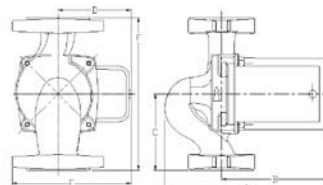

Electrical Data

Model	Volts	Hz	Ph	Amps	RPM	HP
All 007 Models	115	60	1	.71	3250	1/25
Motor Type	Permanent Split Capacitor Impedance Protected					
Motor Options	220/50/1, 220/60/1, 230/60/1, 100/110/50/60/1					

Model 008-IFC® Cartridge Circulator



Application

The 008-IFC® with an Integral Flow Check (IFC®) is designed to reduce installation costs when zoning with “00” circulators on Hydronic or Radiant heating, Hydro-Air Fan Coils or closed loop solar heating systems. By locating the patented IFC® inside the pump casing, a separate in-line flow check is eliminated, reducing installation costs. The reduced pressure drop of the IFC®, increases the 008 flow performance up to 260% over in-line check valves. Both the IFC® and cartridge are easily accessed for service instead of replacing the entire unit. The 008-Z-IFC® combines the circulator, flow-check and patented Priority Zoning control with built-in transformer, relay and priority switch in one complete, compact package to make it ideal for zoning. Available in Cast Iron or Bronze construction.

Pump Dimensions & Weights

Model	Casing	A		B		C		D		E		F		Ship Wt.	
		in.	mm	in.	mm	in.	mm	in.	mm	in.	mm	in.	mm	lbs.	Kg
008-F6-IFC	Cast Iron	7	178	4-1/2	114	3-3/16	81	2-15/16	75	5	127	6-3/8	162	9	4.0
008-ZF6-IFC	Cast Iron	7	178	4-1/2	114	3-3/16	81	3-5/8	92	5-9/16	143	6-3/8	162	9	4.0
008-BC6-IFC	Bronze	6-1/2	165	4-9/16	116	3-3/16	81	2-15/16	75	4-11/16	119	6-3/8	162	9	4.0

Model Nomenclature

F – Cast Iron, Flanged
 Z – Zoning Circulator
 BC – Bronze, Sweat, Panel Mount
 IFC® – Integral Flow Check

Performance Data

Flow Range: 0 - 12.5 GPM
 Head Range: 0 - 15 Feet
 Connection Sizes: 3/4", 1", 1-1/4", 1-1/2" Flanged
 or 3/4" Sweat

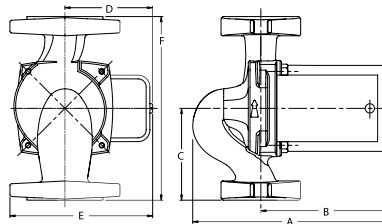

Electrical Data

Model	Volts	Hz	Ph	Amps	RPM	HP
All 008 Models	115	60	1	.79	3250	1/25
Motor Type	Permanent Split Capacitor Impedance Protected					
Motor Options	220/50/1, 220/60/1, 230/60/1, 100/110/50/60/1					

freedom Flange™

Application

Use Taco *freedom* Flanges on all your Circulator jobs for a complete professional installation. Available in Ductile Iron or Bronze, Threaded, Sweat or Threaded Shut-Off design. There's a *freedom* Flange™ to fit every "00" Circulator. The unique hex design provides easy-on, easy-off installation with a standard adjustable wrench.

Shut-Off *freedom* Flange™ - Bronze



Shut-Off *freedom* Flange™ Features

- 2-Piece Design
- 1/4" Steel Flange - Won't Bend or Crack
- Dual Teflon Seated Solid Brass Ball
- Upgraded Stem Seal
- Available in 3/4", 1", 1-1/4" Threaded Connections

Sweat *freedom* Flange™ - Bronze



Sweat & Threaded *freedom* Flange™ Features

- Fits All "00" Circulators
- Easy-On, Easy-Off with an Adjustable Wrench
- Ductile Iron - Stronger than Cast Iron
- Ductile Iron 3/4" – 2"
- Bronze Threaded 3/4" – 2"
- Bronze Sweat 1/2" – 1-1/2"

Threaded *freedom* Flange™ - Bronze



Threaded *freedom* Flange™ - Ductile Iron

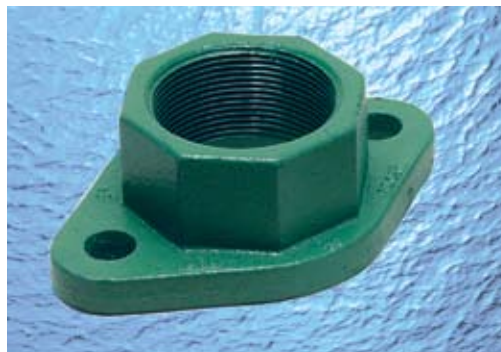

Ductile Iron Freedom Flange™

Ductile Iron Freedom Flange Sets (005, 007-0011, 0013, 0014, 110-113)

Figure	Product #	Size A	B	C	D	E	F	G	H
A	110-251F	3/4" NPT	2-3/4"	1-3/8"	4-1/8"	2-1/16"	1-1/4"	3/8"	3-1/8"
A	110-252F	1" NPT	2-3/4"	1-3/8"	4-1/8"	2-1/16"	1-1/4"	3/8"	3-1/8"
A	110-253F	1-1/4" NPT	2-3/4"	1-3/8"	4-1/8"	2-1/16"	1-7/16"	3/8"	3-1/8"
A	110-254F	1-1/2" NPT	2-3/4"	1-3/8"	4-1/8"	2-1/16"	1-7/16"	3/8"	3-1/8"

Threaded freedom Flange™

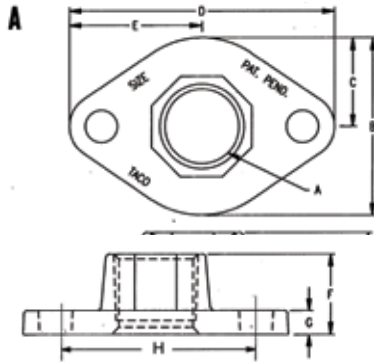

0012 Ductile Iron Freedom Flange Sets (Directly Replaces HV Series Circulators)*

Figure	Product #	Size A	B	C	D	E	F	G	H
A	194-1540F	1-1/4" NPT	2-15/16"	1-15/32"	4-3/4"	2-3/8"	1-9/16"	9/16"	3-7/16"
A	194-1542F	1-1/2" NPT	2-15/16"	1-15/32"	4-3/4"	2-3/8"	1-9/16"	9/16"	3-7/16"

* 1-1/2" Flange set included in each 0012-F4 box.

2" 0012 Ductile Iron Freedom Flange Sets (Directly Replaces 2" Series Circulators)**

Figure	Product #	Size A	B	C	D	E	F	G	H
A	194-1543F	1-1/2" NPT	3-5/8"	1-13/16"	5-9/16"	2-25/32"	1-3/4"	1/2"	4-1/8"
A	194-2124F	2" NPT	3-5/8"	1-13/16"	5-9/16"	2-25/32"	1-3/4"	1/2"	4-1/8"

** 2" Flange set included in each 0012-F4-1 box.

Sweat freedom Flange™

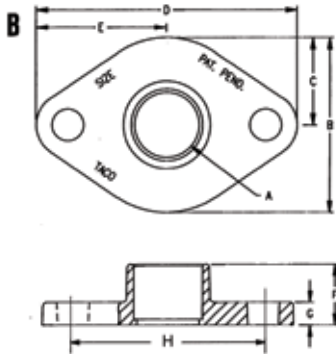

Bronze Freedom Flange™

Bronze Threaded Freedom Flange Sets (005, 007-0011, 0013, 0014, 110-113)

Figure	Product #	Size A	B	C	D	E	F	G	H
A	110-251BF	3/4" NPT	2-3/4"	1-3/8"	4-1/8"	2-1/16"	1-1/4"	3/8"	3-1/8"
A	110-252BF	1" NPT	2-3/4"	1-3/8"	4-1/8"	2-1/16"	1-1/4"	3/8"	3-1/8"
A	110-253BF	1-1/4" NPT	2-3/4"	1-3/8"	4-1/8"	2-1/16"	1-1/4"	3/8"	3-1/8"
A	110-254BF	1-1/2" NPT	2-3/4"	1-3/8"	4-1/8"	2-1/16"	1-1/4"	3/8"	3-1/8"

0012 Bronze Threaded Freedom Flange Sets (Directly Replaces HV Series Circulators)***

Figure	Product #	Size A	B	C	D	E	F	G	H
A	194-1540BF	1-1/4" NPT	2-15/16"	1-15/32"	4-3/4"	2-3/8"	1-9/16"	9/16"	3-7/16"
A	194-1542BF	1-1/2" NPT	2-15/16"	1-15/32"	4-3/4"	2-3/8"	1-9/16"	9/16"	3-7/16"

*** 1-1/2" Flange set included in each 0012-BF4 box.

2" 0012 Bronze Freedom Flange Sets (Directly Replaces HV Series Circulators)****

Figure	Product #	Size A	B	C	D	E	F	G	H
A	194-1543BF	1-1/2" NPT	3-5/8"	1-13/16"	5-9/16"	2-25/32"	1-3/4"	1/2"	4-1/8"
A	194-2124BF	2" NPT	3-5/8"	1-13/16"	5-9/16"	2-25/32"	1-3/4"	1/2"	4-1/8"

**** 2" Flange set included in each 0012-BF4-1 box.

Shut-Off freedom Flange™-Threaded

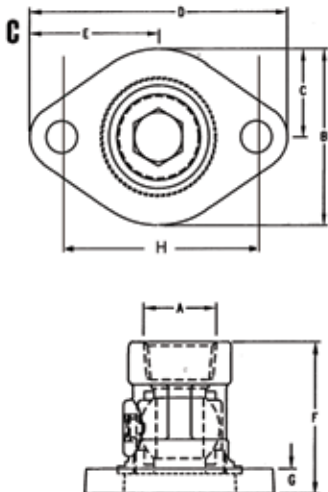

Bronze Sweat Freedom Flange Sets (005, 007-0011, 0013, 0014, 110-113)

Figure	Product #	Size A	B	C	D	E	F	G	H
B	110-522BSF	1/2" Swt	2-3/4"	1-3/8"	4-1/8"	2-1/16"	7/8"	3/8"	3-1/8"
B	110-523BSF	3/4" Swt	2-3/4"	1-3/8"	4-1/8"	2-1/16"	7/8"	3/8"	3-1/8"
B	110-524BSF	1" Swt	2-3/4"	1-3/8"	4-1/8"	2-1/16"	1"	3/8"	3-1/8"
B	110-525BSF	1-1/4" Swt	2-3/4"	1-3/8"	4-1/8"	2-1/16"	1-1/8"	3/8"	3-1/8"
B	110-526BSF	1-1/2" Swt	2-3/4"	1-3/8"	4-1/8"	2-1/16"	1-1/4"	3/8"	3-1/8"

Bronze Shut-Off Freedom Flange™

2-Piece Bronze Shut-Off Freedom Flange Sets (005, 007-0011, 0013, 0014, 110-113)

Figure	Product #	Size A	B	C	D	E	F	G	H
C	254-2	3/4" NPT	2-3/4"	1-3/8"	4-1/8"	2-1/16"	2-3/16"	3/8"	3-1/8"
C	255-2	1" NPT	2-3/4"	1-3/8"	4-1/8"	2-1/16"	1-1/12"	3/8"	3-1/8"
C	256-2	1-1/4" NPT	2-3/4"	1-3/8"	4-1/8"	2-1/16"	2-5/16"	3/8"	3-1/8"

Performance Field Information

60 Hz Performance Field

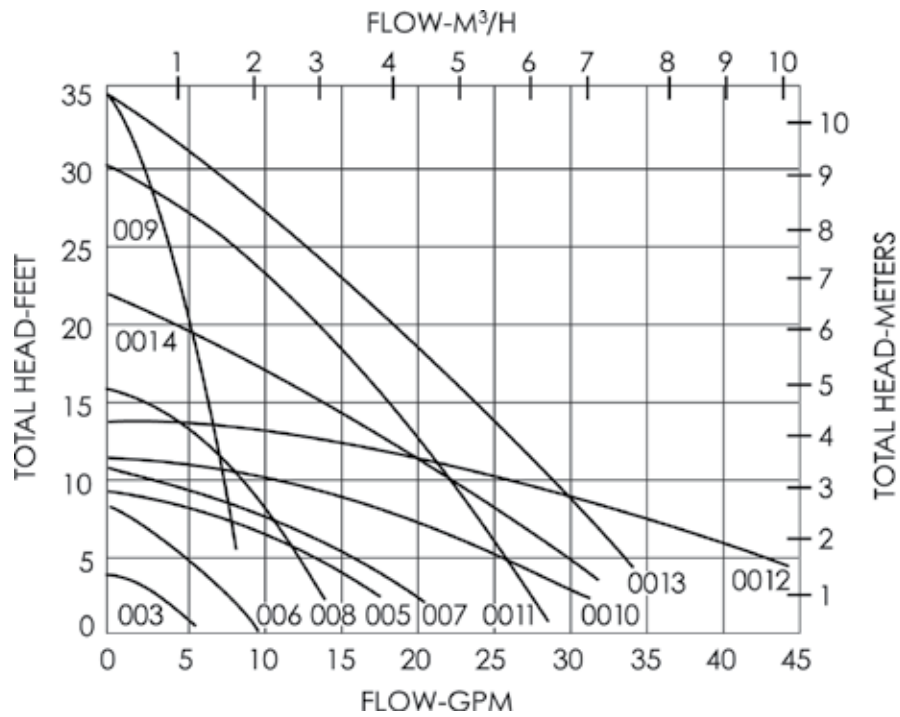

60 Hz Performance Field

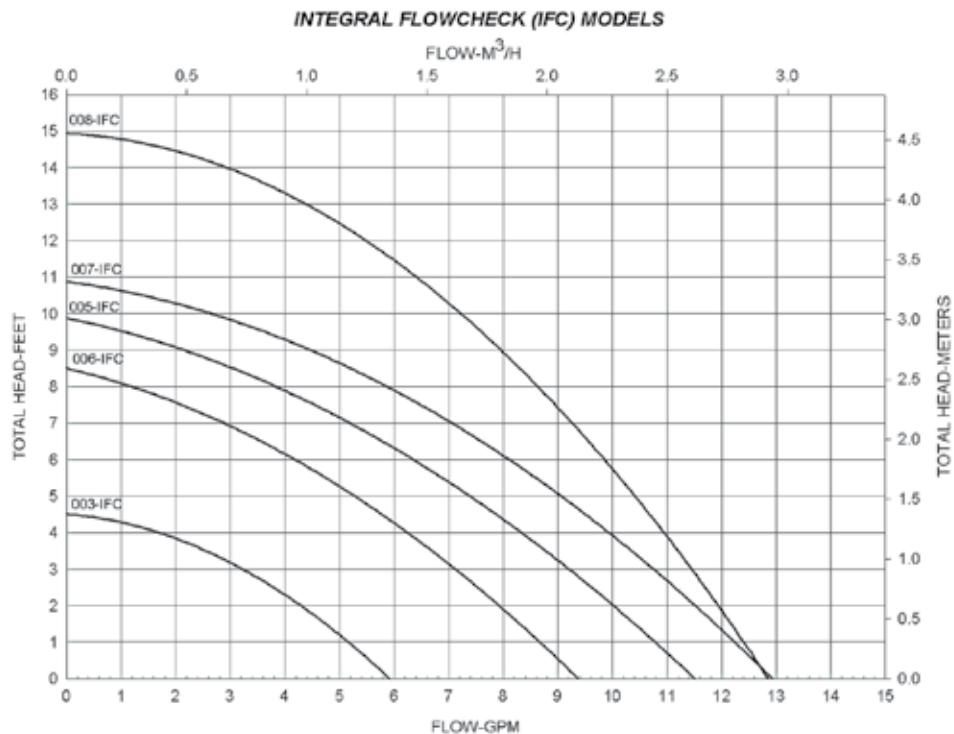

Performance Field Information

50 Hz Performance Field

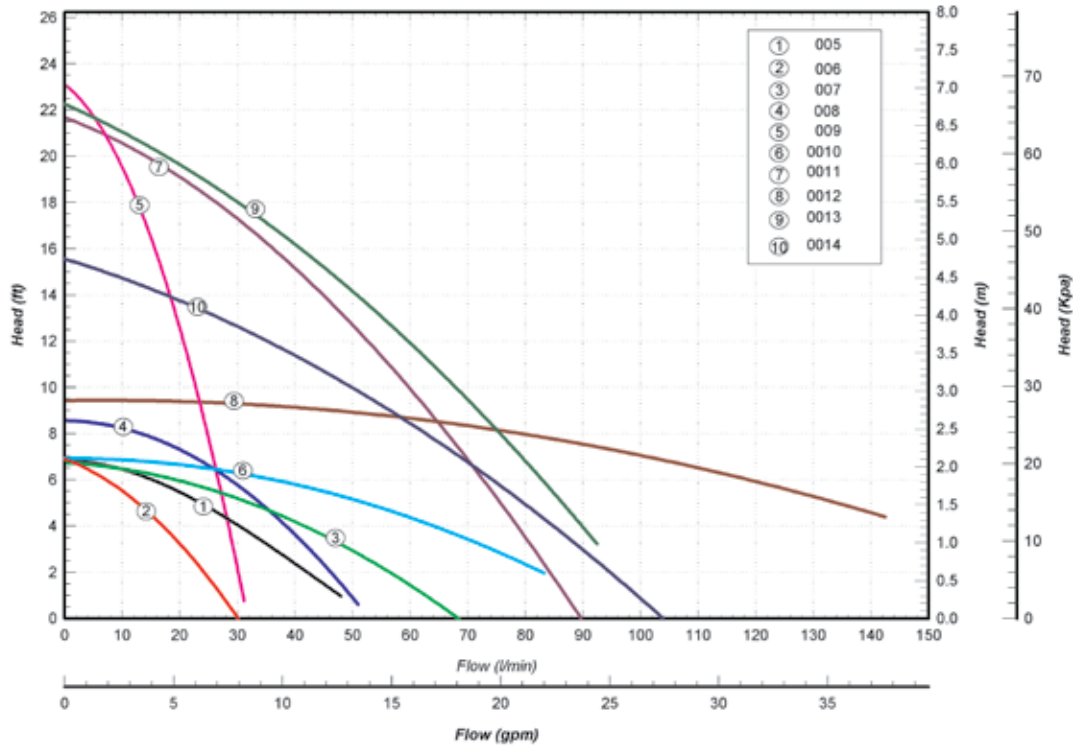

Other Quality Products from Taco®

Wags®

The WAGS® valve shuts off the water supply (plus gas supply for gas-fired water heaters) when it detects a water leak, preventing disastrous flooding and damage to structures and belongings.



Electronic Controls

Whether you're looking for switching relays, zone valves, priority zoning circulators, fan controls or low water cutoffs. Taco has everything you need. Together with Taco zone valves, thermostats, the "00" family of circulators, and a host of add-on controls, we offer the highest quality and broadest selection of zoning products.



5000 Series Mixing Valves

ASSE 1017 approved the 5000 Series Mixing Valve delivers fail-safe security in a high flow, low headloss valve. With an extended mix temperature range of 85°-150°F, it provides the ultimate performance across multiple mixing and diverting applications.



Electronic Ball Valve (EBV) Zone Valve

The most reliable and technologically advanced zone valve on the market. Microcircuit technology lowers the amp draw so you can install up to 12 valves per 40 VA transformer, or use a smaller transformer. The EBV has the industry's highest CV and drop tight shut-off up to 125psi. The lower profile of the EBV allows it to fit into tighter spaces. Last, the EBV features a universal actuator, so it fits all sizes of valves, reduces inventory and can be installed in any position, in any direction.



VorTech® Air Separator

Taco's innovative tangential flow pattern, primary separation chamber and standard Taco Hy-Vent® makes the VorTech® the most effective and reliable air separator on the market. Available in 3/4" - 2" size, they require no minimum run of pipe and have convenient 1/2" bottom tapping for installation of an expansion tank.



Cartridge PRV

Taco's cartridge style pressure reducing valve sets a new standard for performance and serviceability. All the parts are contained in a one-piece cartridge, which can be easily removed and serviced without reducing line pressure. A one handed fast-fill button delivers increased flow to speed system fill times while its unique dial-in pressure setting allows for easy adjustment throughout the 10-50 psi range, without the need for an external gauge.



HYDRONIC COMPONENTS & SYSTEMS

**Do it once.
Do it right.®**  **Taco®**

Taco Inc., 1160 Cranston Street, Cranston, RI 02920 / (401) 942-8000 / Fax (401) 942-2360
Taco (Canada) Ltd., 6180 Ordan Drive, Mississauga, Ontario L5T 2B3 / (905) 564-9422 / Fax (905) 564-9436
www.taco-hvac.com