



# PANEL-TRACK

## Low Profile Hydronic Baseboard Radiation





# PANEL-TRACK

## You can't find a better baseboard!

Panel-Track hydronic baseboard is ideal for any type of residential or light commercial application.

The result of over 40 years of hydronic finned-tube experience Panel-Track's durable yet aesthetically appealing design offers customers one of the cleanest and efficient hydronic baseboards on the market.

Panel-Track hydronic baseboard is the choice of today's heating professional.

### Heavy-Duty Front Panel

Panel-Track's rugged front panel is manufactured out of heavy-gauge steel and stands up to the scratches and dings associated with flimsy competitive models. Panel-Track is built to last and designed to perform.

### Aesthetically Pleasing

Panel-Track offers a modern, streamlined design that blends seamlessly with any type of decor. All finishing accessories including end-caps snap securely into place without the need for additional hardware while maintaining "ease of access" for cleaning and servicing.

### Adjustable Damper

Customize heat output with Panel-Track's finger-touch damper system that can be opened and closed without the use of hinges that can bind or loosen with age.

### Hanger Brackets with Built-In Return

Extra strength hanger brackets allow copper return lines to be installed right in the bracket, eliminating hard-to-use hanging hooks or wires and facilitate easy improvement or relocation along the back panel.

### Efficient Heating Element Design

Embassy's user-friendly element design uses an "Open Box" fin design that prevents fin edges from contacting one another. The boxed and serrated aluminum fins increase radiating surface while directing and increasing convection. Panel-Track's glide shoes allow the heating elements to expand and contract smoothly and quietly.



## Accessories



### End Cap

3" wide left (KCC-L) and right (KCC-R), for use at doorways and wherever a finished end is needed. 3" wide slotted left (KCCS-L) and right (KCCS-R), for through-the-wall connections. Fully telescopic.



### Splicer Set

2" wide (KSP). Three piece snap-on top, front and damper joiner. Joins adjacent baseboard panels. Comes with damper joiner (KDJ-2).



### Outside Corner

90° (KOC-90) and 135°/45° (KOC-45). Use to trim corners at projecting wall. Telescopic up to 1" on each wall.



### Hinged End Caps

5 1/2" wide left (KHC-L) and right (KHC-R). Ideal for semi-recessed installation. Makes removal of front panel easier. Fits flush to the floor. Fully telescopic.



### Inside Corner

90° (KIC-90) and 135°/45° (KIC-45). One piece snap-on for easy installation. Telescopic up to 2 1/2" on each wall.



### Extension Sets

7" wide (KEX-7) and 14" wide (KEX-14). Four sections (back, front, top and damper). Telescopes to fill gaps of 5 1/2" to 12 1/2" between baseboard panels.



### Wall Joiners

3" wide left (KWJ-3), right (KWJ-3R) and 5" left (KWJ-5), right (KWJ-5R). Ideal where piping goes through partitions. Fully telescopic.

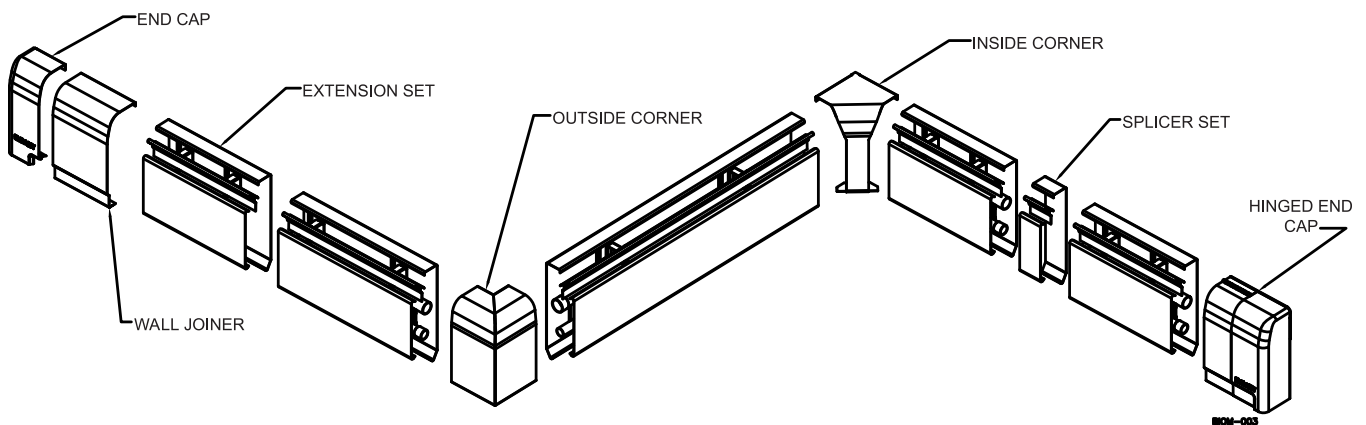

800-003

## Specifications

### Ratings

Model	GPM	Average Hot Water Temperature °F - BTU/Hr./Lin. Ft.									
		120°	130°	140°	150°	160°	170°	180°	190°	200°	210°
KPT-E 3/4"	4	205	261	316	356	419	510	570	630	700	760
	1	195	248	300	338	398	480	540	600	660	720
KVP-D 1/2"	4	216	274	332	374	440	540	600	680	730	790
	1	204	259	314	353	416	510	570	640	690	750

### Dimensional Data

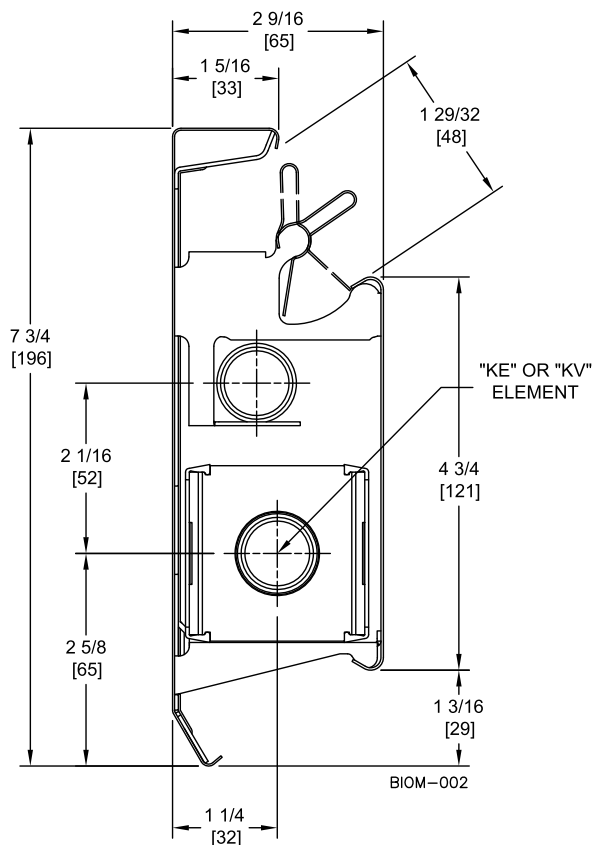

### Correction Factors

If the calculated water flow rate through a baseboard is greater than the standard flow rate (1 GPM), the rating of that unit may be increased by multiplying the standard water rating at 1 GPM by the factor shown for the actual flow rate. All ratings based on 65°F entering air temperature.

### Water Flow Correction Factors

GPM	Heat Output Factor	Pressure Drop – Millinches Per Ft. Copper Element Tube Size	
		3/4"	1/2"
1.0	1.000	47	260
1.5	1.016	96	520
2.0	1.028	157	850
2.5	1.038	230	1270
3.0	1.045	320	1730
3.5	1.051	420	2290
4.0	1.057	525	2880
4.5	1.062	650	3600
5.0	1.067	775	4300
6.0	1.074	1060	5900