



March 2016

Product Catalog & Dimensional Data

InnoFlue®



InnoFlue® SW, Flex & Concentric
Single Wall Rigid, Flexible & Concentric Polypropylene
Category II & IV Special Gas Vent • Gas Vent BH, Class IIC



InnoFlue®

The Intelligent Alternative to PVC & CPVC

Across North America, home owners, maintenance professionals, contractors, distributors, engineers and heating equipment manufacturers are recognizing the unmatched value InnoFlue® delivers to the HVAC industry.

Manufactured from environmentally friendly polypropylene, InnoFlue® has been tested and is listed to all relevant American, Canadian and European Safety Standards. It is listed and warranted for sustained flue gases up to 230°F (110°C), thus providing enhanced performance properties and significant safety margins. Centrotherm offers a comprehensive product line including test/inspection ports, condensate drains, siphons, flue collar adaptors, as well as excellent technical, sales and marketing support.

InnoFlue® Vent Systems are professional, reliable, environmentally sustainable and offer substantial labor savings due to reduced installation times.



**Proudly made
in the U.S.A.**

**Safety
Speed
Innovation**



	InnoFlue®	PVC	CPVC
Chemical Resistance			
<i>Aromatic Hydrocarbons</i>	✓	X	X
<i>Sulfuric Acid</i>	✓	X	X
<i>Hydrochloric Acid</i>	✓	X	X
Working Temperature	0° C (32°F) - 110° C (230°F)	15° C (50°F) - 65° C (149°F)	15° C (50°F) - 90° C (194° F)
Softening Temperature	150° C (302°F)	80° C (176°F)	110° C (230°F)
Environmentally Friendly Production	✓	X	X
No Chloride Leaching	✓	X	X
Fully Recyclable	✓	X	X

Why InnoFlue®?

Ease of Installation

- Integrated gasket system allows for:
 - Faster, cleaner, V.O.C.-free installation
 - Immediate use of appliances upon installation
 - Post-installation adjustments
- No fit up, couplers, primers or adhesives needed
- Light weight makes for easy handling and rapid installation
- **New 1/4" pitch for 2", 3" and 4" Single Wall vent systems**

Health and Safety

ETL Listed: UL 1738, ULC-S636

Listed: CE EN 14471

- Performs at sustained flue temperatures up to 230°F (110°C)
- Listed at zero clearance to combustibles for all systems configurations
- Environmentally-friendly polypropylene is **100% recyclable**
- Industry leading wall thickness enhances structural durability
- Chloride free

Warranty & Reliability

- Manufacturer-supported and guaranteed with an unprecedented 10-year limited warranty
- Enhanced corrosion resistance allows for use with oil, propane, and gas fired appliances
- Over 20 years of field service history



Product Approvals

Since 2010, Centrotherm's InnoFlue® has been accepted and approved by over 50 North American manufacturers of boilers, water heaters and furnaces. For a complete listing of the approvals, visit www.centrotherm.us.com/literature/o-e-m-approvals For appliances that require specific appliance adaptors, contact your manufacturer's representative or Centrotherm Eco Systems.

Listings

Centrotherm made the commitment and investment to have its Single Wall, Flexible and Concentric Vent Systems tested to the industry relevant



UL-1738, ULC-S636 and CE EN 14471 safety standards. Thus InnoFlue® is approved for use in the United States, Canada and most European Countries.

As of this printing, InnoFlue® is the only polymeric vent system to be listed by an accredited third party to the rigorous U.S. safety standard, UL 1738.

For detailed information about Centrotherm's product testing and listing, feel free to visit www.intertek.com

UL 1738
ULC-S636
CE EN 14471



TABLE OF CONTENTS

InnoFlue® SW Residential

Applications and Limitations.....	7
Typical Configurations.....	8

COMPONENTS

Appliance Adaptors

Appliance Adaptor for Coupler Style Flue Collars.....	9
Appliance Adaptor for Flue Collars with Hose Clamp.....	9
Appliance Adaptor SS to InnoFlue®.....	9
Appliance Adaptor 101 mm to InnoFlue®.....	10

Increasesers & Reducers

Eccentric Increaser.....	10
Centric Increaser.....	10
3"/2" Reducer.....	11
Reducers.....	11

Test Ports

Test Port.....	11
----------------	----

Vent Lenth

Rigid Vent Length.....	12
------------------------	----

Base Supports

Base Support.....	12
Base Support Bracket.....	12

Elbows

15° Elbow.....	13
30° Elbow.....	13
45° Elbow.....	13
45° Elbow Long.....	13
87° Elbow.....	14
87° Elbow Long.....	14
Tee.....	14
Tee Cap.....	14

Condensate Management

Horizontal Drain Tee.....	15
Tee Cap with Drain.....	15
Extra Long John Siphon.....	15
Long John Siphon.....	15
Ball Valve Siphon.....	16
Short John Ball Valve Siphon.....	16

Horizontal Vent Kits

Horizontal Vent Kits.....	16
---------------------------	----

Terminations

Chimney Cover PPs-UV.....	17
Chimney Cover SS with PPs-UV End Pipe.....	17
Low Profile Wall Termination.....	17
Universal B-Vent Cap.....	18
Termination Tee.....	18
End Pipe PPs-UV.....	19
Vent Lengths PPs-UV.....	19
45° Elbow Long PPs-UV.....	19
45° Elbow PPs-UV.....	19
87° Elbow Long PPs-UV.....	20
87° Elbow PPs-UV.....	20
PPs to PVC Termination Kit.....	20
Bird Screen PPs-UV.....	20
Bird Screen SS.....	20

Spacers

2", 3", 4", and 5" Spacer.....	21
--------------------------------	----

Accessories

Flue Clamp.....	21
Support Clamp.....	21
Support Clamp Plastic.....	21
Wall Plate Round (Rubber).....	22
Connector Ring.....	22
EPDM Gaskets.....	22
B-Vent Gasket.....	23
Centrocerin.....	23

InnoFlue® Flex

Typical Configurations.....	24
-----------------------------	----

COMPONENTS

Flex Vent Lengths

2" Flex.....	25
3" and 4" Flex.....	25

Couplers

SW to Flex Coupler.....	26
Flex to SW Couplers.....	26
Flex to Flex Couplers.....	26

B-Vent Kits

2" B-Vent Kit.....	27
3" and 4" B-Vent Kit.....	27

Flex Component B-Vent Kits

2" Flex Component B-Vent Kit.....	28
3" and 4" Flex Component B-Vent Kit.....	28

Chimney Kits

2" Chimney Kit.....	29
3" and 4" Chimney Kit.....	29
2" Flex Component Chimney Kit.....	30
3" and 4" Flex Component Chimney Kit.....	30

Terminations

Chimney Covers PPs-UV.....	30
Custom Chimney Cover PPs-UV.....	30
B-Vent Rain Collar PPs-UV.....	31
2" Flex End Pipe.....	31
3" and 4" Flex End Pipe.....	31

InnoFlue® Concentric

Applications and Limitations.....	32
Typical Configurations.....	33

COMPONENTS

Concentric Adaptors

Concentric Centric Inserter.....	33
Concentric Test Port.....	33
Concentric to Twin Pipe Adaptors.....	34
Twin Pipe to Concentric Adaptors.....	34
Concentric Horizontal Drain Tee.....	34

Concentric Vent Lengths

Concentric Vent Length.....	35
-----------------------------	----

Elbows

Concentric 45° Elbow.....	35
Concentric 87° Elbow.....	35

Wall Plates

Wall Plates.....	35
------------------	----

Terminations

Concentric Roof Terminations.....	36
Concentric Wall Terminations.....	36

Accessories

Support Clamp.....	36
--------------------	----

Concentric Kits

Concentric Kit Horizontal.....	37
Concentric Kit Vertical.....	37

InnoFlue® SW Commercial

Applications and Limitations.....	38
Typical Configurations.....	39

COMPONENTS

Appliance Adaptors

Commercial Appliance Adaptor for Coupler Style Flue Collars.....	40
Commercial Appliance Adaptor for Flue Collars with Hose Clamp....	40
Commercial Appliance Adaptor with Condensation Drain & Vibration Isolation Boot OEM to InnoFlue®....	40
Commercial Appliance Adaptors OEM to InnoFlue®.....	41
Commercial Appliance Adaptors SS to PPS.....	41
Vibration Isolation Boot w/ Clamps.....	42

Increases and Reducers

Centric Inserter.....	42
Eccentric Inserter.....	42
Reducer.....	43
Tapered Reducer.....	43

Test Ports

Test Port.....	43
----------------	----

Vent Lengths

Rigid Vent Lengths.....	44
-------------------------	----

Elbows

15° Elbow.....	44
30° Elbow.....	45
45° Elbow.....	45
87° Elbow.....	45
Base Support.....	45

Cascade Components

Branch Tee with Single Feeder.....	46
Branch Tee with Two Feeders.....	46

Branch Tee with Four Feeders.....	46
Non-Return Valve.....	47

Cascade Component Kits

Cascade Component Kits.....	47
-----------------------------	----

Condensate Management

Horizontal Drain Tee.....	48
Horizontal Drain Fitting.....	48
Tee.....	48
Tee Cap.....	48
Tee Cap with Drain.....	49
Extra Long John Siphon.....	49
Long John Siphon.....	49
Ball Valve Siphon.....	49
Short John Ball Valve Siphon.....	50

Terminations

Chimney Cover SS w/ PPs-UV End Pipe.....	50
End Pipe PPs-Gray.....	50
Termination Tees.....	51
Velocity Cone.....	52
PPs to PVC Termination Kit.....	52
Bird Screen PPs-UV.....	52
Bird Screen SS.....	52

Spacers

Spacers.....	53
--------------	----

Accessories

Flue Clamp.....	53
Connector Ring.....	53
Connector Double Hose Clamp.....	54
Support Clamp.....	54
EPDM Gaskets.....	54
Wall Plate Square Steel.....	54
Centrocerin.....	54

Leaders Sustainability Dynamic Efficient
Experience Safety Creative Energy Health
Innovative Solutions Unprecedented Diverse

WORLDWIDE

Established in 2009 for the purpose of introducing Polypropylene Vent Systems to the North American market, **Centrotherm Eco Systems** is the most recent addition to the Ubbink Centrotherm Group.

Ubbink was founded in the Netherlands in 1896. In 1976, Centrotherm Systemtechnik was established in Brilon, Germany, and in 1998, CENTROTEC Sustainable AG was formed as its parent holding company. Subsequently, Ubbink was acquired by Centrotec Sustainable AG in 2000. Today, CENTROTEC is one of Europe's leading manufacturers of a variety of sustainable building solutions, as you will find by visiting: <http://centrotec.de>.

Now, **Centrotherm Eco Systems** produces its InnoFlue® Vent Systems based on a wealth of technical know-how and experience accumulated over time. Field proven for 20 years, it has been installed and is performing successfully in millions of homes in the North American and European markets today.

Centrotherm Eco Systems supplies its standard **InnoFlue®** vent products to heating professionals through heating and plumbing wholesalers, as well as commercial spec. representatives.

Centrotherm Eco Systems also designs, produces, and delivers internal equipment components to many OEMs of high efficiency boilers, tankless water heaters and furnaces.

The following catalog pages describe our standard products available today.

We are looking forward to your feedback and input to help keep our products on the cutting edge of technology, simplicity, and ease of installation.



INNOFLUE® Polypropylene Vent Systems

Applications and Limitations

- In order to maintain relevant listings and Centrotherm's warranty, **InnoFlue®** vent systems may not be combined with any polymeric or stainless steel vent components that are not part of Centrotherm's published offerings.
- **InnoFlue®** SW and **InnoFlue®** Flex must be installed following Centrotherm's published installation instructions.
- **InnoFlue®** SW and **InnoFlue®** Flex are ETL listed UL and ULC for use with natural gas or propane fired, Cat. II or Cat. IV appliances (United States) or BH Gas Class II A, B and C gas or propane fired appliances (Canada).
- **InnoFlue®** SW and **InnoFlue®** Flex can also be used for oil fired, condensing appliances with a maximum flue gas temperature that does not exceed 230°F (110°C).
- **InnoFlue®** SW and **InnoFlue®** Flex are ETL listed to UL 1738 and ULC-S636 at zero clearance to combustibles.
- **InnoFlue®** SW may be installed inside a masonry or sheet rocked chase, through an existing structurally intact metal flue, between floor joists, directly through a wall or if properly supported, can even be left exposed along the interior of a structure.
- **InnoFlue®** Flex is available in 2", 3" and 4" diameters and offers all necessary components for combining it with **InnoFlue®** SW and InnoFlue Concentric to meet specific job requirements.
- **InnoFlue®** Flex may be used in offsets or bends not to exceed 45 degrees from vertical.
- **InnoFlue®** Flex must be installed inside a masonry chimney or sheet rocked chase, or through an existing, structurally intact metal flue.
- Single or multiple **InnoFlue®** Flex runs may be installed into an existing masonry chimney or structurally intact metal flue or chase.
- Do not install where ambient air temperature can exceed 300°F.

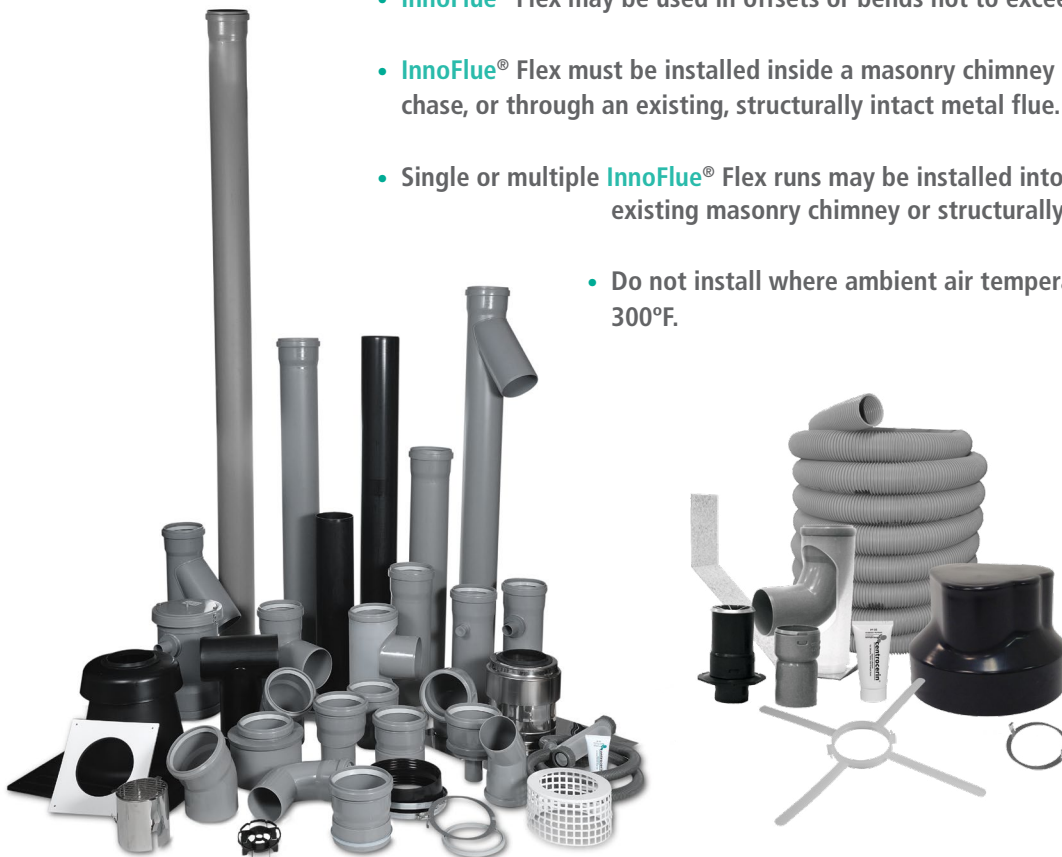

INNOFLUE® SINGLE WALL TYPICAL INSTALLATIONS

- 2 ISEL87: 87° Elbow
- 3 ISVL: Vent Length
- 4 IASCM: Support Clamp
- 5 IANS: Connector Ring
- 6 IAWP: Wall Plate
- 7 ISEP: End Pipe PPs-UV
- 8 ISTT: Termination Tee PPs-UV
- 9 IASPP: Bird Screen PPs-UV
- 11 ISELLUV: 87° Elbow Long PPs-UV
- 12 ISAGL or ISAAL: Appliance Adaptor
- 13 ISLPT: Low Profile Wall Termination
- 14 ICTC: Twin Pipe to Concentric Adaptor
- 15 ICRT: Concentric Roof Termination
- 16 ISVLUV: Vent Length PPs-UV Black
- 24 ISBS: Base Support
- 25 IASP: Spacer
- 27 IFVL: Flexible Vent Length
- 28 ISCP: Chimney Cover PPs-UV
- 29 IFEP: Flex End Pipe
- 30 IFFSC: Flex to SW Coupler
- 36 IAUBV: Universal B-Vent Cap
- 37 IFPT: Custom Chimney Cover

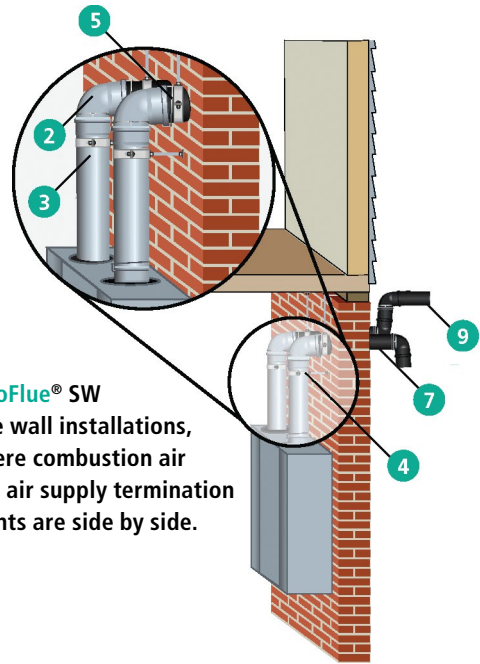

InnoFlue® SW side wall installations, where combustion air and air supply termination points are side by side.

InnoFlue® SW side wall installations where combustion air and supply termination points can be significantly separated.

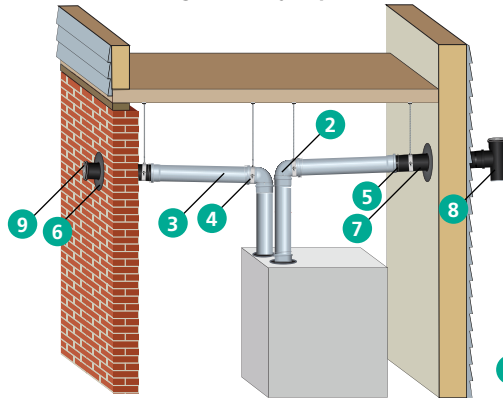

Separated with a Twin Pipe to Concentric Adaptor below the roof for the final concentric vent run and Concentric Roof Termination.

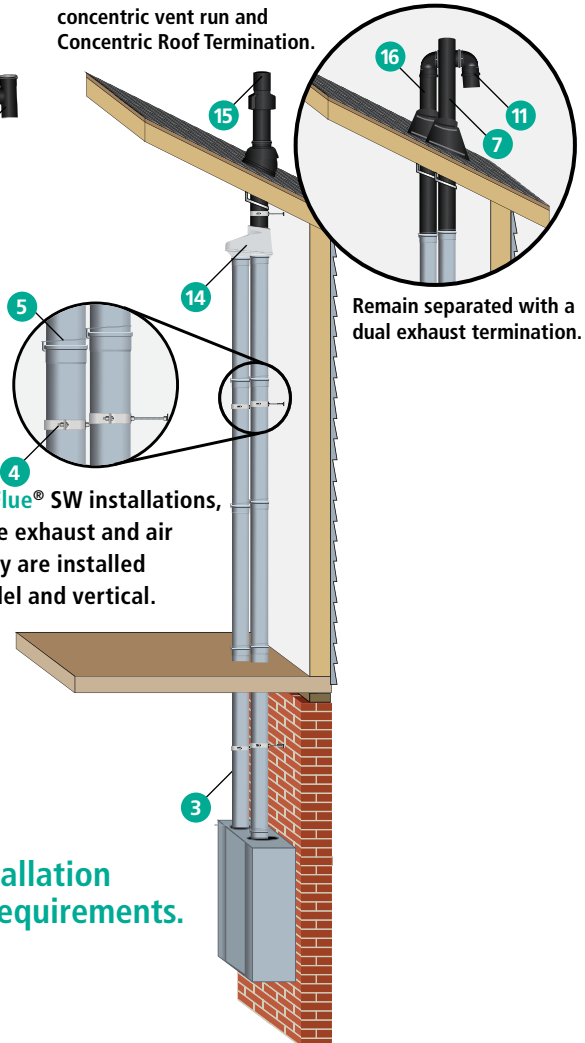

Remain separated with a dual exhaust termination.

InnoFlue® SW side wall installations, where exhaust and air supply remain separated through the Low Profile Wall Termination.

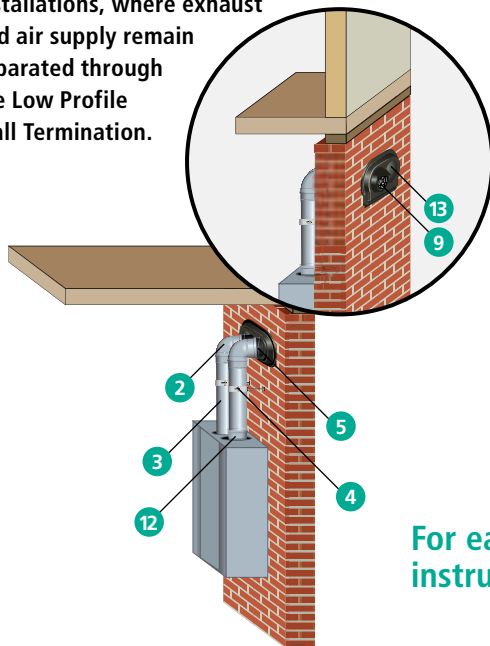

For each configuration, see installation instructions and specific code requirements.

Appliance Adaptors

Check adaptor matrix at www.centrotherm.us.com/literature/o-e-m-approvals



Appliance Adaptor for Coupler Style Flue Collars

Adapts a female PVC / CPVC coupler or appliance flue exhaust to InnoFlue® SW diameters.

Nominal Diameter PVC to PP	Part #	Overall Length "A"	Effective Length "B"	Max O.D. "C"
2"/2" (60/60)	ISAGL0202	3.3 (83)	1.0 (26)	3.0 (76)
3"/3" (89/80)	ISAGL0303	3.0 (75)	0.8 (21)	3.8 (97)
4"/4" (114/110)	ISAGL0404	3.4 (87)	0.8 (21)	5.1 (129)
5"/5" (140/125)	ISAGL0505	5.7 (144)	0.8 (21)	5.8 (146)

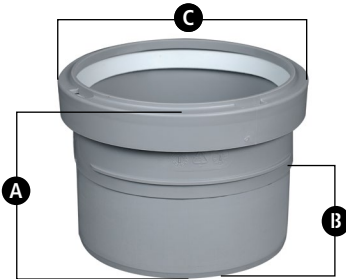

Appliance Adaptor for Flue Collar with Hose Clamp

Adapts a female PVC / CPVC sized appliance collar (with integrated gasket) to InnoFlue® SW diameters.

Nominal Diameter PVC to PP	Part #	Overall Length "A"	Effective Length "B"	Max O.D. "C"
2"/2" (60/60)	ISAAL0202	3.3 (83)	1.0 (26)	3.0 (76)
3"/3" (89/80)	ISAAL0303	3.0 (75)	0.8 (21)	3.8 (97)
4"/4" (114/110)	ISAAL0404	3.4 (87)	0.8 (21)	5.1 (129)
5"/5" (140/125)	ISAAL0505	5.7 (144)	0.8 (21)	5.8 (146)

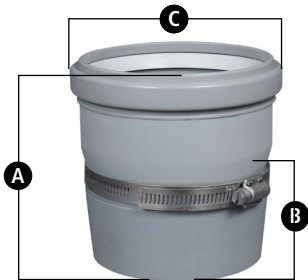

Appliance Adaptor SS to InnoFlue®

Adapts a tapered female stainless steel appliance flue exhaust with tabs to InnoFlue®.

Nominal Diameter	Part #	Overall Length "A"	Effective Length "B"	Max O.D. "C"
3" (80)	ISAAS0303	4.5 (115)	0.8 (21)	3.8 (97)
4" (110)	ISAAS0404	4.8 (122)	0.8 (21)	5.1 (129)

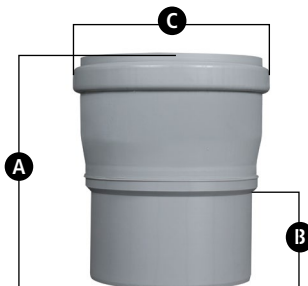

Appliance Adaptor SS to InnoFlue®

Adapts a stainless steel appliance flue exhaust with gasket and clamp to InnoFlue®.

Nominal Diameter	Part #	Overall Length "A"	Effective Length "B"	Max O.D. "C"
3"/3" (76/80)	ISSA0303	6.0 (153)	3.1 (78)	3.8 (97)
4"/4" (102/110)	ISSA0404	6.0 (153)	3.6 (91)	5.1 (129)
5"/5" (127/125)	ISSA0505	6.5 (166)	3.9 (99)	5.8 (146)

SW Residential



Appliance Adaptors 101mm to PPs

Adapts 101mm diameter flue exhaust to InnoFlue.® Adaptors include replacement o-ring for flue collar.

Nominal Diameter PVC to PP	Part #	Overall Length "A"	Effective Length "B"	Max O.D. "C"
4" (100/101)/3" (80)	ISA010103	6.5 (165)	3.3 (84)	3.8 (97)
4" (100/101)/4" (110)	ISA010104	6.4 (163)	4.0 (102)	5.1 (129)

Custom Appliance Adaptors Available

Available to fit most residential and commercial heating appliances. Call for pricing.

Increasesers & Reducers

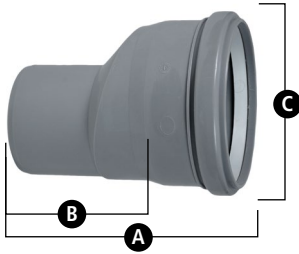

Eccentric Increaser

Transitions vent system to a larger diameter. Install in horizontal or vertical orientation. Other size combinations available upon request.

Nominal Diameter	Part #	Overall Length "A"	Effective Length "B"	Max O.D. "C"
2"/3" (60/80)	ISEI0203	5.3 (135)	3.1 (79)	3.8 (97)
3"/4" (80/110)	ISEI0304	6.1 (156)	3.6 (91)	5.1 (129)
4"/5" (110/125)	ISEI0405	6.7 (170)	4.2 (106)	5.8 (146)



Centric Increaser

Transitions vent system to a larger diameter. Install in vertical orientation only. Additional configurations available upon request.

Nominal Diameter	Part #	Overall Length "A"	Effective Length "B"	Max O.D. "C"
2"/3" (60/80)	ISIA0203	5.9 (150)	3.5 (89)	3.8 (97)
3"/4" (80/110)	ISIA0304	5.7 (145)	3.2 (81)	5.1 (129)
4"/4" (100/110)	ISIA10004	6.4 (163)	4.2 (105)	5.1 (129)
4"/5" (110/125)	ISIA0405	6.8 (173)	4.3 (110)	5.8 (146)

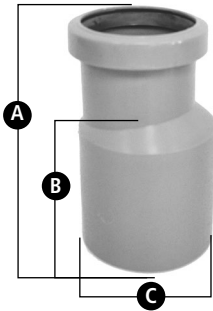

3 1/2" Reducer

Transitions vent system to a smaller diameter.

Nominal Diameter	Part #	Overall Length "A"	Effective Length "B"	Max O.D. "C"
3 1/2" (80/60)	ISR0302	60 (153)	3.5 (89)	3.2 (80)

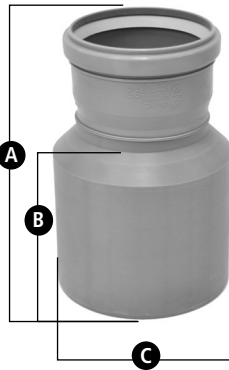

Reducers

Transitions vent system to a smaller diameter.

Nominal Diameter	Part #	Overall Length "A"	Effective Length "B"	Max O.D. "C"
4 1/3" (110/80)	ISR0403	6.0 (153)	3.5 (89)	4.3 (110)
5 1/4" (125/110)	ISR0504	6.5 (166)	4.0 (102)	4.9 (125)
6 1/4" (160/110)	ISR0604	6.5 (166)	4.0 (102)	6.3 (160)
6 1/5" (160/125)	ISR0605	6.5 (166)	4.0 (102)	6.3 (160)
5 1/5" (130/125)	ISR13005	5.0 (127)	4.7 (120)	5.1 (130)
6 1/4" (150/110)	ISR15004	8.8 (223)	6.5 (165)	5.9 (150)
6 1/5" (150/125)	ISR15005	9.1 (230)	6.7 (170)	5.9 (150)

Test Ports

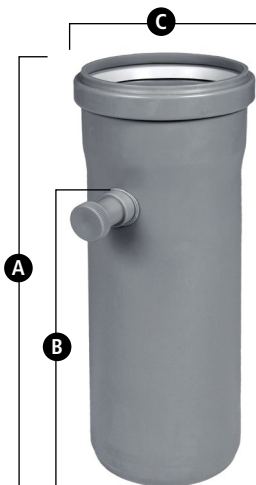

Test Port

Installed immediately above the appliance, the test port allows plumbing and heating professionals to sample flue gases and ensure the appliance is operating at optimum efficiency.

Nominal Diameter	Part #	Overall Length "A"	Effective Length "B"	Max O.D. "C"
2" (60)	ISTP02	7.0 (170)	4.3 (110)	3.0 (76)
3" (80)	ISTP03	7.0 (170)	4.5 (115)	3.8 (97)
4" (110)	ISTP04	12.4 (314)	9.8 (250)	5.1 (129)
5" (125)	ISTP05	12.6 (320)	9.8 (250)	5.8 (146)

Vent Lengths

Residential
SW

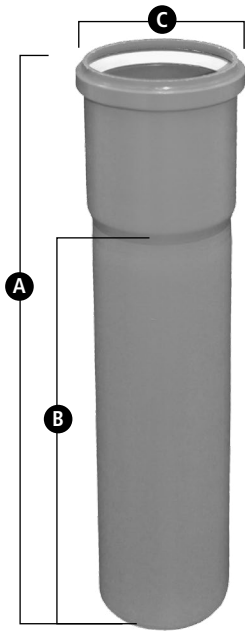

Rigid Vent Length

Gasketed rigid polypropylene vent lengths with dedicated male and female ends. Male ends can be field cut and chamfered.

Nominal Diameter	Part #	Overall Length "A"	Effective Length "B"	Max O.D. "C"
2" (60)	ISVL021	16.4 (411)	12 (305)	3.0 (76)
2" (60)	ISVL022	28.4 (716)	24 (610)	3.0 (76)
2" (60)	ISVL023	40.4 (1021)	36 (914)	3.0 (76)
2" (60)	ISVL026	76.4 (1935)	72 (1829)	3.0 (76)
3" (80)	ISVL031	16.4 (411)	12 (305)	3.8 (97)
3" (80)	ISVL032	28.4 (716)	24 (610)	3.8 (97)
3" (80)	ISVL033	40.2 (1021)	36 (914)	3.8 (97)
3" (80)	ISVL036	76.4 (1935)	72 (1829)	3.8 (97)
4" (110)	ISVL041	16.0 (406)	12 (305)	5.1 (129)
4" (110)	ISVL042	28.0 (711)	24 (610)	5.1 (129)
4" (110)	ISVL043	40.2 (1016)	36 (914)	5.1 (129)
4" (110)	ISVL046	76.2 (1930)	72 (1829)	5.1 (129)
5" (125)	ISVL051	15.9 (404)	12 (305)	5.8 (146)
5" (125)	ISVL052	27.9 (709)	24 (610)	5.8 (146)
5" (125)	ISVL053	39.9 (1013)	36 (914)	5.8 (146)
5" (125)	ISVL056	75.9 (1928)	72 (1829)	5.8 (146)

Base Supports

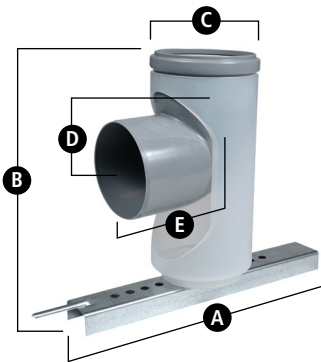

Base Support

Supports vertical sections of rigid (up to 164') and flexible (up to 98' with Flex end pipe) vent lengths installed in chimneys and chases.

Nominal Diameter	Part #	Base Length "A"	Height "B"	Max O.D. "C"	Effective "D"	Effective "E"
2" (60)	ISBS0287	15.8 (400)	9.4 (238)	3.0 (76)	2.7 (69)	4.6 (118)
3" (80)	ISBS0387	15.8 (400)	10.6 (269)	3.8 (97)	3.4 (86)	4.9 (125)
4" (110)	ISBS0487	15.8 (400)	11.5 (291)	5.1 (129)	2.6 (65)	4.5 (115)
5" (125)	ISBS0587	15.8 (400)	13.4 (341)	5.8 (146)	2.9 (74)	5.4 (136)

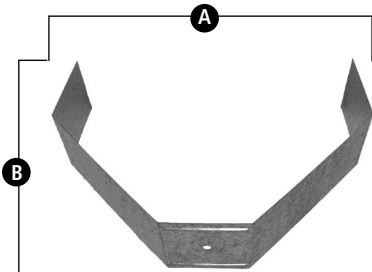

Base Support Bracket

B-Vent Support Bracket (IABVSB) replaces metal channel on base support to support vertical sections of rigid and flexible vent lengths installed inside a B-Vent. Fastens to floor joists.

Part #	Width "A"	Height "B"
IABVSB	17.5 (446)	11.8 (298)

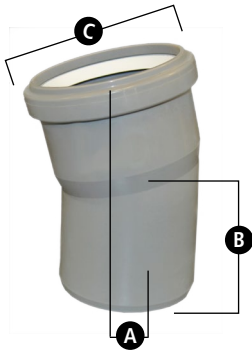

15° Elbow

For offsets or changes in the direction of the vent system.

Nominal Diameter	Part #	Centerline Offset "A"	Effective Length "B"	Max O.D. "C"
2" (60)	ISEL0215	0.7 (18)	3.3 (84)	3.0 (76)
3" (80)	ISEL0315	0.7 (18)	3.1 (79)	3.8 (97)
4" (110)	ISEL0415	0.8 (20)	3.6 (91)	5.1 (129)
5" (125)	ISEL0515	0.9 (23)	4.6 (117)	5.8 (146)

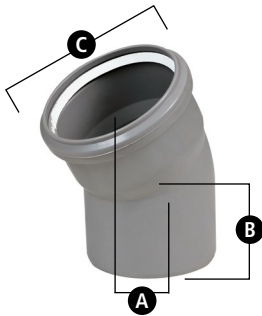

30° Elbow

For offsets or changes in the direction of the vent system.

Nominal Diameter	Part #	Centerline Offset "A"	Effective Length "B"	Max O.D. "C"
2" (60)	ISEL0230	1.5 (38)	3.6 (91)	3.0 (76)
3" (80)	ISEL0330	1.4 (36)	3.4 (86)	3.8 (97)
4" (110)	ISEL0430	1.7 (43)	4.1 (104)	5.1 (129)
5" (125)	ISEL0530	1.8 (46)	5.1 (130)	5.8 (146)

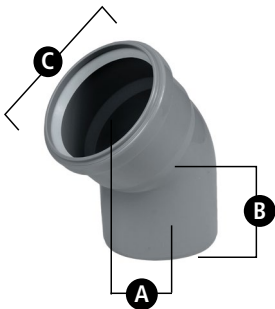

45° Elbow

For offsets or changes in the direction of the vent system.

Nominal Diameter	Part #	Centerline Offset "A"	Effective Length "B"	Max O.D. "C"
3" (80)	ISEL0345	2.2 (56)	3.6 (92)	3.8 (97)
4" (110)	ISEL0445	2.2 (63)	4.1 (105)	5.1 (129)
5" (125)	ISEL0545	2.7 (68)	4.8 (122)	5.8 (146)

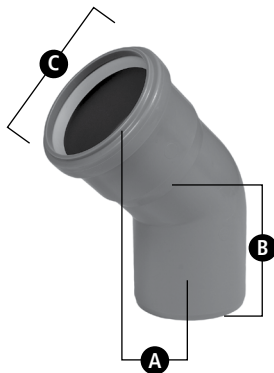

45° Elbow Long

Longer 45° Elbow allows for greater offsets or changes in the direction of the vent system.ns.

Nominal Diameter	Part #	Centerline Offset "A"	Effective Length "B"	Max O.D. "C"
2" (60)	ISELL0245	2.2 (56)	3.8 (96)	3.0 (76)
3" (80)	ISELL0345	2.9 (73)	4.6 (117)	3.7 (97)

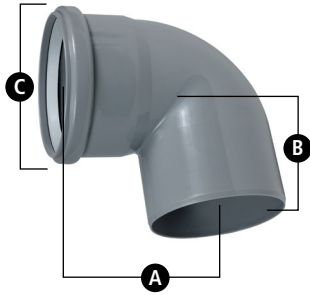

87° Elbow

For offsets or changes in the direction of the vent system.

Nominal Diameter	Part #	Centerline Offset "A"	Effective Length "B"	Max O.D. "C"
2" (60)	ISELL0287	2.5 (63)	4.8 (121)	3.0 (76)
3" (80)	ISEL0387	5.3 (133)	5.0 (127)	3.7 (97)
4" (110)	ISEL0487	2.4 (60)	4.6 (118)	5.1 (129)
5" (125)	ISEL0587	2.7 (68)	5.5 (139)	5.8 (146)



Tee

Use to change the direction of the vent system, combine multiple appliances, and capture condensates at base of long vertical runs.

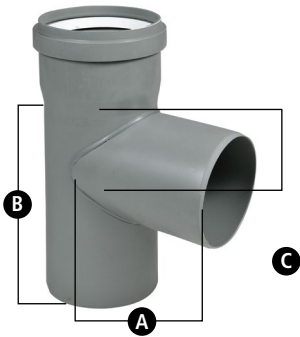

Nominal Diameter	Part #	Effective Length "A"	Effective Length "B"	Effective Length "C"
2" (60)	IST02	6.3 (160)	8.7 (221)	2.6 (66)
3" (80)	IST03	6.3 (160)	8.7 (221)	2.7 (69)
4" (110)	IST04	5.6 (142)	8.4 (214)	3.0 (76)
5" (125)	IST05	5.9 (149)	10.1 (256)	3.7 (94)

Tee Cap

Seals non-utilized tees and branch tees.



Nominal Diameter	Part #	Max O.D. "A"
2" (60)	ISTC02	3.0 (76)
3" (80)	ISTC03	3.8 (97)
4" (110)	ISTC04	5.1 (129)
5" (125)	ISTC05	5.8 (146)

Condensate Management

Horizontal Drain Tee

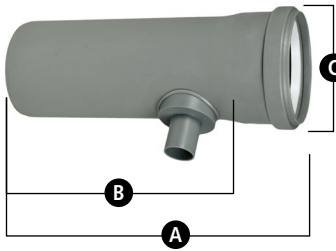

Use with any InnoFlue® siphon to drain condensate from the vent system. Install in horizontal section closest to appliance. 1.26" (32mm) O.D. drain.

Nominal Diameter	Part #	Overall Length "A"	Effective Length "B"	Max O.D. "C"
2" (60)	ISHDT02	9.8 (250)	7.3 (186)	3.0 (76)
3" (80)	ISHDT03	9.8 (250)	7.3 (186)	3.7 (94)
4" (110)	ISHDT04	12.4 (315)	9.8 (250)	4.1 (129)
5" (125)	ISHDT05	12.4 (315)	9.8 (250)	5.8 (146)

Tee Cap with Drain

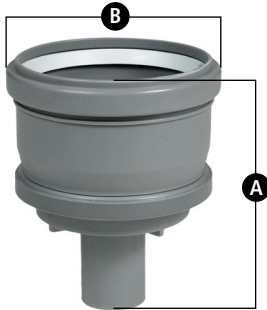

Use with any InnoFlue® siphon to drain condensate from the vent system.

Nominal Diameter	Part #	Overall Length "A"	Max O.D. "B"	Drain O.D. "C"
2" (60)	ISTCD02	6.1 (155)	3.0 (75)	1.3 (32)
3" (80)	ISTCD03	5.3 (135)	3.7 (95)	1.3 (32)
4" (110)	ISTCD04	5.9 (150)	5.0 (126)	1.3 (32)
5" (125)	ISTCD05	6.4 (163)	5.8 (146)	1.3 (32)

Extra Long John Siphon

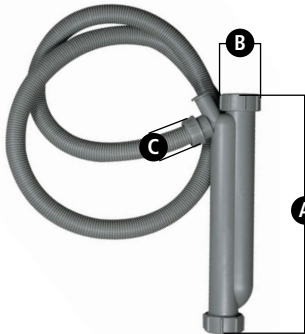

Attaches to any InnoFlue® drain. Allows condensates to flow while containing combustion gases.

Nominal Diameter	Part #	Overall Length "A"	I.D. "B"	O.D. "C"
1.3 (32)	IAELJS	11.9 (302)	1.3 (32)	1.3 (32)

Long John Siphon

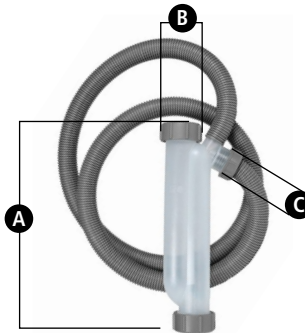

Attaches to any InnoFlue® drain. Allows condensates to flow while containing combustion gases.

Nominal Diameter	Part #	Overall Length "A"	I.D. "B"	O.D. "C"
1.3 (32)	IALJS	9.7 (247)	1.3 (32)	1.3 (32)

Residential
SW

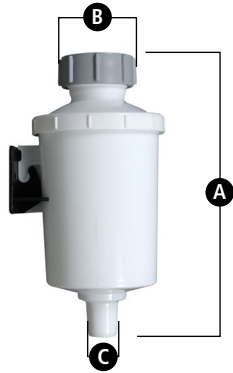

Ball Valve Siphon

Attaches to any InnoFlue® drain to allow condensates to flow while containing combustion gases.

Nominal Diameter	Part #	Overall Length "A"	I.D. "B"	O.D. "C"
1.3 (32)	IASBV	7.3 (187)	1.3 (32)	0.8 (20)

NEW!

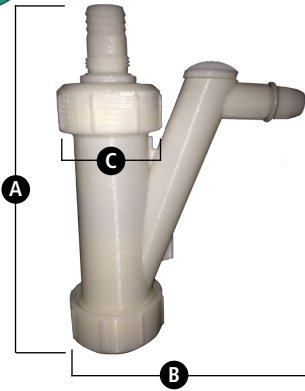

Short John Ball Valve Siphon

Attaches to any InnoFlue® drain. Allows condensates to flow while unique ball valve assures combustion gases remain contained at higher temperatures.

Part #	Overall Height "A"	Width "B"	Length "C"
IASJBVS	6.5	4.5	1.9

Horizontal Vent Kits



Horizontal Vent Kit

Includes all fittings and accessories required for short sidewall termination vent runs.

Nominal Diameter	Part #
2" (60)	ISVKH02
3" (80)	ISVKH03
4" (110)	ISVKH04
5" (125)	ISVKH05

Terminations

SW Residential

Chimney Cover PPs-UV

This termination incorporates a combustion air intake and flue gas termination in a single assembly. Cover seals top of the chimney or chase. Use with End Pipe or Flex End Pipe. End Pipes sold separately.

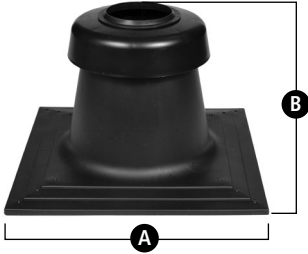

Nominal Diameter	Part #	Length "A"	Height "B"
2" (60)	ISCP02	15.8 (400)	9.6 (245)
3" (80)	ISCP03	15.8 (400)	9.6 (245)
4" (110)	ISCP04	15.8 (400)	9.6 (245)

Chimney Cover SS W/PPs-UV End Pipe

Stainless steel termination with polypropylene end pipe incorporates a combustion air intake and flue gas termination in a single assembly.

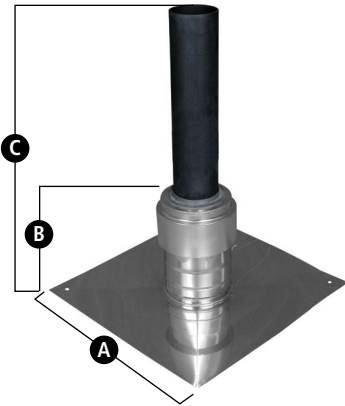

Nominal Diameter	Part #	Length "A"	Height "B"	Height "C"
5" (125)	ISCM05	15.8 (400)	7.9 (200)	19.7 (500)

Low Profile Wall Termination

Low Profile Wall Termination incorporates air intake and exhaust into a single aesthetically pleasing termination. Part is paintable to match exterior of structure. Comes with interior wall plate and bird screen. Exhaust can be extended or re-directed with elbows or vent lengths. Vent lengths and elbows sold separately.

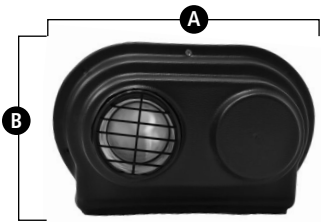

Nominal Diameter	Part #	Overall Width "A"	Overall Height "B"
2" (60)	ISLPT0202	13 (330)	9.1 (231)
3" (80)	ISLPT0303	13 (330)	9.1 (231)



NEW!

Residential
SW



Universal B-Vent Cap

Allows for multiple flue configurations. Utilize existing B-Vent as a chase. Clean, professional and aesthetically pleasing. Installs quickly and easily.

Part #	Length	Height	Width
IAUBVC	10"	10"	10"

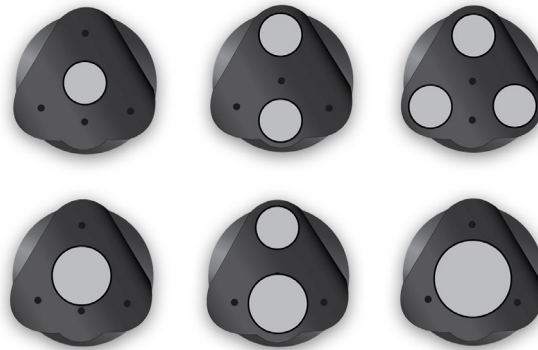

One Part → Multiple Configurations

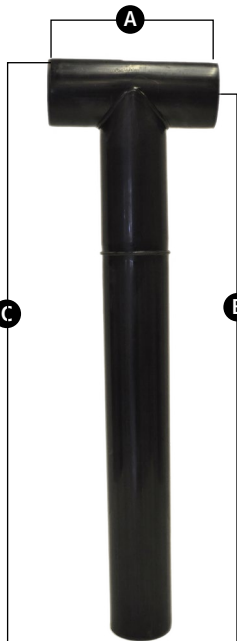

Termination Tee

Made from black U.V. stabilized polypropylene. Use where termination is exposed to excessive sunlight, wind or prone to freeze ups.

Nominal Diameter	Part #	Overall Width "A"	Effective Length "B"	Max Length "C"
2" (60)	ISTT0220	7.6 (193)	27.6	28.8
3" (80)	ISTT0320	7.6 (193)	27.6	29.2
4" (110)	ISTT0420	7.6 (193)	27.6	29.8
5" (125)	ISTT0520	8.0 (203)	27.6	30.1

End Pipe PPs-UV

Made from black U.V. stabilized polypropylene. Use where termination is exposed to excessive sunlight.

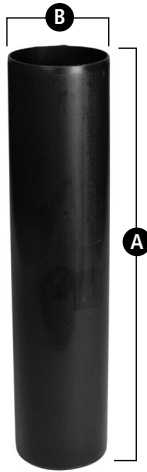

Nominal Diameter	Part #	Overall Length "A"	Max O.D. "B"
2" (60)	ISEP02	19.7 (500)	2.4 (60)
2" (60)	ISEP0239	39.4 (1000)	2.4 (60)
3" (80)	ISEP03	19.7 (500)	3.2 (80)
3" (80)	ISEP0339	39.4 (1000)	3.2 (80)
4" (110)	ISEP04	19.7 (500)	4.3 (110)
4" (110)	ISEP0439	39.4 (1000)	4.3 (110)
5" (125)	ISEP05	19.7 (500)	4.9 (125)
5" (125)	ISEP0539	39.4 (1000)	4.9 (125)

Vent Lengths PPs-UV

PPs-UV Vent Lengths allow for the exterior extension of the vent system.

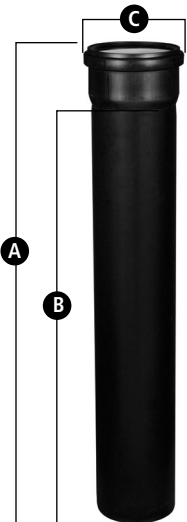

Nominal Diameter	Part #	Overall Length "A"	Effective Length "B"	Max O.D. "C"
2" (60)	ISVL022UV	28.4 (721)	24 (610)	3.0 (75)
3" (80)	ISVL032UV	28.4 (721)	24 (610)	3.8 (97)
4" (110)	ISVL042UV	28.2 (716)	24 (610)	5.1 (129)
5" (125)	ISVL052UV	26.5 (673)	24 (610)	5.8 (146)

45° Elbow Long PPS-UV

For exterior offsets or changes in the direction of the vent system.

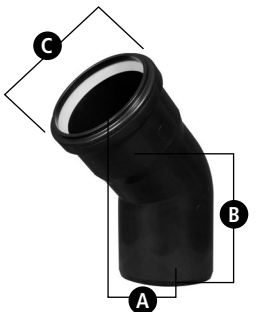

Nominal Diameter	Part #	Centerline Offset "A"	Effective Length "B"	Max O.D. "C"
2" (60)	ISELL0245UV	2.2 (56)	3.8 (96)	3.0 (76)
3" (80)	ISELL0345UV	2.9 (73)	4.6 (117)	3.8 (97)

45° Elbow PPS-UV

For exterior offsets or changes in the direction of the vent system.

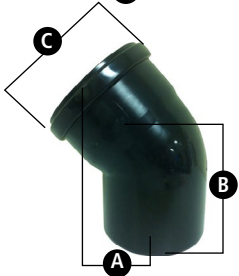

Nominal Diameter	Part #	Centerline Offset "A"	Effective Length "B"	Max O.D. "C"
4" (110)	ISEL0445UV	2.2 (63)	4.1 (105)	5.1 (129)

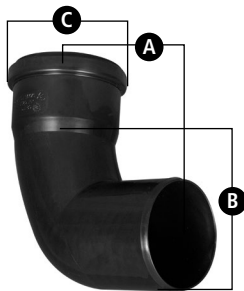

87° Elbow Long PPS-UV

For exterior offsets or changes in the direction of the vent system.

Nominal Diameter	Part #	Centerline Offset "A"	Effective Length "B"	Max O.D. "C"
2" (60)	ISELL0287UV	2.5 (63)	4.8 (121)	3.0 (76)
3" (80)	ISELL0387UV	5.3 (133)	5.1 (129)	3.8 (97)



87° Elbow PPS-UV

For exterior offsets or changes in the direction of the vent system.

Nominal Diameter	Part #	Centerline Offset "A"	Effective Length "B"	Max O.D. "C"
4" (110)	ISEL0487UV	2.4 (80)	4.6 (118)	5.1 (129)

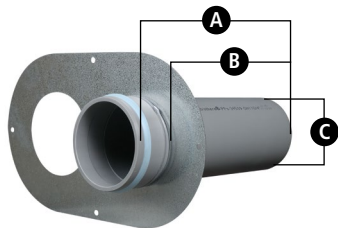

PPs to PVC Termination Kit

Adapts PPs to PVC Twin Pipe Termination. Comes with replacement wall plate and termination adaptor.

Nominal Diameter	Part #	Overall Length "A"	Effective Length "B"	End O.D. "C"
2" (60)	ISLTK02	12.3 (313)	11.0 (280)	2.4 (61)
3" (80)	ISLTK03	13.0 (330)	11.0 (280)	3.5 (89)
4" (110)	ISLTK04	13.2 (336)	11.0 (280)	4.5 (115)



Bird Screen PPS-UV

Fits inside InnoFlue® SW and Flex end-pipes at terminations.

Nominal Diameter	Part #
2" (60)	IASPP02
3" (80)	IASPP03
4" (110)	IASPP04



Bird Screen SS

Fits inside InnoFlue® SW and Flex end-pipes at terminations.

Nominal Diameter	Part #
5" (125)	IASSS05

Spacers

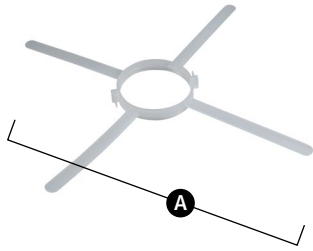

2", 3", 4" and 5" Spacers

Self positioning spacers center InnoFlue® SW or Flex in a chase/chimney/B-vent.

Nominal Diameter	Part #	Max Width "A"	Min Width
2" (60)	IASP02	23.5 (596)	3.3 (85)
3" (80)	IASP03	22.8 (580)	4.2 (106)
4" (110)	IASP04	23.9 (606)	5.4 (138)
5" (125)	IASP05	24.6 (625)	6 (151)

Accessories

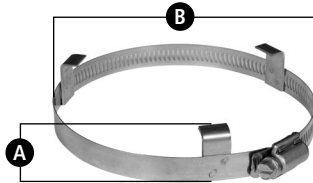

Flue Clamp

Secures ISAGL appliance adaptors to appliance flue collar.

Nominal Diameter	Part #	Height "A"	Max. I.D. "B"
2" (60)	IAFC02	1.0 (26)	3.0 (77)
3" (80)	IAFC03	1.0 (26)	4.3 (110)
4" (110)	IAFC04	1.0 (26)	5.0 (127)

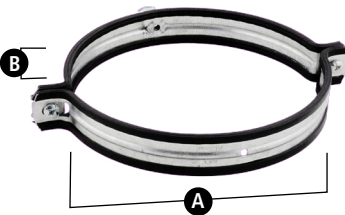

Support Clamp

Used as vertical or horizontal support. Space 78" in vertical and 39" in horizontal installations.

Uses 3/8" threaded rod.

Nominal Diameter	Part #	Overall Length "A"	Height "B"
2" (60)	IASCM02	3 (76.2)	1.1(28)
3" (80)	IASCM03	3.8 (96.5)	1.1 (28)
4" (110)	IASCM04	5.3 (134.6)	1.1 (28)
5" (125)	IASCM05	5.8 (147.3)	1.1 (28)





Wall Plate Round (Rubber)

Used to improve aesthetics and reduce drafts at chimney openings or wall penetrations.

Nominal Diameter	Part #	O.D. "A"
2" (60)	IAWP02BP	4.2 (107)
3" (80)	IAWP03B	5.5 (140)
3" (80)	IAWP03W	5.5 (140)
4" (110)	IAWP04B	7.3 (185)
5" (125)	IAWP05B	8.9 (226)

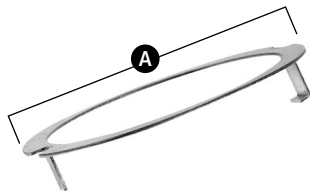

Connector Ring

Provides reinforcement at joints to support loads of up to 99 lbs (45Kg).

Nominal Diameter	Part #	O.D. "A"
2" (60)	IAN502	3.2 (81)
3" (80)	IAN503	4.1 (103)
4" (110)	IAN504	5.3 (134)
5" (125)	IAN505	5.8 (148)

EPDM Gaskets

Standard gasket for 2" through 5" diameter InnoFlue® SW. Inserted into the female end of each part, the gaskets keep flue gases and condensates within the vent system.

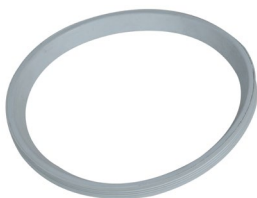

Nominal Diameter	Part #
2" (60)	ISGE02
3" (80)	ISGE03
4" (110)	ISGE04
5" (125)	ISGE05

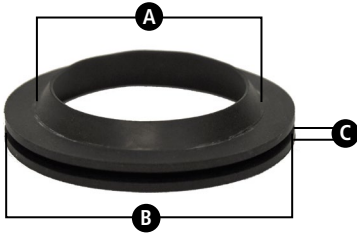

B-Vent Gasket

Rubber gasket for converting existing B-Vent into a combustion air chase.

Nominal Diameter	Part #	Flange I.D. "A"	Max O.D. "B"	Groove Thickness "C"
2" (60)	IACGE02	2.8 (72)	3.5 (88)	0.1 (2.5)
3" (80)	IACGE03	3.6 (92)	4.3 (108)	0.1 (2.5)
4 (110)	IACG04	4.8 (122)	5.4 (137)	01 (2.5)



Centrocerin

A water based lubricant used to ease the assembly of InnoFlue® SW & Flex. Sparingly applied to the gasket or male end.

Package Size	Part #
50 ml	IACE50

INNOFLUE® FLEX TYPICAL INSTALLATIONS

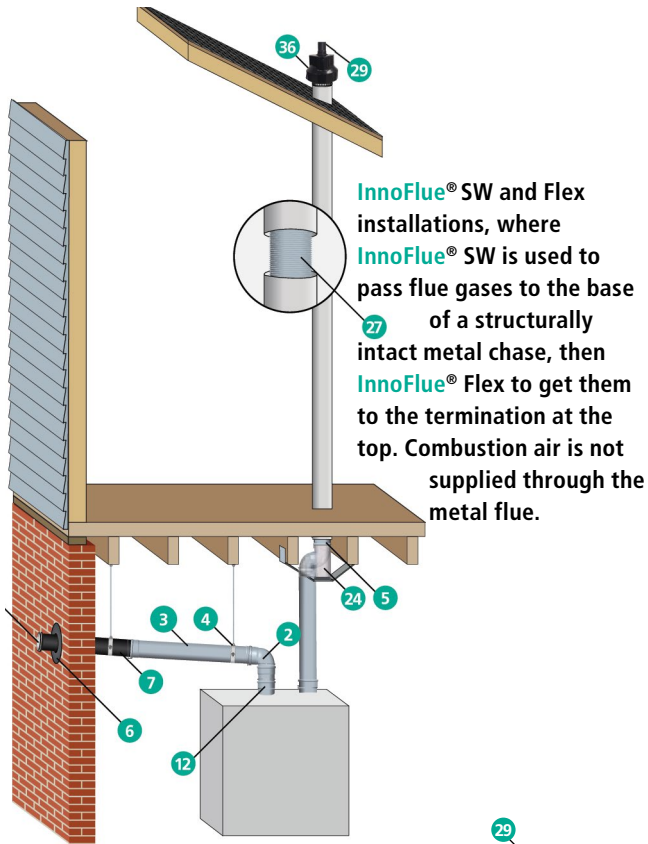

InnoFlue® SW and Flex installations, where InnoFlue® SW is used to pass flue gases to the base of a structurally intact metal chase, then InnoFlue® Flex to get them to the termination at the top. Combustion air is not supplied through the metal flue.

InnoFlue® SW and Flex installations, where InnoFlue® SW is used to pass flue gases to the base of the chimney, then InnoFlue® Flex to get them to the termination at the top.

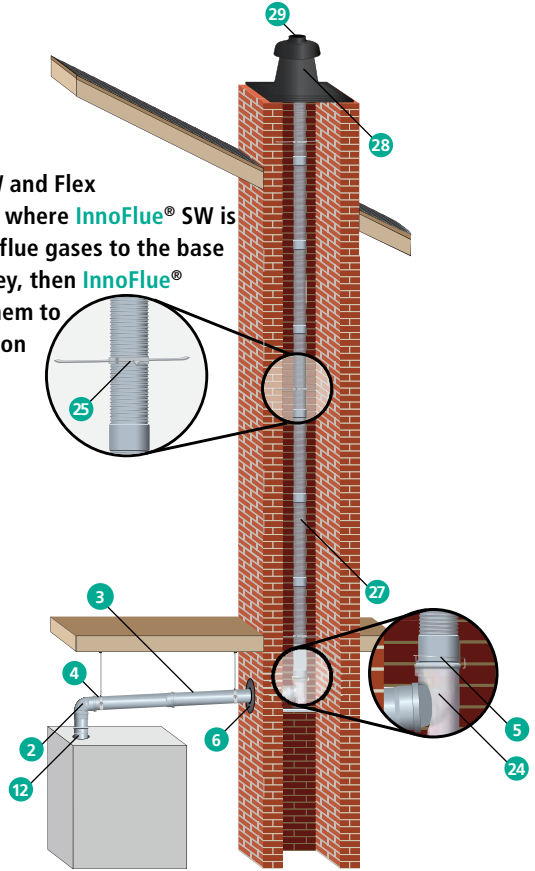

InnoFlue® SW and Flex installations, where InnoFlue® SW is used to pass flue gases to the base of the chimney, then InnoFlue® Flex to get them to the termination at the top. Combustion air is not supplied through the masonry chimney.

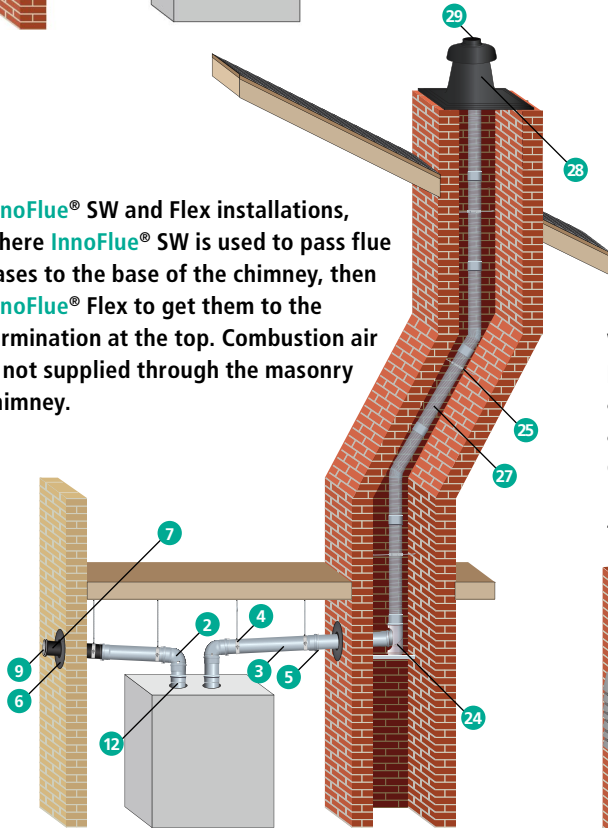

InnoFlue® SW and Flex installations, where InnoFlue® is used to pass flue gases of multiple appliances to the base of a structurally intact masonry chimney or metal flue, then InnoFlue® SW or Flex to get them to the Custom Chimney Cover at top.

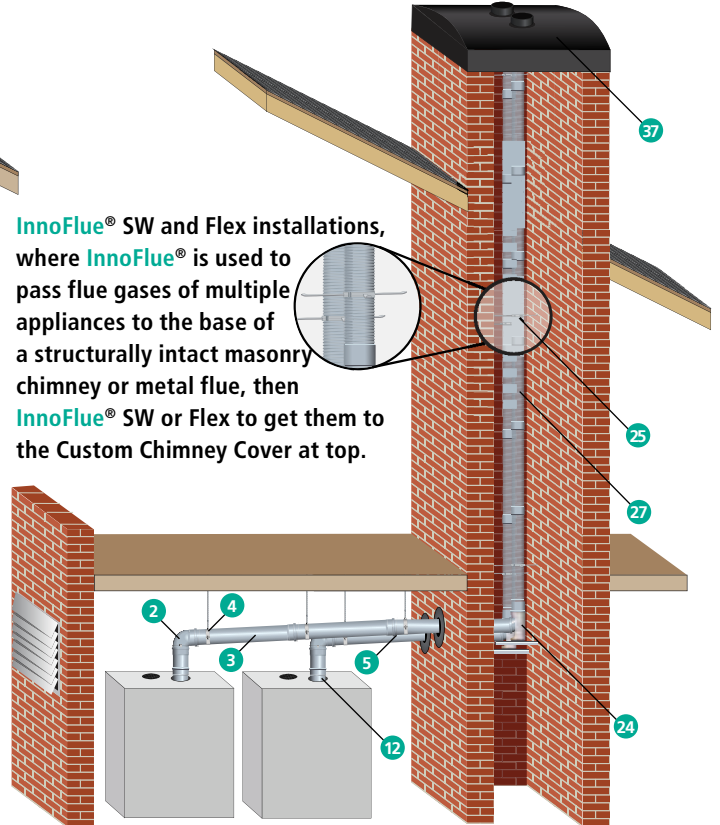

Flex Vent Lengths

2" Flex

Is manufactured from polypropylene. 2" Flex can be field cut and is ideal for use in chimneys with offsets. With couplers, 2" Flex can be connected to 2" Flex or InnoFlue® SW.



Nominal Diameter	Part #	Overall Height "A"	Max O.D. "B"
2" (60)	IFVL02025	25' (7.6m)	2.3 (58)
2" (60)	IFVL02035	35' (10.7m)	2.3 (58)
2" (60)	IFVL02050	50' (15.2m)	2.3 (58)
2" (60)	IFVL02150	150' (45.7m)	2.3 (58)

Flex

3" and 4" Flex

Are manufactured from polypropylene and feature rigid sections every 2'. 3", and 4" Flex can be field cut and are ideal for use in chimneys with offsets. The base of your 3" and 4" Flex can be connected to InnoFlue® SW at any rigid section without coupler. Flex to Flex couplers available for extended flex runs.



Nominal Diameter	Part #	Overall Height "A"	Max O.D. "B"
3" (80)	IFVL03025	25' (7.6m)	3.3 (84)
3" (80)	IFVL03035	35' (10.7m)	3.3 (84)
3" (80)	IFVL03040	40' (12.2m)	3.3 (84)
3" (80)	IFVL03050	50' (15.2m)	3.3 (84)
3" (80)	IFVL03080	80' (24.4m)	3.3 (84)
3" (80)	IFVL03150	150' (45.7m)	3.3 (84)
4" (110)	IFVL04025	25' (7.6m)	4.3 (110)
4" (110)	IFVL04035	35' (10.7m)	4.3 (110)
4" (110)	IFVL04040	40' (12.2m)	4.3 (110)
4" (110)	IFVL04050	50' (15.2m)	4.3 (110)
4" (110)	IFVL04080	80' (24.4m)	4.3 (110)

Couplers



SW to Flex Coupler

Transitions 2" InnoFlue® Single Wall Rigid to 2" InnoFlue® Flex.

Nominal Diameter	Part #	Overall Length "A"	Effective Length "B"	Max O.D. "C"
2" (60)	IFSFC02	4.2 (107)	3.2 (81)	2.6 (65)

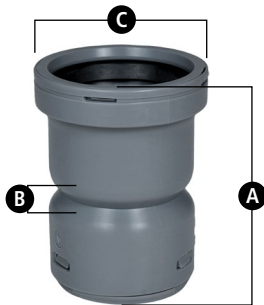

Flex to SW Coupler

Transitions 2" InnoFlue® Flex to 2" InnoFlue® Single Wall Rigid.

Nominal Diameter	Part #	Overall Length "A"	Effective Length "B"	Max O.D. "C"
2" (60)	IFFSC02	3.9 (99)	1.1 (28)	3.0 (76)

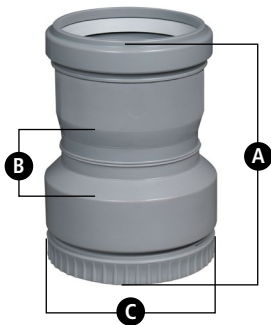

Flex to SW Coupler

Transitions InnoFlue® Flex to InnoFlue® Single Wall Rigid.

Nominal Diameter	Part #	Overall Length "A"	Effective Length "B"	Max O.D. "C"
3" (80)	IFFSC03	5.5 (138)	4.3 (60)	3.9 (100)
4" (110)	IFFSC04	6.5 (171)	2.64 (67)	5.1 (128)

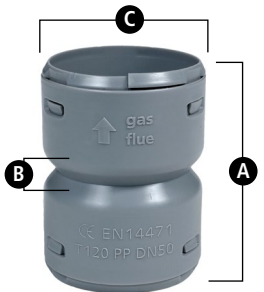

Flex to Flex Coupler

Transitions 2" InnoFlue® Flex to 2" InnoFlue® Flex.

Nominal Diameter	Part #	Overall Length "A"	Effective Length "B"	Max O.D. "C"
2" (60)	IFFFC02	3.4 (87)	1.4 (35)	2.6 (65)

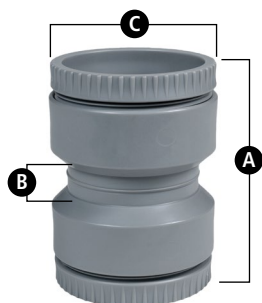

Flex to Flex Coupler

Transitions 3" and 4" InnoFlue® Flex to 3" and 4" InnoFlue® Flex.

Nominal Diameter	Part #	Overall Length "A"	Effective Length "B"	Max O.D. "C"
3" (80)	IFFFC03	5.5 (141)	4.3 (60)	3.9 (100)
4" (110)	IFFFC04	6.7 (166)	4.5 (114)	5.1 (128)

B-Vent Kits



Kit contains B-Vent Support Bracket, Base Support, Single Wall-To-Flex Coupler, 2" Flex, Flex End Pipe, Universal B-Vent Cap, Connector Ring, Spacers and Centrocerin®.

2" B-Vent Kit

Includes all components necessary to line a B-Vent from base to termination. Rigid vent lengths, elbows and adaptors required to connect B-Vent base support to appliance are sold separately.

Nominal Diameter	Part #	Flex Vent Length
2" (60)	IFBK0225	25' (7.6m)
2" (60)	IFBK0235	35' (10.6m)
2" (60)	IFBK0250	50' (15.25m)

Flex



Kit contains B-Vent Support Bracket, Base Support, 3" or 4", Flex End Pipe, Universal B-Vent Cap, Connector Rings, Spacers and Centrocerin.

3" and 4" B-Vent Kit

Includes all components necessary to line a B-Vent from base to termination. Rigid vent lengths, elbows and adaptors required to connect B-Vent base support to appliance are sold separately.

Nominal Diameter	Part #	Flex Vent Length	B-Vent Diameter
3" (80)	IFBK0325	25' (7.6m)	4"
3" (80)	IFBK0335	35' (10.6m)	5"
3" (80)	IFBK0350	50' (15.25m)	6"
4" (110)	IFBK0425	25' (7.6m)	5" or 6"
4" (110)	IFBK0435	35' (10.6m)	5" or 6"
4" (110)	IFBK0440	50' (15.25m)	5" or 6"

Flex Component B-Vent Kits

Flex



Kit includes B-Vent Support Bracket, Base Support, Single Wall-To-Flex Coupler, Flex End Pipe, Universal B-Vent Cap, Connector Ring, Spacers and Centrocerin.

2" Flex Component B-Vent Kit

Includes all fittings and accessories required to line a B-Vent excluding 2" flex. 2" flex and rigid vent length, elbows and adaptors required to connect B-Vent Base Support to appliance are sold separately.

Nominal Diameter	Part #	B-Vent Diameter
2" (60)	IFBKC02	4"

3" and 4" Flex Component B-Vent Kit

Includes all fittings and accessories required to line a B-Vent excluding 3" or 4" Flex. 3" or 4" flex and rigid vent length, elbows and adaptors required to connect B-Vent Base Support to appliance are sold separately.



Kit includes B-Vent Support Bracket, Base Support, Flex End Pipe, Universal B-Vent Cap, Connector Ring, Spacers and Centrocerin.

Nominal Diameter	Part #	B-Vent Diameter
3" (80)	IFBKC03	4"
4" (110)	IFBKC04	5"

Chimney Kits



Kit contains Base Support, Single Wall to Flex Coupler, Flex Vent Length, Flex End Pipe, Chimney Cover, Connector Rings, Spacers and Centrocerin.

2" Chimney Kit

Includes all components necessary to line a chimney from chimney termination to Base Support. Rigid vent lengths, elbows and adaptors required to connect chimney kit base support to appliance are sold separately. Custom flex lengths are available.

Nominal Diameter	Part #	Flex Vent Length
2" (60)	IFCK0225	25' (7.6m)
2" (60)	IFCK0235	35' (10.7m)
2" (60)	IFCK0250	50' (15.2m)

Flex



Kit contains Base Support, Flex Vent Length, Flex End Pipe, Chimney Cover, Connector Rings, Spacers and Centrocerin.

3" and 4" Chimney Kit

Includes all components necessary to line a chimney from chimney termination to Base Support. Rigid vent lengths, elbows and adaptors required to connect chimney kit base support to appliance are sold separately. Custom flex lengths are available.

Nominal Diameter	Part #	Flex Vent Length
3" (80)	IFCK0325	25' (7.6m)
3" (80)	IFCK0335	35' (10.7m)
3" (80)	IFCK0350	50' (15.2m)
4" (110)	IFCK0425	25' (7.6m)
4" (110)	IFCK0435	35' (10.7m)
4" (110)	IFCK0440	40' (12.2m)



Kit contains Base Support, Single Wall to Flex Coupler, Chimney Cover, Flex End Pipe, Connector Ring, Spacers and Centrocerin.

2" Flex Component Chimney Kit

Includes all components necessary to line a chimney from chimney termination to Base Support excluding 2" flex. 2" flex and rigid vent lengths, elbows and adaptors required to connect Base Support to appliance are sold separately.

Nominal Diameter	Part #
2" (60)	IFCKC02



Kit contains Base Support, Chimney Cover, Flex End Pipe, Connector Rings, Spacers and Centrocerin.

3" and 4" Flex Component Chimney Kit

Includes all components necessary to line a chimney from chimney termination to Base Support excluding 3" or 4" flex. 3" or 4" flex and rigid vent lengths, elbows and adaptors required to connect Base Support to appliance are sold separately.

Nominal Diameter	Part #
3" (80)	IFCKC03
4" (110)	IFCKC04

Terminations

Chimney Cover PPs-UV

This termination incorporates a combustion air intake and flue gas termination in a single assembly. Cover seals top of the chimney or chase. Use with End Pipe or Flex End Pipe. End Pipes sold separately.

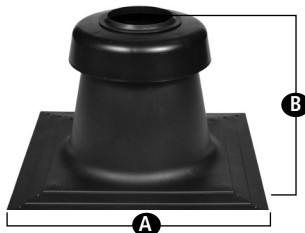

Nominal Diameter	Part #	Length "A"	Height "B"
2" (60)	ISCP02	15.8 (400)	9.6 (245)
3" (80)	ISCP03	15.8 (400)	9.6 (245)
4" (110)	ISCP04	15.8 (400)	9.6 (245)

Custom Chimney Cover PPs-UV

Custom Chimney Cover sizes available, including multiple flue versions. Call with size requirements for pricing.



2" Flex End Pipe

Terminates InnoFlue® Flex at top of chimney. Used in combination with Chimney Cover PPs-UV or B-Vent Cap.

Nominal Diameter	Part #	Overall Length "A"	Effective Length "B"	Max O.D. "C"
2" (60)	IFEP02	5.3 (135)	4.1 (105)	3.9 (99)



3" and 4" Flex End Pipe

Terminates InnoFlue® Flex at top of chimney. Used in combination with Chimney Cover PPs-UV or B-Vent Cap.

Nominal Diameter	Part #	Overall Length "A"	Effective Length "B"	Max O.D. "C"
3" (80)	IFEP03	7.1 (180)	3.3 (84)	3.9 (100)
4" (110)	IFEP04	10.0 (253)	3.5 (89)	5.2 (132)



Universal B-Vent Cap

Allows for multiple flue configurations. Utilize existing B-Vent as a chase. Clean, professional and aesthetically pleasing. Installs quickly and easily.

Part #	Length	Height	Width
IAUBVC	10"	10"	10"

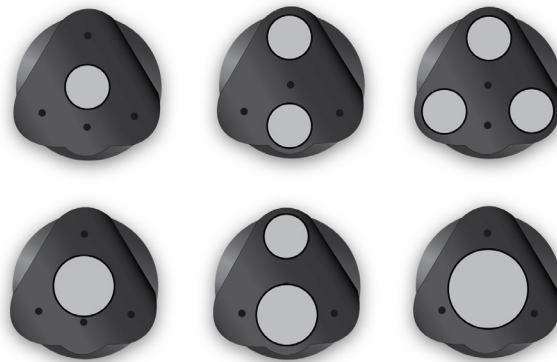

One Part ❖❖❖ Multiple Configurations

Flex

INNOFLUE® CONCENTRIC

Applications and Limitations

- In order to maintain relevant listings and Centrotherm's warranty, **InnoFlue®** vent systems may not be combined with any polymeric or stainless steel vent components that are not part of Centrotherm's published offerings.
- **InnoFlue®** Concentric must be installed following Centrotherm's published installation instructions.
- **InnoFlue®** Concentric are ETL listed UL and ULC for use with natural gas or propane fired, Cat. II or Cat. IV appliances (United States) or BH Gas Class II A, B, and C gas or propane fired appliances (Canada).
- **InnoFlue®** Concentric can also be used for oil fired, condensing appliances with a maximum flue gas temperature that does not exceed 230°F (110°C).
- **InnoFlue®** Concentric is ETL listed to UL 1738 and ULC-S636 at zero clearance to combustibles.
- **InnoFlue®** Concentric may be installed inside a masonry or sheet rocked chase, between floor joists, directly through a wall or if properly supported, can even be left exposed along the interior of a structure.
- **InnoFlue®** Concentric is available in 2"/4", 3"/5" and 4"/6" diameters and offers all necessary components for combining it with **InnoFlue®** SW and **InnoFlue®** Flex to meet specific job requirements.
- Do not install where ambient air temperature can exceed 300°F.



INNOFLUE® CONCENTRIC TYPICAL INSTALLATIONS

- 4 IASCM: Support Clamp
- 6 IAWP: Wall Plate
- 15 ICRT: Concentric Roof Termination
- 31 ICTP: Concentric Appliance Adaptor
- 32 ICCEL45: Concentric 45° Elbow
- 33 ICVL: Concentric Vent Length
- 34 ICCEL87: Concentric 87° Elbow
- 35 ICWT: Concentric Wall Termination PP

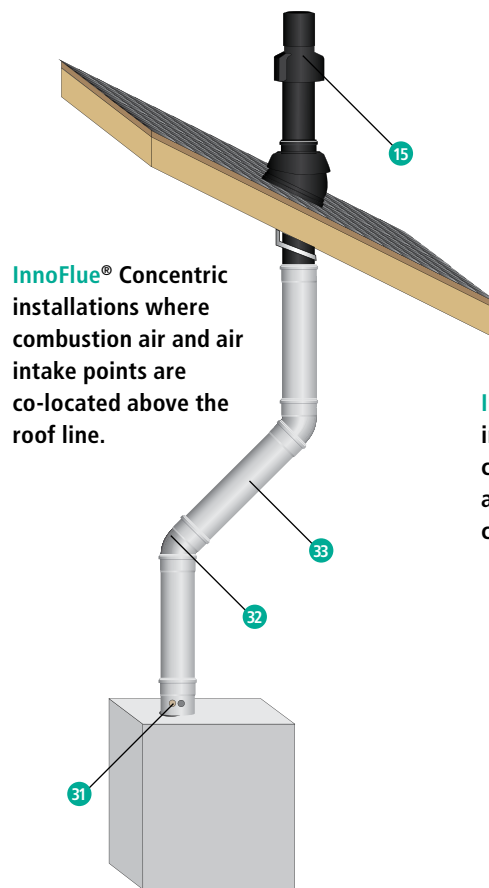

InnoFlue® Concentric installations where combustion air and air intake points are co-located above the roof line.

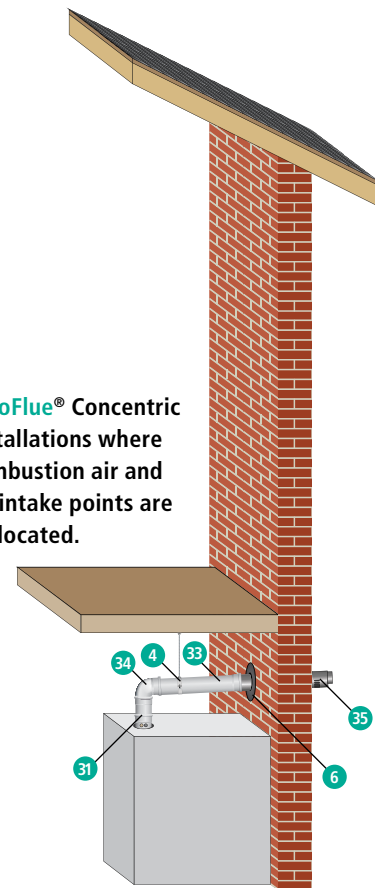

InnoFlue® Concentric installations where combustion air and air intake points are co-located.

Concentric Adaptors

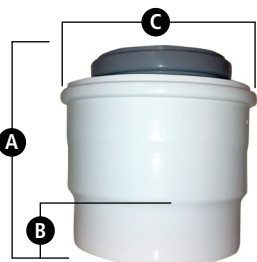

Concentric Centric Increaser

Transitions from one diameter to a larger diameter. Install in vertical orientation only.

Nominal Diameter	Part #	Overall Length "A"	Effective Length "B"	Max O.D. "C"
4"/6" (100/150mm)	ICIA10015046	6.0 (163)	4.1 (105)	6.8 (173)
4"/6" (110/150mm)	ICIA11015046	6.0 (163)	4.1 (105)	6.8 (173)

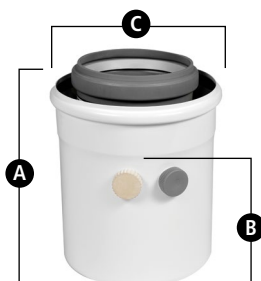

Concentric Test Port

Installed immediately above the appliance, the test port allows plumbing and heating professionals to sample flue gases and ensure the appliance is operating at optimum efficiency.

Nominal Diameter	Part #	Overall Length "A"	Effective Length "B"	Max O.D. "C"
2"/4" (60/100)	ICTP24	6.7 (170)	4.3 (110)	4.4 (112)
3"/5" (80/125)	ICTP35	6.7 (170)	4.3 (110)	5.5 (139)
4"/6" (110/160)	ICTP46	8.1 (207)	5.6 (143)	6.8 (173)

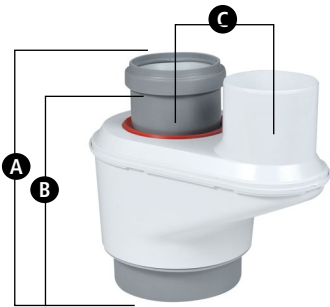

Concentric to Twin Pipe Adaptor

Transitions Concentric to twin pipe Single Wall.

Nominal Diameter	Part #	Overall Length "A"	Effective Length "B"	Offset "C"
3"/5" (80/125)	ICCT3503	9.8 (250)	5.9 (150)	4.8 (121)

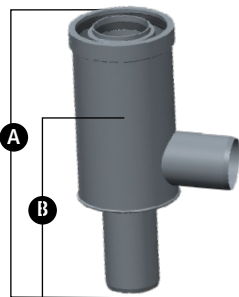

Twin Pipe to Concentric Adaptor

Transitions twin pipe Single Wall to Concentric.

Nominal Diameter	Part #	Overall Length "A"	Effective Length "B"
2"/4" (60/100)	ICTC0224	12.0 (333)	10.3 (262)
4"/6" (110/160)	ICTC0446	14.5 (316)	10.0 (25.3)

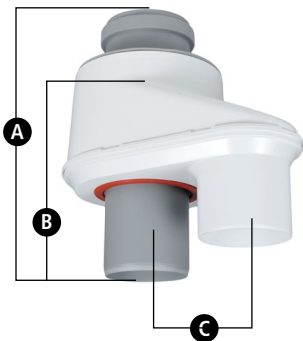

Twin Pipe to Concentric Adaptor

Transitions twin pipe Single Wall to Concentric.

Nominal Diameter	Part #	Overall Length "A"	Effective Length "B"	Offset "C"
3"/5" (80/125)	ICTC0335	9.8 (250)	7.9 (200)	4.8 (121)

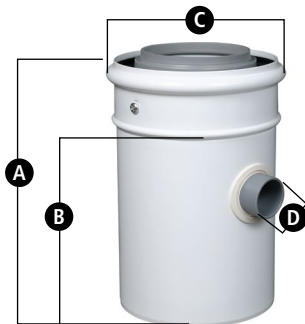

Concentric Horizontal Drain Tee

Use to drain condensate from the vent system. Install in horizontal section closest to appliance.

Nominal Diameter	Part #	Overall Length "A"	Effective Length "B"	Max O.D. "C"	Drain O.D. "D"
2"/4" (60/100)	ICHDT24	7.9 (200)	5.9 (150)	4.4 (112)	1.4 (32)
3"/5" (80/125)	ICHDT35	7.9 (200)	5.9 (150)	5.5 (139)	1.4 (32)
4"/6" (110/160)	ICHDT46	7.9 (200)	5.9 (150)	6.8 (173)	1.4 (32)

Concentric Vent Lengths

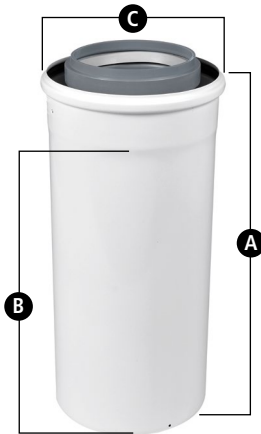

Concentric Vent Lengths

Gasketed rigid polypropylene vent lengths with metal outer and dedicated male and female ends. Male ends can be field cut to length.

Nominal Diameter	Part #	Overall Length "A"	Effective Length "B"	Max O.D. "C"
2" / 4" (60/100)	ICVL241	14.5 (368)	12 (305)	4.4 (112)
2" / 4" (60/100)	ICVL242	26.5 (673)	24 (610)	4.4 (112)
2" / 4" (60/100)	ICVL243	38.5 (978)	36 (914)	4.4 (112)
3" / 5" (80/125)	ICVL351	14.5 (368)	12 (305)	5.5 (139)
3" / 5" (80/125)	ICVL352	26.5 (673)	24 (610)	5.5 (139)
3" / 5" (80/125)	ICVL353	38.5 (978)	36 (914)	5.5 (139)
4" / 6" (110/160)	ICVL461	14.5 (368)	12 (305)	6.8 (173)
4" / 6" (110/160)	ICVL462	26.5 (673)	24 (610)	6.8 (173)
4" / 6" (110/160)	ICVL463	38.5 (978)	36 (914)	6.8 (173)

Elbows

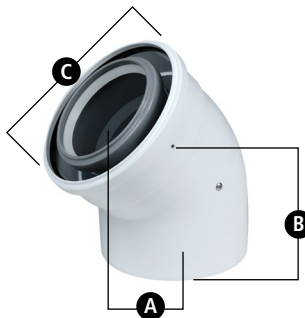

Concentric 45° Elbow

For offsets or changes in the direction of the vent system.

Nominal Diameter	Part #	Centerline Offset "A"	Effective Length "B"	Max O.D. "C"
2" / 4" (60/100)	ICEL2445	.7 (18)	3.3 (85)	4.4 (112)
3" / 5" (80/125)	ICEL3545	1.3 (34)	4.6 (117)	5.5 (139)
4" / 6" (110/160)	ICEL4645	1.5 (39)	5.2 (133)	6.8 (173)

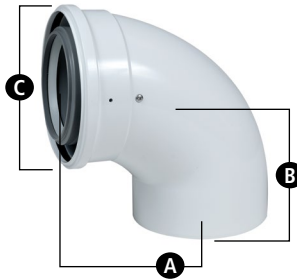

Concentric 87° Elbow

For offsets or changes in the direction of the vent system.

Nominal Diameter	Part #	Centerline Offset "A"	Effective Length "B"	Max O.D. "C"
2" / 4" (60/100)	ICEL2487	2.0 (50)	4.8 (123)	4.4 (112)
3" / 5" (80/125)	ICEL3587	3.1 (79)	5.1 (129)	5.5 (139)
4" / 6" (110/160)	ICEL4687	4.4 (111)	6.5 (165)	6.8 (173)

Wall Plates



Wall Plate

Provides an aesthetically pleasing and water tight finish at wall penetrations when sealed with field-supplied silicone.

Nominal Diameter	Part #	Overall Diameter "A"	Width of Opening "B"
4" (100)	IAWP100B	5.6 (142)	4" (100)
5" (125)	IAWP05B	8.9 (226)	5" (125)
6" (160)	IAWPSS06	4.8 (250)	6.7" (170)

Terminations



Concentric Roof Termination

Roof Termination combines flue gas termination and combustion air intake. Use with InnoFlue® Concentric or with InnoFlue® SW by adding an ICTC Adapter. Includes support clamp.

Nominal Diameter	Part #	Overall Length "A"	Roof Line "B"	Max O.D. "C"
2" / 4" (60/100)	ICRT2439	39.4 (1000)	20.5 (520)	6.5 (166)
3" / 5" (80/125)	ICRT3539	39.4 (1000)	20.5 (520)	6.5 (166)
4" / 6" (110/160)	ICRT4679	78.7 (2000)	23.6 (600)	6.5 (166)

Concentric

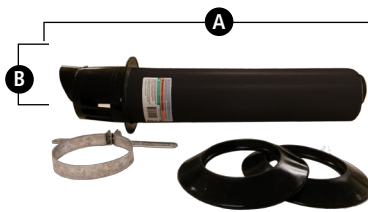

Concentric Wall Termination

Made from PPs-UV outer and PPs-UV inner, the Concentric Wall termination incorporates flue gas termination and combustion air intake. Use with InnoFlue® Concentric or with InnoFlue® SW by adding an ICTC Adapter. Includes support clamp and wall plates.

Nominal Diameter	Part #	Overall Length "A"	O.D. "B"
2" / 4" (60/100)	ICWT242	21.2 (538)	5.54 (141)
3" / 5" (80/125)	ICWT352	28.3 (719)	5 (125)

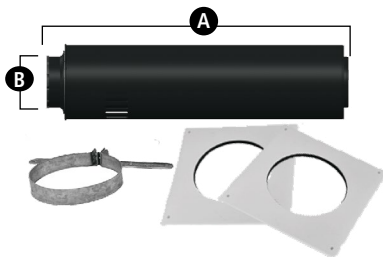

Concentric Wall Termination

Made from PPs-UV outer and PPs-UV inner, the Concentric Wall termination incorporates flue gas termination and combustion air intake. Use with InnoFlue® Concentric or with InnoFlue® SW by adding an ICTC Adapter. Includes support clamp and wall plates.

Nominal Diameter	Part #	Overall Length "A"	O.D. "B"
4" / 6" (110/160)	ICWT462	32.0 (813)	6.3 (160)

NEW!

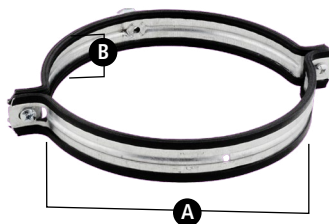

Support Clamp

Used as vertical or horizontal support. Space 78" in vertical and 39" in horizontal installations. **Uses 3/8" threaded rod.**

Nominal Diameter	Part#	Overall Length "A"	Height "B"
4" (100)	IASCM04	5.3 (134.6)	1.1 (28)
5" (125)	IASCM05	5.8 (147.3)	1.1 (28)
6" (160)	IASCM06	6.8 (172.7)	1.1 (28)

Concentric Kits

Concentric Kit Horizontal

Concentric Side Wall Venting Kit contains components needed to vent wall mounted appliance to wall termination. Additional components may be required for longer runs and are sold separately.



Nominal Diameter	Part #
2" / 4" (60/100)	ICVKH24
3" / 5" (80/125)	ICVKH35
4" / 6" (110/160)	ICVKH46

Kit includes one 3' Concentric Vent Length, Concentric Elbow, Concentric Wall Termination, Wall Plates and Support Clamp.



Concentric Kit Vertical

Concentric Vertical Venting Kit contains components needed to vent vertically through roof. Additional components may be required for longer runs and are sold separately.

Nominal Diameter	Part #
2" / 4" (60/100)	ICVKV24
3" / 5" (80/125)	ICVKV35
4" / 6" (110/160)	ICVKV46

Kit includes one 2' and one 3' Concentric Vent Length, Concentric Roof Termination, one Wall Plate and Support Clamp.

Applications and Limitations

- In order to maintain relevant listings and Centrotherm's warranty, **InnoFlue®** vent systems may not be combined with any polymeric or stainless steel vent components that are not part of Centrotherm's published offerings.
- **InnoFlue®** SW must be installed following Centrotherm's published installation instructions.
- **InnoFlue®** SW is ETL listed UL and ULC for use with natural gas or propane fired, Cat. II or Cat. IV appliances (United States) or BH Gas Class II A, B, and C gas or propane fired appliances (Canada).
- **InnoFlue®** SW can also be used for oil fired, condensing appliances with a maximum flue gas temperature that does not exceed 230°F (110°C).
- **InnoFlue®** SW is ETL listed to UL 1738 and ULC-S636 at zero clearance to combustibles.

- **InnoFlue®** SW may be installed inside a masonry or sheet rocked chase, through an existing structurally intact metal flue, between floor joists, directly through a wall or if properly supported, can even be left exposed along the interior of a structure.

- **InnoFlue®** SW Commercial is available in 6", 8", 10" and 12" diameters and offers all necessary components.

- Single or multiple **InnoFlue®** SW Commercial runs may be installed into an existing masonry chimney or structurally intact metal flue or chase.
- Do not install where ambient air temperature can exceed 300°F.



INNOFLUE® SW COMMERCIAL TYPICAL INSTALLATIONS

- 2 ISEL87: 87° Elbow
- 3 ISVL: Vent Length
- 4 IASCM: Support Clamp
- 5 IANS: Connector Ring
- 6 IAWP: Wall Plate
- 7 ISEP: End Pipe PPs-UV
- 9 IASPP: Bird Screen PPs-UV
- 12 ISAGL or ISAAL: Appliance Adaptor
- 17 IAAI: Air Intake
- 19 ISTEP: Test Port
- 20 ISHDF: Horizontal Drain Fitting
- 21 IALJS: Siphon
- 22 ISBT: Branch Tee
- 23 ISEL0430: 30° Elbow
- 24 ISBS: Base Support
- 25 IASP: Spacer
- 26 ISCM: Chimney Cover SS w/PPs-UV End Pipe

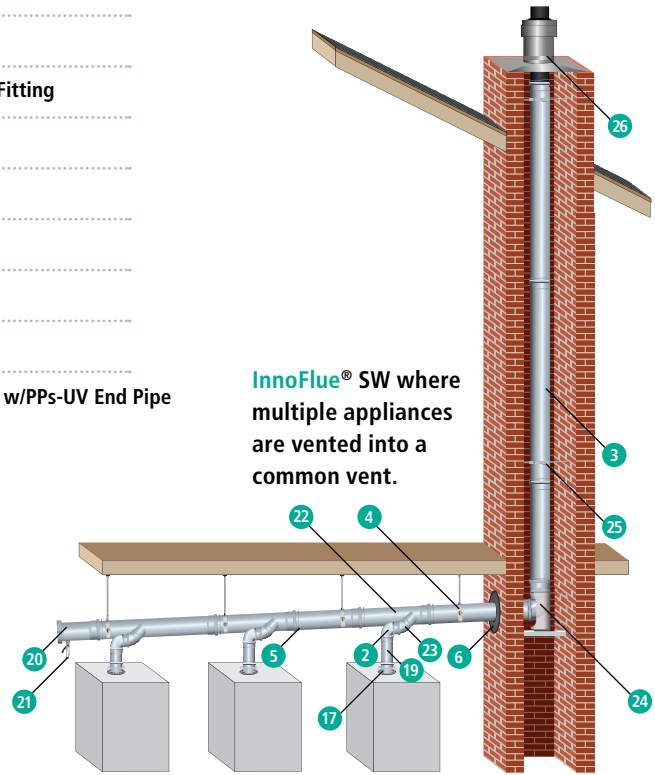

InnoFlue® SW where multiple appliances are vented into a common vent. Combustion air and air supply terminations points are significantly separated.

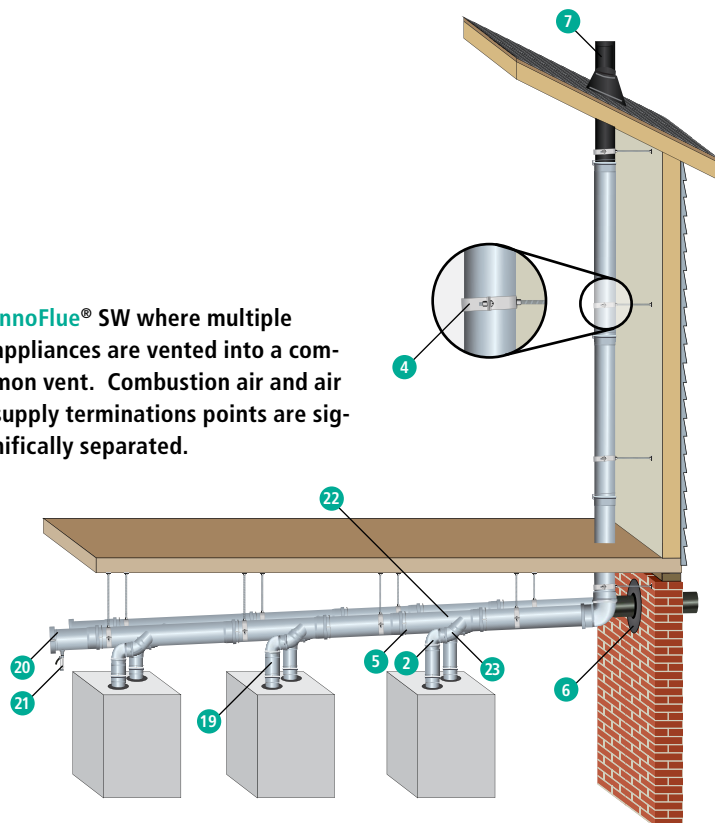

InnoFlue® SW through the roof installations where combustion air and air supply termination points are significantly separated.

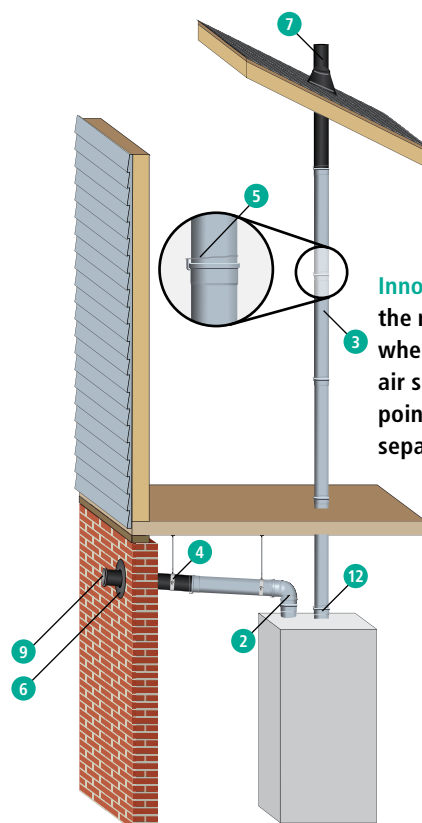

Appliance Adaptors

Commercial appliance adaptors are made to order. Adaptors can be manufactured to fit any appliance. Call Centrotherm if your appliance is not listed below.

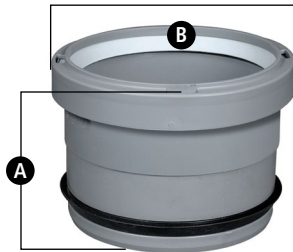

Commercial Appliance Adaptor for Coupler Style Flue Collar

Adapts a female PVC / CPVC coupler or appliance flue exhaust to InnoFlue® SW diameters.

Nominal Diameter PVC to PP	Part #	Overall Length "A"	Max O.D. "B"
6"/6" (168/160)	ISAGL0606	7.6 (194)	7.0 (178)

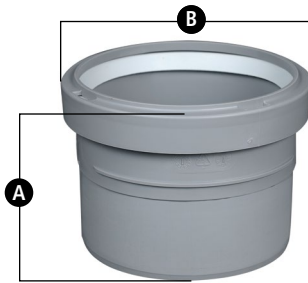

Commercial Appliance Adaptor for Flue Collar with Hose Clamp

Adapts a female PVC / CPVC diameter appliance flue exhaust (with integrated gasket) to InnoFlue® SW diameters.

Nominal Diameter PVC to PP	Part #	Overall Length "A"	Max O.D. "B"
6"/6" (168/160)	ISAAL0606	7.6 (194)	7.0 (178)

Commercial Appliance Adaptor w/ Condensate Drain and Vibration Isolation Boot OEM to InnoFlue®

Adapts Camus Dynaforce boilers to InnoFlue®. Other increasing size combinations available upon request.

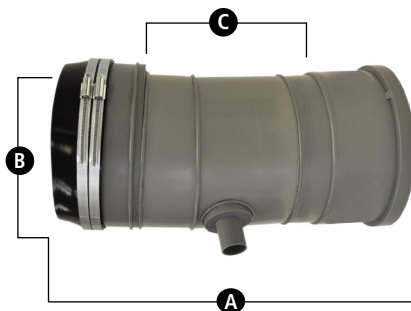

Nominal Diameter	Part #	Overall Length "A"	Maximum OD "B"	Effective Length "C"
4" (110)	ISAACD0404	10.3 (262)	5.9 (150)	3.4 (86)
5" (125)	ISAACD0505	13.6 (345)	6.5 (165)	8.5 (216)
6" (160)	ISAACD0606	12.0 (305)	7.9 (201)	5.4 (137)
7" (180) to 8" (200)	ISAACD0708	16.5 (419)	9.5 (241)	9.7 (246)
8" (200)	ISAACD0808	16.5 (419)	9.5 (241)	9.7 (246)
9" (230) to 10" (250)	ISAACD0910	16.9 (429)	11.4 (290)	10.0 (254)
10" (250)	ISAACD1010	16.9 (429)	11.4 (290)	10.0 (254)
12" (315)	ISAACD1212	23.3 (542)	14.7 (373)	7.6 (191)

Commercial SW

Commercial Appliance Adaptor OEM to InnoFlue®

Adapts InnoFlue® with bolt down flanged adaptor. Available for purchase through Centrotherm.

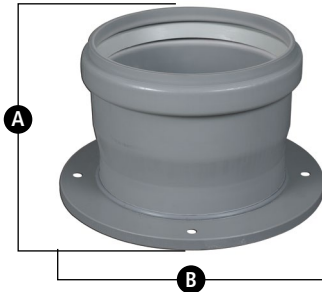

Nominal Diameter	Part #	Overall Length "A"	Maximum OD "B"
3" (80)	ISAFLG03	3.7 (94)	8.8 (224)
4" (110)	ISAFLG04	4.7 (119)	8.8 (224)
6" (160)	ISAFLG06	4.3 (109)	8.8 (224)
8" (200)	ISAFLG08	6.2 (158)	11.3 (287)
10" (250)	ISAFLG10	6.2 (157)	15.0 (381)
12" (315)	ISAFLG12	13.2 (335)	15.0 (381)

Commercial Appliance Adaptor OEM to InnoFlue®

Adapts RBI Fusion boilers to InnoFlue®.

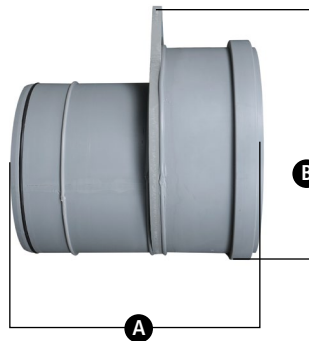

Nominal Diameter	Part #	Overall Length "A"	Max O.D. "B"
7" (180) to 8" (200)	ISAF0708	9.0 (229)	8.8 (224)
8" (200)	ISAF0808	8.0 (204)	8.8 (224)
10" (250)	ISAF1010	8.0 (204)	10.8 (27)

Commercial Appliance Adaptor SS to InnoFlue®

Adapts stainless steel flue outlets to InnoFlue®.

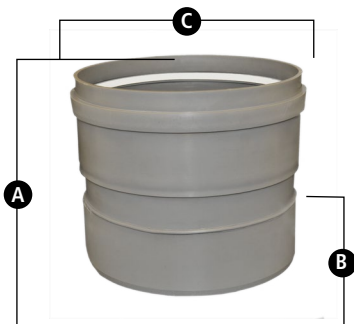

Nominal Diameter SS to PP	Part #	Overall Length "A"	Effective Length "B"	Max O.D. "C"
6"/6" (152/160)	ISSA0606	7.3 (185)	4.2 (107)	7.8 (183)
7" (180) to 8" (200)	ISSA0708	8.7 (221)	6.1 (155)	8.8 (224)
8"/8" 203/200)	ISSA0808	8.9 (226)	5.0 (127)	8.8 (224)
10"/10" (254/250)	ISSA1010	8.9 (226)	5.0 (127)	10.7 (272)
12"/12" (305/315)	ISSA1212	16.9 (429)	4.2 (107)	13.8 (350)

SW
Commercial

Vibration Isolation Boot with Clamps



High temperature silicone boot seals InnoFlue® SW Vent Lengths and Fittings to appliance flue outlet.

Nominal Diameter PVC to PP	Part #	Width	I.D
6" (160)	ISVIB06	2.4 (60)	6.3 (160)
8" (200)	ISVIB08	2.4 (60)	7.9 (200)
10" (250)	ISVIB10	2.4 (60)	9.8 (250)
12" (315)	ISVIB12	2.4 (60)	12.4 (315)

Custom Appliance Adaptors Available

Appliance Adaptors are built to order. Contact your sales representative for pricing and availability. <http://www.centrotherm.us.com/rep-finder/>

Increasesers & Reducers

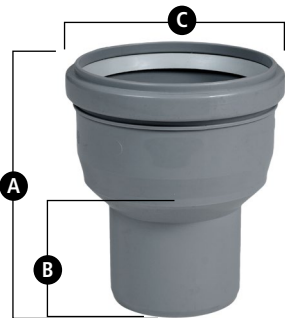

Centric Increaser

Transitions vent system to a larger diameter. Install in vertical orientation only. Additional configurations available upon request.

Nominal Diameter	Part #	Overall Length "A"	Effective Length "B"	Max O.D. "C"
4"/6" (110/160)	ISIA0406	7.6 (193)	4.8 (122)	7.2 (183)
5"/6" (125/160)	ISIA0506	7.2 (185)	4.3 (110)	7.2 (185)
6"/6" (150/160)	ISIA15006	7.7 (196)	4.9 (124)	7.2 (183)
6"/8" (160/200)	ISIA0608	10.4 (265)	6.5 (165)	8.8 (224)
6"/12" (160/315)	ISIA0612	18.1 (460)	5.4 (137)	13.8 (351)
8"/10" (200/250)	ISIA0810	11.6 (295)	7.7 (195)	10.7 (272)
10"/12" (250/315)	ISIA1012	18.2 (463)	5.5 (141)	13.8 (350)

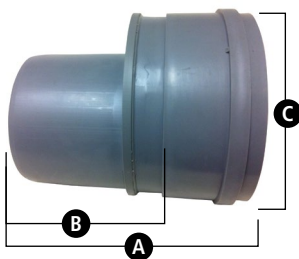

Eccentric Increaser

Transitions vent system to a larger diameter. Install in horizontal or vertical orientation. Other size combinations available upon request.

Nominal Diameter	Part #	Overall Length "A"	Effective Length "B"	Max O.D. "C"
4"/6" (110/160)	ISEI0406	9.2 (234)	6.4 (163)	7.2 (183)
5"/6" (125/160)	ISEI0506	7.2 (185)	4.3 (108)	7.2 (183)
6"/8" (160/200)	ISEI0608	10.4 (265)	6.5 (165)	8.8 (224)
6"/12" (160/315)	ISEI0612	18.1 (460)	5.4 (137)	13.8 (350)
8"/10" (200/250)	ISEI0810	11.8 (300)	7.8 (200)	10.7 (272)
8"/12" (200/315)	ISEI08120	16.9 (429)	4.2 (107)	13.8 (350)
10"/12" (250/315)	ISEI1012	20.2 (514)	7.8 (200)	13.8 (350)

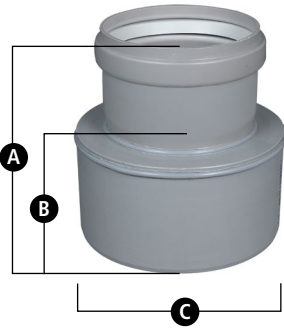

Reducer

Transitions vent system to a smaller diameter.

Nominal Diameter	Part #	Overall Length "A"	Effective Length "B"	Max O.D. "C"
8"/6" (200/160)	ISRD0806	8.0 (204)	5.2 (133)	7.9 (201)
10"/8" (250/200)	ISRD1008	9.2 (234)	5.2 (133)	9.9 (252)
12"/10" (315/250)	ISRD1210	17.9 (455)	14.0 (356)	12.5 (318)

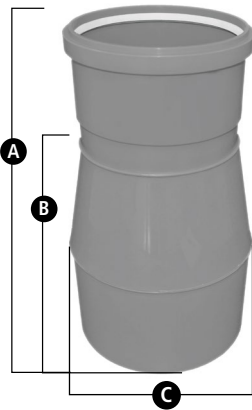

Tapered Reducer

Transitions vent system to a smaller diameter with minimal back pressure. Other sizes available. Please contact Centrotherm.

Nominal Diameter	Part #	Overall Length "A"	Effective Length "B"	Max O.D. "C"
8"/6" (200/160)	ISTR0806	13.5 (343)	10.7 (272)	7.9 (200)
10"/6" (250/160)	ISTR1006	18.5 (409)	16.3 (414)	9.9 (250)
10"/8" (250/200)	ISTR1008	16.6 (422)	12.6 (320)	9.9 (250)

Test Ports

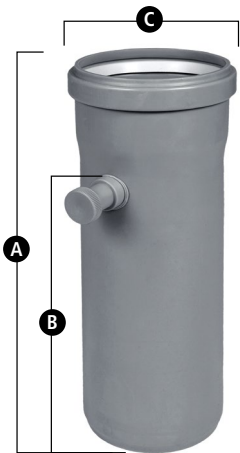

Test Port

Installed immediately above the appliance, the test port allows plumbing and heating professionals to sample flue gases and ensure the appliance is operating at optimum efficiency.

Nominal Diameter	Part #	Overall Length "A"	Effective Length "B"	Max O.D. "C"
6" (160)	ISTP06	12.7 (323)	9.8 (250)	7.2 (183)
8" (200)	ISTP08	15.9 (405)	12.0 (305)	8.8 (224)
10" (250)	ISTP10	15.9 (405)	12.0 (305)	10.7 (272)
12" (315)	ISTP12	36.7 (932)	24 (610)	13.8 (350)

Vent Lengths

Rigid Vent Length

Gasketed rigid polypropylene vent lengths with dedicated male and female ends. Male ends can be field cut to length.

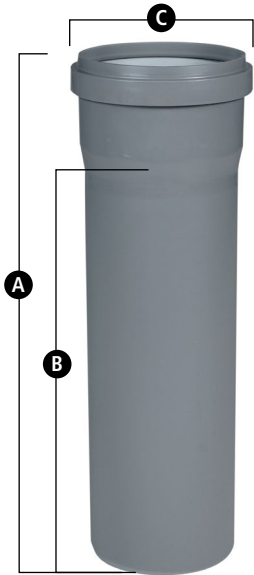

Nominal Diameter	Part #	Overall Length "A"	Effective Length "B"	Max O.D. "C"
6" (160)	ISVL061	15.5 (345)	12 (305)	7.8 (183)
6" (160)	ISVL062	27.5 (700)	24 (610)	7.8 (183)
6" (160)	ISVL063	39.5 (1004)	36 (914)	7.8 (183)
6" (160)	ISVL066	75.5 (1919)	72 (1829)	7.8 (183)
8" (200)	ISVL081	16.2 (412)	12 (305)	8.8 (224)
8" (200)	ISVL082	28.2 (716)	24 (610)	8.8 (224)
8" (200)	ISVL083	40.2 (1021)	36 (914)	8.8 (224)
8" (200)	ISVL086	76.2 (1935)	72 (1829)	8.8 (224)
10" (250)	ISVL101	16.1 (410)	12 (305)	10.7 (272)
10" (250)	ISVL102	28.1 (715)	24 (610)	10.7 (272)
10" (250)	ISVL103	40.1 (1019)	36 (914)	10.7 (272)
10" (250)	ISVL106	76.1 (1934)	72 (1829)	10.7 (272)
12" (315)	ISVL122	36.7 (932)	24 (610)	13.8 (350)
12" (315)	ISVL123	48.7 (1236)	36 (914)	13.8 (350)
12" (315)	ISVL126	84.7 (2151)	72 (1829)	13.8 (350)

Elbows



15° Elbow

Segmented Elbows offset or change the direction of the vent system.

Nominal Diameter	Part #	Centerline Offset "A"	Effective Length "B"	Max O.D. "C"
6" (160)	ISEL0615	1.0 (25)	5.1 (130)	7.2 (183)
8" (200)	ISEL0815	1.8 (46)	9.8 (249)	8.8 (224)
10" (250)	ISEL1015	1.9 (48)	10.6 (269)	10.7 (272)
12" (315)	ISEL1215	4.4 (112)	18.7 (475)	13.8 (350)

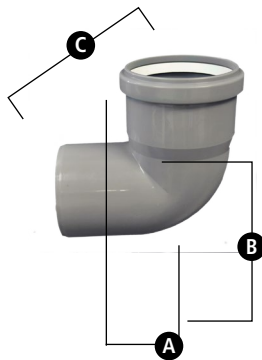

30° Elbow

Segmented elbow for offsets or changes in the direction of the vent system. Commonly used to provide offsets in cascade configurations.

Nominal Diameter	Part #	Centerline Offset "A"	Effective Length "B"	Max O.D. "C"
6" (160)	ISEL0630	2.1 (53)	5.8 (147)	7.2 (183)
8" (200)	ISEL0830	4.1 (104)	11.5 (292)	8.8 (224)
10" (250)	ISEL1030	4.3 (109)	12.6 (320)	10.7 (272)
12" (315)	ISEL1230	9.3 (21.4)	21.4 (544)	13.8 (350)

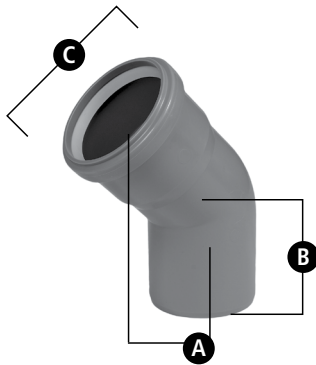

45° Elbow

For offsets or changes in the direction of the vent system.

Nominal Diameter	Part #	Centerline Offset "A"	Effective Length "B"	Max O.D. "C"
6" (160)	ISEL0645	3.2 (81)	5.5 (138)	7.2 (183)
8" (200)	ISEL0845	3.8 (96)	13.1 (332)	8.8 (224)
10" (250)	ISEL1045	4.1 (105)	14.3 (364)	10.7 (272)
12" (315)	ISEL1245	5.5 (139)	23.6 (599)	13.8 (350)

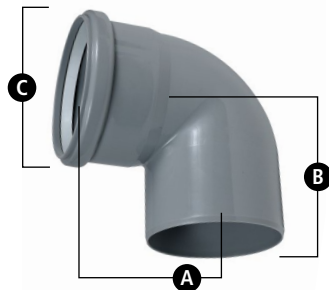

87° Elbow

For offsets or changes in the direction of the vent system.

Nominal Diameter	Part #	Centerline Offset "A"	Effective Length "B"	Max O.D. "C"
6" (160)	ISEL0687	3.4 (86)	6.3 (160)	7.2 (183)
8" (200)	ISEL0887	9.5 (242)	14.0 (355)	8.8 (224)
10" (250)	ISEL1087	11.3 (287)	15.7 (399)	10.7 (272)
12" (315)	ISEL1287	14.3 (364)	25.7 (653)	13.8 (350)

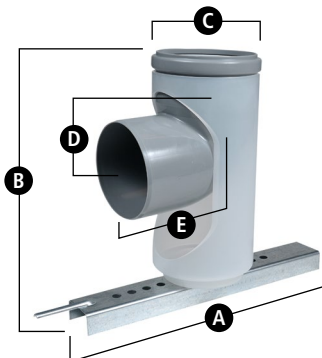

Base Support

Supports vertical sections of rigid (up to 164') vent lengths installed in chimneys and chases.

Nominal Diameter	Part #	Base Length "A"	Height "B"	Max O.D. "C"	Effective "D"	Effective "E"
6" (160)	ISBS0687	15.8 (400)	13.2 (335)	7.2 (183)	3.7 (93)	6.1 (156)
8" (200)	ISBS0887	15.8 (400)	22.7 (577)	8.8 (224)	10.2 (260)	13.5 (342)
10" (250)	ISBS1087	27.6 (700)	29.5 (750)	10.7 (272)	12.1 (307)	15.1 (383)
12" (315)	ISBS1287	27.6 (700)	46.9 (1191)	13.8 (350)	15.7 (398)	24.9 (633)

SW Commercial

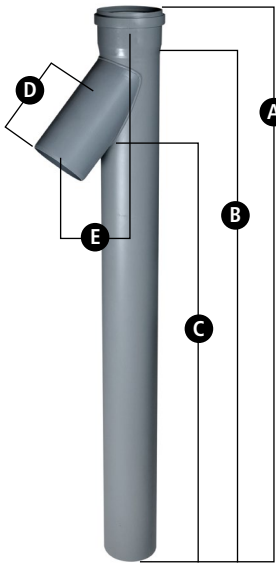

Branch Tee with Single Feeder

42° Y allows for the cascading of appliances in an inline configuration. Other size configuration available upon request.

Nominal Diameter	Part #	Overall Length "A"	Effective Length "B"	Effective Length "C"	Feeder Length "D"	Offset "E"
4" (110)	ISBT040415	17.7 (449)	15.2 (385)	8.1 (205)	7.9 (200)	5.8 (148)
4" (110)	ISBT040442	44.3 (1124)	41.7 (1060)	34.6 (880)	7.9 (200)	5.8 (148)
5" (125)	ISBT050412	14.8 (376)	12.0 (305)	4.9 (124)	7.9 (200)	6.1 (156)
5" (125)	ISBT050442	44.5 (1131)	41.7 (1060)	34.6 (879)	7.9 (200)	6.1 (156)
6" (160)	ISBT060412	15.2 (386)	12.0 (305)	4.3 (122)	7.9 (200)	6.8 (173)
6" (160)	ISBT060442	45.0 (1141)	41.7 (1060)	34.5 (877)	7.9 (200)	6.8 (173)
8" (200)	ISBT080412	15.9 (405)	12.0 (305)	4.7 (121)	7.9 (200)	7.6 (193)
8" (200)	ISBT080442	45.7 (1160)	41.7 (1060)	34.5 (876)	7.9 (200)	7.6 (193)
10" (250)	ISBT100412	15.9 (405)	12.0 (305)	4.7 (121)	7.9 (200)	8.6 (218)
10" (250)	ISBT100442	45.7 (1160)	41.7 (1060)	34.5 (876)	7.9 (200)	8.6 (218)

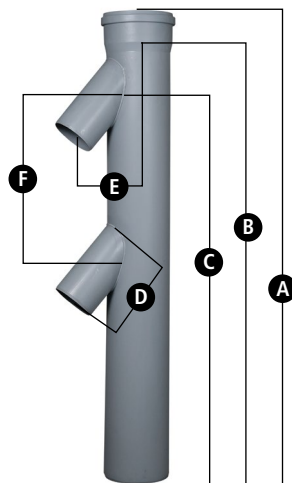

Branch Tee with Two Feeders

2 x 42° Ys allows for the cascading of appliances in line or a back to back configuration. Other size configurations available upon request.

Nominal Diameter	Part #	Overall Length "A"	Effective Length "B"	Effective Length "C"	Feeder Length "D"	Offset "E"	Offset "F"
6" (160)	ISBT0604422	45.0 (1142)	41.7 (1060)	34.5 (875)	7.9 (200)	6.8 (173)	15.9 (405)
8" (200)	ISBT0804422	45.7 (1160)	41.7 (1060)	34.5 (876)	7.9 (200)	7.6 (193)	15.8 (400)

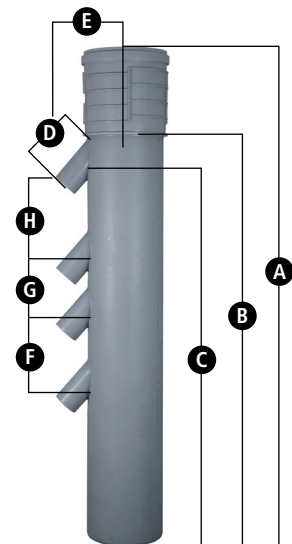

Branch Tee with Four Feeders

4 x 42° Ys allows for the cascading of appliances in a back to back configuration. Other sizes configuration available upon request.

Nominal Diameter	Part #	Overall Length "A"	Effective Length "B"	Effective Length "C"	Feeder Length "D"	Offset "E"	Offset "F"	Offset "G"	Offset "H"
10" (250)	ISBT1004514	55.1 (1400)	51.2 (1300)	43.9 (1116)	7.9 (200)	8.6 (218)	11.8 (299)	9.1 (232)	14.6 (371)
12" (315)	ISBT1204744	86.5 (2198)	73.8 (1876)	66.6 (1691)	7.9 (200)	9.9 (250)	11.8 (299)	9.1 (232)	14.6 (371)

Custom Branch Tees

Branch Tees can be made to order using a variety of diameter manifolds and feeders.

Commercial SW



Non-Return Valve

Used in cascade or common vent configurations, Non-Return Valves prevent the escape of combustion gas through non-operating appliances. Product is only available for purchase through Original Equipment Manufacturers.

Nominal Diameter	Part #	Overall Length "A"	Effective Length "B"	Max Dia. "C"
3" to 4" (80/110)	ISNRV0304	9.7 (246)	7.4 (188)	8.9 (225)
4" to 4" (110/110)	ISNRV0404	10.3 (262)	8.0 (204)	8.9 (225)

Cascade Component Kits



Cascade Component Kits

Available in various sizes and configurations. Contact your sales representative for more information.

SW
Commercial

Condensate Management

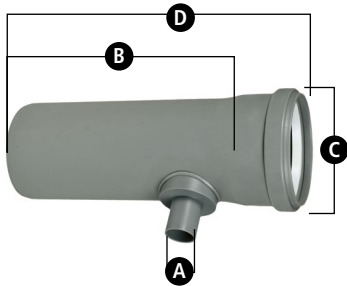

Use to drain condensate from the vent system. Install in horizontal section closest to appliance. 1.26" (32mm) O.D. drain. Use with any InnoFlue® Siphon.

Nominal Diameter	Part #	Drain O.D. "A"	Effective Length "B"	Max O.D. "C"	Overall Length "D"
6" (160)	ISHDT06	1.3 (32)	9.8 (250)	7.2 (183)	12.4 (315)
8" (200)	ISHDT08	1.3 (32)	12.0 (305)	8.8 (224)	16.0 (405)
10" (250)	ISHDT10	1.3 (32)	12.0 (305)	10.7 (272)	16.0 (405)
12" (315)	ISHDT12	1.3 (32)	24.0 (1610)	13.8 (350)	36.7 (1932)

Horizontal Drain Fitting

Use with any InnoFlue® siphon. Placed at the end of the last Branch Tee in a cascade configuration, the Horizontal Drain Fitting removes condensate from the system and allows for inspections and system clean out. 32mm O.D. drain.

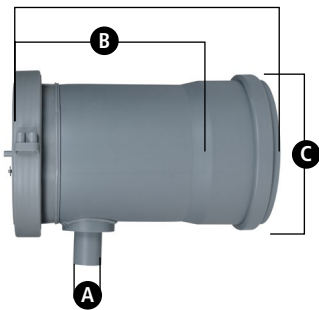

Nominal Diameter	Part #	Drain O.D. "A"	Effective Length "B"	Max O.D. "C"	Overall Length "D"
4" (110)	ISHDF04	1.3 (32)	7.2 (182)	5.1 (129)	9.7
5" (125)	ISHDF05	1.3 (32)	7.4 (187)	5.8 (146)	11.3
6" (160)	ISHDF06	1.3 (32)	8.1 (209)	7.2 (183)	12.1
8" (200)	ISHDF08	1.3 (32)	8.5 (215)	8.8 (224)	12.7
10" (250)	ISHDF10	1.3 (32)	13.8 (350)	10.7 (272)	18.0
12" (315)	ISHDF12	1.3 (32)	6.3 (160)	13.8 (350)	19.0

Tee

Use to change the direction of the vent system, combine multiple appliances, and capture condensates at base of long vertical runs.

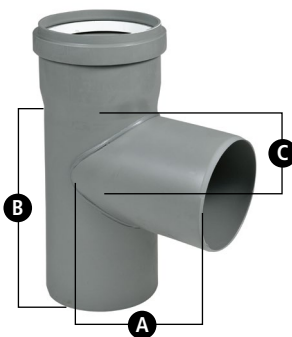

Nominal Diameter	Part #	Effective Length "A"	Effective Length "B"	Effective Length "C"
6" (160)	IST06	6.6 (168)	11.2 (284)	4.1 (105)
8" (200)	IST08	8.5 (215)	15.2 (387)	6.5 (165)
10" (250)	IST10	16.5 (419)	16.5 (420)	7.0 (179)
12" (315)	IST12	19.7 (500)	28.7 (728)	7.5 (189.5)



Tee Cap

Seals non-utilized tees and branch tees.

Nominal Diameter	Part #	Max O.D. "A"
6" (160)	ISTC06	7.3 (185)
8" (200)	ISTC08	8.8 (224)
10" (250)	ISTC10	10.7 (272)
12" (315)	ISTC12	13.8 (350)

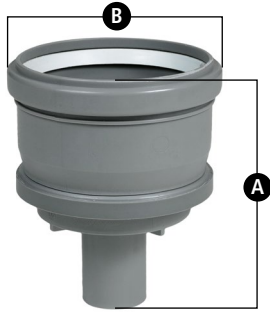

Tee Cap with Drain

Use with any InnoFlue® siphon to drain condensate from the vent system.

Nominal Diameter	Part #	Overall Length "A"	Max O.D. "B"
6" (160)	ISTCD06	6.9 (175)	7.2 (185)
8" (200)	ISTCD08	8.9 (225)	8.8 (224)
10" (250)	ISTCD10	8.9 (225)	10.7 (273)
12" (315)	ISTCD12	16.0 (407)	13.8 (351)

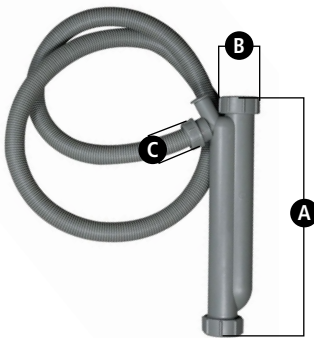

Extra Long John Siphon

Attaches to any InnoFlue® drain. Allows condensates to flow while containing combustion gases..

Nominal Diameter	Part #	Overall Length "A"	I.D. "B"	O.D. "C"
1.3 (32)	IAELJS	11.9 (302)	1.3 (32)	1.3 (32)

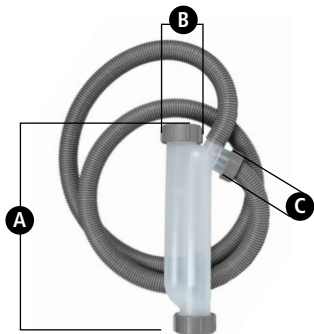

Long John Siphon

Attaches to any InnoFlue® drain. Allows condensates to flow while containing combustion gases.

Nominal Diameter	Part #	Overall Length "A"	I.D. "B"	O.D. "C"
1.3 (32)	IALJS	9.7 (247)	1.3 (32)	1.3 (32)

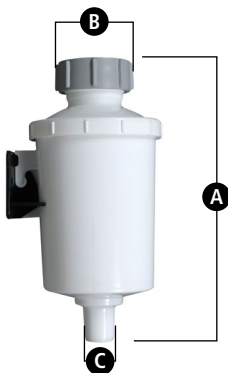

Ball Valve Siphon

Attaches to any InnoFlue® drain to allow condensates to flow while containing combustion gases.

Nominal Diameter	Part #	Overall Length "A"	I.D. "B"	O.D. "C"
1.3 (32)	IASBV	7.3 (187)	1.3 (32)	0.8 (20)

SW
Commercial

NEW!

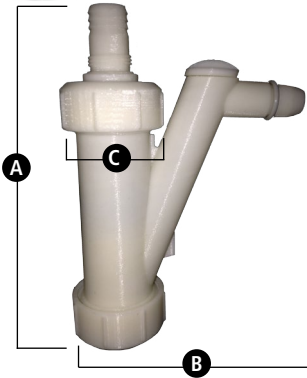

Terminations

Short John Ball Valve Siphon

Attaches to any InnoFlue® drain. Allows condensates to flow while unique ball valve assures combustion gases remain contained at higher temperatures.

Part #	Overall Height "A"	Overall Length "B"	Overall Width "C"
IASJBVS	6.5	4.5	1.9

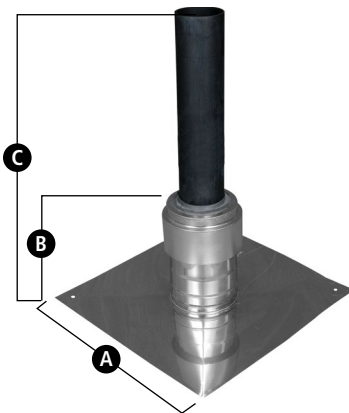

Chimney Cover SS with PPs-UV End Pipe

Stainless steel termination with polypropylene end pipe seals top of the chimney or chase.

Nominal Diameter	Part #	Length "A"	Width "B"	Height "C"
6"	ISCM06	15.8	15.9	16.7
8"	ISCM08	19.7	19.7	19.7
10"	ISCM10	20	20	20
12"	ISCM12	20	20	39.4

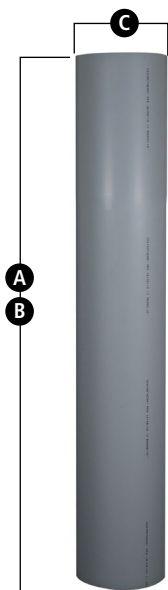

End Pipe PPs-Gray

PPs End Pipes allow for termination of the vent system through the wall or roof.

Nominal Diameter	Part #	Overall Length "A"	Effective Length "B"	Max O.D. "C"
8" (200)	ISEP086	70 (1778)	70 (1778)	8 (200)
10" (250)	ISEP106	70 (1778)	70 (1778)	10 (250)

Commercial
SW

Termination Tee (long)

Made from black polypropylene. Use where termination is exposed to excessive sunlight, wind or prone to freeze ups.



Nominal Diameter	Part #	Length "A"	Width "B"	Height "C"
6"	ISTT0620UV	9	6.5	30.8
8"	ISTT0820	16	7.9	32
10"	ISTT1020	20.5	9.9	32.3
12"	ISTT1220	22	12.4	41.5



Velocity Cone

Made to order. Call for more information.

Nominal Diameter	Part #
3" to 2"	ISVC0302
4" to 3"	ISVC0403
5" to 4"	ISVC0504
6" to 4"	ISVC0604
6" to 5"	ISCV0605
8" to 6"	ISVC0806
10" to 6"	ISVC1006
10" to 8"	ISVC1008

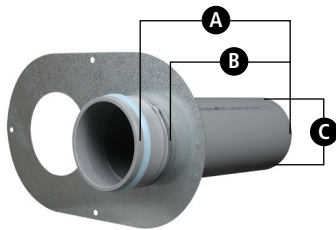

PPs to PVC Termination Kit

Adapts PPs to PVC Twin Pipe Termination. Comes with replacement wall plate and termination adaptor.

Nominal Diameter	Part #	Overall Length "A"	Effective Length "B"	End O.D. "C"
6" (160)	ISLTK06	14.4 (366)	11.0 (280)	6.5 (166)



Bird Screen PPs-UV

Fits inside InnoFlue® SW and Flex end-pipes at terminations.

Nominal Diameter	Part #
6" (160)	IASPP06



Bird Screen SS

Fits inside InnoFlue® SW and Flex end-pipes at terminations.

Nominal Diameter	Part #
6" (160)	IASSS06
8" (200)	IASSS08
10" (250)	IASSS10
12" (315)	IASSS12

Spacers

6" Spacers

Self positioning spacers centers InnoFlue® SW in a chase/chimney/B-vent.

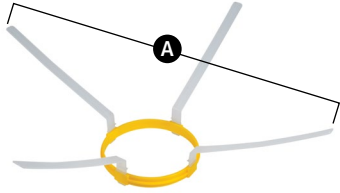

Nominal Diameter	Part #	Max Width "A"	Min Width
6" (160)	IASP06	25.0 (635)	7 (186)

8", 10" and 12" Spacers

Self positioning spacers centers InnoFlue® SW in a chase/chimney/B-vent.

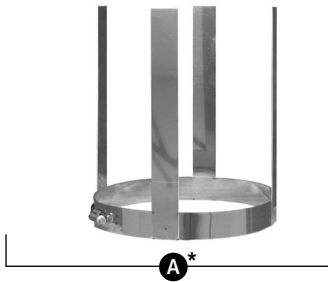

Nominal Diameter	Part #	Max Width "A"	Min Width
8" (200)	IASP08	27.6 (700)	9 (228)
10" (250)	IASP10	29.5 (750)	11 (276)
12" (315)	IASP12	32.1 (815)	13 (341)

* When bent into place.

Flue Clamp

Secures ISAG and ISAGL appliance adaptors to appliance flue exhaust.

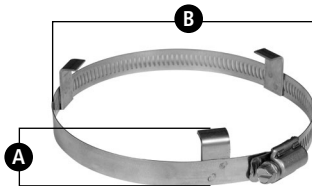

Nominal Diameter	Part #	Height "A"	Max. I.D. "B"
6" (160)	IAFC06	1.0 (26)	8.3 (211)

Connector Ring

Provides reinforcement at joints to support loads of up to 99 lbs (45Kg). 6" through 12" connector rings are available but not required per UL 1738 and ULC-S636.

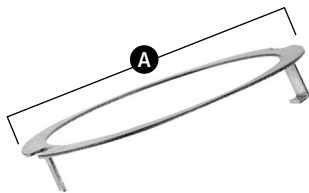

Nominal Diameter	Part #	O.D. "A"
6" (160)	IANS06	7.5 (191)
8" (200)	IANS08	9.4 (239)
10" (250)	IANS10	10.7 (271)
12" (315)	IANS12	14.9 (378.5)



Connector Double Hose Clamp

Connection clamps provide mechanical connection as required by O.E.M.

Nominal Diameter	Part #
5" (125)	IADHC0505
6" (160)	IADHC0606
8" (200)	IADHC0808
10" (250)	IADHC1010
12" (315)	IADHC1212

NEW!

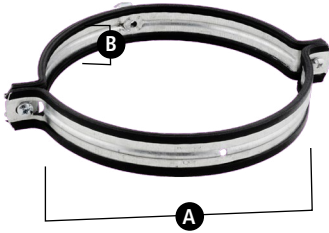

Support Clamp

Used as vertical or horizontal support. Space 78" in vertical and 39" in horizontal installations. **Uses 3/8" threaded rod.**

Nominal Diameter	Part #	Overall Length "A"	Height "B"
6" (160)	IASCM06	6.8 (172.7)	1.1 (28)
8" (200)	IASCM08	8.4 (213.3)	1.1 (28)
10" (250)	IASCM10	10.3 (261.6)	1.1 (28)
12" (315)	IASCM12	12.8 (325.1)	1.1 (28)

EPDM Gaskets

Standard gasket for 6" through 12" diameter InnoFlue® SW. Inserted into the female end of each part, the gaskets keep flue gases and condensates within the vent system.

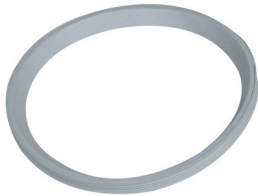

Nominal Diameter	Part #
6" (160)	ISGE06
8" (200)	ISGE08
10" (250)	ISGE10
12" (315)	ISGE12



Wall Plate Square Steel

Used to improve aesthetics and reduce drafts at chimney openings or wall penetrations.

Nominal Diameter	Part #	Overall Length "A"	Width of Opening "B"
6" (160)	IAWPSSW06	9.8 (250)	6.9 (175)



Centrocerin

A water based lubricant used to ease the assembly of InnoFlue® SW & Flex. Sparingly applied to the gasket or male end.

Package Size	Part #
50 ml	IACE50



Centrotherm Eco Systems
Albany, New York



Centrotherm Systemtechnik GmbH
Brilon, Germany

About Centrotherm

For over 20 years, the Ubbink-Centrotherm group of companies has manufactured the most comprehensive line of polypropylene flue gas systems in the industry including Single Wall, Flexible, and Concentric Vent solutions. In addition to our extensive range of standard vent products, Centrotherm is a full service manufacturer of appliance components for original equipment manufacturers. As the industry leader, Centrotherm is experienced in providing design services, prototyping, testing, and logistics management to its diverse sales channels.



Team up any high efficiency gas or oil fired appliance with InnoFlue[®] the superior performing, environmentally sustainable vent system with an established and solid track record of nearly two decades of field service.

Centrotherm Eco Systems is part of Centrotec Group, a publicly traded diversified manufacturer of sustainable industrial products.

For more information about Centrotec Sustainable AG, visit www.centrotec.de



Centrotherm Eco Systems, LLC
400 South Pearl Street
Albany, NY 12202
Toll Free: 877 434 3432
Fax: 518 618 3166
info@centrotherm.us.com
www.centrotherm.us.com