

**BANDO**

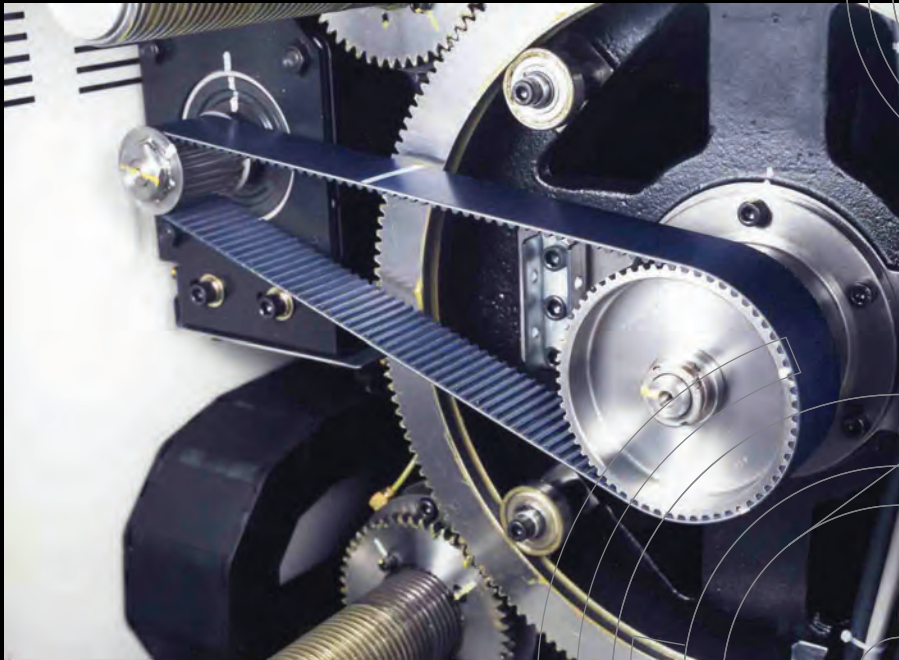

# **Industrial Power Transmission Products**

# Table of Contents

<b>Reference Information</b> .....		2
<b>Distribution, Service and Sales</b> .....		3
<b>V-Belt Products</b>	<b>Preview Page</b>	<b>Price Page</b>
Power Ace® (3V, 5V, 8V) .....	.3	.17
Power King® (A, B, C, D, E) .....	.4	.18
Power Ace® Cog (3VX, 5VX) .....	.4	.22
Power King® Cog (AX, BX, CX) .....	.4	.23
Power Ace® Combo (3V, 5V, 8V) .....	.5	.25
Power King® Combo (B, C, D) .....	.5	.27
Power Ace® Aramid Combo V-Belts (8VK) .....	.5	.30
Power Ace® Cog Combo (3VX, 5VX) .....	.5	.31
Power Max® Variable Speed .....	.6	.32
Rib Ace® (J, L, M) .....	.6	.36
Double V (AA, BB, CC) .....	.7	.38
Duraflex GL® Cog (2L) .....	.7	.40
Duraflex GL® FHP (3L, 4L, 5L) .....	.8	.40
Duraflex VC® and DC .....	.8	.43
Ultrapower AG™ KC Belts (A, B) .....	.9	.44
Metric (XPZ/SPZ, XPA/SPA, XPB/SPB, SPC) .....	.9	.46
Banflex® (3M, 5M, 7M, 11M) .....	.10	.49
Banflex® Combo (5MS, 7MS, 11MS) .....	.10	.51
<b>Synchro-Link® Timing Belt Products</b> .....	.11	
Synchro-Link® Single Sided Timing Belts		
Synchro-Link® STS Timing Belts - Neoprene (Metric) (STS2M, STS3M, STS4.5M, STS5M, STS8M, STS14M) .....	.12	.54
Synchro-Link® HPS Timing Belts - Neoprene (Metric) (HPS5M, HPS8M, HPS14M) .....	.12	.66
Synchro-Link® KPS II Timing Belts - Polyurethane (Metric) (KPS8M, KPS14M) .....	.13	.71
Synchro-Link® HT Timing Belts - Neoprene (Metric) (3M, 5M, 8M, 14M) .....	.13	.73
Synchro-Link® Timing Belts - Neoprene (RMA) (MXL, XL, L, H, XH, XXH) .....	.14	.79
Synchro-Link® Timing Belts - Polyurethane (RMA) (XL, L) .....	.14	.92
Synchro-Link® Timing Belts - Polyurethane (Metric) (T2.5, T5, T10) .....	.14	.94
Synchro-Link® Double Sided Timing Belts		
Synchro-Link® Double Sided Timing Belts - Neoprene (RMA) (DXL, DL, DH) .....	.15	.98
Synchro-Link® Double Sided Timing Belts - Polyurethane (RMA) (DMXL, DXL) .....	.15	.104
Synchro-Link® Double Sided Timing Belts - Polyurethane (Metric) (DT5, DT10) .....	.15	.106
Open Ended Timing Belts .....		.108
<b>Synchro-Link® Timing Belt Pulleys</b>		
STS MPB Timing Belt Pulleys (S8M, S14M) .....	.16	.109
Synchro-Link® STS TL® Timing Belt Pulleys (S8M, S14M) .....	.16	.111
Synchro-Link® HT Timing Belt Pulleys	.16	
MPB (5M, 8M, 14M) .....		.113
QD® (5M, 8M, 14M) .....		.114
Synchro-Link® MPB Timing Belt Pulleys (XL, L, H) .....	.16	.119
Synchro-Link® QD® Timing Belts Pulleys (L, H) .....	.16	.123
Synchro-Link® TL® Timing Belts Pulleys (L, H) .....	.16	.126
<b>Bushings</b>		
QD® & TL® .....		.128
Belt Racks .....		.42
Belt Sleeves .....		.41
Belt Troubleshooting Guide .....		.134
Installation and Maintenance Tools .....		.39
Manufacturers Brand Name Reference .....		.135
Minimum Recommended Pulley Sizes .....		.85, 116
Minimum Recommended Sheave Diameters .....		.25, 37, 43
Power King® and Power Ace® Combo Mandrel Program .....		.29
Preventative Maintenance .....		.121
Product Warranty .....		.2
Rebore, Keyway and Set Screw Alterations .....		.119
Specialty Application Synchro-Link® Belts .....		.101
Synchro-Link® Belt Handling .....		.93
Synchro-Link® Operating Conditions .....		.91
Synchro-Link® Sleeve Program .....		.107
Tensioning for Synchro-Link® STS, HPS and KPS II Timing Belts .....		.72
Tensioning for Synchro-Link® HT Timing Belts .....		.77
Tensioning Information .....		.133
Useful Formulas for V-Belt Drives .....		.136
V-Belt Installation .....		.132

QD® is a registered trademark of Emerson Electric.  
Taper-Lock® and TL® are registered trademarks of Reliance Electric.

## Reference Information

### Service Express

**1-800-829-6612**

Place an order, request technical assistance, discuss commercial issues – our knowledgeable team of inside sales professionals is prepared to handle your orders, inquiries or special requirements promptly, courteously and efficiently. **Service Express** hours are 7:00 A.M. through 6:00 P.M. CST.

### Message Express

**1-800-733-3672**

BANDO's **Message Express** is your real time communication link to any one of BANDO's field sales representatives, inside sales representatives, product specialists, engineering support personnel or any member of BANDO's management team.

If you don't know your party's extension, **Message Express** will assist you in connecting to the individual with whom you wish to communicate.

### Web Page

Visit our web site at [www.bandousa.com](http://www.bandousa.com) for information on products, purchasing options, "What's New" at BANDO and to review our privacy statement.

### Email

Contact us via email at: [serviceexpress@bandousa.com](mailto:serviceexpress@bandousa.com)

Looking for the "e-dress" of a specific individual – request that information via email (above), **Message Express** (above) or phone 630-773-6600 and our receptionist will give you that information.

**BAN/SET**<sup>®</sup>

BANDO's proprietary **BAN/SET**<sup>®</sup> system is your assurance that all belts shown with the **BAN/SET**<sup>®</sup> designation will match all other belts of the same size and type. **BAN/SET**<sup>®</sup> eliminates cumbersome, complex and time consuming matching systems, reduces inventory and simplifies order procedures.

### Application Exclusions

For safety reasons, BANDO belts may not be designed into, applied on, or sold as replacements for any of the following applications:

- Aircraft (propeller or rotor) drive systems or any inflight accessory system drives.
- Any type of "lift system" for personnel or product that relies solely on the belt for support without an appropriate "fail safe" type of backup support system(s).

### Static Conductivity

All BANDO belts labeled "*static conductive*" will meet the Rubber Manufacturers Association (RMA) requirements for static conductivity. Belts not marked "*static conductive*" may not meet the Rubber Manufacturers Association (RMA) requirements for static conductivity.

For specific applications requiring static conductive belts, consult your BANDO sales representative or BANDO headquarters in Itasca, IL for static conductive certification and installation instructions.

### Specifications

BANDO USA, Inc. reserves the right to modify, improve and/or enhance product design, specifications, dimensions and materials at any time without obligation for replacement or refund on any products or parts thereof which may be in any customers' possession at the time such changes become effective.

All dimensions shown in this catalog are for *reference purposes only* and are subject to change without notice. Where space requirements are critical, consult BANDO for certified specifications.

### The BANDO Product Warranty

BANDO USA, Inc. warrants its products against defects in material and workmanship, under normal use and service, for a period of one year from date of shipment. BANDO's obligation under this warranty is limited to repairing or furnishing a similar product without charge. BANDO shall have the option of requiring the return of the defective material, transportation prepaid, to establish the claim. All claims must be made in writing. No allowances will be made for repairs or alterations without BANDO's written consent or approval. BANDO shall not in any event be liable for any special indirect or consequential damage. THERE IS NO IMPLIED WARRANTY OF MERCHANTABILITY OR FITNESS FOR A PARTICULAR PURPOSE.

## Stocking Distributors

BANDO USA, Inc. markets their products through over 500 stocking distributors located throughout North and South America.

These Distributors are serviced and supplied by BANDO distribution centers that are strategically located to provide optimum service levels on a local market basis.

## Design Engineering and Application Assistance

Assistance in drive design, application or general engineering support is always available through your BANDO distributor, your BANDO sales representative or by contacting BANDO USA, Inc.

Whether your request is for a complex drive application or for basic information on any BANDO product, we will be pleased to assist you.

## Pricing

All prices in this catalog are list. For actual purchase price, contact your BANDO stocking distributor. All list prices are in USD and are subject to change without notice.

## BANDO Field Sales Representatives

BANDO USA Inc.'s team of sales representatives have an average of 20 years field sales experience per man. These are experienced power transmission specialists who work for and with BANDO distributors. For the name and location of the BANDO distributor nearest you, or the name of your BANDO sales representative, contact BANDO via:

**SERVICE EXPRESS 1-800-829-6612**  
**[www.bandousa.com](http://www.bandousa.com)**

## **Power Ace®**



**BAN/SET®**

BANDO's Power Ace® narrow profile V-belt transmits power more efficiently and effectively, delivering higher horsepower ratings than classical cross section belts. BANDO's Power Ace® should be considered for any new drive application, as they can transmit the same load as classical belts in 1/2 to 2/3 the space.

- The special bias cut angle of the cover fabric reduces stress as the belt bends around sheaves, lowering heat build up that shortens belt life.
- Extra strong polyester cords are treated for fatigue, stretch resistance and adhesion to assure the longest possible belt life.
- The rubber compound of the body is engineered to maintain structural uniformity while maintaining the flexibility to reduce heat build up.
- Meets RMA standards for oil and heat resistance and static conductivity.

Refer to page 17 for size and list price information.



## Power King®



**BAN/SET**®

BANDO's continuous improvements in materials, design and manufacturing methods make the Power King® classical cross section belt the workhorse of industry.

- Bias cut, rubber impregnated fabric cover provides superior flexibility and friction resistance. Oil and heat resistant.
- Ultra high strength polyester cords assure fatigue resistance and length stability while providing the flexibility needed to attain long, trouble-free service.
- Specially compounded rubber body reduces heat build-up while giving firm support to the cords, maintaining uniform load distribution.
- Meets RMA standards for oil and heat resistance and static conductivity.

Refer to pages 18 through 21 for size and list price information.

## Power Ace® Cog and Power King® Cog



**BAN/SET**®

Studies have determined that using BANDO Power King® Cog and Power Ace® Cog V-belts can save substantial dollars on energy consumption. The precision molded raw edge cogged construction transfers power with much greater efficiency, allowing for smaller sheave sizes and increased power transmission capabilities.

- The bias cut cover stock provides lateral stability across the width of the belt while allowing axial flexibility.
- Stability is assured through the use of **BANPRENE**® cushion stock that maintains cord integrity, assuring uniform distribution of load transmission.
- The fiber loaded cogged construction provides optimum flexibility and minimizes heat build-up.
- Meets RMA standards for oil and heat resistance and static conductivity.

Refer to pages 22 through 24 for size and list price information.



## **Power Ace® Combo, Power King® Combo and Power Ace® Aramid Combo**



**BAN/SET®**

To resolve problem applications where belts are flipping over or jumping out of the sheaves, utilize BANDO's series of Combo belts. The tie band assures lateral rigidity and guides the belts into the sheave grooves.

- The tie band, reinforced with high strength transverse tensile cords, is fully oil and heat resistant and permanently welds the individual belts together.
- Combos utilize the premium quality Power King® and Power Ace® belts, with all of their features and benefits.
- Assures equal load distribution in drives where high shock or pulsating loads cause belts to whip, flip over or jump out of the sheave grooves.
- Combos are ideal for use on vertical shaft drives.
- Meets RMA standards for oil and heat resistance and static conductivity.

Power Ace® Aramid Combo belts are constructed with high modulus aramid cords to maintain length stability and to withstand severe shock loads, making them ideally suited for oil, gas, aggregate and lumber industry applications.

Refer to pages 25 through 30 for size and list price information.

## **Power Ace® Cog Combo**

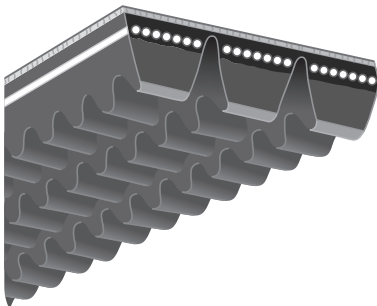

**BAN/SET®**

Power Ace® Cog Combo combines the superior load carrying capacity of the Power Ace® Cog belt with the banded construction of BANDO's Combo series to provide an exceptional belt for troublesome applications. The tie band assures lateral rigidity and guides the belts into the sheave grooves.

- The tie band, reinforced with high strength transverse tensile cords, is fully oil and heat resistant and permanently welds the individual belts together.
- Power Ace® Cog Combos utilize the premium quality Power Ace® Cog belts, with all of their features and benefits.
- Provide belt stability in drives where high shock or pulsating loads cause belts to whip, flip over, or jump out of the sheave grooves.
- Assure equal load distribution.
- Power Ace® Cog Combos are ideal for use on vertical shaft drives.
- Meets RMA standards for oil and heat resistance and static conductivity.

Refer to page 31 for size and list price information.



## **Power Max<sup>®</sup>**

Because Power Max<sup>®</sup> belts are wide in proportion to their thickness, they must have extreme crosswise rigidity to keep them from dishing in. This dishing would cause the tensile cords to become misaligned, leading to uneven speed control and excessive wear on the cords, causing premature failure.

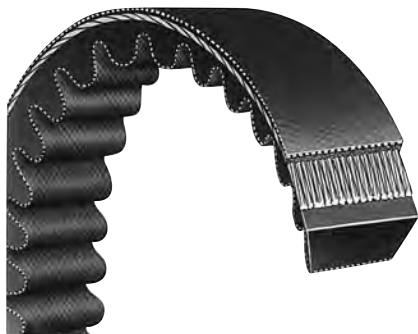

- Power Max<sup>®</sup> belts provide lengthwise flexibility to bend around small sheave diameters without excess strain that would shorten belt life.
- Tough polyester cords won't fatigue, even with repeated shock loads. Cords are specially treated to resist stretch and carry high horsepower loads.
- Transversely aligned fiber reinforcement in the belt cogs assures crosswise rigidity and flexibility to reduce heat build up and minimize cracking.
- Meets RMA standards for oil and heat resistance and static conductivity.

Refer to pages 32 through 35 for size and list price information.

## **Rib Ace<sup>®</sup>**

BANDO's Rib Ace<sup>®</sup> is an ultra thin, extremely flexible belt with the versatility to handle heavy, high speed industrial applications like machine tools, as well as light duty, slower applications such as exercise equipment.



- Able to utilize very small sheaves, allowing for speed ratios up to 40 to 1.
- Smooth, vibration-free performance ideally suited for consumer goods applications like clothes dryers.
- Rib Ace<sup>®</sup> belts can be used in serpentine drive configurations with small backside idlers, making for compact design.
- Rib Ace<sup>®</sup> belts improve performance on 1/8 turn, 1/4 turn and mule drives.

Refer to pages 36 and 37 for size and list price information.



## Double V



Serpentine drives with one or more reverse bends which require power to be transmitted from both sides of the belt can put extra stress on belt components. BANDO's Double V dual-direction flexibility assures long life - as much as 40% more than traditional Double V-belts.

- Ideally suited to handle tough applications such as agricultural, textile and printing machinery.
- High strength polyester tensile cords provide superior length stability and fatigue resistance. Cords are bonded together chemically to the body of the belt to prevent separation and to assure long service life.
- The upper and lower sections of the belt are compounded for extra flexibility to allow the belt to bend easily in both directions.
- Designed for low heat build up to extend belt life.
- Meets RMA standards for oil and heat resistance and static conductivity.

Refer to pages 38 and 39 for size and list price information.

## Duraflex GL<sup>®</sup> Cog

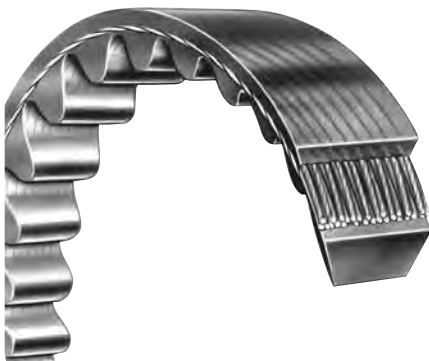

Duraflex GL<sup>®</sup> combines cogged construction with polyurethane material to provide a belt supremely suited for light duty 2L fractional horsepower drives. Clean room environments, food processing and textile machinery all benefit from the elimination of "black dust" common to conventional FHP belts.

- Polyurethane construction is ten times more oil resistant than rubber and provides super clean operation. It won't absorb lubricants and swell like rubber belts.
- Strong polyester tensile cords are placed with extreme accuracy to distribute horsepower loads uniformly for long belt life. Specially treated cords assure no-stretch, no-wobble performance even in high speed, severe shock load applications.
- Duraflex GL<sup>®</sup> Cog available only in 2L cross section.

Refer to page 40 for size and list price information.





## Duraflex GL®



Duraflex GL® V-belts are specifically designed for shorter center distance, high speed fractional horsepower drives. Common applications include HVAC equipment and appliances.

- Oil, heat and ozone resistant bias cut, rubber impregnated fabric cover protects inner components for long life.
- High strength polyester tensile cords provide maximum fatigue and stretch resistance. The cords are positioned, supported and protected by the insulation section for uniform load distribution.
- The special rubber compound in the body of the belt is formulated to flex around small sheaves and dissipate heat build up to extend belt life.
- Meets RMA standards for oil and heat resistance and static conductivity.

Refer to pages 40 through 42 for size and list price information.

## Duraflex® VC (Cogged) and DC (Double Cog)

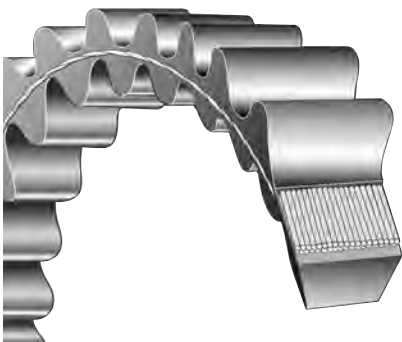
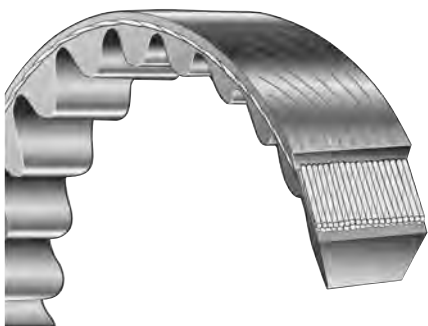

Duraflex® VC and DC are the most precise V-belts available. Because of their superior dimensional stability, Duraflex® VC and DC have half the center-to-center distance variation of conventional belts. This stability and exceptionally high coefficient of friction add up to minimal slippage. The polyurethane construction eliminates the black dust problem common in conventional belts.

- The polyurethane body is more stable, flexible and the non-conductive compound is highly resistant to lubricants with a minimal volume increase.
- Exclusive BANDO TETRON® cords are positioned with exact spacing to insure tensile strength and dimensional stability in high speed shock load applications.
- Cogged design provides maximum flexibility without sacrificing either strength or performance. Double cog construction allows you to scale down pulley size requirements. Cogs allow efficient operation in pulleys as small as 0.6" OD with virtually no slippage or heat build up.

Refer to page 43 for size and list price information.



## Ultrapower AG™ KC\*

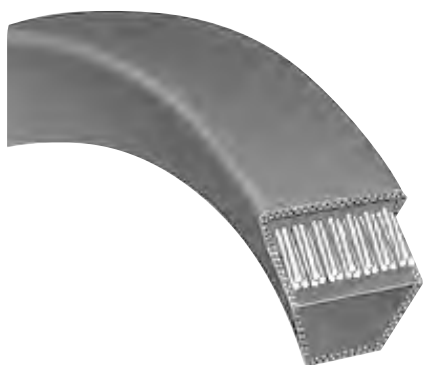

Ultrapower AG™ KC is constructed specifically for those drives where a clutching function is essential to successful operation. Compounded to provide maximum durability during the clutching phase of operation, the KC's envelope, aramid fiber tension members and low profile design provide extended service life and superior flexibility to handle idler and reverse bend drive configurations typical of many power equipment applications.

- BANDO's KC envelope is designed specifically to handle the wear and tear of clutching applications. Bias cut, cross woven fabric is oil and heat resistant.
- Aramid fiber tensile cords transmit up to 20% more horsepower than traditional polyester construction. High modulus cords placed just above the neutral axis resist elongation, reducing or eliminating re-tensioning or expensive take-up mechanisms.
- The body of the KC is formulated to reduce heat buildup for a cooler running, longer lasting belt. The **BANPRENE®** compound balances firmness with flexibility to maintain cross sectional uniformity.

\*Where clutching is not a requirement, select the Ultrapower AG™ K construction which has the same internal components as the KC design, only with a rubber impregnated fabric cover.

Refer to page 44 and 45 for size and list price information.

## Metric V-Belts



In addition to belts manufactured to RMA (Rubber Manufacturers Association) standards, BANDO produces belts to European standard DIN 7753 and ISO4184. These standards are based on the metric system of measure and have different cross section designations. The Narrow Wedge profile allows for higher speed ratios, shorter center distances and more compact drives. They are direct replacements for belts on imported machinery and on domestic equipment for export.

- Oil and heat resistant bias cut envelope protects the belt's inner components against dirt, oil and heat. The bias cut **BANPRENE®** impregnated fabric provides lateral stability while permitting axial flexibility for operating around small pulley diameters.
- High density polyester tension members treated for fatigue and elongation resistance minimize maintenance costs.
- **BANPRENE®** compression section maintains tension member cross section uniformity while remaining flexible enough to reduce heat build up - one of the primary causes of premature belt failure.

Refer to pages 46 through 48 for size and list price information.



## **BanFlex®**



The small cross section of the BanFlex® belts makes them the preferred choice where short center distances and small diameter sheaves are required on compact equipment designs. The 60° sidewall angle and precision molded, seamless construction allows for precise belt-to-sheave meshing in high speed applications up to 10,000 RPM.

- Precision cast, seamless polyurethane body for maximum power transmission capability at high speeds.
- Polyester tensile member is treated to insure length stability and insure superior resistance to fatigue.
- Polyurethane ribs dissipate heat and assure lateral rigidity while providing longitudinal flexibility.

Refer to pages 49 and 50 for size and list price information.

## **BanFlex® Combo**

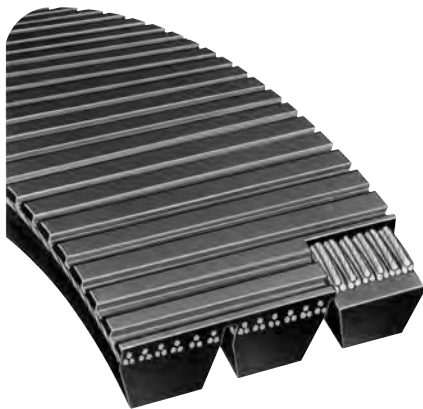

Ideally suited for short center distances and small diameter pulleys, BanFlex® Combos' banded construction minimizes or eliminates the turnover problem normally associated with small cross section belts. The ribbed construction provides superior flexibility while maintaining lateral stability.

- Precision molded, seamless polyurethane ribs provide maximum resistance to oil and traditional lubricants with virtually vibration free operation.
- Treated polyester tensile cords resist fatigue and stretch as well as providing exceptional length stability and drive uniformity.
- Polyamid tie band prevents belt whip under impulse loads.
- Polyurethane ribs on the back of the belt provide rigidity across the width of the belt and dissipate heat, leading to longer belt life.

Refer to pages 51 through 53 for size and list price information.



## Synchro-Link® Timing Belts

When synchronization of the driveN and driveR speed is required, Synchro-Link® Timing Belts give unsurpassed efficiency, economy and performance and are available in both inch (RMA) and metric dimensions. BANDO timing belts offer these advantages:

- **Popular Profiles** – Available in the high torque, low noise STS profile, the widely used HT curvilinear profile and the traditional Trapezoidal profile.
- **Non-Slip, Positive Performance** — Belt-pulley compatibility and close manufacturing tolerances assure that belt teeth mesh precisely with pulley grooves for constant output speed without skipping, vibration or speed variation.
- **Extremely energy efficient** - Studies by the US Department of Energy have found that synchronous belt drives are over 99% energy efficient, leading to lower operating costs.
- **Low Maintenance/Economical Operation** — Because timing belts do not require re-tensioning and, unlike gears or chain, require no lubrication, they are ideal for applications where maintenance is difficult and downtime is costly.
- **Low Tension Requirements** — The “tooth grip” principle of timing belts does not require high tension, so bearing loads are minimized, resulting in longer bearing and motor life.
- **Wide Range of Load Capacities and Speeds** — Design versatility makes timing belts the right choice for a variety of applications. Speeds can range from 1 to over 10,000 RPM; load carrying capacity can vary from fractional to hundreds of horsepower.
- **Space and Weight Savings** — Drives are compact because pulleys are small and center distances are short. Per horsepower transmitted, timing belts weigh only a fraction of alternative methods.
- **Clean, Quiet Operation** — Noise and vibration are kept to a minimum. Clean operation is ideal for contamination sensitive machines.

## Synchro-Link® Super Torque Timing Belts

Due to its high power transmission capabilities, quiet, smooth running tooth meshing qualities, energy efficiency and reliability, the STS tooth profile is widely recognized by automotive design engineers as the preferred belt for overhead cam applications in most late model cars and trucks. These same qualities make this generation of synchronous belts ideal for today's high performance industrial applications.

As the tooth meshes with the pulley groove, the cord lay forms an almost true circle, minimizing the cantilever effect on the cords, resulting in reduced bending fatigue and longer service life.

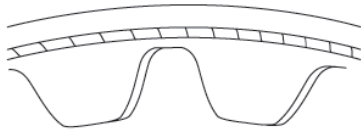

Smooth tooth engagement and direct contact of the belt tooth and the pulley groove enable the belt to run quietly, even at high speeds.

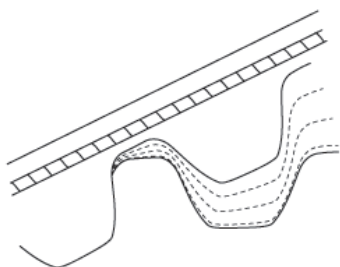



## Synchro-Link® STS Timing Belts



Unique modified curvilinear tooth form enables the STS belt to transmit greater loads than like-sized drives having the standard high torque tooth profile.

- Smoother tooth engagement and direct contact of belt tooth top with the pulley grooves enables the belt to run quietly - even at high speeds.
- As the tooth meshes with the pulley grooves, the cord lay forms an almost true circle, minimizing the cantilever effect on the cords, resulting in reduced bending fatigue and longer service life.
- No lubrication or re-tensioning required.
- Higher HP transmission capability can decrease the belt and pulley width, reducing the drive space envelope, resulting in a more compact machine design.

Refer to pages 54 through 65 for size and list price information.

## High Performance STS Belts

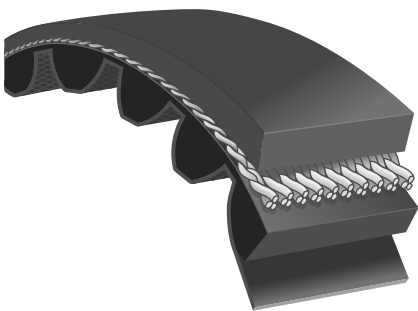

Anticipating the demand for energy savings and higher horsepower transmission, BANDO developed our High Performance STS (HPSTS) belt, utilizing our time-proven technology and experience.

- High durometer oil and heat resistant, static conductive synthetic rubber protects against tooth deformation, minimizing fatigue.
- Tooth canvas provides a low coefficient of friction, lowering noise levels.
- This HPSTS belt achieves exceptionally higher power transmission - up to 2 times as high as conventional STS belts.
- Higher HP transmission minimizes the width of the belt, making system design as compact as possible.
- The narrower width of the belt and pulleys results in a quieter running drive.
- Runs in standard stock STS pulleys.
- HPS5M is only available in clean specification, minimizing rubber dust.

Refer to pages 66 through 70 for size and list price information.



## King Power Synchronous Belt (KPS II)



Utilizing high modulus aramid cords and the unique blue polyurethane body, the KPS II is the belt of choice for applications requiring exceptional power transmission capabilities, particularly on lower speed-high torque drives.

- The KPS II belt transmits up to 5 times more power than a standard STS belt. This allows the same power transmission capacity to be achieved using narrower or smaller diameter pulleys, saving space and money.
- Wear-resistant polyurethane construction reduces rubber dust.
- Available in 8mm and 14mm pitch.
- Utilize standard STS pulleys for a wide range of speed ratios.

Refer to pages 71 and 72 for size and list price information.

## Synchro-Link® HT Timing Belts



BANDO's Synchro-Link® HT (High Torque Synchronous) belts' curvilinear tooth design improves stress distribution to provide high horsepower ratings over a wide speed range and high torque transmission at low speeds.

- The rounded tooth profile meshes precisely with matching pulley grooves so there is no belt creep or slip to cause speed variation.
- HT belt drives are 99% efficient, leading to significant energy savings on high horsepower applications.
- HT belts are thin and flexible so they do not generate heat build up, delivering long service life.
- Continuous, helically-wound S and Z oriented fiberglass cord is the load carrying muscle of the belt, resisting elongation and shock loads while providing excellent strength and service life.

Refer to pages 73 through 78 for size and list price information.





## Synchro-Link® Trapezoidal Timing Belts

### Neoprene



- The extra durable, highly flexible neoprene backing provides excellent abrasion and wear resistance — especially important if power is transmitted from the back of the belt. Backing also guards the tensile cords against oil, grease, dirt and moisture.
- Continuous, helically-wound high strength fiberglass tensile cords guarantee dimensional stability to eliminate take up adjustments. Heavy torque loads won't fatigue this super strong cord. S and Z orientation of the cords aid in minimizing belt tracking problems.
- Precision formed, oil and heat resistant neoprene teeth have a shear resistance equal to the tensile strength of the belt (under standard “6 teeth in mesh” tests). Tooth design and tight manufacturing tolerances provide full surface contact between belt and pulley for smooth running characteristics.
- The tooth surface is protected by a low friction, clean running, wear resistant woven nylon facing. Seamless construction eliminates vibration.

Refer to pages 79 through 91 for size and list price information.

### Polyurethane



- Polyurethane timing belts provide a lightweight drive system, when used with aluminum or plastic pulleys, and exceptionally quiet operation. They are ideal for applications needing high oil and ozone resistance, and their extremely clean operation make them suitable for appliance and office machine use. Metric sizes are often found on imported textile machinery.
- Body is made from the highest quality polyurethane for maximum oil and ozone resistance. Non-static conductive.
- Strong fiberglass cords oriented in an S and Z configuration, which won't stretch or fatigue over the life of the belt, provide high load carrying capacity and superior tooth shear strength under shock load applications.

Refer to pages 92 through 97 for size and list price information.



## **Synchro-Link® Double Sided Timing Belts (Neoprene)**

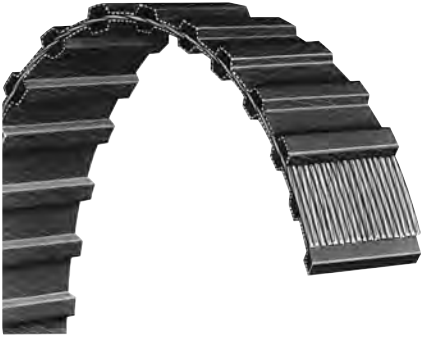

Synchro-Link® Double Sided Timing Belts provide smooth, precise performance under exacting drive conditions in serpentine drives common in printing, textile and packaging machinery. BANDO's precision molding process assures "mirror-image" symmetry, so both sides of the belt mesh with the pulley properly and provide maximum belt life.

- Flexible neoprene body resists oil, heat, ozone, grease and moisture for maximum belt life.
- Strong, helically-wound fiberglass cords won't stretch or fatigue under high horsepower loads.
- Durable precision formed teeth engage pulley grooves exactly for accurate synchronization from both sides of the belt.
- Tough nylon fabric on both sides of the belt protects teeth against wear and abrasion. Low coefficient of friction provides smooth running characteristics.

Refer to pages 98 through 103 for size and list price information.

## **Synchro-Link® Double Sided Timing Belts (Polyurethane)**

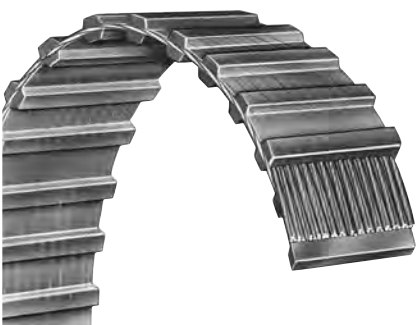

An ideal selection for serpentine drives where extremely clean, quiet operation is required. Precision molded to insure mirror image top and bottom tooth alignment for precise symmetry and synchronization.

- Top quality oil and ozone resistant polyurethane provides clean running operation and exceptionally long belt life.
- Strong fiberglass cords assure length stability and stand up to high horsepower loads.
- Extremely clean operation makes these belts ideally suited for appliance and office equipment applications.

Refer to pages 104 through 107 for size and list price information.



# Synchro-Link® Timing Belt Pulleys

For optimum performance, combine BANDO Synchro-Link® Timing Belts and Timing Belt Pulleys.

BANDO Synchro-Link® Timing Belt Pulleys are manufactured to exacting tolerances to assure total drive system compatibility. They are available in a complete range of sizes, types, configurations and materials to contribute to the efficiency, economy and performance of your drive.



Synchro-Link® **Minimum Plain Bore** for trapezoidal, STS and HT profiles

Refer to pages 109-110, 113, and 119-122 for size and list price information.



Synchro-Link® **QD** construction for trapezoidal and HT profiles

Refer to pages 114-118, and 123-125 for size and list price information.



Synchro-Link® **TL** construction for trapezoidal and STS profiles

Refer to pages 111-112, and 126-127 for size and list price information.

The type of pulley used on a Synchro-Link® drive depends on a number of factors, including but not limited to, space available, ratios, center distances, horsepower being transmitted, speeds and user preference of mounting systems (i.e. QD®, TL® or Minimum Plain Bore).

## An Explanation of Synchro-Link® Drive Pitches

With Synchro-Link® Drives, as with gear or chain drives, circular pitch (usually referred to as pitch) is a fundamental consideration. On the belt, pitch is the distance between tooth centers and is measured on the pitch line of the belt. On the pulley, pitch is the distance between groove centers and is measured on the pulley's pitch curve.

The pitch line of a Synchro-Link® Drive Belt is located within the tension member. The pitch circle of a Synchro-Link® Drive Belt pulley coincides with the pitch line of the belt mating with it.

Any Synchro-Link® Drive Belt must be run with pulleys of the same pitch. A belt of one pitch cannot be used successfully with pulleys of a different pitch.

### Synchro-Link® Drive Pulleys

- L Circular pitch of groove
- M Minimum depth of groove, including clearance
- N Width of groove at minimum depth, including clearance
- O Pressure angle
- P Top radius of groove
- R Pitch diameter (always > S)
- S Outside diameter

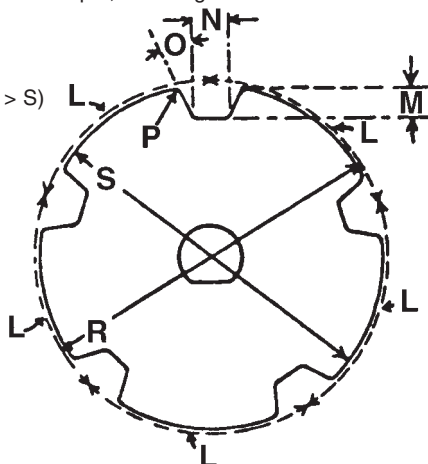

### Synchro-Link® Drive Belts

- A Pitch of teeth
  - B Depth of teeth
  - C Width of bottom of teeth
  - D Pressure angle
  - E Radius at bottom of teeth
  - F Radius at top of teeth
  - G Pitch line differential
- Belt P.L. = "A" x Total no. of teeth in belt

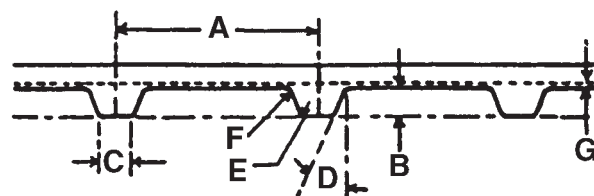



## Nominal Dimensions

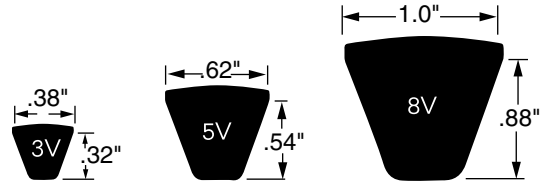

### 3V Section

Part Number	Weight* (Lbs.)	Effective Outside Length (Inches)	Part Number	Weight* (Lbs.)	Effective Outside Length (Inches)
3V250	0.114	25.0	3V630	0.288	63.0
3V265	0.121	26.5	3V650	0.292	65.0
3V280	0.128	28.0	3V670	0.307	67.0
3V300	0.137	30.0	3V710	0.325	71.0
3V315	0.144	31.5	3V750	0.343	75.0
3V335	0.153	33.5	3V800	0.366	80.0
3V355	0.162	35.5	3V850	0.389	85.0
3V375	0.172	37.5	3V900	0.412	90.0
3V400	0.183	40.0	3V950	0.435	95.0
3V425	0.194	42.5	3V1000	0.458	100.0
3V450	0.206	45.0	3V1060	0.485	106.0
3V475	0.217	47.5	3V1120	0.513	112.0
3V500	0.229	50.0	3V1180	0.540	118.0
3V530	0.243	53.0	3V1250	0.572	125.0
3V560	0.256	56.0	3V1320	0.604	132.0
3V600	0.275	60.0	3V1400	0.641	140.0

### 5V Section

Part Number	Weight* (Lbs.)	Effective Outside Length (Inches)	Part Number	Weight* (Lbs.)	Effective Outside Length (Inches)
5V500	0.648	50	5V1400	1.816	140
5V530	0.687	53	5V1500	1.945	150
5V560	0.726	56	5V1600	2.075	160
5V600	0.778	60	5V1700	2.205	170
5V630	0.817	63	5V1800	2.334	180
5V670	0.869	67	5V1900	2.464	190
5V710	0.921	71	5V2000	2.594	200
5V750	0.973	75	5V2120	2.749	212
5V800	1.038	80	5V2240	2.905	224
5V850	1.102	85	5V2360	3.061	236
5V900	1.167	90	5V2500	3.242	250
5V950	1.232	95	5V2650	3.437	265
5V1000	1.297	100	5V2800	3.631	280
5V1060	1.375	106	5V3000	3.891	300
5V1120	1.453	112	5V3150	4.085	315
5V1180	1.530	118	5V3350	4.345	335
5V1250	1.621	125	5V3550	4.604	355
5V1320	1.712	132			

### 8V Section

Part Number	Weight* (Lbs.)	Effective Outside Length (Inches)	Part Number	Weight* (Lbs.)	Effective Outside Length (Inches)
8V1000	3.490	100	8V2360	8.237	236
8V1060	3.700	106	8V2500	8.726	250
8V1120	3.909	112	8V2650	9.250	265
8V1180	4.119	118	8V2800	9.773	280
8V1250	4.363	125	8V3000	10.471	300
8V1320	4.607	132	8V3150	10.995	315
8V1400	4.887	140	8V3350	11.693	335
8V1500	5.236	150	8V3550	12.391	355
8V1600	5.585	160	8V3750	13.089	375
8V1700	5.934	170	8V4000	13.962	400
8V1800	6.283	180	8V4250	14.834	425
8V1900	6.632	190	8V4500	15.707	450
8V2000	6.981	200	8V4750	16.579	475
8V2120	7.400	212	8V5000	17.452	500
8V2240	7.818	224	8V5600	19.546	560

\* Weights shown are approximate.



Nominal Dimensions

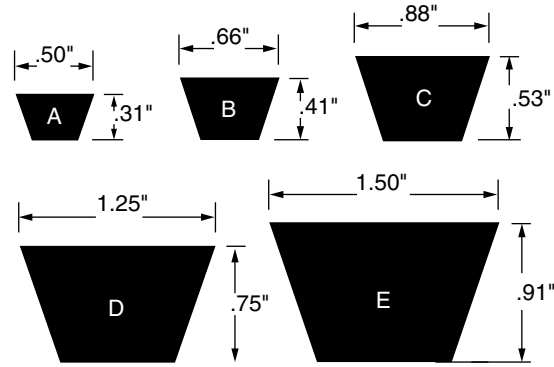

A Section

Part Number	Weight* (Lbs.)	Outside Length (Inches)	Datum Length (Inches)	Part Number	Weight* (Lbs.)	Outside Length (Inches)	Datum Length (Inches)
A18	0.120	20	19.3	A68	0.439	70	69.3
A19	0.123	21	20.3	A69	0.445	71	70.3
A20	0.129	22	21.3	A70	0.452	72	71.3
A21	0.135	23	22.3	A71	0.458	73	72.3
A22	0.142	24	23.3	A72	0.464	74	73.3
A23	0.148	25	24.3	A73	0.471	75	74.3
A24	0.155	26	25.3	A74	0.477	76	75.3
A25	0.161	27	26.3	A75	0.484	77	76.3
A26	0.168	28	27.3	A76	0.490	78	77.3
A27	0.174	29	28.3	A77	0.497	79	78.3
A28	0.181	30	29.3	A78	0.503	80	79.3
A29	0.187	31	30.3	A79	0.510	81	80.3
A30	0.194	32	31.3	A80	0.516	82	81.3
A31	0.200	33	32.3	A81	0.522	83	82.3
A32	0.206	34	33.3	A82	0.529	84	83.3
A33	0.213	35	34.3	A83	0.535	85	84.3
A34	0.219	36	35.3	A84	0.542	86	85.3
A35	0.226	37	36.3	A85	0.548	87	86.3
A36	0.232	38	37.3	A86	0.555	88	87.3
A37	0.239	39	38.3	A87	0.561	89	88.3
A38	0.245	40	39.3	A88	0.568	90	89.3
A39	0.252	41	40.3	A89	0.574	91	90.3
A40	0.258	42	41.3	A90	0.581	92	91.3
A41	0.264	43	42.3	A91	0.587	93	92.3
A42	0.271	44	43.3	A92	0.593	94	93.3
A43	0.277	45	44.3	A93	0.600	95	94.3
A44	0.284	46	45.3	A94	0.606	96	95.3
A45	0.290	47	46.3	A95	0.613	97	96.3
A46	0.297	48	47.3	A96	0.619	98	97.3
A47	0.303	49	48.3	A97	0.626	99	98.3
A48	0.310	50	49.3	A98	0.632	100	99.3
A49	0.316	51	50.3	A99	0.639	101	100.3
A50	0.323	52	51.3	A100	0.645	102	101.3
A51	0.329	53	52.3	A101	0.651	103	102.3
A52	0.335	54	53.3	A102	0.658	104	103.3
A53	0.342	55	54.3	A103	0.664	105	104.3
A54	0.348	56	55.3	A105	0.677	107	106.3
A55	0.355	57	56.3	A106	0.684	108	107.3
A56	0.361	58	57.3	A110	0.710	112	111.3
A57	0.368	59	58.3	A112	0.722	114	113.3
A58	0.374	60	59.3	A115	0.742	117	116.3
A59	0.381	61	60.3	A120	0.774	122	121.3
A60	0.387	62	61.3	A128	0.826	130	129.3
A61	0.393	63	62.3	A133	0.858	135	134.3
A62	0.400	64	63.3	A136	0.877	138	137.3
A63	0.406	65	64.3	A144	0.929	146	145.3
A64	0.413	66	65.3	A158	1.019	160	159.3
A65	0.419	67	66.3	A173	1.116	175	174.3
A66	0.426	68	67.3	A180	1.161	182	181.3
A67	0.432	69	68.3				

\* Weights shown are approximate.

For intermediate sizes not shown, consult BANDO for availability and price.

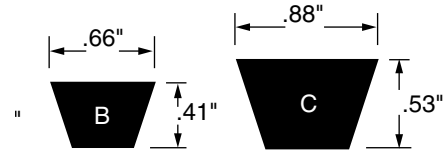

**B Section**

Part Number	Weight* (Lbs.)	Outside Length (Inches)	Datum Length (Inches)	Part Number	Weight* (Lbs.)	Outside Length (Inches)	Datum Length (Inches)
B25	0.263	28	26.8	B90	0.947	93	91.8
B26	0.274	29	27.8	B91	0.957	94	92.8
B27	0.284	30	28.8	B92	0.968	95	93.8
B28	0.295	31	29.8	B93	0.978	96	94.8
B29	0.305	32	30.8	B94	0.989	97	95.8
B30	0.316	33	31.8	B95	0.999	98	96.8
B31	0.326	34	32.8	B96	1.010	99	97.8
B32	0.337	35	33.8	B97	1.020	100	98.8
B33	0.347	36	34.8	B98	1.031	101	99.8
B34	0.358	37	35.8	B99	1.041	102	100.8
B35	0.368	38	36.8	B100	1.052	103	101.8
B36	0.379	39	37.8	B101	1.063	104	102.8
B37	0.389	40	38.8	B102	1.073	105	103.8
B38	0.400	41	39.8	B103	1.084	106	104.8
B39	0.410	42	40.8	B104	1.094	107	105.8
B40	0.421	43	41.8	B105	1.105	108	106.8
B41	0.431	44	42.8	B106	1.114	109	107.8
B42	0.442	45	43.8	B107	1.126	110	108.8
B43	0.452	46	44.8	B108	1.136	111	109.8
B44	0.463	47	45.8	B110	1.157	113	111.8
B45	0.473	48	46.8	B111	1.168	114	112.8
B46	0.484	49	47.8	B112	1.178	115	113.8
B47	0.494	50	48.8	B114	1.199	117	115.8
B48	0.505	51	49.8	B115	1.210	118	116.8
B49	0.515	52	50.8	B116	1.220	119	117.8
B50	0.526	53	51.8	B117	1.231	120	118.8
B51	0.537	54	52.8	B118	1.241	121	119.8
B52	0.547	55	53.8	B120	1.262	123	121.8
B53	0.558	56	54.8	B122	1.281	125	123.8
B54	0.568	57	55.8	B123	1.294	126	124.8
B55	0.579	58	56.8	B124	1.304	127	125.8
B56	0.589	59	57.8	B126	1.326	129	127.8
B57	0.600	60	58.8	B128	1.347	131	129.8
B58	0.610	61	59.8	B130	1.356	133	131.8
B59	0.621	62	60.8	B131	1.378	134	132.8
B60	0.631	63	61.8	B133	1.399	136	134.8
B61	0.642	64	62.8	B134	1.410	137	135.8
B62	0.652	65	63.8	B135	1.422	138	136.8
B63	0.663	66	64.8	B136	1.431	139	137.8
B64	0.673	67	65.8	B137	1.441	140	138.8
B65	0.684	68	66.8	B138	1.450	141	139.8
B66	0.694	69	67.8	B140	1.473	143	141.8
B67	0.705	70	68.8	B141	1.486	144	142.8
B68	0.715	71	69.8	B142	1.494	145	143.8
B69	0.726	72	70.8	B144	1.515	147	145.8
B70	0.736	73	71.8	B147	1.546	150	148.8
B71	0.747	74	72.8	B148	1.557	151	149.8
B72	0.757	75	73.8	B150	1.578	153	151.8
B73	0.768	76	74.8	B152	1.599	155	153.8
B74	0.778	77	75.8	B153	1.610	156	154.8
B75	0.791	78	76.8	B154	1.620	157	155.8
B76	0.800	79	77.8	B156	1.640	159	157.8
B77	0.810	80	78.8	B158	1.662	161	159.8
B78	0.821	81	79.8	B160	1.684	163	161.8
B79	0.831	82	80.8	B162	1.704	165	163.8
B80	0.842	83	81.8	B165	1.734	168	165.8
B81	0.852	84	82.8	B168	1.767	171	169.8
B82	0.863	85	83.8	B170	1.785	173	171.8
B83	0.873	86	84.8	B172	1.814	175	173.8
B84	0.884	87	85.8	B173	1.820	176	174.8
B85	0.894	88	86.8	B175	1.841	178	176.8
B86	0.905	89	87.8	B180	1.894	183	181.8
B87	0.915	90	88.8	B185	1.946	188	186.8
B88	0.926	91	89.8	B190	1.999	193	191.8
B89	0.936	92	90.8	B195	2.051	198	196.8

\* Weights shown are approximate.

For intermediate sizes not shown, consult BANDO for availability and price.

To find an authorized BANDO distributor, go to [www.bandousa.com](http://www.bandousa.com) or call 1-800-829-6612





## B Section (Continued)

Part Number	Weight* (Lbs.)	Outside Length (Inches)	Datum Length (Inches)	Part Number	Weight* (Lbs.)	Outside Length (Inches)	Datum Length (Inches)
B205	2.157	208	206.8	B290	3.050	291	290.3
B206	2.167	209	207.8	B292	3.072	293	292.3
B210	2.209	213	211.8	B293	3.082	294	293.3
B224	2.354	227	225.3	B300	3.156	301	300.3
B225	2.367	226	225.3	B315	3.314	316	315.3
B237	2.493	238	237.3	B330	3.348	331	330.3
B238	2.500	239	238.3	B345	3.621	346	345.3
B240	2.525	241	240.3	B360	3.811	361	360.3
B255	2.683	256	255.3	B433	4.423	434	433.3
B270	2.840	271	270.3	B472	4.970	473	472.3
B285	2.998	286	285.3				

## C Section

Part Number	Weight* (Lbs.)	Outside Length (Inches)	Datum Length (Inches)	Part Number	Weight* (Lbs.)	Outside Length (Inches)	Datum Length (Inches)
C38	0.683	42	40.9	C117	2.102	121	119.9
C42	0.754	46	44.9	C118	2.120	122	120.9
C50	0.818	54	52.9	C120	2.156	124	122.9
C51	0.916	55	53.9	C122	2.172	126	124.9
C53	0.952	57	55.9	C124	2.228	128	126.9
C54	0.961	58	56.9	C125	2.246	129	127.9
C55	0.988	59	57.9	C126	2.257	130	128.9
C56	0.994	60	58.9	C128	2.300	132	130.9
C57	1.015	61	59.9	C130	2.340	134	132.9
C58	1.052	62	60.9	C131	2.354	135	133.9
C59	1.068	63	61.9	C132	2.372	136	134.9
C60	1.078	64	62.9	C135	2.426	139	137.9
C62	1.114	66	64.9	C136	2.444	140	138.9
C64	1.150	68	66.9	C140	2.516	144	142.9
C65	1.168	69	67.9	C141	2.534	145	143.9
C68	1.222	72	70.9	C144	2.588	148	146.9
C70	1.258	74	72.9	C147	2.640	151	149.9
C71	1.276	75	73.9	C148	2.660	152	150.9
C72	1.294	76	74.9	C150	2.696	154	152.9
C73	1.312	77	75.9	C151	2.710	155	153.9
C75	1.348	79	77.9	C152	2.731	156	154.9
C76	1.366	80	78.9	C156	2.803	160	158.9
C78	1.402	82	80.9	C158	2.839	162	160.9
C79	1.430	83	81.9	C160	2.852	164	162.9
C80	1.453	84	82.9	C161	2.861	165	163.9
C81	1.456	85	83.9	C162	2.911	166	164.9
C82	1.474	86	84.9	C169	3.040	173	171.9
C83	1.492	87	85.9	C170	3.060	174	172.9
C84	1.510	88	86.9	C173	3.109	177	175.9
C85	1.527	89	87.9	C175	3.145	179	177.9
C86	1.545	90	88.9	C177	3.181	181	179.9
C87	1.558	91	89.9	C180	3.235	184	182.9
C89	1.602	93	91.9	C185	3.324	189	187.9
C90	1.617	94	92.9	C186	3.338	190	188.9
C91	1.621	95	93.9	C187	3.351	191	189.9
C93	1.671	97	95.9	C190	3.414	194	192.9
C94	1.693	98	96.9	C195	3.504	199	197.9
C95	1.709	99	97.9	C206	3.702	210	208.9
C96	1.725	100	98.9	C208	3.726	212	210.9
C97	1.743	101	99.9	C210	3.774	214	212.9
C98	1.761	102	100.9	C220	3.950	224	222.9
C99	1.779	103	101.9	C225	4.043	227	225.9
C100	1.797	104	102.9	C240	4.312	242	240.9
C103	1.851	107	105.9	C255	4.581	257	255.9
C104	1.869	108	106.9	C270	4.852	272	270.9
C105	1.887	109	107.9	C285	5.121	287	285.9
C106	1.905	110	108.9	C300	5.391	302	300.9
C107	1.923	111	109.9	C315	5.661	317	315.9
C108	1.941	112	110.9	C330	5.930	332	330.9
C109	1.959	113	111.9	C345	6.200	347	345.9
C110	1.977	114	112.9	C360	6.469	362	360.9
C111	1.995	115	113.9	C390	7.008	392	390.9
C112	2.013	116	114.9	C420	7.547	422	420.9
C115	2.067	119	117.9	C450	8.087	452	450.9
C116	2.077	120	118.9	C480	8.626	482	480.9

\* Weights shown are approximate.

For intermediate sizes not shown, consult BANDO for availability and price.



### Nominal Dimensions

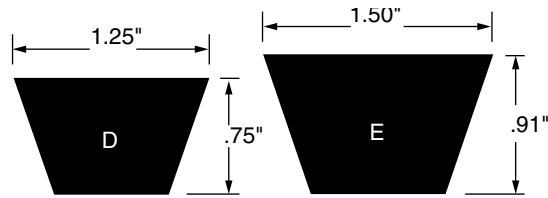

### D Section

Part Number	Weight* (Lbs.)	Outside Length (Inches)	Datum Length (Inches)	Part Number	Weight* (Lbs.)	Outside Length (Inches)	Datum Length (Inches)
D105	3.927	110	108.3	D255	9.537	257	255.8
D120	4.488	125	123.3	D270	10.098	272	270.8
D128	4.787	133	131.3	D285	10.659	287	285.8
D144	5.386	149	147.3	D300	11.220	302	300.8
D152	5.684	157	155.3	D315	11.781	317	315.8
D158	5.909	163	161.3	D330	12.342	332	330.8
D160	5.951	165	163.3	D345	12.903	347	345.8
D162	6.059	167	165.3	D360	13.464	362	360.8
D171	6.395	176	174.3	D390	14.586	392	390.8
D173	6.470	178	176.3	D420	15.708	422	420.8
D180	6.732	185	183.3	D450	16.830	452	450.8
D195	7.293	200	198.3	D480	17.952	482	480.8
D210	7.854	215	213.3	D540	20.196	542	540.8
D225	8.415	227	225.8	D600	22.440	602	600.8
D240	8.976	242	240.8				

### E Section

Part Number	Weight* (Lbs.)	Outside Length (Inches)	Datum Length (Inches)	Part Number	Weight* (Lbs.)	Outside Length (Inches)	Datum Length (Inches)
E180	10.642	187	184.5	E360	21.283	363	361.0
E195	11.528	202	199.5	E390	23.057	393	391.0
E210	12.415	217	214.5	E420	24.830	423	421.0
E240	14.189	243	241.0	E470	27.786	473	471.0
E270	15.962	273	271.0	E480	28.378	483	481.0
E300	17.736	303	301.0	E540	31.925	543	541.0
E330	19.510	333	331.0	E600	35.472	603	601.0
E350	20.692	353	351.0				

\* Weights shown are approximate.

For intermediate sizes not shown, consult BANDO for availability and price.



BAN/SET®

Nominal Dimensions

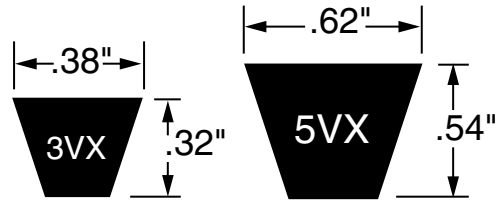

3VX Section

Part Number	Weight* (Lbs.)	Effective Outside Length (Inches)	Part Number	Weight* (Lbs.)	Effective Outside Length (Inches)
3VX235	0.097	23.5	3VX600	0.252	60.0
3VX250	0.105	25.0	3VX630	0.265	63.0
3VX265	0.111	26.5	3VX670	0.281	67.0
3VX280	0.118	28.0	3VX710	0.298	71.0
3VX300	0.126	30.0	3VX750	0.315	75.0
3VX315	0.132	31.5	3VX800	0.336	80.0
3VX335	0.141	33.5	3VX830	0.342	83.0
3VX355	0.149	35.5	3VX850	0.357	85.0
3VX360	0.151	36.0	3VX900	0.378	90.0
3VX375	0.158	37.5	3VX950	0.399	95.0
3VX400	0.168	40.0	3VX1000	0.420	100.0
3VX425	0.179	42.5	3VX1060	0.445	106.0
3VX450	0.189	45.0	3VX1120	0.470	112.0
3VX475	0.200	47.5	3VX1180	0.496	118.0
3VX500	0.210	50.0	3VX1250	0.525	125.0
3VX530	0.223	53.0	3VX1320	0.554	132.0
3VX560	0.235	56.0	3VX1400	0.588	140.0

5VX Section

Part Number	Weight* (Lbs.)	Effective Outside Length (Inches)	Part Number	Weight* (Lbs.)	Effective Outside Length (Inches)
5VX450	0.450	45.0	5VX830	0.839	83.0
5VX490	0.497	49.0	5VX840	0.850	84.0
5VX500	0.506	50.0	5VX850	0.860	85.0
5VX510	0.517	51.0	5VX860	0.870	86.0
5VX530	0.536	53.0	5VX880	0.890	88.0
5VX540	0.547	54.0	5VX900	0.911	90.0
5VX550	0.557	55.0	5VX930	0.940	93.0
5VX560	0.567	56.0	5VX950	0.961	95.0
5VX570	0.577	57.0	5VX960	0.972	96.0
5VX580	0.587	58.0	5VX1000	1.012	100.0
5VX590	0.597	59.0	5VX1030	1.042	103.0
5VX600	0.607	60.0	5VX1060	1.072	106.0
5VX610	0.617	61.0	5VX1080	1.093	108.0
5VX630	0.637	63.0	5VX1120	1.133	112.0
5VX650	0.657	65.0	5VX1150	1.164	115.0
5VX660	0.668	66.0	5VX1180	1.194	118.0
5VX670	0.678	67.0	5VX1230	1.224	123.0
5VX680	0.693	68.0	5VX1250	1.265	125.0
5VX690	0.698	69.0	5VX1320	1.335	132.0
5VX710	0.718	71.0	5VX1400	1.416	140.0
5VX730	0.738	73.0	5VX1500	1.518	150.0
5VX740	0.748	74.0	5VX1600	1.619	160.0
5VX750	0.759	75.0	5VX1700	1.720	170.0
5VX780	0.785	78.0	5VX1800	1.821	180.0
5VX800	0.809	80.0	5VX1900	1.922	190.0
5VX810	0.818	81.0	5VX2000	2.023	200.0

\* Weights shown are approximate.

For intermediate sizes not shown, consult BANDO for availability and price.



**Nominal Dimensions**

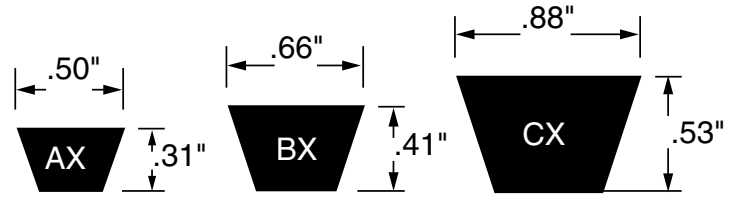

**AX Section**

Part Number	Weight* (Lbs.)	Outside Length (Inches)	Datum Length (Inches)	Part Number	Weight* (Lbs.)	Outside Length (Inches)	Datum Length (Inches)
AX19	0.112	21	20.3	AX61	0.360	63	62.3
AX20	0.118	22	21.3	AX62	0.370	64	63.3
AX21	0.123	23	22.3	AX63	0.372	65	64.3
AX22	0.129	24	23.3	AX64	0.382	66	65.3
AX23	0.136	25	24.3	AX65	0.384	67	66.3
AX24	0.143	26	25.3	AX66	0.394	68	67.3
AX25	0.148	27	26.3	AX67	0.397	69	68.3
AX26	0.155	28	27.3	AX68	0.406	70	69.3
AX27	0.159	29	28.3	AX69	0.408	71	70.3
AX28	0.167	30	29.3	AX70	0.418	72	71.3
AX29	0.173	31	30.3	AX71	0.424	73	72.3
AX30	0.177	32	31.3	AX72	0.425	74	73.3
AX31	0.185	33	32.3	AX73	0.436	75	74.3
AX32	0.189	34	33.3	AX75	0.447	77	76.3
AX33	0.197	35	34.3	AX77	0.454	79	78.3
AX34	0.203	36	35.3	AX78	0.465	80	79.3
AX35	0.209	37	36.3	AX79	0.466	81	80.3
AX36	0.215	38	37.3	AX80	0.477	82	81.3
AX37	0.221	39	38.3	AX82	0.484	84	83.3
AX38	0.227	40	39.3	AX83	0.490	85	84.3
AX39	0.233	41	40.3	AX85	0.507	87	86.3
AX40	0.239	42	41.3	AX86	0.510	88	87.3
AX41	0.242	43	42.3	AX87	0.514	89	88.3
AX42	0.251	44	43.3	AX88	0.519	90	89.3
AX43	0.257	45	44.3	AX90	0.537	92	91.3
AX44	0.262	46	45.3	AX92	0.549	94	93.3
AX45	0.268	47	46.3	AX94	0.555	96	95.3
AX46	0.274	48	47.3	AX95	0.561	97	96.3
AX47	0.277	49	48.3	AX96	0.573	98	97.3
AX48	0.286	50	49.3	AX98	0.578	100	99.3
AX49	0.289	51	50.3	AX100	0.582	102	101.3
AX50	0.295	52	51.3	AX105	0.626	107	106.3
AX51	0.304	53	52.3	AX110	0.656	112	111.3
AX52	0.311	54	53.3	AX112	0.668	114	113.3
AX53	0.316	55	54.3	AX120	0.716	122	121.3
AX54	0.322	56	55.3	AX128	0.764	130	129.3
AX55	0.328	57	56.3	AX136	0.811	138	137.3
AX56	0.334	58	57.3	AX144	0.859	146	145.3
AX57	0.336	59	58.3	AX158	0.943	160	159.3
AX58	0.342	60	59.3	AX173	1.032	175	174.3
AX59	0.348	61	60.3	AX180	1.074	182	181.3
AX60	0.358	62	61.3				

\* Weights shown are approximate.

For intermediate sizes not shown, consult BANDO for availability and price.



## BX Section

Part Number	Weight* (Lbs.)	Outside Length (Inches)	Datum Length (Inches)	Part Number	Weight* (Lbs.)	Outside Length (Inches)	Datum Length (Inches)
BX31	0.324	34	32.8	BX79	0.808	82	80.8
BX32	0.335	35	33.8	BX80	0.819	83	81.8
BX34	0.348	37	35.8	BX81	0.829	84	82.8
BX35	0.358	38	36.8	BX82	0.839	85	83.8
BX36	0.368	39	37.8	BX83	0.849	86	84.8
BX37	0.379	40	38.8	BX84	0.857	87	85.8
BX38	0.389	41	39.8	BX85	0.870	88	86.8
BX40	0.409	43	41.8	BX86	0.878	89	87.8
BX41	0.420	44	42.8	BX87	0.887	90	88.8
BX42	0.430	45	43.8	BX89	0.900	92	90.8
BX43	0.435	46	44.8	BX90	0.921	93	91.8
BX44	0.440	47	45.8	BX91	0.925	94	92.8
BX45	0.452	48	46.8	BX92	0.931	95	93.8
BX46	0.471	49	47.8	BX93	0.952	96	94.8
BX47	0.485	50	48.8	BX94	0.961	97	95.8
BX48	0.491	51	49.8	BX95	0.972	98	96.8
BX49	0.502	52	50.8	BX96	0.982	99	97.8
BX50	0.512	53	51.8	BX97	0.993	100	98.8
BX51	0.522	54	52.8	BX99	1.013	102	100.8
BX52	0.532	55	53.8	BX100	1.023	103	101.8
BX53	0.542	56	54.8	BX103	1.054	106	104.8
BX54	0.553	57	55.8	BX105	1.075	108	106.8
BX55	0.563	58	56.8	BX106	1.081	109	107.8
BX56	0.573	59	57.8	BX108	1.105	111	109.8
BX57	0.583	60	58.8	BX112	1.146	115	113.8
BX58	0.594	61	59.8	BX113	1.156	116	114.8
BX59	0.604	62	60.8	BX115	1.177	118	116.8
BX60	0.614	63	61.8	BX116	1.187	119	117.8
BX61	0.624	64	62.8	BX120	1.228	123	121.8
BX62	0.634	65	63.8	BX124	1.269	127	125.8
BX63	0.645	66	64.8	BX126	1.285	129	127.8
BX64	0.655	67	65.8	BX128	1.310	131	129.8
BX65	0.665	68	66.8	BX133	1.361	136	134.8
BX66	0.675	69	67.8	BX136	1.392	139	137.8
BX67	0.686	70	68.8	BX144	1.474	147	145.8
BX68	0.696	71	69.8	BX150	1.530	153	151.8
BX70	0.716	73	71.8	BX158	1.617	161	159.8
BX71	0.727	74	72.8	BX162	1.658	165	163.8
BX72	0.734	75	73.8	BX173	1.770	176	174.8
BX73	0.745	76	74.8	BX180	1.842	183	181.8
BX74	0.755	77	75.8	BX195	1.996	198	196.8
BX75	0.768	78	76.8	BX210	2.149	213	211.8
BX76	0.776	79	77.8	BX225	2.303	226	225.3
BX77	0.788	80	78.8	BX240	2.456	241	240.3
BX78	0.798	81	79.8				

## CX Section

Part Number	Weight* (Lbs.)	Outside Length (Inches)	Datum Length (Inches)	Part Number	Weight* (Lbs.)	Outside Length (Inches)	Datum Length (Inches)
CX51	0.847	55	53.9	CX123	2.043	127	125.9
CX55	0.914	59	57.9	CX128	2.126	132	130.9
CX60	0.997	64	62.9	CX133	2.209	137	135.9
CX68	1.129	72	70.9	CX136	2.259	140	138.9
CX70	1.148	74	72.9	CX144	2.392	148	146.9
CX75	1.246	79	77.9	CX150	2.492	154	152.9
CX81	1.345	85	83.9	CX158	2.624	162	160.9
CX85	1.412	89	87.9	CX162	2.691	166	164.9
CX90	1.495	94	92.9	CX173	2.874	177	175.9
CX96	1.595	100	98.9	CX180	2.990	184	182.9
CX101	1.678	105	103.9	CX187	3.106	191	189.9
CX105	1.744	109	107.9	CX190	3.156	194	192.9
CX109	1.811	113	111.9	CX195	3.239	199	197.9
CX111	1.844	115	113.9	CX210	3.488	214	212.9
CX112	1.860	116	114.9	CX225	3.737	227	225.9
CX115	1.910	119	117.9	CX240	3.986	242	240.9
CX120	1.993	124	122.9				

\* Weights shown are approximate.

For intermediate sizes not shown, consult BANDO for availability and price.



**BAN/SET**®

**Nominal Dimensions**

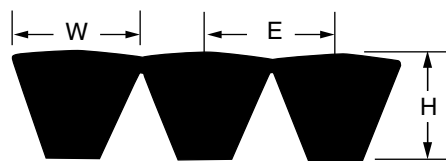

Belt Section	Top Width W (Inches)	Thickness H (Inches)	Pitch Between Belts E (Inches)
3V	.38	.39	.41
5V	.62	.63	.69
8V	1.00	.98	1.13

**Part Number Example**

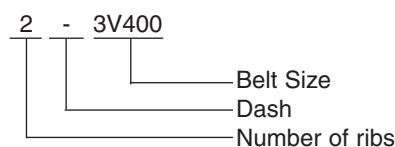

For example, a 2 rib 3V400 belt is part number 2-3V400. Use dash between ribs and belt size. No spaces.

**3V Section**

Belt Size	Weight Rib* (Lbs.)	Nominal Outside Length (Inches)
3V400	0.250	40.63
3V425	0.270	43.13
3V450	0.280	45.63
3V475	0.300	48.13
3V500	0.310	50.63
3V530	0.330	53.63
3V560	0.350	56.63
3V600	0.380	60.63
3V630	0.400	63.63
3V670	0.420	67.63
3V710	0.450	71.63
3V750	0.470	75.63
3V800	0.500	80.63
3V850	0.530	85.63
3V900	0.560	90.63
3V950	0.600	95.63
3V1000	0.630	100.63
3V1060	0.660	106.63
3V1120	0.700	112.63
3V1180	0.740	118.63
3V1250	0.780	125.63
3V1320	0.830	132.63
3V1400	0.880	140.63

\* Weights shown are approximate.

For intermediate sizes not shown, consult BANDO for availability and price.

Note: Refer to page 29 for details on BANDO's Power Ace® Combo Mandrel Program.

**Minimum Recommended Sheave Diameters**

Using sheave diameters less than the recommended minimum can substantially reduce belt life and drive efficiency. Dimensions shown are datum diameters in inches.

Belt Cross Section	A	AX	B	BX	C	CX	D	3V	3VX	5V	5VX	8V
Minimum Diameter (Inches)	3.0	2.2	5.4	4.0	9.0	6.8	13.0	2.65	2.20	7.10	4.40	12.50





**5V Section** See page 25 for part numbering example.

Belt Size	Weight Rib* (Lbs.)	Nominal Outside Length (Inches)
5V500	0.800	50.75
5V530	0.840	53.75
5V560	0.890	56.75
5V600	0.950	60.75
5V630	1.000	63.75
5V670	1.070	67.75
5V710	1.130	71.75
5V750	1.190	75.75
5V800	1.270	80.75
5V850	1.350	85.75
5V900	1.430	90.75
5V950	1.510	95.75
5V1000	1.590	100.75
5V1060	1.690	106.75
5V1120	1.780	112.75
5V1180	1.880	118.75
5V1250	1.990	125.75
5V1320	2.100	132.75
5V1400	2.230	140.75
5V1500	2.390	150.75
5V1600	2.540	160.75
5V1700	2.700	170.75
5V1800	2.860	180.75
5V1900	3.020	190.75
5V2000	3.180	200.75
5V2120	3.370	212.75
5V2240	3.560	224.75
5V2360	3.750	236.75
5V2500	3.980	250.75
5V2650	4.210	265.75
5V2800	4.450	280.75
5V3000	4.770	300.75
5V3150	5.010	315.75
5V3350	5.330	335.75
5V3550	5.640	355.75

**8V Section**

Belt Size	Weight Rib* (Lbs.)	Nominal Outside Length (Inches)
8V1000	3.990	101.00
8V1060	4.220	107.00
8V1120	4.460	113.00
8V1180	4.700	119.00
8V1250	4.980	126.00
8V1320	5.260	133.00
8V1400	5.580	141.00
8V1500	5.980	151.00
8V1600	6.380	161.00
8V1700	6.770	171.00
8V1800	7.170	181.00
8V1900	7.570	191.00
8V2000	7.970	201.00
8V2120	8.450	213.00
8V2240	8.920	225.00
8V2360	9.400	237.00
8V2500	9.960	251.00
8V2650	10.560	266.00
8V2800	11.150	281.00
8V3000	11.950	301.00
8V3150	12.550	316.00
8V3350	13.350	336.00
8V3550	14.140	356.00
8V3750	14.940	376.00
8V4000	15.930	401.00
8V4250	16.930	426.00
8V4500	17.930	451.00
8V4750	18.920	476.00
8V5000	19.920	501.00
8V5600	22.310	561.00
8V6000	23.900	601.00

\* Weights shown are approximate.

For intermediate sizes not shown, consult BANDO for availability and price.



**BAN/SET**®

**Nominal Dimensions**

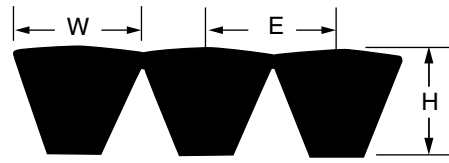

Belt Section	Top Width W (Inches)	Thickness H (Inches)	Pitch Between Belts E (Inches)
B	.66	.51	.75
C	.88	.63	1.00
D	1.25	.85	1.46

**Part Number Example**

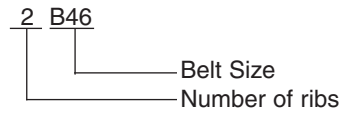

For example, a 2 rib B46 belt is part number 2B46. No spaces in part number.

**B Section**

Belt Size	Weight Rib* (Lbs.)	Outside Length (Inches)	Datum Length (Inches)
B46	0.790	49.75	47.8
B48	0.820	51.75	49.8
B50	0.850	53.75	51.8
B51	0.870	54.75	52.8
B52	0.890	55.75	53.8
B53	0.900	56.75	54.8
B54	0.920	57.75	55.8
B55	0.940	58.75	56.8
B56	0.960	59.75	57.8
B57	0.970	60.75	58.8
B58	0.990	61.75	59.8
B59	1.010	62.75	60.8
B60	1.020	63.75	61.8
B61	1.040	64.75	62.8
B62	1.060	65.75	63.8
B63	1.070	66.75	64.8
B64	1.090	67.75	65.8
B65	1.110	68.75	66.8
B66	1.130	69.75	67.8
B67	1.140	70.75	68.8
B68	1.160	71.75	69.8
B70	1.190	73.75	71.8
B71	1.210	74.75	72.8
B72	1.230	75.75	73.8
B73	1.240	76.75	74.8
B74	1.260	77.75	75.8
B75	1.280	78.75	76.8
B77	1.310	80.75	78.8
B78	1.330	81.75	79.8
B79	1.350	82.75	80.8
B80	1.360	83.75	81.8
B81	1.380	84.75	82.8
B82	1.400	85.75	83.8
B83	1.420	86.75	84.8
B85	1.450	88.75	86.8
B87	1.480	90.75	88.8
B90	1.530	93.75	91.8
B93	1.590	96.75	94.8
B95	1.620	98.75	96.8
B96	1.640	99.75	97.8
B97	1.650	100.75	98.8
B99	1.690	102.75	100.8
B100	1.700	103.75	101.8
B103	1.760	106.75	104.8
B105	1.790	108.75	106.8
B108	1.840	111.75	109.8
B112	1.910	115.75	113.8
B116	2.000	119.75	117.8

\* Weights shown are approximate.

For intermediate sizes not shown, consult BANDO for availability and price.

To find an authorized BANDO distributor, go to [www.bandousa.com](http://www.bandousa.com) or call 1-800-829-6612



**B Section (Continued)**

Belt Size	Weight Rib* (Lbs.)	Outside Length (Inches)	Datum Length (Inches)
B120	2.040	123.75	121.8
B124	2.110	127.75	125.8
B126	2.140	129.75	127.8
B128	2.180	131.75	129.8
B133	2.270	136.75	134.8
B136	2.320	139.75	137.8
B144	2.450	147.75	145.8
B148	2.520	151.75	149.8
B150	2.560	153.75	151.8
B157	2.690	160.75	158.8
B158	2.700	161.75	159.8
B162	2.760	165.75	163.8
B173	2.950	176.75	174.8
B180	3.070	183.75	181.8
B195	3.320	198.75	196.8
B210	3.580	213.75	211.8
B225	3.830	226.75	225.3
B240	4.090	241.75	240.3



BAN/SET®

**Nominal Dimensions**

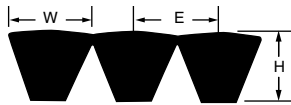

Belt Section	Top Width W (Inches)	Thickness H (Inches)	Pitch Between Belts E (Inches)
B	.66	.51	.75
C	.88	.63	1.00
D	1.25	.85	1.46

**Part Number Example**

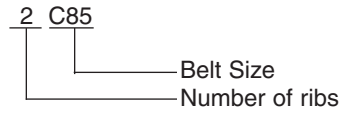

For example, a 2 rib C85 belt is part number 2C85. No spaces in part number.

**C Section**

Belt Size	Weight Rib* (Lbs.)	Outside Length (Inches)	Datum Length (Inches)
C85	2.410	89.88	87.9
C90	2.550	94.88	92.9
C96	2.720	100.88	98.9
C100	2.830	104.88	102.9
C105	2.970	109.88	107.9
C108	3.050	112.88	110.9
C109	3.080	113.88	111.9
C112	3.160	116.88	114.9
C120	3.390	124.88	122.9
C123	3.470	127.88	125.9
C124	3.500	128.88	126.9
C126	3.560	130.88	128.9
C128	3.620	132.88	130.9
C136	3.840	140.88	138.9
C144	4.070	148.88	146.9
C158	4.460	162.88	160.9
C162	4.580	166.88	164.9
C173	4.890	177.88	175.9
C180	5.080	184.88	182.9
C195	5.510	199.88	197.9
C210	5.930	214.88	212.9
C225	6.350	227.88	225.9
C230	6.490	232.88	230.9
C240	6.780	242.88	240.9
C255	7.200	257.88	255.9
C270	7.620	272.88	270.9
C285	8.050	287.88	285.9
C300	8.470	302.88	300.9
C315	8.890	317.88	315.9
C330	9.320	332.88	330.9
C345	9.740	347.88	345.9
C360	10.170	362.88	360.9
C375	10.590	377.88	375.9
C390	11.010	392.88	390.9
C420	11.860	422.88	420.9

\* Weights shown are approximate.

For intermediate sizes not shown, consult BANDO for availability and price.



### Nominal Dimensions



Belt Section	Top Width W (Inches)	Thickness H (Inches)	Pitch Between Belts E (Inches)
B	.66	.51	.75
C	.88	.63	1.00
D	1.25	.85	1.46

### Part Number Example

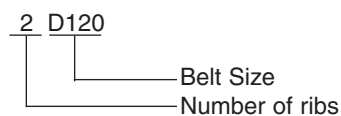

For example, a 2 rib D120 belt is part number 2D120.

No spaces in part number.

### D Section

Belt Size	Weight Rib* (Lbs.)	Outside Length (Inches)	Datum Length (Inches)
D120	6.280	126.13	123.3
D128	6.700	134.13	131.3
D144	7.530	150.13	147.3
D158	8.260	164.13	161.3
D162	8.470	168.13	165.3
D173	9.050	179.13	176.3
D180	9.410	186.13	183.3
D195	10.200	201.13	198.3
D210	10.980	216.13	213.3
D225	11.770	228.13	225.8
D240	12.550	243.13	240.8
D255	13.340	258.13	255.8
D270	14.120	273.13	270.8
D285	14.910	288.13	285.8
D300	15.690	303.13	300.8
D315	16.470	318.13	315.8
D330	17.260	333.13	330.8
D345	18.040	348.13	345.8
D360	18.830	363.13	360.8
D390	20.400	393.13	390.8
D420	21.960	423.13	420.8
D450	23.530	453.13	450.8
D480	25.100	483.13	480.8
D540	28.240	543.13	540.8
D600	31.380	603.13	600.8

\* Weights shown are approximate.

For intermediate sizes not shown, consult BANDO for availability and price.

## Power King® & Power Ace® Combo Mandrel Program

For those customers who prefer to inventory Power King® and Power Ace® combos in full width mandrels rather than individually cut sizes, BANDO stocks mandrel widths in the following configurations:

Belt Section	Length Range (Inches)	No. of Ribs/Mandrel
B	46 - 100	15
	101 - 240	21
C	85 - 420	15
D	120 - 600	11
3V	40 - 75	25
	76 - 140	40
5V	50 - 75	15
	76 - 355	23
8V	100 - —	10
	106 - 600	14
8VK	125 - 560	10

Consult BANDO for availability, price and detailed cutting instructions.



BAN/SET®

Belts are constructed with high modulus aramid cords to maintain length stability and to withstand severe shock loads, making them ideally suited for the oil, gas and aggregate industries.

**Nominal Dimensions**

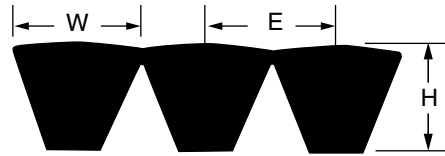

Belt Section	Top Width W (Inches)	Thickness H (Inches)	Pitch Between Belts E (Inches)
8V	1.00	.98	1.13

**Part Number Example**

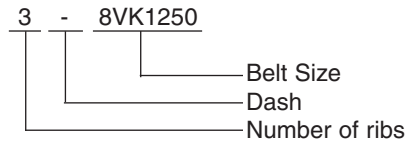

For example, a 3 rib 8VK1250 belt is part number 3-8VK1250. Use dash between ribs and belt size. No spaces.

**8V Section Kevlar®**

Belt Size	Weight Rib * (Lbs.)	Nominal Outside Length (Inches)
8VK1250	4.98	126
8VK1320	5.26	133
8VK1400	5.58	141
8VK1500	5.98	151
8VK1600	6.38	161
8VK1700	6.77	171
8VK1800	7.20	181
8VK1900	7.60	191
8VK2000	8.00	201
8VK2120	8.60	213
8VK2240	9.00	225
8VK2360	9.40	237
8VK2500	10.00	251
8VK2650	10.60	266
8VK2800	11.40	281
8VK3000	12.20	301
8VK3150	13.00	316
8VK3350	13.60	336
8VK3550	14.00	356
8VK3750	15.20	376
8VK4000	16.20	401
8VK4250	17.20	426
8VK4500	18.20	451
8VK4750	19.20	476
8VK5000	20.20	501
8VK5600	22.80	561

\* Weights shown are approximate.

10 ribs width for 8VK.

Kevlar is a registered trademark of the DuPont Corporation.

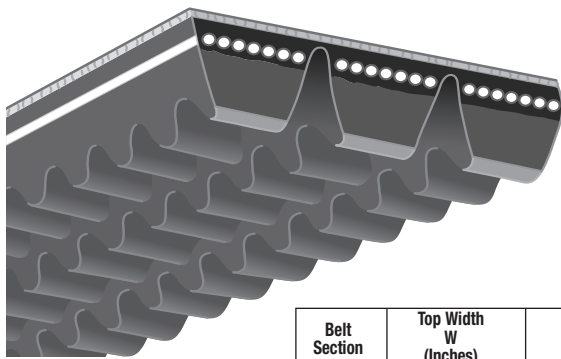

Belt Section	Top Width W (Inches)	Thickness H (Inches)
3VX	.38	.410
5VX	.62	.575

### 3VX Section

Belt Size	Weight Rib* (Lbs.)	Nominal Outside Length (Inches)
3VX250	0.105	25.35
3VX265	0.111	26.85
3VX280	0.118	28.35
3VX300	0.126	30.35
3VX315	0.135	31.85
3VX335	0.141	33.85
3VX355	0.149	35.85
3VX375	0.158	37.85
3VX400	0.168	40.35
3VX425	0.179	42.85
3VX450	0.189	45.35
3VX475	0.200	47.85
3VX500	0.210	50.35
3VX530	0.223	53.35
3VX560	0.235	56.35
3VX600	0.252	60.35
3VX630	0.265	63.35
3VX670	0.281	67.35
3VX710	0.298	71.35
3VX750	0.315	75.35
3VX800	0.336	80.35
3VX850	0.357	85.35
3VX900	0.378	90.35
3VX950	0.399	95.35
3VX1000	0.420	100.35
3VX1060	0.445	106.35
3VX1120	0.470	112.35
3VX1180	0.496	118.35

### 5VX Section

Belt Size	Weight Rib* (Lbs.)	Nominal Outside Length (Inches)
5VX530	0.536	53.50
5VX560	0.567	56.50
5VX600	0.607	60.50
5VX630	0.637	63.50
5VX670	0.678	67.50
5VX710	0.718	71.50
5VX750	0.759	75.50
5VX800	0.809	80.50
5VX850	0.860	85.50
5VX900	0.911	90.50
5VX950	0.961	95.50
5VX1000	1.012	100.50
5VX1060	1.072	106.50
5VX1120	1.133	112.50
5VX1180	1.194	118.50

\* Weights shown are approximate.

For intermediate sizes not shown, consult BANDO for availability and price.

To find an authorized BANDO distributor, go to [www.bandousa.com](http://www.bandousa.com) or call 1-800-829-6612

### Nominal Dimensions

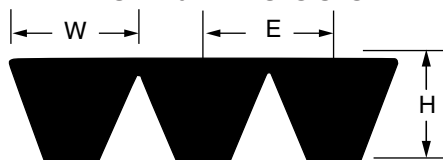

### Part Number Example

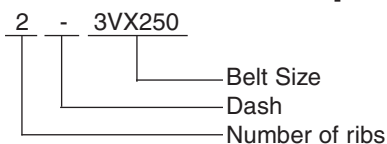

For example, a 2 rib 3VX250 belt is part number 2-3VX250. Use dash between ribs and belt size. No spaces.





Nominal Dimensions

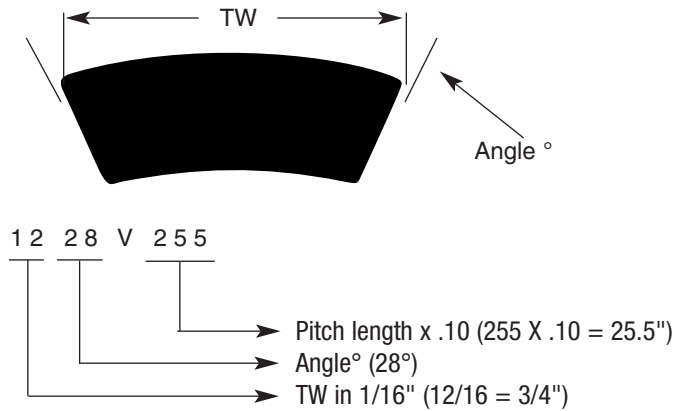

Part Number	Weight* (Lbs.)	Top Width (Inches)	Angle (°)	Outside Circ. (Inches)	Part Number	Weight* (Lbs.)	Top Width (Inches)	Angle (°)	Outside Circ. (Inches)
1228V255	0.4	3/4	28	26.0	1626V380	0.6	1	26	38.5
1230V348	0.4	3/4	30	35.3	1626V384	0.6	1	26	38.9
1330V242	0.4	13/16	30	24.7	1626V395	0.6	1	26	40.0
1422V235	0.3	7/8	22	24.0	1626V411	0.7	1	26	41.6
1422V240	0.3	7/8	22	24.5	1626V428	0.7	1	26	43.3
1422V270	0.3	7/8	22	27.5	1626V440	0.8	1	26	44.5
1422V290	0.4	7/8	22	29.5	1626V455	0.8	1	26	46.0
1422V300	0.4	7/8	22	30.5	1626V517	0.9	1	26	52.2
1422V330	0.4	7/8	22	33.5	1626V604	1.1	1	26	60.9
1422V340	0.5	7/8	22	34.5	1626V700	1.3	1	26	70.5
1422V360	0.5	7/8	22	36.5	1628V210	0.4	1	28	21.5
1422V400	0.5	7/8	22	40.5	1628V315	0.6	1	28	32.0
1422V420	0.5	7/8	22	42.5	1632V210	0.4	1	32	21.5
1422V440	0.5	7/8	22	44.5	1822V290	0.6	1-1/8	22	29.7
1422V460	0.6	7/8	22	46.5	1822V328	0.7	1-1/8	22	33.5
1422V480	0.6	7/8	22	48.5	1826V250	0.4	1-1/8	26	25.6
1422V540	0.7	7/8	22	54.5	1828V368	0.8	1-1/8	28	37.4
1422V600	0.8	7/8	22	60.5	1832V338	0.7	1-1/8	32	34.5
1422V780	1.0	7/8	22	78.5	1922V256	0.5	1-3/16	22	26.2
1426V298	0.4	7/8	26	30.3	1922V277	0.5	1-3/16	22	28.4
1426V328	0.5	7/8	26	33.3	1922V298	0.7	1-3/16	22	30.4
1426V362	0.6	7/8	26	36.7	1922V302	0.7	1-3/16	22	30.8
1430V215	0.4	7/8	30	22.0	1922V321	0.8	1-3/16	22	32.7
1430V315	0.5	7/8	30	32.0	1922V332	0.8	1-3/16	22	33.8
1430V375	0.5	7/8	30	38.0	1922V338	0.9	1-3/16	22	34.4
1430V450	0.6	7/8	30	45.5	1922V363	0.9	1-3/16	22	36.9
1430V500	0.7	7/8	30	50.5	1922V386	0.9	1-3/16	22	39.2
1524V301	0.5	15/16	24	30.6	1922V390	0.9	1-3/16	22	39.6
1526V264	0.5	15/16	26	26.9	1922V403	0.9	1-3/16	22	40.9
1526V294	0.5	15/16	26	29.9	1922V417	0.9	1-3/16	22	42.3
1528V298	0.4	15/16	28	30.3	1922V426	1.0	1-3/16	22	43.2
1528V326	0.5	15/16	28	33.1	1922V443	1.1	1-3/16	22	44.9
1528V360	0.5	15/16	28	36.5	1922V454	1.1	1-3/16	22	46.0
1528V414	0.6	15/16	28	41.9	1922V460	1.1	1-3/16	22	46.6
1622V270	0.4	1	22	27.5	1922V484	1.1	1-3/16	22	49.0
1622V297	0.4	1	22	30.2	1922V526	1.3	1-3/16	22	53.2
1622V307	0.5	1	22	31.2	1922V544	1.3	1-3/16	22	55.0
1622V336	0.5	1	22	34.1	1922V604	1.4	1-3/16	22	61.0
1622V520	0.8	1	22	52.5	1922V630	1.4	1-3/16	22	63.6
1626V262	0.4	1	26	26.7	1922V646	1.5	1-3/16	22	65.2
1626V290	0.5	1	26	29.5	1922V666	1.6	1-3/16	22	67.2
1626V293	0.5	1	26	29.8	1922V686	1.6	1-3/16	22	69.2
1626V304	0.6	1	26	30.9	1922V706	1.7	1-3/16	22	71.2
1626V330	0.6	1	26	33.5	1922V721	1.7	1-3/16	22	72.7
1626V339	0.6	1	26	34.4	1922V726	1.7	1-3/16	22	73.2
1626V356	0.6	1	26	36.1	1922V751	1.8	1-3/16	22	75.7

\* Weights shown are approximate.

For intermediate sizes not shown, consult BANDO for availability and price.



Part Number	Weight* (Lbs.)	Top Width (Inches)	Angle (°)	Outside Circ. (Inches)	Part Number	Weight* (Lbs.)	Top Width (Inches)	Angle (°)	Outside Circ. (Inches)
1922V806	1.8	1-3/16	22	81.2	2322V461	1.5	1-7/16	22	46.9
1922V891	1.8	1-3/16	22	89.7	2322V481	1.5	1-7/16	22	48.9
1922V966	1.9	1-3/16	22	97.2	2322V491	1.5	1-7/16	22	49.8
1926V250	0.4	1-3/16	26	25.6	2322V521	1.6	1-7/16	22	52.8
1926V275	0.6	1-3/16	26	28.2	2322V541	1.6	1-7/16	22	54.8
1926V333	0.8	1-3/16	26	33.9	2322V544	1.6	1-7/16	22	55.1
1926V367	0.9	1-3/16	26	37.3	2322V601	1.7	1-7/16	22	60.9
1926V376	0.9	1-3/16	26	38.2	2322V604	1.9	1-7/16	22	61.2
1926V380	0.9	1-3/16	26	38.6	2322V681	1.8	1-7/16	22	68.9
1926V390	0.9	1-3/16	26	39.7	2322V701	2.2	1-7/16	22	70.9
1926V407	1.0	1-3/16	26	41.3	2322V721	2.5	1-7/16	22	72.8
1926V415	1.0	1-3/16	26	42.1	2322V826	2.6	1-7/16	22	83.3
1926V427	1.0	1-3/16	26	43.3	2322V886	2.9	1-7/16	22	89.3
1926V507	1.2	1-3/16	26	51.3	2322V921	3.0	1-7/16	22	92.8
1926V542	1.8	1-3/16	26	54.9	2326V310	1.0	1-7/16	26	31.7
1930V355	0.8	1-3/16	30	36.0	2326V359	1.1	1-7/16	26	36.7
1930V366	0.9	1-3/16	30	37.2	2328V345	1.1	1-7/16	28	35.2
1930V375	0.9	1-3/16	30	38.3	2330V273	0.6	1-7/16	30	28.0
1930V400	1.0	1-3/16	30	40.8	2330V338	0.7	1-7/16	30	34.6
1930V431	1.1	1-3/16	30	43.9	2330V359	0.8	1-7/16	30	36.7
1930V450	1.1	1-3/16	30	45.8	2330V537	1.5	1-7/16	30	54.5
1930V485	1.2	1-3/16	30	49.3	2332V373	1.1	1-7/16	32	38.0
1930V491	1.2	1-3/16	30	49.8	2422V570	2.0	1-1/2	22	58.2
1930V500	1.2	1-3/16	30	50.9	2426V343	1.2	1-1/2	26	35.0
1930V541	1.3	1-3/16	30	54.8	2428V345	1.2	1-1/2	28	35.2
1930V591	1.4	1-3/16	30	59.8	2428V707	3.1	1-1/2	28	71.5
1930V630	1.5	1-3/16	30	63.8	2428V807	3.5	1-1/2	28	81.5
1930V670	1.6	1-3/16	30	67.7	2430V297	0.8	1-1/2	30	30.4
1930V691	1.6	1-3/16	30	69.8	2430V302	0.8	1-1/2	30	30.9
1930V710	1.6	1-3/16	30	71.7	2430V319	0.9	1-1/2	30	32.6
1930V750	1.7	1-3/16	30	75.8	2430V345	1.0	1-1/2	30	35.2
1930V791	1.9	1-3/16	30	79.8	2430V354	1.0	1-1/2	30	36.3
1930V850	2.0	1-3/16	30	85.8	2430V364	1.0	1-1/2	30	37.2
1930V891	2.1	1-3/16	30	89.9	2430V379	1.0	1-1/2	30	38.6
1930V900	2.1	1-3/16	30	90.8	2430V388	1.0	1-1/2	36	39.5
1930V950	2.2	1-3/16	30	95.8	2436V331	1.1	1-1/2	36	33.9
1930V991	2.4	1-3/16	30	99.9	2526V302	1.1	1-9/16	26	31.0
2026V422	0.5	1-1/4	26	42.8	2526V314	1.2	1-9/16	26	32.2
2026V445	0.8	1-1/4	26	45.1	2526V370	1.3	1-9/16	26	37.8
2026V474	0.6	1-1/4	26	48.0	2530V300	1.9	1-9/16	30	30.9
2026V607	1.1	1-1/4	26	61.3	2530V335	1.9	1-9/16	30	34.5
2028V447	0.9	1-1/4	28	45.2	2530V470	1.9	1-9/16	30	48.0
2030V381	0.9	1-1/4	30	38.7	2530V490	2.0	1-9/16	30	50.0
2126V297	0.7	1-5/16	26	30.3	2530V500	2.4	1-9/16	30	51.0
2126V307	0.7	1-5/16	26	31.3	2530V530	2.4	1-9/16	30	54.0
2126V309	0.7	1-5/16	26	31.5	2530V550	2.5	1-9/16	30	56.0
2126V365	1.0	1-5/16	26	37.1	2530V575	2.7	1-9/16	30	58.5
2126V377	1.0	1-5/16	26	38.3	2530V595	2.8	1-9/16	30	60.5
2126V468	1.1	1-5/16	26	47.6	2530V610	2.8	1-9/16	30	62.0
2226V307	0.7	1-3/8	26	31.3	2530V630	2.9	1-9/16	30	64.0
2230V266	0.6	1-3/8	30	27.4	2530V670	3.1	1-9/16	30	68.0
2230V273	0.6	1-3/8	30	28.0	2530V690	3.1	1-9/16	30	70.0
2230V275	0.6	1-3/8	30	28.3	2530V710	3.2	1-9/16	30	72.0
2230V285	0.6	1-3/8	30	29.3	2530V730	3.4	1-9/16	30	74.0
2230V326	0.7	1-3/8	30	33.4	2530V750	3.5	1-9/16	30	76.0
2230V345	0.8	1-3/8	30	35.3	2530V790	3.7	1-9/16	30	80.0
2230V375	0.9	1-3/8	30	38.3	2530V840	3.9	1-9/16	30	85.0
2322V329	1.0	1-7/16	22	33.7	2530V850	4.0	1-9/16	30	86.0
2322V347	1.1	1-7/16	22	35.4	2530V890	4.1	1-9/16	30	90.0
2322V364	1.1	1-7/16	22	37.2	2530V900	4.1	1-9/16	30	91.0
2322V373	1.1	1-7/16	22	38.0	2530V934	4.3	1-9/16	30	94.4
2322V384	1.2	1-7/16	22	39.1	2530V950	4.4	1-9/16	30	96.0
2322V396	1.2	1-7/16	22	40.4	2530V990	4.6	1-9/16	30	100.0
2322V421	1.3	1-7/16	22	42.8	2530V1250	5.1	1-9/16	30	126.0
2322V434	1.3	1-7/16	22	44.1	2626V369	1.3	1-5/8	26	37.6
2322V441	1.4	1-7/16	22	44.8	2626V388	1.4	1-5/8	26	39.6

\* Weights shown are approximate.

For intermediate sizes not shown, consult BANDO for availability and price.



Part Number	Weight* (Lbs.)	Top Width (Inches)	Angle (°)	Outside Circ. (Inches)	Part Number	Weight* (Lbs.)	Top Width (Inches)	Angle (°)	Outside Circ. (Inches)
2630V345	1.1	1-5/8	30	35.4	3226V650	2.7	2	26	65.9
2630V395	1.3	1-5/8	30	40.5	3226V663	2.8	2	26	67.2
2636V332	1.2	1-5/8	36	34.2	3226V690	3.1	2	26	69.9
2826V412	1.7	1-3/4	26	42.1	3226V723	3.2	2	26	73.2
2826V452	1.9	1-3/4	26	46.1	3226V783	3.4	2	26	79.2
2830V337	0.8	1-3/4	30	34.7	3226V843	3.6	2	26	86.0
2830V363	1.0	1-3/4	30	37.2	3226V903	3.8	2	26	91.2
2830V366	1.0	1-3/4	30	37.5	3226V963	4.0	2	26	97.2
2830V367	1.0	1-3/4	30	37.6	3226V1023	4.1	2	26	103.2
2830V387	1.3	1-3/4	30	39.6	3230V419	2.1	2	30	42.9
2830V393	1.1	1-3/4	30	40.3	3230V481	2.6	2	30	49.1
2830V422	1.2	1-3/4	30	43.2	3230V630	3.4	2	30	64.0
2830V428	1.2	1-3/4	30	43.8	3230V670	3.6	2	30	68.0
2830V492	2.1	1-3/4	30	50.2	3230V701	3.8	2	30	71.1
2836V343	1.4	1-3/4	36	35.2	3230V710	3.8	2	30	72.0
2836V350	1.4	1-3/4	36	35.9	3230V750	4.0	2	30	76.0
2836V361	1.5	1-3/4	36	37.0	3230V771	4.2	2	30	78.1
2836V380	1.6	1-3/4	36	38.9	3230V850	4.9	2	30	86.0
2926V366	1.7	1-13/16	26	37.5	3230V900	5.2	2	30	91.0
2926V400	1.8	1-13/16	26	40.9	3230V950	5.5	2	30	96.0
2926V426	2.0	1-13/16	26	43.5	3230V1250	7.2	2	30	126.0
2926V471	2.1	1-13/16	26	48.0	3230HV553	3.6	2	30	56.3
2926V477	2.1	1-13/16	26	48.6	3230HV570	3.6	2	30	58.0
2926V491	2.2	1-13/16	26	50.0	3230HV585	3.7	2	30	59.5
2926V521	2.4	1-13/16	26	53.0	3230HV603	3.8	2	30	61.3
2926V534	2.5	1-13/16	26	54.3	3230HV613	3.9	2	30	62.3
2926V546	2.5	1-13/16	26	55.5	3230HV620	4.0	2	30	63.0
2926V574	2.6	1-13/16	26	58.3	3230HV626	4.1	2	30	63.6
2926V586	2.7	1-13/16	26	59.5	3230HV644	4.1	2	30	65.4
2926V606	2.7	1-13/16	26	61.5	3230HV670	4.3	2	30	68.0
2926V616	2.8	1-13/16	26	62.5	3230HV685	4.3	2	30	69.5
2926V636	2.9	1-13/16	26	64.5	3230HV702	4.4	2	30	71.2
2926V646	2.9	1-13/16	26	65.5	3230HV723	4.5	2	30	73.3
2926V666	3.0	1-13/16	26	67.5	3230HV821	4.9	2	30	83.1
2926V686	3.1	1-13/16	26	69.5	3230HV856	5.0	2	30	86.6
2926V706	3.2	1-13/16	26	71.5	3230HV931	5.3	2	30	94.1
2926V726	3.3	1-13/16	26	73.5	3230HV960	5.4	2	30	97.0
2926V750	3.4	1-13/16	26	75.9	3236V342	1.5	2	36	35.1
2926V776	3.5	1-13/16	26	78.5	3236V369	1.6	2	36	37.8
2926V786	3.5	1-13/16	26	79.5	3236V389	2.0	2	36	39.9
2926V834	3.7	1-13/16	26	84.3	3236V432	2.2	2	36	44.2
2926V856	3.9	1-13/16	26	86.5	3326V478	2.7	2-1/16	36	48.9
2926V891	4.0	1-13/16	26	90.0	3430V424	2.1	2-1/8	30	43.4
2926V906	4.1	1-13/16	26	92.1	3430V450	2.1	2-1/8	30	46.0
2926V921	4.3	1-13/16	26	93.0	3430V456	2.1	2-1/8	30	46.6
2926V966	4.4	1-13/16	26	97.5	3430V480	2.2	2-1/8	30	49.0
2926V1026	4.7	1-13/16	26	103.5	3432V450	2.2	2-1/8	32	46.0
2930V348	2.1	1-13/16	30	35.7	3432V456	2.2	2-1/8	32	46.6
2930V492	2.2	1-13/16	30	50.2	3432V480	2.3	2-1/8	32	49.0
3028V386	1.8	1-7/8	28	39.5	3432V534	2.5	2-1/8	32	54.4
3030V357	1.6	1-7/8	30	36.7	3436V404	2.1	2-1/8	36	41.3
3030V377	1.7	1-7/8	30	38.7	3626V556	3.5	2-1/4	26	56.5
3030V387	1.7	1-7/8	30	39.6	3630V455	2.5	2-1/4	30	46.5
3036V351	1.6	1-7/8	36	36.1	3630V479	3.0	2-1/4	30	48.9
3226V392	1.9	2	26	40.1	3726V558	3.2	2-5/16	26	54.8
3226V395	2.0	2	26	40.4	3826V459	3.3	2-3/8	26	46.9
3226V400	2.1	2	26	40.9	3826V465	3.3	2-3/8	26	47.5
3226V433	2.2	2	26	44.2	3828V728	4.3	2-3/8	28	73.8
3226V439	2.2	2	26	44.8	3830V501	3.4	2-3/8	30	51.1
3226V450	2.3	2	26	45.9	3830V510	3.5	2-3/8	30	52.0
3226V465	2.3	2	26	47.4	3830V517	3.6	2-3/8	30	52.7
3226V505	2.4	2	26	51.4	3830V587	3.6	2-3/8	30	59.7
3226V514	2.4	2	26	52.3	3836V418	2.8	2-3/8	36	42.8
3226V545	2.5	2	26	55.4	3836V426	2.9	2-3/8	36	43.6
3226V585	2.5	2	26	59.4	3836V654	3.8	2-3/8	36	66.4
3226V603	2.6	2	26	61.2	3836V734	4.3	2-3/8	36	74.4

\* Weights shown are approximate.

For intermediate sizes not shown, consult BANDO for availability and price.



Part Number	Weight* (Lbs.)	Top Width (Inches)	Angle (°)	Outside Circ. (Inches)	Part Number	Weight* (Lbs.)	Top Width (Inches)	Angle (°)	Outside Circ. (Inches)
3836V795	2.9	2-3/8	36	80.5	4430V1150	9.8	2-3/4	30	116.1
4030V538	3.0	2-1/2	30	54.9	4430V1180	10.0	2-3/4	30	119.1
4030V590	4.2	2-1/2	30	60.1	4430V1250	11.9	2-3/4	30	126.1
4036V541	4.0	2-1/2	36	55.2	4430V1320	11.5	2-3/4	30	133.1
4036V574	4.1	2-1/2	36	58.5	4430V1410	13.2	2-3/4	30	142.1
4230V503	4.0	2-5/8	30	51.4	4436V525	4.5	2-3/4	36	53.6
4230V556	4.1	2-5/8	30	56.7	4436V551	4.7	2-3/4	36	56.2
4230V605	4.5	2-5/8	30	61.6	4436V576	4.9	2-3/4	36	58.7
4230V653	4.5	2-5/8	30	66.5	4436V646	5.5	2-3/4	36	65.7
4330V521	4.6	2-11/16	30	53.2	4436V714	7.6	2-3/4	36	72.5
4430V510	4.4	2-3/4	30	52.1	4436V750	7.8	2-3/4	36	76.1
4430V530	4.6	2-3/4	30	54.1	4630V650	7.5	2-7/8	30	66.1
4430V548	4.7	2-3/4	30	55.9	4630V663	7.5	2-7/8	30	67.4
4430V555	4.8	2-3/4	30	56.6	4630V668	7.7	2-7/8	30	67.9
4430V570	4.9	2-3/4	30	58.1	4630V683	8.0	2-7/8	30	69.4
4430V578	5.1	2-3/4	30	58.9	4630V733	8.1	2-7/8	30	74.4
4430V610	5.3	2-3/4	30	62.1	4630V756	7.6	2-7/8	30	76.7
4430V630	5.6	2-3/4	30	64.1	4632V722	8.5	2-7/8	32	73.3
4430V652	5.7	2-3/4	30	66.3	4830V614	6.7	3	30	62.8
4430V660	5.7	2-3/4	30	67.1	4830V653	6.8	3	30	66.7
4430V670	6.8	2-3/4	30	68.1	4830V692	6.9	3	30	70.6
4430V690	6.0	2-3/4	30	70.1	4830V699	7.0	3	30	71.3
4430V700	6.1	2-3/4	30	71.1	4830V730	7.2	3	30	74.4
4430V710	6.2	2-3/4	30	72.1	4830V750	7.3	3	30	76.4
4430V730	6.4	2-3/4	30	74.1	4830V850	8.0	3	30	86.4
4430V740	6.4	2-3/4	30	75.1	4836V588	5.8	3	36	60.2
4430V750	6.5	2-3/4	30	76.1	4836V608	6.0	3	36	62.2
4430V760	6.5	2-3/4	30	77.1	4836V655	6.4	3	36	66.9
4430V767	6.6	2-3/4	30	77.8	4836V670	6.4	3	36	68.4
4430V790	6.9	2-3/4	30	80.1	4836V710	6.5	3	36	72.4
4430V850	7.4	2-3/4	30	86.1	4836V729	7.0	3	36	74.3
4430V910	7.9	2-3/4	30	92.1	4836V750	7.2	3	36	76.4
4430V930	8.0	2-3/4	30	94.1	4836V789	7.3	3	36	80.3
4430V950	8.3	2-3/4	30	96.1	4836V850	7.5	3	36	86.4
4430V1030	9.0	2-3/4	30	104.1	4836V900	7.6	3	36	91.4
4430V1060	9.2	2-3/4	30	107.2	4836V950	8.5	3	36	96.4
4430V1090	9.6	2-3/4	30	110.1	4836V1180	10.0	3	36	119.4

### Metric Variable Speed Belts

Part Number	Weight* (Lbs.)	Top Width (Inches)	Angle (°)	Outside Circ. (Inches)	Part Number	Weight* (Lbs.)	Top Width (Inches)	Angle (°)	Outside Circ. (Inches)
875VC3828	1.2	1-1/2	28	35.4	975VC3830	1.0	1-1/2	38	39.3

\* Weights shown are approximate.

For intermediate sizes not shown, consult BANDO for availability and price.



Belt Number is effective length in tenths of an inch, cross section, and number of ribs.

**Nominal Dimensions**

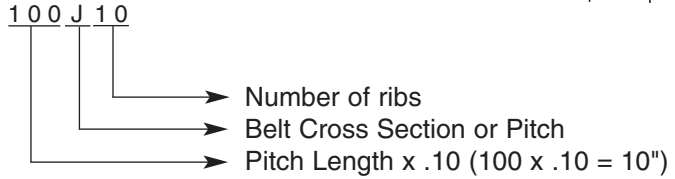
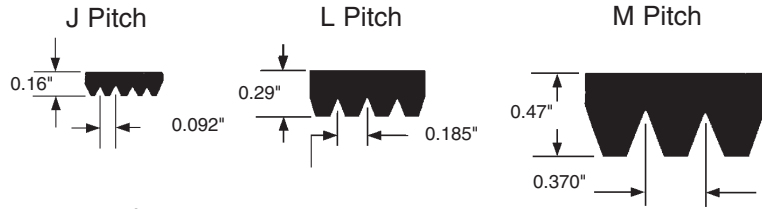

**J Section**

Part Number	Weight Rib* (Lbs.)	***Max. Ribs Per Sleeve	Part Number	Weight Rib* (Lbs.)	***Max. Ribs Per Sleeve
100J	0.10	180	425J	0.20	100
105J	0.10	180	430J	0.30	100
120J	0.10	180	440J	0.30	100
130J	0.10	180	445J	0.30	100
140J	0.10	180	450J	0.30	100
150J	0.10	180	460J	0.30	100
160J	0.10	180	480J	0.30	100
170J	0.10	180	490J	0.30	100
180J	0.10	180	500J	0.30	100
190J	0.10	180	510J	0.30	100
200J	0.10	180	515J	0.30	100
220J	0.10	180	520J	0.30	100
230J	0.10	180	530J	0.30	100
240J	0.10	180	540J	0.30	100
260J	0.20	180	550J	0.30	100
270J	0.20	100	560J	0.30	100
280J	0.20	100	580J	0.30	100
285J	0.20	100	610J	0.30	180
290J	0.20	100	630J	0.40	180
300J	0.20	100	650J	0.40	180
310J	0.20	100	655J	0.40	180
323J	0.20	100	690J	0.40	180
330J	0.20	100	730J	0.40	180
340J	0.20	100	770J	0.40	180
347J	0.20	100	820J	0.50	180
360J	0.20	100	870J	0.50	180
370J	0.20	100	920J	0.50	180
380J	0.20	100	940J	0.55	180
390J	0.20	100	980J	0.60	180
400J	0.20	100			

\* Weights shown are approximate.

\*\* Non-stock sizes – consult BANDO for availability.

\*\*\***Full sleeves are available – consult BANDO for price, availability and detailed cutting instructions.** For intermediate sizes not shown, consult BANDO for availability and price.



### L Section

Part Number	Weight Rib* (Lbs.)	***Max. Ribs Per Sleeve	Part Number	Weight Rib* (Lbs.)	***Max. Ribs Per Sleeve
375L	0.90	100	915L	0.27	100
390L	0.90	100	930L	0.27	100
500L	0.12	100	975L	0.28	100
525L	0.13	100	990L	0.28	100
540L	0.13	100	1065L	0.31	100
550L	0.13	100	1080L	0.31	100
560L	0.13	100	1120L	0.32	100
580L	0.13	100	1140L	0.32	100
615L	0.15	100	1150L	0.33	100
635L	0.15	100	1180L	0.34	100
655L	0.16	100	1215L	0.35	100
675L	0.16	100	1230L	0.35	100
695L	0.17	100	1295L	0.37	100
710L	0.17	100	1310L	0.38	100
725L	0.17	100	1375L	0.40	100
765L	0.18	100	1455L	0.42	100
780L	0.19	100	1595L	0.45	100
795L	0.19	100	1650L	0.48	100
815L	0.19	100	1760L	0.51	100
825L	0.19	100	1820L	0.53	100
840L	0.20	100	1980L	0.57	100
865L	0.20	100	2120L	0.62	100
880L	0.20	100	2400L	0.70	100

### M Section

Part Number	Weight Rib* (Lbs.)	***Max. Ribs Per Sleeve	Part Number	Weight Rib* (Lbs.)	***Max. Ribs Per Sleeve
900M	0.80	48	1830M	1.64	48
940M	0.84	48	1980M	1.78	48
990M	0.88	48	2130M	1.91	48
1060M	0.94	48	2410M	2.16	48
1115M	1.01	48	2710M	2.43	48
1150M	1.02	48	3010M	2.69	48
1230M	1.11	48	3310M	2.96	48
1310M	1.18	48	3610M	3.20	48
1390M	1.25	48	3910M	3.50	48
1470M	1.32	48	4210M	3.75	48
1610M	1.45	48	4810M	4.29	48
1650M	1.48	48	5410M	4.82	48
1760M	1.58	48	6010M	5.36	48

\* Weights shown are approximate.

\*\* Non-stock sizes – consult BANDO for availability.

\*\*\*Full sleeves are available – consult BANDO for price, availability and detailed cutting instructions.

For intermediate sizes not shown, consult BANDO for availability and price.

### Minimum Recommended Sheave Diameter

Belt Cross Section	J	L	M
Minimum Diameter (Inches)	0.8	3.0	7.0





**Nominal Dimensions**

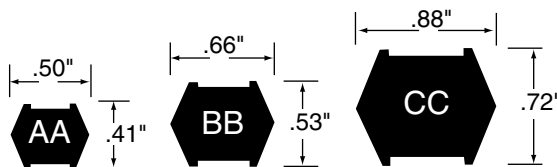

**AA Section**

Part Number	Weight* (Lbs.)	Effective Length (Inches)	Part Number	Weight* (Lbs.)	Effective Length (Inches)
AA45	0.30	47.10	AA78	0.60	80.10
AA47	0.30	49.10	AA80	0.60	82.10
AA51	0.40	53.10	AA85	0.60	87.10
AA55	0.40	57.10	AA90	0.70	92.10
AA60	0.50	62.10	AA93	0.70	95.10
AA62	0.50	64.10	AA96	0.70	98.10
AA64	0.50	66.10	AA105	0.80	107.10
AA65	0.50	67.10	AA112	0.80	114.10
AA66	0.50	68.10	AA120	0.90	122.10
AA68	0.50	70.10	AA128	0.90	130.10
AA70	0.60	72.10	AA136	1.00	138.10
AA75	0.60	77.10	AA144	1.00	146.10
AA77	0.60	79.10			

**BB Section**

Part Number	Weight* (Lbs.)	Effective Length (Inches)	Part Number	Weight* (Lbs.)	Effective Length (Inches)
BB43	0.60	45.90	BB122	1.50	124.90
BB45	0.60	47.90	BB123	1.50	125.90
BB46	0.60	48.90	BB124	1.50	126.90
BB51	0.70	53.90	BB127	1.60	129.90
BB53	0.70	55.90	BB128	1.60	130.90
BB54	0.70	56.90	BB129	1.60	131.90
BB55	0.70	57.90	BB130	1.70	132.90
BB60	0.80	62.90	BB136	1.80	138.90
BB63	0.80	65.90	BB140	1.80	142.90
BB68	0.90	70.90	BB144	1.80	146.90
BB71	1.00	73.90	BB148	1.80	150.90
BB73	1.00	75.90	BB155	2.00	157.90
BB74	1.00	76.90	BB157	2.00	159.90
BB75	1.00	77.90	BB158	2.00	160.90
BB76	1.00	78.90	BB159	2.00	161.90
BB77	1.00	79.90	BB162	2.10	164.90
BB81	1.00	83.90	BB168	2.10	170.90
BB82	1.00	84.90	BB169	2.10	171.90
BB83	1.00	85.90	BB173	2.10	175.90
BB85	1.10	87.90	BB175	2.10	177.90
BB90	1.10	92.90	BB180	2.20	182.90
BB92	1.10	94.90	BB182	2.20	184.90
BB93	1.20	95.90	BB190	2.30	192.90
BB94	1.20	96.90	BB195	2.40	197.90
BB97	1.20	99.90	BB210	2.60	212.90
BB103	1.30	105.90	BB225	2.80	226.40
BB105	1.30	107.90	BB226	2.80	227.40
BB107	1.30	109.90	BB228	2.90	229.40
BB108	1.30	110.90	BB230	2.90	231.40
BB111	1.40	113.90	BB240	2.90	241.40
BB112	1.40	114.90	BB270	3.30	271.40
BB116	1.40	118.90	BB273	3.30	274.40
BB117	1.40	119.90	BB277	3.50	278.40
BB118	1.50	120.90	BB278	3.50	279.40
BB120	1.50	122.90	BB300	3.70	301.40

\* Weights shown are approximate.

For intermediate sizes not shown, consult BANDO for availability and price.



### CC Section

Part Number	Weight* (Lbs.)	Effective Length (Inches)	Part Number	Weight* (Lbs.)	Effective Length (Inches)
CC75	1.60	79.20	CC158	3.50	162.20
CC81	1.80	85.20	CC162	3.80	166.20
CC85	1.90	89.20	CC173	3.80	177.20
CC90	2.00	94.20	CC180	4.00	184.20
CC96	2.20	100.20	CC195	4.30	199.20
CC105	2.40	109.20	CC210	4.70	214.20
CC112	2.50	116.20	CC240	5.20	242.20
CC119	2.70	123.20	CC270	5.90	272.20
CC120	2.70	124.20	CC300	6.50	302.20
CC128	2.90	132.20	CC330	7.20	332.20
CC136	3.10	140.20	CC360	7.80	362.20
CC144	3.20	148.20	CC390	8.50	392.20
CC150	3.20	154.20	CC420	9.10	422.20
CC155	3.20	159.20			

\* Weights shown are approximate.

For intermediate sizes not shown, consult BANDO for availability and price.

### Installation and Maintenance Tools

Get the maximum value from your BANDO drives: proper installation, alignment and tension are the key to optimum belt life.



Tension tester uses simple force/deflection method. Metal gauge is packed in plastic tube complete with instructions.  
**Order BU-304...\$20.00 net each.**



Sheave groove and belt cross section identification gauges used to inspect sheaves for worn or "dished out" sidewalls. Eleven (11) piece set measures classical and narrow sheaves.  
**Order BU-303...\$8.00 net each.**



Laser-A-Line system assures horizontal, vertical and parallel alignment, comes complete with three (3) targets and hard shell carrying case and instructions.  
**Order BU-439...\$1,225.00 list.**

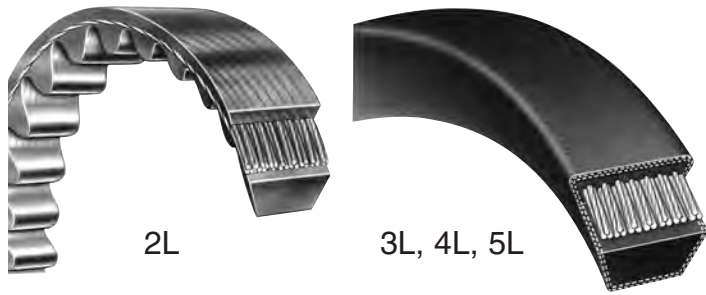

**Nominal Dimensions**

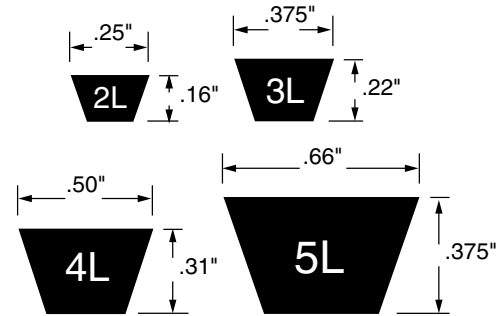

**2L Section** All 2L Duraflex are polyurethane cog construction.

Part Number	Weight* (Lbs.)	Outside Length (Inches)	Part Number	Weight* (Lbs.)	Outside Length (Inches)
2L080	0.008	8.0	2L180	0.018	18.0
2L090	0.009	9.0	2L190	0.018	19.0
2L100	0.010	10.0	2L200	0.019	20.0
2L110	0.011	11.0	2L220	0.021	22.0
2L120	0.012	12.0	2L240	0.023	24.0
2L130	0.013	13.0	2L260	0.025	26.0
2L140	0.014	14.0	2L280	0.027	28.0
2L150	0.015	15.0	2L300	0.029	30.0
2L160	0.016	16.0	2L320	0.031	32.0
2L170	0.017	17.0	2L340	0.033	34.0

**3L Section**

Part Number	Weight* (Lbs.)	Outside Length (Inches)	Part Number	Weight* (Lbs.)	Outside Length (Inches)
3L110	0.037	11.0	3L430	0.145	43.0
3L120	0.040	12.0	3L440	0.148	44.0
3L130	0.044	13.0	3L450	0.152	45.0
3L140	0.047	14.0	3L460	0.155	46.0
3L150	0.051	15.0	3L470	0.158	47.0
3L160	0.054	16.0	3L480	0.162	48.0
3L170	0.057	17.0	3L490	0.165	49.0
3L180	0.061	18.0	3L500	0.168	50.0
3L190	0.064	19.0	3L510	0.172	51.0
3L200	0.067	20.0	3L520	0.175	52.0
3L210	0.071	21.0	3L530	0.179	53.0
3L220	0.074	22.0	3L540	0.182	54.0
3L230	0.077	23.0	3L550	0.185	55.0
3L240	0.081	24.0	3L560	0.189	56.0
3L250	0.084	25.0	3L570	0.192	57.0
3L260	0.088	26.0	3L580	0.195	58.0
3L270	0.091	27.0	3L590	0.199	59.0
3L280	0.094	28.0	3L600	0.202	60.0
3L290	0.098	29.0	3L610	0.205	61.0
3L300	0.101	30.0	3L620	0.209	62.0
3L310	0.104	31.0	3L630	0.212	63.0
3L320	0.108	32.0	3L640	0.216	64.0
3L330	0.111	33.0	3L650	0.219	65.0
3L340	0.115	34.0	3L660	0.222	66.0
3L350	0.118	35.0	3L670	0.226	67.0
3L360	0.121	36.0	3L680	0.229	68.0
3L370	0.125	37.0	3L690	0.232	69.0
3L380	0.128	38.0	3L700	0.236	70.0
3L390	0.131	39.0	3L710	0.239	71.0
3L400	0.135	40.0	3L720	0.242	72.0
3L410	0.138	41.0	3L730	0.246	73.0
3L420	0.141	42.0	3L740	0.249	74.0

\* Weights shown are approximate.

For intermediate sizes not shown, consult BANDO for availability and price.



### 4L Section

Part Number	Weight* (Lbs.)	Outside Length (Inches)	Part Number	Weight* (Lbs.)	Outside Length (Inches)
4L150	0.090	15.0	4L570	0.344	57.0
4L160	0.096	16.0	4L580	0.350	58.0
4L170	0.102	17.0	4L590	0.356	59.0
4L175	0.105	17.5	4L600	0.362	60.0
4L180	0.109	18.0	4L610	0.368	61.0
4L190	0.115	19.0	4L620	0.374	62.0
4L200	0.121	20.0	4L630	0.380	63.0
4L210	0.127	21.0	4L640	0.386	64.0
4L220	0.133	22.0	4L650	0.392	65.0
4L230	0.139	23.0	4L660	0.398	66.0
4L240	0.145	24.0	4L670	0.404	67.0
4L250	0.151	25.0	4L680	0.410	68.0
4L260	0.157	26.0	4L690	0.416	69.0
4L270	0.163	27.0	4L700	0.422	70.0
4L280	0.169	28.0	4L710	0.428	71.0
4L290	0.175	29.0	4L720	0.434	72.0
4L300	0.181	30.0	4L730	0.440	73.0
4L310	0.187	31.0	4L740	0.446	74.0
4L315	0.190	31.5	4L750	0.452	75.0
4L320	0.193	32.0	4L760	0.458	76.0
4L330	0.199	33.0	4L770	0.464	77.0
4L340	0.205	34.0	4L780	0.470	78.0
4L350	0.211	35.0	4L790	0.476	79.0
4L360	0.217	36.0	4L800	0.482	80.0
4L370	0.223	37.0	4L810	0.488	81.0
4L380	0.229	38.0	4L820	0.494	82.0
4L390	0.235	39.0	4L830	0.500	83.0
4L400	0.241	40.0	4L840	0.506	84.0
4L410	0.247	41.0	4L850	0.512	85.0
4L415	0.250	41.5	4L860	0.518	86.0
4L420	0.253	42.0	4L870	0.524	87.0
4L430	0.259	43.0	4L880	0.530	88.0
4L440	0.265	44.0	4L890	0.536	89.0
4L450	0.271	45.0	4L900	0.543	90.0
4L460	0.277	46.0	4L910	0.549	91.0
4L470	0.283	47.0	4L920	0.555	92.0
4L480	0.289	48.0	4L930	0.561	93.0
4L490	0.295	49.0	4L940	0.567	94.0
4L500	0.301	50.0	4L950	0.573	95.0
4L510	0.307	51.0	4L960	0.579	96.0
4L520	0.313	52.0	4L970	0.585	97.0
4L530	0.319	53.0	4L980	0.591	98.0
4L540	0.326	54.0	4L990	0.597	99.0
4L550	0.332	55.0	4L1000	0.603	100.0
4L560	0.338	56.0			

\* Weights shown are approximate.

For intermediate sizes not shown, consult BANDO for availability and price.

### Belt Sleeves

BANDO Belt Sleeves are useful in identifying and displaying belts in an attractive and organized manner. For availability of sleeves, contact BANDO Inside Sales and request Sleeve BU-201 (3" x 6" x 1/2") or Sleeve BU-202 (4" x 6" x 3/4").

**BANDO**  
**Premium V-Belt**

**PROPER INSTALLATION PROCEDURE**

1. Lock out power source before attempting to change belt(s).
2. Shorten center distance and remove old belt(s).
3. Inspect sheave(s) for wear or damage. Replace if necessary.
4. Replace new belt(s). Do NOT attempt to install new belt(s) by prying, forcing or rolling over sheave groove(s).

**PROPER TENSIONING PROCEDURE**

1. Measure the span length (L) of your drive.
2. At the center of the span (L), apply a force perpendicular to the belt. Measure the force required to deflect the belt 1/64 inch per inch of span length. For example, for a 20 inch span, the deflection would be 20/64 inches or 5/16 inches.
3. Compare this force with the recommended ranges shown in Bando's Catalog BU-200. Tighten or loosen belts to bring into the recommended range.
4. New belts should be tensioned to "initial installation" force shown in the table. Check tension after the first 24 hours of operation and retension if necessary.

**Worldwide Manufacturing  
World Class Quality**

[www.bandousa.com](http://www.bandousa.com) BU-202



## 5L Section

Part Number	Weight* (Lbs.)	Outside Length (Inches)	Part Number	Weight* (Lbs.)	Outside Length (Inches)
5L230	0.210	23.0	5L620	0.567	62.0
5L240	0.219	24.0	5L630	0.576	63.0
5L250	0.229	25.0	5L640	0.585	64.0
5L260	0.238	26.0	5L650	0.594	65.0
5L270	0.247	27.0	5L660	0.603	66.0
5L280	0.256	28.0	5L670	0.613	67.0
5L290	0.265	29.0	5L680	0.622	68.0
5L300	0.274	30.0	5L690	0.631	69.0
5L310	0.283	31.0	5L700	0.640	70.0
5L320	0.293	32.0	5L710	0.649	71.0
5L330	0.302	33.0	5L720	0.658	72.0
5L340	0.311	34.0	5L730	0.667	73.0
5L350	0.320	35.0	5L740	0.677	74.0
5L360	0.329	36.0	5L750	0.686	75.0
5L370	0.338	37.0	5L760	0.695	76.0
5L380	0.347	38.0	5L770	0.704	77.0
5L390	0.357	39.0	5L780	0.713	78.0
5L400	0.366	40.0	5L790	0.722	79.0
5L410	0.375	41.0	5L800	0.731	80.0
5L420	0.384	42.0	5L810	0.741	81.0
5L430	0.393	43.0	5L820	0.750	82.0
5L440	0.402	44.0	5L830	0.759	83.0
5L450	0.411	45.0	5L840	0.768	84.0
5L460	0.421	46.0	5L850	0.777	85.0
5L470	0.430	47.0	5L860	0.786	86.0
5L480	0.439	48.0	5L870	0.795	87.0
5L490	0.448	49.0	5L880	0.804	88.0
5L500	0.457	50.0	5L890	0.814	89.0
5L510	0.466	51.0	5L900	0.823	90.0
5L520	0.475	52.0	5L910	0.832	91.0
5L530	0.485	53.0	5L920	0.841	92.0
5L540	0.494	54.0	5L930	0.850	93.0
5L550	0.503	55.0	5L940	0.859	94.0
5L560	0.512	56.0	5L950	0.868	95.0
5L570	0.521	57.0	5L960	0.878	96.0
5L580	0.530	58.0	5L970	0.887	97.0
5L590	0.539	59.0	5L980	0.896	98.0
5L600	0.549	60.0	5L990	0.905	99.0
5L610	0.558	61.0	5L1000	0.914	100.0

\* Weights shown are approximate.

For intermediate sizes not shown, consult BANDO for availability and price.

## Premium Belt Rack

This premium quality belt rack system is offered exclusively from BANDO USA. It includes a 36" heavy-duty steel track, six (6) - six inch heavy-duty steel pegs and six back tags. It features a graphite color, baked powder-coat epoxy finish for a long, maintenance-free service life. Mounting holes in the track are spaced for securing to wall studs. System is sized for standard shipping charges via UPS.

Order BU-145...\$20.00 net each.



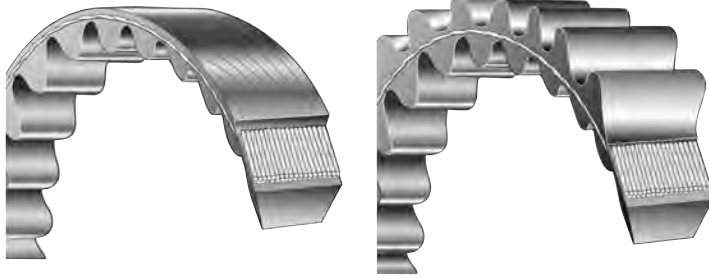

**Nominal Dimensions**

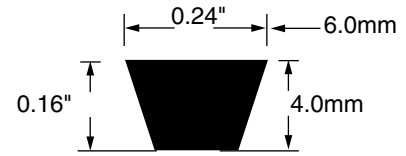

Part Number	Weight* (Lbs.)	Outside Length		Part Number	Weight* (Lbs.)	Outside Length	
		(Inches)	(mm)			(Inches)	(mm)
VC6X207	0.007	8.1	207.0	VC6X550	0.018	21.7	550.0
VC6X220	0.007	8.7	220.0	VC6X561	0.019	22.1	561.0
VC6X232	0.008	9.1	232.0	VC6X587	0.020	23.1	587.0
VC6X250	0.008	9.8	250.0	VC6X600	0.020	23.6	600.0
VC6X260	0.009	10.2	260.0	VC6X613	0.020	24.1	613.0
VC6X261	0.009	10.3	261.0	VC6X628	0.021	24.7	628.0
VC6X270	0.009	10.6	270.0	VC6X650	0.022	25.6	650.0
VC6X280	0.009	11.0	280.0	VC6X663	0.022	26.1	663.0
VC6X289	0.010	11.4	289.0	VC6X700	0.023	27.6	700.0
VC6X290	0.010	11.4	290.0	VC6X713	0.024	28.1	713.0
VC6X297	0.010	11.7	297.0	VC6X730	0.024	28.7	730.0
VC6X300	0.010	11.8	300.0	VC6X750	0.025	29.5	750.0
VC6X310	0.010	12.2	310.0	VC6X760	0.025	29.9	760.0
VC6X315	0.011	12.4	315.0	VC6X764	0.025	30.1	764.0
VC6X320	0.011	12.6	320.0	VC6X800	0.027	31.5	800.0
VC6X330	0.011	13.0	330.0	VC6X821	0.027	32.3	821.0
VC6X340	0.011	13.4	340.0	VC6X850	0.028	33.5	850.0
VC6X343	0.012	13.5	343.0	VC6X866	0.029	34.1	866.0
VC6X345	0.012	13.6	345.0	DC6X200	0.011	7.9	200.0
VC6X349	0.012	13.7	349.0	DC6X210	0.012	8.3	210.0
VC6X350	0.012	13.8	350.0	DC6X230	0.012	9.1	230.0
VC6X360	0.012	14.2	360.0	DC6X240	0.013	9.4	240.0
VC6X370	0.012	14.6	370.0	DC6X250	0.014	9.8	250.0
VC6X380	0.013	15.0	380.0	DC6X260	0.014	10.2	260.0
VC6X381	0.013	15.0	381.0	DC6X270	0.015	10.6	270.0
VC6X390	0.013	15.4	390.0	DC6X277	0.015	10.9	277.0
VC6X400	0.013	15.7	400.0	DC6X280	0.016	11.0	280.0
VC6X407	0.014	16.0	407.0	DC6X290	0.016	11.4	290.0
VC6X410	0.014	16.1	410.0	DC6X300	0.016	11.8	300.0
VC6X414	0.014	16.3	414.0	DC6X310	0.017	12.2	310.0
VC6X420	0.014	16.5	420.0	DC6X315	0.017	12.4	315.0
VC6X430	0.014	16.9	430.0	DC6X320	0.018	12.6	320.0
VC6X432	0.014	17.0	432.0	DC6X330	0.018	13.0	330.0
VC6X440	0.015	17.3	440.0	DC6X340	0.018	13.4	340.0
VC6X444	0.015	17.5	444.0	DC6X345	0.018	13.6	345.0
VC6X450	0.015	17.7	450.0	DC6X350	0.019	13.8	350.0
VC6X460	0.015	18.1	460.0	DC6X360	0.019	14.2	360.0
VC6X466	0.016	18.4	466.0	DC6X365	0.019	14.4	365.0
VC6X470	0.016	18.5	470.0	DC6X370	0.020	14.6	370.0
VC6X480	0.016	18.9	480.0	DC6X380	0.020	15.0	380.0
VC6X485	0.016	19.1	485.0	DC6X390	0.020	15.4	390.0
VC6X490	0.016	19.3	490.0	DC6X400	0.021	15.7	400.0
VC6X500	0.017	19.7	500.0	DC6X450	0.021	17.7	450.0
VC6X511	0.017	20.1	511.0	DC6X470	0.021	18.5	470.0
VC6X520	0.017	20.5	520.0	DC6X500	0.022	19.7	500.0
VC6X530	0.018	20.9	530.0	DC6X540	0.022	21.3	540.0
VC6X540	0.018	21.3	540.0				

\* Weights shown are approximate.

For intermediate sizes not shown, consult BANDO for availability and price.

**Minimum Recommended Sheave Diameters**

Using sheave diameters less than the recommended minimum can substantially reduce belt life and drive efficiency. Dimensions shown are datum diameters in inches.

FHP Belt Cross Section	2L, VC, DC	3L	4L	5L
Minimum Diameter (Inches)	0.80	1.50	2.50	3.50





### Nominal Dimensions



Ultrapower AG™ KC is constructed specifically for those drives where a clutching function is essential to successful operation. Compounded to provide maximum durability during the clutching phase of operation, the KC's envelope, aramid fiber tension members and low profile design provide extended service life and superior flexibility to handle idler and reverse bend drive configurations typical of many power equipment applications.

### A Section

Part Number	Weight* (Lbs.)	Outside Length (Inches)	Pitch Length (Inches)	Part Number	Weight* (Lbs.)	Outside Length (Inches)	Pitch Length (Inches)
A28KC	0.181	29.9	29	A66KC	0.426	67.9	67
A29KC	0.187	30.9	30	A67KC	0.432	68.9	68
A30KC	0.194	31.9	31	A68KC	0.439	69.9	69
A31KC	0.200	32.9	32	A69KC	0.445	70.9	70
A32KC	0.206	33.9	33	A70KC	0.452	71.9	71
A33KC	0.213	34.9	34	A71KC	0.458	72.9	72
A34KC	0.219	35.9	35	A72KC	0.464	73.9	73
A35KC	0.226	36.9	36	A73KC	0.471	74.9	74
A36KC	0.232	37.9	37	A74KC	0.477	75.9	75
A37KC	0.239	38.9	38	A75KC	0.484	76.9	76
A38KC	0.245	39.9	39	A76KC	0.490	77.9	77
A39KC	0.252	40.9	40	A77KC	0.497	78.9	78
A40KC	0.258	41.9	41	A78KC	0.503	79.9	79
A41KC	0.264	42.9	42	A79KC	0.510	80.9	80
A42KC	0.271	43.9	43	A80KC	0.516	81.9	81
A43KC	0.277	44.9	44	A81KC	0.522	82.9	82
A44KC	0.284	45.9	45	A82KC	0.529	83.9	83
A45KC	0.290	46.9	46	A83KC	0.535	84.9	84
A46KC	0.297	47.9	47	A84KC	0.542	85.9	85
A47KC	0.303	48.9	48	A85KC	0.548	86.9	86
A48KC	0.310	49.9	49	A86KC	0.555	87.9	87
A49KC	0.316	50.9	50	A87KC	0.561	88.9	88
A50KC	0.323	51.9	51	A88KC	0.568	89.9	89
A51KC	0.329	52.9	52	A89KC	0.574	90.9	90
A52KC	0.335	53.9	53	A90KC	0.581	91.9	91
A53KC	0.342	54.9	54	A91KC	0.587	92.9	92
A54KC	0.348	55.9	55	A92KC	0.593	93.9	93
A55KC	0.355	56.9	56	A93KC	0.600	94.9	94
A56KC	0.361	57.9	57	A95KC	0.613	96.9	96
A57KC	0.368	58.9	58	A98KC	0.632	99.9	99
A58KC	0.374	59.9	59	A100KC	0.645	101.9	101
A59KC	0.381	60.9	60	A101KC	0.651	102.9	102
A60KC	0.387	61.9	61	A103KC	0.664	104.9	104
A61KC	0.393	62.9	62	A105KC	0.677	106.9	106
A62KC	0.400	63.9	63	A106KC	0.688	107.9	107
A63KC	0.406	64.9	64	A112KC	0.722	113.9	113
A64KC	0.413	65.9	65	A120KC	0.774	121.9	121
A65KC	0.419	66.9	66	A136KC	0.877	137.9	137

\* Weights shown are approximate.

\*\*Also available in K construction for applications where clutching is not a requirement. List price(s), dimension information and internal construction of the K is identical to the KC design. For intermediate sizes not shown, consult BANDO for availability and price.



## B Section

Part Number	Weight* (Lbs.)	Outside Length (Inches)	Pitch Length (Inches)	Part Number	Weight* (Lbs.)	Outside Length (Inches)	Pitch Length (Inches)
B28KC	0.295	31.1	30	B75KC	0.791	78.1	77
B29KC	0.305	32.1	31	B76KC	0.800	79.1	78
B30KC	0.316	33.1	32	B77KC	0.810	80.1	79
B31KC	0.326	34.1	33	B78KC	0.821	81.1	80
B32KC	0.337	35.1	34	B79KC	0.831	82.1	81
B33KC	0.347	36.1	35	B80KC	0.842	83.1	82
B34KC	0.358	37.1	36	B81KC	0.852	84.1	83
B35KC	0.368	38.1	37	B82KC	0.863	85.1	84
B36KC	0.379	39.1	38	B83KC	0.873	86.1	85
B37KC	0.389	40.1	39	B84KC	0.884	87.1	86
B38KC	0.400	41.1	40	B85KC	0.894	88.1	87
B39KC	0.410	42.1	41	B86KC	0.905	89.1	88
B40KC	0.421	43.1	42	B87KC	0.915	90.1	89
B41KC	0.431	44.1	43	B88KC	0.926	91.1	90
B42KC	0.442	45.1	44	B89KC	0.936	92.1	91
B43KC	0.452	46.1	45	B90KC	0.947	93.1	92
B44KC	0.463	47.1	46	B91KC	0.957	94.1	93
B45KC	0.473	48.1	47	B92KC	0.968	95.1	94
B46KC	0.484	49.1	48	B93KC	0.978	96.1	95
B47KC	0.494	50.1	49	B94KC	0.989	97.1	96
B48KC	0.505	51.1	50	B95KC	0.999	98.1	97
B49KC	0.515	52.1	51	B96KC	1.010	99.1	98
B50KC	0.526	53.1	52	B97KC	1.020	100.1	99
B51KC	0.537	54.1	53	B98KC	1.031	101.1	100
B52KC	0.547	55.1	54	B99KC	1.041	102.1	101
B53KC	0.558	56.1	55	B100KC	1.052	103.1	102
B54KC	0.568	57.1	56	B103KC	1.084	106.1	105
B55KC	0.579	58.1	57	B108KC	1.136	111.1	110
B56KC	0.589	59.1	58	B112KC	1.178	115.1	114
B57KC	0.600	60.1	59	B116KC	1.220	119.1	118
B58KC	0.610	61.1	60	B126KC	1.326	129.1	128
B59KC	0.621	62.1	61	B128KC	1.347	131.1	130
B60KC	0.631	63.1	62	B131KC	1.378	134.1	133
B61KC	0.642	64.1	63	B133KC	1.399	136.1	135
B62KC	0.652	65.1	64	B136KC	1.431	139.1	138
B63KC	0.663	66.1	65	B138KC	1.493	141.1	140
B64KC	0.673	67.1	66	B144KC	1.515	147.1	146
B65KC	0.684	68.1	67	B147KC	1.546	150.1	149
B66KC	0.694	69.1	68	B148KC	1.557	151.1	150
B67KC	0.705	70.1	69	B150KC	1.578	153.1	152
B68KC	0.715	71.1	70	B155KC	1.601	158.1	157
B69KC	0.726	72.1	71	B157KC	1.632	160.1	159
B70KC	0.736	73.1	72	B158KC	1.662	161.1	160
B71KC	0.747	74.1	73	B175KC	1.841	178.1	177
B72KC	0.757	75.1	74	B180KC	1.894	183.1	182
B73KC	0.768	76.1	75	B216KC	2.273	219.1	218
B74KC	0.778	77.1	76				

\* Weights shown are approximate.

\*\*Also available in K construction for applications where clutching is not a requirement. List price(s), dimensional information and internal construction of the K is identical to the KC design.

For intermediate sizes not shown, consult BANDO for availability and price.



### XPZ/SPZ, XPA/SPA, XPB/SPB, SPC

In addition to belts manufactured to RMA (Rubber Manufacturers Association) Standards, BANDO produces belts to European Standard DIN 7753 and ISO 4184.

#### SP Belts - European Standard DIN 7753

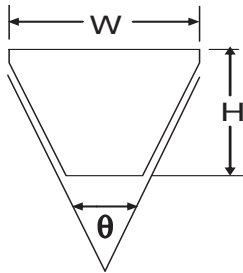

	SPZ XPZ	SPA XPA	SPB XPB	SPC
W (mm)	9.5	12.5	16	22
H (mm)	8	10	13.5	18
$\theta$ (degrees)	40	40	40	40

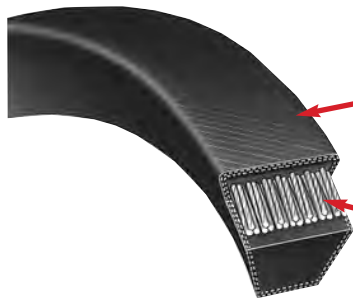

SPZ, SPA, SPB, SPC

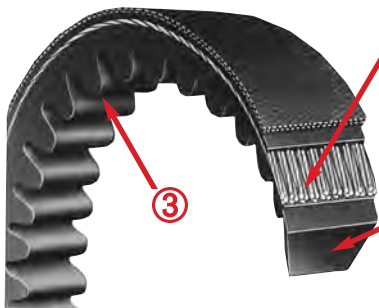

XPZ, XPA, XPB

- ① **Cover** - The oil and heat resistant top cover protects the belt from damage while contributing to the belt's dimensional stability. The cover stock is bias cut to provide lateral stability while allowing axial flexibility.
- ② **Tension Member** - Stability is assured through the use of a formulated fiber loaded *BANPRENE*<sup>®</sup> cushion stock that maintains cord "lay" integrity and uniform distribution of load transmission.
- ③ The **precision molded cogs** (X Series) provides optimum flexibility with a minimum of heat build up. Flexing generates heat; heat will shorten belt life. The two (2) primary factors that increase replacement costs and down time.
- ④ **Compression Section** - The fiber loaded compression section provides a high coefficient of friction.



### XPZ, SPZ

Part Number	Weight* (Lbs.)	Part Number	Weight* (Lbs.)	Part Number	Weight* (Lbs.)	Part Number	Weight* (Lbs.)
XPZ587	0.100	XPZ1024	0.174	XPZ1400	0.239	XPZ1850	0.315
XPZ612	0.104	XPZ1030	0.175	XPZ1412	0.241	XPZ1862	0.317
XPZ630	0.107	XPZ1037	0.177	XPZ1420	0.242	XPZ1867	0.318
XPZ637	0.109	XPZ1047	0.178	XPZ1437	0.245	XPZ1900	0.324
XPZ670	0.114	XPZ1060	0.181	XPZ1450	0.247	XPZ1937	0.330
XPZ710	0.121	XPZ1077	0.183	XPZ1462	0.249	XPZ1950	0.332
XPZ722	0.123	XPZ1080	0.184	XPZ1470	0.250	XPZ1962	0.334
XPZ730	0.124	XPZ1087	0.185	XPZ1487	0.253	XPZ1987	0.339
XPZ750	0.128	XPZ1112	0.189	XPZ1500	0.256	XPZ2000	0.341
XPZ762	0.130	XPZ1120	0.191	XPZ1512	0.258	XPZ2030	0.346
XPZ787	0.134	XPZ1137	0.194	XPZ1520	0.259	XPZ2037	0.347
XPZ800	0.136	XPZ1140	0.194	XPZ1537	0.262	XPZ2120	0.361
XPZ812	0.138	XPZ1150	0.196	XPZ1560	0.266	XPZ2137	0.364
XPZ825	0.141	XPZ1162	0.198	XPZ1562	0.266	XPZ2187	0.373
XPZ837	0.143	XPZ1180	0.201	XPZ1587	0.270	XPZ2240	0.382
XPZ850	0.145	XPZ1187	0.202	XPZ1600	0.273	XPZ2280	0.388
XPZ862	0.147	XPZ1202	0.205	XPZ1612	0.275	XPZ2287	0.390
XPZ875	0.149	XPZ1212	0.206	XPZ1637	0.279	XPZ2360	0.402
XPZ887	0.151	XPZ1237	0.211	XPZ1650	0.281	XPZ2410	0.411
XPZ900	0.153	XPZ1250	0.213	XPZ1662	0.283	XPZ2437	0.415
XPZ912	0.155	XPZ1262	0.215	XPZ1687	0.287	XPZ2500	0.426
XPZ925	0.158	XPZ1270	0.216	XPZ1700	0.290	XPZ2540	0.433
XPZ937	0.160	XPZ1287	0.219	XPZ1737	0.296	XPZ2690	0.458
XPZ950	0.162	XPZ1312	0.224	XPZ1750	0.298	XPZ2800	0.477
XPZ962	0.164	XPZ1320	0.225	XPZ1762	0.300	XPZ2840	0.484
XPZ987	0.168	XPZ1337	0.228	XPZ1787	0.304	XPZ3000	0.511
XPZ1000	0.170	XPZ1340	0.228	XPZ1800	0.307	XPZ3160	0.538
XPZ1010	0.172	XPZ1362	0.232	XPZ1812	0.309	SPZ3350	0.628
XPZ1012	0.172	XPZ1387	0.236	XPZ1837	0.313	SPZ3550	0.666

### XPA, SPA

Part Number	Weight* (Lbs.)	Part Number	Weight* (Lbs.)	Part Number	Weight* (Lbs.)	Part Number	Weight* (Lbs.)
XPA530	0.126	XPA1257	0.299	XPA1607	0.383	XPA2082	0.496
XPA732	0.174	XPA1272	0.303	XPA1650	0.393	XPA2120	0.505
XPA760	0.181	XPA1280	0.305	XPA1657	0.395	XPA2132	0.508
XPA782	0.186	XPA1282	0.305	XPA1680	0.400	XPA2180	0.519
XPA800	0.190	XPA1300	0.310	XPA1682	0.400	XPA2182	0.520
XPA832	0.198	XPA1307	0.311	XPA1700	0.405	XPA2207	0.525
XPA850	0.202	XPA1320	0.314	XPA1707	0.406	XPA2240	0.533
XPA900	0.214	XPA1332	0.317	XPA1732	0.412	XPA2282	0.543
XPA910	0.217	XPA1340	0.319	XPA1750	0.417	XPA2307	0.549
XPA925	0.220	XPA1357	0.323	XPA1757	0.418	XPA2332	0.555
XPA932	0.222	XPA1360	0.324	XPA1782	0.424	XPA2360	0.562
XPA950	0.226	XPA1375	0.327	XPA1800	0.429	XPA2382	0.567
XPA982	0.234	XPA1382	0.329	XPA1807	0.430	XPA2432	0.579
XPA1000	0.238	XPA1400	0.333	XPA1832	0.436	XPA2482	0.591
XPA1032	0.246	XPA1407	0.335	XPA1850	0.440	XPA2500	0.595
XPA1060	0.252	XPA1430	0.340	XPA1857	0.442	XPA2582	0.615
XPA1090	0.260	XPA1432	0.341	XPA1882	0.448	XPA2682	0.639
XPA1107	0.264	XPA1450	0.345	XPA1900	0.452	XPA2732	0.650
XPA1120	0.267	XPA1457	0.347	XPA1907	0.454	XPA2800	0.667
XPA1132	0.270	XPA1482	0.353	XPA1932	0.460	XPA3000	0.714
XPA1150	0.274	XPA1500	0.357	XPA1950	0.464	XPA 3150	0.750
XPA1157	0.275	XPA1507	0.359	XPA1957	0.466	SPA3182	1.134
XPA1180	0.281	XPA1525	0.363	XPA1982	0.472	SPA3350	1.194
XPA1207	0.287	XPA1550	0.369	XPA2000	0.476	SPA3750	1.337
XPA1220	0.290	XPA1557	0.371	XPA2032	0.484	SPA4000	1.426
XPA1232	0.293	XPA1582	0.377	XPA2057	0.490	SPA4250	1.515
XPA1250	0.298	XPA1600	0.381	XPA2060	0.490	SPA4500	1.604

\* Weights shown are approximate.

For intermediate sizes not shown, consult BANDO for availability and price.



### XPB, SPB

Part Number	Weight* (Lbs.)	Part Number	Weight* (Lbs.)	Part Number	Weight* (Lbs.)	Part Number	Weight* (Lbs.)
XPB1150	0.506	XPB1850	0.814	XPB3000	1.320	SPB5070	2.535
XPB1250	0.550	XPB1900	0.836	XPB3150	1.386	SPB5300	2.650
XPB1260	0.554	XPB1950	0.858	SPB3340	1.670	SPB5380	2.690
XPB1320	0.581	XPB2000	0.880	SPB3350	1.675	SPB5600	2.800
XPB1340	0.590	XPB2020	0.889	SPB3550	1.775	SPB5680	2.840
XPB1400	0.616	XPB2060	0.906	SPB3650	1.825	SPB5990	2.995
XPB1410	0.620	XPB2120	0.933	SPB3750	1.875	SPB6000	3.000
XPB1450	0.638	XPB2150	0.946	SPB3800	1.900	SPB6300	3.150
XPB1500	0.660	XPB2180	0.959	SPB4000	2.000	SPB6340	3.170
XPB1510	0.664	XPB2240	0.986	SPB4060	2.030	SPB6700	3.350
XPB1550	0.682	XPB2280	1.003	SPB4250	2.125	SPB7100	3.550
XPB1600	0.704	XPB2360	1.038	SPB4310	2.155	SPB7500	3.750
XPB1650	0.726	XPB2410	1.060	SPB4500	2.250	SPB7990	3.995
XPB1690	0.744	XPB2500	1.100	SPB4560	2.280	SPB8000	4.000
XPB1700	0.748	XPB2680	1.179	SPB4750	2.375		
XPB1750	0.770	XPB2800	1.232	SPB4820	2.410		
XPB1800	0.792	XPB2990	1.316	SPB5000	2.500		

### SPC

Part Number	Weight* (Lbs.)	Part Number	Weight* (Lbs.)	Part Number	Weight* (Lbs.)	Part Number	Weight* (Lbs.)
SPC2000	2.050	SPC3150	3.229	SPC5300	5.433	SPC9000	9.225
SPC2120	2.173	SPC3350	3.434	SPC5600	5.740	SPC10000	10.250
SPC2240	2.296	SPC3550	3.639	SPC6000	6.150	SPC10600	10.865
SPC2360	2.419	SPC3750	3.844	SPC6300	6.458	SPC11200	11.480
SPC2500	2.563	SPC4000	4.100	SPC6700	6.868	SPC11800	12.095
SPC2600	2.665	SPC4250	4.356	SPC7100	7.278	SPC12500	12.813
SPC2650	2.716	SPC4500	4.613	SPC7500	7.688		
SPC2800	2.870	SPC4750	4.869	SPC8200	8.405		
SPC3000	3.075	SPC5000	5.125	SPC8500	8.713		

\* Weights shown are approximate.

For intermediate sizes not shown, consult BANDO for availability and price.

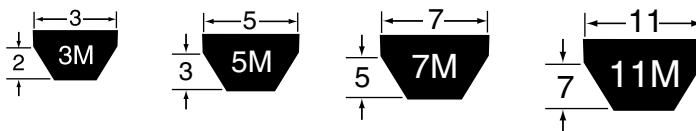

Width and height dimensions are in mm.

### 3M

Part Number	Weight* (Lbs.)	Effective Outside Length (mm)	Part Number	Weight* (Lbs.)	Effective Outside Length (mm)
3M180	0.003	180	3M375	0.006	375
3M185	0.003	185	3M387	0.006	387
3M190	0.003	190	3M400	0.006	400
3M195	0.003	195	3M412	0.006	412
3M200	0.003	200	3M425	0.007	425
3M206	0.003	206	3M437	0.007	437
3M212	0.003	212	3M450	0.007	450
3M218	0.003	218	3M462	0.007	462
3M224	0.003	224	3M475	0.008	475
3M230	0.004	230	3M487	0.008	487
3M236	0.004	236	3M500	0.008	500
3M243	0.004	243	3M515	0.008	515
3M250	0.004	250	3M530	0.009	530
3M258	0.004	258	3M545	0.009	545
3M265	0.004	265	3M560	0.009	560
3M272	0.004	272	3M580	0.010	580
3M280	0.004	280	3M600	0.010	600
3M290	0.004	290	3M615	0.010	615
3M300	0.004	300	3M630	0.011	630
3M307	0.004	307	3M650	0.011	650
3M315	0.005	315	3M670	0.011	670
3M325	0.005	325	3M690	0.012	690
3M335	0.005	335	3M710	0.012	710
3M345	0.005	345	3M730	0.013	730
3M355	0.005	355	3M750	0.013	750
3M365	0.005	365			

### 5M

Part Number	Weight* (Lbs.)	Effective Outside Length (mm)	Part Number	Weight* (Lbs.)	Effective Outside Length (mm)
5M280	0.016	280	5M670	0.026	670
5M290	0.016	290	5M690	0.027	690
5M300	0.017	300	5M710	0.028	710
5M307	0.017	307	5M730	0.028	730
5M315	0.017	315	5M750	0.029	750
5M325	0.017	325	5M775	0.029	775
5M335	0.017	335	5M800	0.030	800
5M345	0.018	345	5M805	0.030	805
5M355	0.018	355	5M825	0.030	825
5M365	0.018	365	5M850	0.031	850
5M375	0.018	375	5M875	0.031	875
5M387	0.018	387	5M900	0.032	900
5M400	0.019	400	5M925	0.033	925
5M412	0.019	412	5M950	0.034	950
5M425	0.019	425	5M975	0.034	975
5M437	0.020	437	5M1000	0.035	1000
5M450	0.020	450	5M1030	0.036	1030
5M462	0.020	462	5M1060	0.037	1060
5M475	0.020	475	5M1090	0.039	1090
5M487	0.021	487	5M1120	0.039	1120
5M500	0.021	500	5M1150	0.040	1150
5M515	0.021	515	5M1180	0.041	1180
5M518	0.021	518	5M1220	0.042	1220
5M530	0.022	530	5M1250	0.043	1250
5M545	0.023	545	5M1280	0.044	1280
5M560	0.023	560	5M1320	0.045	1320
5M580	0.024	580	5M1360	0.047	1360
5M600	0.024	600	5M1400	0.049	1400
5M615	0.025	615	5M1450	0.051	1450
5M630	0.025	630	5M1500	0.053	1500
5M650	0.025	650	5M1850	0.065	1850

\* Weights shown are approximate.





## 7M

Part Number	Weight* (Lbs.)	Effective Outside Length (mm)	Part Number	Weight* (Lbs.)	Effective Outside Length (mm)
7M450	0.028	450	7M1090	0.067	1090
7M500	0.031	500	7M1120	0.069	1120
7M515	0.032	515	7M1150	0.071	1150
7M535	0.033	535	7M1180	0.073	1180
7M545	0.034	545	7M1220	0.075	1220
7M560	0.035	560	7M1250	0.077	1250
7M580	0.036	580	7M1280	0.079	1280
7M600	0.037	600	7M1320	0.081	1320
7M615	0.038	615	7M1360	0.084	1360
7M630	0.039	630	7M1400	0.086	1400
7M650	0.040	650	7M1450	0.090	1450
7M670	0.042	670	7M1500	0.093	1500
7M690	0.043	690	7M1550	0.096	1550
7M710	0.044	710	7M1600	0.099	1600
7M730	0.045	730	7M1650	0.102	1650
7M750	0.046	750	7M1700	0.105	1700
7M775	0.048	775	7M1750	0.108	1750
7M800	0.049	800	7M1800	0.111	1800
7M825	0.051	825	7M1850	0.114	1850
7M850	0.052	850	7M1900	0.117	1900
7M875	0.054	875	7M1950	0.120	1950
7M900	0.056	900	7M2000	0.123	2000
7M925	0.057	925	7M2060	0.127	2060
7M950	0.059	950	7M2120	0.131	2120
7M975	0.060	975	7M2180	0.135	2180
7M1000	0.062	1000	7M2240	0.138	2240
7M1030	0.064	1030	7M2300	0.142	2300
7M1060	0.065	1060			

## 11M

Part Number	Weight* (Lbs.)	Effective Outside Length (mm)	Part Number	Weight* (Lbs.)	Effective Outside Length (mm)
11M710	0.086	710	11M1280	0.155	1280
11M730	0.089	730	11M1320	0.160	1320
11M750	0.091	750	11M1360	0.165	1360
11M775	0.094	775	11M1400	0.170	1400
11M800	0.097	800	11M1450	0.176	1450
11M825	0.100	825	11M1500	0.182	1500
11M850	0.103	850	11M1550	0.188	1550
11M875	0.106	875	11M1600	0.194	1600
11M900	0.109	900	11M1650	0.200	1650
11M925	0.112	925	11M1700	0.206	1700
11M950	0.115	950	11M1750	0.212	1750
11M975	0.118	975	11M1800	0.218	1800
11M1000	0.121	1000	11M1850	0.224	1850
11M1030	0.125	1030	11M1900	0.230	1900
11M1060	0.129	1060	11M1950	0.236	1950
11M1090	0.132	1090	11M2000	0.243	2000
11M1120	0.136	1120	11M2060	0.250	2060
11M1150	0.139	1150	11M2120	0.257	2120
11M1180	0.143	1180	11M2180	0.264	2180
11M1220	0.148	1220	11M2240	0.272	2240
11M1250	0.152	1250	11M2300	0.279	2300

\* Weights shown are approximate.

For intermediate sizes not shown, consult BANDO for availability and price.

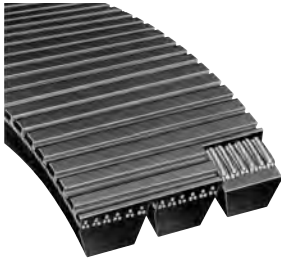

Belt Size	Top Width (mm)		H (mm)	E (mm)	L (mm)
	W2	W3			
5M	9.8	15.1	3.3	5.3	1.5
7M	15.6	24.1	5.3	8.5	2.8
11M	24.4	37.6	7.0	13.2	4.3

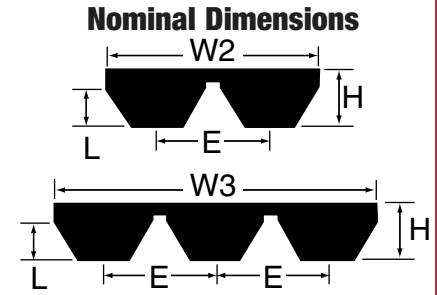

### 5MS (2 and 3 Rib)

Part Number	Weight* (Lbs.)	Effective Outside Length (mm)	Part Number	Weight* (Lbs.)	Effective Outside Length (mm)
<b>2 Rib</b>			<b>3 Rib</b>		
2-5MS280	0.020	280	3-5MS280	0.030	280
2-5MS290	0.020	290	3-5MS290	0.031	290
2-5MS300	0.021	300	3-5MS300	0.032	300
2-5MS307	0.022	307	3-5MS307	0.032	307
2-5MS325	0.023	325	3-5MS325	0.034	325
2-5MS335	0.024	335	3-5MS335	0.035	335
2-5MS345	0.024	345	3-5MS345	0.037	345
2-5MS355	0.025	355	3-5MS355	0.038	355
2-5MS365	0.026	365	3-5MS365	0.039	365
2-5MS375	0.026	375	3-5MS375	0.040	375
2-5MS387	0.027	387	3-5MS387	0.041	387
2-5MS400	0.028	400	3-5MS400	0.042	400
2-5MS412	0.029	412	3-5MS412	0.044	412
2-5MS425	0.030	425	3-5MS425	0.045	425
2-5MS437	0.031	437	3-5MS437	0.046	437
2-5MS450	0.032	450	3-5MS450	0.048	450
2-5MS462	0.033	462	3-5MS462	0.049	462
2-5MS475	0.034	475	3-5MS475	0.050	475
2-5MS487	0.034	487	3-5MS487	0.052	487
2-5MS500	0.035	500	3-5MS500	0.053	500
2-5MS515	0.036	515	3-5MS515	0.054	515
2-5MS530	0.037	530	3-5MS530	0.056	530
2-5MS545	0.038	545	3-5MS545	0.058	545
2-5MS560	0.040	560	3-5MS560	0.059	560
2-5MS580	0.041	580	3-5MS580	0.061	580
2-5MS600	0.042	600	3-5MS600	0.063	600
2-5MS615	0.043	615	3-5MS615	0.065	615
2-5MS630	0.044	630	3-5MS630	0.067	630
2-5MS650	0.046	650	3-5MS650	0.069	650
2-5MS660	0.047	660	3-5MS660	0.070	660
2-5MS670	0.047	670	3-5MS670	0.071	670
2-5MS690	0.049	690	3-5MS690	0.073	690
2-5MS710	0.050	710	3-5MS710	0.075	710
2-5MS730	0.051	730	3-5MS730	0.077	730
2-5MS750	0.053	750	3-5MS750	0.079	750
2-5MS775	0.055	775	3-5MS775	0.082	775
2-5MS800	0.056	800	3-5MS800	0.085	800
2-5MS825	0.058	825	3-5MS825	0.087	825
2-5MS850	0.060	850	3-5MS850	0.090	850
2-5MS875	0.062	875	3-5MS875	0.093	875
2-5MS900	0.063	900	3-5MS900	0.095	900
2-5MS925	0.065	925	3-5MS925	0.098	925
2-5MS950	0.067	950	3-5MS950	0.101	950
2-5MS975	0.069	975	3-5MS975	0.103	975
2-5MS1000	0.071	1000	3-5MS1000	0.106	1000
2-5MS1030	0.073	1030	3-5MS1030	0.109	1030
2-5MS1060	0.075	1060	3-5MS1060	0.112	1060
2-5MS1090	0.077	1090	3-5MS1090	0.115	1090
2-5MS1120	0.079	1120	3-5MS1120	0.119	1120
2-5MS1150	0.081	1150	3-5MS1150	0.122	1150
2-5MS1180	0.083	1180	3-5MS1180	0.125	1180
2-5MS1220	0.086	1220	3-5MS1220	0.129	1220
2-5MS1250	0.088	1250	3-5MS1250	0.132	1250
2-5MS1280	0.090	1280	3-5MS1280	0.135	1280
2-5MS1320	0.093	1320	3-5MS1320	0.140	1320
2-5MS1360	0.096	1360	3-5MS1360	0.144	1360
2-5MS1400	0.099	1400	3-5MS1400	0.148	1400
2-5MS1450	0.102	1450	3-5MS1450	0.153	1450
2-5MS1500	0.106	1500	3-5MS1500	0.159	1500
2-5MS1850	0.131	1850	3-5MS1850	0.196	1850

\* Weights shown are approximate.

For intermediate sizes not shown, consult BANDO for availability and price.

To find an authorized BANDO distributor, go to [www.bandousa.com](http://www.bandousa.com) or call 1-800-829-6612



### 7MS (2 and 3 Rib)

Part Number	Weight* (Lbs.)	Effective Outside Length (mm)	Part Number	Weight* (Lbs.)	Effective Outside Length (mm)
<b>2 Rib</b>			<b>3 Rib</b>		
2-7MS500	0.077	500	3-7MS500	0.116	500
2-7MS515	0.079	515	3-7MS515	0.119	515
2-7MS530	0.082	530	3-7MS530	0.123	530
2-7MS545	0.084	545	3-7MS545	0.126	545
2-7MS560	0.086	560	3-7MS560	0.130	560
2-7MS580	0.090	580	3-7MS580	0.134	580
2-7MS600	0.093	600	3-7MS600	0.139	600
2-7MS615	0.095	615	3-7MS615	0.142	615
2-7MS630	0.097	630	3-7MS630	0.146	630
2-7MS650	0.100	650	3-7MS650	0.150	650
2-7MS670	0.103	670	3-7MS670	0.155	670
2-7MS690	0.106	690	3-7MS690	0.160	690
2-7MS710	0.110	710	3-7MS710	0.164	710
2-7MS730	0.113	730	3-7MS730	0.169	730
2-7MS750	0.116	750	3-7MS750	0.174	750
2-7MS775	0.120	775	3-7MS775	0.179	775
2-7MS800	0.123	800	3-7MS800	0.185	800
2-7MS825	0.127	825	3-7MS825	0.191	825
2-7MS850	0.131	850	3-7MS850	0.197	850
2-7MS875	0.135	875	3-7MS875	0.203	875
2-7MS900	0.139	900	3-7MS900	0.208	900
2-7MS925	0.143	925	3-7MS925	0.214	925
2-7MS950	0.147	950	3-7MS950	0.220	950
2-7MS975	0.150	975	3-7MS975	0.226	975
2-7MS1000	0.154	1000	3-7MS1000	0.231	1000
2-7MS1030	0.159	1030	3-7MS1030	0.238	1030
2-7MS1060	0.164	1060	3-7MS1060	0.245	1060
2-7MS1090	0.168	1090	3-7MS1090	0.252	1090
2-7MS1120	0.173	1120	3-7MS1120	0.259	1120
2-7MS1150	0.177	1150	3-7MS1150	0.266	1150
2-7MS1180	0.182	1180	3-7MS1180	0.273	1180
2-7MS1220	0.188	1220	3-7MS1220	0.282	1220
2-7MS1250	0.193	1250	3-7MS1250	0.289	1250
2-7MS1280	0.198	1280	3-7MS1280	0.296	1280
2-7MS1320	0.204	1320	3-7MS1320	0.306	1320
2-7MS1360	0.210	1360	3-7MS1360	0.315	1360
2-7MS1400	0.216	1400	3-7MS1400	0.324	1400
2-7MS1450	0.224	1450	3-7MS1450	0.336	1450
2-7MS1500	0.231	1500	3-7MS1500	0.347	1500
2-7MS1550	0.239	1550	3-7MS1550	0.359	1550
2-7MS1600	0.247	1600	3-7MS1600	0.370	1600
2-7MS1650	0.255	1650	3-7MS1650	0.382	1650
2-7MS1700	0.262	1700	3-7MS1700	0.394	1700
2-7MS1750	0.270	1750	3-7MS1750	0.405	1750
2-7MS1800	0.278	1800	3-7MS1800	0.417	1800
2-7MS1850	0.285	1850	3-7MS1850	0.428	1850
2-7MS1900	0.293	1900	3-7MS1900	0.440	1900
2-7MS1950	0.301	1950	3-7MS1950	0.451	1950
2-7MS2000	0.309	2000	3-7MS2000	0.463	2000
2-7MS2060	0.318	2060	3-7MS2060	0.477	2060
2-7MS2120	0.327	2120	3-7MS2120	0.491	2120
2-7MS2180	0.336	2180	3-7MS2180	0.505	2180
2-7MS2240	0.346	2240	3-7MS2240	0.519	2240
2-7MS2300	0.355	2300	3-7MS2300	0.532	2300

\* Weights shown are approximate.

For intermediate sizes not shown, consult BANDO for availability and price.



### 11MS (2 Rib, 3 Rib and 4 Rib)

Part Number	Weight* (Lbs.)	Effective Outside Length (mm)	Part Number	Weight* (Lbs.)	Effective Outside Length (mm)
<b>2 Rib</b>			<b>3 Rib Continued</b>		
2-11MS710	0.235	710	3-11MS825	0.409	825
2-11MS730	0.241	730	3-11MS850	0.422	850
2-11MS750	0.248	750	3-11MS875	0.434	875
2-11MS775	0.256	775	3-11MS900	0.446	900
2-11MS800	0.265	800	3-11MS925	0.459	925
2-11MS825	0.273	825	3-11MS950	0.471	950
2-11MS850	0.281	850	3-11MS975	0.484	975
2-11MS875	0.289	875	3-11MS1000	0.496	1000
2-11MS900	0.298	900	3-11MS1030	0.511	1030
2-11MS925	0.306	925	3-11MS1060	0.526	1060
2-11MS950	0.314	950	3-11MS1090	0.541	1090
2-11MS975	0.322	975	3-11MS1120	0.556	1120
2-11MS1000	0.331	1000	3-11MS1150	0.570	1150
2-11MS1030	0.341	1030	3-11MS1180	0.585	1180
2-11MS1060	0.351	1060	3-11MS1220	0.605	1220
2-11MS1090	0.360	1090	3-11MS1250	0.620	1250
2-11MS1120	0.370	1120	3-11MS1280	0.635	1280
2-11MS1150	0.380	1150	3-11MS1320	0.655	1320
2-11MS1180	0.390	1180	3-11MS1360	0.675	1360
2-11MS1220	0.403	1220	3-11MS1400	0.694	1400
2-11MS1250	0.413	1250	3-11MS1450	0.719	1450
2-11MS1280	0.423	1280	3-11MS1500	0.744	1500
2-11MS1320	0.437	1320	3-11MS1550	0.769	1550
2-11MS1360	0.450	1360	3-11MS1600	0.794	1600
2-11MS1400	0.463	1400	3-11MS1650	0.818	1650
2-11MS1450	0.479	1450	3-11MS1700	0.843	1700
2-11MS1500	0.496	1500	3-11MS1750	0.868	1750
2-11MS1550	0.513	1550	3-11MS1800	0.893	1800
2-11MS1600	0.529	1600	3-11MS1850	0.918	1850
2-11MS1650	0.546	1650	3-11MS1900	0.942	1900
2-11MS1700	0.562	1700	3-11MS1950	0.967	1950
2-11MS1750	0.579	1750	3-11MS2000	0.992	2000
2-11MS1800	0.595	1800	3-11MS2060	1.022	2060
2-11MS1850	0.612	1850	3-11MS2120	1.052	2120
2-11MS1900	0.628	1900	3-11MS2180	1.081	2180
2-11MS1950	0.645	1950	3-11MS2240	1.111	2240
2-11MS2000	0.661	2000	3-11MS2300	1.141	2300
2-11MS2060	0.681	2060	<b>4 Rib</b>		
2-11MS2120	0.701	2120	4-11MS1450	0.958	1450
2-11MS2180	0.721	2180	4-11MS1800	1.190	1800
2-11MS2240	0.741	2240	4-11MS1850	1.224	1850
2-11MS2300	0.761	2300	4-11MS1950	1.290	1950
<b>3 Rib</b>			4-11MS2000	1.322	2000
3-11MS710	0.352	710	4-11MS2060	1.362	2060
3-11MS730	0.362	730	4-11MS2120	1.402	2120
3-11MS750	0.372	750	4-11MS2180	1.442	2180
3-11MS775	0.384	775	4-11MS2240	1.482	2240
3-11MS800	0.397	800			

\* Weights shown are approximate.

For intermediate sizes not shown, consult BANDO for availability and price.

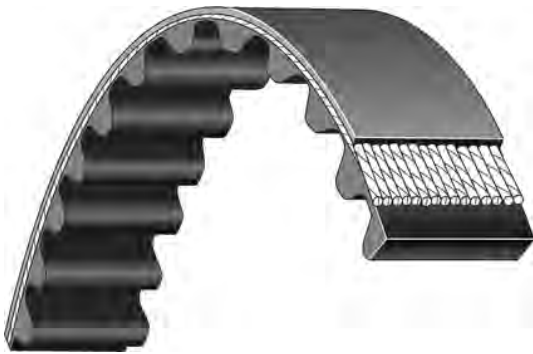

**Nominal Dimensions**

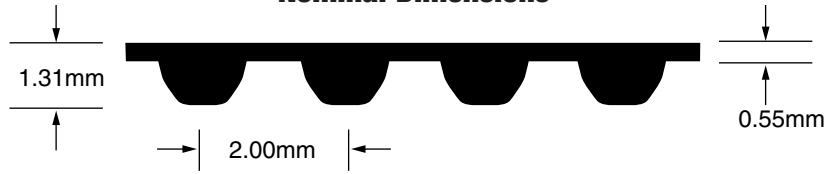

**Part Number Example**

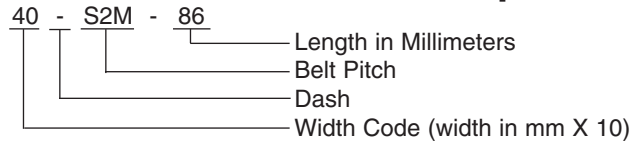

Part number includes the width code prefix in parenthesis below. For example, a 4mm wide S2M-86 is part number 40-S2M-86.

**STS2M for 4mm, 6mm and 10mm Wide Belts**

**Synchro-Link® STS Timing Belts - Neoprene (Metric)**

Part Number	4mm Wide (40)	6mm Wide (60)	10mm Wide (100)	Pitch Length (mm)	Number of Teeth
	Weight*	Weight*	Weight*		
S2M-86	0.001	0.001	0.002	86	43
S2M-88	0.001	0.001	0.002	88	44
S2M-90	0.001	0.001	0.002	90	45
S2M-92	0.001	0.001	0.002	92	46
S2M-98	0.001	0.001	0.002	98	49
S2M-100	0.001	0.001	0.002	100	50
S2M-102	0.001	0.001	0.002	102	51
S2M-108	0.001	0.001	0.002	108	54
S2M-112	0.001	0.001	0.002	112	56
S2M-114	0.001	0.001	0.002	114	57
S2M-116	0.001	0.001	0.002	116	58
S2M-118	0.001	0.001	0.002	118	59
S2M-120	0.001	0.001	0.002	120	60
S2M-122	0.001	0.001	0.002	122	61
S2M-124	0.001	0.001	0.002	124	62
S2M-126	0.001	0.002	0.003	126	63
S2M-128	0.001	0.002	0.003	128	64
S2M-130	0.001	0.002	0.003	130	65
S2M-132	0.001	0.002	0.003	132	66
S2M-134	0.001	0.002	0.003	134	67
S2M-138	0.001	0.002	0.003	138	69
S2M-140	0.001	0.002	0.003	140	70
S2M-142	0.001	0.002	0.003	142	71
S2M-144	0.001	0.002	0.003	144	72
S2M-148	0.001	0.002	0.003	148	74
S2M-150	0.001	0.002	0.003	150	75
S2M-152	0.001	0.002	0.003	152	76
S2M-158	0.001	0.002	0.003	158	79
S2M-160	0.001	0.002	0.003	160	80
S2M-162	0.001	0.002	0.003	162	81
S2M-164	0.001	0.002	0.003	164	82
S2M-166	0.001	0.002	0.003	166	83
S2M-168	0.001	0.002	0.003	168	84
S2M-170	0.001	0.002	0.003	170	85
S2M-172	0.001	0.002	0.003	172	86
S2M-174	0.001	0.002	0.003	174	87
S2M-176	0.001	0.002	0.003	176	88
S2M-180	0.001	0.002	0.004	180	90
S2M-184	0.001	0.002	0.004	184	92
S2M-186	0.001	0.002	0.004	186	93
S2M-190	0.002	0.002	0.004	190	95
S2M-192	0.002	0.002	0.004	192	96
S2M-198	0.002	0.002	0.004	198	99
S2M-200	0.002	0.002	0.004	200	100
S2M-202	0.002	0.002	0.004	202	101
S2M-204	0.002	0.002	0.004	204	102
S2M-210	0.002	0.003	0.004	210	105
S2M-212	0.002	0.003	0.004	212	106

\* Weights shown are approximate.

Other widths available. Contact BANDO for price and delivery.



## STS2M for 4mm, 6mm and 10mm Wide Belts (Continued)

Part Number	4mm Wide (40)	6mm Wide (60)	10mm Wide (100)	Pitch Length (mm)	Number of Teeth
	Weight*	Weight*	Weight*		
S2M-214	0.002	0.003	0.004	214	107
S2M-216	0.002	0.003	0.004	216	108
S2M-220	0.002	0.003	0.004	220	110
S2M-222	0.002	0.003	0.004	222	111
S2M-224	0.002	0.003	0.004	224	112
S2M-230	0.002	0.003	0.005	230	115
S2M-234	0.002	0.003	0.005	234	117
S2M-236	0.002	0.003	0.005	236	118
S2M-240	0.002	0.003	0.005	240	120
S2M-242	0.002	0.003	0.005	242	121
S2M-244	0.002	0.003	0.005	244	122
S2M-248	0.002	0.003	0.005	248	124
S2M-250	0.002	0.003	0.005	250	125
S2M-254	0.002	0.003	0.005	254	127
S2M-256	0.002	0.003	0.005	256	128
S2M-260	0.002	0.003	0.005	260	130
S2M-262	0.002	0.003	0.005	262	131
S2M-266	0.002	0.003	0.005	266	133
S2M-272	0.002	0.003	0.005	272	136
S2M-274	0.002	0.003	0.005	274	137
S2M-280	0.002	0.003	0.006	280	140
S2M-284	0.002	0.003	0.006	284	142
S2M-288	0.002	0.003	0.006	288	144
S2M-290	0.002	0.003	0.006	290	145
S2M-292	0.002	0.003	0.006	292	146
S2M-296	0.002	0.004	0.006	296	148
S2M-300	0.002	0.004	0.006	300	150
S2M-308	0.002	0.004	0.006	308	154
S2M-310	0.002	0.004	0.006	310	155
S2M-312	0.002	0.004	0.006	312	156
S2M-314	0.002	0.004	0.006	314	157
S2M-316	0.003	0.004	0.006	316	158
S2M-320	0.003	0.004	0.006	320	160
S2M-322	0.003	0.004	0.006	322	161
S2M-324	0.003	0.004	0.006	324	162
S2M-328	0.003	0.004	0.007	328	164
S2M-330	0.003	0.004	0.007	330	165
S2M-332	0.003	0.004	0.007	332	166
S2M-340	0.003	0.004	0.007	340	170
S2M-342	0.003	0.004	0.007	342	171
S2M-344	0.003	0.004	0.007	344	172
S2M-350	0.003	0.004	0.007	350	175
S2M-364	0.003	0.004	0.007	364	182
S2M-370	0.003	0.004	0.007	370	185
S2M-372	0.003	0.004	0.007	372	186
S2M-376	0.003	0.004	0.007	376	188
S2M-380	0.003	0.005	0.008	380	190
S2M-386	0.003	0.005	0.008	386	193
S2M-396	0.003	0.005	0.008	396	198
S2M-400	0.003	0.005	0.008	400	200
S2M-406	0.003	0.005	0.008	406	203
S2M-408	0.003	0.005	0.008	408	204
S2M-416	0.003	0.005	0.008	416	208
S2M-420	0.003	0.005	0.008	420	210
S2M-426	0.003	0.005	0.008	426	213
S2M-438	0.003	0.005	0.009	438	219
S2M-448	0.004	0.005	0.009	448	224
S2M-452	0.004	0.005	0.009	452	226
S2M-454	0.004	0.005	0.009	454	227
S2M-460	0.004	0.005	0.009	460	230
S2M-468	0.004	0.006	0.009	468	234
S2M-474	0.004	0.006	0.009	474	237
S2M-486	0.004	0.006	0.010	486	243
S2M-490	0.004	0.006	0.010	490	245
S2M-494	0.004	0.006	0.010	494	247
S2M-500	0.004	0.006	0.010	500	250
S2M-520	0.004	0.006	0.010	520	260
S2M-530	0.004	0.006	0.011	530	265
S2M-540	0.004	0.006	0.011	540	270
S2M-550	0.004	0.007	0.011	550	275

Synchro-Link® STS Timing Belts - Neoprene (Metric)

\* Weights shown are approximate.

Other widths available. Contact BANDO for price and delivery.



### STS2M for 4mm, 6mm and 10mm Wide Belts (Continued)

Part Number	4mm Wide (40)	6mm Wide (60)	10mm Wide (100)	Pitch Length (mm)	Number of Teeth
	Weight*	Weight*	Weight*		
S2M-558	0.004	0.007	0.011	558	279
S2M-560	0.004	0.007	0.011	560	280
S2M-572	0.005	0.007	0.011	572	286
S2M-594	0.005	0.007	0.012	594	297
S2M-596	0.005	0.007	0.012	596	298
S2M-600	0.005	0.007	0.012	600	300
S2M-620	0.005	0.007	0.012	620	310
S2M-630	0.005	0.008	0.013	630	315
S2M-650	0.005	0.008	0.013	650	325
S2M-652	0.005	0.008	0.013	652	326
S2M-656	0.005	0.008	0.013	656	328
S2M-668	0.005	0.008	0.013	668	334
S2M-676	0.005	0.008	0.013	676	338
S2M-700	0.006	0.008	0.014	700	350
S2M-710	0.006	0.008	0.014	710	355
S2M-742	0.006	0.009	0.015	742	371
S2M-752	0.006	0.009	0.015	752	376
S2M-754	0.006	0.009	0.015	754	377
S2M-766	0.006	0.009	0.015	766	383
S2M-796	0.006	0.009	0.016	796	398
S2M-800	0.006	0.010	0.016	800	400
S2M-810	0.006	0.010	0.016	810	405
S2M-898	0.007	0.011	0.018	898	449
S2M-900	0.007	0.011	0.018	900	450
S2M-940	0.007	0.011	0.019	940	470
S2M-946	0.008	0.011	0.019	946	473
S2M-950	0.008	0.011	0.019	950	475
S2M-984	0.008	0.012	0.020	984	492
S2M-1000	0.008	0.012	0.020	1000	500
S2M-1032	0.008	0.012	0.021	1032	516
S2M-1036	0.008	0.012	0.021	1036	518
S2M-1066	0.008	0.013	0.021	1066	533
S2M-1074	0.009	0.013	0.021	1074	537
S2M-1100	0.009	0.013	0.022	1100	550
S2M-1110	0.009	0.013	0.022	1110	555
S2M-1136	0.009	0.014	0.023	1136	568
S2M-1154	0.009	0.014	0.023	1154	577
S2M-1166	0.009	0.014	0.023	1166	583
S2M-1224	0.010	0.015	0.024	1224	612
S2M-1228	0.010	0.015	0.024	1228	614

Synchro-Link® STS Timing Belts - Neoprene (Metric)

\* Weights shown are approximate.

Other widths available. Contact BANDO for price and delivery.

### NOTE

S2M Synchro-Link® STS size available in *polyurethane* construction for specialty applications. Consult BANDO for price and availability.



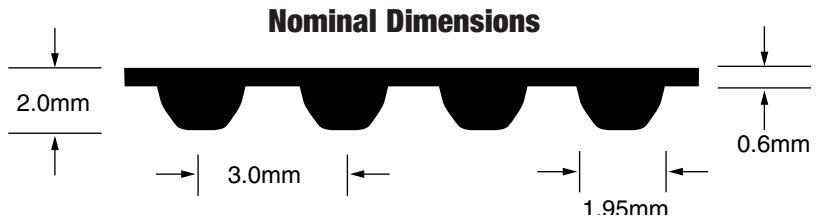
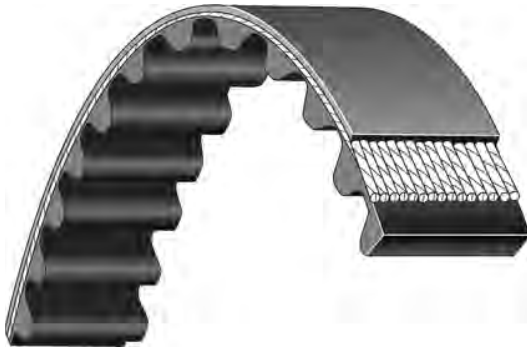

**Part Number Example**

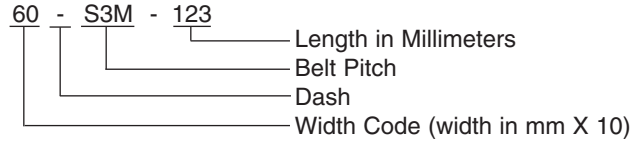

Part number includes the width code prefix in parenthesis below. For example, a 6mm wide S3M-123 is part number 60-S3M-123.

**STS3M for 6mm, 10mm and 15mm Wide Belts**

Part Number	6mm Wide (60)	10mm Wide (100)	15mm Wide (150)	Pitch Length (mm)	Number of Teeth
	Weight*	Weight*	Weight*		
S3M-123	0.003	0.004	0.006	123	41
S3M-129	0.003	0.005	0.007	129	43
S3M-144	0.003	0.005	0.008	144	48
S3M-150	0.003	0.005	0.008	150	50
S3M-156	0.003	0.005	0.008	156	52
S3M-159	0.003	0.006	0.008	159	53
S3M-162	0.003	0.006	0.008	162	54
S3M-168	0.004	0.006	0.009	168	56
S3M-171	0.004	0.006	0.009	171	57
S3M-174	0.004	0.006	0.009	174	58
S3M-177	0.004	0.006	0.009	177	59
S3M-180	0.004	0.006	0.009	180	60
S3M-186	0.004	0.006	0.010	186	62
S3M-189	0.004	0.007	0.010	189	63
S3M-192	0.004	0.007	0.010	192	64
S3M-198	0.004	0.007	0.010	198	66
S3M-201	0.004	0.007	0.011	201	67
S3M-204	0.004	0.007	0.011	204	68
S3M-207	0.004	0.007	0.011	207	69
S3M-210	0.004	0.007	0.011	210	70
S3M-213	0.004	0.007	0.011	213	71
S3M-219	0.005	0.008	0.011	219	73
S3M-222	0.005	0.008	0.012	222	74
S3M-225	0.005	0.008	0.012	225	75
S3M-228	0.005	0.008	0.012	228	76
S3M-234	0.005	0.008	0.012	234	78
S3M-237	0.005	0.008	0.012	237	79
S3M-240	0.005	0.008	0.013	240	80
S3M-243	0.005	0.008	0.013	243	81
S3M-246	0.005	0.009	0.013	246	82
S3M-249	0.005	0.009	0.013	249	83
S3M-252	0.005	0.009	0.013	252	84
S3M-255	0.005	0.009	0.013	255	85
S3M-258	0.005	0.009	0.014	258	86
S3M-264	0.006	0.009	0.014	264	88
S3M-267	0.006	0.009	0.014	267	89
S3M-270	0.006	0.009	0.014	270	90
S3M-273	0.006	0.010	0.014	273	91
S3M-276	0.006	0.010	0.014	276	92
S3M-279	0.006	0.010	0.015	279	93
S3M-285	0.006	0.010	0.015	285	95
S3M-288	0.006	0.010	0.015	288	96
S3M-291	0.006	0.010	0.015	291	97
S3M-297	0.006	0.010	0.016	297	99
S3M-300	0.006	0.010	0.016	300	100

Synchro-Link® STS Timing Belts - Neoprene (Metric)

\* Weights shown are approximate.

Other widths available. Contact BANDO for price and delivery.



### STS3M for 6mm, 10mm and 15mm Wide Belts (Continued)

Synchro-Link® STS Timing Belts - Neoprene (Metric)

Part Number	6mm Wide (60)	10mm Wide (100)	15mm Wide (150)	Pitch Length (mm)	Number of Teeth
	Weight*	Weight*	Weight*		
S3M-303	0.006	0.011	0.016	303	101
S3M-309	0.006	0.011	0.016	309	103
S3M-312	0.007	0.011	0.016	312	104
S3M-315	0.007	0.011	0.017	315	105
S3M-318	0.007	0.011	0.017	318	106
S3M-324	0.007	0.011	0.017	324	108
S3M-327	0.007	0.011	0.017	327	109
S3M-330	0.007	0.012	0.017	330	110
S3M-339	0.007	0.012	0.018	339	113
S3M-342	0.007	0.012	0.018	342	114
S3M-351	0.007	0.012	0.018	351	117
S3M-354	0.007	0.012	0.019	354	118
S3M-360	0.008	0.013	0.019	360	120
S3M-363	0.008	0.013	0.019	363	121
S3M-366	0.008	0.013	0.019	366	122
S3M-369	0.008	0.013	0.019	369	123
S3M-372	0.008	0.013	0.019	372	124
S3M-375	0.008	0.013	0.020	375	125
S3M-378	0.008	0.013	0.020	378	126
S3M-384	0.008	0.013	0.020	384	128
S3M-387	0.008	0.014	0.020	387	129
S3M-390	0.008	0.014	0.020	390	130
S3M-399	0.008	0.014	0.021	399	133
S3M-402	0.008	0.014	0.021	402	134
S3M-405	0.008	0.014	0.021	405	135
S3M-408	0.009	0.014	0.021	408	136
S3M-417	0.009	0.015	0.022	417	139
S3M-420	0.009	0.015	0.022	420	140
S3M-423	0.009	0.015	0.022	423	141
S3M-426	0.009	0.015	0.022	426	142
S3M-432	0.009	0.015	0.023	432	144
S3M-438	0.009	0.015	0.023	438	146
S3M-444	0.009	0.016	0.023	444	148
S3M-447	0.009	0.016	0.023	447	149
S3M-453	0.009	0.016	0.024	453	151
S3M-459	0.010	0.016	0.024	459	153
S3M-468	0.010	0.016	0.025	468	156
S3M-471	0.010	0.016	0.025	471	157
S3M-480	0.010	0.017	0.025	480	160
S3M-486	0.010	0.017	0.025	486	162
S3M-489	0.010	0.017	0.026	489	163
S3M-492	0.010	0.017	0.026	492	164
S3M-501	0.011	0.018	0.026	501	167
S3M-507	0.011	0.018	0.027	507	169
S3M-516	0.011	0.018	0.027	516	172
S3M-519	0.011	0.018	0.027	519	173
S3M-522	0.011	0.018	0.027	522	174
S3M-525	0.011	0.018	0.028	525	175
S3M-534	0.011	0.019	0.028	534	178
S3M-537	0.011	0.019	0.028	537	179
S3M-540	0.011	0.019	0.028	540	180
S3M-549	0.012	0.019	0.029	549	183
S3M-552	0.012	0.019	0.029	552	184
S3M-555	0.012	0.019	0.029	555	185
S3M-564	0.012	0.020	0.030	564	188
S3M-573	0.012	0.020	0.030	573	191
S3M-579	0.012	0.020	0.030	579	193
S3M-588	0.012	0.021	0.031	588	196
S3M-597	0.013	0.021	0.031	597	199
S3M-600	0.013	0.021	0.031	600	200
S3M-609	0.013	0.021	0.032	609	203
S3M-621	0.013	0.022	0.033	621	207
S3M-633	0.013	0.022	0.033	633	211
S3M-648	0.014	0.023	0.034	648	216
S3M-657	0.014	0.023	0.034	657	219

\* Weights shown are approximate.

Other widths available. Contact BANDO for price and delivery.



### STS3M for 6mm, 10mm and 15mm Wide Belts (Continued)

Part Number	6mm Wide (60)	10mm Wide (100)	15mm Wide (150)	Pitch Length (mm)	Number of Teeth
	Weight*	Weight*	Weight*		
S3M-660	0.014	0.023	0.035	660	220
S3M-666	0.014	0.023	0.035	666	222
S3M-681	0.014	0.024	0.036	681	227
S3M-690	0.014	0.024	0.036	690	230
S3M-699	0.015	0.024	0.037	699	233
S3M-726	0.015	0.025	0.038	726	242
S3M-735	0.015	0.026	0.039	735	245
S3M-741	0.016	0.026	0.039	741	247
S3M-750	0.016	0.026	0.039	750	250
S3M-768	0.016	0.027	0.040	768	256
S3M-771	0.016	0.027	0.040	771	257
S3M-789	0.017	0.028	0.041	789	263
S3M-804	0.017	0.028	0.042	804	268
S3M-810	0.017	0.028	0.042	810	270
S3M-825	0.017	0.029	0.043	825	275
S3M-852	0.018	0.030	0.045	852	284
S3M-882	0.018	0.031	0.046	882	294
S3M-885	0.019	0.031	0.046	885	295
S3M-888	0.019	0.031	0.047	888	296
S3M-900	0.019	0.031	0.047	900	300
S3M-918	0.019	0.032	0.048	918	306
S3M-927	0.019	0.032	0.049	927	309
S3M-936	0.020	0.033	0.049	936	312
S3M-990	0.021	0.035	0.052	990	330
S3M-1119	0.023	0.039	0.059	1119	373
S3M-1134	0.024	0.040	0.059	1134	378
S3M-1146	0.024	0.040	0.060	1146	382
S3M-1188	0.025	0.042	0.062	1188	396
S3M-1299	0.027	0.045	0.068	1299	433
S3M-1419	0.030	0.050	0.074	1419	473
S3M-1530	0.032	0.053	0.080	1530	510

\* Weights shown are approximate.

Other widths available. Contact BANDO for price and delivery.

### NOTE

S3M Synchro-Link® STS size available in *polyurethane* construction for specialty applications. Consult BANDO for price and availability.

Synchro-Link® STS Timing Belts - Neoprene (Metric)

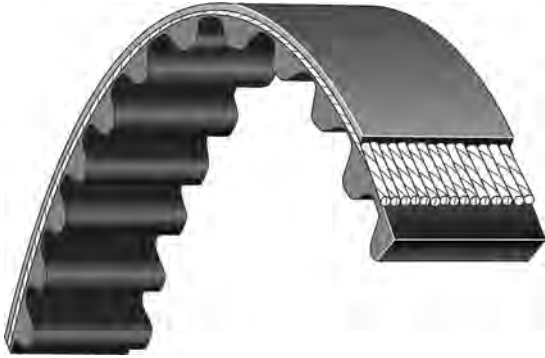

**Nominal Dimensions**

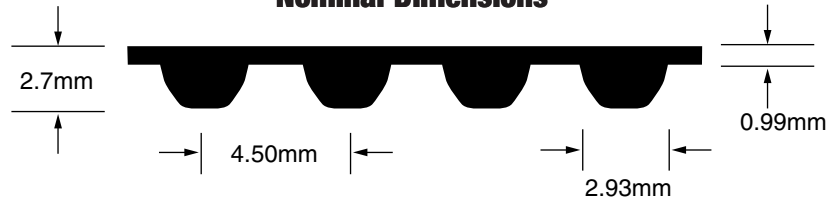

**Part Number Example**

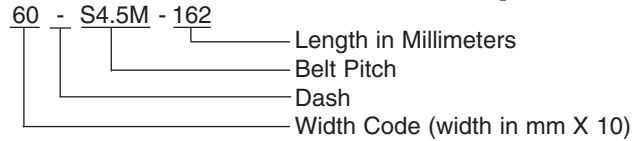

Part number includes the width code prefix in parenthesis below. For example, a 6mm wide S4.5M-162 is part number 60-S4.5M-162.

**Synchro-Link® STS Timing Belts - Neoprene (Metric)**

**STS4.5M for 6mm, 10mm and 15mm Wide Belts**

Part Number	6mm Wide (60)	10mm Wide (100)	15mm Wide (150)	Pitch Length (mm)	Number of Teeth
	Weight*	Weight*	Weight*		
S4.5M-162	0.007	0.011	0.017	162	36
S4.5M-180	0.008	0.013	0.019	180	40
S4.5M-198	0.008	0.014	0.021	198	44
S4.5M-225	0.009	0.016	0.024	225	50
S4.5M-239	0.010	0.017	0.025	239	53
S4.5M-252	0.011	0.018	0.026	252	56
S4.5M-279	0.012	0.019	0.029	279	62
S4.5M-284	0.012	0.020	0.030	284	63
S4.5M-315	0.013	0.022	0.033	315	70
S4.5M-324	0.014	0.023	0.034	324	72
S4.5M-351	0.015	0.025	0.037	351	78
S4.5M-383	0.016	0.027	0.040	383	85
S4.5M-396	0.017	0.028	0.042	396	88
S4.5M-450	0.019	0.031	0.047	450	100
S4.5M-491	0.021	0.034	0.051	491	109
S4.5M-504	0.021	0.035	0.053	504	112
S4.5M-518	0.022	0.036	0.054	518	115
S4.5M-558	0.023	0.039	0.058	558	124
S4.5M-563	0.024	0.039	0.059	563	125
S4.5M-612	0.025	0.042	0.063	612	136
S4.5M-630	0.026	0.044	0.066	630	140
S4.5M-711	0.030	0.050	0.075	711	158
S4.5M-729	0.031	0.051	0.076	729	162
S4.5M-801	0.034	0.056	0.084	801	178
S4.5M-1031	0.037	0.061	0.092	1,031	229
S4.5M-2111	0.040	0.066	0.100	2,111	469

\* Weights shown are approximate.

Other widths available. Contact BANDO for price and delivery.



### Nominal Dimensions

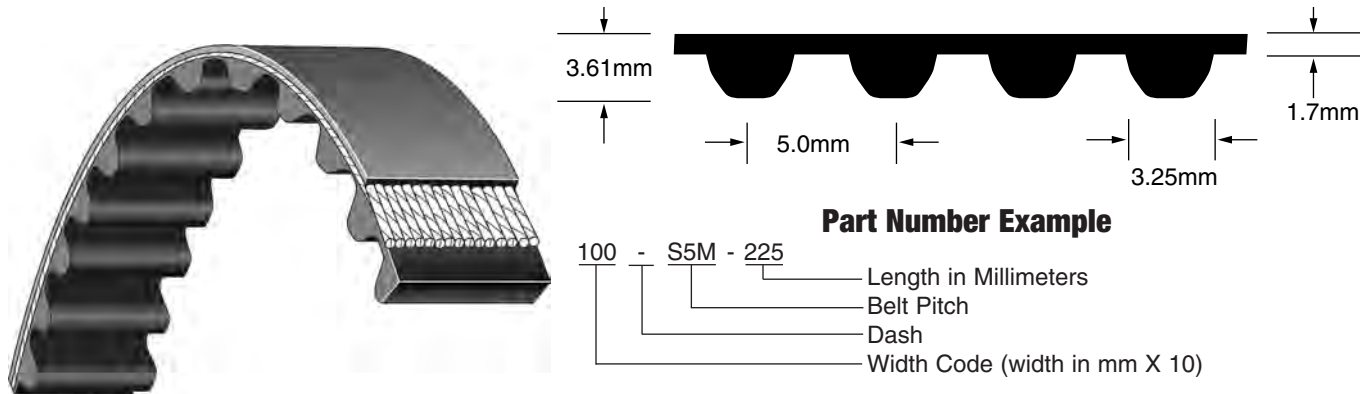

Part number includes the width code prefix in parenthesis below. For example, a 10mm wide S5M-225 is part number 100-S5M-225.

### STS5M for 10mm, 15mm, 20mm and 25mm Wide Belts

Part Number	10mm Wide (100)	15mm Wide (150)	20mm Wide (200)	25mm Wide (250)	Pitch Length (mm)	Number of Teeth
	Weight*	Weight*	Weight*	Weight*		
S5M-225	0.019	0.028	0.038	0.038	225	45
S5M-230	0.019	0.029	0.039	0.039	230	46
S5M-255	0.021	0.032	0.043	0.043	255	51
S5M-275	0.023	0.035	0.046	0.046	275	55
S5M-295	0.025	0.037	0.050	0.050	295	59
S5M-300	0.025	0.038	0.051	0.051	300	60
S5M-320	0.027	0.040	0.054	0.054	320	64
S5M-325	0.027	0.041	0.055	0.055	325	65
S5M-350	0.029	0.044	0.059	0.059	350	70
S5M-375	0.032	0.047	0.063	0.063	375	75
S5M-380	0.032	0.048	0.064	0.064	380	76
S5M-390	0.033	0.049	0.066	0.066	390	78
S5M-400	0.034	0.051	0.067	0.067	400	80
S5M-410	0.035	0.052	0.069	0.069	410	82
S5M-420	0.036	0.053	0.070	0.070	420	84
S5M-425	0.036	0.054	0.072	0.072	425	85
S5M-435	0.037	0.055	0.073	0.073	435	87
S5M-440	0.037	0.056	0.074	0.074	440	88
S5M-445	0.037	0.056	0.075	0.075	445	89
S5M-450	0.038	0.057	0.076	0.076	450	90
S5M-475	0.040	0.060	0.080	0.080	475	95
S5M-490	0.041	0.062	0.083	0.083	490	98
S5M-500	0.043	0.064	0.085	0.085	500	100
S5M-520	0.044	0.066	0.088	0.088	520	104
S5M-525	0.045	0.068	0.091	0.091	525	105
S5M-550	0.046	0.070	0.093	0.093	550	110
S5M-560	0.047	0.071	0.094	0.094	560	112
S5M-565	0.048	0.071	0.095	0.095	565	113
S5M-570	0.048	0.072	0.096	0.096	570	114
S5M-575	0.048	0.073	0.097	0.097	575	115
S5M-600	0.051	0.076	0.101	0.101	600	120
S5M-625	0.053	0.079	0.105	0.105	625	125
S5M-635	0.054	0.080	0.107	0.107	635	127
S5M-645	0.054	0.082	0.109	0.109	645	129
S5M-650	0.055	0.082	0.110	0.110	650	130

\* Weights shown are approximate.

Other widths available. Contact BANDO for price and delivery.

Synchro-Link® STS Timing Belts - Neoprene (Metric)



## STS5M for 10mm, 15mm, 20mm and 25mm Wide Belts (Continued)

Part Number	10mm Wide (100)	15mm Wide (150)	20mm Wide (200)	25mm Wide (250)	Pitch Length (mm)	Number of Teeth
	Weight*	Weight*	Weight*	Weight*		
S5M-665	0.056	0.084	0.112	0.112	665	133
S5M-670	0.056	0.085	0.113	0.113	670	134
S5M-675	0.057	0.085	0.114	0.114	675	135
S5M-695	0.059	0.088	0.117	0.117	695	139
S5M-700	0.059	0.088	0.118	0.118	700	140
S5M-710	0.060	0.090	0.120	0.120	710	142
S5M-725	0.061	0.092	0.122	0.122	725	145
S5M-740	0.062	0.094	0.124	0.124	740	148
S5M-750	0.063	0.095	0.126	0.126	750	150
S5M-765	0.064	0.097	0.129	0.129	765	153
S5M-770	0.065	0.097	0.130	0.130	770	154
S5M-775	0.065	0.098	0.131	0.131	775	155
S5M-800	0.067	0.101	0.135	0.135	800	160
S5M-810	0.068	0.102	0.137	0.137	810	162
S5M-830	0.070	0.105	0.140	0.140	830	166
S5M-850	0.072	0.107	0.143	0.143	850	170
S5M-860	0.072	0.109	0.145	0.145	860	172
S5M-870	0.073	0.110	0.147	0.147	870	174
S5M-900	0.076	0.114	0.152	0.152	900	180
S5M-920	0.078	0.116	0.155	0.155	920	184
S5M-940	0.079	0.119	0.158	0.158	940	188
S5M-950	0.080	0.120	0.160	0.160	950	190
S5M-965	0.080	0.121	0.161	0.161	965	193
S5M-975	0.082	0.123	0.164	0.164	975	195
S5M-1000	0.084	0.126	0.169	0.169	1000	200
S5M-1025	0.086	0.130	0.173	0.173	1025	205
S5M-1050	0.088	0.133	0.177	0.177	1050	210
S5M-1125	0.095	0.142	0.190	0.190	1125	225
S5M-1135	0.096	0.143	0.191	0.191	1135	227
S5M-1145	0.096	0.145	0.193	0.193	1145	229
S5M-1195	0.101	0.151	0.201	0.201	1195	239
S5M-1225	0.103	0.155	0.206	0.206	1225	245
S5M-1250	0.105	0.158	0.211	0.211	1250	250
S5M-1260	0.106	0.159	0.212	0.212	1260	252
S5M-1270	0.107	0.161	0.214	0.214	1270	254
S5M-1295	0.109	0.164	0.218	0.218	1295	259
S5M-1350	0.114	0.171	0.228	0.228	1350	270
S5M-1420	0.120	0.179	0.239	0.239	1420	284
S5M-1595	0.134	0.202	0.269	0.269	1595	319
S5M-1715	0.145	0.217	0.289	0.289	1715	343
S5M-1800	0.152	0.228	0.303	0.303	1800	360
S5M-2000	0.169	0.253	0.337	0.337	2000	400

Synchro-Link® STS Timing Belts - Neoprene (Metric)

\* Weights shown are approximate.

Other widths available. Contact BANDO for price and delivery.

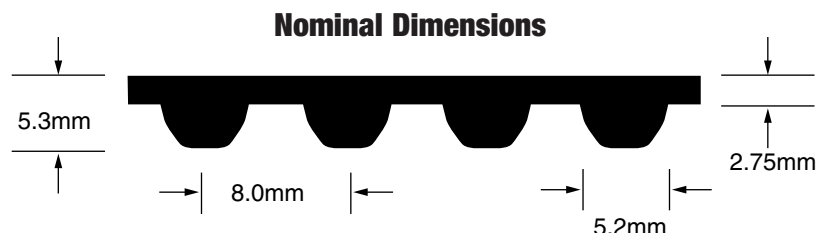
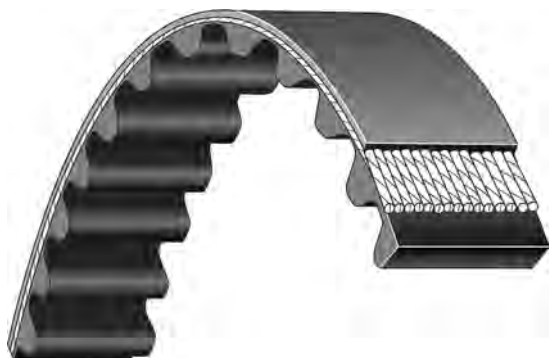

**Part Number Example**

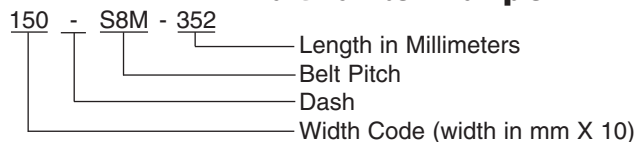

Part number includes the width code prefix in parenthesis below. For example, a 15mm wide S8M-352 is part number 150-S8M-352.

**STS8M for 15mm, 25mm, 40mm and 60mm Wide Belts**

Part Number	15mm Wide (150)	25mm Wide (250)	40mm Wide (400)	60mm Wide (600)	Pitch Length (mm)	Number of Teeth
	Weight*	Weight*	Weight*	Weight*		
S8M-352	0.063	0.106	0.170	0.256	352	44
S8M-384	0.069	0.115	0.186	0.279	384	48
S8M-408	0.073	0.122	0.197	0.296	408	51
S8M-424	0.076	0.127	0.205	0.308	424	53
S8M-456	0.082	0.137	0.221	0.331	456	57
S8M-480	0.087	0.145	0.232	0.348	480	60
S8M-520	0.094	0.157	0.251	0.377	520	65
S8M-528	0.095	0.160	0.256	0.383	528	66
S8M-560	0.101	0.169	0.271	0.406	560	70
S8M-584	0.106	0.176	0.282	0.423	584	73
S8M-600	0.109	0.181	0.290	0.435	600	75
S8M-632	0.115	0.191	0.305	0.458	632	79
S8M-640	0.116	0.193	0.309	0.464	640	80
S8M-656	0.118	0.197	0.318	0.476	656	82
S8M-672	0.121	0.202	0.325	0.488	672	84
S8M-680	0.123	0.205	0.329	0.493	680	85
S8M-712	0.129	0.215	0.344	0.516	712	89
S8M-720	0.130	0.217	0.348	0.522	720	90
S8M-728	0.132	0.220	0.352	0.528	728	91
S8M-760	0.138	0.230	0.367	0.551	760	95
S8M-800	0.145	0.242	0.387	0.580	800	100
S8M-824	0.148	0.247	0.399	0.598	824	103
S8M-840	0.152	0.254	0.406	0.609	840	105
S8M-848	0.154	0.256	0.410	0.615	848	106
S8M-880	0.159	0.266	0.425	0.638	880	110
S8M-888	0.161	0.268	0.429	0.644	888	111
S8M-896	0.162	0.271	0.433	0.649	896	112
S8M-920	0.167	0.278	0.445	0.667	920	115
S8M-944	0.171	0.285	0.456	0.684	944	118
S8M-960	0.174	0.290	0.464	0.696	960	120
S8M-976	0.176	0.293	0.472	0.709	976	122
S8M-984	0.178	0.297	0.475	0.713	984	123
S8M-1000	0.181	0.302	0.483	0.725	1000	125
S8M-1032	0.187	0.312	0.499	0.748	1032	129
S8M-1040	0.188	0.314	0.503	0.754	1040	130
S8M-1056	0.191	0.319	0.510	0.765	1056	132
S8M-1096	0.199	0.331	0.530	0.794	1096	137
S8M-1120	0.203	0.338	0.541	0.812	1120	140
S8M-1136	0.206	0.343	0.549	0.823	1136	142
S8M-1152	0.209	0.348	0.557	0.835	1152	144
S8M-1160	0.209	0.351	0.561	0.842	1160	145
S8M-1184	0.215	0.358	0.572	0.858	1184	148
S8M-1192	0.216	0.360	0.576	0.864	1192	149
S8M-1200	0.217	0.362	0.580	0.870	1200	150
S8M-1216	0.220	0.367	0.588	0.881	1216	152

**Synchro-Link® STS Timing Belts - Neoprene (Metric)**

\* Weights shown are approximate.

Other widths available. Contact BANDO for price and delivery.





## STS8M for 15mm, 25mm, 40mm and 60mm Wide Belts (Continued)

Part Number	15mm Wide (150)	25mm Wide (250)	40mm Wide (400)	60mm Wide (600)	Pitch Length (mm)	Number of Teeth
	Weight*	Weight*	Weight*	Weight*		
S8M-1224	0.222	0.370	0.591	0.887	1224	153
S8M-1240	0.225	0.374	0.599	0.899	1240	155
S8M-1248	0.226	0.377	0.603	0.905	1248	156
S8M-1272	0.229	0.385	0.616	0.923	1272	159
S8M-1280	0.232	0.387	0.618	0.928	1280	160
S8M-1296	0.235	0.391	0.626	0.939	1296	162
S8M-1312	0.239	0.399	0.638	0.957	1312	164
S8M-1344	0.244	0.406	0.649	0.974	1344	168
S8M-1352	0.245	0.408	0.653	0.980	1352	169
S8M-1384	0.251	0.418	0.669	1.003	1384	173
S8M-1392	0.252	0.420	0.673	1.009	1392	174
S8M-1400	0.254	0.423	0.676	1.015	1400	175
S8M-1424	0.258	0.430	0.688	1.032	1424	178
S8M-1440	0.261	0.435	0.696	1.044	1440	180
S8M-1480	0.266	0.448	0.716	1.074	1480	185
S8M-1520	0.274	0.460	0.736	1.104	1520	190
S8M-1552	0.279	0.469	0.751	1.127	1552	194
S8M-1600	0.301	0.501	0.802	1.203	1600	200
S8M-1728	0.313	0.522	0.835	1.252	1728	216
S8M-1760	0.319	0.532	0.850	1.276	1760	220
S8M-1776	0.322	0.536	0.858	1.287	1776	222
S8M-1800	0.326	0.544	0.870	1.305	1800	225
S8M-1808	0.331	0.547	0.875	1.313	1808	226
S8M-1880	0.338	0.569	0.910	1.365	1880	235
S8M-1952	0.351	0.590	0.945	1.417	1952	244
S8M-2000	0.362	0.604	0.966	1.450	2000	250
S8M-2120	0.384	0.640	1.024	1.537	2120	265
S8M-2160	0.391	0.652	1.044	1.566	2160	270
S8M-2240	0.406	0.676	1.082	1.624	2240	280
S8M-2304	0.417	0.696	1.113	1.670	2304	288
S8M-2400	0.435	0.725	1.160	1.740	2400	300
S8M-2496	0.452	0.754	1.206	1.809	2496	312
S8M-2560	0.464	0.773	1.237	1.855	2560	320
S8M-2600	0.468	0.787	1.258	1.888	2600	325
S8M-2800	0.507	0.846	1.353	2.029	2800	350
S8M-2880	0.522	0.870	1.392	2.087	2880	360
S8M-2944	0.530	0.891	1.465	2.137	2944	368
S8M-3200	0.580	0.966	1.546	2.319	3200	400
S8M-3600	0.648	1.089	1.742	2.614	3600	450
S8M-3720	0.670	1.125	1.800	2.701	3720	465
S8M-3904	0.703	1.181	1.890	2.834	3904	488
S8M-4400	0.797	1.329	2.126	3.189	4400	550

\* Weights shown are approximate.

Other widths available. Contact BANDO for price and delivery.

Synchro-Link® STS Timing Belts - Neoprene (Metric)



### Nominal Dimensions

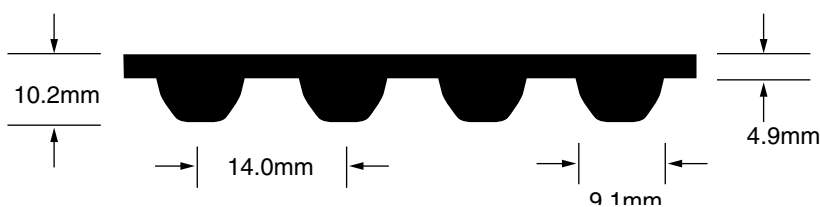

### Part Number Example

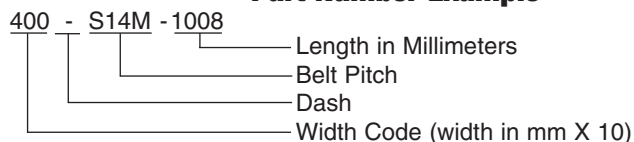

Part number includes the width code prefix in parenthesis below. For example, a 40mm wide S14M-1008 has a part number 400-S14M-1008.

### STS14M for 40mm, 60mm, 80mm, 100mm and 120mm Wide Belts

Part Number	40mm Wide (400)	60mm Wide (600)	80mm Wide (800)	100mm Wide (1000)	120mm Wide (1200)	Pitch Length (mm)	Number of Teeth
	Weight*	Weight*	Weight*	Weight*	Weight*		
S14M-1008	0.889	1.334	1.778	2.223	2.667	1008	72
S14M-1120	0.988	1.482	1.976	2.470	2.964	1120	80
S14M-1190	1.050	1.574	2.099	2.624	3.149	1190	85
S14M-1246	1.099	1.648	2.198	2.747	3.297	1246	89
S14M-1400	1.235	1.852	2.470	3.087	3.704	1400	100
S14M-1540	1.358	2.037	2.717	3.396	4.075	1540	110
S14M-1610	1.420	2.130	2.840	3.550	4.260	1610	115
S14M-1652	1.457	2.186	2.914	3.643	4.371	1652	118
S14M-1778	1.565	2.347	3.129	3.912	4.694	1778	127
S14M-1806	1.593	2.389	3.186	3.982	4.779	1806	129
S14M-1890	1.667	2.500	3.334	4.167	5.001	1890	135
S14M-1904	1.679	2.519	3.359	4.198	5.038	1904	136
S14M-1960	1.725	2.587	3.450	4.312	5.174	1960	140
S14M-2002	1.766	2.649	3.532	4.414	5.297	2002	143
S14M-2100	1.852	2.778	3.704	4.631	5.557	2100	150
S14M-2240	1.976	2.964	3.951	4.939	5.927	2240	160
S14M-2310	2.037	3.056	4.075	5.094	6.112	2310	165
S14M-2380	2.099	3.149	4.198	5.248	6.297	2380	170
S14M-2450	2.161	3.241	4.322	5.402	6.483	2450	175
S14M-2506	2.210	3.315	4.421	5.526	6.631	2506	179
S14M-2590	2.284	3.427	4.569	5.711	6.853	2590	185
S14M-2660	2.346	3.519	4.692	5.865	7.038	2660	190
S14M-2800	2.470	3.704	4.939	6.174	7.409	2800	200
S14M-3150	2.778	4.167	5.557	6.946	8.335	3150	225
S14M-3248	2.858	4.287	5.716	7.146	8.575	3248	232
S14M-3500	3.087	4.631	6.174	7.718	9.261	3500	250
S14M-3556	3.136	4.705	6.273	7.841	9.409	3556	254
S14M-3850	3.396	5.094	6.791	8.489	10.187	3850	275
S14M-4004	3.532	5.297	7.063	8.829	10.595	4004	286
S14M-4060	3.581	5.371	7.162	8.952	10.743	4060	290
S14M-4326	3.816	5.723	7.631	9.539	11.447	4326	309
S14M-4508	3.976	5.964	7.952	9.940	11.928	4508	322
S14M-5012	4.421	6.631	8.841	11.051	13.262	5012	358

\* Weights shown are approximate.

Other widths available. Contact BANDO for price and delivery.

Synchro-Link® STS Timing Belts - Neoprene (Metric)



### Nominal Dimensions

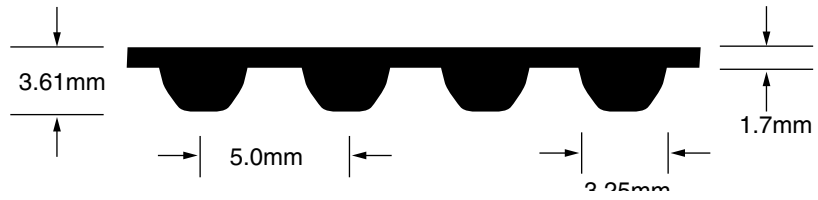

### Part Number Example

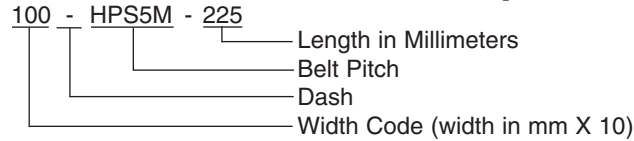

Part number includes the width code prefix in parenthesis below. For example, a 10mm wide HPS5M-225 is part number 100-HPS5M-225.

Synchro-Link® HPS Timing Belts - Neoprene (Metric)

### HPS5M for 10mm, 15mm, 20mm and 25mm Wide Belts

Part Number	10mm Wide (100)	15mm Wide (150)	20mm Wide (200)	25mm Wide (250)	Pitch Length (mm)	Number of Teeth
	Weight*	Weight*	Weight*	Weight*		
HPS5M-225	0.019	0.028	0.038	0.047	225	45
HPS5M-230	0.020	0.030	0.040	0.051	230	46
HPS5M-255	0.021	0.032	0.043	0.054	255	51
HPS5M-275	0.023	0.035	0.046	0.058	275	55
HPS5M-285	0.024	0.036	0.048	0.060	285	57
HPS5M-295	0.025	0.037	0.050	0.062	295	59
HPS5M-300	0.025	0.038	0.051	0.063	300	60
HPS5M-305	0.026	0.039	0.052	0.065	305	61
HPS5M-320	0.027	0.040	0.054	0.067	320	64
HPS5M-325	0.027	0.041	0.055	0.068	325	65
HPS5M-350	0.029	0.044	0.059	0.074	350	70
HPS5M-375	0.032	0.047	0.063	0.079	375	75
HPS5M-380	0.032	0.048	0.064	0.080	380	76
HPS5M-390	0.033	0.049	0.066	0.082	390	78
HPS5M-400	0.034	0.051	0.067	0.084	400	80
HPS5M-410	0.035	0.052	0.069	0.086	410	82
HPS5M-420	0.036	0.053	0.070	0.088	420	84
HPS5M-425	0.036	0.054	0.072	0.090	425	85
HPS5M-435	0.037	0.055	0.073	0.092	435	87
HPS5M-440	0.037	0.056	0.074	0.093	440	88
HPS5M-445	0.037	0.056	0.075	0.094	445	89
HPS5M-450	0.038	0.057	0.076	0.095	450	90
HPS5M-475	0.040	0.060	0.080	0.100	475	95
HPS5M-490	0.041	0.062	0.083	0.103	490	98
HPS5M-500	0.043	0.064	0.085	0.106	500	100
HPS5M-520	0.044	0.066	0.088	0.110	520	104
HPS5M-525	0.045	0.068	0.090	0.113	525	105
HPS5M-550	0.046	0.070	0.093	0.116	550	110
HPS5M-560	0.047	0.071	0.094	0.118	560	112
HPS5M-565	0.048	0.071	0.095	0.119	565	113
HPS5M-570	0.048	0.072	0.096	0.120	570	114
HPS5M-575	0.048	0.073	0.097	0.121	575	115
HPS5M-600	0.051	0.076	0.101	0.126	600	120
HPS5M-625	0.053	0.079	0.105	0.132	625	125
HPS5M-635	0.054	0.080	0.107	0.134	635	127

\* Weights shown are approximate.

Other widths available. Contact BANDO for price and delivery.



## HPS5M for 10mm, 15mm, 20mm and 25mm Wide Belts (Continued)

Part Number	10mm Wide (100)	15mm Wide (150)	20mm Wide (200)	25mm Wide (250)	Pitch Length (mm)	Number of Teeth
	Weight*	Weight*	Weight*	Weight*		
HPS5M-645	0.054	0.082	0.109	0.136	645	129
HPS5M-650	0.055	0.082	0.110	0.137	650	130
HPS5M-665	0.056	0.084	0.112	0.140	665	133
HPS5M-670	0.056	0.085	0.113	0.141	670	134
HPS5M-675	0.057	0.085	0.114	0.142	675	135
HPS5M-695	0.059	0.088	0.117	0.146	695	139
HPS5M-700	0.059	0.088	0.118	0.147	700	140
HPS5M-710	0.060	0.090	0.120	0.150	710	142
HPS5M-725	0.061	0.092	0.122	0.153	725	145
HPS5M-740	0.062	0.094	0.124	0.155	740	148
HPS5M-750	0.063	0.095	0.126	0.158	750	150
HPS5M-765	0.064	0.097	0.129	0.161	765	153
HPS5M-770	0.065	0.097	0.130	0.162	770	154
HPS5M-775	0.065	0.098	0.131	0.163	775	155
HPS5M-780	0.066	0.100	0.133	0.166	780	156
HPS5M-800	0.067	0.101	0.135	0.169	800	160
HPS5M-810	0.068	0.102	0.137	0.171	810	162
HPS5M-830	0.070	0.105	0.140	0.175	830	166
HPS5M-850	0.072	0.107	0.143	0.179	850	170
HPS5M-860	0.072	0.109	0.145	0.181	860	172
HPS5M-870	0.073	0.110	0.147	0.183	870	174
HPS5M-900	0.076	0.114	0.152	0.190	900	180
HPS5M-920	0.078	0.116	0.155	0.194	920	184
HPS5M-940	0.079	0.119	0.158	0.198	940	188
HPS5M-950	0.080	0.120	0.160	0.200	950	190
HPS5M-965	0.080	0.121	0.161	0.201	965	193
HPS5M-975	0.082	0.123	0.164	0.205	975	195
HPS5M-1000	0.084	0.126	0.169	0.211	1000	200
HPS5M-1025	0.086	0.130	0.173	0.216	1025	205
HPS5M-1050	0.088	0.133	0.177	0.221	1050	210
HPS5M-1085	0.092	0.138	0.183	0.229	1085	217
HPS5M-1125	0.095	0.142	0.190	0.237	1125	225
HPS5M-1135	0.096	0.143	0.191	0.239	1135	227
HPS5M-1145	0.096	0.145	0.193	0.241	1145	229
HPS5M-1195	0.101	0.151	0.201	0.252	1195	239
HPS5M-1225	0.103	0.155	0.206	0.258	1225	245
HPS5M-1250	0.105	0.158	0.211	0.263	1250	250
HPS5M-1260	0.106	0.159	0.212	0.265	1260	252
HPS5M-1270	0.107	0.161	0.214	0.268	1270	254
HPS5M-1295	0.109	0.164	0.218	0.273	1295	259
HPS5M-1350	0.114	0.171	0.228	0.284	1350	270
HPS5M-1420	0.120	0.179	0.239	0.299	1420	284
HPS5M-1595	0.134	0.202	0.269	0.336	1595	319
HPS5M-1715	0.145	0.217	0.289	0.361	1715	343
HPS5M-1800	0.152	0.228	0.303	0.379	1800	360
HPS5M-2000	0.169	0.253	0.337	0.421	2000	400

Synchro-Link® HPS Timing Belts - Neoprene (Metric)

\* Weights shown are approximate.

Other widths available. Contact BANDO for price and delivery.



### Nominal Dimensions

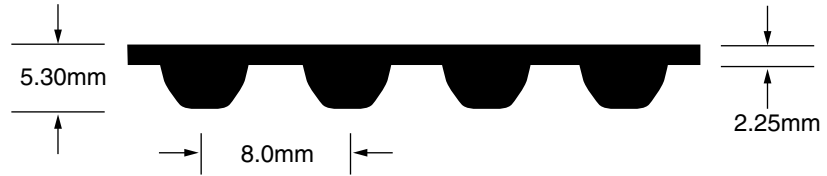

### Part Number Example

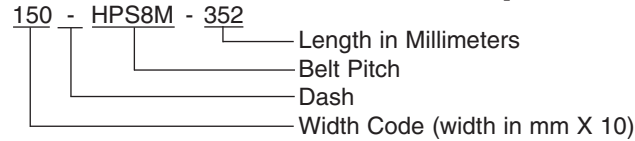

Part number includes the width code prefix in parenthesis below. For example, a 15mm wide HPS8M-352 is part number 150-HPS8M-352.

**Synchro-Link® HPS Timing Belts - Neoprene (Metric)**

### HPS8M for 15mm, 25mm, 40mm and 60mm Wide Belts

Part Number	15mm Wide (150)	25mm Wide (250)	40mm Wide (400)	60mm Wide (600)	Pitch Length (mm)	Number of Teeth
	Weight*	Weight*	Weight*	Weight*		
HPS8M-352	0.063	0.106	0.170	0.256	352	44
HPS8M-384	0.069	0.115	0.186	0.279	384	48
HPS8M-408	0.073	0.122	0.197	0.296	408	51
HPS8M-424	0.076	0.127	0.205	0.308	424	53
HPS8M-456	0.082	0.137	0.221	0.331	456	57
HPS8M-480	0.087	0.145	0.232	0.348	480	60
HPS8M-520	0.094	0.157	0.251	0.377	520	65
HPS8M-528	0.095	0.160	0.256	0.383	528	66
HPS8M-560	0.101	0.169	0.271	0.406	560	70
HPS8M-584	0.106	0.176	0.282	0.423	584	73
HPS8M-600	0.109	0.181	0.290	0.435	600	75
HPS8M-632	0.115	0.191	0.305	0.458	632	79
HPS8M-640	0.116	0.193	0.309	0.464	640	80
HPS8M-656	0.118	0.197	0.318	0.476	656	82
HPS8M-672	0.121	0.202	0.325	0.488	672	84
HPS8M-680	0.123	0.205	0.329	0.493	680	85
HPS8M-712	0.129	0.215	0.344	0.516	712	89
HPS8M-720	0.130	0.217	0.348	0.522	720	90
HPS8M-728	0.132	0.220	0.352	0.528	728	91
HPS8M-760	0.138	0.230	0.367	0.551	760	95
HPS8M-800	0.145	0.242	0.387	0.580	800	100
HPS8M-824	0.148	0.247	0.399	0.598	824	103
HPS8M-840	0.152	0.254	0.406	0.609	840	105
HPS8M-848	0.154	0.256	0.410	0.615	848	106
HPS8M-880	0.159	0.266	0.425	0.638	880	110
HPS8M-888	0.161	0.268	0.429	0.644	888	111
HPS8M-896	0.162	0.271	0.433	0.649	896	112
HPS8M-920	0.167	0.278	0.445	0.667	920	115
HPS8M-944	0.171	0.285	0.456	0.684	944	118
HPS8M-960	0.174	0.290	0.464	0.696	960	120
HPS8M-976	0.176	0.293	0.472	0.709	976	122
HPS8M-984	0.178	0.297	0.475	0.713	984	123
HPS8M-1000	0.181	0.302	0.483	0.725	1000	125
HPS8M-1032	0.187	0.312	0.499	0.748	1032	129
HPS8M-1040	0.188	0.314	0.503	0.754	1040	130

\* Weights shown are approximate.

Other widths available. Contact BANDO for price and delivery.



## HPS8M for 15mm, 25mm, 40mm and 60mm Wide Belts (Continued)

Part Number	15mm Wide (150)	25mm Wide (250)	40mm Wide (400)	60mm Wide (600)	Pitch Length (mm)	Number of Teeth
	Weight*	Weight*	Weight*	Weight*		
HPS8M-1056	0.191	0.319	0.510	0.765	1056	132
HPS8M-1096	0.199	0.331	0.530	0.794	1096	137
HPS8M-1120	0.203	0.338	0.541	0.812	1120	140
HPS8M-1136	0.206	0.343	0.549	0.823	1136	142
HPS8M-1152	0.209	0.348	0.557	0.835	1152	144
HPS8M-1160	0.209	0.351	0.561	0.842	1160	145
HPS8M-1184	0.215	0.358	0.572	0.858	1184	148
HPS8M-1192	0.216	0.360	0.576	0.864	1192	149
HPS8M-1200	0.217	0.362	0.580	0.870	1200	150
HPS8M-1216	0.220	0.367	0.588	0.881	1216	152
HPS8M-1224	0.222	0.370	0.591	0.887	1224	153
HPS8M-1240	0.225	0.374	0.599	0.899	1240	155
HPS8M-1248	0.226	0.377	0.603	0.905	1248	156
HPS8M-1272	0.229	0.385	0.616	0.923	1272	159
HPS8M-1280	0.232	0.387	0.618	0.928	1280	160
HPS8M-1296	0.235	0.391	0.626	0.939	1296	162
HPS8M-1312	0.239	0.399	0.638	0.957	1312	164
HPS8M-1344	0.244	0.406	0.649	0.974	1344	168
HPS8M-1352	0.245	0.408	0.653	0.980	1352	169
HPS8M-1384	0.251	0.418	0.669	1.003	1384	173
HPS8M-1392	0.252	0.420	0.673	1.009	1392	174
HPS8M-1400	0.254	0.423	0.676	1.015	1400	175
HPS8M-1424	0.258	0.430	0.688	1.032	1424	178
HPS8M-1440	0.261	0.435	0.696	1.044	1440	180
HPS8M-1480	0.266	0.448	0.716	1.074	1480	185
HPS8M-1520	0.274	0.460	0.736	1.104	1520	190
HPS8M-1552	0.279	0.469	0.751	1.127	1552	194
HPS8M-1600	0.301	0.501	0.802	1.203	1600	200
HPS8M-1728	0.313	0.522	0.835	1.252	1728	216
HPS8M-1760	0.319	0.532	0.850	1.276	1760	220
HPS8M-1776	0.322	0.536	0.858	1.287	1776	222
HPS8M-1800	0.326	0.544	0.870	1.305	1800	225
HPS8M-1808	0.331	0.547	0.875	1.313	1808	226
HPS8M-1880	0.338	0.569	0.910	1.365	1880	235
HPS8M-1952	0.351	0.590	0.945	1.417	1952	244
HPS8M-2000	0.362	0.604	0.966	1.450	2000	250
HPS8M-2040	0.373	0.622	0.995	1.494	2040	255
HPS8M-2120	0.384	0.640	1.024	1.537	2120	265
HPS8M-2160	0.391	0.652	1.044	1.566	2160	270
HPS8M-2240	0.406	0.676	1.082	1.624	2240	280
HPS8M-2304	0.417	0.696	1.113	1.670	2304	288
HPS8M-2400	0.435	0.725	1.160	1.740	2400	300
HPS8M-2496	0.452	0.754	1.206	1.809	2496	312
HPS8M-2560	0.464	0.773	1.237	1.855	2560	320
HPS8M-2600	0.468	0.787	1.258	1.888	2600	325
HPS8M-2800	0.507	0.846	1.353	2.029	2800	350
HPS8M-2880	0.522	0.870	1.392	2.087	2880	360
HPS8M-2944	0.530	0.891	1.465	2.137	2944	368
HPS8M-3200	0.580	0.966	1.546	2.319	3200	400
HPS8M-3600	0.648	1.089	1.742	2.614	3600	450
HPS8M-3720	0.670	1.125	1.800	2.701	3720	465
HPS8M-3904	0.703	1.181	1.890	2.834	3904	488
HPS8M-4400	0.797	1.329	2.126	3.189	4400	550

Synchro-Link® HPS Timing Belts - Neoprene (Metric)

\* Weights shown are approximate.

Other widths available. Contact BANDO for price and delivery.



### Nominal Dimensions

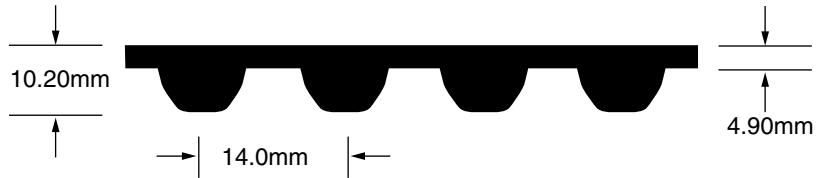

### Part Number Example

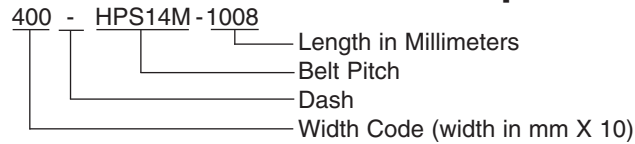

Part number includes the width code prefix in parenthesis below. For example, a 40mm wide HPS14M-1008 has a part number 400-HPS14M-1008.

**Synchro-Link® HPS Timing Belts - Neoprene (Metric)**

### HPS14M for 40mm, 60mm, 80mm 100mm and 120mm Wide Belts

Part Number	40mm Wide (400)	60mm Wide (600)	80mm Wide (800)	100mm Wide (1000)	120mm Wide (1200)	Pitch Length (mm)	Number of Teeth
	Weight*	Weight*	Weight*	Weight*	Weight*		
HPS14M-1008	0.889	1.334	1.778	2.223	2.667	1008	72
HPS14M-1120	0.988	1.482	1.976	2.470	2.964	1120	80
HPS14M-1190	1.050	1.574	2.099	2.624	3.149	1190	85
HPS14M-1246	1.099	1.648	2.198	2.747	3.297	1246	89
HPS14M-1400	1.235	1.852	2.470	3.087	3.704	1400	100
HPS14M-1540	1.358	2.037	2.717	3.396	4.075	1540	110
HPS14M-1610	1.420	2.130	2.840	3.550	4.260	1610	115
HPS14M-1652	1.457	2.186	2.914	3.643	4.371	1652	118
HPS14M-1778	1.565	2.347	3.129	3.912	4.694	1778	127
HPS14M-1806	1.593	2.389	3.186	3.982	4.779	1806	129
HPS14M-1890	1.667	2.500	3.334	4.167	5.001	1890	135
HPS14M-1904	1.679	2.519	3.359	4.198	5.038	1904	136
HPS14M-1960	1.725	2.587	3.450	4.312	5.174	1960	140
HPS14M-2002	1.766	2.649	3.532	4.414	5.297	2002	143
HPS14M-2100	1.852	2.778	3.704	4.631	5.557	2100	150
HPS14M-2240	1.976	2.964	3.951	4.939	5.927	2240	160
HPS14M-2310	2.037	3.056	4.075	5.094	6.112	2310	165
HPS14M-2380	2.099	3.149	4.198	5.248	6.297	2380	170
HPS14M-2450	2.161	3.241	4.322	5.402	6.483	2450	175
HPS14M-2506	2.210	3.315	4.421	5.526	6.631	2506	179
HPS14M-2590	2.284	3.427	4.569	5.711	6.853	2590	185
HPS14M-2660	2.346	3.519	4.692	5.865	7.038	2660	190
HPS14M-2800	2.470	3.704	4.939	6.174	7.409	2800	200
HPS14M-3150	2.778	4.167	5.557	6.946	8.335	3150	225
HPS14M-3248	2.858	4.287	5.716	7.146	8.575	3248	232
HPS14M-3500	3.087	4.631	6.174	7.718	9.261	3500	250
HPS14M-3556	3.136	4.705	6.273	7.841	9.409	3556	254
HPS14M-3850	3.396	5.094	6.791	8.489	10.187	3850	275
HPS14M-4004	3.532	5.297	7.063	8.829	10.595	4004	286
HPS14M-4060	3.581	5.371	7.162	8.952	10.743	4060	290
HPS14M-4326	3.816	5.723	7.631	9.539	11.447	4326	309
HPS14M-4508	3.976	5.964	7.952	9.940	11.928	4508	322
HPS14M-5012	4.421	6.631	8.841	11.051	13.262	5012	358

\* Weights shown are approximate.

Other widths available. Contact BANDO for price and delivery.





### Nominal Dimensions

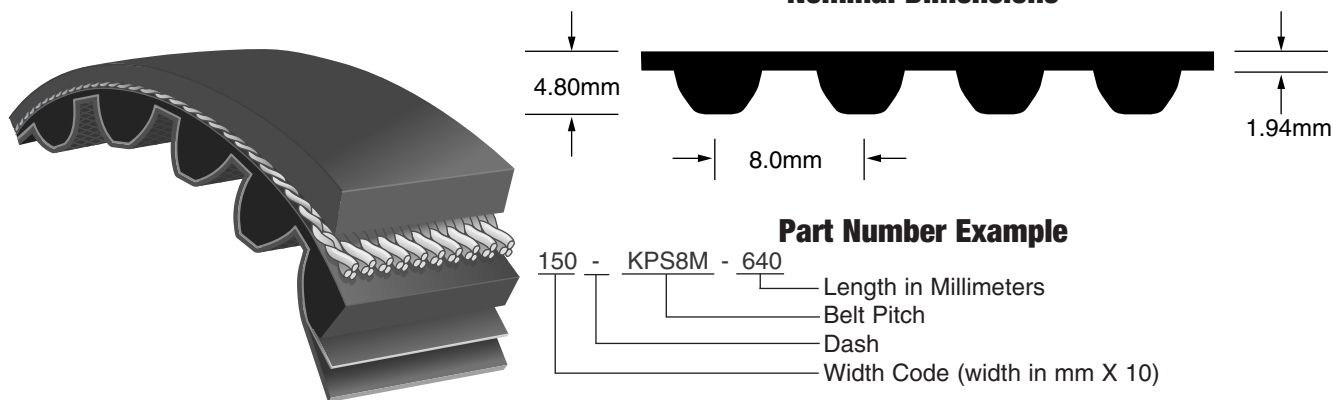

Part number includes the width code prefix in parenthesis below. For example, a 15mm wide KPS8M-640 is part number 150-KPS8M-640.

### KPS8M for 15mm, 25mm, 40mm and 60mm Wide Belts

Part Number	15mm Wide (150)	25mm Wide (250)	40mm Wide (400)	60mm Wide (600)	Pitch Length (mm)	Number of Teeth
	Weight*	Weight*	Weight*	Weight*		
KPS8M-640	0.083	0.138	0.220	0.330	640	80
KPS8M-680	0.088	0.146	0.234	0.351	680	85
KPS8M-720	0.093	0.155	0.248	0.372	720	90
KPS8M-760	0.098	0.163	0.261	0.392	760	95
KPS8M-800	0.103	0.172	0.275	0.413	800	100
KPS8M-848	0.109	0.182	0.292	0.438	848	106
KPS8M-896	0.116	0.193	0.308	0.462	896	112
KPS8M-944	0.122	0.203	0.325	0.487	944	118
KPS8M-1000	0.129	0.215	0.344	0.516	1000	125
KPS8M-1024	0.133	0.222	0.355	0.533	1024	128
KPS8M-1032	0.134	0.224	0.358	0.537	1032	129
KPS8M-1056	0.136	0.227	0.363	0.545	1056	132
KPS8M-1120	0.144	0.241	0.385	0.578	1120	140
KPS8M-1152	0.149	0.248	0.396	0.594	1152	144
KPS8M-1200	0.155	0.258	0.413	0.619	1200	150
KPS8M-1280	0.165	0.275	0.440	0.660	1280	160
KPS8M-1360	0.174	0.291	0.465	0.698	1360	170
KPS8M-1440	0.186	0.310	0.495	0.743	1440	180
KPS8M-1520	0.196	0.327	0.523	0.784	1520	190
KPS8M-1600	0.206	0.344	0.550	0.826	1600	200
KPS8M-1696	0.223	0.372	0.594	0.892	1696	212
KPS8M-1792	0.227	0.378	0.605	0.908	1792	224
KPS8M-1960	0.252	0.420	0.671	1.007	1960	245

\* Weights shown are approximate.

Other widths available. Contact BANDO for price and delivery.

Synchro-Link® KPS Timing Belts - Polyurethane (Metric)



### Nominal Dimensions

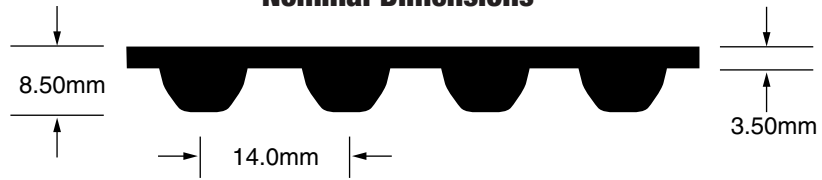

### Part Number Example

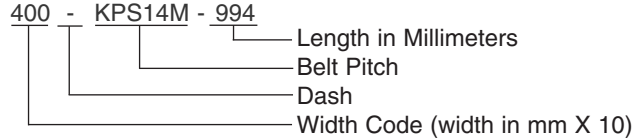

Part number includes the width code prefix in parenthesis below. For example, a 40mm wide KPS14M-994 has a part number 400-KPS14M-994.

## KPS14M for 40mm, 60mm, 80mm, 100mm and 120mm Wide Belts

Synchro-Link® KPS Timing Belts - Polyurethane (Metric)

Part Number	40mm Wide (400)	60mm Wide (600)	80mm Wide (800)	100mm Wide (1000)	120mm Wide (1200)	Pitch Length (mm)	Number of Teeth
	Weight*	Weight*	Weight*	Weight*	Weight*		
KPS14M-994	0.589	0.883	1.177	1.472	1.766	994	71
KPS14M-1120	0.654	0.981	1.308	1.635	1.962	1120	80
KPS14M-1190	0.695	1.042	1.390	1.737	2.085	1190	85
KPS14M-1260	0.728	1.091	1.455	1.819	2.183	1260	90
KPS14M-1400	0.818	1.226	1.635	2.044	2.453	1400	100
KPS14M-1470	0.899	1.349	1.799	2.248	2.698	1470	105
KPS14M-1568	0.940	1.410	1.880	2.351	2.821	1568	112
KPS14M-1652	0.965	1.447	1.930	2.412	2.894	1652	118
KPS14M-1708	1.038	1.558	2.077	2.596	3.115	1708	122
KPS14M-1890	1.104	1.656	2.208	2.759	3.311	1890	135
KPS14M-1960	1.145	1.717	2.289	2.862	3.434	1960	140
KPS14M-2380	1.390	2.085	2.780	3.475	4.170	2380	170

\* Weights shown are approximate.

Other widths available. Contact BANDO for price and delivery.

### Tensioning for Synchro-Link® STS and HPS Belts

Belt Size		Belt Width (mm)										
		4	6	10	15	20	25	40	60	80	100	120
S2M	Min	0.2	0.3	0.5								
	Max	0.4	0.5	0.7								
S3M	Min		0.4	0.7	1.2							
	Max		0.6	1.1	1.6							
S4.5M	Min		0.5	0.8	1.4							
	Max		0.7	1.2	1.8							
S5M	Min			1.6	2.0	2.6	3.0					
	Max			2.2	3.0	3.5	4.0					
S8M	Min				3.0		5.0	9.0	14.0			
	Max				5.0		7.0	11.5	17.0			
S14M	Min							10.0	17.0	21.0	28.0	34.0
	Max							14.0	21.0	26.0	34.0	41.0

### Tensioning for Synchro-Link® KPS II Belts

Belt Size		Belt Width (mm)						
		15	25	40	60	80	100	120
KPS8M	Min	6.1	8.5	15.3	23.8			
	Max	7.4	11.9	19.5	28.9			
KPS14M	Min			17.0	28.9	35.7	47.6	57.8
	Max			23.8	35.7	44.2	57.8	69.7

**Note:** Tensioning values are in pounds. Refer to page 133 for proper tensioning procedures and use of values in this table.



### Nominal Dimensions

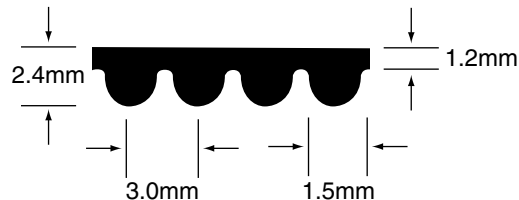

### Part Number Example

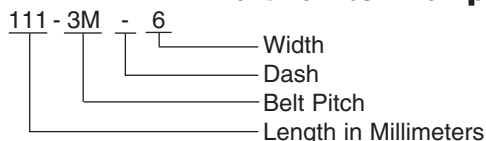

Part number includes the width/construction suffix in parenthesis below.  
Example, a 6mm wide 111-3M is part number 111-3M-6.

## HT - 3mm Pitch for 6mm, 9mm and 15mm Wide Belts

Part Number	6mm Wide	9mm Wide	15mm Wide	Pitch Length (mm)	Number of Teeth
	Weight*	Weight*	Weight*		
111-3M	0.004	0.005	0.009	111	37
117-3M	0.004	0.006	0.009	117	39
129-3M	0.004	0.006	0.010	129	43
144-3M	0.005	0.007	0.011	144	48
150-3M	0.005	0.007	0.012	150	50
159-3M	0.005	0.007	0.012	159	53
168-3M	0.005	0.008	0.013	168	56
174-3M	0.005	0.008	0.014	174	58
177-3M	0.006	0.008	0.014	177	59
201-3M	0.006	0.009	0.016	201	67
204-3M	0.006	0.010	0.016	204	68
210-3M	0.007	0.010	0.016	210	70
213-3M	0.007	0.010	0.017	213	71
216-3M	0.007	0.010	0.017	216	72
225-3M	0.007	0.011	0.018	225	75
240-3M	0.008	0.011	0.019	240	80
246-3M	0.008	0.012	0.019	246	82
252-3M	0.008	0.012	0.020	252	84
255-3M	0.008	0.012	0.020	255	85
267-3M	0.008	0.013	0.021	267	89
285-3M	0.009	0.013	0.022	285	95
300-3M	0.009	0.014	0.023	300	100
312-3M	0.010	0.015	0.024	312	104
318-3M	0.010	0.015	0.025	318	106
336-3M	0.011	0.016	0.026	336	112
339-3M	0.011	0.016	0.027	339	113
363-3M	0.011	0.017	0.028	363	121
384-3M	0.012	0.018	0.030	384	128
390-3M	0.012	0.018	0.030	390	130
420-3M	0.013	0.020	0.033	420	140
447-3M	0.014	0.021	0.035	447	149
474-3M	0.015	0.022	0.037	474	158
480-3M	0.015	0.023	0.038	480	160
489-3M	0.015	0.023	0.038	489	163
495-3M	0.016	0.023	0.039	495	165
501-3M	0.016	0.024	0.039	501	167
513-3M	0.016	0.024	0.040	513	171
522-3M	0.016	0.024	0.041	522	174
525-3M	0.016	0.025	0.041	525	175
537-3M	0.017	0.025	0.042	537	179

\* Weights shown are approximate.

Some specific sizes of 3mm Synchro-Link® HT may require minimum order quantities.

Other widths available. Contact BANDO for price and delivery.

Synchro-Link® HT Timing Belts - Neoprene (Metric)



## HT - 3mm Pitch for 6mm, 9mm and 15mm Wide Belts (Continued)

Part Number	6mm Wide	9mm Wide	15mm Wide	Pitch Length (mm)	Number of Teeth
	Weight*	Weight*	Weight*		
564-3M	0.018	0.026	0.044	564	188
570-3M	0.018	0.027	0.045	570	190
606-3M	0.019	0.028	0.047	606	202
612-3M	0.019	0.029	0.048	612	204
633-3M	0.020	0.030	0.049	633	211
669-3M	0.021	0.031	0.052	669	223
708-3M	0.022	0.033	0.055	708	236
711-3M	0.022	0.033	0.056	711	237
753-3M	0.024	0.035	0.059	753	251
843-3M	0.026	0.040	0.066	843	281
882-3M	0.028	0.041	0.069	882	294
945-3M	0.030	0.044	0.074	945	315
960-3M	0.030	0.045	0.075	960	320
1041-3M	0.033	0.049	0.081	1041	347
1068-3M	0.033	0.050	0.083	1068	356
1071-3M	0.033	0.050	0.084	1071	357
1125-3M	0.035	0.053	0.088	1125	375
1176-3M	0.367	0.056	0.092	1176	392
1569-3M	0.049	0.074	0.123	1569	523

\* Weights shown are approximate.

Some specific sizes of 3mm Synchro-Link® HT may require minimum order quantities.

Other widths available. Contact BANDO for price and delivery.

Synchro-Link® HT Timing Belts - Neoprene (Metric)



### BANDO USA, Inc. Bowling Green, Kentucky Plant

Established in 1987, BANDO USA Inc.'s Bowling Green, Kentucky plant is unlike any belt production facility in the U.S.A. Using a combination of highly automated processing equipment and state-of-the-art manufacturing techniques, the Kentucky facility is synonymous with zero defect product and proven reliability in V-Belt and Timing Belt technology and production. The Bowling Green plant has received over 125 awards for excellence in innovation, quality and service.

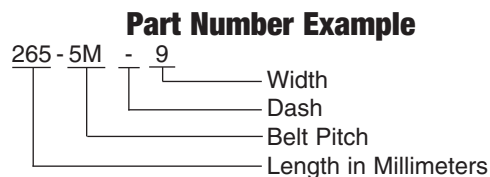
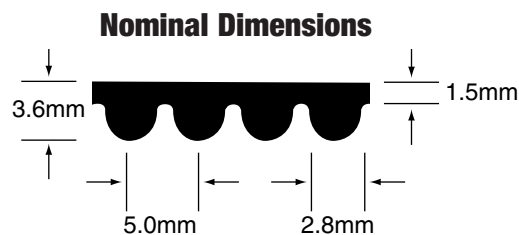

Example 9mm wide 265-5M is part number 265-5M-9.

### HT - 5mm Pitch for 9mm, 15mm and 25mm Wide Belts

Part Number	9mm Wide	15mm Wide	25mm Wide	Pitch Length (mm)	Number of Teeth
	Weight*	Weight*	Weight*		
265-5M	0.017	0.028	0.047	265	53
295-5M	0.018	0.031	0.052	295	59
300-5M	0.019	0.032	0.053	300	60
330-5M	0.021	0.035	0.059	330	66
350-5M	0.022	0.037	0.062	350	70
375-5M	0.024	0.040	0.067	375	75
400-5M	0.026	0.043	0.071	400	80
425-5M	0.027	0.045	0.076	425	85
450-5M	0.029	0.048	0.080	450	90
460-5M	0.030	0.049	0.082	460	92
475-5M	0.030	0.051	0.085	475	95
500-5M	0.032	0.053	0.089	500	100
535-5M	0.034	0.057	0.095	535	107
565-5M	0.036	0.060	0.101	565	113
600-5M	0.039	0.064	0.107	600	120
615-5M	0.039	0.066	0.110	615	123
620-5M	0.040	0.066	0.110	620	124
630-5M	0.040	0.067	0.112	630	126
635-5M	0.041	0.068	0.113	635	127
665-5M	0.043	0.071	0.118	665	133
710-5M	0.046	0.076	0.126	710	142
740-5M	0.047	0.079	0.132	740	148
755-5M	0.048	0.081	0.134	755	151
800-5M	0.051	0.086	0.142	800	160
835-5M	0.054	0.089	0.149	835	167
890-5M	0.057	0.095	0.158	890	178
900-5M	0.058	0.096	0.160	900	180
925-5M	0.059	0.099	0.165	925	185
1000-5M	0.064	0.107	0.178	1000	200
1050-5M	0.067	0.112	0.187	1050	210
1125-5M	0.072	0.120	0.200	1125	225
1270-5M	0.081	0.136	0.226	1270	254
1500-5M	0.096	0.160	0.267	1500	300

\* Weights shown are approximate.

Some specific sizes of 5mm Synchro-Link® HT may require minimum order quantities.

Other widths available. Contact BANDO for price and delivery.

Synchro-Link® HT Timing Belts - Neoprene (Metric)



**Nominal Dimensions**

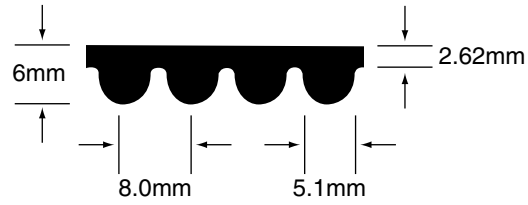

**Part Number Example**



Example, 20mm wide 384-8M is part number 384-8M-20.

**Synchro-Link® HT Timing Belts - Neoprene (Metric)**

**HT - 8mm Pitch for 20mm, 30mm, 50mm and 85mm Wide Belts**

Part Number	20mm Wide	30mm Wide	50mm Wide	85mm Wide	Pitch Length (mm)	Number of Teeth
	Weight*	Weight*	Weight*	Weight*		
384-8M	0.095	0.144	0.239	0.406	384	48
424-8M	0.102	0.154	0.256	0.435	424	53
480-8M	0.116	0.174	0.290	0.493	480	60
560-8M	0.135	0.203	0.338	0.575	560	70
600-8M	0.145	0.217	0.362	0.616	600	75
624-8M	0.151	0.226	0.377	0.641	624	78
640-8M	0.155	0.232	0.387	0.684	640	80
656-8M	0.161	0.242	0.403	0.702	656	82
680-8M	0.167	0.251	0.419	0.720	680	85
720-8M	0.174	0.261	0.435	0.739	720	90
760-8M	0.184	0.276	0.459	0.780	760	95
800-8M	0.193	0.290	0.483	0.821	800	100
840-8M	0.200	0.299	0.499	0.849	840	105
856-8M	0.207	0.309	0.515	0.877	856	107
880-8M	0.213	0.319	0.532	0.904	880	110
896-8M	0.218	0.326	0.544	0.925	896	112
920-8M	0.222	0.333	0.556	0.945	920	115
960-8M	0.232	0.348	0.580	0.986	960	120
1000-8M	0.242	0.363	0.604	1.027	1000	125
1040-8M	0.251	0.377	0.628	1.068	1040	130
1056-8M	0.256	0.384	0.640	1.089	1056	132
1064-8M	0.261	0.392	0.652	1.110	1064	133
1080-8M	0.266	0.399	0.664	1.130	1080	135
1120-8M	0.271	0.406	0.676	1.150	1120	140
1152-8M	0.275	0.412	0.686	1.166	1152	144
1160-8M	0.279	0.418	0.696	1.182	1160	145
1184-8M	0.282	0.423	0.705	1.184	1184	148
1192-8M	0.286	0.429	0.715	1.203	1192	149
1200-8M	0.290	0.442	0.725	1.232	1200	150
1224-8M	0.295	0.448	0.737	1.253	1224	153
1248-8M	0.300	0.453	0.749	1.273	1248	156
1264-8M	0.304	0.459	0.761	1.294	1264	158
1280-8M	0.309	0.464	0.773	1.314	1280	160
1304-8M	0.315	0.483	0.788	1.339	1304	163
1360-8M	0.329	0.493	0.821	1.396	1360	170
1392-8M	0.334	0.501	0.834	1.418	1392	174
1400-8M	0.339	0.508	0.847	1.440	1400	175
1424-8M	0.344	0.516	0.860	1.462	1424	178
1440-8M	0.348	0.527	0.870	1.479	1440	180
1480-8M	0.356	0.537	0.889	1.512	1480	185

\* Weights shown are approximate.

Other widths available. Contact BANDO for price and delivery.



## HT - 8mm Pitch for 20mm, 30mm, 50mm and 85mm Wide Belts (Continued)

Part Number	20mm Wide	30mm Wide	50mm Wide	85mm Wide	Pitch Length (mm)	Number of Teeth
	Weight*	Weight*	Weight*	Weight*		
1512-8M	0.364	0.548	0.908	1.545	1512	189
1520-8M	0.371	0.559	0.928	1.578	1520	190
1584-8M	0.379	0.569	0.947	1.610	1584	198
1600-8M	0.387	0.580	0.966	1.643	1600	200
1728-8M	0.406	0.609	1.015	1.725	1728	216
1760-8M	0.425	0.638	1.063	1.807	1760	220
1800-8M	0.435	0.652	1.087	1.848	1800	225
1904-8M	0.459	0.689	1.148	1.951	1904	238
2000-8M	0.483	0.725	1.208	2.054	2000	250
2056-8M	0.493	0.740	1.233	2.096	2056	257
2080-8M	0.503	0.755	1.258	2.138	2080	260
2104-8M	0.513	0.770	1.283	2.180	2104	263
2160-8M	0.523	0.785	1.308	2.220	2160	270
2240-8M	0.533	0.800	1.333	2.264	2240	280
2248-8M	0.543	0.815	1.358	2.308	2248	281
2272-8M	0.562	0.843	1.404	2.386	2272	284
2400-8M	0.580	0.870	1.450	2.464	2400	300
2504-8M	0.604	0.906	1.510	2.567	2504	313
2600-8M	0.628	0.942	1.570	2.670	2600	325
2800-8M	0.676	1.015	1.691	2.875	2800	350
3048-8M	0.736	1.105	1.841	3.130	3048	381
3200-8M	0.764	1.147	1.911	3.249	3200	400
3280-8M	0.792	1.189	1.981	3.368	3280	410
3360-8M	0.831	1.247	2.078	3.532	3360	420
3600-8M	0.870	1.305	2.174	3.696	3600	450
4400-8M	1.063	1.595	2.658	4.518	4400	550

\* Weights shown are approximate.

Other widths available. Contact BANDO for price and delivery.

Synchro-Link® HT Timing Belts - Neoprene (Metric)

## Tensioning for Synchro-Link® HT Belts

Belt Size	Belt Width (mm)												
		6	9	15	20	25	30	40	50	55	85	115	170
3M	Min	0.4	0.6	1.5									
	Max	0.6	0.9	2.0									
5M	Min		1.5	2.0		3.0							
	Max		2.0	3.0		4.0							
8M	Min				4.0		6.0		12		16		
	Max				6.0		8.0		15		20		
14M	Min							10		15	23	32	42
	Max							14		19	28	39	50

Refer to page 133 for proper tensioning procedures and use of values in this table. Values shown are lbs.





### Nominal Dimensions

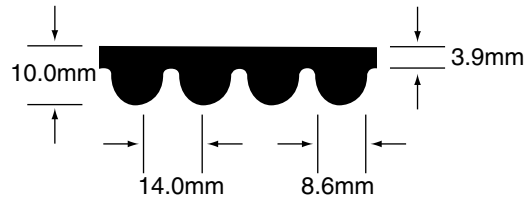

### Part Number Example



For example, a 40mm wide 966-14M is part number 966-14M-40.

Synchro-Link® HT Timing Belts - Neoprene (Metric)

### HT - 14mm Pitch for 40mm, 55mm, 85mm, 115mm and 170mm Wide Belts

Part Number	40mm Wide	55mm Wide	85mm Wide	115mm Wide	170mm Wide	Pitch Length (mm)	Number of Teeth
	Weight*	Weight*	Weight*	Weight*	Weight*		
966-14M	0.852	1.172	1.811	2.450	3.621	966	69
1092-14M	0.951	1.308	2.021	2.734	4.041	1092	78
1190-14M	1.050	1.443	2.230	3.018	4.461	1190	85
1344-14M	1.143	1.571	2.427	3.284	4.855	1344	96
1400-14M	1.235	1.698	2.624	3.550	5.248	1400	100
1456-14M	1.297	1.783	2.755	3.728	5.510	1456	104
1540-14M	1.359	1.868	2.886	3.906	5.772	1540	110
1610-14M	1.420	1.953	3.018	4.083	6.035	1610	115
1680-14M	1.494	2.055	3.175	4.296	6.350	1680	120
1778-14M	1.568	2.156	3.332	4.509	6.665	1778	127
1890-14M	1.667	2.292	3.542	4.793	7.085	1890	135
2002-14M	1.760	2.420	3.739	5.066	7.479	2002	143
2100-14M	1.852	2.547	3.936	5.375	7.872	2100	150
2198-14M	1.945	2.674	4.133	5.617	8.266	2198	157
2310-14M	2.037	2.801	4.330	5.858	8.659	2310	165
2450-14M	2.161	2.971	4.592	6.213	9.184	2450	175
2590-14M	2.284	3.141	4.854	6.568	9.709	2590	185
2800-14M	2.470	3.396	5.248	7.100	10.496	2800	200
3150-14M	2.778	3.820	5.904	7.988	11.808	3150	225
3360-14M	2.964	4.075	6.297	8.520	12.595	3360	240
3500-14M	3.087	4.245	6.560	8.875	13.120	3500	250
3850-14M	3.396	4.669	7.216	9.763	14.432	3850	275
4004-14M	3.606	4.958	7.662	10.367	15.324	4004	286
4326-14M	3.816	5.246	8.108	10.970	16.216	4326	309
4578-14M	4.038	5.552	8.580	11.609	17.161	4578	327
4956-14M	4.371	6.010	9.289	12.567	18.578	4956	354

\* Weights shown are approximate.

Other widths available. Contact BANDO for price and delivery.



### Nominal Dimensions

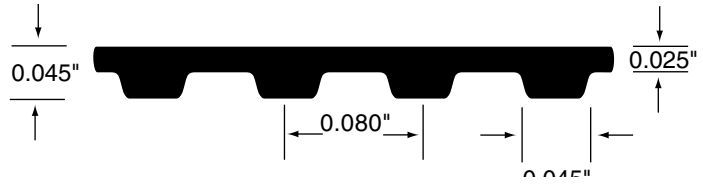

### Part Number Example

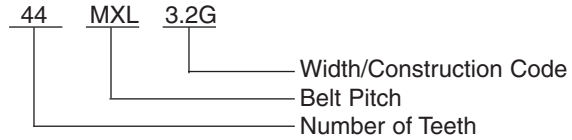

Part number includes the width/construction suffix in parenthesis below.  
Example, a 1/8" wide 44MXL is a part number 44MXL3.2G.

## MXL - .080 Inch Pitch for 3.2mm, 4.8mm and 6.4mm Wide Belts

Part Number	1/8" - 3.2mm Wide (3.2G)	3/16" - 4.8mm Wide (4.8G)	1/4" - 6.4mm Wide (6.4G)	Pitch Length (in)	Number of Teeth
	Weight*	Weight*	Weight*		
44MXL	0.001	0.001	0.002	3.52	44
45MXL	0.001	0.001	0.002	3.60	45
48MXL	0.001	0.001	0.002	3.84	48
50MXL	0.001	0.001	0.002	4.00	50
52MXL	0.001	0.001	0.002	4.16	52
53MXL	0.001	0.001	0.002	4.24	53
54MXL	0.001	0.002	0.002	4.32	54
55MXL	0.001	0.002	0.002	4.40	55
56MXL	0.001	0.002	0.002	4.48	56
57MXL	0.001	0.002	0.002	4.56	57
58MXL	0.001	0.002	0.002	4.64	58
59MXL	0.001	0.002	0.002	4.72	59
60MXL	0.001	0.002	0.002	4.80	60
61MXL	0.001	0.002	0.002	4.88	61
62MXL	0.001	0.002	0.002	4.96	62
63MXL	0.001	0.002	0.002	5.04	63
64MXL	0.001	0.002	0.002	5.12	64
65MXL	0.001	0.002	0.002	5.20	65
67MXL	0.001	0.002	0.002	5.36	67
68MXL	0.001	0.002	0.002	5.44	68
69MXL	0.001	0.002	0.002	5.52	69
70MXL	0.001	0.002	0.003	5.60	70
71MXL	0.001	0.002	0.003	5.68	71
72MXL	0.001	0.002	0.003	5.76	72
73MXL	0.001	0.002	0.003	5.84	73
74MXL	0.001	0.002	0.003	5.92	74
75MXL	0.001	0.002	0.003	6.00	75
76MXL	0.001	0.002	0.003	6.08	76
77MXL	0.001	0.002	0.003	6.16	77
78MXL	0.001	0.002	0.003	6.24	78
79MXL	0.001	0.002	0.003	6.32	79
80MXL	0.001	0.002	0.003	6.40	80
81MXL	0.001	0.002	0.003	6.48	81
82MXL	0.002	0.002	0.003	6.56	82
83MXL	0.002	0.002	0.003	6.64	83
85MXL	0.002	0.002	0.003	6.80	85
86MXL	0.002	0.002	0.003	6.88	86
87MXL	0.002	0.002	0.003	6.89	87
88MXL	0.002	0.002	0.003	7.04	88
90MXL	0.002	0.002	0.003	7.20	90
91MXL	0.002	0.002	0.003	7.28	91
92MXL	0.002	0.003	0.003	7.36	92
93MXL	0.002	0.003	0.003	7.44	93
94MXL	0.002	0.003	0.003	7.52	94
95MXL	0.002	0.003	0.003	7.60	95

Synchro-Link® Timing Belts - Neoprene (RMA)

\* Weights shown are approximate.

Other widths available. Contact BANDO for price and delivery.



## MXL - .080 Inch Pitch for 3.2mm, 4.8mm and 6.4mm Wide Belts (Continued)

Part Number	1/8" - 3.2mm Wide (3.2G)	3/16" - 4.8mm Wide (4.8G)	1/4" - 6.4mm Wide (6.4G)	Pitch Length (in)	Number of Teeth
	Weight*	Weight*	Weight*		
96MXL	0.002	0.003	0.003	7.68	96
97MXL	0.002	0.003	0.004	7.76	97
98MXL	0.002	0.003	0.004	7.84	98
99MXL	0.002	0.003	0.004	7.92	99
100MXL	0.002	0.003	0.004	8.00	100
101MXL	0.002	0.003	0.004	8.08	101
102MXL	0.002	0.003	0.004	8.16	102
103MXL	0.002	0.003	0.004	8.24	103
104MXL	0.002	0.003	0.004	8.32	104
105MXL	0.002	0.003	0.004	8.40	105
106MXL	0.002	0.003	0.004	8.48	106
108MXL	0.002	0.003	0.004	8.64	108
109MXL	0.002	0.003	0.004	8.72	109
110MXL	0.002	0.003	0.004	8.80	110
112MXL	0.002	0.003	0.004	8.96	112
114MXL	0.002	0.003	0.004	9.12	114
115MXL	0.002	0.003	0.004	9.20	115
118MXL	0.002	0.003	0.004	9.44	118
119MXL	0.002	0.003	0.004	9.52	119
120MXL	0.002	0.003	0.004	9.60	120
121MXL	0.002	0.003	0.004	9.68	121
122MXL	0.002	0.003	0.004	9.76	122
123MXL	0.002	0.003	0.004	9.84	123
124MXL	0.002	0.003	0.005	9.92	124
125MXL	0.002	0.003	0.005	10.00	125
126MXL	0.002	0.003	0.005	10.08	126
127MXL	0.002	0.003	0.005	10.16	127
128MXL	0.002	0.003	0.005	10.24	128
129MXL	0.002	0.003	0.005	10.32	129
130MXL	0.002	0.003	0.005	10.40	130
131MXL	0.002	0.003	0.005	10.48	131
132MXL	0.002	0.003	0.005	10.56	132
134MXL	0.002	0.003	0.005	10.72	134
135MXL	0.003	0.004	0.005	10.80	135
137MXL	0.003	0.004	0.005	10.96	137
138MXL	0.003	0.004	0.005	11.04	138
140MXL	0.003	0.004	0.005	11.20	140
142MXL	0.003	0.004	0.005	11.36	142
144MXL	0.003	0.004	0.005	11.52	144
145MXL	0.003	0.004	0.005	11.60	145
146MXL	0.003	0.004	0.005	11.68	146
148MXL	0.003	0.004	0.005	11.84	148
150MXL	0.003	0.004	0.005	12.00	150
151MXL	0.003	0.004	0.006	12.08	151
155MXL	0.003	0.004	0.006	12.40	155
158MXL	0.003	0.004	0.006	12.64	158
159MXL	0.003	0.004	0.006	12.72	159
160MXL	0.003	0.004	0.006	12.80	160
162MXL	0.003	0.004	0.006	12.96	162
163MXL	0.003	0.004	0.006	13.04	163
164MXL	0.003	0.004	0.006	13.12	164
165MXL	0.003	0.004	0.006	13.20	165
169MXL	0.003	0.005	0.006	13.52	169
170MXL	0.003	0.005	0.006	13.60	170
175MXL	0.003	0.005	0.006	14.00	175
177MXL	0.003	0.005	0.006	14.16	177
180MXL	0.003	0.005	0.006	14.40	180
183MXL	0.003	0.005	0.007	14.64	183
184MXL	0.003	0.005	0.007	14.72	184
188MXL	0.004	0.006	0.008	15.04	188
190MXL	0.004	0.006	0.008	15.20	190
192MXL	0.004	0.006	0.008	15.36	192
195MXL	0.004	0.006	0.008	15.60	195
196MXL	0.004	0.006	0.008	15.68	196
200MXL	0.004	0.006	0.008	16.00	200

Synchro-Link® Timing Belts - Neoprene (RMA)

\* Weights shown are approximate.

Other widths available. Contact BANDO for price and delivery.



### MXL - .080 Inch Pitch for 3.2mm, 4.8mm and 6.4mm Wide Belts (Continued)

Part Number	1/8" - 3.2mm Wide (3.2G)	3/16" - 4.8mm Wide (4.8G)	1/4" - 6.4mm Wide (6.4G)	Pitch Length (in)	Number of Teeth
	Weight*	Weight*	Weight*		
204MXL	0.004	0.006	0.008	16.32	204
205MXL	0.004	0.006	0.008	16.40	205
208MXL	0.004	0.006	0.008	16.64	208
210MXL	0.004	0.006	0.008	16.80	210
212MXL	0.004	0.006	0.008	16.96	212
215MXL	0.004	0.006	0.008	17.20	215
220MXL	0.004	0.006	0.008	17.60	220
221MXL	0.004	0.006	0.008	17.68	221
222MXL	0.004	0.006	0.008	17.76	222
224MXL	0.004	0.006	0.008	17.92	224
225MXL	0.004	0.006	0.008	18.00	225
226MXL	0.004	0.006	0.008	18.08	226
228MXL	0.004	0.006	0.008	18.24	228
230MXL	0.004	0.006	0.008	18.40	230
232MXL	0.004	0.006	0.008	18.56	232
234MXL	0.004	0.006	0.008	18.72	234
236MXL	0.004	0.006	0.009	18.88	236
239MXL	0.004	0.006	0.009	19.12	239
240MXL	0.004	0.006	0.009	19.20	240
245MXL	0.004	0.007	0.009	19.60	245
248MXL	0.004	0.007	0.009	19.84	248
249MXL	0.005	0.007	0.009	19.92	249
250MXL	0.005	0.007	0.009	20.00	250
251MXL	0.005	0.007	0.009	20.08	251
255MXL	0.005	0.007	0.009	20.40	255
256MXL	0.005	0.007	0.009	20.48	256
260MXL	0.005	0.007	0.009	20.80	260
262MXL	0.005	0.007	0.010	20.96	262
265MXL	0.005	0.007	0.010	21.20	265
268MXL	0.005	0.007	0.010	21.44	268
271MXL	0.005	0.007	0.010	21.68	271
273MXL	0.005	0.007	0.010	21.84	273
275MXL	0.005	0.007	0.010	22.00	275
280MXL	0.005	0.008	0.010	22.40	280
281MXL	0.005	0.008	0.010	22.48	281
285MXL	0.005	0.008	0.011	22.80	285
288MXL	0.005	0.008	0.011	23.04	288
290MXL	0.005	0.008	0.011	23.20	290
295MXL	0.005	0.008	0.011	23.60	295
297MXL	0.005	0.008	0.011	23.76	297
300MXL	0.005	0.008	0.011	24.00	300
305MXL	0.006	0.008	0.011	24.40	305
308MXL	0.006	0.008	0.011	24.64	308
310MXL	0.006	0.008	0.011	24.80	310
312MXL	0.006	0.008	0.011	24.96	312
315MXL	0.006	0.009	0.011	25.20	315
318MXL	0.006	0.009	0.011	25.44	318
320MXL	0.006	0.009	0.012	25.60	320
323MXL	0.006	0.009	0.012	25.84	323
326MXL	0.006	0.009	0.012	26.08	326
328MXL	0.006	0.009	0.012	26.24	328
330MXL	0.006	0.009	0.012	26.40	330
332MXL	0.006	0.009	0.012	26.56	332
334MXL	0.006	0.009	0.012	26.72	334
336MXL	0.006	0.009	0.012	26.88	336
337MXL	0.006	0.009	0.012	26.96	337
347MXL	0.007	0.010	0.012	27.76	347
350MXL	0.007	0.010	0.013	28.00	350
354MXL	0.007	0.010	0.013	28.32	354
355MXL	0.007	0.010	0.013	28.40	355
358MXL	0.007	0.010	0.013	28.64	358
359MXL	0.007	0.010	0.013	28.72	359
360MXL	0.007	0.010	0.013	28.80	360
364MXL	0.007	0.010	0.013	29.12	364
365MXL	0.007	0.010	0.013	29.20	365

Synchro-Link® Timing Belts - Neoprene (RMA)

\* Weights shown are approximate.

Other widths available. Contact BANDO for price and delivery.



### MXL - .080 Inch Pitch for 3.2mm, 4.8mm and 6.4mm Wide Belts (Continued)

Part Number	1/8" - 3.2mm Wide (3.2G)	3/16" - 4.8mm Wide (4.8G)	1/4" - 6.4mm Wide (6.4G)	Pitch Length (in)	Number of Teeth
	Weight*	Weight*	Weight*		
371MXL	0.007	0.010	0.013	29.68	371
372MXL	0.007	0.010	0.013	29.76	372
380MXL	0.007	0.010	0.014	30.40	380
388MXL	0.007	0.010	0.014	31.04	388
397MXL	0.007	0.011	0.014	31.76	397
400MXL	0.007	0.011	0.015	32.00	400
402MXL	0.007	0.011	0.015	32.16	402
405MXL	0.007	0.011	0.015	32.40	405
410MXL	0.007	0.011	0.015	32.80	410
413MXL	0.007	0.011	0.015	33.04	413
425MXL	0.008	0.011	0.015	34.00	425
431MXL	0.008	0.011	0.015	34.48	431
434MXL	0.008	0.011	0.015	34.72	434
435MXL	0.008	0.012	0.016	34.80	435
440MXL	0.008	0.012	0.016	35.20	440
448MXL	0.008	0.012	0.016	35.84	448
453MXL	0.008	0.012	0.016	36.24	453
464MXL	0.008	0.012	0.016	37.12	464
468MXL	0.008	0.013	0.017	37.44	468
473MXL	0.009	0.013	0.017	37.84	473
475MXL	0.009	0.013	0.017	38.00	475
480MXL	0.009	0.013	0.017	38.40	480
487MXL	0.009	0.013	0.017	38.96	487
493MXL	0.009	0.013	0.018	39.44	493
498MXL	0.009	0.013	0.018	39.84	498
500MXL	0.009	0.013	0.018	40.00	500
516MXL	0.009	0.014	0.019	41.28	516
522MXL	0.009	0.014	0.019	41.76	522
524MXL	0.009	0.014	0.019	41.92	524
525MXL	0.009	0.014	0.019	42.00	525
535MXL	0.010	0.015	0.020	42.80	535
550MXL	0.010	0.015	0.020	44.00	550
591MXL	0.011	0.016	0.022	47.28	591
612MXL	0.012	0.017	0.024	48.96	612
665MXL	0.013	0.017	0.024	53.20	665

\* Weights shown are approximate.

Other widths available. Contact BANDO for price and delivery.

Synchro-Link® Timing Belts - Neoprene (RMA)

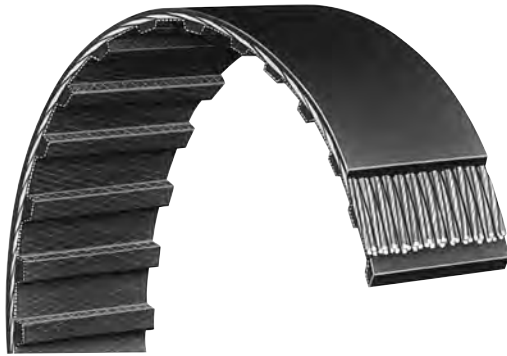

### Nominal Dimensions

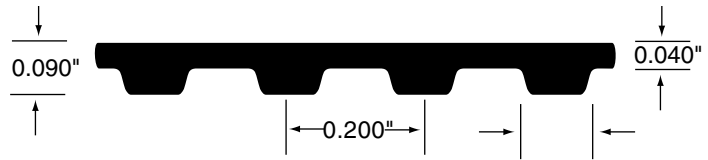

### Part Number Example

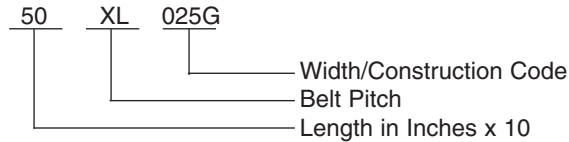

Part number includes the width/construction suffix in parenthesis below.  
Example: A 1/4" wide 50XL is a part number 50XL025G.

## XL - 1/5 Inch Pitch for 1/4" and 3/8" Wide Belts

Part Number	1/4" Wide (025G)		3/8" Wide (037G)		Pitch Length (in)	Number of Teeth
	Weight*	Weight*	Weight*	Weight*		
50XL	0.004	0.006	0.006	0.006	5.00	25
60XL	0.005	0.007	0.007	0.007	6.00	30
64XL	0.005	0.007	0.007	0.007	6.40	32
68XL	0.005	0.007	0.007	0.007	6.80	34
70XL	0.005	0.008	0.008	0.008	7.00	35
72XL	0.006	0.008	0.008	0.008	7.20	36
74XL	0.006	0.008	0.008	0.008	7.40	37
76XL	0.006	0.009	0.009	0.009	7.60	38
78XL	0.005	0.009	0.009	0.009	7.80	39
80XL	0.006	0.009	0.009	0.009	8.00	40
84XL	0.006	0.009	0.009	0.009	8.40	42
88XL	0.007	0.010	0.010	0.010	8.80	44
90XL	0.007	0.010	0.010	0.010	9.00	45
92XL	0.007	0.010	0.010	0.010	9.20	46
94XL	0.007	0.011	0.011	0.011	9.40	47
96XL	0.007	0.011	0.011	0.011	9.60	48
98XL	0.007	0.011	0.011	0.011	9.80	49
100XL	0.007	0.011	0.011	0.011	10.00	50
102XL	0.008	0.011	0.011	0.011	10.20	51
104XL	0.008	0.012	0.012	0.012	10.40	52
106XL	0.008	0.012	0.012	0.012	10.60	53
108XL	0.008	0.012	0.012	0.012	10.80	54
110XL	0.008	0.012	0.012	0.012	11.00	55
112XL	0.008	0.013	0.013	0.013	11.20	56
114XL	0.009	0.013	0.013	0.013	11.40	57
116XL	0.009	0.013	0.013	0.013	11.60	58
118XL	0.009	0.013	0.013	0.013	11.80	59
122XL	0.009	0.014	0.014	0.014	12.20	61
124XL	0.009	0.014	0.014	0.014	12.40	62
126XL	0.009	0.014	0.014	0.014	12.60	63
128XL	0.010	0.014	0.014	0.014	12.80	64
130XL	0.010	0.015	0.015	0.015	13.00	65
132XL	0.010	0.015	0.015	0.015	13.20	66
134XL	0.010	0.015	0.015	0.015	13.40	67
136XL	0.010	0.015	0.015	0.015	13.60	68
138XL	0.010	0.015	0.015	0.015	13.80	69
140XL	0.010	0.016	0.016	0.016	14.00	70
142XL	0.011	0.016	0.016	0.016	14.20	71
144XL	0.011	0.016	0.016	0.016	14.40	72
146XL	0.011	0.016	0.016	0.016	14.60	73
148XL	0.011	0.017	0.017	0.017	14.80	74
150XL	0.011	0.017	0.017	0.017	15.00	75
152XL	0.011	0.017	0.017	0.017	15.20	76
154XL	0.012	0.017	0.017	0.017	15.40	77
156XL	0.012	0.017	0.017	0.017	15.60	78

\* Weights shown are approximate.

Other widths available. Contact BANDO for price and delivery.

Synchro-Link® Timing Belts - Neoprene (RMA)



## XL - 1/5 Inch Pitch for 1/4" and 3/8" Wide Belts (Continued)

Part Number	1/4" Wide (025G)	3/8" Wide (037G)	Pitch Length (in)	Number of Teeth
	Weight*	Weight*		
158XL	0.012	0.018	15.80	79
160XL	0.012	0.018	16.00	80
162XL	0.012	0.018	16.20	81
164XL	0.012	0.018	16.40	82
166XL	0.012	0.019	16.60	83
168XL	0.013	0.019	16.80	84
170XL	0.013	0.019	17.00	85
172XL	0.013	0.019	17.20	86
174XL	0.013	0.019	17.40	87
176XL	0.013	0.020	17.60	88
178XL	0.013	0.020	17.80	89
180XL	0.013	0.020	18.00	90
182XL	0.014	0.020	18.20	91
184XL	0.014	0.021	18.40	92
188XL	0.014	0.021	18.80	94
190XL	0.014	0.021	19.00	95
194XL	0.014	0.022	19.40	97
196XL	0.015	0.022	19.60	98
198XL	0.015	0.022	19.80	99
200XL	0.015	0.022	20.00	100
202XL	0.015	0.023	20.20	101
206XL	0.015	0.023	20.60	103
208XL	0.016	0.023	20.80	104
210XL	0.016	0.023	21.00	105
212XL	0.016	0.024	21.20	106
214XL	0.016	0.024	21.40	107
216XL	0.016	0.025	21.60	108
220XL	0.016	0.025	22.00	110
222XL	0.017	0.026	22.20	111
224XL	0.017	0.026	22.40	112
228XL	0.017	0.026	22.80	114
230XL	0.017	0.026	23.00	115
234XL	0.017	0.026	23.40	117
240XL	0.018	0.027	24.00	120
244XL	0.018	0.027	24.40	122
248XL	0.019	0.028	24.80	124
250XL	0.019	0.028	25.00	125
260XL	0.019	0.029	26.00	130
262XL	0.020	0.029	26.20	131
266XL	0.020	0.030	26.60	133
270XL	0.020	0.030	27.00	135
276XL	0.021	0.031	27.60	138
280XL	0.021	0.031	28.00	140
282XL	0.021	0.032	28.20	141
290XL	0.022	0.032	29.00	145
300XL	0.022	0.034	30.00	150
310XL	0.023	0.035	31.00	155
314XL	0.023	0.035	31.40	157
320XL	0.024	0.036	32.00	160
322XL	0.024	0.036	32.20	161
330XL	0.025	0.037	33.00	165
340XL	0.025	0.038	34.00	170
344XL	0.026	0.038	34.40	172
348XL	0.026	0.039	34.80	174
352XL	0.026	0.039	35.20	176
356XL	0.027	0.040	35.60	178
360XL	0.027	0.040	36.00	180
364XL	0.027	0.041	36.40	182
370XL	0.028	0.041	37.00	185
372XL	0.028	0.042	37.20	186
376XL	0.028	0.042	37.60	188
384XL	0.029	0.043	38.40	192
386XL	0.029	0.043	38.60	193
388XL	0.029	0.043	38.80	194
390XL	0.029	0.044	39.00	195

Synchro-Link® Timing Belts - Neoprene (RMA)

\* Weights shown are approximate.

Other widths available. Contact BANDO for price and delivery.





## XL - 1/5 Inch Pitch for 1/4" and 3/8" Wide Belts (Continued)

Part Number	1/4" Wide (025G)	3/8" Wide (037G)	Pitch Length (in)	Number of Teeth
	Weight*	Weight*		
396XL	0.030	0.044	39.60	198
400XL	0.030	0.045	40.00	200
408XL	0.030	0.046	40.80	204
424XL	0.032	0.047	42.40	212
430XL	0.032	0.048	43.00	215
450XL	0.034	0.050	45.00	225
456XL	0.034	0.051	45.60	228
460XL	0.034	0.051	46.00	230
470XL	0.035	0.053	47.00	235
490XL	0.037	0.055	49.00	245
496XL	0.038	0.056	49.60	248
510XL	0.038	0.057	51.00	255
540XL	0.040	0.060	54.00	270
564XL	0.042	0.063	56.40	282
592XL	0.044	0.066	59.20	296
608XL	0.045	0.068	60.80	304
630XL	0.047	0.070	63.00	315
638XL	0.048	0.071	63.80	319
686XL	0.055	0.082	68.60	343
828XL	0.062	0.092	82.80	414
860XL	0.064	0.096	86.00	430
888XL	0.066	0.099	88.80	444
900XL	0.067	0.101	90.00	450
908XL	0.068	0.102	90.80	454
914XL	0.068	0.102	91.40	457
926XL	0.069	0.103	92.60	463
1014XL	0.076	0.113	101.40	507
1020XL	0.076	0.114	102.00	510

\* Weights shown are approximate.

Other widths available. Contact BANDO for price and delivery.

Synchro-Link® Timing Belts - Neoprene (RMA)

## Minimum Recommended Pulley Sizes

Using pulley sizes less than the recommended minimum can substantially reduce belt life and drive efficiency. Values shown are number of pulley teeth.

Speed Range (RPM)	MXL	XL	L	H	XH	XXH
<b>0 - 870</b>	NA	10	12	14	22	22
<b>870 - 1160</b>	12	10	12	16	24	24
<b>1160 - 1750</b>	14	12	14	18	26	26
<b>1750 - 3500</b>	16	12	16	20	30	NA
<b>3500 - over</b>	16	14	18	22	NA	NA



### Nominal Dimensions

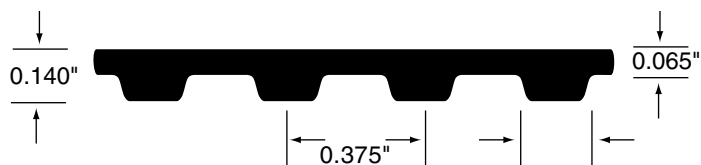

### Part Number Example

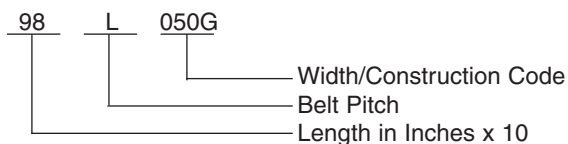

Part number includes the width/construction suffix in parenthesis below.  
For example, a 1/2" wide 98L is a part number 98L050G.

## L - 3/8 Inch Pitch 1/2", 3/4" and 1" Wide Belts

Synchro-Link® Timing Belts - Neoprene (RMA)

Part Number	1/2" Wide (050G)	3/4" Wide (075G)	1" Wide (100G)	Pitch Length (in)	Number of Teeth
	Weight*	Weight*	Weight*		
98L	0.023	0.034	0.046	9.75	26
109L	0.026	0.039	0.052	10.88	29
124L	0.029	0.044	0.058	12.38	33
135L	0.032	0.047	0.063	13.50	36
150L	0.035	0.053	0.070	15.00	40
165L	0.039	0.058	0.077	16.50	44
169L	0.040	0.059	0.079	16.88	45
172L	0.040	0.061	0.081	17.25	46
187L	0.044	0.066	0.088	18.75	50
203L	0.048	0.071	0.095	20.25	54
210L	0.049	0.074	0.098	21.00	56
218L	0.051	0.077	0.104	21.75	58
225L	0.053	0.079	0.110	22.50	60
240L	0.056	0.084	0.113	24.00	64
248L	0.058	0.087	0.117	24.75	66
255L	0.060	0.090	0.120	25.50	68
263L	0.062	0.093	0.123	26.25	70
270L	0.063	0.095	0.127	27.00	72
277L	0.065	0.097	0.130	27.75	74
285L	0.067	0.101	0.134	28.50	76
300L	0.070	0.106	0.141	30.00	80
304L	0.071	0.107	0.143	30.38	81
315L	0.074	0.111	0.148	31.50	84
320L	0.075	0.113	0.150	31.88	85
322L	0.076	0.113	0.151	32.25	86
334L	0.078	0.117	0.157	33.38	89
337L	0.079	0.119	0.158	33.75	90
345L	0.081	0.121	0.162	34.50	92
360L	0.084	0.127	0.169	36.00	96
367L	0.086	0.129	0.172	36.75	98
375L	0.088	0.132	0.176	37.50	100
382L	0.090	0.134	0.179	38.25	102
390L	0.091	0.137	0.183	39.00	104
394L	0.092	0.139	0.185	39.38	105
420L	0.098	0.148	0.197	42.00	112
427L	0.100	0.150	0.200	42.75	114
436L	0.102	0.153	0.204	43.50	116
439L	0.103	0.154	0.206	43.88	117
446L	0.105	0.157	0.209	44.63	119
450L	0.106	0.158	0.211	45.00	120
465L	0.109	0.164	0.218	46.50	124
480L	0.113	0.169	0.225	48.00	128
510L	0.120	0.179	0.239	51.00	136
514L	0.121	0.181	0.241	51.38	137
525L	0.123	0.185	0.246	52.50	140

\* Weights shown are approximate.

Other widths available. Contact BANDO for price and delivery.



### L - 3/8 Inch Pitch 1/2", 3/4" and 1" Wide Belts (Continued)

Part Number	1/2" Wide (050G)	3/4" Wide (075G)	1" Wide (100G)	Pitch Length (in)	Number of Teeth
	Weight*	Weight*	Weight*		
540L	0.127	0.190	0.253	54.00	144
548L	0.129	0.193	0.257	54.75	146
581L	0.136	0.204	0.272	58.13	155
600L	0.141	0.211	0.281	60.00	160
605L	0.142	0.213	0.284	60.38	161
619L	0.145	0.218	0.290	61.88	165
630L	0.148	0.222	0.295	63.00	168
640L	0.150	0.225	0.300	63.75	170
653L	0.153	0.230	0.306	65.25	174
660L	0.155	0.232	0.310	66.00	176
697L	0.163	0.245	0.327	69.75	186
728L	0.171	0.256	0.341	72.75	194
731L	0.171	0.257	0.343	73.13	195
767L	0.180	0.270	0.360	76.88	205
780L	0.183	0.274	0.366	78.00	208
788L	0.185	0.277	0.370	78.75	210
806L	0.189	0.284	0.378	80.63	215
855L	0.200	0.301	0.401	85.50	228
863L	0.202	0.304	0.405	86.25	230
881L	0.207	0.310	0.413	88.13	235
915L	0.215	0.322	0.429	91.50	244
919L	0.216	0.323	0.431	91.88	245
938L	0.220	0.330	0.440	93.75	250
1294L	0.296	0.406	0.516	129.38	345

\* Weights shown are approximate.

Other widths available. Contact BANDO for price and delivery.

Synchro-Link® Timing Belts - Neoprene (RMA)



### Nominal Dimensions

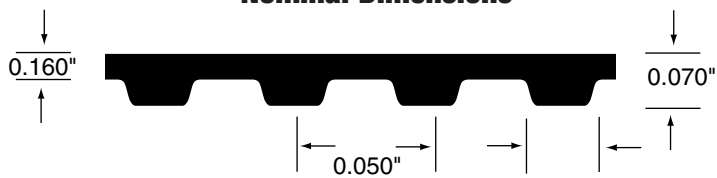

### Part Number Example

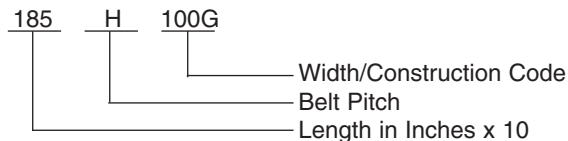

Part number includes the width/construction suffix in parenthesis below.  
 Example: A 1" wide 185H is a part number 185H100G.

## H - 1/2 Inch Pitch for 1", 1-1/2", 2" and 3" Wide Belts

Synchro-Link® Timing Belts - Neoprene (RMA)

Part Number	1" Wide (100G)	1-1/2" Wide (150G)	2" Wide (200G)	3" Wide (300G)	Pitch Length (in)	Number of Teeth
	Weight*	Weight*	Weight*	Weight*		
185H	0.107	0.161	0.215	0.322	18.50	37
225H	0.120	0.181	0.241	0.361	22.50	45
230H	0.133	0.200	0.267	0.400	23.00	46
240H	0.139	0.209	0.278	0.418	24.00	48
245H	0.142	0.213	0.284	0.426	24.50	49
270H	0.157	0.235	0.313	0.470	27.00	54
280H	0.162	0.244	0.325	0.487	28.00	56
300H	0.174	0.261	0.348	0.522	30.00	60
310H	0.180	0.270	0.360	0.539	31.00	62
315H	0.183	0.274	0.365	0.548	31.50	63
320H	0.186	0.278	0.371	0.557	32.00	64
330H	0.191	0.287	0.383	0.574	33.00	66
340H	0.197	0.296	0.394	0.592	34.00	68
350H	0.203	0.305	0.406	0.609	35.00	70
360H	0.209	0.313	0.418	0.627	36.00	72
370H	0.215	0.322	0.429	0.644	37.00	74
375H	0.218	0.326	0.435	0.653	37.50	75
390H	0.226	0.339	0.452	0.679	39.00	78
400H	0.232	0.348	0.464	0.696	40.00	80
410H	0.238	0.357	0.476	0.714	41.00	82
420H	0.244	0.365	0.487	0.731	42.00	84
430H	0.249	0.374	0.499	0.748	43.00	86
450H	0.261	0.392	0.522	0.783	45.00	90
465H	0.270	0.405	0.539	0.809	46.50	93
480H	0.278	0.418	0.557	0.835	48.00	96
490H	0.284	0.426	0.568	0.853	49.00	98
510H	0.296	0.444	0.592	0.888	51.00	102
530H	0.307	0.461	0.615	0.922	53.00	106
540H	0.313	0.470	0.627	0.940	54.00	108
560H	0.325	0.487	0.650	0.975	56.00	112
565H	0.328	0.492	0.656	0.984	56.50	113
570H	0.331	0.496	0.661	0.992	57.00	114
580H	0.336	0.505	0.673	1.009	58.00	116
600H	0.348	0.522	0.696	1.044	60.00	120
605H	0.351	0.526	0.702	1.053	60.50	121
630H	0.365	0.548	0.731	1.096	63.00	126
640H	0.371	0.575	0.743	1.114	64.00	128
650H	0.377	0.566	0.754	1.131	65.00	130
660H	0.383	0.574	0.766	1.149	66.00	132
680H	0.394	0.592	0.789	1.183	68.00	136
700H	0.406	0.609	0.812	1.218	70.00	140
730H	0.423	0.635	0.847	1.270	73.00	146
750H	0.435	0.653	0.870	1.305	75.00	150
760H	0.441	0.661	0.882	1.323	76.00	152
770H	0.447	0.670	0.893	1.340	77.00	154

\* Weights shown are approximate.

Other widths available. Contact BANDO for price and delivery.



### H - 1/2 Inch Pitch for 1", 1-1/2", 2" and 3" Wide Belts (Continued)

Part Number	1" Wide (100G)	1-1/2" Wide (150G)	2" Wide (200G)	3" Wide (300G)	Pitch Length (in)	Number of Teeth
	Weight*	Weight*	Weight*	Weight*		
800H	0.464	0.696	0.928	1.392	80.00	160
810H	0.470	0.705	0.940	1.410	81.00	162
820H	0.476	0.714	0.951	1.427	82.00	164
840H	0.487	0.731	0.975	1.462	84.00	168
850H	0.493	0.740	0.986	1.479	85.00	170
860H	0.499	0.748	0.998	1.497	86.00	172
880H	0.510	0.766	1.021	1.531	88.00	176
900H	0.522	0.783	1.044	1.566	90.00	180
950H	0.551	0.827	1.102	1.653	95.00	190
985H	0.571	0.857	1.143	1.714	98.50	197
1000H	0.580	0.870	1.160	1.740	100.00	200
1020H	0.592	0.888	1.183	1.775	102.00	204
1050H	0.609	0.914	1.218	1.827	105.00	210
1100H	0.638	0.957	1.276	1.914	110.00	220
1130H	0.650	0.975	1.300	1.949	113.00	226
1140H	0.661	0.992	1.323	1.984	114.00	228
1250H	0.725	1.088	1.450	2.175	125.00	250
1325H	0.769	1.153	1.537	2.306	132.50	265
1350H	0.783	1.175	1.566	2.349	135.00	270
1400H	0.812	1.218	1.624	2.436	140.00	280
1680H	0.899	1.349	1.798	2.698	168.00	336
1700H	0.986	1.479	1.972	2.959	170.00	340

\* Weights shown are approximate.

Other widths available. Contact BANDO for price and delivery.

Synchro-Link® Timing Belts - Neoprene (RMA)



**Nominal Dimensions**

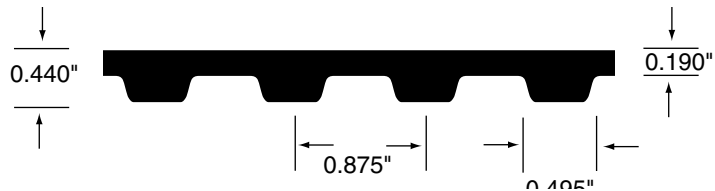

**Part Number Example**

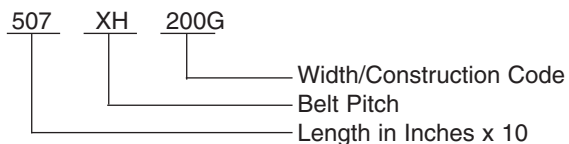

Part number includes the width/construction suffix in parenthesis below. Example, a 2" wide 507XH is a part number 507XH200G.

Synchro-Link® Timing Belts - Neoprene (RMA)

**XH - 7/8 Inch Pitch for 2", 3" and 4" Wide Belts**

Part Number	2" Wide (200G)	3" Wide (300G)	4" Wide (400G)	Pitch Length (in)	Number of Teeth
	Weight*	Weight*	Weight*		
507XH	1.498	2.247	2.996	50.75	58
560XH	1.654	2.482	3.309	56.00	64
630XH	1.861	2.792	3.723	63.00	72
700XH	2.068	3.102	4.136	70.00	80
735XH	2.172	3.257	4.343	73.50	84
770XH	2.275	3.412	4.550	77.00	88
840XH	2.482	3.723	4.963	84.00	96
875XH	2.585	3.878	5.170	87.50	100
927XH	2.740	4.111	5.481	92.75	106
980XH	2.895	4.343	5.791	98.00	112
1120XH	3.309	4.963	6.618	112.00	128
1260XH	3.723	5.584	7.445	126.00	144
1400XH	4.136	6.204	8.272	140.00	160
1540XH	4.550	6.825	9.100	154.00	176
1750XH	5.170	7.755	10.340	175.00	200

\* Weights shown are approximate.

Other widths available. Contact BANDO for price and delivery.

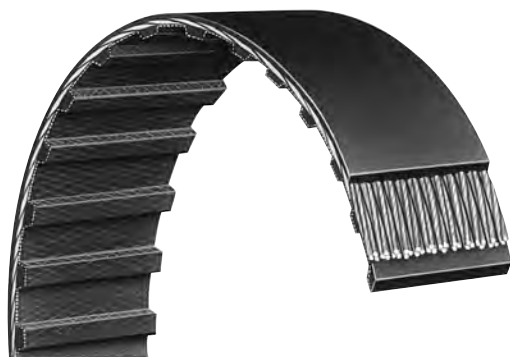

### Nominal Dimensions

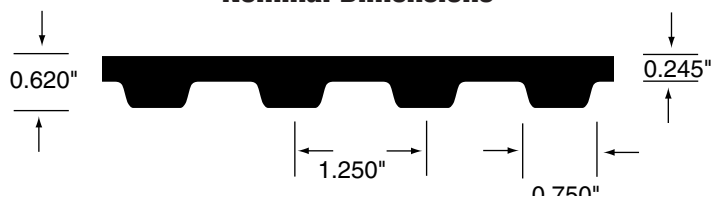

### Part Number Example

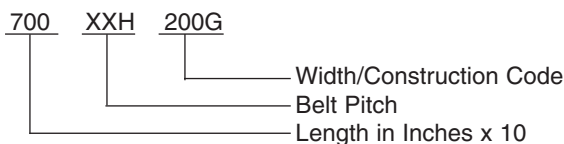

Part number includes the width/construction suffix in parenthesis below.  
Example, a 2" wide 700XXH is a part number 700XXH200G.

## XXH - 1-1/4 Inch Pitch for 2", 3", 4" and 5" Wide Belts

Part Number	2" Wide (200G)	3" Wide (300G)	4" Wide (400G)	5" Wide (500G)	Pitch Length (in)	Number of Teeth
	Weight*	Weight*	Weight*	Weight*		
700XXH	3.049	4.574	6.098	7.623	70.00	56
800XXH	3.485	5.227	6.970	8.712	80.00	64
900XXH	3.920	5.881	7.841	9.801	90.00	72
1000XXH	4.356	6.534	8.712	10.890	100.00	80
1200XXH	5.227	7.841	10.454	13.068	120.00	96
1400XXH	6.098	9.148	12.197	15.246	140.00	112
1600XXH	6.970	10.454	13.939	17.424	160.00	128
1800XXH	7.841	11.761	15.682	19.602	180.00	144
1915XXH	8.277	12.415	16.554	20.691	191.25	153

\* Weights shown are approximate.

Other widths available. Contact BANDO for price and delivery.

## Synchro-Link® Operating Conditions

BANDO Synchro-Link® belts will yield maximum service life providing they are not subjected to conditions that exceed their operating capabilities.

- Allowable ambient temperature range – neoprene  
-22°F to +194°F  
-30°C to +90°C
- Allowable ambient temperature range – polyurethane  
-22°F to +176°F  
-30°C to +80°C
- Maximum allowable operating speed – neoprene  
7,000 feet/min
- Maximum allowable operating speed – polyurethane  
4,000 feet/min

For applications that exceed these limits, consult BANDO Engineering for assistance in drive design and selection.

Synchro-Link® Timing Belts - Neoprene (RMA)



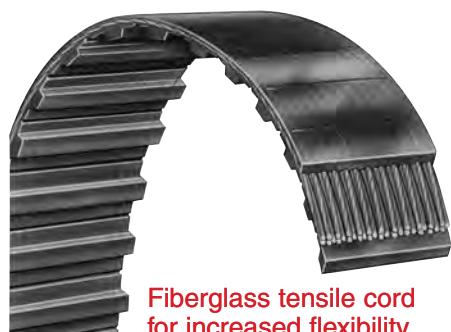

Fiberglass tensile cord for increased flexibility and greater durability.

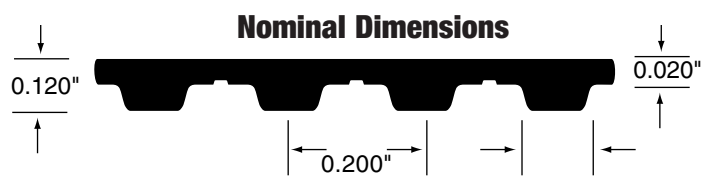

**Part Number Example**

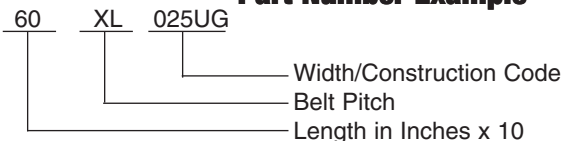

Part number includes the width/construction suffix in parenthesis below. Example, a 1/4" wide 60XL is a part number 60XL025UG.

**XL - 1/5 Inch Pitch for 1/4" and 3/8" Wide Belts**

Synchro-Link® Timing Belts - Polyurethane (RMA)

Part Number	1/4" Wide (025UG)	3/8" Wide (037UG)	Pitch Length (in)	Number of Teeth
	Weight*	Weight*		
60XL	0.006	0.007	6.00	30
70XL	0.007	0.008	7.00	35
80XL	0.008	0.009	8.00	40
90XL	0.009	0.010	9.00	45
96XL	0.010	0.011	9.60	48
100XL	0.010	0.011	10.00	50
102XL	0.110	0.011	10.20	51
110XL	0.011	0.012	11.00	55
114XL	0.012	0.013	11.40	57
120XL	0.013	0.014	12.00	60
130XL	0.014	0.015	13.00	65
140XL	0.015	0.016	14.00	70
150XL	0.016	0.017	15.00	75
154XL	0.016	0.017	15.40	77
156XL	0.017	0.018	15.60	78
160XL	0.017	0.018	16.00	80
166XL	0.017	0.018	16.60	83
168XL	0.018	0.019	16.80	84
170XL	0.018	0.019	17.00	85
180XL	0.019	0.020	18.00	90
190XL	0.020	0.021	19.00	95
198XL	0.021	0.022	19.80	99
200XL	0.021	0.022	20.00	100
202XL	0.022	0.023	20.20	101
210XL	0.022	0.023	21.00	105
212XL	0.023	0.024	21.20	106
220XL	0.023	0.024	22.00	110
230XL	0.024	0.025	23.00	115
236XL	0.025	0.026	23.60	118
240XL	0.025	0.026	24.00	120
250XL	0.026	0.027	25.00	125
254XL	0.027	0.028	25.40	127
260XL	0.027	0.028	26.00	130
290XL	0.027	0.028	29.00	145
300XL	0.028	0.029	30.00	150
320XL	0.028	0.029	32.00	160
330XL	0.029	0.030	33.00	165
376XL	0.029	0.030	37.60	188
396XL	0.030	0.031	39.60	198
414XL	0.030	0.031	41.40	207
430XL	0.031	0.032	43.00	215
460XL	0.033	0.034	46.00	230
478XL	0.034	0.035	47.80	239
480XL	0.035	0.036	48.00	240
490XL	0.036	0.037	49.00	245
512XL	0.038	0.039	51.20	256
564XL	0.039	0.040	56.40	282
630XL	0.040	0.041	63.00	315
670XL	0.041	0.042	67.00	335
686XL	0.043	0.044	68.60	343
730XL	0.044	0.045	73.00	365

\* Weights shown are approximate.

Other widths available. Contact BANDO for price and delivery.

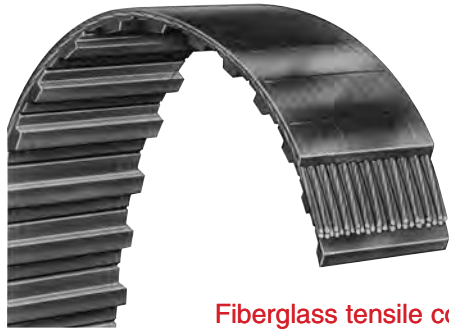

Fiberglass tensile cord for increased flexibility and greater durability.

### Nominal Dimensions

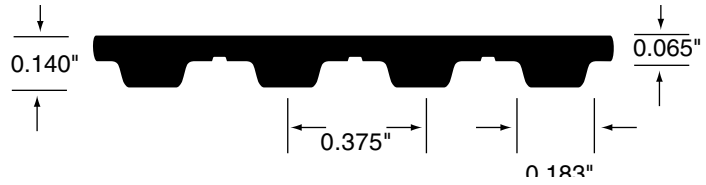

### Part Number Example

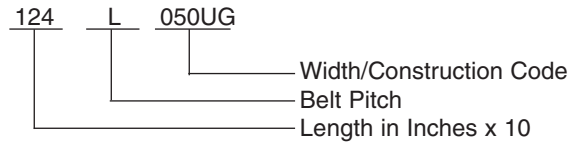

Part number includes the width/construction suffix in parenthesis below. Example, a 1/2" wide 124L is a part number 124L050UG.

## L - 3/8 Inch Pitch for 1/2", 3/4" and 1" Wide Belts

Part Number	1/2" Wide (050UG)	3/4" Wide (075UG)	1" Wide (100UG)	Pitch Length (in)	Number of Teeth
	Weight*	Weight*	Weight*		
124L	0.020	0.050	0.070	12.38	33
150L	0.030	0.060	0.078	15.00	40
165L	0.039	0.063	0.082	16.50	44
187L	0.040	0.070	0.090	18.75	50
210L	0.040	0.080	0.100	21.00	56
225L	0.050	0.080	0.110	22.50	60
240L	0.060	0.090	0.120	24.00	64
255L	0.060	0.090	0.130	25.50	68
270L	0.060	0.100	0.130	27.00	72
285L	0.070	0.100	0.140	28.50	76
300L	0.070	0.110	0.150	30.00	80
322L	0.080	0.120	0.160	32.25	86
345L	0.080	0.123	0.170	34.50	92
360L	0.085	0.128	0.170	36.00	96
367L	0.090	0.130	0.180	36.75	98
390L	0.090	0.140	0.190	39.00	104
420L	0.099	0.148	0.198	42.00	112
450L	0.106	0.159	0.212	45.00	120
480L	0.120	0.170	0.240	48.00	128
510L	0.123	0.183	0.250	51.00	136
540L	0.127	0.197	0.260	54.00	144
600L	0.130	0.210	0.270	60.00	160

\* Weights shown are approximate.

Other widths available. Contact BANDO for price and delivery.

## Synchro-Link® Belt Handling

BANDO Synchro-Link® handling during storage and shipping requires some additional precautions to ensure optimum belt life.

- A. Synchro-Link® belts should be stored and packaged in such a way as to avoid any sharp bends or "crimping" which will cause internal damage to the belt tension members.
- B. Store Synchro-Link® belts where they are protected from extremes in temperature, high ambient moisture or direct sunlight.

Synchro-Link® Timing Belts - Polyurethane (RMA)



### Nominal Dimensions

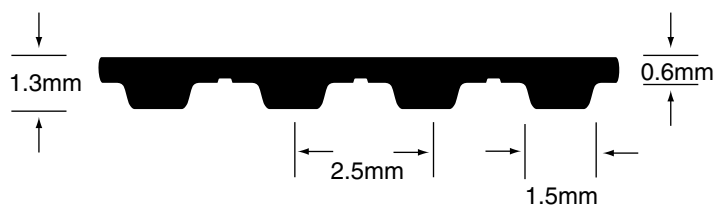

### Part Number Example

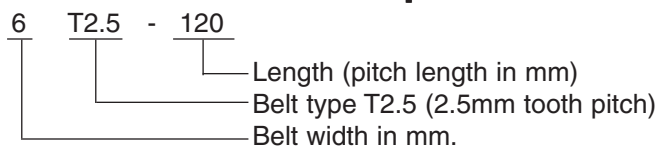

## T2.5 - 2.5mm Pitch for 3mm, 4mm, 6mm, 8mm, 10mm and 12mm Wide Belts

Part Number	Pitch Length		Number of Teeth
	(in)	(mm)	
T2.5-120	4.72	120.0	48
T2.5-145	5.71	145.0	58
T2.5-160	6.30	160.0	64
T2.5-177.5	6.99	177.5	71
T2.5-200	7.87	200.0	80
T2.5-230	9.06	230.0	92
T2.5-245	9.65	245.0	98
T2.5-265	10.43	265.0	106
T2.5-285	11.22	285.0	114
T2.5-305	12.01	305.0	122
T2.5-317.5	12.50	317.5	127
T2.5-330	12.99	330.0	132
T2.5-380	14.96	380.0	152
T2.5-420	16.54	420.0	168
T2.5-480	18.90	480.0	192
T2.5-500	19.69	500.0	200
T2.5-600	23.62	600.0	240
T2.5-620	24.41	620.0	248
T2.5-650	25.59	650.0	260
T2.5-680	26.77	680.0	272
T2.5-780	30.71	780.0	312
T2.5-880	34.65	880.0	352
T2.5-915	36.02	915.0	366
T2.5-950	37.40	950.0	380
T2.5-1185	46.65	1185.0	474

Other widths available. Contact BANDO for price and delivery.

Contact Bando Technical Department if weights are required.



### Nominal Dimensions

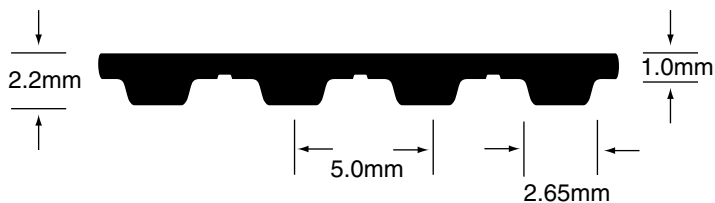

### Part Number Example

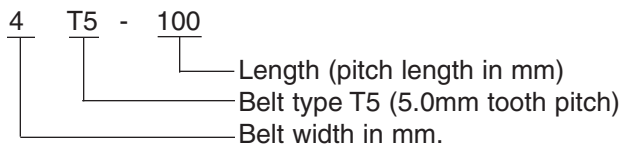

## T5 - 5mm Pitch for 4mm, 6mm, 8mm, 10mm, 12mm, 16mm, 20mm and 25mm Wide Belts

Part Number	Pitch Length		Number of Teeth
	(in)	(mm)	
T5-100	3.94	100.0	20
T5-150	5.91	150.0	30
T5-165	6.50	165.0	33
T5-180	7.09	180.0	36
T5-185	7.29	185.0	37
T5-200	7.88	200.0	40
T5-215	8.47	215.0	43
T5-220	8.67	220.0	44
T5-225	8.87	225.0	45
T5-245	9.65	245.0	49
T5-250	9.85	250.0	50
T5-255	10.04	255.0	51
T5-260	10.24	260.0	52
T5-270	10.63	270.0	54
T5-275	10.83	275.0	55
T5-280	11.02	280.0	56
T5-295	11.61	295.0	59
T5-300	11.81	300.0	60
T5-305	12.01	305.0	61
T5-330	12.99	330.0	66
T5-340	13.39	340.0	68
T5-350	13.78	350.0	70
T5-355	13.98	355.0	71
T5-365	14.37	365.0	73
T5-390	15.35	390.0	78
T5-400	15.75	400.0	80
T5-410	16.14	410.0	82
T5-420	16.54	420.0	84
T5-425	16.73	425.0	85
T5-450	17.72	450.0	90
T5-455	17.91	455.0	91
T5-460	18.11	460.0	92
T5-475	18.70	475.0	95
T5-480	18.90	480.0	96
T5-500	19.69	500.0	100
T5-510	20.08	510.0	102
T5-525	20.67	525.0	105
T5-545	21.46	545.0	109
T5-550	21.65	550.0	110
T5-560	22.05	560.0	112
T5-575	22.64	575.0	115
T5-590	23.23	590.0	118
T5-600	23.62	600.0	120
T5-610	24.02	610.0	122
T5-620	24.41	620.0	124

Other widths available. Contact BANDO for price and delivery.

Contact Bando Technical Department if weights are required.

Synchro-Link® Timing Belts - Polyurethane (Metric)



**T5 - 5mm Pitch for 4mm, 6mm, 8mm, 10mm, 12mm, 16mm, 20mm and 25mm Wide Belts (Continued)**

Part Number	Pitch Length		Number of Teeth
	(in)	(mm)	
T5-630	24.80	630.0	126
T5-640	25.20	640.0	128
T5-650	25.59	650.0	130
T5-660	25.98	660.0	132
T5-690	27.17	690.0	138
T5-695	27.36	695.0	139
T5-700	27.56	700.0	140
T5-720	28.35	720.0	144
T5-750	29.53	750.0	150
T5-780	30.71	780.0	156
T5-815	32.09	815.0	163
T5-830	32.68	830.0	166
T5-840	33.07	840.0	168
T5-850	33.46	850.0	170
T5-860	33.86	860.0	172
T5-885	34.84	885.0	177
T5-900	35.43	900.0	180
T5-940	37.01	940.0	188
T5-990	38.98	990.0	198
T5-1000	39.37	1000.0	200
T5-1075	42.32	1075.0	215
T5-1100	43.30	1100.0	220
T5-1160	45.67	1160.0	232
T5-1215	47.83	1215.0	243
T5-1275	50.20	1275.0	255
T5-1280	50.39	1280.0	256
T5-1315	51.77	1315.0	263
T5-1380	54.33	1380.0	276
T5-1440	56.69	1440.0	288

Other widths available. Contact BANDO for price and delivery.

Contact Bando Technical Department if weights are required.

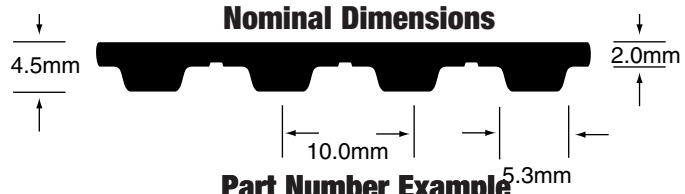

**Part Number Example**

10 T10 - 260

- Length (pitch length in mm)
- Belt type T10 (10.0mm tooth pitch)
- Belt width in mm.

**T10 - 10mm Pitch for 10mm, 14mm, 16mm, 20mm, 25mm, 30mm, 32mm and 50mm Wide Belts**

Part Number	Pitch Length		Number of Teeth
	(in)	(mm)	
T10-260	10.24	260.0	26
T10-340	13.39	340.0	34
T10-370	14.57	370.0	37
T10-400	15.75	400.0	40
T10-410	16.14	410.0	41
T10-440	17.32	440.0	44
T10-450	17.72	450.0	45
T10-460	18.11	460.0	46
T10-480	18.90	480.0	48
T10-490	19.29	490.0	49
T10-500	19.69	500.0	50
T10-530	20.87	530.0	53
T10-560	22.05	560.0	56
T10-600	23.62	600.0	60
T10-610	24.02	610.0	61
T10-630	24.80	630.0	63
T10-660	25.98	660.0	66
T10-690	27.17	690.0	69
T10-700	27.56	700.0	70
T10-720	28.35	720.0	72
T10-750	29.53	750.0	75
T10-780	30.71	780.0	78
T10-810	31.89	810.0	81
T10-840	33.07	840.0	84
T10-880	34.65	880.0	88
T10-890	35.04	890.0	89
T10-900	35.43	900.0	90
T10-920	36.22	920.0	92
T10-960	37.80	960.0	96
T10-970	38.19	970.0	97
T10-980	38.58	980.0	98
T10-1010	39.76	1010.0	101
T10-1080	42.52	1080.0	108
T10-1110	43.70	1110.0	111
T10-1140	44.88	1140.0	114
T10-1150	45.28	1150.0	115
T10-1210	47.64	1210.0	121
T10-1240	48.82	1240.0	124
T10-1250	49.21	1250.0	125
T10-1300	51.18	1300.0	130
T10-1320	51.97	1320.0	132
T10-1350	53.15	1350.0	135
T10-1390	54.72	1390.0	139
T10-1400	55.12	1400.0	140
T10-1420	55.91	1420.0	142
T10-1440	56.69	1440.0	144
T10-1450	57.09	1450.0	145
T10-1460	57.48	1460.0	146
T10-1500	59.06	1500.0	150
T10-1560	61.42	1560.0	156
T10-1610	63.39	1610.0	161
T10-1750	68.90	1750.0	175
T10-1780	70.08	1780.0	178
T10-1880	74.02	1880.0	188
T10-1960	77.17	1960.0	196
T10-2250	88.58	2250.0	225

Other widths available. Contact BANDO for price and delivery.

Contact Bando Technical Department if weights are required.



### Nominal Dimensions

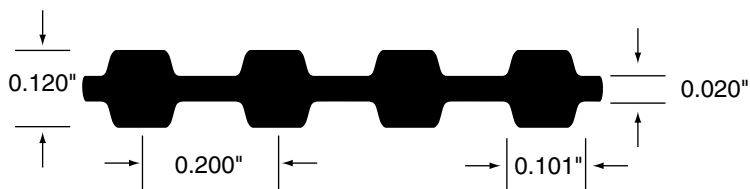

### Part Number Example



Part number includes the width/construction suffix in parenthesis below.  
Example: A 1/4" wide 160DXL is a part number 160DXL025G.

Synchro-Link® Double Sided Timing Belts Neoprene (RMA)

### DXL - 1/5 Inch Pitch for 1/4" and 3/8" Wide Belts

Part Number	1/4" Wide (025G)	3/8" Wide (037G)	Pitch Length (in)	Number of Teeth
	Weight*	Weight*		
160DXL	0.020	0.030	16.00	80
162DXL	0.020	0.030	16.20	81
164DXL	0.020	0.030	16.40	82
166DXL	0.020	0.030	16.60	83
168DXL	0.020	0.030	16.80	84
170DXL	0.020	0.030	17.00	85
172DXL	0.020	0.030	17.20	86
174DXL	0.020	0.030	17.40	87
176DXL	0.020	0.030	17.60	88
178DXL	0.030	0.040	17.80	89
180DXL	0.030	0.040	18.00	90
182DXL	0.030	0.040	18.20	91
184DXL	0.030	0.040	18.40	92
188DXL	0.030	0.040	18.80	94
190DXL	0.030	0.040	19.00	95
194DXL	0.030	0.040	19.40	97
196DXL	0.030	0.040	19.60	98
198DXL	0.030	0.040	19.80	99
200DXL	0.030	0.040	20.00	100
202DXL	0.030	0.040	20.20	101
206DXL	0.030	0.040	20.60	103
208DXL	0.030	0.040	20.80	104
210DXL	0.030	0.040	21.00	105
212DXL	0.030	0.040	21.20	106
214DXL	0.030	0.040	21.40	107
216DXL	0.030	0.040	21.60	108
220DXL	0.030	0.040	22.00	110
222DXL	0.030	0.040	22.20	111
224DXL	0.030	0.040	22.40	112
228DXL	0.030	0.050	22.80	114
230DXL	0.030	0.050	23.00	115
234DXL	0.030	0.050	23.40	117
240DXL	0.030	0.050	24.00	120
248DXL	0.030	0.050	24.80	124
250DXL	0.030	0.050	25.00	125
260DXL	0.030	0.050	26.00	130
262DXL	0.030	0.050	26.20	131
266DXL	0.030	0.050	26.60	133
270DXL	0.030	0.050	27.00	135
280DXL	0.030	0.050	28.00	140

\* Weights shown are approximate.

Other widths available. Contact BANDO for price and delivery.





### DXL - 1/5 Inch Pitch for 1/4" and 3/8" Wide Belts (Continued)

Part Number	1/4" Wide (025G)	3/8" Wide (037G)	Pitch Length (in)	Number of Teeth
	Weight*	Weight*		
282DXL	0.030	0.050	28.20	141
290DXL	0.030	0.050	29.00	145
300DXL	0.040	0.060	30.00	150
310DXL	0.040	0.060	31.00	155
314DXL	0.040	0.060	31.40	157
320DXL	0.040	0.060	32.00	160
322DXL	0.040	0.060	32.20	161
330DXL	0.040	0.060	33.00	165
340DXL	0.040	0.060	34.00	170
344DXL	0.040	0.060	34.40	172
348DXL	0.040	0.060	34.80	174
352DXL	0.050	0.070	35.20	176
356DXL	0.050	0.070	35.60	178
360DXL	0.050	0.070	36.00	180
364DXL	0.050	0.070	36.40	182
370DXL	0.050	0.070	37.00	185
372DXL	0.050	0.070	37.20	186
376DXL	0.050	0.070	37.60	188
384DXL	0.050	0.070	38.40	192
388DXL	0.060	0.080	38.80	194
390DXL	0.060	0.080	39.00	195
396DXL	0.060	0.080	39.60	198
400DXL	0.060	0.080	40.00	200
408DXL	0.060	0.080	40.80	204
424DXL	0.060	0.090	42.40	212
430DXL	0.060	0.090	43.00	215
450DXL	0.060	0.090	45.00	225
456DXL	0.060	0.090	45.60	228
460DXL	0.060	0.090	46.00	230
470DXL	0.060	0.090	47.00	235
490DXL	0.060	0.090	49.00	245
496DXL	0.060	0.090	49.60	248
510DXL	0.070	0.100	51.00	255
540DXL	0.070	0.100	54.00	270
592DXL	0.070	0.100	59.20	296
608DXL	0.070	0.100	60.80	304
630DXL	0.070	0.100	63.00	315

\* Weights shown are approximate.

Other widths available. Contact BANDO for price and delivery.

Synchro-Link® Double Sided Timing Belts Neoprene (RMA)



### Nominal Dimensions

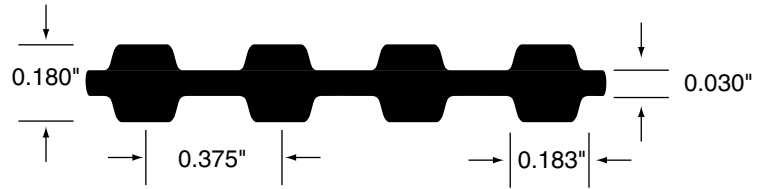
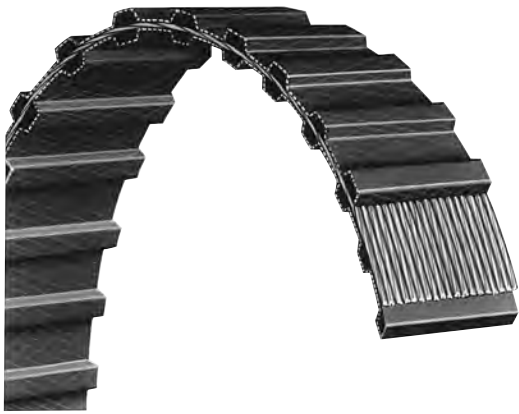

### Part Number Example

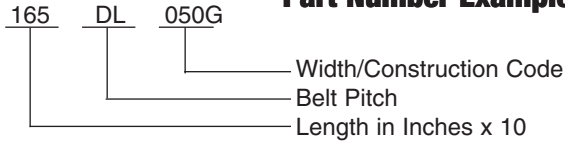

Part number includes the width/construction suffix in parenthesis below.  
 Example: A 1/2" wide 165DL is a part number 165DL050G.

### DL - 3/8 Inch Pitch for 1/2", 3/4" and 1" Wide Belts

Synchro-Link® Double Sided Timing Belts Neoprene (RMA)

Part Number	1/2" Wide (050G)	3/4" Wide (075G)	1" Wide (100G)	Pitch Length (in)	Number of Teeth
	Weight*	Weight*	Weight*		
165DL	0.060	0.080	0.110	16.50	44
169DL	0.060	0.080	0.110	16.88	45
172DL	0.060	0.080	0.120	17.25	46
187DL	0.060	0.080	0.120	18.75	50
203DL	0.070	0.090	0.130	20.25	54
210DL	0.070	0.100	0.130	21.00	56
218DL	0.070	0.100	0.135	21.75	58
225DL	0.070	0.100	0.140	22.50	60
240DL	0.080	0.120	0.160	24.00	64
248DL	0.080	0.120	0.165	24.75	66
255DL	0.080	0.120	0.170	25.50	68
263DL	0.080	0.120	0.170	26.25	70
270DL	0.090	0.130	0.170	27.00	72
277DL	0.090	0.130	0.170	27.75	74
285DL	0.090	0.130	0.180	28.50	76
300DL	0.100	0.140	0.200	30.00	80
304DL	0.100	0.140	0.200	30.38	81
315DL	0.100	0.150	0.200	31.50	84
320DL	0.100	0.160	0.210	31.88	85
322DL	0.100	0.160	0.210	32.25	86
334DL	0.110	0.170	0.210	33.38	89
337DL	0.110	0.170	0.210	33.75	90
345DL	0.110	0.170	0.220	34.50	92
360DL	0.120	0.170	0.220	36.00	96
367DL	0.120	0.170	0.230	36.75	98
375DL	0.120	0.180	0.240	37.50	100
382DL	0.120	0.180	0.240	38.25	102
390DL	0.130	0.180	0.250	39.00	104
394DL	0.135	0.190	0.260	39.38	105
420DL	0.140	0.200	0.270	42.00	112
427DL	0.140	0.200	0.270	42.75	114
436DL	0.140	0.200	0.270	43.50	116
439DL	0.140	0.200	0.270	43.88	117
446DL	0.150	0.200	0.270	44.63	119
450DL	0.150	0.200	0.290	45.00	120
465DL	0.150	0.210	0.290	46.50	124
480DL	0.160	0.220	0.310	48.00	128
510DL	0.170	0.260	0.320	51.00	136
514DL	0.170	0.260	0.340	51.38	137
525DL	0.170	0.260	0.340	52.50	140
540DL	0.180	0.280	0.340	54.00	144
548DL	0.180	0.280	0.340	54.75	146
581DL	0.190	0.290	0.350	58.13	155
600DL	0.200	0.300	0.360	60.00	160
605DL	0.200	0.300	0.370	60.38	161

\* Weights shown are approximate.

Other widths available. Contact BANDO for price and delivery.



## DL - 3/8 Inch Pitch for 1/2", 3/4" and 1" Wide Belts (Continued)

Part Number	1/2" Wide (050G)	3/4" Wide (075G)	1" Wide (100G)	Pitch Length (in)	Number of Teeth
	Weight*	Weight*	Weight*		
619DL	0.200	0.300	0.380	61.88	165
630DL	0.205	0.310	0.400	63.00	168
640DL	0.210	0.320	0.420	63.75	170
653DL	0.220	0.330	0.420	65.25	174
660DL	0.220	0.330	0.420	66.00	176
697DL	0.220	0.330	0.440	69.75	186
728DL	0.240	0.340	0.450	72.75	194
731DL	0.240	0.340	0.450	73.13	195
767DL	0.240	0.340	0.480	76.88	205
780DL	0.260	0.380	0.500	78.00	208
788DL	0.270	0.380	0.510	78.75	210
806DL	0.270	0.380	0.520	80.63	215
855DL	0.270	0.380	0.540	85.50	228
863DL	0.280	0.400	0.550	86.25	230
881DL	0.280	0.400	0.560	88.13	235
915DL	0.300	0.400	0.580	91.50	244
919DL	0.300	0.400	0.580	91.88	245
938DL	0.310	0.410	0.600	93.75	250

\* Weights shown are approximate.

Other widths available. Contact BANDO for price and delivery.

## Specialty Application Synchro-Link® Belts

BANDO has design and production expertise to develop and produce a variety of special Synchro-Link® constructions for specific applications. Consult BANDO engineering with your application information.

### High Flexibility (MXL, L)

Developed for office machines, these belts have maximum flexibility.

### Special Dimensions (All pitches)

Special pitch and special widths are available.

### Special Cord (All pitches)

Kevlar® cord is available in MXL, XL, and L pitches.

### Food Grade (XL, L, H)

Belt body is food grade white rubber. Tooth facing is black nylon.

### Low Durometer (All pitches)

For conveying and transport applications.

### Non-Marking Back (MXL, XL, L, H)

Clean operations such as paper transport use this belt.

### High Heat Resistance (MXL, XL, L, H)

Use this belt in areas with an ambient temperature to 248°F (120°C).

### High Electrical Resistance (MXL, XL, L, H)

For uses where resistance of 6 megohms or more is required.

### Low Noise (H, XH, XXH)

For applications where quiet operations are needed.

### Special Construction (All pitches)

For applications where the belt conveys, meters, indexes, moves a component, etc., the belt top can be molded into a special configuration.

Kevlar® is a registered trademark of DuPont Corp.

Synchro-Link® Double Sided Timing Belts Neoprene (RMA)



### Nominal Dimensions

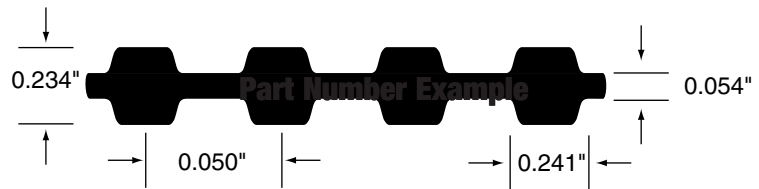

### Part Number Example

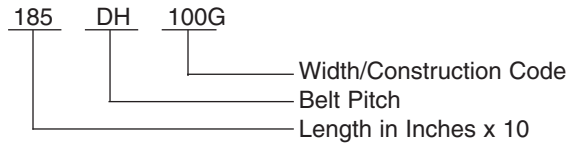

Part number includes the width/construction suffix in parenthesis below.  
Example: A 1" wide 185DH is a part number 185DH100G.

Synchro-Link® Double Sided Timing Belts Neoprene (RMA)

### DH - 1/2 Inch Pitch for 1", 1-1/2", 2" and 3" Wide Belts

Part Number	1" Wide (100G)	1-1/2" Wide (150G)	2" Wide (200G)	3" Wide (300G)	Pitch Length (in)	Number of Teeth
	Weight*	Weight*	Weight*	Weight*		
185DH	0.190	0.280	0.380	0.570	18.50	37
225DH	0.215	0.320	0.430	0.645	22.50	45
230DH	0.240	0.360	0.480	0.720	23.00	46
240DH	0.250	0.380	0.490	0.750	24.00	48
245DH	0.250	0.380	0.500	0.750	24.50	49
270DH	0.270	0.410	0.540	0.820	27.00	54
280DH	0.280	0.420	0.560	0.840	28.00	56
300DH	0.300	0.450	0.600	0.910	30.00	60
310DH	0.310	0.470	0.620	0.930	31.00	62
315DH	0.310	0.470	0.620	0.930	31.50	63
320DH	0.320	0.480	0.640	0.960	32.00	64
330DH	0.330	0.490	0.660	0.990	33.00	66
340DH	0.340	0.510	0.680	1.020	34.00	68
350DH	0.350	0.520	0.700	1.040	35.00	70
360DH	0.360	0.540	0.730	1.090	36.00	72
370DH	0.370	0.550	0.740	1.100	37.00	74
375DH	0.380	0.570	0.760	1.140	37.50	75
390DH	0.390	0.590	0.790	1.180	39.00	78
400DH	0.400	0.600	0.800	1.200	40.00	80
410DH	0.410	0.610	0.820	1.220	41.00	82
420DH	0.420	0.630	0.850	1.270	42.00	84
430DH	0.430	0.650	0.860	1.300	43.00	86
450DH	0.460	0.680	0.910	1.370	45.00	90
465DH	0.470	0.710	0.940	1.420	46.50	93
480DH	0.480	0.730	0.980	1.460	48.00	96
490DH	0.490	0.740	0.980	1.480	49.00	98
510DH	0.510	0.770	1.030	1.550	51.00	102
530DH	0.530	0.800	1.060	1.595	53.00	106
540DH	0.530	0.820	1.090	1.640	54.00	108
560DH	0.560	0.840	1.120	1.680	56.00	112
565DH	0.565	0.850	1.140	1.710	56.50	113
570DH	0.570	0.860	1.160	1.730	57.00	114
580DH	0.580	0.870	1.160	1.740	58.00	116
600DH	0.600	0.910	1.210	1.820	60.00	120
605DH	0.610	0.920	1.220	1.840	60.50	121
630DH	0.620	0.950	1.270	1.910	63.00	126
640DH	0.635	0.965	1.285	1.940	64.00	128
650DH	0.650	0.980	1.300	1.960	65.00	130
660DH	0.660	1.000	1.330	2.000	66.00	132
680DH	0.680	1.020	1.360	2.040	68.00	136
700DH	0.700	1.050	1.420	2.130	70.00	140
730DH	0.725	1.090	1.470	2.210	73.00	146
750DH	0.750	1.130	1.510	2.280	75.00	150
760DH	0.760	1.140	1.520	2.280	76.00	152
770DH	0.770	1.160	1.540	2.320	77.00	154

\* Weights shown are approximate.

Other widths available. Contact BANDO for price and delivery.



### DH - 1/2 Inch Pitch for 1", 1-1/2", 2" and 3" Wide Belts (Continued)

Part Number	1" Wide (100G)	1-1/2" Wide (150G)	2" Wide (200G)	3" Wide (300G)	Pitch Length (in)	Number of Teeth
	Weight*	Weight*	Weight*	Weight*		
800DH	0.790	1.210	1.610	2.430	80.00	160
810DH	0.810	1.220	1.620	2.440	81.00	162
820DH	0.820	1.230	1.640	2.460	82.00	164
840DH	0.840	1.260	1.680	2.520	84.00	168
850DH	0.850	1.290	1.720	2.590	85.00	170
860DH	0.860	1.290	1.720	2.580	86.00	172
880DH	0.880	1.320	1.760	2.640	88.00	176
900DH	0.900	1.350	1.820	2.730	90.00	180
950DH	0.950	1.430	1.900	2.860	95.00	190
985DH	0.990	1.490	1.980	2.980	98.50	197
1000DH	1.000	1.510	2.020	3.060	100.00	200
1020DH	1.000	1.500	2.000	3.110	102.00	204
1050DH	1.050	1.580	2.100	3.160	105.00	210
1100DH	1.090	1.650	2.180	3.340	110.00	220
1130DH	1.120	1.690	2.240	3.400	113.00	226
1140DH	1.150	1.730	2.300	3.460	114.00	228
1250DH	1.250	1.890	2.500	3.800	125.00	250
1350DH	1.350	2.030	2.700	4.060	135.00	270
1400DH	1.400	2.110	2.800	4.250	140.00	280
1680DH	1.550	2.330	3.100	4.675	168.00	336
1700DH	1.700	2.550	3.400	5.100	170.00	340

\* Weights shown are approximate.

Other widths available. Contact BANDO for price and delivery.



**BANDO USA, Inc. Corporate Headquarters  
and Midwest Distribution Center  
Itasca, IL**

Synchro-Link® Double Sided Timing Belts Neoprene (RMA)

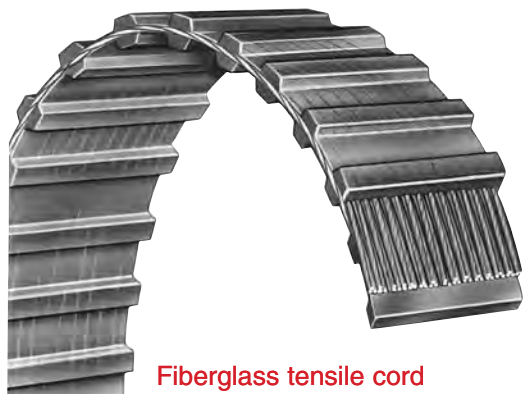

Fiberglass tensile cord for increased flexibility and greater durability.

### Nominal Dimensions

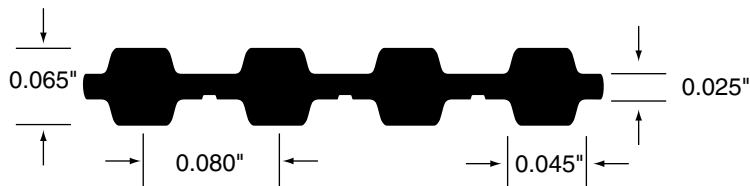

### Part Number Example

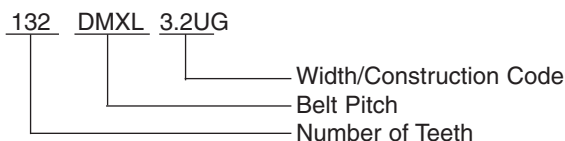

Part number includes the width suffix in parenthesis below.  
Example: A 3.2 mm wide 132DMXL is a part number 132DMXL3.2UG.

Synchro-Link® Double Sided Timing Belts - Polyurethane (RMA)

## DMXL - 0.080 Inch Pitch for 1/8", 3/16" and 1/4" Wide Belts

Part Number	1/8" - 3.2mm Wide (3.2UG)	3/16" - 4.8mm Wide (4.8UG)	1/4" - 6.4mm Wide (6.4UG)	Pitch Length (in)	Number of Teeth
	Weight*	Weight*	Weight*		
132DMXL	0.002	0.003	0.004	10.56	132
136DMXL	0.002	0.003	0.004	10.88	136
140DMXL	0.002	0.003	0.004	11.20	140
145DMXL	0.002	0.003	0.004	11.60	145
150DMXL	0.002	0.004	0.005	12.00	150
155DMXL	0.002	0.004	0.005	12.40	155
160DMXL	0.002	0.004	0.005	12.80	160
165DMXL	0.003	0.004	0.005	13.20	165
170DMXL	0.003	0.004	0.005	13.60	170
175DMXL	0.003	0.004	0.005	14.00	175
180DMXL	0.003	0.004	0.005	14.40	180
185DMXL	0.003	0.004	0.006	14.80	185
190DMXL	0.003	0.004	0.006	15.20	190
195DMXL	0.003	0.004	0.006	15.60	195
200DMXL	0.003	0.005	0.006	16.00	200
212DMXL	0.003	0.005	0.006	16.96	212
224DMXL	0.004	0.005	0.007	17.92	224
231DMXL	0.004	0.005	0.007	18.48	231
236DMXL	0.004	0.005	0.008	18.88	236
250DMXL	0.004	0.006	0.008	20.00	250
265DMXL	0.004	0.006	0.008	21.20	265
280DMXL	0.004	0.006	0.008	22.40	280
300DMXL	0.005	0.007	0.009	24.00	300
315DMXL	0.005	0.007	0.010	25.20	315
335DMXL	0.005	0.008	0.010	26.80	335
355DMXL	0.005	0.008	0.011	28.40	355
375DMXL	0.005	0.008	0.011	30.00	375
400DMXL	0.006	0.009	0.012	32.00	400
425DMXL	0.006	0.009	0.013	34.00	425
450DMXL	0.007	0.010	0.013	36.00	450
475DMXL	0.007	0.011	0.014	38.00	475
500DMXL	0.008	0.011	0.015	40.00	500

\* Weights shown are approximate.

Other widths available. Contact BANDO for price and delivery.

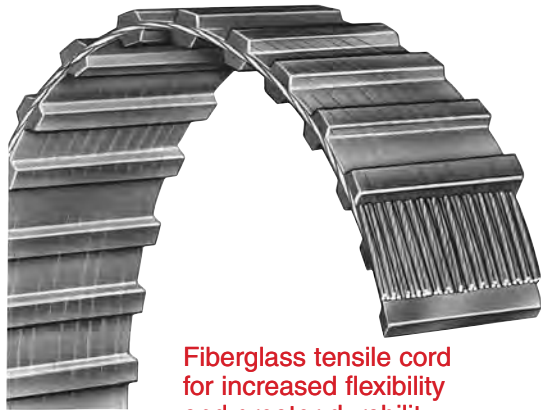

Fiberglass tensile cord for increased flexibility and greater durability.

### Nominal Dimensions

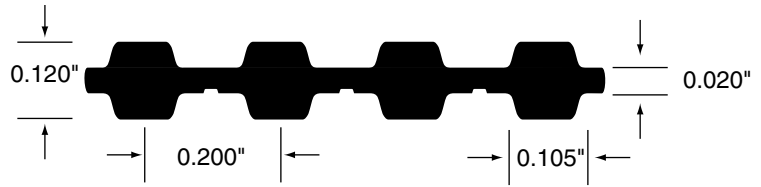

### Part Number Example

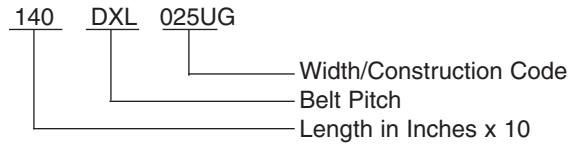

Part number includes the width/construction suffix in parenthesis below. For example, a 1/4" wide 140DXL is a part number 140DXL025UG.

## DXL - 1/5 Inch Pitch for 1/4" and 3/8" Wide Belts

Part Number	1/4" Wide (025UG)	3/8" Wide (037UG)	Pitch Length (in)	Number of Teeth
	Weight*	Weight*		
140DXL	0.010	0.010	14.00	70
146DXL	0.010	0.010	14.60	73
150DXL	0.010	0.010	15.00	75
166DXL	0.010	0.010	16.60	83
170DXL	0.010	0.015	17.00	85
180DXL	0.010	0.020	18.00	90
190DXL	0.010	0.020	19.00	95
200DXL	0.010	0.020	20.00	100
210DXL	0.010	0.020	21.00	105
220DXL	0.010	0.020	22.00	110
230DXL	0.010	0.020	23.00	115
240DXL	0.010	0.020	24.00	120
270DXL	0.015	0.020	27.00	135
290DXL	0.020	0.020	29.00	145
300DXL	0.020	0.025	30.00	150
320DXL	0.020	0.030	32.00	160
376DXL	0.020	0.030	37.60	188
400DXL	0.030	0.040	40.00	200
430DXL	0.030	0.040	43.00	215
490DXL	0.030	0.040	49.00	245

\* Weights shown are approximate.

Other widths available. Contact BANDO for price and delivery.

Synchro-Link® Double Sided Timing Belts - Polyurethane (RMA)



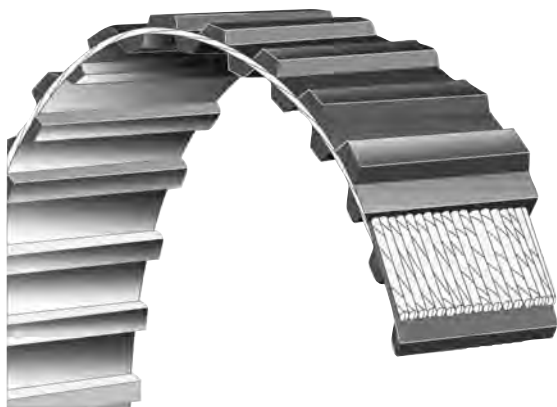

### Nominal Dimensions

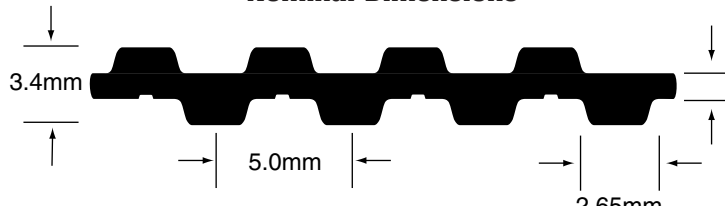

### Part Number Example

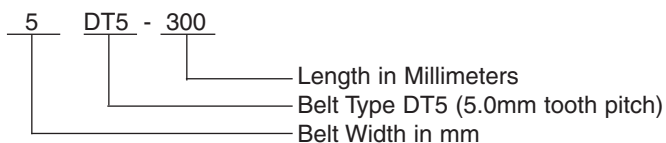

Part number includes the width prefix in parenthesis below.  
Example: A 5mm wide DT5-300 is part number 5DT5-300.

Synchro-Link® Double Sided Timing Belts - Polyurethane (Metric)

### DT5 - 5mm Pitch for 5mm, 10mm, 15mm, 20mm and 25mm Wide Belts

Part Number	5mm Wide (5)	10mm Wide (10)	15mm Wide (15)	20mm Wide (20)	25mm Wide (25)	Pitch Length (in)	Pitch Length (mm)	Number of Teeth
	Weight*	Weight*	Weight*	Weight*	Weight*			
DT5-300	0.010	0.011	0.016	0.020	0.025	11.81	300	60
DT5-410	0.011	0.013	0.018	0.022	0.027	16.14	410	82
DT5-460	0.012	0.015	0.020	0.025	0.030	18.11	460	92
DT5-480	0.013	0.016	0.021	0.026	0.031	18.90	480	96
DT5-515	0.014	0.017	0.022	0.028	0.033	20.28	515	103
DT5-550	0.015	0.018	0.024	0.030	0.036	21.65	550	110
DT5-590	0.016	0.019	0.026	0.032	0.038	23.23	590	118
DT5-620	0.017	0.020	0.027	0.034	0.040	24.41	620	124
DT5-650	0.018	0.022	0.029	0.036	0.043	25.59	650	130
DT5-700	0.019	0.023	0.030	0.038	0.045	27.56	700	140
DT5-750	0.020	0.024	0.032	0.041	0.049	29.53	750	150
DT5-800	0.022	0.026	0.035	0.043	0.052	31.50	800	160
DT5-815	0.022	0.026	0.035	0.044	0.053	32.09	815	163
DT5-860	0.023	0.028	0.037	0.047	0.056	33.86	860	172
DT5-900	0.024	0.030	0.039	0.049	0.059	35.43	900	180
DT5-940	0.025	0.031	0.041	0.051	0.061	37.01	940	188
DT5-1075	0.029	0.035	0.047	0.058	0.070	42.32	1075	215
DT5-1100	0.030	0.036	0.048	0.060	0.071	43.31	1100	220

\* Weights shown are approximate.

Other widths available. Contact BANDO for price and delivery.

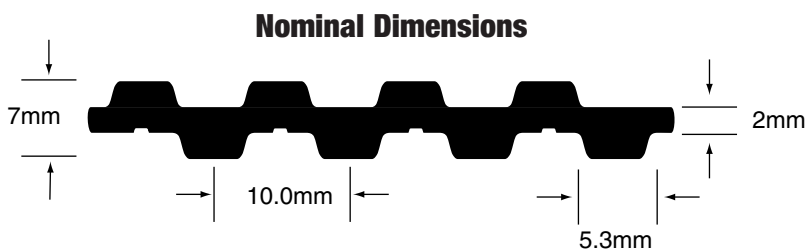
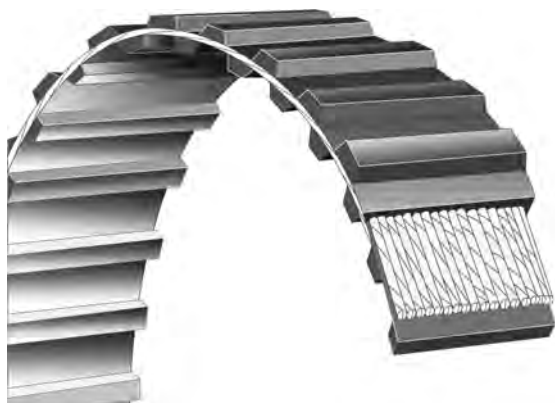

**Part Number Example**

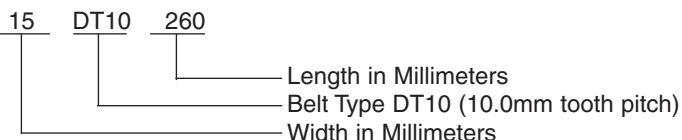

Part number includes the width prefix in parenthesis below.  
 Example: A 15mm wide DT10-260 is part number 15DT10-260.

**DT10 - 10mm Pitch for 15mm, 20mm, 25mm, 30mm and 50mm Wide Belts**

Part Number	15mm Wide (15)	20mm Wide (20)	25mm Wide (25)	30mm Wide (30)	50mm Wide (50)	Pitch Length (in)	Pitch Length mm	Number of Teeth
	Weight*	Weight*	Weight*	Weight*	Weight*			
DT10-260	0.015	0.018	0.024	0.030	0.036	10.24	260	26
DT10-530	0.031	0.037	0.049	0.061	0.073	20.87	530	53
DT10-630	0.036	0.044	0.058	0.073	0.087	24.80	630	63
DT10-660	0.038	0.046	0.061	0.076	0.091	25.98	660	66
DT10-700	0.040	0.048	0.065	0.081	0.097	27.56	700	70
DT10-720	0.042	0.050	0.066	0.083	0.100	28.35	720	72
DT10-800	0.046	0.055	0.074	0.092	0.111	31.50	800	80
DT10-840	0.048	0.058	0.077	0.097	0.116	33.07	840	84
DT10-900	0.052	0.062	0.083	0.104	0.124	35.43	900	90
DT10-980	0.056	0.068	0.090	0.113	0.136	38.58	980	98
DT10-1100	0.063	0.076	0.101	0.127	0.152	43.31	1100	110
DT10-1210	0.070	0.084	0.112	0.139	0.167	47.64	1210	121
DT10-1240	0.071	0.086	0.114	0.143	0.171	48.82	1240	124
DT10-1250	0.072	0.086	0.115	0.144	0.173	49.21	1250	125
DT10-1320	0.076	0.091	0.122	0.152	0.183	51.97	1320	132
DT10-1350	0.078	0.093	0.124	0.156	0.187	53.15	1350	135
DT10-1420	0.082	0.098	0.131	0.164	0.196	55.91	1420	142
DT10-1500	0.086	0.104	0.138	0.173	0.207	59.06	1500	150
DT10-1610	0.093	0.111	0.148	0.186	0.223	63.39	1610	161
DT10-1800	0.104	0.124	0.166	0.207	0.249	70.87	1800	180
DT10-1880	0.108	0.130	0.173	0.217	0.260	74.02	1880	188

\* Weights shown are approximate.

Other widths available. Contact BANDO for price and delivery.

**BANDO's Synchro-Link® Sleeve Program**

To support the cut-to-size Synchro-Link® inventory as described in this catalog, BANDO carries a full range of the Synchro-Link® Timing Belt product line in sleeve form.

This back-up inventory provides BANDO with the versatility to “cut to order”, on a *same day* basis, any non-stock width of Synchro-Link® Timing Belt or, if necessary, to support stock width requirements. (Minimum quantity may apply.)

Contact Service Express for details of the Synchro-Link® sleeve program.

Synchro-Link® Double Sided Timing Belts - Polyurethane (Metric)



## Synchro-Link® Open Ended Timing Belts

Synchro-Link® Open Ended Belting is available in RMA and metric pitches in both neoprene and polyurethane construction. A number of configurations are offered to satisfy most applications requiring synchronization and specialized uses such as conveying, positioning, metering, etc.

Optional constructions available. Contact BANDO for special requirements.



## White Polyurethane with Steel Cords

Part Number	Roll Length (Feet)	Approx. Weight (Lbs.)
50-S2M-OPENU	196	1.508
100-S2M-OPENU	196	3.016
150-S2M-OPENU	196	4.524
200-S2M-OPENU	196	6.032
250-S2M-OPENU	196	7.540
300-S2M-OPENU	196	9.048
350-S2M-OPENU	196	10.556
400-S2M-OPENU	196	12.064
60-S3M-OPENU	196	1.931
120-S3M-OPENU	196	3.862
180-S3M-OPENU	196	5.793
240-S3M-OPENU	196	7.724
300-S3M-OPENU	196	9.655
360-S3M-OPENU	196	11.586
420-S3M-OPENU	196	13.517
480-S3M-OPENU	196	15.448
100-S5M-OPENU	164	3.814
150-S5M-OPENU	164	5.721
200-S5M-OPENU	164	7.628
250-S5M-OPENU	164	9.535
300-S5M-OPENU	164	11.442
400-S5M-OPENU	164	15.256
500-S5M-OPENU	164	19.070
150-S8M-OPENU	98	5.714
200-S8M-OPENU	98	7.619
250-S8M-OPENU	98	9.523
300-S8M-OPENU	98	11.428
400-S8M-OPENU	98	15.237
500-S8M-OPENU	98	19.047
750-S8M-OPENU	98	28.570
1000-S8M-OPENU	98	38.093
XL025-OPENU	164	1.552
XL031-OPENU	164	1.924
XL037-OPENU	164	2.328
XL050-OPENU	164	3.104
XL075-OPENU	164	4.656
XL100-OPENU	164	6.208
XL150-OPENU	164	9.312
XL200-OPENU	164	12.416
L050U-OPEN	164	5.071
L075U-OPEN	164	7.606
L100U-OPEN	164	10.141
L150U-OPEN	164	15.212
L200U-OPEN	164	20.282
H075U-OPEN	164	8.656
H100U-OPEN	164	11.542
H150U-OPEN	164	17.313
H200U-OPEN	164	23.085
H300U-OPEN	164	34.626
H400U-OPEN	164	46.168
10T5-OPEN	164	2.436
15T5-OPEN	164	3.654
20T5-OPEN	164	4.872
25T5-OPEN	164	6.090
30T5-OPEN	164	7.308
40T5-OPEN	164	9.744
50T5-OPEN	164	12.180
15T10-OPEN	164	7.871
20T10-OPEN	164	10.494
25T10-OPEN	164	13.118
30T10-OPEN	164	15.741
40T10-OPEN	164	20.988
50T10-OPEN	164	26.235
75T10-OPEN	164	39.353
100T10-OPEN	164	52.470

Open Ended

## Rubber

Part Number	Roll Length (Feet)	Approx. Weight (Lbs.)
MXL4.8-OPEN	137	0.507
MXL6.4-OPEN	101	0.499
XL025-OPEN	173	1.986
XL031-OPEN	141	1.998
XL037-OPEN	114	1.968
XL050-OPEN	85	1.949
XL075-OPEN	108	3.710
L050-OPEN	160	5.185
L075-OPEN	104	5.079
L100-OPEN	154	4.512
H075-OPEN	137	9.236
H100-OPEN	101	9.090
H150-OPEN	131	17.593
H200-OPEN	91	17.420
H300-OPEN	55	14.954
50-S2M-OPEN	131	0.882
60-S2M-OPEN	114	0.741
70-S2M-OPEN	98	0.741
80-S2M-OPEN	164	1.411
50-S3M-OPEN	164	1.268
60-S3M-OPEN	131	1.217
60-S4.5M-OPEN	147	0.738
100-S4.5M-OPEN	131	1.093
100-S5M-OPEN	131	3.422
150-S5M-OPEN	131	5.132
200-S5M-OPEN	98	5.132
250-S5M-OPEN	78	5.132
150-S8M-OPEN	164	9.127
250-S8M-OPEN	98	9.127
400-S8M-OPEN	124	18.497
600-S8M-OPEN	78	17.524

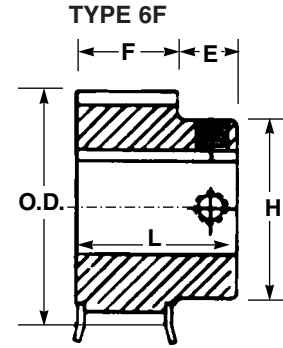

### STS - S8M 15mm, 25mm, 40mm and 60mm

Note: Additional sizes may be available. Contact BANDO.

Part Number	Type	Number of Teeth	Nominal Dimensions (mm)						Bore (mm)		Weight*
			Pitch Dia.	Pulley OD	Flange OD	E	L	H	MPB	Max	
<b>15mm</b> F Dimension = 23mm, 17mm Between Flanges											
P18-S8M-15	6F	18	45.84	44.46	53	15	38	29	12	19	0.6
P19-S8M-15	6F	19	48.38	47.01	56	15	38	34	12	22	0.7
P20-S8M-15	6F	20	50.93	49.56	59	15	38	35	12	23	0.8
P21-S8M-15	6F	21	53.48	52.10	59	15	38	35	12	23	0.9
P22-S8M-15	6F	22	56.02	54.65	62	15	38	35	12	23	1.0
P24-S8M-15	6F	24	61.12	59.74	68	15	38	40	12	25	1.2
P26-S8M-15	6F	26	66.21	64.84	75	15	38	40	12	25	1.4
P28-S8M-15	6F	28	71.30	69.93	77	15	38	50	12	30	1.8
<b>25mm</b> F Dimension = 34mm, 28mm Between Flanges											
P18-S8M-25	6F	18	45.84	44.46	53	15	49	29	12	19	0.8
P19-S8M-25	6F	19	48.38	47.01	56	15	49	34	12	22	1.0
P20-S8M-25	6F	20	50.93	49.56	59	15	49	35	12	23	1.1
P21-S8M-25	6F	21	53.48	52.10	59	15	49	35	12	23	1.2
P22-S8M-25	6F	22	56.02	54.65	62	15	49	35	12	23	1.4
P24-S8M-25	6F	24	61.12	59.74	68	15	49	40	12	25	1.7
P26-S8M-25	6F	26	66.21	64.84	75	15	49	40	12	25	2.0
P28-S8M-25	6F	28	71.30	69.93	77	15	49	50	12	30	2.4
P30-S8M-25	6F	30	76.39	75.02	83	15	49	50	12	30	2.6
<b>40mm</b> F Dimension = 50mm, 44mm Between Flanges											
P18-S8M-40	6F	18	45.84	44.46	53	15	65	29	12	19	1.2
P19-S8M-40	6F	19	48.38	47.01	56	15	65	34	12	22	1.4
P20-S8M-40	6F	20	50.93	49.56	59	15	65	35	12	23	1.6
P21-S8M-40	6F	21	53.48	52.10	59	15	65	35	12	23	1.7
P22-S8M-40	6F	22	56.02	54.65	62	15	65	35	12	23	1.9
P24-S8M-40	6F	24	61.12	59.74	68	15	65	40	12	25	2.2
P26-S8M-40	6F	26	66.21	64.84	75	15	65	40	12	25	2.6
P28-S8M-40	6F	28	71.30	69.93	77	15	65	50	12	30	3.3
P30-S8M-40	6F	30	76.39	75.02	83	15	65	50	12	30	3.7
P32-S8M-40	6F	32	81.49	80.12	89	15	65	65	12	42	4.6
P34-S8M-40	6F	34	86.58	85.21	92	15	65	65	12	42	5.3
<b>60mm</b> F Dimension = 71mm, 65mm Between Flanges											
P18-S8M-60	6F	18	45.84	44.46	53	15	86	29	12	19	1.6
P19-S8M-60	6F	19	48.38	47.01	56	15	86	34	12	22	1.9
P20-S8M-60	6F	20	50.93	49.56	59	15	86	35	12	23	2.1
P21-S8M-60	6F	21	53.48	52.10	59	15	86	35	12	23	2.2
P22-S8M-60	6F	22	56.02	54.65	62	15	86	35	12	23	2.4
P24-S8M-60	6F	24	61.12	59.74	68	15	86	40	12	25	3.1
P26-S8M-60	6F	26	66.21	64.84	75	15	86	40	12	25	3.7
P28-S8M-60	6F	28	71.30	69.93	77	15	86	50	12	30	4.4
P30-S8M-60	6F	30	76.39	75.02	83	15	86	50	12	30	5.3
P32-S8M-60	6F	32	81.49	80.12	89	15	86	65	12	42	6.2
P34-S8M-60	6F	34	86.58	85.21	92	15	86	65	12	42	7.1

\* Weights shown are approximate.

Dimensions shown are for reference purposes only and are subject to change without notice. Where space requirements are critical, consult BANDO for certified specifications.

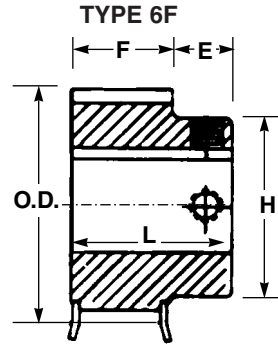

### STS - S14M 40mm, 60mm, 80mm, 100mm and 120mm

Note: Additional sizes may be available. Contact BANDO.

Part Number	Type	Number of Teeth	Nominal Dimensions (mm)						Bore (mm)		Weight*
			Pitch Dia.	Pulley OD	Flange OD	E	L	H	MPB	Max	
<b>40mm</b> F Dimension = 23mm, 17mm Between Flanges											
P28-S14M-40	6F	28	124.78	121.98	136	20	72	100	25	62	11.5
P30-S14M-40	6F	30	133.69	130.90	145	20	72	110	25	62	13.7
P32-S14M-40	6F	32	142.60	139.81	154	20	72	110	25	62	15.2
P34-S14M-40	6F	34	151.52	148.72	163	20	72	130	25	75	18.3
P36-S14M-40	6F	36	160.43	157.63	172	20	72	130	25	75	20.3
P40-S14M-40	6F	40	178.25	175.46	189	20	72	130	30	75	24.0
<b>60mm</b> F Dimension = 73mm, 67mm Between Flanges											
P28-S14M-60	6F	28	124.78	121.98	136	20	93	100	25	62	15.2
P30-S14M-60	6F	30	133.69	130.90	145	20	93	110	25	62	17.9
P32-S14M-60	6F	32	142.60	139.81	154	20	93	110	25	62	20.3
P34-S14M-60	6F	34	151.52	148.72	163	20	93	130	25	75	24.0
P36-S14M-60	6F	36	160.43	157.63	172	20	93	130	25	75	26.7
P40-S14M-60	6F	40	178.25	175.46	189	20	93	130	30	75	32.0
<b>80mm</b> F Dimension = 94mm, 88mm Between Flanges											
P28-S14M-80	6F	28	124.78	121.98	136	20	114	100	25	62	19.0
P30-S14M-80	6F	30	133.69	130.90	145	20	114	110	25	62	22.3
P32-S14M-80	6F	32	142.60	139.81	154	20	114	110	25	62	25.1
P34-S14M-80	6F	34	151.52	148.72	163	20	114	130	25	75	29.8
P36-S14M-80	6F	36	160.43	157.63	172	20	114	130	25	75	33.1
P40-S14M-80	6F	40	178.25	175.46	189	20	114	130	30	75	39.9
<b>100mm</b> F Dimension = 115mm, 109mm Between Flanges											
P28-S14M-100	6F	26	124.78	121.98	136	20	135	100	25	62	22.3
P30-S14M-100	6F	30	133.69	130.90	145	20	135	110	25	62	26.5
P32-S14M-100	6F	32	142.60	139.81	154	20	135	110	25	62	30.2
P34-S14M-100	6F	34	151.52	148.72	163	20	135	130	25	75	35.3
P36-S14M-100	6F	36	160.43	157.63	172	20	135	130	25	75	39.5
P40-S14M-100	6F	40	178.25	175.46	189	20	135	130	30	75	47.8
<b>120mm</b> F Dimension = 136mm, 130mm Between Flanges											
P28-S14M-120	6F	28	124.78	121.98	136	20	156	100	25	62	26.2
P30-S14M-120	6F	30	133.69	130.90	145	20	156	110	25	62	30.9
P32-S14M-120	6F	32	142.60	139.81	154	20	156	110	25	62	35.1
P34-S14M-120	6F	34	151.52	148.72	163	20	156	130	25	75	41.0
P36-S14M-120	6F	36	160.43	157.63	172	20	156	130	25	75	45.9
P40-S14M-120	6F	40	178.25	175.46	189	20	156	130	30	75	56.0

\* Weights shown are approximate.

Dimensions shown are for reference purposes only and are subject to change without notice. Where space requirements are critical, consult BANDO for certified specifications.

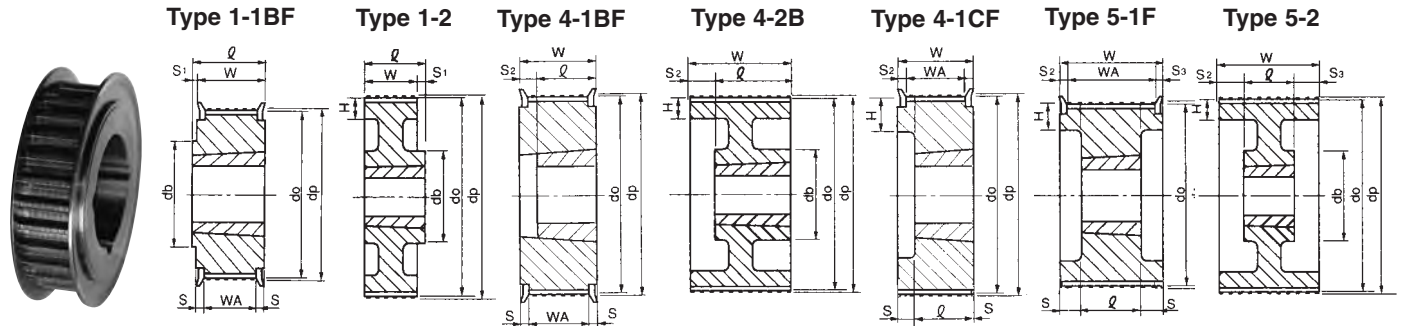

## STS - S8M 15mm, 25mm, 40mm and 60mm

Note: Additional sizes may be available. Contact BANDO.

Part Number	Type	No. of Teeth	Nominal Dimensions (mm)												Bushing	Weight*
			Pitch Dia.	Pulley OD	Flange OD	W	WA	S	db	ℓ	S <sub>1</sub>	S <sub>2</sub>	S <sub>3</sub>	H		
<b>15mm</b>																
TL28-S8M-15	1-1BF	28	71.30	69.93	77	23	17	3	47	25	2	—	—	—	1108	1.0
TL30-S8M-15	1-1BF	30	76.39	75.02	83	23	17	3	57	25	2	—	—	—	1108	1.0
TL32-S8M-15	1-1BF	32	81.49	80.12	89	23	17	3	60	25	2	—	—	—	1210	1.5
TL34-S8M-15	1-1BF	34	86.59	85.21	92	23	17	3	60	25	2	—	—	—	1610	1.7
TL36-S8M-15	1-1BF	36	91.67	90.30	98	23	17	3	70	35	12	—	—	—	1610	2.2
TL38-S8M-15	1-1BF	38	96.77	95.39	103	23	17	3	75	35	12	—	—	—	1610	2.9
TL40-S8M-15	1-1BF	40	101.86	100.49	108	23	17	3	80	35	12	—	—	—	2012	3.7
TL44-S8M-15	1-1BF	44	112.05	110.67	120	23	17	3	80	35	12	—	—	—	2012	4.6
TL48-S8M-15	1-1BF	48	122.23	120.86	129	23	17	3	80	35	12	—	—	—	2012	5.3
TL50-S8M-15	1-1BF	50	127.32	125.95	136	23	17	3	80	35	12	—	—	—	2012	7.5
TL60-S8M-15	1-1BF	60	152.79	151.42	160	23	17	3	80	35	12	—	—	—	2012	10.8
TL64-S8M-15	1-1BF	64	162.97	161.60	171	23	17	3	80	35	12	—	—	—	2012	4.0
TL72-S8M-15	1-2	72	183.35	181.97	—	23	—	—	100	40	17	—	—	15	2012	11.2
TL84-S8M-15	1-2	84	213.90	212.53	—	23	—	—	100	40	17	—	—	15	2012	12.8
<b>25mm</b>																
TL28-S8M-25	1-1BF	28	71.30	69.93	77	34	28	3	63	35	1	—	—	—	1108	1.4
TL30-S8M-25	1-1BF	30	76.39	75.02	83	34	28	3	63	35	1	—	—	—	1108	1.6
TL32-S8M-25	1-1BF	32	81.49	80.12	89	34	28	3	63	35	1	—	—	—	1210	1.8
TL34-S8M-25	1-1BF	34	86.59	85.21	92	34	28	3	63	35	1	—	—	—	1610	2.2
TL36-S8M-25	1-1BF	36	91.67	90.30	98	34	28	3	63	35	6	—	—	—	1610	2.6
TL38-S8M-25	1-1BF	38	96.77	95.39	103	34	28	3	80	40	6	—	—	—	1610	2.9
TL40-S8M-25	1-1BF	40	101.86	100.49	108	34	28	3	80	40	6	—	—	—	2012	3.1
TL44-S8M-25	1-1BF	44	112.05	110.67	120	34	28	3	80	40	6	—	—	—	2012	4.2
TL48-S8M-25	1-1BF	48	122.23	120.86	129	34	28	3	90	40	6	—	—	—	2012	5.3
TL50-S8M-25	1-1BF	50	127.32	125.95	136	34	28	3	90	40	6	—	—	—	2012	6.0
TL60-S8M-25	1-1BF	60	152.79	151.42	160	34	28	3	90	40	6	—	—	—	2012	9.3
TL64-S8M-25	1-1BF	64	162.97	161.60	171	34	28	3	90	40	6	—	—	—	2012	10.6
TL72-S8M-25	1-2	72	183.35	181.97	—	34	—	—	100	40	6	—	—	15	2517	13.9
TL84-S8M-25	1-2	84	213.90	212.53	—	34	—	—	140	45	11	—	—	15	2517	19.0
TL96-S8M-25	1-2	96	244.46	243.09	—	34	—	—	140	45	11	—	—	15	2517	19.0
TL120-S8M-25	1-2	120	305.58	304.21	—	34	—	—	140	45	11	—	—	16	2517	24.3
<b>40mm</b>																
TL30-S8M-40	4-1BF	30	76.39	75.02	83	50	44	3	—	40	—	10	—	—	1108	2.3
TL32-S8M-40	4-1BF	32	81.49	80.12	89	50	44	3	—	40	—	10	—	—	1210	2.5
TL34-S8M-40	4-1BF	34	86.59	85.21	92	50	44	3	—	40	—	10	—	—	1210	2.7
TL36-S8M-40	4-1BF	36	91.67	90.30	98	50	44	3	—	40	—	10	—	—	1610	2.9
TL38-S8M-40	4-1BF	38	96.77	95.39	103	50	44	3	—	40	—	10	—	—	1610	3.5
TL40-S8M-40	4-1BF	40	101.86	100.49	108	50	44	3	—	40	—	10	—	—	2012	4.2
TL44-S8M-40	4-1BF	44	112.05	110.67	120	50	44	3	—	40	—	10	—	—	2012	5.5
TL48-S8M-40	4-1BF	48	122.23	120.86	129	50	44	3	—	45	—	5	—	—	2012	5.7
TL50-S8M-40	4-1BF	50	127.32	125.95	136	50	44	3	—	45	—	5	—	—	2012	6.0
TL60-S8M-40	4-1CF	60	152.79	151.42	160	50	44	3	—	45	—	5	—	15	2517	10.8
TL64-S8M-40	4-1CF	64	162.97	161.60	171	50	44	3	—	45	—	5	—	15	2517	12.8
TL72-S8M-40	4-1C	72	183.35	181.97	—	50	—	—	—	45	—	5	—	15	2517	15.9
TL84-S8M-40	4-2B	84	213.90	212.53	—	50	—	—	125	45	—	5	—	15	3020	22.9
TL96-S8M-40	4-2B	96	244.46	243.09	—	50	—	—	140	45	—	5	—	15	3020	24.7
TL120-S8M-40	4-2B	120	305.58	304.21	—	50	—	—	140	45	—	5	—	16	3020	29.8
TL144-S8M-40	1-2	144	366.69	356.32	—	50	—	—	180	45	—	5	—	16	3020	37.5
TL156-S8M-40	1-2	156	397.25	395.88	—	50	—	—	180	55	—	5	—	16	3020	46.3
<b>60mm</b>																
TL30-S8M-60	4-1BF	30	76.39	75.02	83	71	65	3	—	45	—	10	—	—	1108	4.1
TL32-S8M-60	4-1BF	32	81.49	80.12	89	71	65	3	—	45	—	10	—	—	1108	4.5
TL34-S8M-60	4-1BF	34	86.59	85.21	92	71	65	3	—	45	—	10	—	—	1610	4.9
TL36-S8M-60	4-1BF	36	91.67	90.30	98	71	65	3	—	45	—	10	—	—	1610	5.3
TL38-S8M-60	4-1BF	38	96.77	95.39	103	71	65	3	—	45	—	10	—	—	1610	5.7
TL40-S8M-60	4-1BF	40	101.86	100.49	108	71	65	3	—	45	—	10	—	—	2012	6.2
TL44-S8M-60	5-1F	44	112.05	110.67	120	71	65	3	—	45	—	26	—	—	2012	6.6
TL48-S8M-60	5-1	48	122.23	120.86	129	71	65	3	—	45	—	26	—	—	2517	7.1
TL50-S8M-60	5-2	50	127.32	125.95	136	71	65	3	—	45	—	26	—	—	2517	8.2
TL60-S8M-60	5-2	60	152.79	151.42	160	71	65	3	—	45	—	15	11	16	3020	13.4
TL64-S8M-60	5-2	64	162.97	161.60	171	71	—	—	—	45	—	15	11	16	3020	15.2
TL72-S8M-60	5-2	72	183.35	181.97	—	71	—	—	—	45	—	15	11	16	3020	19.4
TL84-S8M-60	5-2	84	213.90	212.53	—	71	—	—	125	45	—	15	11	16	3020	27.1
TL96-S8M-60	5-2	96	244.46	243.09	—	71	—	—	160	55	—	5	11	16	3020	36.8
TL120-S8M-60	5-2	120	305.58	304.21	—	71	—	—	180	55	—	5	11	16	3020	43.7
TL144-S8M-60	5-2	144	366.69	356.32	—	71	—	—	180	55	—	5	11	16	3020	51.6
TL156-S8M-60	5-2	156	397.25	395.88	—	71	—	—	180	55	—	5	11	16	3525	55.1

Some sizes may be non-stock - consult BANDO for availability.

\* Weights shown are approximate. Dimensions shown are for reference purposes only.

To find an authorized BANDO distributor, go to [www.bandousa.com](http://www.bandousa.com) or call 1-800-829-6612



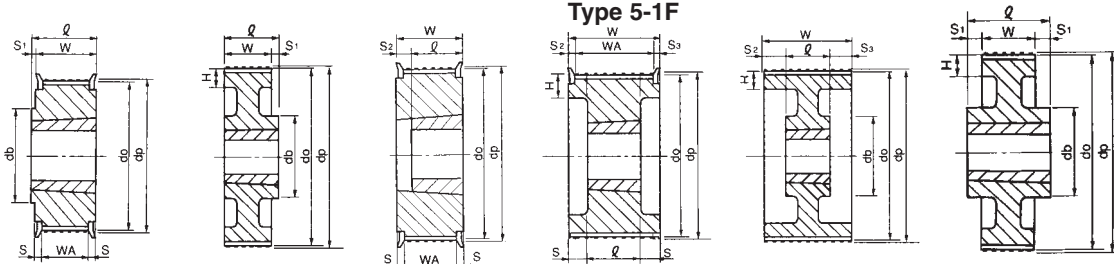

Type 1-1BF    Type 1-2    Type 4-1BF    Type 5-1    Type 5-2    Type 6

## STS - S14M 40mm, 60mm, 80mm, 100mm and 120mm Note: Additional sizes may be available. Contact BANDO.

Part Number	Type	No. of Teeth	Pitch Dia.	Pulley OD	Flange OD	Nominal Dimensions (mm)										Bushing	Weight* (Lbs.)
						W	WA	S	db	ℓ	S1	S2	S3	H			
<b>40mm</b>																	
TL28-S14M-40	4-1BF	28	124.78	121.98	136	52	46	3	—	45	—	7	—	—	2012	5.1	
TL30-S14M-40	4-1BF	30	133.69	130.90	145	52	46	3	—	45	—	7	—	—	2517	6.6	
TL32-S14M-40	4-1BF	32	142.60	139.81	154	52	46	3	—	45	—	7	—	—	2517	8.4	
TL34-S14M-40	4-1BF	34	151.52	148.72	163	52	46	3	—	45	—	7	—	—	2517	10.1	
TL36-S14M-40	4-1BF	36	160.43	157.63	172	52	46	3	—	45	—	7	—	—	2517	11.9	
TL40-S14M-40	5-1F	40	178.25	175.46	189	52	46	3	—	45	—	5	2	18	3020	16.5	
TL42-S14M-40	5-1F	42	187.17	184.37	198	52	46	3	—	45	—	5	2	18	3020	18.7	
TL44-S14M-40	5-1F	44	196.08	193.28	207	52	46	3	—	45	—	5	2	18	3020	21.2	
TL48-S14M-40	5-2F	48	213.90	211.11	225	52	46	3	125	45	—	5	2	18	3020	26.2	
TL50-S14M-40	5-2F	50	222.82	220.02	234	52	46	3	125	45	—	5	2	18	3020	22.9	
TL60-S14M-40	5-2	60	267.38	264.59	—	52	—	—	140	45	—	5	2	18	3525	26.9	
TL72-S14M-40	1-2	72	320.86	318.06	—	52	—	—	180	55	3	—	—	18	3525	39.9	
TL84-S14M-40	1-2	84	374.33	371.54	—	52	—	—	180	55	3	—	—	18	3525	46.3	
TL96-S14M-40	1-2	96	427.81	425.01	—	52	—	—	180	55	3	—	—	18	3525	52.9	
TL120-S14M-40	6	120	534.76	531.97	—	52	—	—	180	80	14	—	—	18	3525	81.6	
<b>60mm</b>																	
TL28-S14M-60	4-1CF	28	124.78	121.98	136	73	67	3	—	45	—	28	—	18	2517	7.1	
TL30-S14M-60	4-1CF	30	133.69	130.90	145	73	67	3	—	45	—	28	—	18	2517	9.3	
TL32-S14M-60	4-1CF	32	142.60	139.81	154	73	67	3	—	45	—	28	—	18	2517	11.5	
TL34-S14M-60	5-1F	34	151.52	148.72	163	73	67	3	—	45	—	20	8	18	2517	12.1	
TL36-S14M-60	5-1F	36	160.43	157.63	172	73	67	3	—	45	—	20	8	18	3020	13.9	
TL40-S14M-60	5-1F	40	178.25	175.46	189	73	67	3	—	45	—	20	8	18	3020	17.9	
TL42-S14M-60	5-1F	42	187.17	184.37	198	73	67	3	—	55	—	10	8	18	3020	19.8	
TL44-S14M-60	5-1F	44	196.08	193.28	207	73	67	3	—	55	—	10	8	18	3020	21.6	
TL48-S14M-60	5-1F	48	213.90	211.11	225	73	67	3	—	55	—	10	8	18	3525	27.1	
TL50-S14M-60	5-1F	50	222.82	220.02	234	73	67	3	—	55	—	10	8	18	3525	30.0	
TL60-S14M-60	5-2	60	267.38	264.59	—	73	—	—	180	55	—	10	8	18	3525	44.1	
TL72-S14M-60	5-2	72	320.86	318.06	—	73	—	—	180	55	—	10	8	18	3525	48.5	
TL84-S14M-60	1-2	84	374.33	371.54	—	73	—	—	180	80	7	—	—	18	3525	63.9	
TL96-S14M-60	1-2	96	427.81	425.01	—	73	—	—	180	80	7	—	—	18	4030	75.0	
TL120-S14M-60	1-2	120	534.76	531.97	—	73	—	—	212	90	17	—	—	20	4030	108.0	
<b>80mm</b>																	
TL36-S14M-80	4-1BF	36	160.43	157.63	172	94	88	3	—	55	—	39	—	—	3020	15.0	
TL40-S14M-80	4-1BF	40	178.25	175.46	189	94	88	3	—	55	—	39	—	—	3020	22.3	
TL42-S14M-80	5-1F	42	187.17	184.37	198	94	88	3	—	55	—	25	14	20	3020	24.5	
TL44-S14M-80	5-1F	44	196.08	193.28	207	94	88	3	—	55	—	25	14	20	3525	25.1	
TL48-S14M-80	5-1F	48	213.90	211.11	225	94	88	3	—	55	—	25	14	20	3525	31.1	
TL50-S14M-80	5-1F	50	222.82	220.02	234	94	88	3	—	55	—	25	14	20	3525	34.2	
TL60-S14M-80	5-2	60	267.38	264.59	—	94	—	—	160	80	—	10	4	20	4030	55.1	
TL72-S14M-80	5-2	72	320.86	318.06	—	94	—	—	180	80	—	10	4	20	4030	63.9	
TL84-S14M-80	4-2A	84	374.33	371.54	—	94	—	—	212	90	—	—	4	20	4030	86.0	
TL96-S14M-80	4-2A	96	427.81	425.01	—	94	—	—	212	90	—	—	4	20	4030	97.0	
TL120-S14M-80	4-2A	120	534.76	531.97	—	94	—	—	212	90	—	—	4	20	4535	123.5	
TL144-S14M-80	4-2A	144	641.71	638.92	—	94	—	—	236	90	—	—	4	20	5040	165.3	
TL156-S14M-80	4-2A	156	695.19	692.39	—	94	—	—	236	90	—	—	4	20	5040	187.4	
<b>100mm</b>																	
TL36-S14M-100	4-1BF	36	160.43	157.63	172	115	109	3	—	80	—	35	—	—	3020	19.2	
TL40-S14M-100	5-1F	40	178.25	175.46	189	115	109	3	—	80	—	25	10	20	3020	27.1	
TL42-S14M-100	5-1F	42	187.17	184.37	198	115	109	3	—	80	—	25	10	20	3020	31.7	
TL44-S14M-100	5-1F	44	196.08	193.28	207	115	109	3	—	80	—	20	15	20	3525	32.6	
TL48-S14M-100	5-1F	48	213.90	211.11	225	115	109	3	—	80	—	20	15	20	3525	40.8	
TL50-S14M-100	5-1F	50	222.82	220.02	234	115	109	3	—	80	—	20	15	20	3525	44.1	
TL60-S14M-100	5-1	60	267.38	264.59	—	115	—	—	—	90	—	10	15	20	4030	66.1	
TL72-S14M-100	5-2	72	320.86	318.06	—	115	—	—	200	90	—	10	15	20	4030	83.8	
TL84-S14M-100	5-2	84	374.33	371.54	—	115	—	—	212	90	—	10	15	20	4030	94.8	
TL96-S14M-100	5-2	96	427.81	425.01	—	115	—	—	236	90	—	10	15	20	4030	119.0	
TL120-S14M-100	5-2	120	534.76	531.97	—	115	—	—	236	90	—	10	15	20	4535	149.9	
TL144-S14M-100	4-2A	144	641.71	638.92	—	115	—	—	265	110	—	—	5	20	5040	198.4	
TL156-S14M-100	4-2A	156	695.19	692.39	—	115	—	—	265	110	—	—	5	20	5040	224.9	
<b>120mm</b>																	
TL40-S14M-120	5-1F	40	178.25	175.46	189	136	130	3	—	80	—	40	16	20	3020	27.8	
TL42-S14M-120	5-1F	42	187.17	184.37	198	136	130	3	—	80	—	40	16	20	3020	31.5	
TL44-S14M-120	5-1F	44	196.08	193.28	207	136	130	3	—	80	—	40	16	20	3020	36.6	
TL48-S14M-120	5-1F	48	213.90	211.11	225	136	130	3	—	80	—	40	16	20	3020	44.1	
TL50-S14M-120	5-1F	50	222.82	220.02	234	136	130	3	—	80	—	40	16	20	4535	48.5	
TL60-S14M-120	5-1	60	267.38	264.59	—	136	—	—	—	90	—	30	16	20	4535	72.8	
TL72-S14M-120	5-2	72	320.86	318.06	—	136	—	—	200	90	—	30	16	20	5040	110.2	
TL84-S14M-120	5-2	84	374.33	371.54	—	136	—	—	236	90	—	30	16	20	5040	114.6	
TL96-S14M-120	5-2	96	427.81	425.01	—	136	—	—	236	90	—	30	16	20	5040	134.5	
TL120-S14M-120	5-2	120	534.76	531.97	—	136	—	—	265	110	—	10	16	20	6050	191.8	
TL144-S14M-120	5-2	144	641.71	638.92	—	136	—	—	265	110	—	10	16	20	6050	231.5	
TL156-S14M-120	5-2	156	695.19	692.39	—	136	—	—	265	110	—	10	16	20	6050	257.9	

Some sizes may be non-stock sizes - consult BANDO for availability.



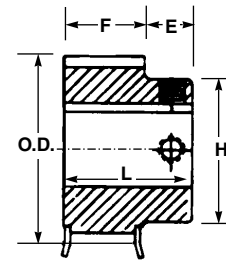

TYPE 6F

## 5mm Pitch (HT) for 15mm and 25mm Wide Belts

Part Number	Type	Number of Teeth	Nominal Dimensions (in)								Weight* (Lbs.)
			Pitch Dia.	Pulley OP	Flange OD	E	L	H	Bore		
									MPB	Max.	
<b>15mm F Dimension = 0.84"</b>											
P32-5M-15	6F	32	2.005	1.960	2.160	1/2	1-11/32	1-9/16	1/2	.88	.84
P34-5M-15	6F	34	2.130	2.085	2.295	1/2	1-11/32	1-11/16	1/2	1.00	.93
P36-5M-15	6F	36	2.256	2.211	2.410	1/2	1-11/32	1-13/16	1/2	1.12	1.03
<b>25mm F Dimension = 1.23"</b>											
P32-5M-25	6F	32	2.005	1.960	2.165	1/2	1-23/32	1-9/16	1/2	.88	1.19
P34-5M-25	6F	34	2.130	2.085	2.290	1/2	1-23/32	1-11/16	1/2	1.00	1.38
P36-5M-25	6F	36	2.256	2.211	2.415	1/2	1-23/32	1-13/16	1/2	1.12	1.56

## 8mm Pitch (HT) for 20mm and 30mm Wide Belts

Part Number	Type	Number of Teeth	Nominal Dimensions (in)								Weight* (Lbs.)
			Pitch Dia.	Pulley OP	Flange OD	E	L	H	Bore		
									MPB	Max.	
<b>20mm F Dimension = 1-5/32"</b>											
P22-8M-20	6F	22	2.206	2.152	2.559	5/8	1-3/4	1-5/8	1/2	1-3/16	1.1
<b>30mm F Dimension = 1-17/32"</b>											
P22-8M-30	6F	22	2.206	2.152	2.559	5/8	2-1/8	1-5/8	1/2	1-3/16	1.4
P24-8M-30	6F	24	2.406	2.352	2.756	5/8	2-1/8	1-13/16	1/2	1-1/4	1.8
P26-8M-30	6F	26	2.607	2.553	2.953	5/8	2-1/4	2	1/2	1-1/4	2.2

## 14mm Pitch (HT) for 85mm and 115mm Wide Belts

Part Number	Type	Number of Teeth	Nominal Dimensions (in)								Weight* (Lbs.)
			Pitch Dia.	Pulley OP	Flange OD	E	L	H	Bore		
									MPB	Max.	
<b>85mm F Dimension = 4.0"</b>											
P28-14M-85	D1F	28	4.912	4.808	5.56	1	4	3-11/16	1-1/4	2-11/16	17
P29-14M-85	D1F	29	5.088	4.983	5.56	1	4	3-11/16	1-1/4	2-11/16	18
<b>115mm F Dimension = 5-1/4"</b>											
P28-14M-115	D1F	28	4.912	4.808	5.56	1-1/4	5	3-11/16	1-1/4	2-11/16	21
P29-14M-115	D1F	29	5.088	4.983	5.56	1-1/4	5	3-11/16	1-1/4	2-11/16	23

\* Weights shown are approximate.

Dimensions shown are for reference purposes only and are subject to change without notice. Where space requirements are critical, consult BANDO for certified specifications.

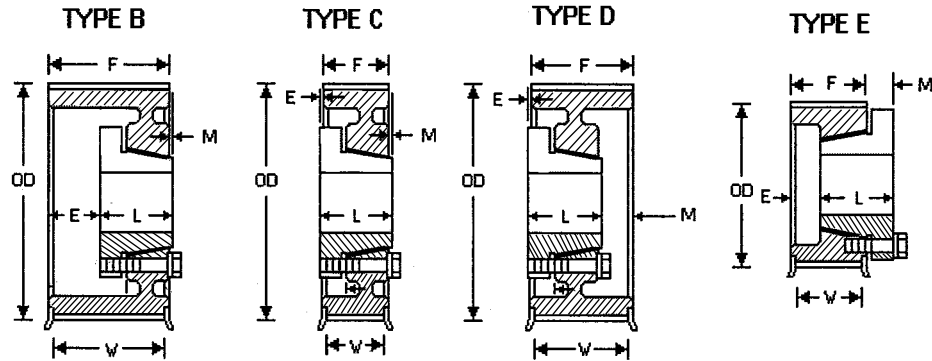

## 5mm Pitch (HT) for 15mm and 25mm Wide Belts

Part Number	Type	Number of Teeth	Nominal Dimensions (in)								Bushing	Weight* (Lbs.)
			Pitch Dia.	Pulley OD	Flange OD	E	L	F	M	W		
<b>15mm (15)</b>												
P38-5M-15	E1F	38	2.381	2.336	2.54	0.28	1.00	0.84	0.44	0.65	JA	0.61
P40-5M-15	E1F	40	2.506	2.461	2.66	0.28	1.00	0.84	0.44	0.65	JA	0.72
P44-5M-15	E1F	44	2.757	2.712	2.91	0.28	1.00	0.84	0.44	0.65	JA	0.95
P48-5M-15	C1F	48	3.008	2.963	3.16	0.16	1.00	0.84	0.00	0.65	JA	0.97
P52-5M-15	C1F	52	3.258	3.213	3.41	0.16	1.00	0.84	0.00	0.65	JA	1.17
P56-5M-15	D1F	56	3.509	3.464	3.66	0.50	1.25	0.84	0.09	0.65	SH	1.37
P60-5M-15	D1F	60	3.760	3.715	3.92	0.50	1.25	0.84	0.09	0.65	SH	1.68
P64-5M-15	D1F	64	4.010	3.965	4.16	0.50	1.25	0.84	0.09	0.65	SH	1.80
P68-5M-15	C1F	68	4.261	4.216	4.41	0.47	1.31	0.84	0.00	0.65	SDS	2.10
P72-5M-15	C1F	72	4.511	4.466	4.66	0.47	1.31	0.84	0.00	0.65	SDS	2.43
P80-5M-15	C1	80	5.013	4.968	-	0.47	1.31	0.84	0.00	0.65	SDS	3.15
P90-5M-15	C1	90	5.639	5.594	-	0.47	1.31	0.84	0.00	0.65	SDS	4.17
P112-5M-15	C1	112	7.018	6.973	-	0.47	1.31	0.84	0.00	0.65	SDS	6.75
<b>25mm (25)</b>												
P38-5M-25	E1F	38	2.381	2.336	2.54	0.67	1.00	1.23	0.44	1.04	JA	0.94
P40-5M-25	E1F	40	2.506	2.461	2.66	0.67	1.00	1.23	0.44	1.04	JA	1.06
P44-5M-25	E1F	44	2.757	2.712	2.91	0.67	1.00	1.23	0.44	1.04	JA	1.13
P48-5M-25	B1F	48	3.008	2.963	3.16	0.23	1.00	1.23	0.00	1.04	JA	1.20
P52-5M-25	B1F	52	3.258	3.213	3.41	0.23	1.00	1.23	0.00	1.04	JA	1.75
P56-5M-25	D1F	56	3.509	3.464	3.66	0.08	1.25	1.23	0.06	1.04	SH	1.75
P60-5M-25	D1F	60	3.760	3.715	3.92	0.08	1.25	1.23	0.06	1.04	SH	2.13
P64-5M-25	D1F	64	4.010	3.965	4.16	0.08	1.25	1.23	0.06	1.04	SH	2.50
P68-5M-25	C1F	68	4.261	4.216	4.41	0.08	1.31	1.23	0.00	1.04	SDS	2.63
P72-5M-25	C1F	72	4.511	4.466	4.66	0.08	1.31	1.23	0.00	1.04	SDS	3.00
P80-5M-25	C1	80	5.013	4.968	-	0.08	1.31	1.23	0.00	1.04	SDS	3.81
P90-5M-25	C1	90	5.639	5.594	-	0.08	1.31	1.23	0.00	1.04	SDS	4.69
P112-5M-25	C2	112	7.018	6.973	-	0.08	1.31	1.23	0.00	1.04	SDS	6.02

\* Weights shown are approximate.

Pulley Type: F = Flanged

† Prices do not include bushing.

Dimensions shown are for reference purposes only and are subject to change without notice. Where space requirements are critical, consult Bando for certified specifications.

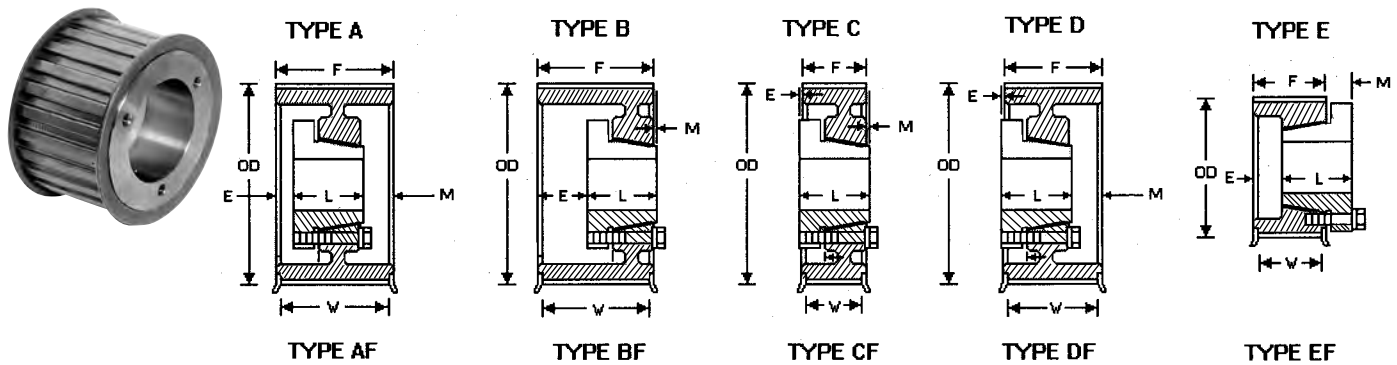

## 8mm Pitch (HT) for 20mm and 30mm Wide Belts

Part Number	Type	Number of Teeth	Nominal Dimensions (in)								Bushing	Weight* (Lbs.)
			Pitch Dia.	Pulley OD	Flange OD	E	L	F	M	W		
<b>20mm (20)</b>												
P24-8M-20	E1F	24	2.406	2.352	2.756	9/16	1	1-1/8	7/16	7/8	JA	1.0
P26-8M-20	E1F	26	2.607	2.553	2.953	9/16	1	1-1/8	7/16	7/8	JA	1.2
P28-8M-20	E1F	28	2.807	2.759	3.150	1/4	1-1/4	1-1/8	3/8	7/8	D	1.6
P30-8M-20	E1F	30	3.008	2.958	3.346	1/4	1-1/4	1-1/8	3/8	7/8	D	1.9
P32-8M-20	C1F	32	3.208	3.156	3.543	1/8	1-1/4	1-1/8	0	7/8	D	2.0
P34-8M-20	D1F	34	3.409	3.355	3.819	3/16	1-1/4	1-1/8	1/16	7/8	SH	2.0
P36-8M-20	D1F	36	3.609	3.555	4.009	3/16	1-1/4	1-1/8	1/16	7/8	SH	2.2
P38-8M-20	D1F	38	3.810	3.756	4.210	3/16	1-1/4	1-1/8	1/16	7/8	SH	2.5
P40-8M-20	D1F	40	4.010	3.956	4.410	3/16	1-1/4	1-1/8	1/16	7/8	SH	2.8
P44-8M-20	C1F	44	4.411	4.357	4.911	3/16	1-5/16	1-1/8	0	7/8	SDS	3.4
P48-8M-20	C1F	48	4.812	4.758	5.212	3/16	1-5/16	1-1/8	0	7/8	SDS	4.0
P56-8M-20	C1F	56	5.614	5.560	6.014	3/16	1-5/16	1-1/8	0	7/8	SDS	5.3
P64-8M-20	C1F	64	6.416	6.362	6.716	3/16	1-5/16	1-1/8	0	7/8	SDS	6.9
P72-8M-20	C2F	72	7.218	7.164	7.598	3/16	1-5/16	1-1/8	0	7/8	SDS	6.7
P80-8M-20	C2F	80	8.020	7.996	8.420	3/16	1-5/16	1-1/8	0	7/8	SDS	7.5
P90-8M-20	C3	90	9.023	8.969	-	3/16	1-5/16	1-1/8	0	-	SDS	8.0
<b>30mm (30)</b>												
P28-8M-30	E1F	28	2.807	2.759	3.150	5/8	1-1/4	1-1/2	3/8	1-1/4	D	2.0
P30-8M-30	E1F	30	3.008	2.958	3.346	5/8	1-1/4	1-1/2	3/8	1-1/4	D	2.3
P32-8M-30	B1F	32	3.208	3.156	3.543	1/4	1-1/4	1-1/2	0	1-1/4	D	2.2
P34-8M-30	A1F	34	3.409	3.355	3.819	3/16	1-1/4	1-1/2	1/16	1-1/4	SH	2.2
P36-8M-30	A1F	36	3.609	3.555	4.009	3/16	1-1/4	1-1/2	1/16	1-1/4	SH	2.5
P38-8M-30	A1F	38	3.810	3.756	4.210	3/16	1-1/4	1-1/2	1/16	1-1/4	SH	2.8
P40-8M-30	A1F	40	4.010	3.956	4.410	3/16	1-1/4	1-1/2	1/16	1-1/4	SH	3.3
P44-8M-30	B1F	44	4.411	4.357	4.911	3/16	1-5/16	1-1/2	0	1-1/4	SDS	3.8
P48-8M-30	B1F	48	4.812	4.758	5.212	3/16	1-5/16	1-1/2	0	1-1/4	SDS	4.5
P56-8M-30	B1F	56	5.614	5.560	6.014	3/16	1-5/16	1-1/2	0	1-1/4	SDS	5.9
P64-8M-30	C1F	64	6.416	6.362	6.716	3/8	1-7/8	1-1/2	0	1-1/4	SK	10.4
P72-8M-30	C2F	72	7.218	7.164	7.598	3/8	1-7/8	1-1/2	0	1-1/4	SK	10.0
P80-8M-30	C2F	80	8.020	7.966	8.420	3/8	1-7/8	1-1/2	0	1-1/4	SK	11.8
P90-8M-30	C2	90	9.023	8.969	-	3/8	1-7/8	1-1/2	0	-	SK	13.5
P112-8M-30	C3	112	11.229	11.175	-	3/8	1-7/8	1-1/2	0	-	SK	15.3

\* Weights shown are approximate.

Pulley Type: F = Flanged

† Prices do not include bushing.

Dimensions shown are for reference purposes only and are subject to change without notice. Where space requirements are critical, consult Bando for certified specifications.



## 8mm Pitch (HT) for 50mm and 85mm Wide Belts

Part Number	Type	Number of Teeth	Nominal Dimensions (in)								Bushing	Weight* (Lbs.)
			Pitch Dia.	Pulley OD	Flange OD	E	L	F	M	W		
<b>50mm (50)</b>												
P32-8M-50	A1F	32	3.208	3.156	3.543	1/2	1-1/4	2-3/8	5/8	2-1/8	JA	2.5
P32-8M-50	A1F	32	3.208	3.156	3.543	1/2	1-1/4	2-3/8	5/8	2-1/8	D	2.5
P34-8M-50	A1F	34	3.409	3.355	3.819	0	1-1/4	2-3/8	1-1/8	2-1/8	SH	2.6
P36-8M-50	A1F	36	3.609	3.355	4.009	0	1-1/4	2-3/8	1-1/8	2-1/8	SH	3.1
P38-8M-50	A1F	38	3.810	3.756	4.210	0	1-1/4	2-3/8	1-1/8	2-1/8	SH	3.5
P40-8M-50	A1F	40	4.010	3.956	4.410	0	1-1/4	2-3/8	1-1/8	2-1/8	SH	4.2
P44-8M-50	A1F	44	4.411	4.357	4.911	0	1-13/16	2-3/8	9/16	2-1/8	SD	5.7
P48-8M-50	A1F	48	4.812	4.758	5.212	0	1-13/16	2-3/8	9/16	2-1/8	SD	6.9
P56-8M-50	D1F	56	5.614	5.560	6.014	1/16	1-7/8	2-3/8	9/16	2-1/8	SK	9.4
P64-8M-50	D1F	64	6.416	6.362	6.716	1/16	1-7/8	2-3/8	9/16	2-1/8	SK	12.0
P72-8M-50	D1F	72	7.218	7.164	7.598	1/16	1-7/8	2-3/8	9/16	2-1/8	SK	15.0
P80-8M-50	D2F	80	8.020	7.966	8.420	1/16	2	2-3/8	7/16	2-1/8	SF	16.1
P90-8M-50	D2	90	9.023	8.969	-	1/16	2	2-3/8	7/16	-	SF	19.1
P112-8M-50	D3	112	11.229	11.175	-	1/16	2	2-3/8	7/16	-	SF	22.0
P144-8M-50	D3	144	14.437	14.383	-	1/2	2-5/8	2-3/8	1/4	-	E	38.1
P192-8M-50	D3	192	19.249	19.195	-	1/2	2-5/8	2-3/8	1/4	-	E	52.5
<b>85mm (85)</b>												
P34-8M-85	A1F	34	3.409	3.355	3.819	1	1-1/4	3-3/4	1-1/2	3-1/2	SH	3.3
P36-8M-85	A1F	36	3.609	3.555	4.009	1	1-1/4	3-3/4	1-1/2	3-1/2	SH	4.1
P38-8M-85	A1F	38	3.810	3.756	4.210	1	1-1/4	3-3/4	1-1/2	3-1/2	SH	4.6
P40-8M-85	A1F	40	4.010	3.956	4.410	11/16	1-13/16	3-3/4	1-1/4	3-1/2	SD	5.6
P44-8M-85	A1F	44	4.411	4.357	4.911	11/16	1-13/16	3-3/4	1-1/4	3-1/2	SD	7.1
P48-8M-85	A1F	48	4.812	4.758	5.212	11/16	1-13/16	3-3/4	1-1/4	3-1/2	SD	8.7
P56-8M-85	A1F	56	5.614	5.560	6.014	5/8	1-7/8	3-3/4	1-1/4	3-1/2	SK	11.6
P64-8M-85	A1F	64	6.416	6.362	6.716	5/8	1-7/8	3-3/4	1-1/4	3-1/2	SK	14.6
P72-8M-85	A1F	72	7.218	7.164	7.598	5/8	2	3-3/4	1-1/8	3-1/2	SF	18.5
P80-8M-85	A2F	80	8.020	7.966	8.420	5/8	2	3-3/4	1-1/8	3-1/2	SF	20.4
P90-8M-85	A2	90	9.023	8.969	-	5/8	2	3-3/4	1-1/8	-	SF	23.7
P112-8M-85	A3	112	11.229	11.175	-	5/8	2	3-3/4	1-1/8	-	SF	29.6
P144-8M-85	A3	144	14.437	14.383	-	3/16	2-5/8	3-3/4	1-1/16	-	E	50.6
P192-8M-85	A3	192	19.249	19.195	-	3/16	2-5/8	3-3/4	1-1/16	-	E	68.5

\* Weights shown are approximate.

Pulley Type: F = Flanged

† Prices do not include bushing.

Dimensions shown are for reference purposes only and are subject to change without notice. Where space requirements are critical, consult Bando for certified specifications.

## Minimum Recommended Pulley Sizes

Using pulley sizes less than the recommended minimum can substantially reduce belt life and drive efficiency. Values shown are number of pulley teeth.

Speed Range (RPM)	2mm	3mm	5mm	8mm	14mm
<b>0 - 870</b>	14	14	12	22	32
<b>870 - 1160</b>	14	14	14	24	34
<b>1160 - 1750</b>	16	16	16	26	38
<b>1750 - 3500</b>	18	18	18	28	44
<b>3500 - over</b>	20	20	18	30	44

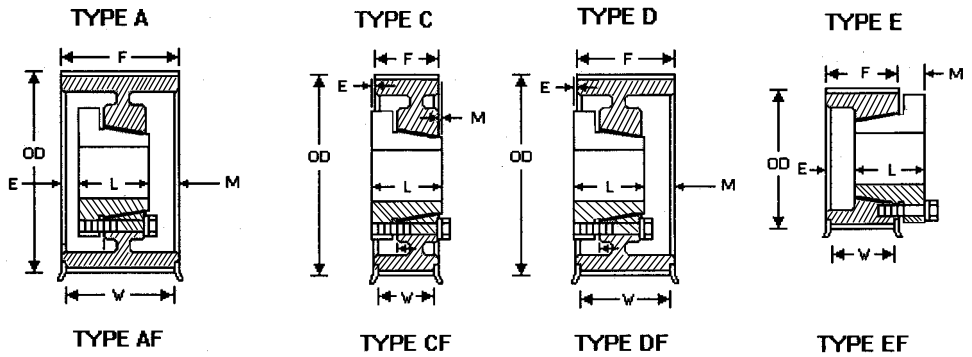

## 14mm Pitch (HT) for 40mm and 55mm Wide Belts

Part Number	Type	Number of Teeth	Nominal Dimensions (in)								Bushing	Weight* (Lbs.)
			Pitch Dia.	Pulley OD	Flange OD	E	L	F	M	W		
<b>40mm (40)</b>												
P28-14M-40	E1F	28	4.912	4.808	5.402	7/8	1-7/8	2-1/8	5/8	1-13/16	SK	5.2
P29-14M-40	E1F	29	5.088	4.983	5.402	7/8	1-7/8	2-1/8	5/8	1-13/16	SK	5.7
P30-14M-40	D1F	30	5.263	5.157	5.763	3/16	1-7/8	2-1/8	7/16	1-13/16	SK	5.6
P32-14M-40	D1F	32	5.614	5.507	6.114	3/16	1-7/8	2-1/8	7/16	1-13/16	SK	7.2
P34-14M-40	D1F	34	5.965	5.858	6.465	3/16	1-7/8	2-1/8	7/16	1-13/16	SK	8.6
P36-14M-40	D1F	36	6.316	6.208	6.816	3/16	2	2-1/8	5/16	1-13/16	SF	9.0
P38-14M-40	D1F	38	6.667	6.559	7.167	3/16	2	2-1/8	5/16	1-13/16	SF	10.6
P40-14M-40	D1F	40	7.018	6.909	7.518	3/16	2	2-1/8	5/16	1-13/16	SF	12.1
P44-14M-40	D1F	44	7.720	7.610	8.395	5/8	2-5/8	2-1/8	1/8	1-13/16	E	14.0
P48-14M-40	D1F	48	8.412	8.311	8.941	5/8	2-5/8	2-1/8	1/8	1-13/16	E	18.4
P52-14M-40	D1F	52	9.123	9.013	9.687	5/8	2-5/8	2-1/8	1/8	1-13/16	E	23.6
P56-14M-40	D1F	56	9.825	9.715	10.355	5/8	2-5/8	2-1/8	1/8	1-13/16	E	27.3
P60-14M-40	D1F	60	10.527	10.417	11.067	5/8	2-5/8	2-1/8	1/8	1-13/16	E	29.0
P64-14M-40	D2F	64	11.229	11.119	11.593	5/8	2-5/8	2-1/8	1/8	1-13/16	E	32.6
P68-14M-40	D2F	68	11.930	11.820	12.500	5/8	2-5/8	2-1/8	1/8	1-13/16	E	36.0
P72-14M-40	D2F	72	12.632	12.522	13.006	5/8	2-5/8	2-1/8	1/8	1-13/16	E	39.8
P80-14M-40	D2F	80	14.036	13.926	14.620	5/8	2-5/8	2-1/8	1/8	1-13/16	E	43.5
P90-14M-40	D3	90	15.790	15.680	-	5/8	2-5/8	2-1/8	1/8	-	E	47.8
P112-14M-40	D3	112	19.650	19.540	-	5/8	2-5/8	2-1/8	1/8	-	E	52.5
P144-14M-40	D3	144	25.264	25.154	-	5/8	2-5/8	2-1/8	1/8	-	E	80.0
<b>55mm (55)</b>												
P28-14M-55	E1F	28	4.912	4.808	5.402	1-1/2	1-7/8	2-3/4	5/8	2-7/16	SK	6.5
P29-14M-55	E1F	29	5.088	4.983	5.402	1-1/2	1-7/8	2-3/4	5/8	2-7/16	SK	8.0
P30-14M-55	A1F	30	5.263	5.157	5.763	1/8	1-7/8	2-3/4	3/4	2-7/16	SK	8.3
P32-14M-55	A1F	32	5.614	5.507	6.114	1/8	1-7/8	2-3/4	3/4	2-7/16	SK	8.5
P34-14M-55	A1F	34	5.965	5.858	6.465	1/8	1-7/8	2-3/4	3/4	2-7/16	SK	10.3
P36-14M-55	A1F	36	6.316	6.208	6.816	1/8	2	2-3/4	5/8	2-7/16	SF	10.9
P38-14M-55	A1F	38	6.667	6.559	7.167	1/8	2	2-3/4	5/8	2-7/16	SF	12.2
P40-14M-55	A1F	40	7.018	6.909	7.518	1/8	2	2-3/4	5/8	2-7/16	SF	14.9
P44-14M-55	D1F	44	7.720	7.610	8.395	5/16	2-5/8	2-3/4	7/16	2-7/16	E	16.5
P48-14M-55	D1F	48	8.421	8.311	8.941	5/16	2-5/8	2-3/4	7/16	2-7/16	E	21.8
P52-14M-55	D1F	52	9.123	9.013	9.687	5/16	2-5/8	2-3/4	7/16	2-7/16	E	26.5
P56-14M-55	D1F	56	9.825	9.715	10.355	5/16	2-5/8	2-3/4	7/16	2-7/16	E	31.4
P60-14M-55	D1F	60	10.527	10.417	11.067	5/16	2-5/8	2-3/4	7/16	2-7/16	E	37.0
P64-14M-55	C1F	64	11.229	11.119	11.593	7/8	3-5/8	2-3/4	-	2-7/16	F	50.7
P68-14M-55	D2F	68	11.930	11.820	12.500	7/8	3-5/8	2-3/4	-	2-7/16	F	45.0
P72-14M-55	C2F	72	12.632	12.522	13.006	7/8	3-5/8	2-3/4	-	2-7/16	F	48.2
P80-14M-55	C2F	80	14.036	13.926	14.620	7/8	3-5/8	2-3/4	-	2-7/16	F	56.0
P90-14M-55	C3	90	15.790	15.680	-	7/8	3-5/8	2-3/4	-	-	F	56.5
P112-14M-55	C3	112	19.650	19.540	-	7/8	3-5/8	2-3/4	-	-	F	72.0
P144-14M-55	C3	144	25.264	25.154	-	7/8	3-5/8	2-3/4	-	-	F	98.0
P168-14M-55	C3	168	29.475	29.365	-	7/8	3-5/8	2-3/4	-	-	F	130.0
P192-14M-55	C3	192	33.686	33.576	-	7/8	3-5/8	2-3/4	-	-	F	155.0
P216-14M-55	C3	216	37.896	37.786	-	7/8	3-5/8	2-3/4	-	-	F	210.0

\* Weights shown are approximate.

Pulley Type: F = Flanged

† Prices do not include bushing.

Dimensions shown are for reference purposes only and are subject to change without notice. Where space requirements are critical, consult Bando for certified specifications.



## 14mm Pitch (HT) for 85mm, 115mm and 170mm Wide Belts

Part Number	Type	Number of Teeth	Nominal Dimensions (in)							Bushing	Weight* (Lbs.)	
			Pitch Dia.	Pulley OD	Flange OD	E	L	F	M			W
<b>85mm (85)</b>												
P30-14M-85	A1F	30	5.263	5.157	5.763	1	4	4	1	3-11/16	SK	9.0
P32-14M-85	A1F	32	5.614	5.507	6.114	1	4	4	1	3-11/16	SK	10.3
P34-14M-85	A1F	34	5.965	5.858	6.465	3/4	1-7/8	4	1-3/8	3-11/16	SK	13.8
P36-14M-85	A1F	36	6.316	6.208	6.816	3/4	1-7/8	4	1-3/8	3-11/16	SF	14.0
P38-14M-85	A1F	38	6.667	6.559	7.167	3/4	1-7/8	4	1-3/8	3-11/16	SF	16.2
P40-14M-85	A1F	40	7.018	6.909	7.518	3/4	2	4	1-1/4	3-11/16	SF	18.2
P44-14M-85	A1F	44	7.720	7.610	8.395	3/4	2	4	1-1/4	3-11/16	E	21.4
P48-14M-85	A1F	48	8.421	8.311	8.941	3/4	2	4	1-1/4	3-11/16	E	28.0
P52-14M-85	A1F	52	9.123	9.013	9.687	5/16	2-5/8	4	1-1/16	3-11/16	E	33.0
P56-14M-85	D1F	56	9.825	9.715	10.355	5/16	2-5/8	4	1-1/16	3-11/16	F	43.8
P60-14M-85	D1F	60	10.527	10.417	11.067	5/16	2-5/8	4	1-1/16	3-11/16	F	52.0
P64-14M-85	D1F	64	11.229	11.119	11.593	1/4	3-5/8	4	5/8	3-11/16	F	60.0
P68-14M-85	D2F	68	11.930	11.820	12.500	1/4	3-5/8	4	5/8	3-11/16	F	53.8
P72-14M-85	D2F	72	12.632	12.522	13.006	1/4	3-5/8	4	5/8	3-11/16	F	58.0
P80-14M-85	D2F	80	14.036	13.926	14.620	1/4	3-5/8	4	5/8	3-11/16	F	65.5
P90-14M-85	D3	90	15.790	15.680	-	1/4	3-5/8	4	5/8	-	F	69.0
P112-14M-85	D3	112	19.650	19.540	-	1/4	3-5/8	4	5/8	-	F	88.0
P144-14M-85	D3	144	25.264	25.154	-	1/4	3-5/8	4	5/8	-	F	125.0
P168-14M-85	D3	168	29.475	29.365	-	1/4	3-5/8	4	5/8	-	J	153.0
P192-14M-85	D3	192	33.686	33.576	-	1/4	3-5/8	4	5/8	-	J	177.0
P216-14M-85	D3	216	37.896	37.786	-	1/4	3-5/8	4	5/8	-	J	215.0
<b>115mm (115)</b>												
P30-14M-115	A1F	30	5.263	5.157	5.763	1-3/8	1-7/8	5-1/4	2	4-15/16	SK	11.0
P32-14M-115	A1F	32	5.614	5.507	6.114	1-3/8	1-7/8	5-1/4	2	4-15/16	SK	14.5
P34-14M-115	A1F	34	5.965	5.858	6.465	1-3/8	1-7/8	5-1/4	2	4-15/16	SK	18.3
P36-14M-115	A1F	36	6.316	6.208	6.816	1-3/8	2	5-1/4	1-7/8	4-15/16	SF	17.0
P38-14M-115	A1F	38	6.667	6.559	7.167	1-3/8	2	5-1/4	1-7/8	4-15/16	SF	21.0
P40-14M-115	A1F	40	7.018	6.909	7.518	1-3/8	2	5-1/4	1-7/8	4-15/16	SF	22.4
P44-14M-115	A1F	44	7.720	7.610	8.395	15/16	2-5/8	5-1/4	1-11/16	4-15/16	E	25.5
P48-14M-115	A1F	48	8.421	8.311	8.941	15/16	2-5/8	5-1/4	1-11/16	4-15/16	E	33.2
P52-14M-115	A1F	52	9.123	9.013	9.687	3/8	3-5/8	5-1/4	1-1/4	4-15/16	F	42.0
P56-14M-115	A1F	56	9.825	9.715	10.355	3/8	3-5/8	5-1/4	1-1/4	4-15/16	F	50.5
P60-14M-115	A1F	60	10.527	10.417	11.067	3/8	3-5/8	5-1/4	1-1/4	4-15/16	F	58.3
P64-14M-115	D1F	64	11.229	11.119	11.593	3/16	4-1/2	5-1/4	15/16	4-15/16	J	72.3
P68-14M-115	D1F	68	11.930	11.820	12.500	3/16	4-1/2	5-1/4	15/16	4-15/16	J	83.2
P72-14M-115	D1F	72	12.632	12.522	13.006	3/16	4-1/2	5-1/4	15/16	4-15/16	J	85.6
P80-14M-115	D2F	80	14.036	13.926	14.620	3/16	4-1/2	5-1/4	15/16	4-15/16	J	90.0
P90-14M-115	D2	90	15.790	15.680	-	3/16	4-1/2	5-1/4	15/16	-	J	94.0
P112-14M-115	D3	112	19.650	19.540	-	3/16	4-1/2	5-1/4	15/16	-	J	121.0
P144-14M-115	D3	144	25.264	25.154	-	3/16	4-1/2	5-1/4	15/16	-	J	168.0
P168-14M-115	D3	168	29.475	29.365	-	3/16	4-1/2	5-1/4	15/16	-	M	198.0
P192-14M-115	D3	192	33.686	33.576	-	3/16	4-1/2	5-1/4	15/16	-	M	235.0
P216-14M-115	D3	216	37.896	37.786	-	3/16	4-1/2	5-1/4	15/16	-	M	340.0
<b>170mm (170)</b>												
P44-14M-170	A1F	44	7.720	7.610	8.340	2	2-5/8	7-3/8	2-3/4	7-1/16	E	39.2
P48-14M-170	A1F	48	8.421	8.311	8.900	2	2-5/8	7-3/8	2-3/4	7-1/16	E	49.8
P52-14M-170	A1F	52	9.123	9.013	9.680	1-7/16	3-5/8	7-3/8	2-5/16	7-1/16	F	64.5
P56-14M-170	A1F	56	9.825	9.715	10.380	1-7/16	3-5/8	7-3/8	2-5/16	7-1/16	F	73.3
P60-14M-170	A1F	60	10.527	10.417	11.060	15/16	4-1/2	7-3/8	1-15/16	7-1/16	J	93.1
P64-14M-170	A1F	64	11.229	11.119	11.680	15/16	4-1/2	7-3/8	1-15/16	7-1/16	J	103.9
P68-14M-170	A1F	68	11.930	11.820	12.500	15/16	4-1/2	7-3/8	1-15/16	7-1/16	J	115.3
P72-14M-170	A1F	72	12.632	12.522	13.190	15/16	4-1/2	7-3/8	1-15/16	7-1/16	J	117.2
P80-14M-170	A2F	80	14.036	13.926	14.630	15/16	4-1/2	7-3/8	1-15/16	7-1/16	J	119.9
P90-14M-170	A2	90	15.790	15.680	-	15/16	4-1/2	7-3/8	1-15/16	-	J	130.5
P112-14M-170	A3	112	19.650	19.540	-	0	6-3/4	7-3/8	5/8	-	M	205.5
P144-14M-170	A3	144	25.264	25.154	-	0	6-3/4	7-3/8	5/8	-	M	268.1
P168-14M-170	A3	168	29.475	29.365	-	0	6-3/4	7-3/8	5/8	-	M	293.2
P192-14M-170	A3	192	33.686	33.576	-	0	6-3/4	7-3/8	5/8	-	M	334.8
P216-14M-170	A3	216	37.896	37.786	-	0	6-3/4	7-3/8	5/8	-	M	334.8

\* Weights shown are approximate.

Pulley Type: F = Flanged

† Prices do not include bushing.

**Dimensions shown are for reference purposes only and are subject to change without notice. Where space requirements are critical, consult Bando for certified specifications.**



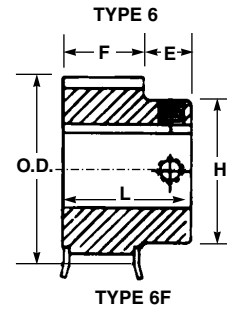

### 1/5 Inch Pitch (XL) for 1/4" and 3/8" Wide Belts

F Dimension = 9/16"

Part Number	Type	Number of Teeth	Nominal Dimensions (in)								Weight* (Lbs.)
			Pitch Dia.	Pulley OD	Flange OD	E	L	H	Bore		
									MPB	Max.	
P10XL037A	6F	10	.637	.617	.91	7/32	25/32	7/16	3/16	1/4	.03
P10XL037	6F	10	.637	.617	.91	7/32	25/32	7/16	3/16	1/4	.03
P11XL037A	6F	11	.700	.680	.93	7/32	25/32	7/16	3/16	1/4	.03
P11XL037	6F	11	.700	.680	.93	7/32	25/32	7/16	3/16	1/4	.03
P12XL037A	6F	12	.764	.744	.99	7/32	25/32	1/2	3/16	5/16	.06
P12XL037	6F	12	.764	.744	.99	7/32	25/32	1/2	3/16	5/16	.06
P13XL037A	6F	13	.828	.808	1.06	1/4	13/16	9/16	1/4	3/8	.06
P14XL037A	6F	14	.891	.871	1.12	7/32	25/32	9/16	1/4	3/8	.06
P14XL037	6F	14	.891	.871	1.12	7/32	25/32	9/16	1/4	3/8	.06
P15XL037A	6F	15	.955	.935	1.18	7/32	25/32	5/8	1/4	7/16	.09
P15XL037	6F	15	.955	.935	1.18	7/32	25/32	5/8	1/4	7/16	.09
P16XL037A	6F	16	1.019	.999	1.25	7/32	25/32	11/16	1/4	1/2	.09
P16XL037	6F	16	1.019	.999	1.25	7/32	25/32	11/16	1/4	1/2	.09
P17XL037A	6F	17	1.082	1.062	1.31	7/32	25/32	3/4	1/4	1/2	.13
P18XL037A	6F	18	1.146	1.126	1.38	7/32	25/32	13/16	1/4	9/16	.13
P18XL037	6F	18	1.146	1.126	1.38	7/32	25/32	13/16	1/4	9/16	.13
P19XL037A	6F	19	1.210	1.190	1.44	1/4	13/16	7/8	1/4	9/16	.15
P20XL037A	6F	20	1.273	1.253	1.50	11/32	29/32	15/16	1/4	11/16	.19
P20XL037	6F	20	1.273	1.253	1.50	11/32	29/32	15/16	1/4	11/16	.19
P21XL037A	6F	21	1.337	1.317	1.57	11/32	29/32	15/16	1/4	11/16	.19
P21XL037	6F	21	1.337	1.317	1.57	11/32	29/32	15/16	1/4	11/16	.19
P22XL037A	6F	22	1.401	1.381	1.63	11/32	29/32	1	1/4	3/4	.22
P22XL037	6F	22	1.401	1.381	1.63	11/32	29/32	1	1/4	3/4	.22
P23XL037A	6F	23	1.464	1.444	1.69	5/16	7/8	1-1/16	1/4	13/16	.25
P24XL037A	6F	24	1.528	1.508	1.76	11/32	29/32	1-1/16	1/4	13/16	.25
P24XL037	6F	24	1.528	1.508	1.76	11/32	29/32	1-1/16	1/4	13/16	.25
P25XL037A	6F	25	1.592	1.572	1.81	11/32	29/32	1-1/16	1/4	13/16	.25
P26XL037A	6F	26	1.655	1.635	1.88	11/32	29/32	1-3/16	1/4	15/16	.34
P28XL037A	6F	28	1.783	1.763	2.01	11/32	29/32	1-3/16	1/4	15/16	.34
P30XL037A	6F	30	1.910	1.890	2.14	11/32	29/32	1-3/8	5/16	1-1/16	.41
P32XL037A	6	32	2.037	2.017	-	7/16	1	1-1/2	5/16	1-3/16	.22
P36XL037A	6	36	2.292	2.272	-	7/16	1	1-1/2	5/16	1-3/16	.30
P40XL037A	6	40	2.546	2.526	-	7/16	1	1-1/2	5/16	1-3/16	.31
P42XL037A	6	42	2.674	2.654	-	7/16	1	1-1/2	5/16	1-3/16	.31
P44XL037A	6	44	2.801	2.781	-	7/16	1	1-1/2	5/16	1-3/16	.31
P48XL037A	6	48	3.056	3.036	-	7/16	1	1-1/2	5/16	1-3/16	.38
P60XL037A	6	60	3.820	3.800	-	7/16	1	1-1/2	5/16	1-3/16	.38
P72XL037A	6	72	4.584	4.564	-	7/16	1	1-1/2	3/8	1-3/16	.50

A=Aluminum Construction; all others are steel.

All pulleys have two (2) setscrews at 90°.

\* Weights shown are approximate.

#### Rebore, Keyway and Setscrew Alterations

A *minimum* quantity of 100 identical sizes of MPB Synchro-Link® pulleys are required for *any* alteration, i.e.: reboring, keywaying or additional setscrews. Consult BANDO for price and availability.

Dimensions shown are for reference purposes only and are subject to change without notice. Where space requirements are critical, consult BANDO for certified specifications.



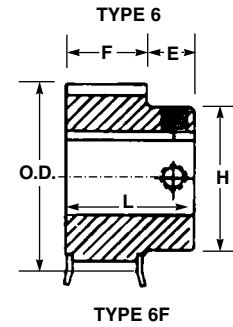

## 3/8 Inch Pitch (L) for 1/2" and 3/4" Wide Belts

Part Number	Type	Number of Teeth	Nominal Dimensions (in)							Bore		Weight* (Lbs.)
			Pitch Dia.	Pulley OD	Flange OD	E	L	H	MPB	Max.		
<b>1/2" (050)</b>			<b>F Dimension = 3/4"</b>									
P10L050	6F	10	1.194	1.164	1-7/16	3/4	1-1/2	13/16	3/8	1/2	.20	
P12L050	6F	12	1.432	1.402	1-11/16	3/4	1-1/2	1-1/16	3/8	1/2	.40	
P13L050.3	6F	13	1.552	1.522	1-25/32	3/4	1-1/2	1-1/8	3/8	3/4	.50	
P13L050.5	6F	13	1.552	1.522	1-25/32	3/4	1-1/2	1-1/8	1/2	3/4	.50	
P14L050	6F	14	1.671	1.641	1-15/16	3/4	1-1/2	1-1/8	3/8	3/4	.50	
P15L050.3	6F	15	1.790	1.760	2-1/64	3/4	1-1/2	1-5/16	3/8	3/4	.60	
P15L050.5	6F	15	1.790	1.760	2-1/64	3/4	1-1/2	1-5/16	1/2	3/4	.60	
P15L050.6	6F	15	1.790	1.760	2-1/64	3/4	1-1/2	1-5/16	5/8	3/4	.60	
P15L050.7	6F	15	1.790	1.760	2-1/64	3/4	1-1/2	1-5/16	3/4	3/4	.60	
P16L050	6F	16	1.910	1.880	2-3/16	3/4	1-1/2	1-7/16	1/2	1	.80	
P17L050	6F	17	2.029	1.999	2-9/32	3/4	1-1/2	1-1/2	1/2	1-1/8	.90	
P18L050	6F	18	2.149	2.119	2-3/8	3/4	1-1/2	1-9/16	1/2	1-3/16	.90	
P19L050	6F	19	2.268	2.238	2-1/2	3/4	1-1/2	1-5/8	1/2	1-3/16	1.10	
P20L050	6F	20	2.387	2.357	2-5/8	3/4	1-1/2	1-11/16	1/2	1-1/4	1.20	
P21L050	6F	21	2.507	2.477	2-47/64	3/4	1-1/2	1-7/8	1/2	1-5/16	1.30	
P22L050	6F	22	2.626	2.596	2-7/8	3/4	1-1/2	2	1/2	1-1/2	1.10	
P24L050	6F	24	2.865	2.835	3-1/8	3/4	1-1/2	2-1/4	1/2	1-5/8	1.60	
P26L050	6F	26	3.104	3.074	3-3/8	3/4	1-1/2	2-1/4	1/2	1-5/8	2.30	
P28L050	6F	28	3.342	3.312	3-5/8	3/4	1-1/2	2-1/4	1/2	1-5/8	2.50	
P30L050	6F	30	3.581	3.551	3-13/16	3/4	1-1/2	2-1/4	1/2	1-5/8	2.70	
P32L050	6F	32	3.820	3.790	4-1/6	3/4	1-5/8	2-9/16	1/2	1-7/8	3.00	
<b>3/4" (075)</b>			<b>F Dimension = 1.0"</b>									
P12L075	6F	12	1.432	1.402	1-1/16	5/8	1-3/8	1-1/16	3/8	1/2	.50	
P13L075.3	6F	13	1.552	1.522	1-25/32	5/8	1-3/8	1-1/8	3/8	3/4	.60	
P13L075.5	6F	13	1.552	1.522	1-25/32	5/8	1-3/8	1-1/8	1/2	3/4	.60	
P14L075	6F	14	1.671	1.641	1-15/16	5/8	1-3/8	1-7/16	3/8	3/4	.60	
P15L075.5	6F	15	1.790	1.760	2-1/32	5/8	1-3/8	1-1/2	1/2	3/4	.75	
P15L075.6	6F	15	1.790	1.760	2-1/32	5/8	1-3/8	1-1/2	5/8	3/4	.75	
P15L075.7	6F	15	1.790	1.760	2-1/32	5/8	1-3/8	1-1/2	3/4	3/4	.75	
P16L075	6F	16	1.910	1.880	2-3/16	5/8	1-3/8	1-7/16	1/2	1	.90	
P17L075	6F	17	2.029	1.999	2-9/32	5/8	1-3/8	1-1/2	1/2	1-1/8	1.00	
P18L075	6F	18	2.149	2.119	2-3/8	5/8	1-3/8	1-9/16	1/2	1-3/16	1.10	
P19L075	6F	19	2.268	2.238	2-1/2	5/8	1-3/8	1-5/8	1/2	1-3/16	1.30	
P20L075	6F	20	2.387	2.357	2-5/8	5/8	1-3/8	1-11/16	1/2	1-1/4	1.10	
P21L075	6F	21	2.507	2.477	2-47/64	5/8	1-3/8	1-7/8	5/8	1-5/16	1.50	
P22L075	6F	22	2.626	2.596	2-7/8	5/8	1-3/8	2	5/8	1-1/2	1.60	
P24L075	6F	24	2.865	2.835	3-1/8	5/8	1-3/8	2-1/4	5/8	1-5/8	1.80	
P26L075	6F	26	3.104	3.074	3-3/8	5/8	1-3/8	2-1/4	5/8	1-5/8	2.10	
P28L075	6F	28	3.342	3.312	3-5/8	5/8	1-3/8	2-1/4	5/8	1-5/8	2.80	
P30L075	6F	30	3.581	3.551	3-13/16	5/8	1-3/8	2-1/4	5/8	1-5/8	3.10	
P32L075	6F	32	3.820	3.790	4-1/16	5/8	1-3/8	2-9/16	5/8	1-7/8	3.40	

P10, P12, P14 and P16 have one (1) setscrew. All other sizes do not have setscrew.

\* Weights shown are approximate.

**Dimensions shown are for reference purposes only and are subject to change without notice. Where space requirements are critical, consult BANDO for certified specifications.**



### 3/8 Inch Pitch (L) for 1" Wide Belts

Part Number	Type	Number of Teeth	Nominal Dimensions (in)								Weight* (Lbs.)
			Pitch Dia.	Pulley OD	Flange OD	E	L	H	Bore		
									MPB	Max.	
<b>1.0" (100) F Dimension = 1-1/4"</b>											
P13L100.3	6F	13	1.552	1.522	1-25/32	11/16	1-11/16	1-1/8	3/8	3/4	.70
P13L100.5	6F	13	1.552	1.522	1-25/32	11/16	1-11/16	1-1/8	1/2	3/4	.70
P14L100	6F	14	1.671	1.641	1-15/16	11/16	1-11/16	1-7/16	3/8	3/4	.80
P15L100.5	6F	15	1.790	1.760	2-1/32	11/16	1-11/16	1-1/2	1/2	3/4	.85
P15L100.6	6F	15	1.790	1.760	2-1/32	11/16	1-11/16	1-1/2	5/8	3/4	.85
P15L100.7	6F	15	1.790	1.760	2-1/32	11/16	1-11/16	1-1/2	3/4	3/4	.85
P16L100	6F	16	1.910	1.880	2-3/16	11/16	1-11/16	1-7/16	1/2	1	1.10
P17L100	6F	17	2.029	1.999	2-9/32	11/16	1-11/16	1-1/2	1/2	1-1/8	1.20
P18L100	6F	18	2.149	2.119	2-3/8	11/16	1-11/16	1-9/16	1/2	1-3/16	1.20
P19L100	6F	19	2.268	2.238	2-1/2	11/16	1-11/16	1-5/8	1/2	1-3/16	1.60
P20L100	6F	20	2.387	2.357	2-5/8	11/16	1-11/16	1-11/16	1/2	1-1/4	1.80
P21L100	6F	21	2.507	2.477	2-47/64	11/16	1-11/16	1-7/8	5/8	1-5/16	1.80
P22L100	6F	22	2.626	2.596	2-7/8	11/16	1-11/16	2	5/8	1-1/2	2.00
P24L100	6F	24	2.865	2.835	3-1/8	11/16	1-11/16	2-1/4	5/8	1-5/8	2.50
P26L100	6F	26	3.104	3.074	3-3/8	11/16	1-11/16	2-9/16	5/8	1-7/8	3.30
P28L100	6F	28	3.342	3.312	3-5/8	11/16	1-11/16	2-13/16	5/8	2	3.60
P30L100	6F	30	3.581	3.551	3-13/16	11/16	1-11/16	2-15/16	5/8	2-1/8	4.00
P32L100	6F	32	3.820	3.790	4-1/16	11/16	1-11/16	3-1/8	5/8	2-7/8	4.40

P14 and P16 have one (1) setscrew. All other sizes do not have setscrew.

\* Weights shown are approximate.

Dimensions shown are for reference purposes only and are subject to change without notice. Where space requirements are critical, consult BANDO for certified specifications.

### Preventative Maintenance

Properly designed drives – V-belt or synchronous – are virtually maintenance free providing some simple rules for proper installation and maintenance are adhered to.

The pay-off in “preventative maintenance” as opposed to “corrective maintenance” is maximum belt and sheave or pulley life, increased “up-time” and efficient, uninterrupted equipment and process service.

Refer to the Installation and Tensioning Information on pages 132 and 133 of this Catalog or, for a more comprehensive guide to proper drive installation and maintenance, request BANDO publication BU-106 (shown) or consult your BANDO sales representative to schedule a Preventive Maintenance seminar. Publication BU-106 is also available online at [www.BANDOUSA.com](http://www.BANDOUSA.com).



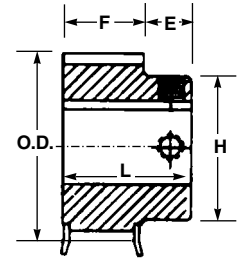

TYPE 6F

### 1/2 Inch Pitch (H) for 1", 1-1/2", 2" and 3" Wide Belts

Part Number	Type	Number of Teeth	Nominal Dimensions (in)								Weight* (Lbs.)	
			Pitch Dia.	Pulley OD	Flange OD	E	L	H	Bore			
									MPB	Max.		
<b>1" (100) F Dimension = 1-3/16"</b>												
P14H100	6F	14	2.228	2.174	2-15/32	3/4	1-3/4	1-1/2	5/8	1	1.4	
P16H100	6F	16	2.546	2.492	2-25/32	3/4	1-3/4	2	5/8	1-1/4	2.0	
P18H100	6F	18	2.865	2.811	3-1/8	3/4	1-3/4	2-1/4	5/8	1-1/2	2.8	
P19H100	6F	19	3.024	2.970	3-1/4	3/4	1-3/4	2-3/8	5/8	1-9/16	3.0	
P20H100	6F	20	3.183	3.129	3-27/64	3/4	1-3/4	2-1/2	5/8	1-5/8	3.4	
P21H100	6F	21	3.342	3.288	3-37/64	3/4	1-3/4	2-5/8	3/4	1-11/16	3.8	
P22H100	6F	22	3.501	3.447	3-3/4	3/4	1-3/4	2-7/8	3/4	1-7/8	4.3	
P24H100	6F	24	3.820	3.766	4-1/16	3/4	1-3/4	3-1/8	3/4	2-1/8	5.3	
P26H100	6F	26	4.138	4.084	4-3/8	3/4	1-3/4	3-1/2	3/4	2-1/2	6.7	
P28H100	6F	28	4.456	4.402	4-11/16	3/4	1-3/4	3-5/8	3/4	2-5/8	8.0	
<b>1-1/2" (150) F Dimension = 1-13/16"</b>												
P14H150	6F	14	2.228	2.174	2-15/32	3/4	1-9/16	1-1/2	3/8	1	1.8	
P16H150	6F	16	2.546	2.492	2-25/32	3/4	1-9/16	2	3/4	1-1/4	2.5	
P18H150	6F	18	2.865	2.811	3-1/8	3/4	1-9/16	2-1/4	3/4	1-1/2	3.3	
P19H150	6F	19	3.024	2.970	3-1/4	3/4	1-9/16	2-3/8	3/4	1-9/16	3.7	
P20H150	6F	20	3.183	3.129	3-27/64	3/4	1-9/16	2-1/2	3/4	1-5/8	4.3	
P21H150	6F	21	3.342	3.288	3-37/64	3/4	1-9/16	2-5/8	3/4	1-11/16	4.8	
P22H150	6F	22	3.501	3.447	3-3/4	3/4	1-9/16	2-7/8	3/4	1-7/8	5.4	
P24H150	6F	24	3.820	3.766	4-1/6	3/4	1-9/16	3-1/8	3/4	2-1/8	6.5	
P26H150	6F	26	4.138	4.084	4-3/8	3/4	1-9/16	3-1/2	3/4	2-1/2	8.4	
P28H150	6F	28	4.456	4.402	4-11/16	3/4	1-9/16	3-5/8	3/4	2-5/8	9.3	
<b>2" (200) F Dimension = 2-11/32"</b>												
P14H200	6F	14	2.228	2.174	2-15/32	3/4	3-3/32	1-1/2	3/4	1	2.2	
P16H200	6F	16	2.546	2.492	2-25/32	3/4	3-3/32	2	3/4	1-1/4	3.1	
P18H200	6F	18	2.865	2.811	3-1/8	3/4	3-3/32	2-1/4	3/4	1-1/2	3.9	
P19H200	6F	19	3.024	2.970	3-1/4	3/4	3-3/32	2-3/8	3/4	1-9/16	4.6	
P20H200	6F	20	3.183	3.129	3-27/64	3/4	3-3/32	2-1/2	3/4	1-5/8	4.9	
P21H200	6F	21	3.342	3.288	3-37/64	3/4	3-3/32	2-5/8	1	1-11/16	5.6	
P22H200	6F	22	3.501	3.447	3-3/4	3/4	3-3/32	2-7/8	1	1-7/8	6.3	
P24H200	6F	24	3.820	3.766	4-1/16	3/4	3-3/32	3-1/8	1	2-1/8	7.5	
P26H200	6F	26	4.138	4.084	4-3/8	3/4	3-3/32	3-1/2	1	2-1/2	9.5	
P28H200	6F	28	4.456	4.402	4-11/16	3/4	3-3/32	3-5/8	1	2-5/8	11.0	
<b>3" (300) F Dimension = 3-3/8"</b>												
P16H300	6F	16	2.546	2.492	2-25/32	3/4	4-1/8	2	3/4	1-1/4	4.1	
P18H300	6F	18	2.865	2.811	3-1/8	3/4	4-1/8	2-1/4	3/4	1-3/8	5.4	
P19H300	6F	19	3.024	2.970	3-1/4	3/4	4-1/8	2-3/8	3/4	1-9/16	6.2	
P20H300	6F	20	3.183	3.129	3-27/64	3/4	4-1/8	2-1/2	3/4	1-7/8	7.0	
P21H300	6F	21	3.342	3.288	3-37/64	3/4	4-1/8	2-5/8	1	1-11/16	7.5	
P22H300	6F	22	3.501	3.447	3-3/4	3/4	4-1/8	2-7/8	1-1/8	1-7/8	8.7	
P24H300	6F	24	3.820	3.766	4-1/16	3/4	4-1/8	3-1/8	1-1/8	2-1/8	10.0	
P26H300	6F	26	4.138	4.084	4-3/8	3/4	4-1/8	3-1/2	1-1/8	2-1/2	12.3	
P28H300	6F	28	4.456	4.402	4-11/16	3/4	4-1/8	3-5/8	1-1/8	2-5/8	15.0	

\* Weights shown are approximate.

Dimensions shown are for reference purposes only and are subject to change without notice. Where space requirements are critical, consult BANDO for certified specifications.

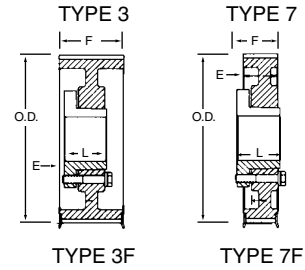

### 3/8 Inch Pitch (L) for Belts 1/2", 3/4" and 1" Wide Belts

Part Number	Type	Number of Teeth	Nominal Dimensions (in)						Bushing	Weight* (Lbs.)
			Pitch Dia.	Pulley OD	Flange OD	E	L	F		
<b>1/2" (050)</b>										
P18L050	3F	18	2.149	2.119	2.38	—	1	3/4	JA	.7
P20L050	3F	20	2.387	2.357	2.62	—	1	3/4	JA	.9
P22L050	3F	22	2.626	2.596	2.88	—	1	3/4	JA	1.1
P24L050	3F	24	2.865	2.835	3.12	—	1-5/16	3/4	SH	1.4
P26L050	3F	26	3.104	3.074	3.38	—	1-5/16	3/4	SH	1.6
P28L050	3F	28	3.342	3.312	3.62	—	1-5/16	3/4	SH	1.9
P30L050	3F	30	3.581	3.551	3.81	—	1-5/16	3/4	SDS	2.2
P32L050	3F	32	3.820	3.790	4.06	—	1-5/16	3/4	SDS	2.5
P36L050	3F	36	4.297	4.267	4.53	—	1-5/16	3/4	SDS	3.0
P40L050	3F	40	4.775	4.745	5.00	—	1-5/16	3/4	SDS	3.6
P44L050	3F	44	5.252	5.222	5.48	—	1-5/16	3/4	SDS	4.3
P48L050	3F	48	5.730	5.700	6.00	—	1-5/16	3/4	SDS	5.1
P60L050	7	60	7.162	7.132	—	1/4	1-13/16	3/4	SD	5.9
P72L050	7	72	8.594	8.564	—	1/4	1-13/16	3/4	SD	7.1
P84L050	7	84	10.027	9.997	—	1/4	1-13/16	3/4	SD	9.0
P96L050	7	96	11.459	11.429	—	1/4	1-13/16	3/4	SD	10.7
P120L050	7	120	14.324	14.294	—	1/4	1-13/16	3/4	SD	13.6
<b>3/4" (075)</b>										
P18L075	3F	18	2.149	2.119	2.38	—	1	1	JA	.8
P20L075	3F	20	2.387	2.357	2.62	—	1	1	JA	1.1
P22L075	3F	22	2.626	2.596	2.88	—	1	1	JA	1.2
P24L075	3F	24	2.865	2.835	3.12	—	1-5/16	1	SH	1.6
P26L075	3F	26	3.104	3.074	3.38	—	1-5/16	1	SH	1.8
P28L075	3F	28	3.342	3.312	3.62	—	1-5/16	1	SH	2.1
P30L075	3F	30	3.581	3.551	3.81	—	1-5/16	1	SDS	2.5
P32L075	3F	32	3.820	3.790	4.06	—	1-5/16	1	SDS	2.8
P36L075	3F	36	4.297	4.267	4.53	1/4	1-5/16	1	SDS	3.3
P40L075	3F	40	4.775	4.745	5.00	1/4	1-5/16	1	SDS	4.0
P44L075	3F	44	5.252	5.222	5.48	1/4	1-5/16	1	SDS	4.8
P48L075	3F	48	5.730	5.700	6.00	1/4	1-5/16	1	SDS	5.6
P60L075	3	60	7.162	7.132	—	—	1-13/16	1	SD	6.6
P72L075	7	72	8.594	8.564	—	1/8	1-13/16	1	SD	7.8
P84L075	7	84	10.027	9.997	—	1/8	1-13/16	1	SD	9.8
P96L075	7	96	11.459	11.429	—	1/8	1-13/16	1	SD	11.7
P120L075	7	120	14.324	14.294	—	1/8	1-13/16	1	SD	14.8
<b>1" (100)</b>										
P18L100	3F	18	2.149	2.119	2.38	—	1	1-1/4	JA	1.0
P20L100	3F	20	2.387	2.357	2.62	—	1	1-1/4	JA	1.3
P22L100	3F	22	2.626	2.596	2.88	—	1	1-1/4	JA	1.3
P24L100	3F	24	2.865	2.835	3.12	—	1-5/16	1-1/4	SH	1.8
P26L100	3F	26	3.104	3.074	3.38	—	1-5/16	1-1/4	SH	2.0
P28L100	3F	28	3.342	3.312	3.62	—	1-5/16	1-1/4	SH	2.4
P30L100	3F	30	3.581	3.551	3.81	—	1-5/16	1-1/4	SDS	2.7
P32L100	3F	32	3.820	3.790	4.06	—	1-5/16	1-1/4	SDS	3.0
P36L100	3F	36	4.297	4.267	4.53	1/4	1-5/16	1-1/4	SDS	3.6
P40L100	3F	40	4.775	4.745	5.00	—	1-5/16	1-1/4	SDS	4.4
P44L100	3F	44	5.252	5.222	5.48	1/2	1-5/16	1-1/4	SDS	5.2
P48L100	3F	48	5.730	5.700	6.00	1/2	1-5/16	1-1/4	SDS	6.1
P60L100	3	60	7.162	7.132	—	—	1-13/16	1-1/4	SD	7.1
P72L100	7	72	8.594	8.564	—	—	1-13/16	1-1/4	SD	8.6
P84L100	7	84	10.027	9.997	—	—	1-13/16	1-1/4	SD	10.7
P96L100	7	96	11.459	11.429	—	—	1-13/16	1-1/4	SD	12.7
P120L100	7	120	14.324	14.294	—	—	1-13/16	1-1/4	SD	16.1

\* Weights shown are approximate.

Pulley Type: F = Flanged

† Prices do not include bushing.

Dimensions shown are for reference purposes only and are subject to change without notice. Where space requirements are critical, consult BANDO for certified specifications.

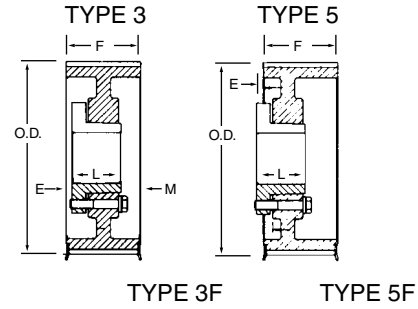

## 1/2 Inch Pitch (H) for 1" and 1-1/2" Wide Belts

Part Number	Type	Number of Teeth	Nominal Dimensions (in)						Bushing	Weight* (Lbs.)
			Pitch Dia.	Pulley OD	Flange OD	E	L	F		
<b>1.0" (100)</b>										
P14H100	3F	14	2.228	2.174	2.44	—	1	1-5/16	JA	1.1
P16H100	3F	16	2.546	2.492	2.75	—	1	1-5/16	JA	1.2
P18H100	3F	18	2.865	2.811	3.12	—	1-5/16	1-5/16	SH	1.8
P20H100	3F	20	3.183	3.129	3.38	—	1-5/16	1-5/16	SH	2.2
P22H100	3F	22	3.501	3.447	3.75	—	1-5/16	1-5/16	SDS	2.6
P24H100	3F	24	3.820	3.766	4.06	—	1-5/16	1-5/16	SDS	3.0
P26H100	3F	26	4.138	4.084	4.38	—	1-5/16	1-5/16	SDS	3.4
P28H100	3F	28	4.456	4.402	4.69	—	1-5/16	1-5/16	SDS	4.0
P30H100	3F	30	4.775	4.721	5.00	—	1-13/16	1-5/16	SD	5.7
P32H100	3F	32	5.093	5.039	5.31	—	1-15/16	1-5/16	SK	6.6
P36H100	3F	36	5.730	5.676	5.95	—	1-15/16	1-5/16	SK	8.4
P40H100	3F	40	6.366	6.312	6.56	—	1-15/16	1-5/16	SK	10.4
P44H100	3F	44	7.003	6.949	7.25	—	1-15/16	1-5/16	SK	12.6
P48H100	3F	48	7.639	7.585	7.88	—	1-15/16	1-5/16	SK	11.1
P60H100	5	60	9.549	9.495	—	—	2-1/16	1-5/16	SF	15.0
P72H100	5	72	11.459	11.405	—	—	2-1/16	1-5/16	SF	20.8
P84H100	5	84	13.369	13.315	—	—	2-1/16	1-5/16	SF	23.6
P96H100	5	96	15.279	15.225	—	—	2-1/16	1-5/16	SF	26.4
P120H100	5	120	19.099	19.045	—	—	2-1/16	1-5/16	SF	34.4
P156H100	5	156	24.828	24.774	—	—	2-1/16	1-5/16	SF	48.8
<b>1-1/2" (150)</b>										
P14H150	3F	14	2.228	2.174	2.44	—	1	1-13/16	JA	1.3
P16H150	3F	16	2.546	2.492	2.75	—	1	1-13/16	JA	1.4
P18H150	3F	18	2.865	2.811	3.12	—	1-5/16	1-13/16	SH	2.2
P20H150	3F	20	3.183	3.129	3.38	—	1-5/16	1-13/16	SH	2.6
P22H150	3F	22	3.501	3.447	3.75	—	1-13/16	1-13/16	SD	3.5
P24H150	3F	24	3.820	3.766	4.06	—	1-13/16	1-13/16	SD	4.2
P26H150	5F	26	4.138	4.084	4.38	—	1-13/16	1-13/16	SD	4.7
P28H150	5F	28	4.456	4.402	4.69	9/16	1-13/16	1-13/16	SD	5.6
P30H150	5F	30	4.775	4.721	5.00	9/16	1-13/16	1-13/16	SD	6.4
P32H150	5F	32	5.093	5.039	5.31	9/16	1-15/16	1-13/16	SK	7.2
P36H150	5F	36	5.730	5.676	5.95	9/16	1-15/16	1-13/16	SK	9.2
P40H150	5F	40	6.366	6.312	6.56	9/16	1-15/16	1-13/16	SK	11.1
P44H150	5F	44	7.003	6.949	7.25	9/16	1-15/16	1-13/16	SK	13.6
P48H150	5F	48	7.639	7.585	7.88	9/16	1-15/16	1-13/16	SK	14.5
P60H150	5	60	9.549	9.495	—	9/32	2-1/16	1-13/16	SF	16.7
P72H150	5	72	11.459	11.405	—	9/32	2-1/16	1-13/16	SF	22.9
P84H150	5	84	13.369	13.315	—	1/2	2-1/16	1-13/16	SF	25.9
P96H150	5	96	15.279	15.225	—	1/2	2-1/16	1-13/16	SF	29.4
P120H150	5	120	19.099	19.045	—	1/2	2-1/16	1-13/16	SF	38.5
P156H150	5	156	24.828	24.774	—	5/16	2-1/16	1-13/16	SF	54.7

\* Weights shown are approximate.

Pulley Type: F = Flanged

† Prices do not include bushing.

**Dimensions shown are for reference purposes only and are subject to change without notice. Where space requirements are critical, consult Bando for certified specifications.**

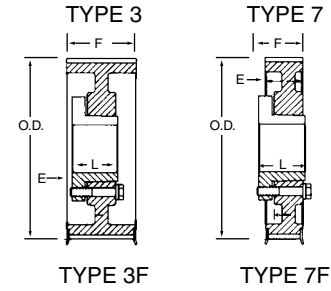

### 1/2 Inch Pitch (H) for 2" and 3" Wide Belts

Part Number	Type	Number of Teeth	Nominal Dimensions (in)						Bushing	Weight* (Lbs.)
			Pitch Dia.	Pulley OD	Flange OD	E	L	F		
<b>2" (200)</b>										
P14H200	3F	14	2.228	2.174	2.44	-	1	2-11/32	JA	1.7
P16H200	3F	16	2.546	2.492	2.75	-	1	2-11/32	JA	1.7
P18H200	3F	18	2.865	2.811	3.12	-	1-5/16	2-11/32	SH	2.6
P20H200	3F	20	3.183	3.129	3.38	-	1-5/16	2-11/32	SH	3.4
P22H200	3F	22	3.501	3.447	3.75	-	1-5/16	2-11/32	SD	4.1
P24H200	3F	24	3.820	3.766	4.06	-	1-5/16	2-11/32	SD	4.7
P26H200	3F	26	4.138	4.084	4.38	15/16	1-5/16	2-11/32	SD	5.2
P28H200	3F	28	4.456	4.402	4.69	15/16	1-5/16	2-11/32	SD	6.2
P30H200	3F	30	4.775	4.721	5.00	15/16	1-5/16	2-11/32	SD	7.1
P32H200	3F	32	5.093	5.039	5.31	15/16	1-15/16	2-11/32	SK	8.1
P36H200	3F	36	5.730	5.676	5.95	15/16	1-15/16	2-11/32	SK	10.3
P40H200	3F	40	6.366	6.312	6.56	15/16	1-15/16	2-11/32	SK	12.2
P44H200	3F	44	7.003	6.949	7.25	15/16	1-15/16	2-11/32	SK	15.0
P48H200	3F	48	7.639	7.585	7.88	35/64	2-1/16	2-11/32	SF	18.1
P60H200	7	60	9.549	9.495	-	35/64	2-1/16	2-11/32	SF	19.8
P72H200	7	72	11.459	11.405	-	35/64	2-1/16	2-11/32	SF	24.8
P84H200	7	84	13.369	13.315	-	1/8	2-1/16	2-11/32	SF	29.7
P96H200	7	96	15.279	15.225	-	3/8	2-3/4	2-11/32	SF	42.3
P120H200	7	120	19.099	19.045	-	3/8	2-3/4	2-11/32	E	53.8
P156H200	7	156	24.828	24.774	-	1/4	2-3/4	2-11/32	E	74.5
<b>3" (300)</b>										
P22H300	3F	22	3.501	3.447	3.75	-	1-1/4	3-3/8	SD	5.1
P24H300	3F	24	3.820	3.766	4.06	-	1-1/4	3-3/8	SD	5.8
P26H300	3F	26	4.138	4.084	4.38	1/16	1-1/4	3-3/8	SD	6.2
P28H300	3F	28	4.456	4.402	4.69	1/16	1-1/4	3-3/8	SD	7.5
P30H300	3F	30	4.775	4.721	5.00	7/16	1-1/4	3-3/8	SD	8.7
P32H300	3F	32	5.093	5.039	5.31	3/8	1-7/8	3-3/8	SK	9.6
P36H300	3F	36	5.730	5.676	5.95	3/8	1-7/8	3-3/8	SK	12.4
P40H300	3F	40	6.366	6.312	6.56	3/8	1-7/8	3-3/8	SK	14.3
P44H300	3F	44	7.003	6.949	7.25	3/8	1-7/8	3-3/8	SK	17.6
P48H300	3F	48	7.639	7.585	7.88	3/8	2	3-3/8	SF	21.1
P60H300	3	60	9.549	9.495	-	3/8	2	3-3/8	SF	24.2
P72H300	3	72	11.459	11.405	-	3/8	2	3-3/8	SF	28.5
P84H300	3	84	13.369	13.315	-	3/8	2	3-3/8	SF	34.9
P96H300	3	96	15.279	15.225	-	1/8	2-5/8	3-3/8	E	48.6
P120H300	3	120	19.099	19.045	-	1/8	2-5/8	3-3/8	E	62.2
P156H300	3	156	24.828	24.774	-	1/8	2-5/8	3-3/8	E	86.3

\* Weights shown are approximate.

Pulley Type: F = Flanged

† Prices do not include bushing.

Dimensions shown are for reference purposes only and are subject to change without notice. Where space requirements are critical, consult Bando for certified specifications.

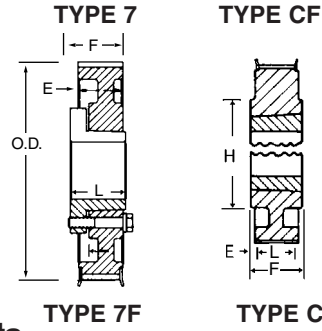

### 3/8 Inch Pitch (L) for 1/2", 3/4" and 1" Wide Belts

Part Number	Type	Number of Teeth	Nominal Dimensions (in)							Bushing	Weight* (Lbs.)
			Pitch Dia.	Pulley OD	Flange OD	E	L	H	F		
<b>1/2" (050)</b>											
TL18L050	CF	18	2.149	2.119	2-3/8	1/8	7/8	1-1/16	3/4	TL1008	.45
TL20L050	CF	20	2.387	2.357	2-5/8	1/8	7/8	1-3/4	3/4	TL1008	.68
TL22L050	CF	22	2.626	2.596	2-7/8	1/8	7/8	2-1/16	3/4	TL1008	.90
TL24L050	CF	24	2.865	2.835	3-1/8	1/4	1	2-1/4	3/4	TL1210	.81
TL26L050	CF	26	3.104	3.074	3-3/8	1/4	1	2-5/8	3/4	TL1210	1.20
TL28L050	CF	28	3.342	3.312	3-5/8	1/4	1	2-3/4	3/4	TL1210	1.40
TL30L050	CF	30	3.581	3.551	3-13/16	1/4	1	2-7/8	3/4	TL1610	1.50
TL32L050	CF	32	3.820	3.790	4-1/16	7/16	1	3-1/16	3/4	TL1610	1.75
TL40L050	CF	40	4.775	4.745	5	7/16	1-1/4	3-5/16	3/4	TL2012	2.40
TL48L050	CF	48	5.730	5.700	6	7/16	1-1/4	3-5/16	3/4	TL2012	4.63
TL60L050	7	60	7.162	7.132	-	1/4	1-1/4	4-3/8	3/4	TL2012	4.90
<b>3/4" (075)</b>											
TL18L075	CF	18	2.149	2.119	2-3/8	1/8	7/8	-	1	TL1008	.50
TL20L075	CF	20	2.387	2.357	2-5/8	1/8	7/8	-	1	TL1008	.81
TL22L075	CF	22	2.626	2.596	2-7/8	1/8	7/8	-	1	TL1008	1.13
TL24L075	CF	24	2.865	2.835	3-1/8	-	1	-	1	TL1210	1.00
TL26L075	CF	26	3.104	3.074	3-3/8	-	1	-	1	TL1210	1.20
TL28L075	CF	28	3.342	3.312	3-5/8	-	1	-	1	TL1610	1.20
TL30L075	CF	30	3.581	3.551	3-13/16	-	1	-	1	TL1610	1.50
TL32L075	CF	32	3.820	3.790	4-1/16	-	1	-	1	TL1610	1.90
TL40L075	CF	40	4.775	4.745	5	3/16	1-1/4	3-1/2	1	TL2012	3.63
TL48L075	CF	48	5.730	5.700	6	3/16	1-1/4	3-15/16	1	TL2012	5.50
TL60L075	CF	60	7.162	7.132	-	1/8	1-1/4	4-3/8	1	TL2012	6.81
<b>1" (100)</b>											
TL18L100	CF	18	2.149	2.119	2-3/8	-	7/8	-	1-1/4	TL1008	.70
TL20L100	CF	20	2.387	2.357	2-5/8	-	7/8	-	1-1/4	TL1008	1.00
TL22L100	CF	22	2.626	2.596	2-7/8	-	7/8	-	1-1/4	TL1008	1.30
TL24L100	CF	24	2.865	2.835	3-1/8	-	1	-	1-1/4	TL1210	1.30
TL26L100	CF	26	3.104	3.074	3-3/8	-	1	-	1-1/4	TL1210	1.70
TL28L100	CF	28	3.342	3.312	3-5/8	-	1	-	1-1/4	TL1610	1.70
TL30L100	CF	30	3.581	3.551	3-13/16	-	1	-	1-1/4	TL1610	2.20
TL32L100	CF	32	3.820	3.790	4-1/16	-	1	-	1-1/4	TL1610	2.70
TL40L100	CF	40	4.775	4.745	5	-	1-1/4	-	1-1/4	TL2012	4.13
TL48L100	CF	48	5.730	5.700	6	-	1-1/4	-	1-1/4	TL2012	6.31
TL60L100	C	60	7.162	7.132	-	-	1-1/4	-	1-1/4	TL2012	6.00

\* Weights shown are approximate.

Pulley Type: F = Flanged

† Prices do not include bushing.

Dimensions shown are for reference purposes only and are subject to change without notice. Where space requirements are critical, consult Bando for certified specifications.





TYPE AF

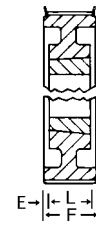

TYPE A

TYPE CF

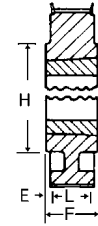

TYPE C

## 1/2 Inch Pitch (H) for 1", 1-1/2", 2" and 3" Wide Belts

Part Number	Type	Number of Teeth	Nominal Dimensions (in)							Bushing	Weight* (Lbs.)
			Pitch Dia.	Pulley OD	Flange OD	E	L	H	F		
<b>1" (100)</b>											
TL14H100	CF	14	2.228	2.174	2-15/32	7/16	7/8	-	1-5/16	TL1008	.8
TL16H100	CF	16	2.546	2.492	2-25/32	7/16	7/8	-	1-5/16	TL1008	1.3
TL18H100	CF	18	2.865	2.811	3-1/8	5/16	1	-	1-5/16	TL1210	1.2
TL20H100	CF	20	3.183	3.129	3-27/64	5/16	1	-	1-5/16	TL1210	1.7
TL22H100	CF	22	3.501	3.447	3-3/4	5/16	1	-	1-5/16	TL1610	2.0
TL24H100	CF	24	3.820	3.766	4-1/16	1/16	1	-	1-5/16	TL1610	1.8
TL26H100	CF	26	4.138	4.084	4-3/8	1/16	1-1/4	-	1-5/16	TL2012	2.7
TL28H100	CF	28	4.456	4.402	4-11/16	1/16	1-1/4	-	1-5/16	TL2012	3.4
TL30H100	CF	30	4.775	4.721	5	1/16	1-1/4	-	1-5/16	TL2012	3.9
TL32H100	CF	32	5.093	5.039	5-21/64	7/16	1-3/4	4	1-5/16	TL2517	4.1
TL40H100	CF	40	6.366	6.312	6-9/16	7/16	1-3/4	4-7/16	1-5/16	TL2517	8.4
TL48H100	CF	48	7.639	7.585	7-7/8	11/32	1-3/4	4-7/16	1-5/16	TL2517	13.0
<b>1-1/2" (150)</b>											
TL14H150	AF	14	2.228	2.174	2-15/32	15/32	7/8	-	1-13/16	TL1008	1.0
TL16H150	AF	16	2.546	2.492	2-25/32	15/32	7/8	-	1-13/16	TL1008	1.5
TL18H150	CF	18	2.865	2.811	3-1/8	-	1-1/2	-	1-13/16	TL1215	1.8
TL20H150	CF	20	3.183	3.129	3-27/64	-	1-1/2	-	1-13/16	TL1215	2.4
TL22H150	CF	22	3.501	3.447	3-3/4	-	1-1/2	-	1-13/16	TL1615	2.8
TL24H150	CF	24	3.820	3.766	4-1/16	-	1-1/4	-	1-13/16	TL2012	3.1
TL26H150	CF	26	4.138	4.084	4-3/8	-	1-1/4	-	1-13/16	TL2012	3.8
TL28H150	CF	28	4.456	4.402	4-11/16	-	1-1/4	-	1-13/16	TL2012	4.8
TL30H150	CF	30	4.775	4.721	5	-	1-1/4	-	1-13/16	TL2012	5.1
TL32H150	CF	32	5.093	5.039	5-21/64	-	1-3/4	-	1-13/16	TL2517	5.3
TL40H150	CF	40	6.366	6.312	6-9/16	-	1-3/4	-	1-13/16	TL2517	9.2
TL48H150	CF	48	7.639	7.585	7-7/8	-	1-3/4	-	1-13/16	TL2517	16.8
<b>2" (200)</b>											
TL16H200	AF	16	2.546	2.492	2-25/32	47/64	7/8	-	2-11/32	TL1008	1.9
TL18H200	AF	18	2.865	2.811	3-1/8	27/64	1-1/2	-	2-11/32	TL1215	2.2
TL20H200	AF	20	3.183	3.129	3-27/64	27/64	1-1/2	-	2-11/32	TL1215	3.1
TL22H200	AF	22	3.501	3.447	3-3/4	27/64	1-1/2	-	2-11/32	TL1615	3.4
TL24H200	AF	24	3.820	3.766	4-1/16	43/64	1-1/4	-	2-11/32	TL2012	3.1
TL26H200	AF	26	4.138	4.084	4-3/8	43/64	1-1/4	-	2-11/32	TL2012	4.3
TL28H200	AF	28	4.456	4.402	4-11/16	43/64	1-1/4	-	2-11/32	TL2012	5.3
TL30H200	AF	30	4.775	4.721	5	43/64	1-1/4	-	2-11/32	TL2012	7.0
TL32H200	CF	32	5.093	5.039	5-21/64	-	1-3/4	-	2-11/32	TL2517	6.8
TL40H200	CF	40	6.366	6.312	6-9/16	-	1-3/4	-	2-11/32	TL2517	13.5
TL48H200	CF	48	7.639	7.585	7-7/8	-	2	-	2-11/32	TL3020	18.9
<b>3" (300)</b>											
TL18H300	AF	18	2.865	2.811	3-1/8	15/16	1-1/2	-	3-3/8	TL1215	3.0
TL20H300	AF	20	3.183	3.129	3-27/64	15/16	1-1/2	-	3-3/8	TL1215	4.2
TL22H300	AF	22	3.501	3.447	3-3/4	15/16	1-1/2	-	3-3/8	TL1215	4.6
TL24H300	AF	24	3.820	3.766	4-1/16	1-1/16	1-1/4	-	3-3/8	TL2012	3.8
TL26H300	AF	26	4.138	4.084	4-3/8	1-1/16	1-1/4	-	3-3/8	TL2012	5.4
TL28H300	AF	28	4.456	4.402	4-11/16	1-1/16	1-1/4	-	3-3/8	TL2012	8.0
TL30H300	AF	30	4.775	4.721	5	43/64	1-1/4	-	3-3/8	TL2012	7.0
TL32H300	-	32	5.039	5.039	-	13/16	1-3/4	-	3-3/8	TL2517	7.4
TL40H300	-	40	6.312	6.312	-	13/16	1-3/4	-	3-3/8	TL2517	12.1
TL48H300	-	48	7.585	7.585	-	11/16	2	-	3-3/8	TL3020	16.3

\* Weights shown are approximate.

Pulley Type: F = Flanged

† Prices do not include bushing.

**Dimensions shown are for reference purposes only and are subject to change without notice. Where space requirements are critical, consult Bando for certified specifications.**

# BANDO



## QD®

The original sheave and pulley mounting system developed to facilitate installation and replacement of components. The QD® (Quick Detachable) design provides for both conventional (flange outboard) and reverse (flange inboard) mounting configurations.

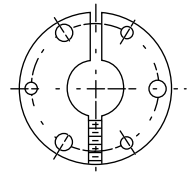
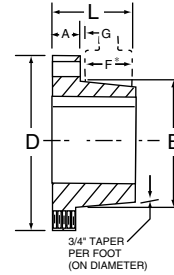

A setscrew over the keyway prevents key drift.

Bushing Size	Weight* (Lbs.)	Nominal Dimensions (in)						Bore Range (in)				Bolt	Cap Screws Required
		A	B	D	F <sup>3</sup>	G	L	Min.	Full Keyway	Shallow Keyway†	No Key		
<b>D</b>	0.4	1/4	1.625	2-1/2	9/16	3/16	1-1/4	3/8	1-7/16	-	-	2	(2) 1/4 X 3/4
<b>JA</b>	0.8	5/16	1.375	2	9/16	3/16	1	1/2	1	1-3/16	1-1/4	1-21/32	(3) 10-24 X 1
<b>SH</b>	0.9	7/16	1.871	2-11/16	3/4	7/32	1-5/16	1/2	1-3/8	1-5/8	1-11/16	2-1/4	(3) 1/4-20 X 1-3/8
<b>SDS</b>	1.3	7/16	2.187	3-3/16	3/4	1/4	1-5/16	1/2	1-5/8	1-15/16	2	2-11/16	(3) 1/4-20 X 1-3/8
<b>SD</b>	1.5	7/16	2.187	3-3/16	1-1/4	1/4	1-13/16	1/2	1-5/8	1-15/16	2	2-11/16	(3) 1/4-20 X 1-7/8
<b>SK</b>	2.8	9/16	2.812	3-29/32	1-1/4	1/4	1-15/16	1/2	2-1/8	2-1/2	2-5/8	3-15/16	(3) 5/16-18 X 2
<b>SF</b>	3.9	5/8	3.125	4-5/8	1-1/4	1/4	2-1/16	1/2	2-5/16	2-13/16	2-15/16	3-7/8	(3) 3/8-16 X 2
<b>E</b>	8.5	7/8	3.834	6	1-5/8	1/4	2-3/4	7/8	2-7/8	3-1/2	-	5	(3) 1/2-13 X 2-3/4
<b>F</b>	14.0	1	4.437	6-5/8	2-1/2	11/32	3-3/4	1	3-5/16	3-15/16	4	5-5/8	(3) 9/16-12 X 3-5/8
<b>J</b>	22.0	1-1/8	5.145	7-1/4	3-3/16	7/16	4-5/8	1-1/2	3-3/4	4-1/2	-	6-1/4	(3) 5/8-11 X 4-1/2
<b>M</b>	49.0	1-1/4	6.496	9	5-3/16	7/16	6-3/4	2	4-3/4	5-1/2	-	7-7/8	(4) 3/4-10 X 6-3/4

<sup>3</sup> Length of taper in mating bore

† Shallow key furnished with bushing

\* Weights shown are approximate and are based on mid-range bore size.

## TL®



TL® bushings are preferred where mounting space is at a premium. The TL® bushing can only be installed in the conventional (large end outboard) position.

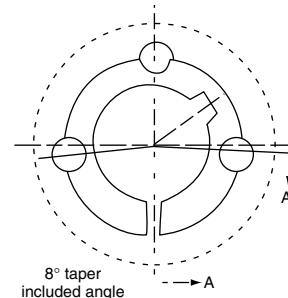
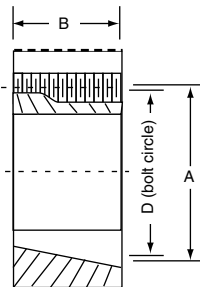

Bushing Size	Weight* (Lbs.)	Nominal Dimensions (in)			Bore Range (in)			Setscrews
		A	B	D	Min.	Full Keyway	Shallow Keyway†	
TL1008	0.2	1.386	7/8	1-21/64	1/2	7/8	1	(2) 1/4 X 1/2
TL1108	0.2	1.511	7/8	1-21/64	1/2	1	1-1/8	(2) 1/4 X 1/2
TL1210	0.5	1-7/8	1	1-3/4	1/2	1-1/4	-	(2) 3/8 X 5/8
TL1215	0.6	1-7/8	1-1/2	1-3/4	1/2	1-1/4	-	(2) 3/8 X 5/8
TL1310	0.7	2	1	1-7/8	1/2	1-1/4	1-7/16	(2) 3/8 X 5/8
TL1610	0.8	2-1/4	1	2-1/8	1/2	1-1/2	1-11/16	(2) 3/8 X 5/8
TL1615	1.0	2-1/4	1-1/2	2-1/8	1/2	1-1/2	1-11/16	(2) 3/8 X 5/8
TL2012	1.4	2-3/4	1-1/4	2-5/8	1/2	1-7/8	2-1/8	(2) 7/16 X 7/8
TL2517	2.8	3-3/8	1-3/4	3-1/4	1/2	2-1/4	2-11/16	(2) 1/2 X 1
TL2525	3.8	3-3/8	2-1/2	3-1/4	3/4	2-1/4	2-1/2	(2) 1/2 X 1
TL3020	5.8	4-1/4	2	4	7/8	2-3/4	3-1/4	(2) 5/8 X 1-1/4
TL3030	7.4	4-1/4	3	4	15/16	2-3/4	3-1/4	(2) 5/8 X 1-1/4
TL3525	7.9	5	2-1/2	4.83	1-3/16	3-1/4	3-1/2	(2) 1/2 X 1-1/2
TL3535	9.5	5	3-1/2	4.83	1-3/16	3-1/4	3-15/16	(3) 1/2 X 1-1/2
TL4030	13.2	5-3/4	3	5.54	1-7/16	3-5/8	4	(2) 5/8 X 1-3/4
TL4040	15.0	5-3/4	4	5.54	1-7/16	3-3/4	4-7/16	(3) 5/8 X 1-3/4
TL4535	15.2	6-3/8	4-1/2	6.13	1-15/16	4-1/4	4-1/2	(2) 3/4 X 2
TL5040	22.2	7	5	6.72	2-7/16	4-1/2	5	(2) 7/8 X 2-1/4
TL6050	52.4	9-1/4	5	9	4-7/17	6	-	(3) 1-1/4 X 3-1/2

\* Weights shown are approximate and are based on mid-range bore size.

† Shallow key furnished with bushing

Dimensions show are for reference purposes only and are subject to change without notice. Where space requirements are critical, consult Bando for certified specifications.



Bushing Size	Standard Bore Sizes Available
JA	1/2, 9/16, 5/8, 11/16, 3/4, 13/16, 7/8, 15/16, 1, 1-1/16+, 1-1/8+, 1-3/16+, 1-1/4*
SH	1/2, 9/16, 5/8, 11/16, 3/4, 13/16, 7/8, 15/16, 1, 1-1/16, 1-1/8, 1-3/16, 1-1/4, 1-5/16, 1-3/8, 1-7/16+, 1-1/2+, 1-9/16+, 1-5/8+, 1-11/16*
SDS	1/2, 9/16, 5/8, 11/16, 3/4, 13/16, 7/8, 15/16, 1, 1-1/16, 1-1/8, 1-3/16, 1-1/4, 1-5/16, 1-3/8, 1-7/16, 1-1/2, 1-9/16, 1-5/8, 1-11/16+, 1-3/4+, 1-13/16+, 1-7/8+, 1-15/16+, 2*
SD	1/2, 9/16, 5/8, 11/16, 3/4, 13/16, 7/8, 15/16, 1, 1-1/16, 1-1/8, 1-3/16, 1-1/4, 1-5/16, 1-3/8, 1-7/16, 1-1/2, 1-9/16, 1-5/8, 1-11/16+, 1-3/4+, 1-13/16+, 1-7/8+, 1-15/16+, 2*
SK	1/2, 9/16, 5/8, 11/16, 3/4, 13/16, 7/8, 15/16, 1, 1-1/16, 1-1/8, 1-3/16, 1-1/4, 1-5/16, 1-3/8, 1-7/16, 1-1/2, 1-9/16, 1-5/8, 1-11/16, 1-3/4, 1-13/16, 1-7/8, 1-15/16, 2, 2-1/16, 2-1/8, 2-3/16+, 2-1/4+, 2-5/16+, 2-3/8+, 2-7/16+, 2-1/2+, 2-5/8*
SF	1/2, 9/16, 5/8, 11/16, 3/4, 13/16, 7/8, 15/16, 1, 1-1/16, 1-1/8, 1-3/16, 1-1/4, 1-5/16, 1-3/8, 1-7/16, 1-1/2, 1-9/16, 1-5/8, 1-11/16, 1-3/4, 1-13/16, 1-7/8, 1-15/16, 2, 2-1/16, 2-1/8, 2-3/16, 2-1/4, 2-5/16, 2-3/8+, 2-7/16+, 2-1/2+, 2-5/8+, 2-11/16+, 2-3/4+, 2-13/16+, 2-7/8+, 2-15/16*
E	7/8, 15/16, 1, 1-1/16, 1-1/8, 1-3/16, 1-1/4, 1-5/16, 1-3/8, 1-7/16, 1-1/2, 1-9/16, 1-5/8, 1-11/16, 1-3/4, 1-13/16, 1-7/8, 1-15/16, 2, 2-1/16, 2-1/8, 2-3/16, 2-1/4, 2-5/16, 2-3/8, 2-7/16, 2-1/2, 2-5/8, 2-11/16, 2-3/4, 2-13/16, 2-7/8, 2-15/16+, 3+, 3-1/8+, 3-3/16+, 3-1/4+, 3-3/8+, 3-7/16+, 3-1/2+
F	1, 1-1/16, 1-1/8, 1-3/16, 1-1/4, 1-5/16, 1-3/8, 1-7/16, 1-1/2, 1-9/16, 1-5/8, 1-11/16, 1-3/4, 1-13/16, 1-7/8, 1-15/16, 2, 2-1/16, 2-1/8, 2-3/16, 2-1/4, 2-5/16, 2-3/8, 2-7/16, 2-1/2, 2-5/8, 2-11/16, 2-3/4, 2-13/16, 2-7/8, 2-15/16, 3, 3-1/8, 3-3/16, 3-1/4, 3-3/8+, 3-7/16+, 3-1/2+, 3-5/8+, 3-11/16+, 3-3/4+, 3-7/8+, 3-15/16+, 4*
J	1-1/2, 1-9/16, 1-5/8, 1-11/16, 1-3/4, 1-13/16, 1-7/8, 1-15/16, 2, 2-1/16, 2-1/8, 2-3/16, 2-1/4, 2-5/16, 2-3/8, 2-7/16, 2-1/2, 2-5/8, 2-11/16, 2-3/4, 2-13/16, 2-7/8, 2-15/16, 3, 3-1/8, 3-3/16, 3-1/4, 3-3/8, 3-7/16, 3-1/2, 3-5/8, 3-11/16, 3-3/4, 3-7/8+, 3-15/16+, 4, 4-1/8+, 4-3/16+, 4-1/4+, 4-3/8+, 4-7/16+, 4-1/2+
M	2, 2-1/16, 2-1/8, 2-3/16, 2-1/4, 2-5/16, 2-3/8, 2-7/16, 2-1/2, 2-5/8, 2-11/16, 2-3/4, 2-13/16, 2-7/8, 2-15/16, 3, 3-1/8, 3-3/16, 3-1/4, 3-3/8, 3-7/16, 3-1/2, 3-5/8, 3-11/16, 3-3/4, 3-7/8, 3-15/16, 4, 4-1/8, 4-3/16, 4-1/4, 4-3/8, 4-7/16, 4-1/2, 4-5/8, 4-11/16, 4-3/4, 4-7/8, 4-15/16, 5, 5-1/4, 5-3/8, 5-7/16, 5-1/2

+ Non-standard keyway bushing

\* No keyway bushing



## QD® Bushings - Standard Metric Bore & Keyways

Bore	Key** W x T	Bushing Sizes
24	8 x 7	SH SDS SD SK
25	8 x 7	SH SDS SD SK
28	8 x 7	SH SDS SD SK SF
30	8 x 7	SH SDS SD SK SF
32	10 x 8	SH SDS SD SK SF
35	10 x 8	SH SDS SD SK SF E
38	10 x 8	SDS SD SK SF E
40	12 x 8	SDS SD SK SF E
42	12 x 8	SDS SD SK SF E
48	14 x 9	SK SF E F
50	14 x 9	SK SF E F J
55	16 x 10	SK SF E F J
60	18 x 11	SF E F J
65	18 x 11	E F J
70	20 x 12	E F J
75	20 x 12	E F J
80	22 x 14	F J
85	22 x 14	F J
90	25 x 14	F J
95	25 x 14	J
100	28 x 16	J

\*\* The metric system does not refer to keyseat or keyway dimensions as does the English system; instead dimensions are given for the key itself which is rectangular in shape not square as in the English system. The correct terminology when ordering metric bored bushings with millimeter keyways will be either of the following:

1. Specify standard keyway.
2. Customer to specify key size (keyseat to be standard size in shaft)



Bushing Size	Standard Bore Sizes Available
TL1008	1/2, 5/8, 3/4, 7/8, 15/16+, 1+
TL 1108	1/2, 9/16, 5/8, 11/16, 3/4, 13/16, 7/8, 15/16, 1, 1-1/8+
TL1210	1/2, 5/8 3/4, 7/8, 15/16, 1, 1-1/8, 1-3/16, 1-1/4
TL1215	1/2, 5/8, 3/4, 7/8, 15/16, 1, 1-1/8, 1-3/16, 1-1/4
TL1310	1/2, 5/8, 3/4, 7/8, 15/16, 1, 1-1/8, 1-3/16, 1-1/4, 1-3/8
TL1610	1/2, 5/8, 3/4, 7/8, 15/16, 1, 1-1/8, 1-3/16, 1-1/4, 1-3/8, 1-7/16, 1-1/2, 1-5/8+
TL1615	1/2, 5,8, 3/4, 7/8, 15/16, 1, 1-1/8, 1-3/16, 1-1/4, 1-5/16, 1-3/8, 1-7/16, 1-1/2, 1-5/8+
TL2012	1/2, 5/8, 3/4, 7/8, 15/16, 1, 1-1/8, 1-3/16, 1-1/4, 1-3/8, 1-7/16, 1-1/2, 1-5/8, 1-11/16, 1-3/4, 1-7/8, 1-15/16+, 2+
TL2517	1/2, 5/8, 3/4, 7/8, 15/16, 1, 1-1/8, 1-3/16, 1-1/4, 1-3/8, 1-7/16, 1-1/2, 1-5/8, 1-11/16,1-3/4, 1-7/8, 1-15/16, 2, 2-1/8, 2-3/16, 2-1/4, 2-3/8+, 2-7/16+, 2-1/2+
TL2525	1-1/4, 1-2/8, 1-7/16, 1-1/2, 1-5/8, 1-3/4, 1-7/8, 1-15/16, 2, 2-1/8, 2-3/16, 2-1/4, 2-3/8+, 2-7/16+, 2-1/2+
TL3020	1-1/8, 1-3/16, 1-1/4, 1-3/8, 1-7/16, 1-1/2, 1-5/8, 1-11/16, 1-3/4, 1-7/8, 1-15/16, 2, 2-1/8, 2-3/16, 2-1/4, 2-3/8, 2-7/16, 2-1/2, 2-5/8, 2-11/16, 2-3/4, 2-7/8+, 2-15/16+, 3+
TL3030	1, 1-1/8, 1-3/16, 1-1/4, 1-3/8, 1-7/16, 1-1/2, 1-5/8, 1-11/16, 1-3/4, 1-7/8, 1-15/16, 2, 2-1/8, 2-3/16, 2-1/4, 2-3/8, 2-7/16, 2-1/2, 2-5/8, 2-11/16, 2-3/4, 2-7/8+, 2-15/16+, 3+
TL3525	1-3/16, 1-1/4, 1-3/8, 1-7/16, 1-1/2, 1-5/8, 1-11/16, 1-3/4, 1-7/8,1-15/16, 2, 2-1/8, 2-3/16, 2-1/4, 2-5/16, 2-3/8, 2-7/16, 2-1/2, 2-5/8, 2-11/16, 2-3/4, 2-7/8, 2-15/16, 3, 3-1/8, 3-3/16, 3-1/4, 3-5/16+, 3-3/8+, 3-7/16+, 3-1/2+
TL3535	1-3/4, 1-7/8, 1-15/16, 2, 2-1/8, 2-3/16, 2-1/4, 2-3/8, 2-7/16, 2-1/2, 2-5/8, 2-11/16, 2-3/4, 2-7/8, 2-15/16, 3, 3-1/8, 3-3/16, 3-1/4, 3-3/8+, 3-7/16+, 3-1/2+
TL4030	1-7/16, 1-1/2, 1-5/8, 1-11/16, 1-3/4, 1-7/8,1-15/16, 2, 2-1/8, 2-3/16, 2-1/4, 2-3/8, 2-7/16, 2-1/2, 2-5/8, 2-11/16, 2-3/4, 2-7/8, 2-15/16, 3, 3-1/8, 3-3/16, 3-1/4, 3-3/8, 3-7/16, 3-1/2, 3-5/8, 3-11/16, 3-3/4, 3-7/8+, 3-15/16+, 4+
TL4040	2-3/16, 2-1/4, 2-3/8, 2-7/16, 2-1/2, 2-5/8, 2-11/16, 2-3/4, 2-7/8, 2-15/16, 3, 3-1/8, 3-3/16, 3-1/4, 3-3/8, 3-7/16, 3-1/2, 3-5/8, 3-3/4+, 3-7/8+, 3-15/16+, 4+
TL4535	1-15/16, 2, 2-3/16, 2-3/8, 2-7/16, 2-5/8, 2-3/4, 2-7/8, 2-15/16, 3-1/8, 3-3/16, 3-1/4, 3-3/8, 3-7/16, 3-1/2, 3-5/8, 3-3/4, 3-7/8, 3-15/16, 4, 4-1/8, 4-3/16, 4-1/4, 4-3/8+, 4-7/16+, 4-1/2+
TL5040	2-7/16, 2-15/16, 3-3/8, 3-7/16, 3-5/8, 3-7/8, 3-15/16, 4, 4-1/8, 4-3/8, 4-7/16, 4-1/2, 4-7/8+, 4-15/16+, 5+
TL6050	4-7/16, 4-15/16, 5-7/16, 5-15/16, 6

+ Furnished complete with keystock.

**Proper installation techniques will assure that you get full service life and minimum downtime from your belt drives.**

1. Turn machine OFF and lock out power source.
2. Remove belt guard, loosen motor mounts, and shorten center distance between sheaves. Remove old belts.
3. Inspect, repair, or replace drive components.
  - Clean oil, grease, and debris from sheaves; remove rust with a wire brush.
  - Inspect and replace damaged sheaves.

Get your money's worth from a new set of belts by checking and replacing worn or damaged sheaves. In the long run, replacement sheave cost will more than be recovered in increased belt life, reduced downtime, and lower maintenance expense. Check the following:

  - a) Worn groove sidewalls, "Dishing" should not exceed 1/32" for individual belts. With a Combo belt, dishing should not exceed 1/64". When a Combo belt rides

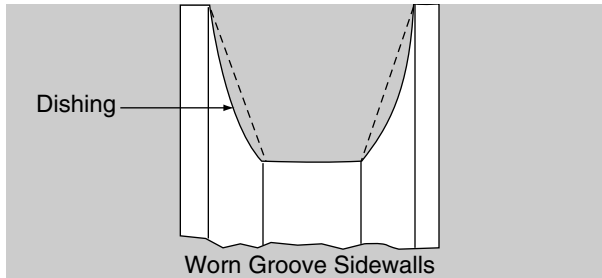

too low in worn sheave grooves, the tie band can be cut by the flanges between the grooves.

- b) Shiny sheave groove bottoms. This is a sure sign that the belt has bottomed out. The resulting slippage shortens belt life.
- c) Wobbling and/or damaged sheaves. Generally caused by improper sheave or bushing installation, wobbling and/or damaged sheaves can unbalance a drive, wear out belts rapidly, and damage bearings.
  - Check and repair worn bearings and bent shafts.

4. Select replacement belts.
  - Replace all belts on a drive with a *new* matched set from one manufacturer.
  - a) Do not mix old and new belts on a drive. A new belt will ride higher in the sheave groove and operate at a higher tension than an old belt. Running them together will damage the new belt so it cannot carry its share of the load.
  - b) Do not mix belts from different manufacturers. Because dimensions and constructions will vary, running such "mis-matched" belts will not give full service life.
  - c) Replace with correct type and cross section belt. Match "A" section belts with "A" sheave grooves, "B" to "B", etc. Do not use "B" section belts in "5V" sheaves, or vice versa. Never replace "A" or "B" belts with "4L" or "5L" fractional horsepower belts. Remember that dimensionally similar belts can have very different horsepower ratings.

5. Install new belts.
  - Loosen the drive take up and place the new belts on the sheaves. Press the belts with your hand to position the slack of each belt on the same side of the drive. If the slack is on different sides, start up loads can break belt tensile cords.
  - Do not pry or force belts on the sheave. This can break the load carrying tensile "muscle" of the belt, and the belts will break or turn over shortly after installation.
  - Take up slack until the belts fit snugly.
6. Check sheave alignment.
  - Place a straightedge or taut string across sheave faces to correct misalignment.
  - Check parallel position of shafts and correct alignment of grooves.
  - **Note:** Mount sheaves as close to bearings as possible.
7. Tension belts. (See note below.)
  - Ideal tension for a V-belt drive is the lowest tension at which a belt will not slip under peak load.
  - Tension belts, replace belt guard, run the drive for 15 minutes, and apply full load. Retighten slipping or squealing belts.
  - Retension after 24 to 48 hours, when belts will be completely seated in grooves.
  - Do not use belt dressing. If the belt slips, tighten and/or check for worn sheave grooves.

**Note:** Store belts in a cool, dry place out of direct sunlight.

**Types of sheave and shaft misalignment**

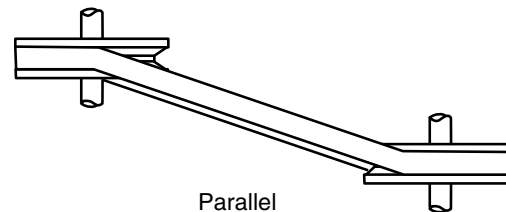
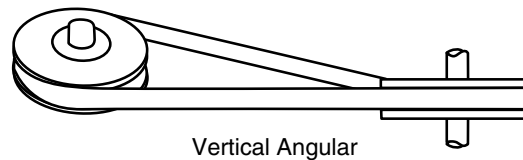
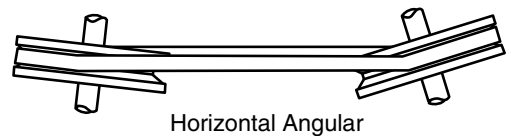

Refer to page 133 for proper tensioning, values and methods.

Refer to page 39 for tensioning and alignment tools.



The key to long, efficient, trouble-free belt operation is proper tension. If belts are too loose, the result is slippage, rapid belt and sheave wear *and* excessive “down time.” Conversely, too much tension imposes excessive strain on belts, bearings and adjacent drive components, resulting in premature wear of one or all of the drive parts. The *proper* tension is the *lowest* tension at which the belt(s) won’t slip or “squeal” under peak load.

### Tensioning Procedures

1. Measure the span length (L) in Fig. 1.
2. At the center of the span (L) apply a force perpendicular to the belt measuring the force needed to deflect the belt 1/64" per inch of span length (L).
3. Compare the force required in step 2 to the recommended range(s) in the appropriate table(s). Tighten or loosen the belt tension to bring the tension into the recommended range.
4. For V-belts, run the drive for five (5) or ten (10) minutes to seat the belt and then recheck the tension.
5. For timing belts, the belt should fit snugly – neither too tight nor too loose. The “tooth grip” eliminates the need for high initial tension.

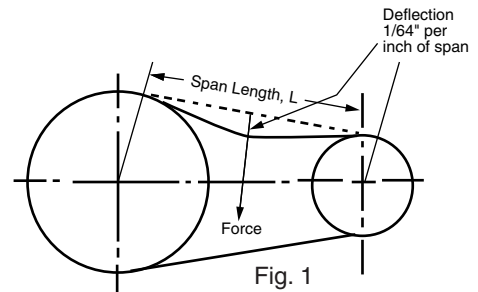

### V-Belt Drives

V Belt Cross Section	Small Pulley Diameter Range (Inches)	Recommended Deflection Force (Lbs.)*		
		Initial Installation	Retensioning	
			Maximum	Minimum
A	- 3.0	3.6	3.1	2.4
	3.1 - 4.0	4.2	3.6	2.8
	4.1 - 5.0	5.2	4.6	3.5
	5.1 -	6.1	5.3	4.1
B	- 4.6	7.3	6.4	4.9
	4.7 - 5.6	8.7	7.5	5.8
	5.7 - 7.0	9.3	8.1	6.2
	7.1 -	10.0	8.8	6.8
C	- 7.0	12.5	10.7	8.2
	7.1 - 9.0	15.0	13.0	10.0
	9.1 - 12.0	18.0	16.3	12.5
	12.1 -	19.5	16.9	13.0
D	12.0 - 13.0	25.5*	22.1	17.0
	13.1 - 15.5	30.0*	26.0*	20.0
	15.6 - 22.0	32.0*	28.0*	21.5
E	18.0 - 22.0	45.0*	39.0*	30.0*
	22.1 -	52.5*	45.5*	35.0*
3L	1.5 - 2.0	1.4	1.1	0.8
	2.1 - 2.7	1.9	1.4	1.1
	2.8 - 4.0	2.5	2.0	1.5
4L	2.0 - 2.5	2.1	1.6	1.2
	2.6 - 3.5	2.4	1.8	1.4
	3.6 - 5.0	3.1	2.3	1.8
5L	3.0 - 3.5	3.2	2.5	1.9
	3.6 - 4.5	4.1	3.2	2.4
	4.6 - 6.0	5.1	3.9	3.0

\* For banded belts, multiply the force in the table by the number of belts in the band.

V Belt Cross Section	Small Sheave Diameter Range (Inches)	Recommended Deflection Force (Lbs.)*		
		Initial Installation	Retensioning	
			Maximum	Minimum
3V	2.65 - 3.35	4.6	4.0	3.1
	3.65 - 4.50	5.5	4.8	3.7
	4.75 - 6.0	6.4	5.6	4.3
	6.5 - 10.6	7.3	6.4	4.9
5V	7.1 - 10.3	16.5	14.3	11.0
	10.9 - 11.8	19.5	16.9	13.0
	12.5 - 16.0	21.0	18.2	14.0
8V	12.5 - 16.0	39.0*	33.8*	26.0*
	17.0 - 20.0	45.0*	39.0*	30.0*
	21.2 - 24.4	51.0*	44.2*	34.0*
3VX	2.2 - 2.5	4.8	4.2	3.2
	2.65 - 4.75	5.7	4.9	3.8
	5.0 - 6.5	7.2	6.2	4.8
	6.9 -	8.7	7.5	5.8
5VX	- 5.5	15.0	13.0	10.0
	5.9 - 8.0	19.0	16.9	13.0
	8.5 - 10.9	21.0	18.2	14.0
	11.8 -	22.0	19.5	15.0
AX	- 3.0	5.1	4.4	3.4
	3.1 - 4.0	5.5	4.8	3.7
	4.1 - 5.0	6.0	5.2	4.0
	5.1 -	6.7	5.9	4.5
BX	- 4.6	10.0	8.7	6.7
	4.7 - 5.6	11.0	9.5	7.3
	5.7 - 7.0	11.5	9.9	7.6
	7.1 -	12.0	10.1	7.8
CX	- 7.0	18.0	15.6	12.0
	7.1 - 9.0	19.5	16.9	13.0
	9.1 - 12.0	20.0	17.6	13.5
	12.1 -	21.0	18.2	14.0
8VK	12.5 - 16.0	62.4	54.1	41.6
	17.0 - 20.0	72.0	62.4	48.0
	21.2 - 24.4	81.6	70.7	54.4

\* For smaller gauges, use 1/2 the value in the table and calculate deflection distance at 1/128th inch per inch of span length.

### Timing Belt Drives

Units are lbs.

Belt Size	012	019	025	031	037	050	075	100	150	200	300	400	500	600
Belt Width	1/8"	3/16"	1/4"	5/16"	3/8"	1/2"	3/4"	1"	1 1/2"	2"	3"	4"	5"	6"
MXL	Max.	.10	.15	.24	.35	.42	.62							
	Min.	.05	.09	.13	.19	.22	.33							
XL	Max.			.42	.55	.66	1.1	1.9						
	Min.			.20	.31	.37	.57	1.0						
L	Max.					1.3	2.1	2.9	4.7	6.4				
	Min.					1.0	1.5	2.2	3.4	4.7				
H	Max.						4.7	6.8	10.4	14.3	22.4			
	Min.						3.7	5.2	8.2	11.2	17.6			
XH	Max.								17.7	27.9	39.7	51.0	62.2	
	Min.								16.3	25.8	36.7	47.0	57.3	
XXH	Max.									40.5	63.9	90.7	117.2	142.1
	Min.									21.5	34.0	48.1	62.3	75.2

For tensioning information on STS and HT constructions refer to pages 72 and 77.

For complete drive installation, maintenance and troubleshooting instructions, request Bando publication BU-106 (V-Belt and Timing Belt Installation and Maintenance) or download Publication BU-106 at [www.BANDOUSA.com](http://www.BANDOUSA.com).

### Rib Ace® Drives

Belt Cross Section	Small Sheave Diameter Range	Force "F" Lbs./Rib
J	1.32 - 1.67	0.4
J	1.77 - 2.20	0.5
J	2.36 - 2.95	0.6
L	2.95 - 3.74	1.7
L	3.94 - 4.92	2.1
L	5.20 - 6.69	2.5
M	7.09 - 8.82	6.4
M	9.29 - 11.81	7.7
M	12.40 - 15.75	8.8





This chart identifies solutions to common problems you may encounter if belt drives aren't properly designed, installed or maintained. Once problems have been identified and corrected, your Bando belt drives will give you efficient performance and economical service.

<u>Problem</u>	<u>Cause</u>	<u>Solution</u>	<u>Problem</u>	<u>Cause</u>	<u>Solution</u>
<b>V-Belts</b>					
<b>Short Belt Life</b>			<b>Vibration</b>		
Short life - no visible reason	Worn or damaged grooves	Replace sheaves		Incorrectly placed flat idler pulley	Align idler on slack side close to driver
	Underdesigned drive	Redesign drive		Distance between shafts too long	Install idler
	Tensile cords damaged from incorrect installation	Replace belts with a new matched set. Follow installation instructions on page 132		Belt lengths uneven	Replace with a new matched set of belts
	Wrong type or cross section belt	Replace with correct belt		Belts too loose	Retension
Separation of cover plies. Soft, stick swollen side-walls.	Oil or grease	Remove source of oil or gease and clean belts with detergent and water	<b>Belt Turnover</b>		
Separation of cover plies. Dry, hard side-walls. Cracked bottom	High temperatures	Remove heat source and/or improve ventilation		Vibration and shock loads cause belts to jump and whip	Use Bando Combo
Cracked belt bottom	Sheaves too small	Redesign drive		Debris in grooves	Clean grooves and protect drive with guard
	Backside idler pulley too small	Redesign drive		Misaligned sheaves	Realign sheaves
	Slippage	Retension drive		Tensile cord broken from incorrect installation	Replace belts with a new matched set. Follow installation instructions on page 132
Broken belts	Excessive tension	Reduce tension		Incorrectly placed flat idler pulley	Align idler on slack side close to driver
	Objects hitting belts	Protect drive with guard		Worn sheave grooves	Replace sheaves
Belt cut on bottom	Belt ran off sheave	Check tension and alignment	<b>Hot Bearings</b>		
	Improper installation	Follow installation instructions on page 132	Overtensioned drive	Worn sheave grooves, belts bottom out	Replace sheaves and retension
Belt deterioration	Belt dressing	Never use belt dressing. Clean belt with detergent and water	Undertensioned drive	Slippage	Retension drive
Extreme cover wear, worn corners	Belt rubs on guard	Align drive to give proper clearance	Sheaves too far out on shaft	Design error or obstruction problem	Redesign and place sheaves as close as possible to bearings
	Dusty environment	Clean belt and protect guard	Bad bearings	Design error or poor maintenance	Redesign and/or maintain correctly
	Sheaves rusted; sheaves have sharp corners or burrs	Clean rust from sheaves; file down sharp corners and burrs	Sheaves too small	Design error	Redesign drive
	Slippage	Retension drive	<b>Timing Belts</b>		
Spin burns	Slippage	Retension drive	Cracks on backing	Low temperatures	Increase temperature or check with Bando for special construction belt
	Underdesigned drive	Redesign drive		High temperatures	Cool drive or check with Bando for special construction belt
	Water or oil	Clean belt and protect guard	Softening of backing	Exposure to oil	Remove source of oil or check with Bando for special construction belt
<b>Belt Stretch</b>			Tensile or tooth shear failure	Small pulley diameter	Redesign drive
Equal stretch	Underdesigned or overloaded drive	Redesign drive		Less than 6 teeth-in-mesh	Increase teeth-in-mesh or use smaller pitch belt
	Insufficient take up allowance	Check drive design manual		Excessive load	Redesign drive
Unequal stretch	Misaligned drive	Realign and retension drive	Noise	Misalignment	Realign drive
	Tensile cord broken from incorrect installation	Replace belts with a new matched set. Follow installation instructions on page 132		Excessive tension	Reduce tension
<b>Belt Noise</b>				Small pulleys	Redesign drive
	Slippage	Retension drive		Excessive load	Redesign drive
<b>Improper Drive Speed</b>			Excessive edge wear	Misalignment or non-rigid centers	Realign and reinforce mounting
	Design error	Redesign drive	Excessive wear on tooth fabric	Overtensioned or underdesigned drive	Reduce tension or redesign

Refer to page 132 for proper V-belt installation.



Standard Specification	Belt Cross Section	Bando	MBL	Carlisle	Optibelt	Goodyear	Thermod	Gates
Classical Multiple V-Belt RMA IP-20	A, B, C, D, E	Power King	Conventional	Super Blue Ribbon	Optibelt VB	Hy-T	Prime Mover Plus	Hi-Power II
	B, C, D Banded	Power King Combo	Conventional Banded	Super Vee-Band	Optibelt KB Kraftband	Torque Team	Prime Mover Plus Banded	Hi-Power II Power Band
	AX, BX CX, DX	Power King Cog	Raw Edge Cogged	Gold Label Cog-Belt	Optibelt Super TX M-S	Torque Flex	Prime Mover Cog	Tri-Power Molded Notch
	BX, CX, DX Banded			Gold Label Cog Band		Torque Team	Cog Banded	
Narrow Multiple V-Belt RMA IP-22	3V, 5V, 8V	Power Ace	Maxstar Wedge	Power Wedge	Optibelt-SK	Hy-T Wedge	Maxi Power	Super HC
	3V, 5V, 8V Banded	Power Ace Combo	Maxstar Wedge Banded	Wedge-Band	Optibelt-KB Kraftband	Hy-T Wedge Torque Team	Maxi Power Banded	Super HC Power Band
	3VX, 5VX, 8VX	Power Ace Cog	Maxstar Wedge Supreme	Power-Wedge Cog	Optibelt Super TX MS = S	Hy-T Wedge Cog	Maxi Power Cog	Super HC Molded Notch
	3VX, 5VX, 8VX Banded	Power Ace Cog Combo	Maxistart Wedge Supreme (5VX Only)			Torque Team Wedge	Maxi Power Cog Banded	Super HC Molded Notch Power Band
Light Duty (FHP) V-Belt RMA IP-23	2L, VC, DC 3L, 4L, 5L	Duraflex GL	FHP	Durapower	Optibelt-LD	FHP	FHP Glasstex	Truflex
Double-V Hex Belts RMA IP-21	AA, BB, CC, DD	Double V	Double	Double Angle	Optibelt-DK	Hex	Hex (Double V)	Hi-Power II Dubl-V
Variable Speed V-Belts RMA IP-25	12 Cross Sections	Power Max	Vari-Star	Variable Speed Cog	Optibelt Super VX	Variable Speed	Variable Speed	Multi-Speed
V-Rib Belts RMA IP-26	H, J, K, L, M	Rib Ace	Ribstar	Poly-Rib	Optibelt-RB	Poly-V	Multi-Ribbed	Micro-V
Synchronous Belts RMA IP-24	MXL, XL, L H, XH, XXH	Synchro-Link	Three Stars Timing	Synchro-Cog	Optibelt-2R	Positive Drive	Grip-Tite	Power Grip
	DMXL, DXL, DL, DH	Synchro-Link Double-Sided	Three Stars Dual Timing	Synchro-Cog Dual	Optibelt-2R DL	Dual Postive Drive	Grip-Tite Dual	Power Grip Twin Power
	3M, 5M, 8M, 14M	Synchro-Link HT Synchro-Link XP Synchro-Link KPS	High Torque Timing	Synchro-Cog Panther	Optibelt-HTD Omega	White Hawk Black Hawk HPPD	Grip-Tite HT	Power Grip HTD Poly-Chain GT
	S2M, S3M, S4.5M, S5M, S8M, S14M	Synchro-Link STS				Super Torque PD		
Synchronous Belts DIN 7721	T2, T2.5, T10, T20, AT3, AT5, AT10, AT20	Synchro-Link Polyurethane				Optibelt ZRM		
	DT2.5, DT5 DT10, DT20	Synchro-Link Double-Sided Polyurethane				Optibelt ZRM-DL		
Single Match System		BAN/SET	Set Free	Chek-Mate	S = C	Matchmaker	Sure-Set	V-80



## Torque to horsepower conversion

Load requirements for a drive may be given in terms of torque (turning effort) rather than horsepower. For drive design purposes, use the formulas below to convert torque (expressed as pound-inches or pound-feet) to horsepower. Be sure to use the rpm of the shaft for which the torque is known, and do not mix the torque of one shaft with the rpm of another shaft.

$$\text{Horsepower} = \frac{(\text{Torque, pound-inches}) (\text{rpm})}{63,025}$$

$$\text{Horsepower} = \frac{(\text{Torque, pound-feet}) (\text{rpm})}{5,252}$$

## Power to or from machinery

Without accurate horsepower requirement data for a drive, the formulas below may be used. Efficiency must be known or estimated to use these formulas, and is shown as a decimal (i.e. if a pump is 75% efficient, use .75 in the formula). When a drive is providing power to a pump or generator, estimate a low efficiency for the driveN machine. For power input to a drive from a motor or turbine, estimate a high efficiency for the driveR machine.

### A.C. Machinery

$$\text{Kilowatts} = \frac{(\text{volts}) (\text{amps}) (\text{pf})}{Y}$$

Where: pf = power factor  
Single phase: Y = 1000  
Three phase: Y = 577

### Power required for generator/alternator

$$\text{Horsepower} = \frac{(\text{volts}) (\text{amps}) (\text{pf})}{(Z) (\text{eff})}$$

Where: eff = overall mechanical and electrical efficiency  
pf = power factor  
Single phase: Z = 746  
Three phase: Z = 431

### Power from motor

$$\text{Horsepower} = \frac{(\text{volts}) (\text{amps}) (\text{pf}) (\text{eff})}{Z}$$

Where: eff = overall mechanical and electrical efficiency  
pf = power factor  
Single phase: Z = 746  
Three phase: Z = 431

### D.C. Machinery

$$\text{Kilowatts} = \frac{(\text{volts}) (\text{amps})}{1000}$$

### Power required for generator

$$\text{Horsepower} = \frac{(\text{volts}) (\text{amps})}{(746) (\text{eff})}$$

Where: eff = overall mechanical and electrical efficiency

### Power from motor

$$\text{Horsepower} = \frac{(\text{volts}) (\text{amps})}{(746)}$$

Where: eff = overall mechanical and electrical efficiency

## Hydraulic Machinery

### Power required by pumps

$$\text{Horsepower} = \frac{(Q) (P)}{1714 (\text{eff})}$$

Where: Q = flow rate, gal./min.  
P = discharge pressure for pumps, inlet pressure for turbines, lb./sq. in.  
eff. = overall mechanical and hydraulic efficiency

### Power from turbine

$$\text{Horsepower} = \frac{(Q) (P) (\text{eff})}{1714}$$

Where: Q = flow rate, gal./min.  
P = discharge pressure for pumps, inlet pressure for turbines, lb./sq. in.  
eff. = overall mechanical and hydraulic efficiency

## V-Belt Tension Formulas

### Effective Pull

$$T_1 - T_2 = 33,000 \left( \frac{HP}{V} \right)$$

Where: T<sub>1</sub> = tight side tension, pounds  
T<sub>2</sub> = slack side tension, pounds  
HP = design horsepower  
V = belt speed, feet per minute

$$T_1 + T_2 = 33,000 (2.5-G) \left( \frac{HP}{GV} \right)$$

Where: T<sub>1</sub> = tight side tension, pounds  
T<sub>2</sub> = slack side tension, pounds  
HP = design horsepower  
V = belt speed, feet per minute  
G = arc of contact correction factor

### Tension Ratio

$$T_1/T_2 = \frac{1}{1-0.8G} \quad (\text{Also, } T_1/T_2 = eK)$$

Where: T<sub>1</sub> = tight side tension, pounds  
T<sub>2</sub> = slack side tension, pounds  
G = arc of contact correction factor  
e = base of natural logarithms  
K = .51230, a constant for V-belt drive design  
q = arc of contact in radians

### Tight Side Tension

$$T_1 = 41,250 \left( \frac{HP}{GV} \right)$$

Where: T<sub>1</sub> = tight side tension, pounds  
HP = design horsepower  
V = belt speed, feet per minute  
G = arc of contact correction factor

### Slack Side Tension

$$T_2 = 33,000 (1.25-G) \left( \frac{HP}{GV} \right)$$

Where: T<sub>2</sub> = slack side tension, pounds  
HP = design horsepower  
V = belt speed, feet per minute  
G = arc of contact correction factor

### Belt Speed

$$V = \frac{PD (\text{rpm})}{3.82} = (PD) (\text{rpm}) (.262)$$

Where: V = belt speed, feet per minute  
PD = pitch diameter of sheave or pulley  
rpm = revolutions/minute of the same sheave or pulley

# The Right Belt For All Applications

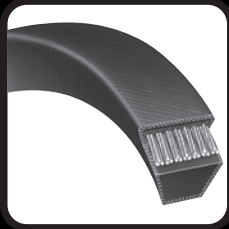

Power King®



Power Ace®



Power King®  
Power Ace® Combo



Rib Ace®



Power Max®



Power King® Cog



Power Ace® Cog



Double V



Duraflex GL®



Synchro-Link®  
Rubber

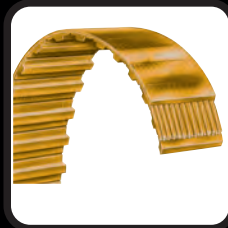

Synchro-Link®  
Polyurethane



Synchro-Link®  
High Torque

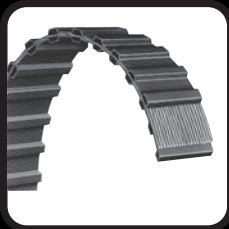

Synchro-Link®  
Double Sided  
Rubber



Synchro-Link®  
Double Sided  
Polyurethane

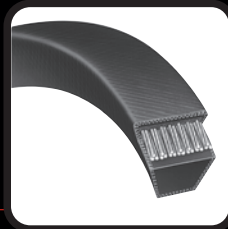

Metric V-Belts



KPS  
High Torque  
Polyurethane

DISTRIBUTED BY:

